MATERIAL FLOWS IN PRIMARY WOOD PROCESSING IN SLOVAKIA

Ján Parobek

Technical University in Zvolen, Faculty of Wood Sciences and Technology, Department of Marketing, Trade and World Forestry, T. G. Masaryka 24, 960 53 Zvolen, Slovakia, parobek@tuzvo.sk

Hubert Paluš

Technical University in Zvolen, Faculty of Wood Sciences and Technology, Department of Marketing, Trade and World Forestry, T. G. Masaryka 24, 960 53 Zvolen, Slovakia, palus@tuzvo.sk

Keywords: wood flows, wood resources, logistics

Abstract: Material flow analysis was used to reveal and quantify relations between the resources and the primary uses of wood. The paper deal with the analysis of raw wood flows in Slovakia in two approaches to wood flow modelling were utilised - wood balance and wood resource balance. Wood balance was presented to demonstrate a general view of the resources and primary uses of roundwood without analysing internal flows. The wood resource balance, as a more detailed analysis, takes into account the uses of wood as a material and also the by-products and waste generated by the production that could be used as inputs for further uses in wood processing or energy sectors. The latter balance was compiled using available official statistics supplemented by a questionnaire to estimate missing data for waste streams with a total consumption of 10.78 mil. m³ roundwood.

1 Introduction

The path of raw wood material from its production to giving the final product to a consumer is relatively long, as it passes several stages of production and different types of markets until the final product fulfils the needs of the consumers. Before reaching the end-user, these stages include leaving the forest, primary wood processing, secondary wood processing, and subsequent wood-using industries. Within these stages, raw wood material is transformed into primary processed intermediate products (sawn wood, pulp), secondary processed products (furniture, construction, and joinery), and then has a role in the final production of different industries related to the use of wood (e.g., construction). The domestic wood processing industry in the Slovak Republic is the major customer of the products of the forestry sector, and roundwood represents the main material input for this sector [1]. Similar links exist between the wood processing industry and other sectors that are dependent on wood products. Material flow analysis (MFA) can be used for the quantification and modelling of wood flows. The analysis process includes the gathering of information and requires market experience and recognition of mutual relations in the “forest - wood – end-user” chain.

EUROSTAT [2] distinguishes and explains the three basic dimensions of material flows: territorial dimension, product chain or life cycle dimension and the product dimension. Different approaches to material flow analysis and modelling have been used by e.g. [3], [4], [5], [6], [7]. The analysis of material flows can be also used as an analytical and modelling tool for different areas and sectors e.g., material balances of corporations and urban

regions in industrialized countries [8], regional wood management [9], and the generation of waste in regional systems [10].

The analysis of wood flows enables one to determine a balance between the production and the use of wood in the country. The analysis results reveal relationships between the production, quality, and availability of data, the balance of foreign trade, and the importance of wood in domestic consumption. Wood flow analysis is focused on all uses of wood and takes into account by-products and waste generated by processing the material input for further use. Both sides of the balance, the resources and the use side, are specific, as they incorporate different markets and products; therefore, it is necessary to examine each side individually. The overall structure of the balance is not constant and may vary depending on the uses of wood and wood products. In most cases, the balance includes such uses of wood for which there are no official statistics available, and the total consumption therefore cannot be simply calculated. Consequently, the consumption of wood may be much higher than indicated by official statistics. Wood balances and material flow analyses have been developed in a number of countries [11], [3], [12], [13]. In general, wood flow analysis is focused more on resources than on products. Official data are not recorded for individual distribution channels in different sectors and products purchased by individual consumers. For these reasons, the analysis of wood flows highlights the need for empirical research and the use of empirically collected data. The balance can either be simply constructed as “wood balance,” or it can reflect a complicated structure of market and material flows as “wood resource balance”. This easily helps analysts to

MATERIAL FLOWS IN PRIMARY WOOD PROCESSING IN SLOVAKIA

Ján Parobek; Hubert Paluš

obtain the missing information and integrates information from the forestry sector, wood processing industry, and energy sector. The approach thus enables one to control and monitor wood flows at a national and international level. Emerging and developing ways of using wood can be easily integrated into the existing flows [14].

The objective of this work was to analyse material flows in primary wood processing in Slovakia. For these purposes, two particular approaches were used - wood balance and wood resource balance.

2 Material and Methods

A single wood balance presents a global view of the resources and primary uses of roundwood in Slovakia. The main categories of resources are represented by the domestic roundwood production and imports, and the main uses by the domestic roundwood consumption and exports. The resource side is complemented by the recycled material and stock decrease, and the use side by the stocks increase. An increase in stocks causes a decrease in consumption, and *vice-versa*. The availability and consistency of data represent a limiting factor for the construction of the wood balance. Available data for 2013 from the FAOSTAT database [15] and the reports on forestry in Slovakia [16] were used. To achieve the state of wood balance, the resources should equal the uses. However, there were no data available on domestic consumption; therefore, it was deducted from the volumes of roundwood production and foreign trade.

The wood resource balance provides a detailed analysis of wood and wood products flows. Unlike the wood balance, which takes into account only uses of wood as a material, the wood resource balance is focused on different uses within the internal environment of the sector. First of all, it takes into consideration by-products and waste generated by the production for use as inputs in wood processing or in the energy sector. The main categories of resources are i) forest woody biomass, ii) used material, iii) other woody biomass, iv) wood processing residues and v) processed wood fuel. The main categories of uses consist of i) wood processing industry (material stream) and ii) energy use (waste stream).

The quality of the final wood resource balance depends directly on the quality and availability of data on wood production and use in individual sectors. Generally, the availability of data on consumption is usually poor, and detailed data do not exist. Empirical research and expert estimations based on the available production data are commonly used to obtain the missing data. Under current conditions, wood resource balance data can be compiled as a mix of officially published and empirically collected data. Official statistics are available for highly concentrated sectors such as the pulp and paper industry. However, certain sectors of the wood processing industry,

such as the sawmill industry, are poorly concentrated; thus, access to data is complicated. Therefore, to estimate the material flows the main streams of primary wood processing and utilization were only considered, in particular sawmilling industry, veneer and plywood production, particleboard and fibre board production, processed wood fuel, pulp and paper industry, energy biomass for power and heat, industrial internal use, and private households. To quantify flows and balances in a single measurement unit (m^3), the UNECE/FAO [17] official input/output ratios for Slovakia were used.

3 Results and Discussion

The primary wood resources are represented by the domestic roundwood production of 8.06 mil. m^3 . The actual level of wood supply is to a certain extent affected by the binding provisions of the valid management plans and thus it is an inelastic supply. The final level of wood consumption and market changes are the reflection of the influence of a range of social, economic and demographic factors, industry structure and the level of industry development. Wood supply is affected by the factors such as available cut, accidental felling, wood stock from previous periods, ownership structure, own consumption, wood price, price of production factors, valid legislation, etc. The volume of the actual felling is relatively stable from a long-term perspective, though a share of accidental felling is quite high (up to 70%). The resource side is complemented by the import of roundwood (0.922 mil. m^3) and is represented mostly by the import of non-coniferous pulpwood used for pulp production, and by the recycled material calculated as the domestic production plus import and reduced by export.

The total resources were 8.984 mil. m^3 roundwood equivalents. The use side of the balance is represented by the roundwood export, which was 3.122 mil. m^3 . The share of roundwood exports for is relatively high (35%) and significantly reduces the domestic availability of certain roundwood assortments. The volume of domestic consumption (5.862 mil. m^3) was deducted from the volumes of roundwood production and foreign trade. The wood balance presents a global view of the resources and primary uses of roundwood in Slovakia and is illustrated in Table 1. Because of the unavailability of data, we do not consider the stock changes.

MATERIAL FLOWS IN PRIMARY WOOD PROCESSING IN SLOVAKIA

Ján Parobek; Hubert Paluš

 Table 1 Wood Balance in Slovakia (m³)

| Sources | | Use | |
|----------------------|----------|-------------|----------|
| Roundwood production | 8062587 | Export | 312200 |
| Import | 922000 | | 0 |
| Used paper* | 297 | | 586288 |
| | | Consumption | 4 |
| Total sources | 10782446 | Total uses | 10782446 |

The wood resource analysis shows that the total resources were 8.731 mil. m³ roundwood (Table 2). Roundwood volume on the resource side is supplemented by wood processing residues consisting mainly of sawmill residues and black liquor. These residues account for 16% of the total resources. The majority of residues (1.3 mil. m³ roundwood equivalents) was produced by the sawmill industry.

Taking into account the overall estimated data, almost 83% of all resources used in Slovakia originated in forest biomass, 17% were from industry waste. On the other hand, over 84% of resources were used industrially, while nearly 16% were used for energy purposes.

At the same time, the sawmill industry is the key producer of wood products on the use side of the balance, followed by the production of pulp and wood-based panels. The consumption of energy wood in its different forms was estimated over 3 mil. m³. This overall estimate comprises energy wood for households, power, and heat production, as well as direct consumption in the wood processing industry. Wood fuel industry is a very specific sector, with the production of 31,000 m³ roundwood equivalents. Most of this production, however, is exported from the country, and only a small portion occurs on the resource side.

The sawmill industry with its production of 1.43 mil. m³ sawnwoods represents the main consumer of roundwood (coniferous) as well as the main producer of wood products in Slovakia. The final volume of production by the pulp and paper industry is important consumer of non-coniferous pulpwood. However, because of the intensive material input/output ratio, the final production was only 0.7 mil. t. Most of this production is represented by chemical pulp, where the input/output ratio is the highest (4.5).

Table 2 Wood Resource Balance

| Resources | (m ³) | Use | (m ³ , t) | |
|----------------------|----------------------------------|--|---|-------------------------|
| Forest woody biomass | Logs | Sawmill industry | 1430000 | |
| | Pulp wood | | Energy, plywood and other large boards production | 19000 |
| | Other industr. wood | Particleboard and fibre board production | | 620000 |
| | Wood fuel | | Processed wood fuel production | 31000 |
| | Energy wood and logging residues | 262570 | | |
| | Energy chips from forest | 500000 | | |
| | Recycled material | 1010 | Pulp and paper industry | 700000 |
| | Other woody biomass | Wood outside forests | Energy biomass for power and heat | 1134000 |
| | | Sawdust | | Industrial internal use |
| | Chips | Private households | 700000 | |
| Particles | 930000 | | | |
| Black liquor | 557000 | | | |
| Total | 8731739 | | 5890000 | |

On the other hand, the lowest ratio (1.4) was determined for roundwood needed for the production of particleboard. The industry produced an output of 0.52 mil. m³ and from the viewpoint of raw material utilisation, it belongs to the industries with the lowest rates of residue production.

MATERIAL FLOWS IN PRIMARY WOOD PROCESSING IN SLOVAKIA

Ján Parobek; Hubert Paluš

Conclusions

Wood residues and by-products are produced during industrial processing of wood. The waste stream is represented by different types of waste generated during the logging operations (e.g., logging residues) as well as the waste generated during primary mechanical and chemical processing of wood (sawdust, chips, black liquor), which can be used either industrially or for the production of energy. The primary source of wood residues used for production of agglomerated wood-based panels, processed fuel wood, and energy generation is the sawmilling industry.

Wood balance is primarily used to estimate domestic consumption, regardless of the further use of wood; unlike the wood resource balance, it considers foreign trade in wood products. Taking into account roundwood classification, the wood resource balance distinguishes wood flows for individual sectors according to the intended use of assortments. Logs are primarily processed by sawmills, and only a small portion is consumed by plywood or veneer producers.

As a paradox, in spite of the large proportion of broadleaved forests in Slovakia, coniferous logs are the primary raw material used by sawmills. Non-coniferous pulp wood and other industrial roundwood is used by the pulp and paper industry for the production of pulp, or alternatively for the production of particleboard and fibre board.

The importance of wood for energy production has been increasing recently. Wood fuel is used for energy production in either internal or external facilities. At the same time, it represents a significant source for heat energy in households. Wood, which was traditionally utilised as material for the production of wood products, is presently in demand for energy production. The increasing direct or derived demand for energy wood causes an increase in energy wood prices.

Acknowledgements

The authors are grateful for the support of the Scientific Grant Agency of the Ministry of Education, Science, Research, and Sport of the Slovak Republic, Grant No 1/0473/16, "Dynamics and determinants of wood based products market in the Slovak Republic".

References

- [1] PAROBEK, J., PALUŠ, H.: Modelling of wood and wood products flow in the Slovak Republic," in: *A European Wood Processing Strategy: Future Resources Matching Products and Innovations*, Ghent University, Belgium, pp. 93-99, 2008.
- [2] EUROSTAT: Economy-wide material flow accounts and derived indicators: A methodological guide, retrieved from: http://epp.eurostat.ec.europa.eu/cache/ITY_OFFPUB/KS-34-00-536/EN/KS-34-00-536-EN.PDF, 2001.
- [3] BINDER, C. R., HOFER, C., WIEK, A., SCHOLZ, R. W.: Transition towards improved regional wood flows by integrating material flux analysis and agent analysis: The case of Appenzell Ausserrhoden, Switzerland, *Ecological Economics* 49(1), pp. 1-17, 2004.
- [4] FISHER-KOWALSKI, M.: Society's metabolism, the intellectual history of material flow analysis, *Journal of Industrial Ecology* 2(1), pp. 61-78, 1998.
- [5] HINTERBERGER, F., GILJUM, S., HAMMER, M.: Material flow accounting and analysis (MFA): A valuable tool for analyses of society-nature interrelationships, retrieved from: <http://seri.at/wp-content/uploads/2009/09/Material-Flow-Accounting-and-Analysis-MFA.-Encyclopaedia-of-the-International-Society-for-Ecological-Economics-ISEE.pdf>, 2003.
- [6] ZHOU, Z., SUN, L.: Preliminary research on regional material flow analysis: A case study of Chengyang District in Qingdao, *Journal of Northeast Agricultural University* 15(2), pp. 41-47, 2008.
- [7] BRINGEZU, S.: Industrial ecology and material flow analysis. Basic concepts, policy relevance and some case studies, in: *Perspectives on Industrial Ecology*, D. Bourg and E. Suren (eds.), Greenleaf Publishing, Sheffield, UK, pp. 24-30, 2003.
- [8] BACCINI, P., BADER, H. P.: *Regionaler Stoffhaushalt. Erfassung, Bewertung und Steuerung*, Spektrum, Heidelberg, Germany, 1996.
- [9] MÜLLER, D.: Szenarien zur nachhaltigen regionalen Holzbewirtschaftung, *Schweizerische Zeitschrift für Forstwesen* 147(11), pp. 873-885, 1996.
- [10] SCHWARZENBACH, R. C., HEITZER, A., STÄUBLI, B., GROSSMANN, B., SCHOLZ, R. W.: A regional perspective on contaminated site remediation - Fate of materials and pollutants, *Environmental Science and Technology* 33(14), pp. 2305-2310, 1999.
- [11] HEKKERT, M. P., JOOSTEN, L. A. J., WORRELL, E.: Analysis of the paper and wood flow in the Netherlands, *Resources, Conservation and Recycling* 30(1), 29-48, 2000.
- [12] PIŠKUR, M., KRAJNC, N.: Roundwood flow analysis in Slovenia, *Croatian Journal of Forest Engineering* 28(1), pp. 39-46, 2007.
- [13] KNAGGS, G., O'DRISCOLL, E.: Estimated woodflow for the Republic of Ireland in 2007, retrieved from: <http://www.coford.ie/media/coford/content/publications/projectreports/cofordconnects/woodflow.pdf>, 2008.

MATERIAL FLOWS IN PRIMARY WOOD PROCESSING IN SLOVAKIAJán Parobek; Hubert Paluš

- [14] MANTAU, U., SAAL, U., PRINS, K., STEIERER, F., LINDNER, M., VERKERK, H., EGGERS, J., LEEK, N., OLDENBURGER, J., ASIKAINEN, A., ANTTILA, P.: EUwood real potential for changes in growth and use of EU forests, retrieved from: http://ec.europa.eu/energy/renewables/studies/doc/bioenergy/euwood_final_report.pdf, 2010.
- [15] FAO: FAOSTAT - Forestry, retrieved from: <http://faostat.fao.org>, 2015.
- [16] MARD: *Zelená správa 2014*, retrieved from: <http://mpsr.sk/sk/download.php?fID=7840>, 2014.
- [17] UNECE/FAO: *Forest Product Conversion Factors for the UNECE Region*, ECE/TIM/DP/49, UN, Geneva, 2010.

Received: 15 May 2016
Accepted: 25 June 2016

ANALYSE OF THE PRODUCTION OF A SPECIFIC ENTERPRISE WITH A FOCUS ON THE IDENTIFICATION OF BOTTLENECK

Veronika Krešáková

Technical University of Kosice, Faculty BERG, Institute of Logistics, Park Komenskeho 14, 043 84 Kosice, Slovakia,
veronika.kresakova@gmail.com

Keywords: logistics, manufacturing process, analyse, designing, bottleneck

Abstract: Each enterprise is based on processes, either productive or non-productive. Productive processes are made by automatic or semi-automatic production lines or by manpower. This article deals with a semi-automatic production line within a specific company. It aims to show possibilities to locate the bottleneck. An enterprise can also represent an international company, which aims to design and produce high-tech systems and components for the automotive sector. The result of the production process is the “component A”.

1 Introduction

The material flow of the “component A” depends on the reference that is currently produced. Some pre-assembly inputs are made directly in the enterprise and some are obtained by a purchase from the suppliers, depending on the “Make or Buy” decision. The production line obeys the “One piece flow” and the FIFO

method, meaning that the requirements are dealt in the same order, in which they entered the production line. The bottlenecks are being observed within the production process. 100-percent feedback, which is mediated by the DMC codes, is obeyed at each output. The production process (Figure 1) runs non-stop [1].

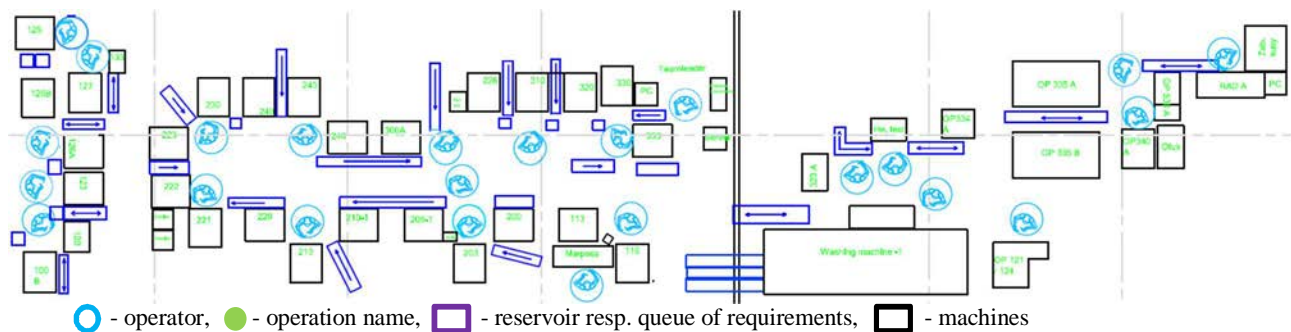

Figure 1 Production line

The production line consists of the following machines, which occur in the line repeatedly:

- Washer and dryer

Everything entering the production process has to be washed, resp. degreased, in order to meet the requirements of the customer and the production process itself. All the components are washed in the chemical A, which is used for the degrease process and then in the chemical B, which secures the surface features of the components, according to the following requirements of the production process. Then, the components are dried with a 110°C hot air.

- Welding machine

The production process requires the welding machines with the laser welding.

- Press machine

In the production process, there are used electrical press machines (pressure test with air – 5 bar, pressure test with helium – 10 bar).

- Measuring device

The quality controls within the process are secured by the cameras (measure of deviation, end of line test). The final control of the product is made by dynamic of static tests, according to the customer’s wish.

2 Bottleneck identification possibilities

The first requirement in the process of finding the bottleneck is to know the production process and the time length of individual operations. According to the analysis of the enterprise, it is possible to create a formal version of the material flow in the production line, which also represents the output of the current-state analysis [2] and

ANALYSE OF THE PRODUCTION OF A SPECIFIC ENTERPRISE WITH A FOCUS ON THE IDENTIFICATION OF BOTTLENECK

Veronika Krešáková

a tool for the creation of block scheme of the simulation model [3]. This scheme shows the individual operation time lengths, queue limitations and the production lines

inputs. The following picture (Figure 2) shows an example of the scheme.

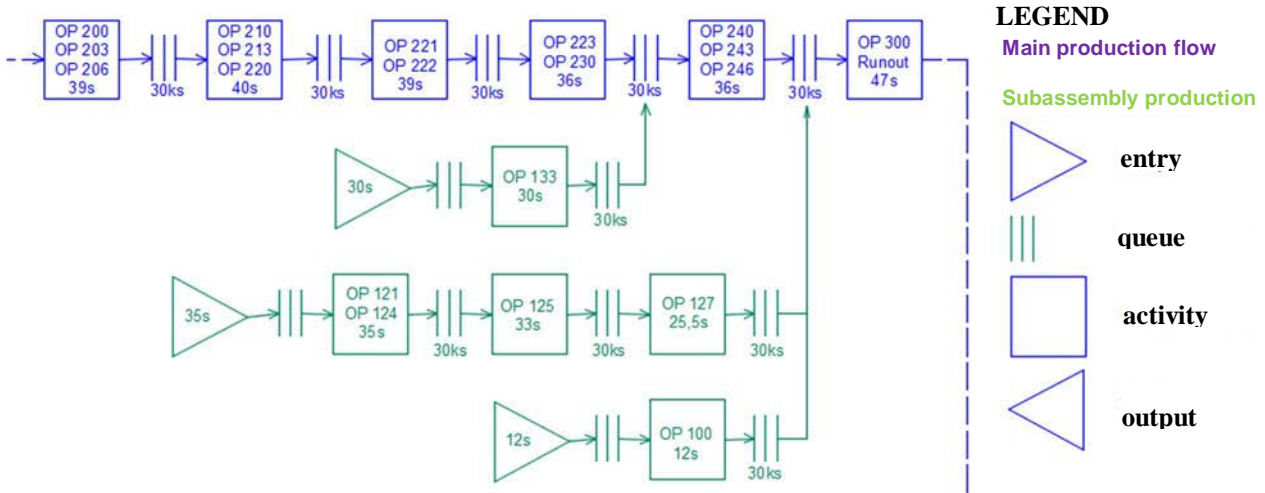

Figure 2 Example of the material flow of the production line

Based on the scheme (Figure 3), it is possible to access the following step, creation of the block scheme of the production line simulation model. One part of the

block scheme can be seen in the following picture. The blocks that are used are found in the Item and Plotter library of the simulation program ExtendSim [4].

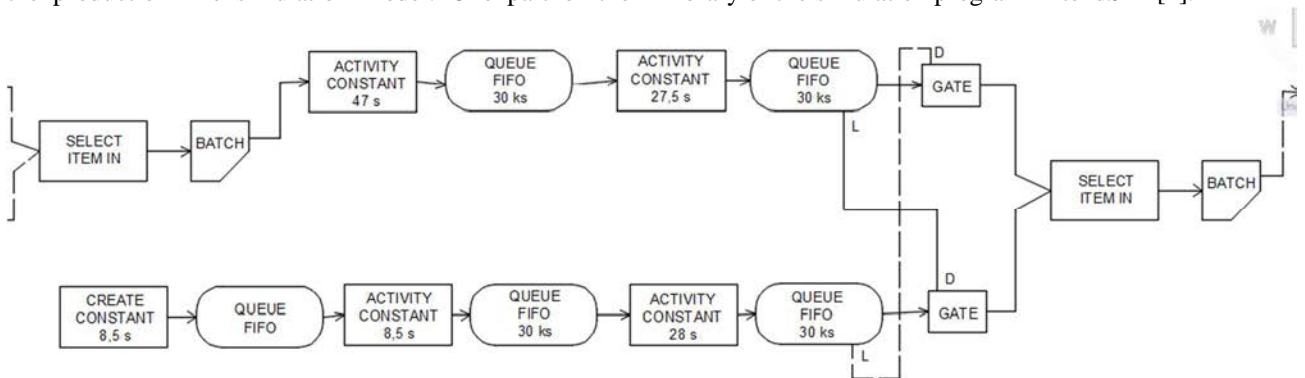

Figure 3 Example of the block scheme of the simulation model of the production line

It is possible to create a simulation model based on the whole simulation model block scheme. The simulation model will simulate the course of the production process, based on which we will be able to find out the usage of the individual machines, resp. it will be possible to see which device has the longest queue in front of it. Such a place will be working on 100 percent and that is why we consider it a bottleneck.

Mapping of the value flow (value stream mapping - VSM) [5], based on the given information from the enterprise, is another method that describes the current state of the material and information flow of the "component A" production. VSM consists of two flows:

- Information flow (Figure 4)

The whole information flow works on the PULL system that begins with the arrival of the orders from the customers in a weekly period. These orders are recorded in PC&L area of the enterprise, which is the department of logistics. The logistics department plans the production process and moves the information further resp. plans the production plan as far as for the last operation of the production process. It gets the data from the production of the last operation retroactively. PC&L area ensures the ordering of the components from the suppliers on a weekly period. The supply of the components from the supplier and sales of the finished products takes place on a weekly period [1].

ANALYSE OF THE PRODUCTION OF A SPECIFIC ENTERPRISE WITH A FOCUS ON THE IDENTIFICATION OF BOTTLENECK

Veronika Krešáková

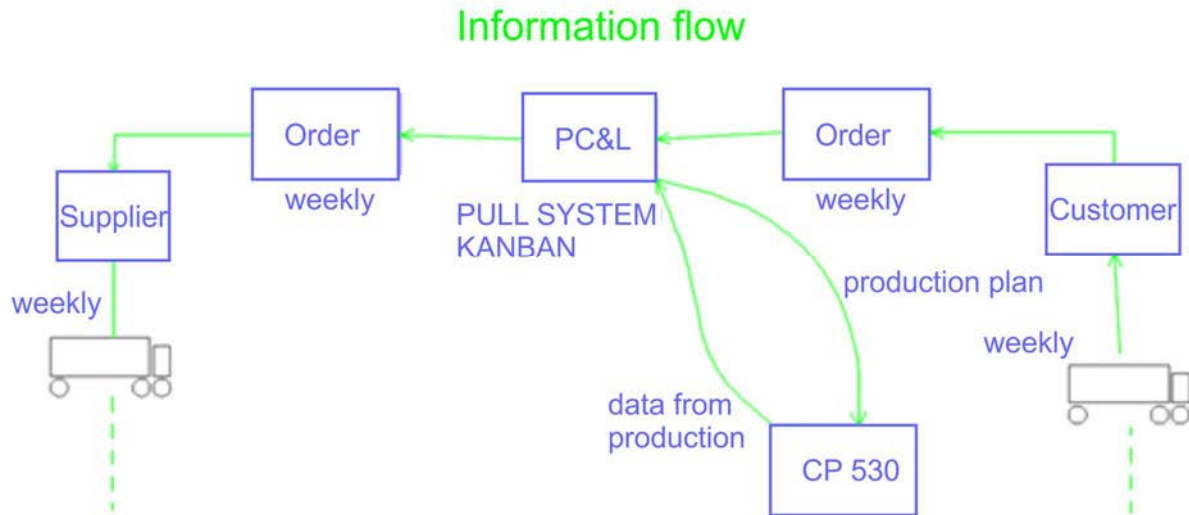

Figure 4 Example of the information flow from VSM

- Material flow (Figure 5)

It is a flow that describes the whole course of the production process, resulting in component A.

Every single operation of the production process has a defined [1]:

- Time of the operation cycle (C/T)
- Capacity of the machine (K)
- Number of the operators (O)

- Number of the changes (Z)
- Total capacity utilization (OEE – Overall equipment effectiveness)

Reservoir, resp. requirement queue is restricted to a maximum of 30 pieces of components, in which FIFO principle is adhered. There also are some reservoirs that have no restrictions [1].

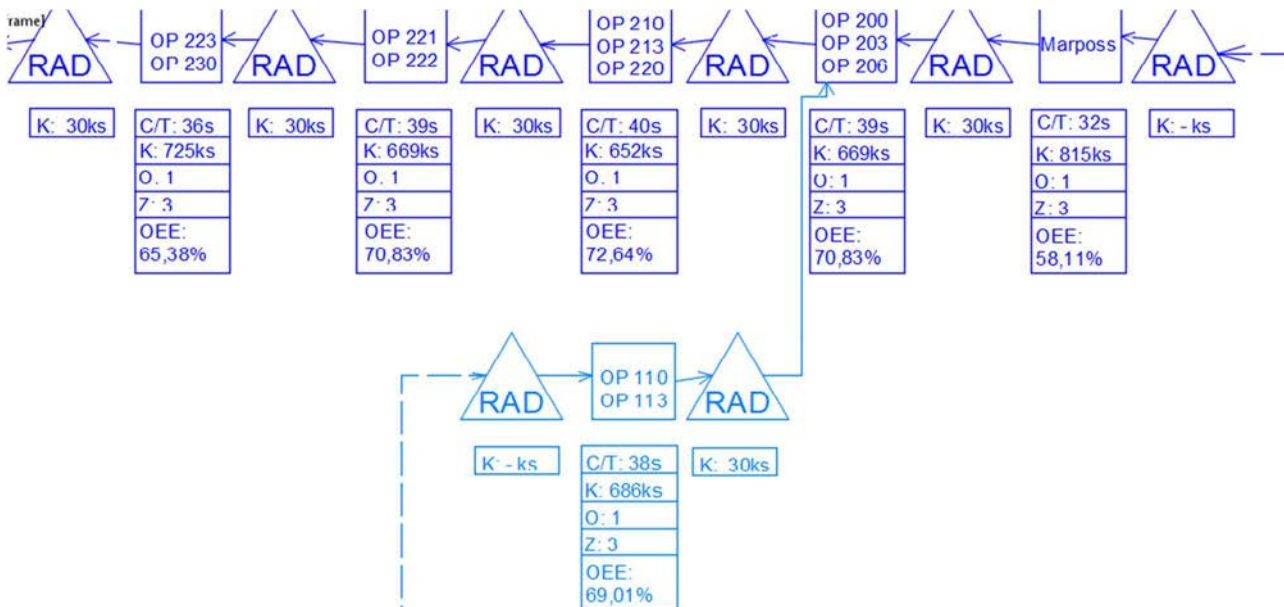

Figure 5 Example of the material flow from VSM

Conclusions

According to the calculated capacity of the machines and overall usage of their capacity, it is possible to construct the following graph (Figure 6).

ANALYSE OF THE PRODUCTION OF A SPECIFIC ENTERPRISE WITH A FOCUS ON THE IDENTIFICATION OF BOTTLENECK

Veronika Krešáková

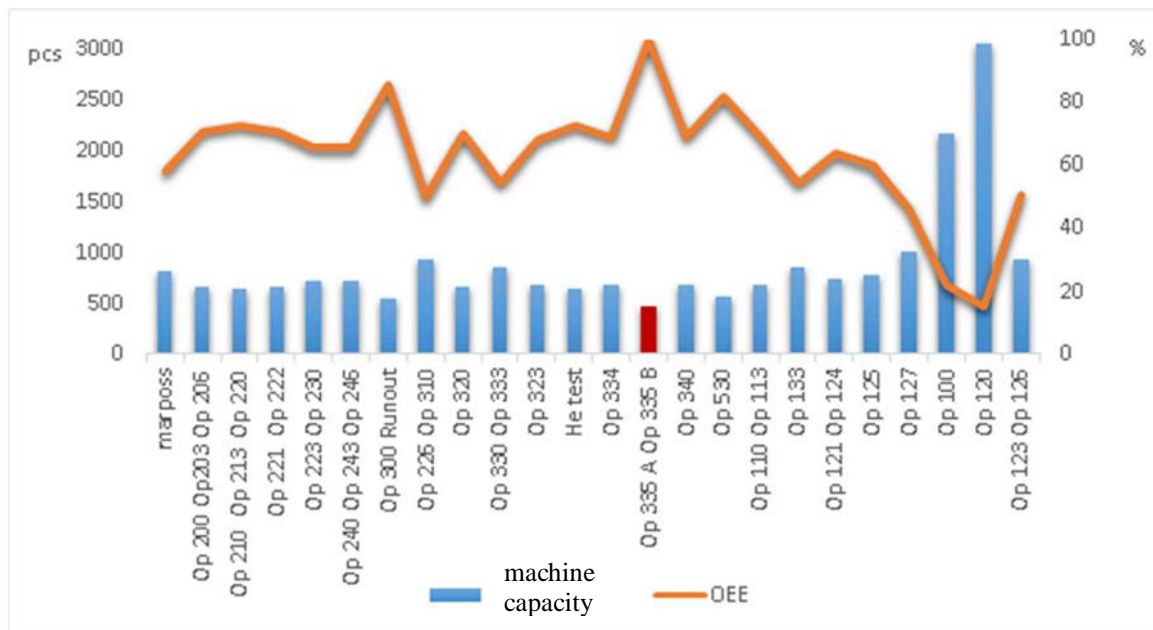

Figure 6 Identification of the bottleneck using the capacities of machines and their overall usage

The graph (Figure 6) concerns about the bottleneck, which is supported by the calculations of the machines capacity and its usage during the production of the component A. Operations OP 335 A and OP 335 B have lower machine capacity resp. they have the ability to produce the smallest number of components. The number of components served by this operation per one shift is approximately 474 pieces, whereas these two operations restrict the production process, because the capacity of other machines reaches its quadruple. The usage of the machines of these two operations is 100%, because it represents the bottleneck, therefore it has to operate non-stop. The output of the production process can only be as many components as can go through the bottleneck.

Based on the identification of the bottleneck, it is possible to consider the following solutions for the elimination of the bottleneck:

- reassessment of the fastest machine,
- reassessment of the row size,
- design of organization changes,
- increasing of the machine capacities.

References

- [1] Internal materials of analysed company OMEGA, 2016. (Original in Slovak)
- [2] MADARÁSZ, L., BUČKO, M., ANDOGA, R.: *Systémová analýza a syntéza*, Košice, 2008. (Original in Slovak)
- [3] MALINDŽÁK, D., ŠINDLER, V.: *Modelovanie výrobných procesov*, Košice, 2001. (Original in Slovak)

[4] STRAKA, M.: *Simulácia diskretných systémov a simulačné jazyky*, Košice, 2005. (Original in Slovak)

[5] MAŠÍN, I.: *Mapování hodnotového toku ve výrobních procesech*. Liberec, 2003. (Original in Czech)

Review process

Single-blind peer reviewed process by two reviewers.

USE OF THE CONCEPT OF CONTINUOUS IMPROVEMENT AS A TOOL FOR OPTIMIZATION OF LOGISTIC PROCESSES

Petr Besta; Kamila Janovská

*Received: 20 May 2016**Accepted: 24 June 2016***USE OF THE CONCEPT OF CONTINUOUS IMPROVEMENT AS A TOOL FOR OPTIMIZATION OF LOGISTIC PROCESSES****Petr Besta**University of Entrepreneurship and Law, Michálkoviccká 1810, 710 00 Ostrava, Czech Republic,
petr.best@vspp.cz**Kamila Janovská**VSB - Technical University of Ostrava, Ostrava, Czech Republic, EU,
kamila.janovska@vsb.cz**Keywords:** innovation, benefits, costs, pricing, competition**Abstract:** Manufacturing companies in today's highly competitive environment are under great pressure. They are constantly forced to seek reserves in their processes. Within logistics we can use dozens of quantifiable parameters which offer us a range of indicators. Manufacturing companies, however, have recently also been trying to use soft tools for the development of the employees' human potential, which can secondarily influence these parameters. One possibility is the application of the Kaizen philosophy. The article deals with the analysis of the research implementing this philosophy in the mechanical engineering production within a company in the Czech Republic.**1. Introduction**

Lean manufacturing is not cost reduction as an end in itself. It is, above all, about maximizing the added value for the customer [1]. Slimming down is a way for the plant to produce more, to reduce overhead costs, to use its resources and production areas more efficiently. Lean production should lead to the elimination of the following forms of waste:

- Overproduction,
- Unnecessary work (activities beyond defined specifications),
- Unnecessary movement (movement that does not add value),
- Inventories (the amount that exceeds the minimum required to meet the production targets)
- Waiting (for components, material, information, or the end of the machine cycle)
- Renovation (reduction of poor quality)
- Transport (each redundant transport and handling)
- Unused abilities of workers [2].

If the manufacturing enterprise wants to eliminate potential resource wastage within business processes, they mainly have to be correctly identified and measured. In general, lean manufacturing can be understood as a philosophy, which seeks to shorten the time between the customer and the supplier, through the elimination of waste in the chain or between chains.

The basic tools of lean manufacturing include these techniques and methods: Kaizen, TPM, lean workplace, Kanban, TPM, teamwork, quality processes and standardized procedures, value flow management [3].

The initial steps towards leaner processes have four main objectives: improving the quality, eliminating losses, shortening the time of the production, reducing overall costs. The loss means any activity of the enterprise that requires time, resources or space, but that does not bring value to the product or the entire production process. Some activities, such as moving materials during the production, are necessary, but do not add value. The overall costs are the direct and indirect costs associated with the manufacture of a product or with the preparation of a service. For an organization to be successful, the prices of its products and services and their operating costs have to be constantly compared. If its price or its operating costs are too high, it may lose market share or profits. To reduce its overall costs, the company must eliminate losses and reduce the time required to realize its processes.

2. Kaizen as a concept for reducing costs

One of the alternative possibilities to constantly seek ways to improve and eliminate wasting can be the application of the Kaizen philosophy. Kaizen means continuous improvement across all corporate levels. When applied in a manufacturing company, Kaizen means continuous improvement involving everyone - from managers to ordinary workers [4]. In the scope of Kaizen, improvement is perceived as an ongoing process consisting of small steps. In each area, for each segment, it is always possible to make small changes that will lead to the improvement of the status quo. It is therefore a sequence of small but continuous improvements that will be implemented continuously in all business processes. The diagram of continuous improvement through small steps is basically the opposite of the improvements

USE OF THE CONCEPT OF CONTINUOUS IMPROVEMENT AS A TOOL FOR OPTIMIZATION OF LOGISTIC PROCESSES

Petr Besta; Kamila Janovská

realized through major investments and costly projects. These processes are the basis for reengineering philosophy. The introduction of the principles of Kaizen does not require any special techniques, but it uses proven methods which have been known and in many cases used for a long time: customer orientation, absolute quality control, process automation, quality control circles, system of improvement proposals, discipline at the workplace, just – in – time, the movement of zero defects, developing new products.

Kaizen is a core element of the concept of lean production mainly to identify what represents a value and what represents wasting for the production company [5]. Things that do not provide the company with a positive effect represent a potential source of waste, or they may represent it in the future. The main causes of waste can generally be divided into three basic terms: Muda – a loss, uselessness; Mura – irregular, uneven; Muri – disproportionate, tight. In the area of manufacturing companies, the largest part of the potential sources of waste include the following areas: unnecessary production processes, high inventories, poorly organized workplace, manufacture of low-quality production.

Implementation of this philosophy within manufacturing companies in the Czech Republic, however, is based on four important factors. The aim of the Kaizen philosophy within lean manufacturing is mainly to motivate employees to creative thinking, which supports limiting the possible sources of waste. Therefore, it is important to promote staff training and motivation in the production company. Furthermore, the goals of the entire implementation process must be set properly, and, above all, it is necessary to build an active level of communication across the whole hierarchy of the company.

Ultimately, Kaizen is based on bilateral orientation, where maximum attention is paid to customers, but also to employees of the company. In our conditions, what is proving most effective is to start continuous improvements in the area of removal of waste directly within the production.

The four areas that are important for the successful implementation of the Kaizen philosophy within lean manufacturing:

- Communication – ineffective communication processes hinder or even prevent the successful process of continuous improvement. Underestimating this area can have negative consequences for a company seeking to implement Kaizen.
- Goals – clearly and transparently defined objectives at all levels of management enable the establishment of a visible management.
- Motivation – a key factor is that employees themselves were interested to participate in the continuous improvement process.

- Education – as the main instrument for the development and improvement of employees and the entire company.

Kaizen as a system is subject to the involvement of the broadest spectrum of the company employees. This is possible only in cases of the effective functioning of communication in the company [6], both in terms of interpersonal communication within the company, and public communication. To achieve this, it is also necessary to set up a system of visible management, where employees will be clearly and accurately informed about what is happening in the enterprise. Effective communication in the company is not only a prerequisite for the use of the principles of continuous improvement, but generally it makes all business processes easier and faster. Within the development of the communication, it is particularly necessary to support all its vertical forms [7].

During the implementation of the Kaizen philosophy in the concept of lean manufacturing, it is advisable to start with the use of good management (5S). This technique focuses primarily on order and preventive activities at the workplace, and its application is undemanding in terms of organization and demands on further education of workers.

3. Benefits of the implementation of good management 5S in the selected mechanical engineering enterprise

As part of the research, the benefits of introducing the concept of good management within a mechanical engineering enterprise in the Czech Republic were identified. Within the implementation of five steps to good management, the machinery was fundamentally reordered in some divisions in the monitored mechanical engineering enterprise. Within the first S, excess machinery was removed. The means of production were then divided into several parts, according to the individual projects. As a first step of good management, all the machinery was assessed against the following criteria:

- Utilization of equipment,
- Functionality,
- Operations carried out,
- Technical condition.

For example, in the hydraulics division, 12 pieces of the machinery out of a total of 82 were removed based on the results of this analysis. Most of this machinery was used rather infrequently and the activities carried out at this machinery could be taken over by other machines. Sorting the machinery was originally conceived technologically; the individual pieces of machinery were grouped according to technological operations, although it was not the case of separate workshops. Due to two large long-term projects, the original production hall of the hydraulics division was divided into three parts. Two parts were intended for realized projects and the third one

USE OF THE CONCEPT OF CONTINUOUS IMPROVEMENT AS A TOOL FOR OPTIMIZATION OF LOGISTIC PROCESSES

Petr Besta; Kamila Janovská

was intended for individual (custom) manufacturing. Given these facts, the division switched from the technological rather to product arrangement. Figure 1 shows the distribution of the original production machinery in the hydraulics division. The marked machinery (grey colour) was removed from the operation for its redundancy.

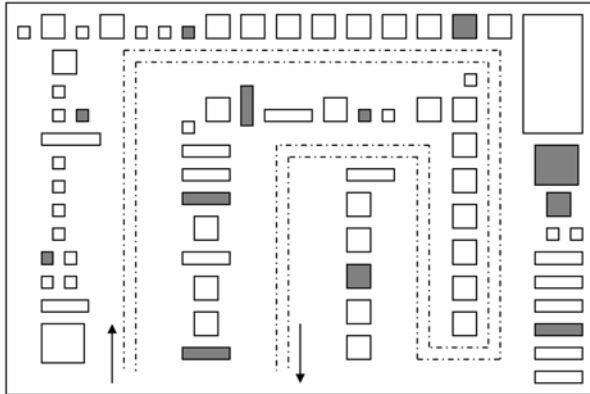

Figure 1 The original layout of the production machinery

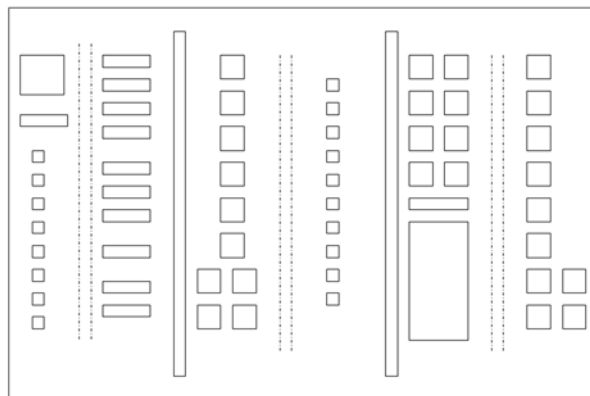

Figure 2 The new layout of the machinery

Figure 2 shows the new layout of the hydraulics division. The machinery is grouped according to the individual projects. Old unused machines were completely taken out of the operation. The production hall is divided into three parts. Besides reducing the cost of maintenance and operation of unused machinery, this measure significantly increased the clear arrangement in the production hall area. Moreover, in the previous system of the machinery arrangement (Figure 1), there were also places that were minimally used (dead spots – areas) due to improper positioning of machines. During routine checks of the hall, it was not even possible to take a look at these places (Figure 3).

Rearranging the production space also greatly improved the transparency of the workplaces and checking the personnel. The new arrangement also facilitated handling pallets, in which semi-finished or finished goods are stored. In the old model, a higher

volume of production was not much considered, and basically, no space for their storage was specified. Pallets were often placed on completely inappropriate sites, such as routes between machines. With higher production volume, movement in the production areas was very difficult. In the new arrangement, there are places marked in colour, reserved for a variety of products, semi-finished products and waste. The creation of three separate projects also meant the division of workers. The division into smaller groups working on the particular project has resulted in the development of employees' team approach. Smaller groups of workers make it possible to establish and develop a philosophy of teamwork more easily.



Figure 3 Inefficient use of a desktop

4. The development of work in progress

Inventories of work in progress are a core group of stocks. For the monitored company operating in the field of heavy engineering, it is a significant item in the inventory, the amount of which considerably affects competitiveness. One of the great successes of the introduction of the Kaizen philosophy was a substantial reduction of work in progress. In a period of four years, the amount of work in progress was reduced by more than fifty percent (Table 1). An important step towards this success was the introduction of good management 5S, as well as the SAP information system, which enabled to accurately monitor the status of work in progress at individual workplaces. Thanks to accurate records, it was possible to set a specific value of work in progress, which was decreased in small steps. Given the scale of the production and its smooth operation, it was not possible to proceed too aggressively in this case and significantly reduce the value of work in progress. The current status of the value of work in progress is getting closer to the optimum level. Another positive effect is that employees themselves started to be interested in this issue because of the positive value of this indicator for them meant a financial reward (small bonus). The management of each division currently regularly informs employees about the development of this indicator on the company bulletin boards.

USE OF THE CONCEPT OF CONTINUOUS IMPROVEMENT AS A TOOL FOR OPTIMIZATION OF LOGISTIC PROCESSES

Petr Besta; Kamila Janovská

Table 1. Development of the status of work in progress

| Date | Division | | | | | In total |
|-----------|-------------------|------------|--------------------------|-----------|----------------|-----------|
| | Engineering plant | Hydraulics | Forge and tempering room | Tool room | Loading cranes | |
| 30.3.2013 | 721 212 | 2 117 456 | 2 965 509 | 75 537 | 667 089 | 6 546 803 |
| 30.9.2013 | 796 443 | 2 982 865 | 2 501 500 | 83 465 | 828 200 | 7 192 473 |
| 30.3.2014 | 527 313 | 2 070 737 | 1 807 615 | 80 371 | 807 900 | 5 293 936 |
| 30.9.2014 | 376 059 | 1 191 037 | 1 635 310 | 104 944 | 1 026 451 | 4 333 801 |
| 30.3.2015 | 409 604 | 1 228 997 | 1 485 767 | 195 291 | 666 787 | 3 986 446 |
| 30.9.2015 | 373 483 | 1 445 271 | 984 450 | 173 067 | 469 799 | 3 446 070 |
| 30.3.2016 | 596 386 | 1 153 658 | 841 306 | 122 366 | 366 581 | 3 080 297 |

Table 2 shows the development of work in progress as a percentage. A high decrease in work in progress, which is in tens of percent, can be seen very well. The only workplace, which, in turn, showed an increase, is the tool room. It is, however, due to the acquisition of new products that other centres utilize as well.

Table 2. Development of the status of work in progress in percentage

| Division | | | | | Company as a whole |
|-------------------|------------|--------------------------|-----------|----------------|--------------------|
| Engineering plant | Hydraulics | Forge and tempering room | Tool room | Loading cranes | |
| -17.3% | -45.5% | -71.6% | +61.9% | -45.0% | -52.9% |

5. Conclusions

According to the conclusions of the research, the Kaizen philosophy as a tool of continuous improvement can also fundamentally affect purely logistical parameters. Within the implementation of this concept, the manufacturing workplace was rearranged, but there was also a substantial reduction in the value of work in progress. Continuous improvement can permanently affect the company's competitiveness. It is, however, always necessary to realize that this is a never-ending process. Achieving a certain level should be seen only as a temporary state before the system is moved to another level.

References

- [1] IMAI, M.: *Kaizen*, Praha: Grada, a.s., 2004.
- [2] DAVIS, J. W.: *Lean manufacturing: implementation strategies that work: a roadmap to quick and lasting success*, Industrial Press Inc., 2009.
- [3] CHANDRA, CH., GRABIS, J.: *Supply chain configuration: concepts, solutions and applications*, Springer, 2007.

- [4] KOŠTURIÁK, J.: *Inovace – Vaše konkurenční výhoda*, Praha: Computer Press, s.r.o., 2008. (Original in Czech)
- [5] PERNICA, P.: *Logistika pro 21. století*, 3. díl. Praha: Radix, s.r.o., 2005. (Original in Czech)
- [6] WILSON, L.: *How to implement Lean Manufacturing*, McGrawHill Professional, 2009.
- [7] MONCZKA, R., M.; HANDFIELD, R., B.; GIUNIPERO, L.: *Purchasing and Supply Chain Management*, Cengage Learning, 2008.

Review process

Single-blind peer reviewed process by two reviewers.

Received: 15 May 2016

Accepted: 27 June 2016

SUPPLIER QUALITY ASSURANCE – STEP TO COMPETITIVE ADVANTAGE

Peter Malega

TU of Košice, Faculty of Mechanical Engineering, Institute of technology and management, Department of Industrial Engineering and Management, Némcovej 32, 04 200 Košice, peter.malega@tuke.sk

Keywords: supplier quality assurance, SQA process, competitive advantage

Abstract: This paper aims to provide the main directions for the standardization of Suppliers Quality Assurance (SQA) processes. The standardization of such processes is to provide a “same face” to SQA areas, allowing their interaction, exchange of information, adoption of best practices and achievement of better and comparable results, besides the recognition, by global Suppliers point of view, of only one company.

1 Introduction

If the company wants to be competitive, it must think about lot of key things [13]. One of the most important is supplier quality assurance, which is confidence in a supplier's ability to deliver a good or service that will satisfy the customer's needs [9]. Achievable through interactive relationship between the customer and the supplier, it aims at ensuring the product's 'fit' to the customer's requirements with little or no adjustment or inspection [11].

2 Basics of supplier quality assurance

The US quality guru Joseph Moses Juran divides the supplier quality assurance process into nine steps [8], [9], [10]:

1. definition of the product's quality requirements,
2. evaluation of alternative suppliers,
3. selection of the most appropriate supplier,
4. conduction of joint quality planning,
5. cooperation during relationship period,
6. validation of conformance to requirements,
7. certification of qualified suppliers,
8. conduction of quality improvement plans,
9. creation and use of supplier ratings.

The Suppliers Quality Assurance processes are designed to promote the management of the quality of outsourced raw materials/components, since their initial qualification until their final performance at Customers and in the field. These processes are four [5], [6], [7]:

1. item/supplier certification,
2. item/supplier quality monitoring,
3. corrective action,
4. suppliers quality improvement.

Suppliers Quality Assurance process is shown in figure 1 [8].

The Suppliers Quality Assurance processes must be aligned with the company strategies, serving as a support to the achievement of established targets and measured through defined Key Performance Indicators (KPIs). Such processes shall be sustainable and flexible, since changes might be introduced anytime due to a changing environment [6].

Changes in processes usually require adaptations in culture and behaviours or, in other words, changes in the mind set. This interconnection is shown in figure 2 [2].

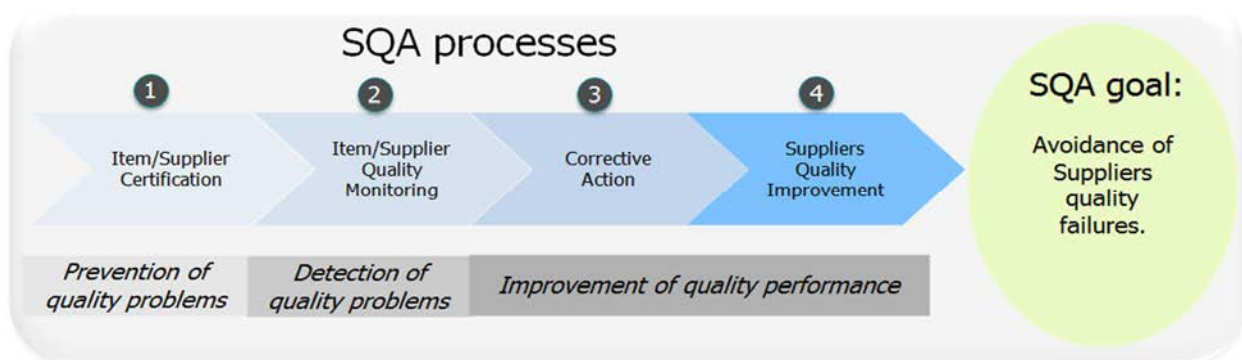

Figure 1 Suppliers Quality Assurance process [8]

SUPPLIER QUALITY ASSURANCE – STEP TO COMPETITIVE ADVANTAGE

Peter Malega



Figure 2 Interconnection in SQA process [2]

The effectiveness of how Suppliers Quality Assurance processes are being operated and providing expected results must be regularly questioned and checked, through a suitable governance, and changes introduced, as necessary, in order to promote their continuous improvement. The cycle (Figure 3) represents, on a simplified way, how this might be carried out [3], [4], [5].



Figure 4 Area of SQA processes [3]

3 Operation of supplier quality assurance

SQA Processes are composed by activities, supported by standard tools, methods and records, which must be properly standardized and accomplished by all company’s Suppliers Quality Assurance areas of every site. This is shown in Fig. 4.

These processes and related activities must serve to [1], [2], [3], [4]:

1. prevent the occurrence of quality related nonconformities,
2. treat quality excursions of supplied raw materials/components to avoid recurrence,
3. promote the continuous quality improvement of such materials,
4. monitor and report to Organization the Suppliers quality performance,
5. allow comparisons of suppliers’ base quality performance among sites.

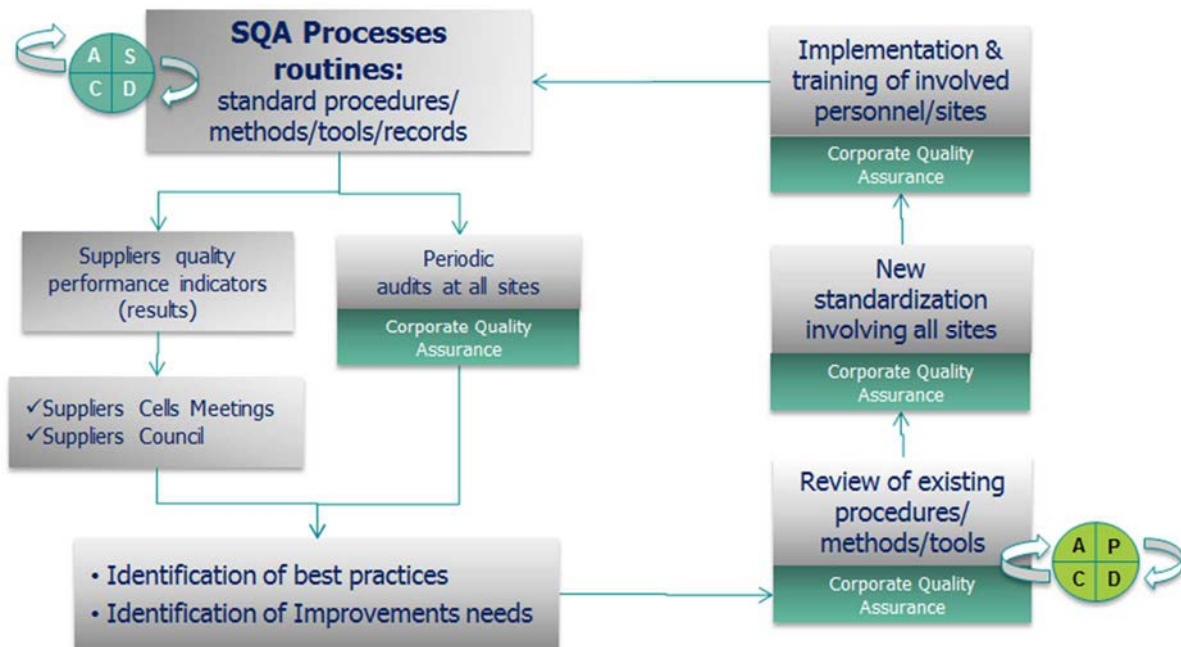

Figure 3 Suppliers Quality Assurance process [5]

SUPPLIER QUALITY ASSURANCE – STEP TO COMPETITIVE ADVANTAGE

Peter Malega

When we want to evaluate SQA process, we have to go back to the figure 1, which consists of 4 basic processes, which have to be evaluated separately [12].

3.1 Step 1 – Item/Supplier Certifications

Item/Supplier Certifications is a process conducted by SQA as a support to Procurement area, aiming to get robustness in every approved supplier certification step and to promote the acquisition of knowledge about Suppliers manufacturing processes.

Figure 5 depicts the involved activities, standard tools and process indicators related to the Item/Supplier Certification process.



Figure 5 Suppliers Quality Assurance process – step 1 [12]

3.2 Step 2 – Item/Supplier Quality Monitoring

Item/Supplier Quality Monitoring (Figure 6) aims to check, on a continuous basis, the quality performance of supplied items and respective Suppliers as a whole, generating Key Performance Indicators and scores, as well as essential information to fix undesired results, to identify/prevent potential failures and to provide evidences to support decisions related to the supplier’s base.

The defined activities above are applied to provide clear evidences about the quality performance of supplied items/Suppliers and to prevent quality excursions.

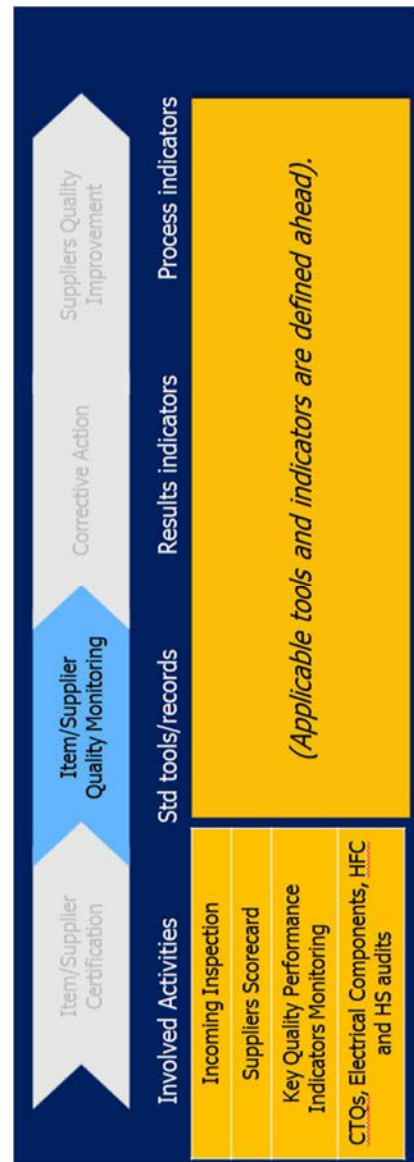

Figure 6 Suppliers Quality Assurance process– step 2 [12]

3.3 Step 3 – Corrective Action

Corrective Action (Figure 7) is a process having a single activity (“Corrective Action”) which aims, through

SUPPLIER QUALITY ASSURANCE – STEP TO COMPETITIVE ADVANTAGE

Peter Malega

involved suppliers plus internal resources, the identification of the root causes of anomalies presented by purchased raw materials/ components and the promotion of improvement actions over such causes in order to avoid recurrence.

The Corrective Action activity has to use standardized methodology to be applied by the involved suppliers, which results have to be submitted and validated by company’s team.

3.4 Step 4 – Suppliers Quality Improvement

Suppliers Quality Improvement (Figure 8) has to promote the continuous improvement of the quality of supplied items/Suppliers, measured through the quality performance indicators (KPIs). These indicators have to show positive trend along the time, in order to demonstrate that implemented improvements are effective.



Figure 7 Suppliers Quality Assurance process– step 3 [12]

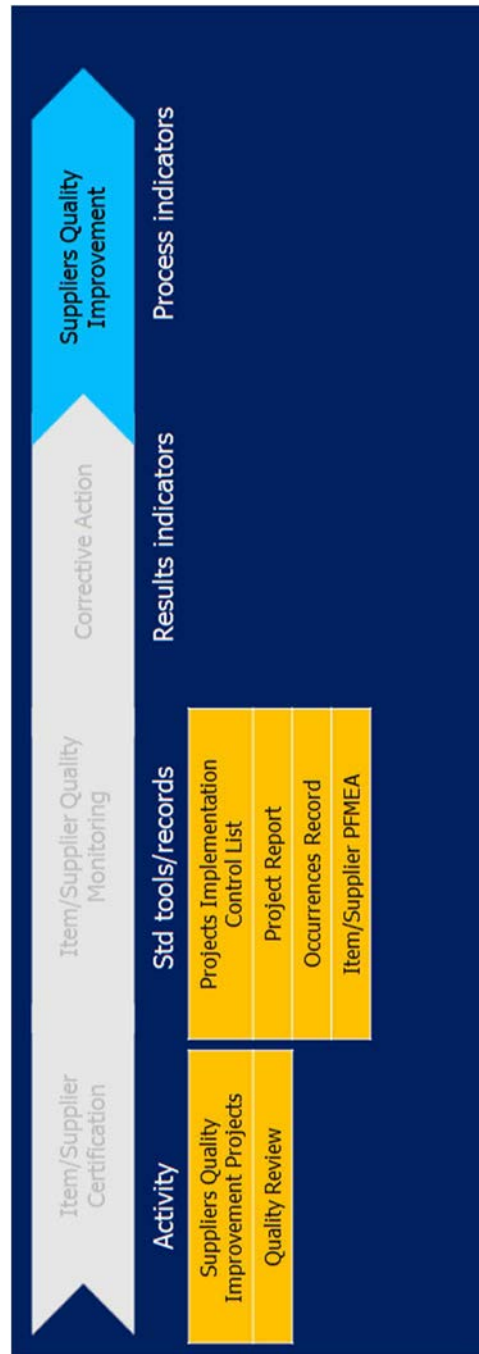

Figure 8 Suppliers Quality Assurance process– step 4 [12]

SUPPLIER QUALITY ASSURANCE – STEP TO COMPETITIVE ADVANTAGE

Peter Malega

Conclusion

For quality assurance purposes, intensive collaboration is required between the company and its suppliers to establish a suitable evaluation process based on an objective appraisal of quality capability and quality performance. This may range from initial sample inspection to quality appraisal of parts from series production. [1], [5], [8]

Acknowledgements

This article was created by implementation of the grant project VEGA 1/0741/16 "Controlling innovation of the industrial companies for the sustaining and improving their competitiveness".

References

- [1] BAUDIN, M.: *Lean Logistics*, New York, Productivity Press, p. 400, 2004.
- [2] BOTTANI, E., RIZZI, A.: A fuzzy multi-attribute framework for supplier selection in an e-procurement environment, *International Journal of Logistics: Research and Applications*, Vol. 8, No. 3, pp. 249 -266, 2005.
- [3] BRAGLIA, M., PETRONI, A.: A quality-assurance oriented methodology for handling trade-offs in supplier selection, *International Journal of Physical Distribution and Logistics Management*, Vol. 30, pp. 96 -111, 2000.
- [4] CEBI, F., BAYRAKTAR, D.: An integrated approach for supplier selection, *Logistics Information Management*, Vol. 16, No. 6, pp. 395-400, 2003.
- [5] GHODSYPOUR, S. H., O'BRIEN, C.: The total cost of logistics in supplier selection, under conditions of multiple sourcing, multiple criteria and capacity constraint, *International Journal of Production Economics*, Vol. 73, No. 1, pp. 15-27, 2001.
- [6] Ho, W., Xu, X., Dey, P. K.: Multi-criteria decision making approaches for supplier evaluation and selection: A literature review, *European Journal of Operational Research*, Vol. 202, No. 1, pp. 16 -24, 2010.
- [7] KAR, A.K.: Revisiting the supplier selection problem: An integrated approach for group decision support, *Expert Systems with Applications*, Vol. 41(6), pp. 2762–2771, 2014.
- [8] NITSCHKE, J.: *Lean logistics – Optimization Supply Chain*, Available at: <<http://www.ingenics.com/en/supply-chain-management/lean-logistics.php>>.
- [9] RUDY, V., MALEGA, P., KOVÁČ, J.: *Production management*. Kosice, Technical university of Kosice, 2012.
- [10] SAEN, R. F.: Suppliers selection in the presence of both cardinal and ordinal data, *European Journal of Operational Research*, Vol. 183, No. 2, pp. 741-747, 2007.
- [11] STRAKA, Ľ.: *New Trends in Technology System Operation*. Proceedings of the 7th conference with international participation, Prešov, pp. 385, 2005.
- [12] Suppliers Quality Assurance Process Standardization Manual
- [13] ŠUTAJ-EŠTOK, A., LIBERKO, I., SIRKOVÁ, M.: *Process management in relation to the systems thinking*, In: Management 2012: research management and business in the light of practical needs. - Prešov : Bookman, p. 214-218, 2012.

Review process

Single-blind peer reviewed process by two reviewers.

CONCEPT OF SERVICE LOGISTICS

Tomáš Jurik

Jobelsa Slovensko, s.r.o., Rozvojová 2, 040 11, Košice, tomas.jurik2426@gmail.com

Keywords: services, logistics, industry, transport, indexes of level of the services

Abstract: The article deals with the design of service logistics, its definition, intersections and classification. It is meant to define the objects and subjects, which create the service logistics that would be used as a base for the subject, which is oriented to the particular area. The aim of the article is to set a complete and transparent source of information to formulate the areas of service logistics for the scientific-technical materials from the particular area. To meet the objectives, it is necessary to work the analysis of the theoretical knowledge in the area of services. The particular aim is to analyse the current state of the information-giving area, concerning the services and service logistics in general. This analysis will be transformed into the third particular aim, which is the synthesis of the service logistics itself and its defined content.

1 Introduction

Everyone meets with the services daily, whether actively or unconsciously. Buying, selling, setting a meeting, or a basic help with dealing with a certain situation. Everything among us is mutually connected according to the services. Logistic services are based on the same principle, however, from a different point of view. They record the relations between the provider and the user of the particular service, also from the point of view of the ownership and also the interpersonal relations, which occur during these services. Each part of the work focuses on the actual events in the particular area of the services. From the methods that are used, the main is the comparative analysis for the mutual comparison of the chosen educative institutions, that are in a certain way used within the schooling of the service logistics and their quality level. The article shows a complete overview about logistic services, their functionality, connection and the profit-delivery, not only for the public, but also in the business sector.

2 Service, its definition and basic features

According to Kotler, a service is an activity, which is offer by one side to the other side, while this activity is completely untouchable and does not create any material ownership. The word “service” comes from a latin word “servicum,” which basically represents the slavery. Within its distribution, there may to occur some problems, which are necessary to be realised, if the provider wants to be successful in the current competitive environment. These problems are based in the main features of the service. Therefore their solution is always slightly different from another, even by comparatively same situations [1].

For better understanding of the notion service, it is useful to define the features that divide a service from a product:

- Untouchability-incorporeality

Services cannot be tasted, smelled, seen or touched before their purchase. This character is often used to separate the services from the products, which you can clearly touch. The customer can lower the uncertainty of the service’s quality by searching for the evidence of its quality. If the customer wants to us accommodation services, he can firstly create an overview of the place where the service will be fulfilled. Usually, there are some propagation materials that will inform him about the prizes and information that relay to the service.

- Unstorability,

This feature is based in the previous one. That means that the customer only perceives the service in the moment of its provision. It is impossible to store empty hotel rooms or empty airplane seats in order to offer them during the season. This feature determines an exact harmony between the supplies and the demand.

- Inseparability,

A service is marked by the impossibility to be consumed elsewhere as it was produced. A product is produced on one place and used on the other. A product is made, sold and used. A service is sold on the first place then it can be provided and then used. Services have to be provided in one piece, it cannot be divided in time, it has to be used “now and here”. Both sides, the customer and the provider, affect the quality and point of view considering the particular service.

- Variability,

is a feature that is affected by a lot of co-factors (provider, customer, environment, ...), which take part within the service. Everyone sees the same service differently. For example, the supplying of the product in March and June seem to be the same things, but there are some significant differences, which follow the prize politics.

CONCEPT OF SERVICE LOGISTICS

Tomáš Jurik

- Complexity,

relates to a complex seeing of the product and assortment throughout the area of services. Therefore, it is possible to divide the services into basic and additional.

- Uniqueness,

is the aspect, which is closely linked to its variability. This feature affects all the requirements, in which the service is located. It represents the uniqueness from the point of view of the provider, but also the customer, according to time and place of provision [1].

2.1 Evaluating of the services

It is necessary to measure the services, in order to set their desired level (Figure 1). The evaluation consists of:

Availability of the products – percentage of the orders, which can be completed from the existing stock,

Percentage of the completed orders – per some time unit (week, month, year ...) is defined as the ration between the completed and imported orders (1).

$$X = \frac{\text{Number of completed orders}}{\text{Number of all the imported orders}} \times 100 \quad (1)$$

The disadvantage of this parameter is, that each item affects the profit differently.

The percentage of orders that are completed in time – this parameter reflects the fact, that each order can consist of several items (2).

$$Y = \frac{\text{Number of completed items within the order}}{\text{number of all the items within the order}} \times 100 \quad (2)$$

Ability to provide services – shows the time of completing of an order in days, the time from its importing, through its completing and delivery of the goods. A lot of customers prefer the meeting of the deadline to the short delivery times. With the security of the in-time delivery, there is no need for a large storage.

Order season without the shortage of the storages – time length, in which there was no deficit within any order.

Quality of the services – activities is before and after the transaction (availability of the spare parts, guidance ...) [2].

Besides the value of the services, it is necessary to evaluate their range. There are many parameters, usually in some physical units, which apply to a certain moment or time length:

- volume of the selling in the natural and financial units,
- number of orders,
- sales, profit,
- usage of the storages,

- incomplete orders.

The range and quality of the services have to respect the dynamics of the market throughout the existence of the product.

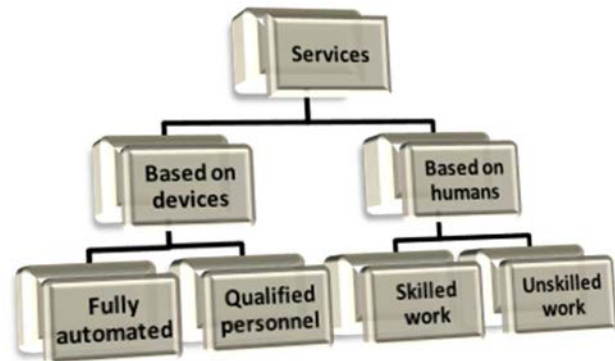

Figure 1 Classification of the services [3]

3 Service logistics conception

The creation of a systematic, transparent and understandable structure of the logistics (which applies the areas of services public and business) depends on several areas. The service logistics consists of different areas of services (Figure 2). The basic pillars include logistic services in:

- industry,
- banking and financial area,
- welfare services,
- telecommunications and post offices,
- army,
- culture,
- transport.

All the areas come from and are regulated by the legislation of the state and this work aims to show the flows and links in the individual sectors, their connection the logistics and also to understand their significance and importance.

At the first glance, it might seem, that logistics has nothing to do with the individual areas. Logistics is currently one of the youngest directions of philosophy, therefore it is understandable that it is constantly evolving. At first, it was only applied in the production connected to the automatization and direction of the flows within the factories. But it is necessary to realise, that logistics has been here from time immemorial. Mostly, the logistics is connected to automotive transport and logistics, but it is necessary to point out the important aspects of service logistics and its usage in the everyday life.

CONCEPT OF SERVICE LOGISTICS

Tomáš Jurik

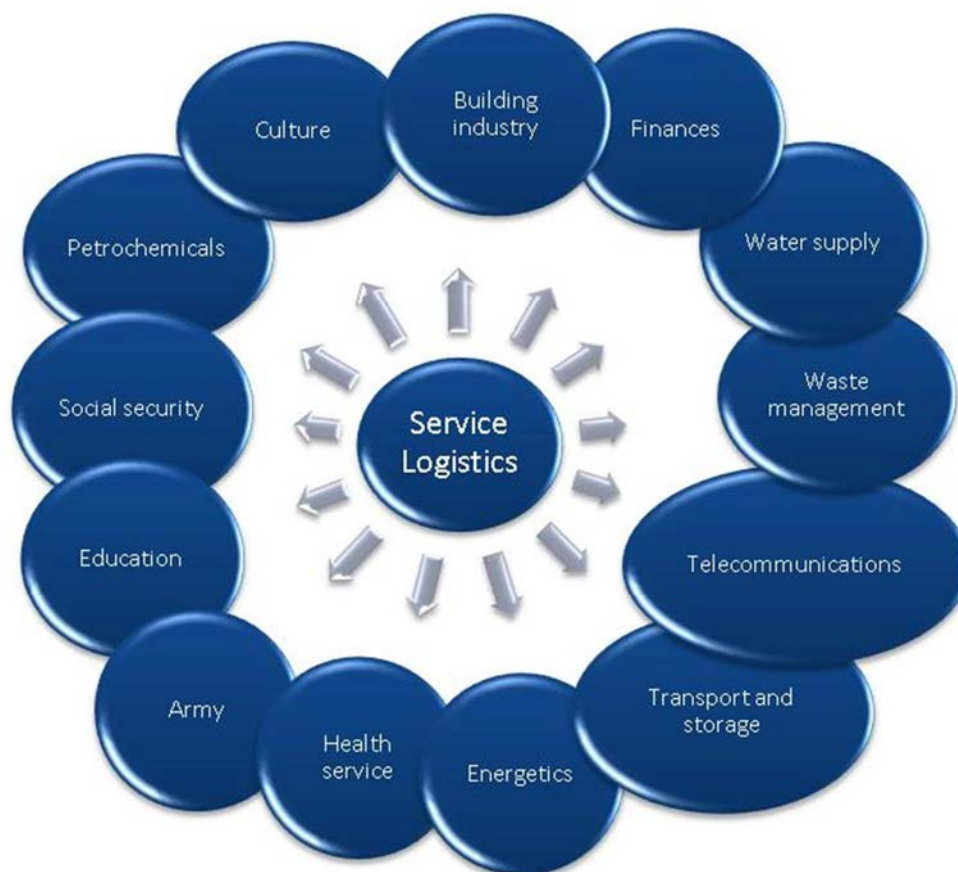

Figure 2 Areas of the service logistics

4 Definition of the notion within the service logistics

Logistics becomes the most evolving segment and offers an open space for innovation and continuous improvement of its processes, not only within the company, but also for the society and companies within the supply chain management. Currently, we divide several sub-categories of logistics and each of them is based on its own issues and its own solution of different problems and on its own search of optimal level of a certain situation. The most expanded part of the logistics is the industrial logistics, which takes the basic flows (material, informational and financial) into account and deals with the problems with various heuristic and systematic accesses with the aim to find the optimal solution for the particular problem, whether to minimize the costs or to maximize the profit.

The service logistics is less known and sometimes people do not realise that they are a part of some logistic flow in some area of services, which they use regularly or can also depend on. Within the logistics, there are defined the categories of logistics - Party Logistics. Every PL segment focuses on different activities within logistics. Service logistics is on the third level of Party Logistics (Figure 3) and fulfils various functions.

Within the service logistics, it is necessary to define and point out the difference between the service, service process and maintenance.

Service is an activity, which is offered by one side to the other, while this activity is completely untouchable and does not create any material ownership [1]. According to the point of view of the ownership, the user does not own the services. He pays for the certain service and in the moment of its provision, it is drawn out. If the customer demands the same service another time, he has to pay for it again.

The service process consists of the set of service processes, which are essential for the continuous and economic process [4]. It includes the activities that are made within the company in order to raise the effectiveness and productivity of the particular process.

Here belong:

- transport,
- storage,
- manipulation,
- supplying,
- technical preparation of the production.

CONCEPT OF SERVICE LOGISTICS

Tomáš Jurik

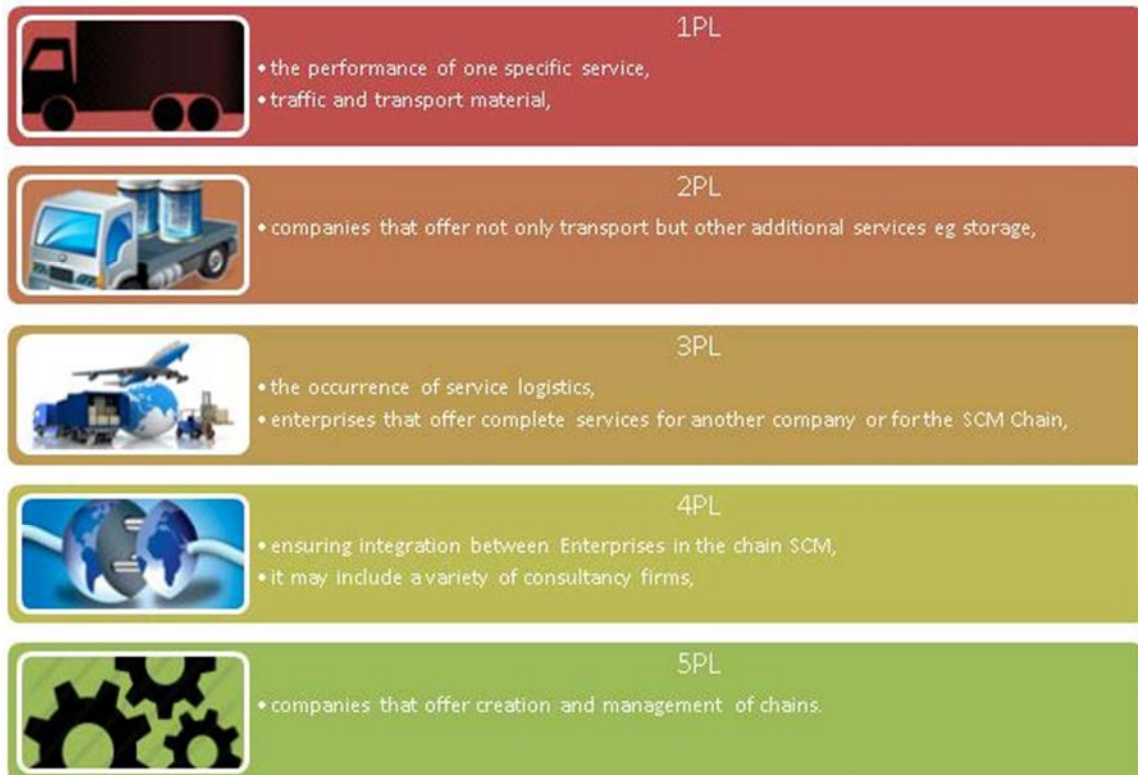

Figure 3 Division of the Party logistics into groups

Here we can see the difference between the service and the service process, where the service can be provided outside the company, the service process has to be done within the company.

Maintenance is the activity, which secures the working competence of the basic tools within the production [4]. It includes the activities, which eliminate the risks within the production and therefore minimize the losses.

Each of the three points has its set place within the productive and unproductive companies, which allows it to perform its activities. Not every service is a service process and similarly, not every service process is the maintenance. The individual areas of operation of the three groups (Figure 4) can be defined by some limits.

Outsourcing is the external purchase of services and also a strategy of saving of the costs, if it is used properly. It is more favourable to buy the outsourcing from another company than to secure it internally. The example can be shown on the cleaning service. The company can purchase he service from another company and it does not have to take care of it anymore. It would be a much more expensive investment, if the company had to secure everything by itself, from the payments to the internal employees, to the purchase of the detergents and tools.

Conclusions

Every activity whether it is logistic activity or not, can be categorized into the one of the areas. Individual

areas (Figure 4) also color coded and they characterize concrete category. An example of how individual area can be understood is also shown in each area. This may be a concrete company, which disposes with all areas, mostly large to multinational companies, or company that connects only few areas itself and that contacts another company, which is specializing in the given area, for realization of other areas, if it is necessary for the correct running of the company.

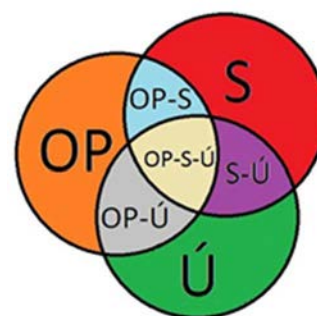

LEGEND:

- S – Service** **OP – Service Process** **Ú – Maintenance**
- OP – Ú => Service Process and Maintenance**
- S – Ú => Service and Maintenance**
- OP – S => Service Process and Service**
- OP – S – Ú => Service Process, Service and Maintenance**

Figure 4 Categories of logistical activities

CONCEPT OF SERVICE LOGISTICS

Tomáš Jurik

Based on the shown scheme there exists seven different areas in which it is possible to incorporate individual activities. As an example, we can include some of the service areas into the created groups and then it would look like this. It is also substantial to take into account that individual inclusion is taken in terms of ownership relationship.

Service – the service itself can include the area of the culture for citizens in the form of optional excursion. In this area only area of the service is included in this area because a guide performs a lecture on historical events and thereby also ends.

Service process – under the service process we can include smaller companies that largely carry out the activity and production of the products for bigger companies or network of chains.

Maintenance – for large and multinational companies it is frequent that they also dispose with more departments. Every department aims to fulfill its obligations and we can include maintenance right below these departments.

Service process and maintenance – internal employees whose duties consist in performing the tasks within the company and, if is necessary carry out the maintenance also outside the company. One of the examples might be employees of the transportation company of the concrete place.

Service and maintenance – in this category we can include a variety of companies whose business idea is designed to help others for example different maintenances and repairs of machinery and equipment. Today we often meet with advertisements where natural person offers its services in the field of maintenance of various household appliances, masonic and safety works.

Service process and service – here we can include number of advisory and consultancy companies or personal agencies. Within the services they offer advisory for its customers and also perform its own role within the company at the same time (management of applications, arranging meetings...).

Service process and service and maintenance - are special group of companies that we can include in the middle of the diagram. There includes e.g. companies operating in the field of IT and internet. Within the services they offer to their customer's internet access and other different complementary services such as telephone, set-top boxes and sale of supplementary products. All measures for the proper operation and functioning of the activities that are offered to their customers are carried out within the service processes. In case of failure, damage or replacing a component they also offer maintenance, where workers will come directly to the customer and carry out the required task.

References

- [1] BOGDANOVSKÁ, G., PAVLÍČKOVÁ, M.: Služby ako nehmotné produkty a problémy súvisiace s ich poskytovaním. Ostrava: VŠB, [Online], Available: <http://katedry.fmfi.vsb.cz/639/qmag/mj100-cz.pdf> [29 Sept. 2014], 2014. (Original in Slovak)
- [2] VANEČEK, D.: Logistika. Jihočeská univerzita, Ekonomická fakulta, p. 178, 2008. (Original in Czech)
- [3] HALÁSEK, D.: Logistika v odvětvích služeb. Přerov: p. 335, 2013. (Original in Czech)
- [4] SPIŠÁK, J.: Logistika obslužných procesov. Košice: TU-FBERG, p. 100, 2005. (Original in Slovak)

Review process

Single-blind peer reviewed process by two reviewers.