

Operational Integration in Health Care versus Mass Production

DOI: 10.12776/QIP.V20I1.658

Inger Gamme, Geir Berg

Received 10 January 2016, Revised 09 April 2016, Accepted 19 May 2016

ABSTRACT

Purpose: Operational integration has been studied by several authors. However, still there are many research questions to be raised.

Methodology/Approach: Two value chains have been studied within two different sectors: the health sector and the car component industry (mass producer). The research methodology is based on semi-structured interviews with selected persons from different levels within the organizations. The data was transcribed, coded and further analyzed to find enablers or disablers to operational integration in both sectors.

Findings: From this study, factors such as management commitment, co-location, and job-rotation can be seen as contributing factors in both organizations. Both experience disablers such as working as functional silos and little alignment of overall goals. Differences are seen in the greater use of job rotation within health care, while the mass producer had more mechanisms to facilitate working in cross functional teams.

Practical implication: This paper presents empirical findings of success factors and pitfalls for operational integration within the value chain of two different types of organizations. Based on this mapping, recommendations on how to achieve better operational integration will be presented.

Originality/Value of paper: The research initiative provides knowledge experiences from operational integration in two different Norwegian organizations representing two different sectors.

Category: Research paper

Keywords: collaboration; health care; integration; inter-functional; mass production

1 INTRODUCTION

Today there is a constant need for improvement in any professional organization, a need driven by increasingly demands for adjustments of products or services. Both internal and external factors contribute to the requirement of more flexible and adaptable value streams. Key criteria for success are inevitably connected to how the organization meets demands from its customers, i.e. its ability to adjust to future needs and control of the process of integration between complex organizations. The automobile and health sectors face different challenges; nevertheless, they both continually strive for an adaptable and efficient value chain, aiming at delivering the best quality of service or products.

This paper will illustrate practices from interdepartmental collaboration processes within a hospital and a mass producer (MP). It focuses on principles and methods used to create a smooth and efficient interface between actors, which pitfalls they may have experienced, and possible aspects of learning for these two different organizations. The following research questions will be addressed:

- What are the enablers or hindrances to operational integration in these two value chains?
- In what ways are there similarities or differences between these two sectors?

2 THEORY

2.1 Operational integration

Working towards an optimization of the value chain, many organizations focus on the optimization of each process step, while forgetting to secure and optimize the interfaces between steps (Figure 1).

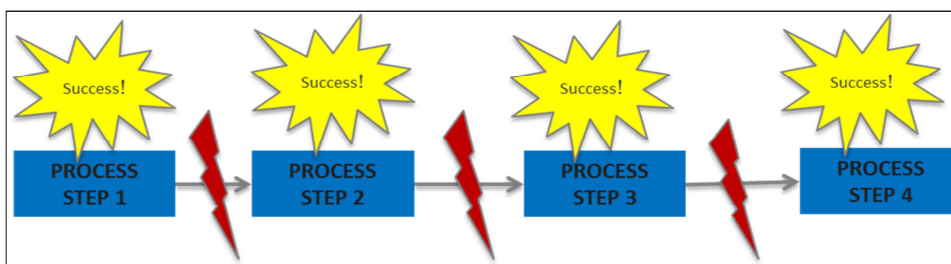

Figure 1 – Optimization of the value chain, requires focus on both process steps and interfaces

One challenge that commonly arises is the “handover of the baton” between two consecutive process steps. Factors such as a lack of documentation or systemization and the existence of functional silos or different cultures are

possible sources of difficulty (Pagell, 2004; Basnet and Wisner, 2012). Achieving a well-managed value chain presupposes that all value creating processes act together (Stank, Keller and Daugherty, 2001) and that intra-organizational customer demand and supply capabilities are aligned and balanced. A well-managed value chain means an integrated value chain that gives the customer optimized value (Stock, Greis and Kasarda, 1999; Morash and Clinton, 1998). This will positively affect an organization's efficiency-capabilities, seen as a quicker response to changes in the customer requirements (Chen, Daugherty and Landry, 2009). Poor integration between the process steps affects the organizational performance in a negative way (Shub and Stonebraker, 2009).

Interdepartmental relations have been studied for decades, but there are still many questions to be answered (Griffin and Hauser, 1996; Childerhouse and Towill, 2011; Barratt and Barratt, 2011; Basnet and Wisner, 2012; Hayes and Wheelwright, 1984; Turkulainen and Ketokivi, 2012). Different perceptions and terms to describe the relevant phenomena are observed between authors and between disciplines. Several authors refer to the topic of integration without presenting a formal definition (Pagell, 2004). Kahn (1996) presents the following definition of integration with the mix of two constructs: information sharing and involvement:

“A process of interdepartmental interaction and interdepartmental collaboration which brings departments together into a cohesive organization.”

Basnet and Wisner (2012) present another definition:

“Working together for the benefit of the company.”

It can be added that participants in a value chain should share the objective of achieving a collaborative supply chain and search for common initiatives to ensure that each participant benefits from the success (Simatupang and Sridharan, 2002).

2.2 Prerequisites for integration

Many authors agree that supply chain integration is valuable (Frohlich and Westbrook, 2001; Shub and Stonebraker, 2009; Pagell, 2004), but it has also been pointed out that it is not easy to achieve (Fawcett and Magnan, 2002; Bowersox, Closs and Stank, 1999; Childerhouse and Towill, 2011). In the existing research, considerable emphasis is placed on the question of why it is important to attain integration in the value chain, but few studies focus on how to achieve good integration (Basnet and Wisner, 2012; Pagell, 2004). Several contributing factors are described, such as facility and layout, job rotation, cross functional teams, amount of informal/formal communication, organizational culture, consensus on integration, and measurements and rewards (Pagell, 2004; Turkulainen, 2008; Bowersox, Closs and Stank, 1999; Basnet and Wisner, 2012).

Culture is one of the elements that affect integration. Despite the difficulty of changing a company's culture, practitioners should try to understand how the culture affects integration (Braunscheidel, Suresh and Boisnier, 2010). Job rotation may be used as a tool to change the culture and enhance integration (Basnet and Wisner, 2012; Pagell, 2004). Another important component to acknowledge is "tacit knowledge" – knowledge which is grounded in action, commitment, and involvement. Tacit knowledge has been characterized as having an individual quality such that it is difficult to communicate and describe (Nonaka, 1994).

Many authors emphasize that management support is an important mechanism to achieve integration (Wheelwright, 1992; Daugherty, Ellinger and Gustin, 1996; Nabavizadeh, Momeni and Saidi, 2013), though there is weak evidence for this claim (Basnet and Wisner, 2012; Morash and Clinton 1998). To achieve consensus on integration it is important that top managers focus on breaking down the organizational strategy into "subtasks" (Malone and Crowston, 1994), and that all the members of an organization have frequent communication about the goals and priorities for the value chain (Pagell, 2004).

To enable better connection between two different sections, it is useful to establish common arenas for information sharing, interaction and implement visual management tools such as team board meetings (Bititci, Cocca and Ates, 2015). But the success criterion most worthy of focus is improving the quality of interaction – not just increasing the quantity – with a concomitant focus on developing relational norms interdepartmentally (Ayers et al., 2001). Standardization facilitates coordination, which is a mechanism for enhancing integration. Use of standards gives the employees a prescription for how to act and coordinates the work (Mentzer, 2004).

Many authors refer to functional silos as disablers for integration (Van Hoek and Mitchell, 2006; Turkulainen and Ketokivi, 2012; Ellinger, Keller and Hansen, 2006; Braunscheidel, Suresh and Boisnier, 2010). Organizations with hierarchic and formal structure are characterized as having vertically driven communication and a functional myopia.

Finally, the use of different reward systems for different units of the organization could have a negative impact on integration, according to (Pagell, 2004; Galbraith, 2011).

2.3 Hospitals

Continuously overloaded and increasing queues are a common challenge for hospitals around the world. In many hospitals, the patient flow is unpredictable, resulting in inefficiency and disorganization (Hoot and Aronsky, 2008). Continuous delays may result in poor use of resources, reduced patient care, employee dissatisfaction and increased patient mortality (Derlet and Richards, 2000). Health care and hospitals all over the world have been organized in terms of health professions and specialist fields such as surgery, internal medicine etc.

The patient's problems are analysed individually. This is an impediment to seeing the "big picture" around the patient's needs and could contribute to problems with achieving "process flow", which again may be a reason for delays and crowded waiting rooms (Preston et al., 1999; Mainz, 1995; Mazzocato et al., 2012).

2.4 Mass Producers

There has been a shift in manufacturing paradigms towards supply chain integration (Muckstadt et al., 2001). Mass production is one of five production paradigms which have been utilized in recent years. In mass production, a large amount of the same product is produced (Jovane, Koren and Boër, 2003). As production volume increases, prices can be reduced and more customers may be able to buy the products. Organizations use technology to support the coordination of the employees' efforts relative to the organizational tasks and objectives. The more effectively the social and the technological systems work together, the better the organization performs (Netland et al., 2008).

For the automobile industry, common quality systems such as ISO/TS 16949:2002, which focuses on quality issues, process flow and lean solutions, have led to a more unified structure for the industry (Kymal, 2004).

2.5 Studying Hospitals versus Mass Production

Both hospitals and mass producers experience a demand for continuous improvements. Seim (2009) has studied similarities and differences between production companies and Operating Rooms. He claims that, among other factors, the operational challenges involve the need for quality improvements, cost reductions, maintenance or improvement in flexibility, secure customer focus and adaptability. These are similarities that make it possible to translate relevant operational management knowledge, principles and techniques between these industries. Porter (1985) claims that looking at work processes as a value chain makes it possible to consider work processes independently from environment and line of business. Even though these two industries are different from each other, they have some similarities. For instance, they both use principles and methods from total quality management (TQM). Useful comparisons can be made between these two sectors (Dahlgaard, Pettersen and Dahlgaard-Park, 2011).

3 METHODOLOGY/APPROACH

Two organizations were studied to find similarities or differences in enablers and disablers for integration. The organizations are quite different from each other with respect to their functions, responsibilities and societal roles. The mass producer, is located in Norway, but is part of a larger international company group. This organization produces high volumes of components for commercial

vehicles on four continents. The second organization is a middle-sized general hospital located in the south east of Norway. The hospital is part of a network hospital organization, in which each hospital has autonomy in some defined areas, such as professional and economic issues, but also follows decisions made by the network hospital board.

Both cases are independent research initiatives made available for a PhD study with the aim of studying enablers of or hindrances to operational integration in value chains. The Norwegian Research Council funded both projects.

A case study is useful to understand both complex social occurrences and organizations (Eisenhardt and Graebner, 2007). A research protocol with an interview guide was prepared in advance of both studies. Semi-structured interviews were conducted to identify the degree of integration for the value chains and enablers and disablers. The same questions were asked in both organizations, and interviews were allowed to proceed at their own pace. This made it possible for the interviewees to volunteer additional information. Understanding the interviewees' experiences and how they reflect on the topic is paramount and this kind of interview can be useful in uncovering these elements (Kvale, 1997). At both organizations, interviews were performed over a period of 6 months. Each interview lasted for approximately one hour. Important aspects to consider are whether there is relevance to the research questions, whether the phenomenon to be studied may occur and whether the research is feasible and ethical (Karlsson, 2009; Yin, 2009). All the interviews were digitally recorded, transcribed verbatim and coded according to the given categories for integration (Tjora, 2011).

Table 1 gives a listing of the essential case company characteristics.

Table 1 – Company characteristics

	Hospital	MP
Year of study	2013-2014	2012-2013
Main product/service	Patient flow for thrombolysis treatment	Car components commercial vehicles
Number of employees	265	37
Formal interviews	15	11
Part of value chain included	Ambulance, emergency department, X-ray, ICU, ward, internal medicine, neurology.	Injection molding, assembly
Type of informants	Nurses, radiographer, paramedic's radiographer, paramedics, attending physicians, clinical nurse, specialist nurses.	Operators, production manager, foreman, planner, tool responsible, quality technicians.

4 FINDINGS AND DISCUSSION

With focus on factors that affect integration in the value chain, the research of Pagell (2004), Basnet and Wisner (2012), Bowersox, Closs and Stank (1999) and Turkulainen (2008) has been used as a basis to categorize our findings. Factors from these researchers have been grouped to form the categories for our research (see first column of the Table 2).

Table 2 – Enablers and disablers for integration in the hospital and the MP; some may be both enablers and disablers

Main categories and explanation	Hospital (+) enablers, (–) disablers	MP (+) enablers, (–) disablers
Culture		
Values, understandings, ways of thinking Informal communication Connecting links Cross functional teams Job rotation	(+) Used to standardized work (+) Overall patient focus (–) Lacks focus on the whole value chain. (+/–) Competence acknowledgement makes information flow better. (+/–) Information flows better when people know each other (+/–) Tacit knowledge (+) Cross functional work in discussion of patients. (–) Job rotation: mostly used at the level of attending physicians	(+) Used to standardized work (–) Some lack of confidence in systems (–) Main focus own work station, minor overall value chain. (+/–) Prefers verbal communication more than written. (+/–) Informal culture (+/–) Foreman connects team boards, and responsible for both departments (–) Mainly cross functional teams at higher levels (–) Job rotation: no standard procedure
Vertical integration		
	(+/–) The culture is dependent on which persons and departments are involved	(+) Informal culture, little hierarchy (+) Department meetings each week, separate days per dept.
Formalization		
Policies, rules, certification Job descriptions Standard procedures, technical reports Charts, information process practices etc. Strategic planning, functional plans, scheduling Performance control Visual systems	(+) TQM, elements of Lean established recently (+) Procedures (+) Overlap meetings at change of shift, verbal communication, telephone, mail (+) Some have team board meetings, department meetings, training in acute situations (+/–) Knowledge of KPI's differs, some decomposed	(+) ISO/TS 16949, ISO 14001, lean (+) Standardized work descriptions (+) Shift log, mail, verbal communication etc. (+) Department meetings, team board meetings, shift overlap meetings (+/–) SAP, Excel sheets (+) KPI's established, some decomposed to functional measures

Main categories and explanation	Hospital (+) enablers, (–) disablers	MP (+) enablers, (–) disablers
	to functional measures (+) Some visual tools	(+) Kanban, visual logistics planning, visual tool status
Facility & Layout		
Plant size Physical distances Partitions	(–) Large organization, many process steps (–) Some physical distance between departments, and sometimes localized over two different floors or different buildings. (–) Functional silos	(+) Large plant, small value chain (+) Little physical distance. (+) Intimate environment. (–) Physical hindrances to verbal communication (–) Functional silos
Information systems		
Degree of formalization of information flows Enhanced capacity of information processing	(+) Several systems in use such as electronically patient journal DIPS, mail system etc. (–) Some lack of trust in systems	(+/–) Several systems in use, such as ERP, document handling system, mail system etc. (–) Some lack of trust in systems
Consensus integration		
Functional strategies must support the business strategy and each other. All functions support business strategy and each other, and all managers know this is going on.	Overall management focus on economy, while functional strategies focus on quality	Operators know department strategy, less of company strategy (+) Some measures derived from strategy, visual via team board. Operators' main focus: own work
Measurement, rewards		
	(+/–) Verbal acknowledgments	(+/–) Verbal acknowledgment per number improvement proposals

The findings presented under the categories in Table 2 are further discussed under each topic below.

4.1 Culture

In the hospital the personnel seemed to be more used to relating to systems and more faithful to structures than were the operators at the MP, and procedures were often referred to when interviewees were describing how they cooperate.

The physicians and the nurses had as a main focus the wellbeing of the patient and aimed at giving the best treatment throughout the patient flow. Still, several interviews indicated a strong functional focus, especially in certain departments.

Several of the informants referred to professional secrecy as a reason why they were not able to follow the information concerning the patient further down the value chain.

At the MP, the informants had little overall value chain focus, and each focused mainly on his or her own process step, to the point that sharing/receiving information beyond one's own process step was perceived as unnecessary. Some claimed, "I have too much to do with my own work".

Although the hospital has a large number of systems in place for information sharing, there are examples of tacit knowledge. For example, interviewees said it was impossible to predict the number of patients that come in during a day. However, several of them had clear opinions of specific fluctuations in the rates of patient arrival.

Cultures which inspire good communication are linked to integration (Pagell, 2004). In response to the question, "When is the information flow perceived to be good?" a specialist nurse at the hospital said: "I think the information flow is good when the person I am talking with acknowledges my competence, and I acknowledge the person's competence." Another interviewee perceived the information to flow better "when you know the people you are collaborating with."

Job rotation can contribute to improving the holistic understanding of the value chain and can be an effective tool to increase integration (Basnet and Wisner, 2012). Job rotation is used to varying degrees at the hospital, primarily by the attending physicians. According to one nurse: "It could have been an advantage to have the possibility to walk in each other's shoes, since we know very little about other departments' work, when we have never been in their place." Another informant said: "job rotation is instructive, but then again it is more that has to be learnt." At the MP there had occasionally been a rotation of workers between departments, and one of the operators perceived this as giving them better knowledge of the rest of the value chain.

4.2 Vertical integration

According to some of the hospital interviewees who had been working in or with more than one department, the culture and structure varied in the different departments. The fact that the departments had different managers could explain the different cultures. The researchers perceived the hierarchy as larger at the hospital than at the mass producer. However, according to some of the informants at the hospital, the hierarchy has been decreased during the recent years in most of the departments. Additionally, the management is often part of the value chain, meaning that some leaders participate in clinical work. The management influences the value chain in several ways, e.g. by their budget planning, strategic choices and direction of daily management.

The two departments at the MP were managed by the same foreman. Each department used a team board for the planning of the day's work, and the foreman was a participant in both meetings. By doing this, the foreman hoped to act as a connecting link for information flow between these two team boards and thereby achieve better integration. Nevertheless, these two departments had different cultures. Although the intention of being a part of both team meetings was to link the departments, it was perceived that the workers interacted with the foreman and not with the workers in the other department.

At both organizations it was observed that the management is actively a part of the value chain. According to Braunscheidel, Suresh and Boisnier (2010), a low degree of hierarchy positively contributes to integration, but to achieve this, management must commit and participate (Morash and Clinton, 1998; Basnet and Wisner, 2012).

4.3 Formalization

The MP has several standardized procedures to control processes, such as process descriptions, shift logs, shift overlap meetings, team board meetings, weekly team meetings and ERP systems. Each compartment has a team board and they also use visual systems on several occasions such as Kanban and tags for tool status. Despite all these systems, there are different perceptions of how information should flow among some of the workers.

The hospital has for several years used an electronic system called TQM. Routines and procedures related to patient treatment are developed over years, influenced partly by research, experience, legislation and professional trends. Important procedures are stored in an electronic system called EK. Over the past two years, the management has focused on increasing understanding of patient flows, through the start-up of a lean process.

Training for acute situations involves a very certain structure and a standard to be followed; there is a high degree of loyalty and discipline regarding systems and communication is very clear. This training demands a lot of resources in the hospital. In contrast, when the focus is on aspects that are important to the patient, such as waiting time and continuity of care where there is not an acute situation, the picture is quite different. Some informants state that, in less acute and life threatening situations, some choose to perform procedures in their own way.

Through study of these two organizations, it was found that both had a high degree of standardization, but the systems were designed differently. The MP used visualization systems, while the hospital used written procedures and training for acute situations. According to Mentzer (2004) this high degree of standardization could make a contribution to achieving integration, but it is recommended that it be complemented with informal interaction activities (Glouberman and Mintzberg, 2001).

4.4 Facility & Layout

In both organizations it was reported that the physical location of the departments affects their collaboration. At the MP there was an open connection between the departments, but also a minor wall. Despite this small partition, the two different departments functioned more or less as functional silos, with separate cultures and a lack of understanding of each other's daily challenges. At the hospital it might be more obvious that personnel experienced different cultures in their different parts of the value chain, since some departments were separated by as much as 8 floors.

Hayes and Wheelwright (1984) claim that a separation between subunits may reduce the degree of integration. By contrast, Pagell (2004) found little support for the idea that the size of the organization should affect the degree of integration, even though it was thought that this would be an obvious factor.

4.5 Information systems

The hospital had several different systems for information sharing. According to some informants too little time and “cumbersome system when dealing with difficult patients” made it difficult to document everything that should have been documented. Additionally, different departments used different systems, which did not always communicate with each other. For example, the X-ray department’s system could not receive electronic referrals. The physicians had to print referrals out and deliver them physically. It was noticed during the study that several of the informants often needed to use verbal communication in addition to the electronic system in special cases.

The operators at the MP used tools such as e-mail and registration of production data in an ERP system. However, according to some of the operators, approximately 90% of the communication was verbal. It was also observed that some of the operators double-checked the systems. For example, one informant said he often checked by telephone whether the emails he had sent had been received. An explanation of why operators had mistrust of the IT systems at the MP could be, as claimed by one of the informants: “The IT strategy does not correspond with the overall company strategy.” At higher levels in the organization there was more use of electronic information systems.

Gattiker (2007) and (Davenport, Harris and Cantrell, 2004) claim that information systems such as ERP systems contribute to integration. However, little support for this claim was found by Basnet and Wisner (2012).

4.6 Consensus integration

The employees at the hospital have an overall focus on the "customer", meaning the patient, and in some ways a focus on the overall patient flow. Despite this, some of the informants refer to an overall lack of thinking on the part of

management. In their view, the management does not understand the clinical problems and focuses too much on economic and rational issues.

The MP had broken some of the overall goals down to functional tasks at the production level and these were visualized on the team boards. The overall strategy, though, was not that clear to all employees.

At both organizations it was seen that the correspondence between the overall strategic goals and functional tasks could be better. This is also in accordance with what Van Hoek and Mitchell (2006) found. Through an internal survey within a large European manufacturing group, they discovered internal misunderstandings and differences in both opportunities and priorities within the organization. They proposed to focus on improving the internal communication and the initiative planning process to achieve better supply chain alignment.

4.7 Measurements rewards

Some informants from the hospital reported that the main focus of the management was on economy, while the overall focus in the value chain was on quality. However, the governmental measures focus primarily on economy, a factor that will also affect what the management focuses on. One of the informants said: "I think the top management has their main focus on quality, but I have never heard them talking of anything else than economy." Through the recent work a focus has been placed on common goals for the value chains, but this work had not yet reached the value chain studied in this case study.

Until recently, the management at the MP has used verbal acknowledgements in accordance with the number of improvement proposals as a reward to encourage further improvements. More recently, work has been done to try to find common motivating factors for the value chain.

Both value chains are aiming towards finding a common reward system and focus, but still they face some challenges. As claimed by Cao et al. (2008), when different departments tend to have different interests and focus, it is especially important to have good overall coordination, and having differences in focus and reward systems may affect the integration negatively (Pagell, 2004).

4.8 Summary of findings

A short summary of the similarities and differences of the findings is shown in Table 3.

Table 3 – Summary of the findings

	Similarities	Differences
Culture	<ul style="list-style-type: none"> • Used to standardized work • Tacit knowledge • Some lack of overall value chain focus • Job rotation perceived as positive 	<ul style="list-style-type: none"> • More true to systems at the hospital than in the MP.
Vertical Integration		<ul style="list-style-type: none"> • More hierarchy at the hospital than in the MP
Formalization and standardization	<ul style="list-style-type: none"> • High degree of formalization 	<ul style="list-style-type: none"> • Degree of use of visualization tools in MP • Training for acute situations at hospital
Facility & layout	<ul style="list-style-type: none"> • Layout challenge to integration 	
Information system	<ul style="list-style-type: none"> • Some mistrust of systems 	<ul style="list-style-type: none"> • More use of information systems at the hospital than in the MP
Consensus integration		<ul style="list-style-type: none"> • Insufficient connection between overall strategies and functional tasks
Measurement, rewards	<ul style="list-style-type: none"> • Verbal acknowledgment 	

5 CONCLUSION

Through two single case studies of two different organizations, the aim has been to provide a better understanding of enablers and hindrances to operational integration and the similarity or difference in these two types of value chains.

Despite the differences in the types of the two organizations, there were some findings of common enablers: both organizations had a high number of routines and standards and the employees were used to standardized work. Furthermore, in both organizations, job rotation was referred to as a contributing factor to increase integration and both companies used verbal acknowledgment as rewards.

The differences in enablers were found in the high degree of training at the hospital for acute situations, higher degree of use of visualization tools in the MP and more use of information tools directly in the value chain at the hospital.

The common disablers for integration were found to be related to culture and physical hindrances in location, tacit knowledge and difficulties in achieving good integration between overall strategies and functional tasks.

One difference in disablers was found in that the degree of hierarchy was higher at the hospital than in the MP.

The study has focused on creating new insight into enablers and disablers for operational integration in two different types of value chains. The experiences from this study could also contribute to providing operational guidance to similar types of organizations if they want to improve their operational integration.

It is of course difficult to generalize from just two case studies, but these studies could contribute to building theory on the topic. Further research should focus on achieving more information on the enablers and disabler for operational integration, by doing a study of more organizations.

REFERENCES

- Ayers, D.J., Gordon, G.L. and Schoenbachler, D.D., 2001. Integration And New Product Development Success: The Role Of Formal And Informal Controls. *Journal of applied business research*, 17(2), pp.133-148.
- Barratt, M. and Barratt, R., 2011. Exploring internal and external supply chain linkages: Evidence from the field. *Journal of Operations Management*, 29, pp.514-528.
- Basnet, C. & Wisner, J., 2012. Nurturing Internal Supply Chain Integration. *Operations and Supply Chain Management*, 5, pp.27-41.
- Bititci, U., Cocca, P. and Ates, A., 2015. Impact of visual performance management systems on the performance management practices of organisations. *International Journal of Production Research*, 54(6), pp.1-23.
- Bowersox, D.J., Closs, D.J. and Stank, T.P., 1999. *21st century logistics: making supply chain integration a reality*. Michigan State University, Council of Logistics Management.
- Braunscheidel, M. J., Suresh, N. C. and Boisnier, A. D. 2010. Investigating the impact of organizational culture on supply chain integration. *Human Resource Management*, 49(5), pp.883-911.
- Cao, N., Zhang, Z., To, K.M. and Ng, K.P., 2008. How are supply chains coordinated?: An empirical observation in textile-apparel businesses. *Journal of fashion marketing and management*, 12(3), pp.384-397.
- Chen, H., Daugherty, P.J. and Landry, T.D., 2009. Supply chain process integration: a theoretical framework. *Journal of Business Logistics*, 30(2), pp.27-46.
- Childerhouse, P. and Towill, D. R. 2011. Arcs of supply chain integration. *International Journal of Production Research*, 49(24), pp.7441-7468.
- Dahlgaard, J.J., Pettersen, J. and Dahlgaard-Park, S.M., 2011. Quality and lean health care: A system for assessing and improving the health of healthcare organisations. *Total Quality Management & Business Excellence*, 22(6), pp.673-689.

- Daugherty, P.J., Ellinger, A. E. and Gustin, C.M., 1996. Integrated logistics: achieving logistics performance improvements. *Supply Chain Management: An International Journal*, 1(3), pp.25-33.
- Davenport, T.H., Harris, J.G. and Cantrell, S., 2004. Enterprise systems and ongoing process change. *Business Process Management Journal*, 10(1), pp.16-26.
- Derlet, R. W. and Richards, J. R. 2000. Overcrowding in the nation's emergency departments: complex causes and disturbing effects. *Annals of emergency medicine*, 35(1), pp.63-68.
- Eisenhardt, K.M. and Graebner, M.E., 2007. Theory Building from Cases: Opportunities and Challenges. *The Academy of Management Journal*, 50(1), pp.25-32.
- Ellinger, A.E., Keller, S.B. and Hansen, J.D., 2006. Bridging the divide between logistics and marketing: facilitating collaborative behavior. *Journal of business logistics*, 27(2), pp.1-27.
- Fawcett, S.E. and Magnan, G.M., 2002. The rhetoric and reality of supply chain integration. *International Journal of Physical Distribution & Logistics Management*, 32(5), 339-361.
- Frohlich, M.T. and Westbrook, R., 2001. Arcs of integration: an international study of supply chain strategies. *Journal of Operations Management*, 19(2), pp.185-200.
- Galbraith, J. R., 2011. The star model. [pdf] Retrieved from <http://www.jaygalbraith.com/pdfs/Star Model.pdf>.
- Gattiker, T.F., 2007. Enterprise resource planning (ERP) systems and the manufacturing–marketing interface: an information-processing theory view. *International Journal of Production Research*, 45(13), pp.2895-2917.
- Glouberman, S. and Mintzberg, H., 2001. Managing the care of health and the cure of disease--Part II: Integration. *Health Care Management Review*, 26(1), pp.56-69.
- Griffin, A. and Hauser, J.R., 1996. Integrating R&D and marketing: a review and analysis of the literature. *Journal of product innovation management*, 13(3), pp.191-215.
- Hayes, R.H. and Wheelwright, S.C., 1984. *Restoring our competitive edge: competing through manufacturing*, New York, NY: John Wiley & Sons.
- Hoot, N.R. and Aronsky, D., 2008. Systematic review of emergency department crowding: causes, effects, and solutions. *Annals of emergency medicine*, 52(2), pp.126-136.e1.

- Jovane, F., Koren, Y. and Boër, C.R., 2003. Present and Future of Flexible Automation: Towards New Paradigms. *CIRP Annals - Manufacturing Technology*, 52(2), pp.543-560.
- Kahn, K.B., 1996. Interdepartmental integration: a definition with implications for product development performance. *Journal of product innovation management*, 13(2), pp.137-151.
- Karlsson, C., 2009. *Researching Operations Management*, Taylor & Francis.
- Kvale, S., 1997. *Det kvalitative forskningsintervju*. Oslo: Ad Notam Gyldendahl.
- Kymal, C., 2004. *The ISO/TS 16949 Implementation Guide: Gaining Value from Your ISO/TS 16949 Implementation*, Paton Professional.
- Mainz, J., 1995. *Problem identification and quality assessment in health care. Theory, methods, results*. København: Munksgaard.
- Malone, T.W. and Crowston, K., 1994. The interdisciplinary study of coordination. *ACM Computing Surveys*, 26(1), pp.87-119.
- Mazzocato, P., Holden, R.J., Brommels, M., Aronsson, H., Bäckman, U., Elg, M. and Thor, J., 2012. How does lean work in emergency care? A case study of a lean-inspired intervention at the Astrid Lindgren Children's hospital, Stockholm, Sweden. *BMC Health Services Research*, 12(28), pp.1-13.
- Mentzer, J.T., 2004. *Fundamentals of supply chain management: twelve drivers of competitive advantage*, Sage publications.
- Morash, E.A. and Clinton, S.R., 1998. Supply chain integration: customer value through collaborative closeness versus operational excellence. *Journal of Marketing Theory and Practice*, 6(4), pp.104-120.
- Muckstadt, J.A., Murray, D.H., Rappold, J.A. and Collins, D.E., 2001. Guidelines for Collaborative Supply Chain System Design and Operation. *Information Systems Frontiers*, 3(4), pp.427-427.
- Nabavizadeh, R., Momeni, M. and Saidi, S. S. 2013. The Impact of Aligned Rewards and Senior Manager Attitudes on Conflict and Collaboration between Sales and Marketing in JahanBehbood Pharmaceutical Co. *International Research Journal of Applied and Basic Sciences*, 5(6), pp.756-761.
- Netland, T.H., Knutstad, G., Buvik, M. and Skjelstad, L., 2008. The New Importance Of Socio-Technical Systems Research On High-Tech Production Systems. Paper submitted to HOPS, Lausanne, Switzerland.
- Nonaka, I., 1994. A dynamic theory of organizational knowledge creation. *Organization science*, 5(1), pp.14-37.
- Pagell, M., 2004. Understanding the factors that enable and inhibit the integration of operations, purchasing and logistics. *Journal of Operations Management*, 22(5), pp.459-487.

- Porter, M.E., 1985. *Competitive advantage: creating and sustaining superior performance*. New York: Free Press.
- Preston, C., Cheater, F., Baker, R. and Hearnshaw, H., 1999. Left in limbo: patients' views on care across the primary/secondary interface. *Quality in Health Care*, 8(1), pp.16-21.
- Seim, A.R., 2009. *Process Analysis and Monitoring in Complex Perioperative Environments: Health Operations Management*. Ph. D. Norwegian University of Science and Technology.
- Shub, A.N. and Stonebraker, P.W., 2009. The human impact on supply chains: evaluating the importance of “soft” areas on integration and performance. *Supply Chain Management: An International Journal*, 14(1), pp.31-40.
- Simatupang, T.M. and Sridharan, R., 2002. The collaborative supply chain. *The International Journal of Logistics Management*, 13(1), pp.15-30.
- Stank, T.P., Keller, S.B. and Daugherty, P.J., 2001. Supply chain collaboration and logistical service performance. *Journal of Business Logistics*, 22(1), pp.29-48.
- Stock, G.N., Greis, N.P. and Kasarda, J.D., 1999. Logistics, strategy and structure: a conceptual framework. *International Journal of Physical Distribution & Logistics Management*, 29(4), pp.224-239.
- Tjora, A. 2011. *Kvalitative forskningsmetoder i praksis*. Gyldendal Akademisk.
- Turkulainen, V., 2008. *Managing cross-functional interdependencies-the contingent value of integration*. Ph. D., Teknillinen korkeakoulu.
- Turkulainen, V. and Ketokivi, M., 2012. Cross-functional integration and performance: what are the real benefits? *International Journal of Operations & Production Management*, 32(4), pp.447-467.
- Van Hoek, R.I. and Mitchell, A., 2006. The challenge of internal misalignment. *International Journal of Logistics*, 9(3), pp.269-281.
- Wheelwright, S.C., 1992. *Revolutionizing product development: quantum leaps in speed, efficiency, and quality*. Simon and Schuster.
- Yin, R.K., 2009. *Case Study Research, Design and Methods*. Sage Publications Inc.

ABOUT THE AUTHORS

Inger Gamme, Ph.D. Candidate, Gjøvik University College/ NTNU, inger.gamme@hig.no, Teknologiveien 22, 2815 Gjøvik, Norway

Geir Berg, Dr. Public Health, MNSc, RN , Innlandet Hospital Trust Lillehammer, geir.berg@sykehuset-innlandet.no, Postboks 104, 2381 Brumunddal, Norway

Traceability System as Perceived-Uncertainty Mitigator for Sustainable Global Food Trade

DOI: 10.12776/QIP.V20I1.625

Renee B. Kim, Qiao Zhang, Dong Hyun Yoon

Received: 2015-10-19, Revised 10 April 2016, Accepted 27 May 2016

ABSTRACT

Purpose: The paper validates a model which approximates a relationship between perceived uncertainty of consumers and two antecedents & three mitigators which explain the value of Food Traceability System (FTS).

Methodology/Approach: The proposed model was drawn from Pavlou et al. (2007) study which applied the principal-agent perspectives, and this study contributes to current literature by improving understanding of structure of perceived uncertainty of a food product with credence good with this model.

Findings: The study assesses the value and effects of FTS in reducing perceived uncertainty of beef from various origins and suggests important implications for stakeholders in beef sector regarding feasibility and marketability of FTS.

Research Limitation/implication: Findings evidently reflect the current market circumstance regarding consumers' concerns and *Perceived Uncertainty* towards import food products for their credence nature. Different aspects of FTS were found to have mediating role in reducing *Perceived Uncertainty* in China and South Korea.

Originality/Value of paper: The study assesses the value and effects of FTS in reducing perceived uncertainty of beef from various origins and suggests important implications for stakeholders in beef sector regarding feasibility and marketability of FTS.

Category: Research paper

Keywords: Perceived Uncertainty; Food Traceability System (FTS); consumer behavior; Sustainable Global Food Trade

1 INTRODUCTION

Various types of food scares associated with food safety impact consumers' attitude towards food choices and consumption substantially, and consumer concern for food safety appear at the forefront of competitiveness of the agri-food industry. Consumers' demand for adequate information on quality and safety of food products are increasing as they prefer to make an informed choice. Nonetheless, inherently sellers have more information on the quality and safety of products and consumers often have limited access to product information which leads to increased perceived risk. In particular, food safety is credence good which consumers are unable to assess without seller's assistance or additional information.

Furthermore, increase in agri-food trade due to rise in free trade agreement (FTA) among nations, brought broader availability of foreign food products in consumers' choice set, and consumers are faced with heightened uncertainty in the origin and safety of import food products. Consequently, country of origin has become one of the key attributes which are used by consumers in purchasing imported products. Country of origin effects refers to the extent to which a product's evaluation is affected by its place of manufacture (Gurhan-Candli and Maheswaran 2000). Country of origin is considered to be an attribute with significant impact on consumers' choice behavior of foreign products and various studies reported on this finding (Nagashima, 1970; Hong and Wyer, 1989; Maheswaran 1994; Häubl 1996; Aboulnasr, 2006). Consumers' evaluation of products is often based on country of origin stereotypes, thus the way consumers acquire, process and use the country of origin information may also have important effect on consumers' choice behavior.

In order to facilitate food transactions in the supply chain, and to reduce consumers' perceived risk in food choice, countries recently introduce Food Traceability System (FTS) which trace all relevant information on food process from farm to end-user point, including country of origin information. When consumers can recognize the country origin of a product with an aid of FTS, they can make informed diagnosis of the quality & safety of the products. Food Traceability System (FTS) which function as a vehicle to provide more information on the product quality and safety to consumers may facilitate them to evaluate product quality based on information from FTS instead of their prior biases or expectation of products. The more diagnostic an attribute, the more helpful this attribute is for consumers in evaluating the quality and performance of a product (Jiang and Benbasat, 2004). In other words, more diagnostic information is more likely to be used as an input for evaluative judgment than information that is ambiguous or non-diagnostic (Garretson and Burton, 2000; Aboulnasr, 2006). Thus, consumers appear to rely more on the information rather than their prior expectation when they are presented with unambiguous quality information (Jiang and Benbasat 2004; Garreston and Burton, 2000; Kempf and Smith, 1998; Aaker, 2000). Furthermore, this facilitates food transaction in the market by reducing consumers' perceived uncertainty of product quality and

safety. Ultimately improved efficiency in the market transaction may be reflected in consumers' willingness to pay price premium for certain country origin and to purchase larger quality.

2 TRACEABILITY SYSTEM IN CHINA AND SOUTH KOREA

Among several types of food products, beef is chosen as this is an item which has been drawing international attention regarding food safety, free trade agreement (FTA) talks as well as local producers and consumers' reluctance in accepting import beef. Several outbreaks of Bovine spongiform encephalopathy (BSE) in various countries in the past have increased consumers' concerns and perceived risk of food safety of beef, causing significant negative impact on beef products from specific country of origin. Food safety is a credence attribute (i.e. consumers cannot assess the food safety level even after they consume), thus consumers tend to rely on other intrinsic and extrinsic cues (i.e. country origin) to infer food safety. As a consequent, the beef industry has introduced a Food Traceability System (FTS) and strengthened vertical coordination in the food supply chain to enhance food safety. FTS is an extrinsic cue which certifies the quality and safety of beef products by transforming food safety from credence attribute to a search attribute.

FTS has been adopted by many advanced economies such as Japan, France, Australia and the U.S. Japan initiated its beef traceability system in 1999 and set up a database management system in 2002 and completed implementation of beef traceability system in 2003 at production level, and in 2004 expanded the FTS to distribution level. The U.S. introduced a plan for traceability system in 2002 and developed database management system in 2004 and completed the farm & cattle registration in 2008. We selected China and South Korea as target markets for beef transactions at consumer level to empirically test the impact of FTS, and to assess the effect of antecedents on consumer's perceived uncertainty and purchase intension. These two markets are chosen since these are two major beef trading countries in Asia and beef products from different country of origin prevalently exist in their consumer markets. Upon the outbreak of Canada's first BSE-infected cow in Alberta in May 2003, which was transferred to the U.S., several beef import countries in Asia banned U.S. beef and cattle products, including China, South Korea, Taiwan, Hong Kong etc. This had tremendous negative impact on beef export countries such as the U.S. and Canada, resulting in substantial gross farm income loss in these countries (i.e. 20% of gross farm income in the U.S declined due to this ban).

Upon the completion of U.S-Korea FTA in 2008, South Korean beef market officially open access to U.S. beef in 2008, nonetheless the Korean consumers were considerably concerned with food safety of U.S. beef. In order to strengthen food risk management and respond to consumers concern, the Korean government operated pilot test of BSE in 2004, and officially activated FTS on beef sector in 2007. The FTS on beef production level started in 2008 and the

FTS on distribution level started in 2009. Since 2010, the public trust of Korean beef safety and quality increased significantly, and Korean beef market share increased from 43.2% in 2010 to 50.3% in 2013. Currently, there are five types of beef, differentiated by country of origin, including Korea, the U.S., Australia, Canada and New Zealand. Korean consumers' preference for import beef still remains to be considerably lower than that of domestic beef due to perceived uncertainty regarding food safety.

On the other hand, China continues to increase its beef imports in recent years and food safety and quality of import beef has become an important issue. China is the world's largest meat consuming country and its beef import is forecasted to double by 2018 as domestic output fails to meet demand. Chinese per capita beef consumption is 4.5kg in 2013 (weights on a carcass-weight basis), which is expected to grow to 6 kg by 2020, getting close to the world average of 8.1kg. Various food scare outbreaks in China heightened consumer concerns for food safety and it is one of the most contending current social issues in China. Due to cope with this challenge, the Chinese government and the industry are in discussion to implement FTS. In China's private sector, HACCP, GAP and other international safety certification standards are increasingly adopted by the private firms on a voluntary basis, while Quality Safety (QS) is the only officially implemented safety certification on a mandatory basis. By 2005, 2,846 food companies in China have implemented HACCP certification (Wang et al., 2006), and the number of food processing firms in China continues to increase and officially registered companies were estimated to be 19,022 in 2003, thus the proportion of Chinese food companies with HACCP certification remains relatively low. This may primarily be due to the fact that introduction of HACCP based systems may be difficult in small and medium sized food businesses with limited capacity and knowledge (Kim et al., n.d.).

In addition, China decided to apply GS1's GTS in order to facilitate its trade with European and other major trading partner countries. As a pilot project, one of Chinese private food manufacturing firm-Synbroad Ltd. adopted GTS by GS1 China, and successfully maintained market position in Europe. With this application of traceability system, Synbroad Ltd. gained the following competitive advantages: compliance with the international traceability standards; automation of all operational traceability process in the companies; strengthening Synbroad competitive compliancy with the European Food Law (GS1, 2009). However, GS1 China also faces with considerable challenges; training and learning on GS1 standards by relevant stakeholders; identifying equipment to support the data flow exchanged; and allocation/assignment of specific tasks involved in the GTS process. For successful adoption of such system, GS1 China identified critical success factors such as sufficient funding supports, high level sponsorship and leadership from both company management and government and effective communication of all relevant actors in the system (Kim et al., 2015). This implies that ultimately the system has been to recognized and supported by the end-users (i.e. Consumers) in order to justify associated costs

and investments. Therefore, it is imperative to conduct a comprehensive study on whether the FTS is perceived to be valuable in the eyes of consumers. From exporters and marketers perspectives, findings provide worthwhile guideline in determining feasibility of Food Traceability System (FTS) in their food supply chains.

The purpose of this paper is to determine whether Food Traceability System (FTS) affect consumers' choice behavior of beef products from various country of origin. More specifically, the study attempt to verify the positive effects of FTS on consumers' purchase decision of beef products by mitigating the perceived uncertainty of consumers towards beef products from various countries. This study adopts Pavlou, Liang and Xue (2007) model which approximate the relationship between perceived uncertainty and purchase intention of consumers. In addition, findings from this study provide practical implications for stakeholders in beef supply chain, regarding return on investments of FTS in beef sector and value-adding potentials of FTS. In other words, the proposed model attempts to examine whether consumers from China and South Korea perceive FTS to an additional value in their purchasing decision process.

3 CONCEPTUAL FRAMEWORK

Choe et al. (2009) state that the perceived risk of consumers stems from uncertainty due to lack of declarative knowledge, or insufficient knowledge of the outcome of the consumption act. Perceived uncertainty refers to the degree by which the outcome of a transaction cannot be accurately predicted, the future sales of the transaction could vary from a successful product fulfillment to any combination of the numerous adverse possibilities (Pavlou, Liang and Xue, 2007). Individual consumers inherently have limited access to the quality and safety of products, and are faced with numerous adverse possibilities, they tend to overestimate the probability of potential losses, even if the probabilities of such losses is low (Kahneman and Tversky, 1979). Uncertainty perceptions give rise to perception of risk (Chiles and McMackin, 1996). In other words, the perceived uncertainty of product quality and safety is the sole source of perceived risk of consumers. Based on this assumption, we propose that FTS decrease perceived uncertainty by providing sufficient information on product quality, and ultimately have positive effect on consumers' choice behavior.

Pavlou, Liang and Xue (2007) apply the principal-agent perspective in developing their conceptual framework for consumers' choice behavior in an e-commerce adoption setting. Their model explicitly addresses the source of uncertainty with this approach. The principal-agent perspective virtually applies to all transactional exchanges that occur in a socio-economic system of opportunism, asymmetric information, and bounded rationality (Milgrom and Roberts, 1992). Since food transaction situation involves high degree of

uncertainty, this framework is considered to be appropriate to approximate consumers' food choice behavior.

Antecedents of Perceived Uncertainty: Information Asymmetry & Fear of Seller Opportunism

The principal-agent perspective addresses an agent relationship in which one entity (the principal) delegates work to another (the agent) who performs the work according to a mutually agreed contract (Esenhardt, 1989). Agency relationships are instituted whenever one party depends on another party to undertake some action on its behalf (Jensen and Meckling, 1976). Due to asymmetric information provided to the principal and the agent, it naturally raises an issue of agency problems of hidden information and hidden action (i.e. misrepresentation of seller quality and of product quality). Thus, hidden information poses difficulty to the buyer in terms of selecting a true high quality seller and products.

Pavlou, Liang and Xue (2007) identify perceived information asymmetry and fears of seller opportunism as main sources of perceived uncertainty. Perceived information asymmetry exists as buyers perceive sellers to have a greater quantity or quality of information than they do. Information asymmetry makes it difficult for buyers to assess the sellers' true characteristics and product quality, resulting in higher perceived uncertainty. In addition, buyers may assume hidden action of sellers as they act opportunistically to serve their self-interest given difference of interests (Pavlou, Liang and Xue, 2007). An example of seller opportunism includes quality cheating, masquerading true identity, contract default, or not acknowledging product warranties (Mishra, Heide and Cort, 1998). These types of hidden action increase perceived uncertainty of buyers. The two identified antecedents are hypothesized to have a positive effect on consumers' perceived uncertainty of products within the framework of the principal-agent perspective, thus the agency problem of hidden information and hidden action are claimed to be mitigated through change in buyers' beliefs (i.e. trust, informativeness and product diagnosticity).

Uncertainty Mitigators: Product Diagnosticity, Informativeness & Trust

Product diagnosticity refers to the ability to convey relevant product information to help buyers accurately evaluate product quality (Pavlou and Fygenson, 2006). FTS may enable sellers to convey information about the true quality of their product, enabling consumers to assess product quality and safety adequately. Increased perceived diagnosticity allows consumers to feel more informed about products, which leads to informed purchased decisions (Jiang and Benbasat, 2004). As a result, product diagnosticity mitigates a buyers' perceived information asymmetry. Informativeness in the FTS is defined as the extent to which the information provided to consumers is actually helpful (Choe et al.

2009). Since there can be various types of information which can be provided, seller needs to decide information which are cost-efficient and relevant to consumers' concern and interest. Informativeness address the importance of the quality and relativity of information provided to consumers. When consumers believe that they are provided with helpful and reliable information, their perceived information asymmetry and fear of seller opportunism are likely to be reduced. Trust is a psychological state that is most valuable under-conditions of uncertainty (Mayer, Davis and Schoorman, 1995), and the intention of the buyer to accept the vulnerability of transaction, believing that the seller will not act opportunistically (Pavlou and Gefen, 2004; Rousseau et al., 1998). Thus, trust mitigate fears of seller opportunism and information asymmetry, as buyers carry on their transaction based on their trust for seller's competence, integrity, facilitating buyer-seller relationships (Swan and Nolan, 1985).

Figures (1-4) show the overall model of FTS impact on consumers' choice behavior and the path relationship of selected constructs. Purchase intention is set as the dependent variable, reflecting consumers' acceptance of FTS. Perceived information asymmetry and fears of seller opportunism are selected two antecedents, affecting perceived uncertainty of consumers which ultimately result in their purchase intention. Three mitigators: product diagnosticity, informativeness and trust are proposed to reduce the impact of two antecedents with an assistance of FTS (Table 1).

Table 1 – Definition of Constructs

Constructs	Definition
Product Diagnosticity	The extent to which a buyer believes that a particular shopping experience is helpful in terms of evaluating the quality and performance of a product (Kempf and Smith 1998)
Informativeness	The extent to which seller provides users with resourceful and helpful information (Ducoffe, 1995)
Trust	Intention of the buyer to accept the vulnerability of the transaction, believing that the seller will not act opportunistically (Pavlou and Gefen, 2004)
Information Asymmetry	The difference between the information that buyers and sellers possess.
Fears of Seller Opportunism	The buyer's concerns that the seller may act opportunistically (Pavlou and Fygenson, 2006)
Perceived Uncertainty	The degree to which the outcome of a transaction cannot be accurately predicted, (Pavlou and Fygenson, 2006)

4 RESEARCH METHOD: CROSS-COUNTRY VALIDATION OF FOUR PROPOSED MODELS

Survey Sampling & Data Analysis

The survey questionnaire was designed and developed based on measures which were defined in Pavlou, Liang and Xue (2007) study and the items of the survey questionnaire are listed in Table 1. All items were measured with five-point Likert-type scales.

The structural model has three constructs which were defined as uncertainty mitigators: Product Diagnosticity, Informativeness & Trust; two constructs, identified as uncertainty sources: Perceived Information Asymmetry & Fears of Seller Opportunism; and one construct as a dependent variable, Purchase Intention. In total, 26 items were measured to assess the proposed model (Table 2).

Table 2 – Measurement Items for the Structural Model

Constructs	Item No.	# of Items	Measurement Items
Product Diagnosticity	Item 1	3	I expect the traceability system to help me carefully evaluate beef products. Being able to carefully evaluate beef products would make it much easier for me to purchase beef products. I expect the traceability system to help me get a real feel for beef products.
	Item 2		
	Item 3		
Informativeness	Item 4	2	A traceability system would give me quick and easy access to large volumes of information. I would learn a lot from using a traceability system.
	Item 5		
Trust	Item 6	3	The traceability system provides objective information on beef products sufficiently. Information provided by the traceability system is trustworthy. I expect the traceability system to provide accurate information trustfully.
	Item 7		
	Item 8		
Perceived Information Asymmetry	Item 9	2	The traceability system reduces the information gap on the “quality of beef products” between the producers and the consumers. The traceability system reduces the information gap on the “circulation process of beef products” between the producers and the consumers.
	Item 10		
Fears of Seller Opportunism	Item 11	3	The producers of beef products who sell through the traceability system will not cheat on consumers. The sellers of beef products who sell through the traceability system will not counterfeit the period of circulation The traceability system will reduce the possibility of illegal production.
	Item 12		
	Item 13		

Constructs	Item No.	# of Items	Measurement Items
Perceived Uncertainty (Domestic & Imported)	Item 14	4	Purchasing domestic beef products through the traceability system will decrease the degree of uncertainty associated with the products. Purchasing imported beef products through the traceability system will decrease the degree of uncertainty associated with the products. Purchasing domestic beef products through the traceability system will decrease the degree of uncertainty that occurs as a post-purchasing reaction. Purchasing imported beef products through the traceability system will decrease the degree of uncertainty that occurs as a post-purchasing reaction.
	Item 15		
	Item 16		
	Item 17		
Purchase intention (Domestic & Imported)	Item 18	9	I plan to continue purchasing domestic beef products using the traceability system I plan to continue purchasing imported beef products using the traceability system I intend to increase the size of domestic beef products purchases using the traceability system. I intend to increase the size of imported beef products purchases using the traceability system. I intend to increase the frequency of purchasing domestic beef products using the traceability system. I intend to increase the frequency of purchasing imported beef products using the traceability system. How much more are you willing to pay for domestic beef products through traceability systems? How much more are you willing to pay for imported beef products through traceability systems? Please select which country's beef products do you prefer? (China, USA, Australia, Canada, New Zealand)
	Item 19		
	Item 20		
	Item 21		
	Item 22		
	Item 23		
	Item 24		
	Item 25		
	Item 26		

Local Marketing Agencies in South Korea and China administered data collection of the survey. The proposed model was empirically tested with survey data from 350 Chinese Consumers and 305 Korean consumers. Chinese survey was done in two major cities in China (i.e. Beijing and Shanghai), while Korean survey was done in various cities in South Korea (Table 3 & 4). The sample in China was 76.6% male and 23.4% female; 93% of respondents were younger than 40; respondents tend to have high education level; 43.8% of respondents were students, 50% of respondents had professional occupations. 43% of Chinese respondents earn monthly income less than 3000 RMB, 42% of them earn between 3000-10,000 RMB per month. The sample in South Korea was 63.5% male and 36.5% female; 41.8% of them are between 30-39 years old, 26.2% are

in 20s and 26.7% are in 40s; 58.7% of the respondents had college education; 30.2% of the respondents make 30.2 Million KW (MKW) per year, 26.2% make 20-30 MKW. Structural equation modeling was used to analyze the collected data with AMOS 18.0.

Table 3 – Demographic Profile of Chinese Respondents

Variable	Section	No. of Frequency	Valid Percent (%)	Total
Gender	Male	229	76.6	299
	Female	70	23.4	
Age	Under 20 years old	4	1.3	
	20~30 years old	210	70.2	
	30~40 years old	69	23.1	
	40~50 years old	12	4.0	
	50 years of age or older	4	1.3	
Education	College Student/Graduated	2	7.0	
	University Student	26	8.7	
	Bachelor's Degree	60	20.1	
	Master Degree/A higher Degree	211	70.6	
Job	Student	131	43.8	
	Normal/Government Employee	85	28.4	
	Specialized Job (Medical Doctor, Lawyer, Teacher or others)	66	22.1	
	Freelancers(Merchant)	6	2.0	
	Others	11	3.7	
Income (month)	<3,000 (RMB)	129	43.1	
	3,000~5,000(RMB)	64	21.4	
	5,000~10,000(RMB)	63	21.1	
	10,000~20,000(RMB)	33	11.0	
	>20,000(RMB)	10	3.3	

Table 4 – Demographic Profile of Korean Respondents

Variable	Section	No. of Frequency	Valid Percent (%)	Total
Gender	Male	143	63.5	225
	Female	82	36.5	
Age	20~29 years old	59	26.2	
	30~39 years old	94	41.8	
	40~49 years old	60	26.7	
	50 years of age or older	12	5.3	
Education	High school graduate	40	17.8	
	College student	43	19.1	
	Bachelor's Degree	132	58.7	
	Master Degree or higher	10	4.4	
Income (million won/year)	<20 (KRW)	68	30.2	
	20~30(KRW)	59	26.2	
	30~40(KRW)	40	17.8	
	40~50(KRW)	24	10.7	
	>50(KRW)	34	15.1	

Development of Four Models

Figures (1-4) are the proposed models which are estimated with survey data to determine the antecedents explaining perceived uncertainty of consumers for beef safety and consumers' purchase intention of beef from various country origins. Empirical data analysis enable discovery of three aspects: two antecedents of perceived uncertainty of consumers for beef; the effects of FTS (through three factors) on the identified antecedents; the impact of FTS on consumers' purchase intention of beef products,

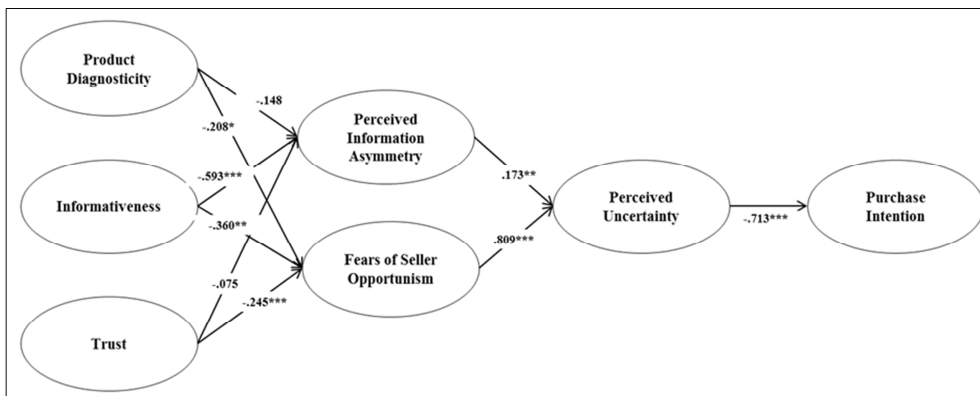

Figure 1 – The China Domestic Model: Effect of FTS on Perceived Uncertainty & Purchase Intention

In order to determine the differentiated effects of FTS on consumers’ beef purchase intention from domestic vs. import origin, separate models were developed for consumers’ purchase intention for domestic beef vs. import beef. Due to Chinese and Korean consumers’ negative reaction to recent BSE outbreaks in major beef exporting countries, it is important to assess how they value the FTS differently on domestic and import beef purchase situations. Consequently, four separate models were developed for China and South Korea: the China Domestic Model, the China Import Model, the Korea Domestic Model; and the Korea Import Model.

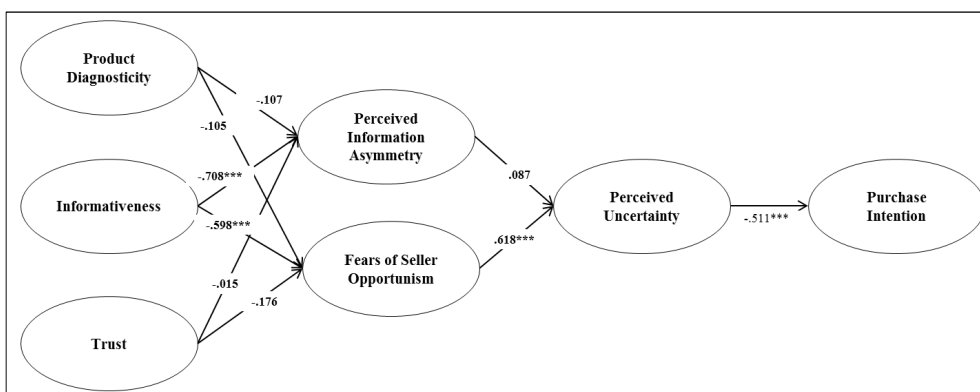

Figure 2 – The China Import Model: Effect of FTS on Perceived Uncertainty & Purchase Intention

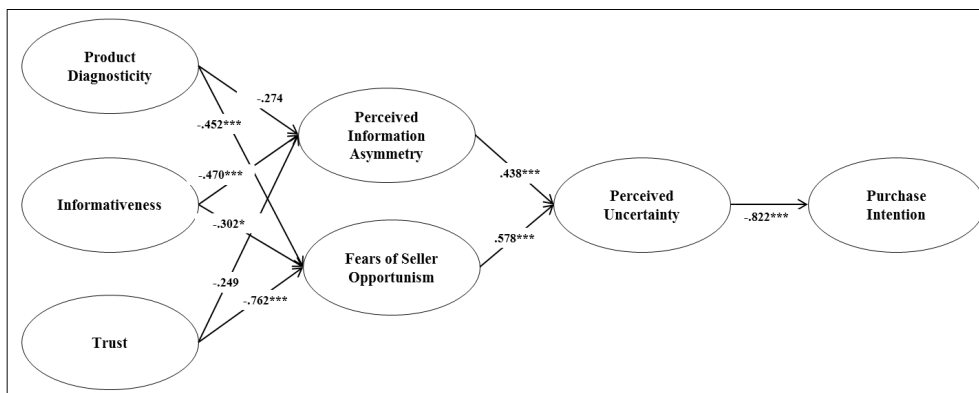

Figure 3 – The Korea Domestic Model: Effect of FTS on Perceived Uncertainty & Purchase Intention

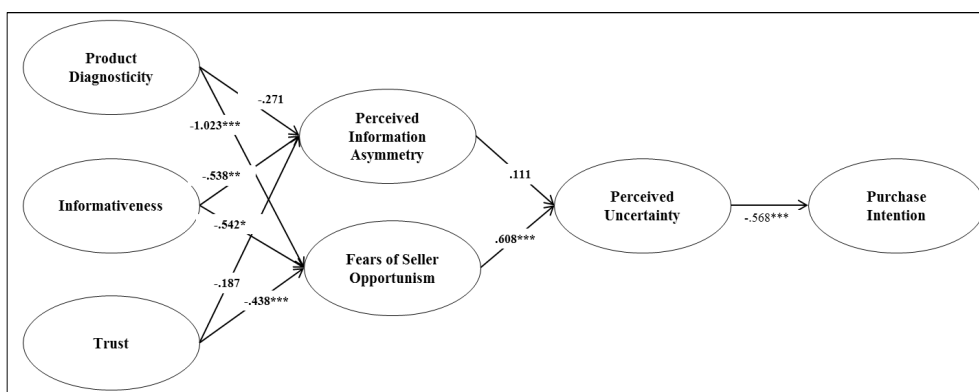

Figure 4 – The Korea Import Model: Effect of FTS on Perceived Uncertainty & Purchase Intention

5 ANALYSIS AND RESULTS

An exploratory factor analysis (EFA) was executed by maximum likelihood extraction method, with varimax rotation to determine the number of factors, followed by confirmatory factory analysis (CFA). Cronbach's coefficient alpha (α) was calculated to assess the internal reliability of the six dimensions affecting consumers' beef purchase intention and to select the final items of the model. The estimated results were found to be satisfactory with most of the alpha values higher than 0.7. This indicates satisfactory levels of internal consistency (Table 5).

Table 5 – Reliability Analysis: China & Korea

Construct	China	Korea
	Cronbach's Alpha	Cronbach's Alpha
Product Diagnosticity	.642	.647
Informativeness	.556	.656
Trust	.829	.733
Perceived Information Asymmetry	.789	.650
Fears of Seller Opportunism	.713	.756
Perceived Uncertainty(domestic)	.817	.710
Perceived Uncertainty(import)	.887	.762
Purchase Intention(domestic)	.560	.729
Purchase Intention(import)	.680	.763

Convergent validity was assessed by determining whether each observed variable's estimated maximum likelihood factor loading on its latent construct was significant (Anderson & Gerbing, 1988). Table 6 indicate that most items' loadings on their corresponding construct (i.e. path coefficients) were significant at $p < .05$, demonstrating adequate convergent validity. Factor loadings in the model had a reasonable range both for China and Korea models (Table 6).

Table 6 – Confirmatory Factor Analysis: China & Korea

Factor	Item No.	China	Korea
		Factor Loading	Factor Loading
Product Diagnosticity	Item 1	.794	.794
	Item 2	.673	.756
	Item 3	.816	.746
Informativeness	Item 4	.833	.863
	Item 5	.833	.863
Trust	Item 6	.824	.859
	Item 7	.877	.841
	Item 8	.887	.725
Perceived Information Asymmetry	Item 9	.909	.861
	Item 10	.909	.861
Fears of Seller Opportunism	Item 11	.814	.858
	Item 12	.848	.816
	Item 13	.724	.787
Perceived Uncertainty (Domestic)	Item 14	.920	.880
	Item 15	.920	.899
Perceived Uncertainty (Imported)	Item 16	.948	.880
	Item 17	.948	.899

Factor	Item No.	China	Korea
		Factor Loading	Factor Loading
Purchase Intention (Domestic)	Item 18	.872	.886
	Item 19	.870	.886
	Item 20	.658	.845
	Item 21	.301	.873
Purchase Intention (Imported)	Item 22	.892	.838
	Item 23	.883	.801
	Item 24	.737	.415
	Item 25	.424	.505

6 STRUCTURAL PATHS AND HYPOTHESES TESTS

The structural relationships are tested with the proposed model (Table 7 and 8), and the mixed results came out for four models.

Table 7 – Comparative Analysis for Domestic and Imported Products: China

Variable Name		Domestic		Imported	
		Estimate	P	Estimate	P
Product Diagnosticity	→ Perceived Information Asymmetry	.154	.252	.107	.442
Informativeness	→ Perceived Information Asymmetry	.791	***	.947	***
Trust	→ Perceived Information Asymmetry	.065	.549	.013	.911
Product Diagnosticity	→ Fears of Seller Opportunism	.214	.078	.140	.169
Informativeness	→ Fears of Seller Opportunism	.473	.012	.753	***
Trust	→ Fears of Seller Opportunism	.212	.030	.099	.437
Perceived Information Asymmetry	→ Perceived Uncertainty	.178	.020	.105	.378
Fears of Seller Opportunism	→ Perceived Uncertainty	.846	***	.792	***
Perceived Uncertainty	→ Purchase Intention	.716	***	.511	***

Domestic: RMR=.053, GFI=.924, CFI=.954, RMSEA=.051, *P<0.1, **P<0.05, ***P<0.01
Imported: RMR=.060, GFI=.922, CFI=.953, RMSEA=.052, *P<0.1, **P<0.05, ***P<0.01

Table 8 – Comparative Analysis for Domestic and Imported Products: Korea

Variable Name		Domestic		Imported	
		Estimate	P	Estimate	P
Product Diagnosticity	→ Perceived Information Asymmetry	.274	.310	.271	.380
Informativeness	→ Perceived Information Asymmetry	.470	.009	.538	.046
Trust	→ Perceived Information Asymmetry	.249	.231	.187	.183
Product Diagnosticity	→ Fears of Seller Opportunism	.452	.004	1.023	.009
Informativeness	→ Fears of Seller Opportunism	-.302	.109	-.542	.080
Trust	→ Fears of Seller Opportunism	.762	.004	.438	.009
Perceived Information Asymmetry	→ Perceived Uncertainty	.438	***	.111	.404
Fears of Seller Opportunism	→ Perceived Uncertainty	.578	***	.608	***
Perceived Uncertainty	→ Purchase Intention	.822	***	.568	***

Domestic: RMR=.054, GFI=.894, CFI=.926, RMSEA=.067, P<0.05, ***<0.001

Imported: RMR=.064, GFI=.889, CFI=.923, RMSEA=.065, P<0.05, ***<0.001

Hypotheses of the China Domestic Model & the China Import Model

Hypothesis 1a states that product diagnosticity mitigates a buyer’s perceived information asymmetry, while Hypothesis 1b states that Product diagnosticity mitigates a buyer’s fears of seller opportunism. Hypothesis 1a was not supported both in the China Domestic Model and the China Import Model. Hypothesis 1b, on the other hand, was supported in the China Domestic Model.

Hypothesis 2a states informativeness mitigates a buyer’s perceived information asymmetry, and Hypothesis 2b states informativeness mitigates a buyer’s fears of seller opportunism. These two hypotheses were supported in both Chinese models.

Hypothesis 3a states that trust mitigates a buyer’s perceived information asymmetry, and Hypothesis 3b says that trust mitigates a buyer’s fears of seller

opportunism. Hypothesis 3a was rejected in both two models, while Hypothesis 3b was supported only in the China Import Model.

Hypothesis 4 says that perceived information asymmetry positively influences a buyer's perceived uncertainty. This hypothesis was supported only in the China Import model. Hypothesis 5 says that fears of seller opportunism positively influence a buyer's perceived uncertainty, which was supported both models. Hypothesis 6 says that a buyer's perceived uncertainty negatively influences his/her purchase intention, which was strongly supported in both models.

Hypotheses of the Korea Domestic Model & the Korea Import Model

Hypothesis 1a was not supported both in the Korea Domestic Model and the Korea Import Model. Hypothesis 1b, on the other hand, was supported both in the Korea Domestic Model and the Korea Import Model. Both Hypothesis 2a and 2b were supported in both models. Hypothesis 3a was rejected in both models and 3b was supported in the two models. Hypothesis 4 was supported only in the Korea Domestic model. Hypothesis 5 & 6 were supported in both models.

The goodness-of-fit (GFI), root-mean-square error of approximation (RMSEA), and comparative fit index (CFI) were; .924, .051 and .954 for the China Domestic Model: .922, .052 and 0.953 for the China Import Model (Table 9). The goodness-of-fit (GFI), root-mean-square error of approximation (RMSEA), and comparative fit index (CFI) were; .894, .067 and .926 for the Korea Domestic Model : .889, .065 and .923 for the Korea Import Model (Table 9). These measures indicate that all four models show an adequate fit.

Table 9 – Hypotheses Testing of the Proposed Theoretical Model

Hypothesis 1a	Product diagnosticity mitigate a buyer's perceived information asymmetry.
Hypothesis 1b	Product diagnosticity mitigates a buyer's fears of seller opportunism.
Hypothesis 2a	Informativeness mitigates a buyer's perceived information asymmetry.
Hypothesis 2b	Informativeness mitigates a buyer's fears of seller opportunism
Hypothesis 3a	Trust mitigates a buyer's perceived information asymmetry.
Hypothesis 3b	Trust mitigates a buyer's fears of seller opportunism
Hypothesis 4	Perceived information asymmetry positively influences a buyer's perceived uncertainty.
Hypothesis 5	Fears of seller opportunism positively influence a buyer's perceived uncertainty.
Hypothesis 6	A buyer's perceived uncertainty negatively influences his/her purchase intention.

7 DISCUSSION AND CONCLUSION

The paper validates a model which approximates a relationship between perceived uncertainty of consumers and two antecedents & three mitigators which explain the value of Food Traceability System (FTS). The proposed model was drawn from Pavlou, Liang and Xue (2007) study which applied the principal-agent perspectives, and this study contributes to current literature by improving understanding of structure of perceived uncertainty of a food product with credence good with this model. In addition, the study assesses the value and effects of FTS in reducing perceived uncertainty of beef from various origins and suggests important implications for stakeholders in beef sector regarding feasibility and marketability of FTS.

This study has several key findings that are validated in two distinct empirical cases (i.e. countries) with two different products (i.e. domestic products vs. import products). First, Fears of seller opportunism were found to have statistically significant and strong effect on Perceived Uncertainty both in Korea & China Domestic and Import models. On the other hand, Perceived Information Asymmetry was found to be statistically significant only for Domestic Model both in China and Korea, and its impact was much smaller than Fears of seller opportunism. Two, Perceived Uncertainty was found to have significant impact on Purchase Intention in all four models. The effect of Perceived Uncertainty was found to be greater in the Domestic model in China and Korea. Third, among three uncertainty mitigators, Informativeness was found to have the largest impact on the two antecedents of Perceived Uncertainty (i.e. Fears of seller opportunism & Perceived Information Asymmetry) in the China Domestic & China Import Models. More specifically, Informativeness had larger impact on Perceived Information Asymmetry. In Korean case, significantly different outcomes were found out. Product Diagnosticity & Trust had significant effects on Fears of Seller Opportunism, while Informativeness had impacts on both Fears of seller opportunism & Perceived Information Asymmetry.

Both in China and South Korea, uncertainty perceptions due to Fears of Seller Opportunism appear to negatively affect consumers' beef purchase intention. Its impact was much greater than the other antecedent, Perceived Information Asymmetry. However, results suggest different approach in dealing with this challenge in China and South Korea. Chinese consumers perceive Informativeness to be a major factor that could improve their perceived uncertainty situation. "quick and easy access to large volume of information" and "being able to learn a lot from FTS" are found to be of value for Chinese consumers in purchasing traceable beef products. On the other hand, Korean consumers were found to value different aspect of FTS in reducing their Fears of Seller Opportunism. For domestic beef choice, Trust was found to have the largest effect on Fears of Seller Opportunism, while Product Diagnosticity had the largest effect on Fears of Seller Opportunism for import beef choice. In other words, Korean consumers consider the FTS to "provide objective information on domestic beef products sufficiently" & "information on FTS is trustworthy" for

the FTS of domestic beef. In term of import beef choice, they expect FTS “to help them evaluate their choice” & “make it much easier to purchase import beef”.

The proposed model confirms that Perceived Uncertainty of consumers function as a critical impediment in consumes’ beef purchase decision, and Fears of Seller Opportunism & Perceived Information Asymmetry are two major sources underlying the Perceived Uncertainty. Cross-country validation of the proposed model enables elicitation of differentiated implications for China and South Korea. Findings evidently reflect the current market circumstance regarding consumers’ concerns and Perceived Uncertainty towards import food products for their credence nature. Different aspects of FTS were found to have mediating role in reducing Perceived Uncertainty in China and South Korea.

Table 10 – Preferred Country of Origin for Beef Purchase in China & Korea

Country	China	Korea
Home Country	31.1	62.7
USA	15.1	2.7
Australia	23.7	28.0
Canada	3.0	1.8
New Zealand	27.1	4.9

This may be due to different attitude of consumers in China and Korea toward their domestic beef products (Table 10). Korean consumers had distinctly higher rate of preference (62.6%) for domestic origin for beef choice compared to Chinese consumers (31.1%). Consumers’ preference for other country origins also showed mixed results. Beef products from Australia (23.7%) and New Zealand (27.1%) were similarly preferred by Chinese consumers, followed by the U.S. origin (15.1%). In contrast, Korean consumers identified Australian (28%) origin as a preferred import beef, while other origins showed considerably weak preference by Korean consumers. Due to this fundamentally different preference structure in China and Korea, consumers’ Perceived Uncertainty may be mitigated by different factors. Informativeness was found to be the most effective aspects of FTS improving Chinese consumers’ Perceived Uncertainty for both Domestic and Import beef choices. For Korean consumers, Product Diagnosticity was the most valuable aspect of FTS for Import beef, while Trust was the most influential factor for Domestic beef choice. Marketers and policy makers should recognize the relative effectiveness of each uncertainty mitigators in communicating the product information with consumers. It is important to note that different aspects of FTS should be emphasized in different countries and also for different type of products (i.e. domestic vs. import).

ACKNOWLEDGMENTS

The research reported is funded by the Social Science Korea (SSK) Research Grant of the National Research Foundation of Korea (NRF), and the author would like to thank the NRFK for supporting our research project (NRF-2013S1A3A2052995).

REFERENCES

- Aaker, J.L. 2000. Accessibility or Diagnosticity? Disentangling the Influence of Culture on Persuasion Processes and Attitudes. *Journal of Consumer Research*, 26(4) (March), pp.340–357.
- Aboulnasr, K., 2006. Country of Origin Effects: The Role of Information Diagnosticity, Information Typicality and Involvement. *Marketing Management Journal*, 16(1), pp.1-18.
- Chiles, T.H., and McMackin, J.F., 1996. Integrating variable risk preferences, trust, and transaction cost economics. *The Academy of Management Review*, 21(1), pp.73–99.
- Choe, Y.C., Park J.W., Chung, M. and Moon, J.H., 2009. Effect of the food traceability system for building trust: Price Premium and buying behavior. *Information Systems Frontiers*, 11(2), pp.167–179.
- Ducoffe, R.H., 1996. How consumers assess the value of advertising. *Journal of Current Issues and Research in Advertising*, 17(1), pp.1-18.
- Eisenhardt, K., 1989. Agency Theory: An Assessment and Review, *Academy of Management Review*, 14(1), pp.57–74.
- Garretson, J.A. and Burton, S., 2000. Effects of Nutrition Facts Panel Values, Nutrition Claims, and Health Claims on Consumer Attitudes, Perceptions of Disease-Related Risks, and Trust. *Journal of Public Policy and Marketing*, 19(2), pp.213–227.
- GS1, 2009. Case Study: Food Traceability, GS1 Traceability Implementation between China and France. GS1 AISBL.
- Gurhan-Canli, Z. and Maheswaran, D., 2000. Determinants of Country-Of-Origin Evaluations, *Journal of Consumer Research* 27(1), pp.96–108.
- Häubl, G., 1996. A Cross-National Investigation of the Effects of Country of Origin and Brand Name on the Evaluation of a New Car. *International Marketing Review*, 13(5), pp.76 –97.
- Hoch, Stephen J. and Young-Won Ha.1986. Consumer Learning: Advertising and the Ambiguity of Product Experience. *Journal of Consumer Research*, 13(2), pp. 221–233.

Hong, S.T. and Wyer, R.S. Jr., 1989. Effects of Country of Origin and Product Attribute Information on Product Evaluation: An Information Processing Perspective. *Journal of Consumer Research*, 16(2), pp.175–187.

Jansen-Vullers, M.H., Van Dorp, C.A. and Beulens, A.J.M., 2003. Managing traceability information in manufacture. *International Journal of Information Management*, 23(5), pp.395–413.

Jensen, M. and Meckling, W.H., 1972. The Theory of the Firm: Managerial Behavior, Agency Costs and Ownership Structure. *Journal of Financial Economics*, 3(4), pp.305-360.

Jiang, Z. and Benbasat, I., 2004. Virtual Product Experience: Effects of Visual and Functional Control of Products on Perceived Diagnosticity and Flow in Electronic Shopping. *Journal of Management Information Systems*, 21(3), pp.111–147.

Kahneman, D. and Tversky, A., 1979. Prospect theory: an analysis of decision under risk. *Econometrica*, 47(2), pp.263–292.

Kempf, D.S. and Smith, R.E., 1998. Consumer Processing of Product Trial and the Influence of Prior Knowledge: A Structural Modeling Approach. *Journal of Marketing Research*, 35(3), pp.325–337.

Kim, R., Chao, Y. and Zhang, Q., (in press) Comparative Analysis of Food Risk Management Quality (FRMQ) of the Public vs. the Private Sectors: Chinese Consumers' perspectives. *International Journal of Economics & Management in Review*

Maheswaran, D., 1994. Country of Origin as a Stereotype: Effects of Consumer Expertise and Attribute Strength on Product Evaluations. *Journal of Consumer Research*, 21(2), pp.354–365.

Mayer, R.C., Davis, J.H. and Schoorman, F.D., 1995. An Integrative model of Organizational Trust. *Academy of Management Review*, 20(3), pp.709–734.

Meyer, H., 1999. When the cause is just. *Journal of Business Strategy*, 20(6), pp.27–31.

Milgrom, P. and Roberts, J., 1992. *Economics, organization and management*. New Jersey, NJ: Prentice Hall.

Mishra, D.P., Heide, J.B. and Cort, S.G., 1998. Information Asymmetry and Levels of Agency Relationships. *Journal of Marketing Research*, 35(3), pp.277–295.

Nagashima, A., 1970. A Comparison of Japanese and U.S. Attitudes Toward Foreign Products. *Journal of Marketing*, 34(1), pp.68–74.

Pavlou, P.A. and Fygenson, M., 2006. Understanding and predicting electronic comer adoption: an extension of the theory of planned behavior. *MIS Quarterly*, 30(1), pp.115–143.

Pavlou, P.A. and Gefen, D., 2004. Building effective online marketplaces with institution-based trust. *Information Systems Research*, 15(1), pp.37–59.

Pavlou, P.A., Liang, H. and Xue, Y., 2007. Understanding and mitigating uncertainty in online environments: a principal–agent perspective. *MIS Quarterly*, 31(1), pp.105–136.

Rousseau, D.M., Sitkin, S.B., Burt, R.S. and Camerer, C., 1998. Not so different after all: A cross-discipline view of trust. *Academy of Management Review*, 23(3), pp.393–404.

Swan, J.E. and Nolan, J.J., 1985. Gaining customer trust: a conceptual guide for the salesperson. *Journal of Personal Selling and Sales Management*, 5(2), pp.39–48.

Wang, Z.G., Weng, Y.Z., Yang, Z.G. and Zheng, F.T., 2016. The effectiveness of adopting HACCP system certification in food industry: From the questionnaire of 482 food manufacturing enterprises in China. *China Soft Science*, 2006(9), pp.69–76.

ABOUT THE AUTHORS

D. H. Yoon is a research fellow at the KISE research institute, Hanyang University, Korea, and specialized in international marketing and international business strategy. He has published several research papers in cross country analysis of consumers in Asia, including Korea and China.

Q. Zhang is a professor in Risk Management, China Academy of Agricultural Science (CAAS), China. He is also the managing director of the Agricultural Information Institute (AII) at CAAS, and Secretary General of the Agricultural Sci-technology Information Society. His research focuses on agricultural risk management, rural finance & marketing of agricultural commodity. He has published more than 90 papers in academic journal and completed more than 50 projects which are consigned by Chinese government and international fund.

R. B. Kim is a professor in international business, international marketing at School of Business, Hanyang University, Korea. She is also the executive director of KISE research institute, and has published over 50 publications in peer-reviewed international journals. Her research focuses on international consumer marketing studies, international business strategy, global branding strategy etc.

Analysis of Innovative Start-Up Companies – Case of Košice Region

DOI: 10.12776/QIP.V20I1.641

Peter Džupka, Slávka Klasová, Viliam Kováč

Received 25 November 2015, Revised 9 April 2016, Accepted 19 May 2016

ABSTRACT

Purpose: Support policy for start-up companies is being developed nowadays in Slovakia, but so far there has hardly been any research focuses on this issue. Therefore, the aim of this article is to identify, what are the specific needs and funding sources of start-up companies according to their stage of development.

Methodology/Approach: This paper used questionnaire empirical approach. The research was conducted in the Košice region. The sample of 47 innovative start-up companies was obtained and analysed using statistical measurements such as the Pearson's chi-square test and the correspondence analysis method.

Findings: The results reveal that start-up companies at their initial phase of development mostly use bank loans as a funding source of their activities, but they opt also business angel as their source of funding at start phase of development. The findings further discover relation between the stage of the development of start-up company and its specific need. Additionally, research probes that collaboration with other firms or universities has a positive impact on prosperity of the start-up company in terms of higher profitability and better access to funding.

Research limitation/Implication: The Košice region is not an area, where representative survey in the field of start-up companies can be held nowadays. It relates to small market of innovative and creative solutions and goes with not so developed incentives to support start-up companies in their initial phase of development too. Thus, all the results and the outcomes coming from the dataset can be considered rather demonstrational than complex.

Originality/Value of paper: We show the specific needs and funding sources for start-up companies in the Košice region according to their stage of development and thus identify, which aspects government representatives should pay attention to and what should be taken into consideration when designing

policy initiatives oriented towards support of start-up prosperity. Furthermore, we bridge the gap between increased attention to analysis of start-up companies and no effort made to analyse them in the Košice region.

Category: research paper.

Keywords: start-up; innovation; support policy; prosperity.

1 INTRODUCTION

It has been acknowledged that start-up companies have essential role as a driver of technological and economic growth of any country. Those companies create a favourable environment and by introducing new products or services they can substantially contribute to a country's competitiveness (Mazanai and Fatoki, 2012). Additionally, as they tend to be more labour intensive they can boost employment more effectively than large firms. From this point of view government intervention for subsidies to promote start-up and spin-off prosperity is needed in order to create such employment (Alweendo, 2004). As the rationale for public support for companies is confirmed by several research, countries have started to establish a range of programmes for supporting start-up scene. Local start-up scene is growing also in the Košice region. The first official centre for supporting start-up projects Eastcubator was founded in 2012 and thenceforward several start-up activities have been created. For instance, the Technical University of Košice, the second largest technical university in Slovakia, opened its Startup Center for the first batch of young innovative start-up companies (City of Košice, 2015). By the end of 2014, two incubators were founded in Košice – one of them was established at the Technical University of Košice and the other one was founded as a result of the commercial activity of the AZU project members (Lavčák and Hudec, 2015). Following the efforts and cooperation of various institutions, companies and individuals, the Košice region is on a great path towards becoming a regional heart of innovative start-up. In spite of that local ecosystem is very dynamic and keeps changing, it is growing only slowly. This development is the consequence of some reasons. For instance, definition of start-up companies is often confused, although they are mentioned in strategic development documents (Džupka and Vajda, 2015). Secondly, there is a lack of cooperation and coordination between the various existing initiatives and companies specific required needs.

Muller and Rammer (2012) present some proposals for this situation. First of all, when government focuses on creation of a policy to promote new start-up companies, it is first and essential to classify the different types of start-up companies and their stage of development. Further, it is important to examine their special needs according to their stage of development (Muller and Rammer, 2012). Support measures cannot be equal for each start-up companies as they have different needs and require different support according to their stage of development. As our research reveals, while in the initial phase of their

development they seek marketing and mentoring services, at the start phase they need help in finding potential new customers and at the growth phase they look for access to incubators or accelerators. Another research carried out by Cvijanović, Marović and Sruck (2008) and Čalopa, Horvat and Lalić (2014) pointed out that financing of the start-up companies also depends on the phase of development. Therefore, in this paper we focus on the financial source of start-up companies while taking into account their stage of development. Our research reveals that bank loans are important formal financial sources for many start-up companies at their initial and start phase of development. However, business angels are used as a main source of funding of start-up companies at their start and risk capital at their growth phase of development.

The rest of the paper is organised as follows. The next section presents some literature background on start-up companies. Section 3 and Section 4 present data and methodological approach used in this study. Section 5 reports the obtained results and conclusion with highlights opportunities to improve and to broaden this research.

2 THEORETICAL OVERVIEW

There is no single formal definition on start-up companies in the current literature. Saini and Plowman (2007) describe start-up companies as small companies, most often with a high-tech focus and in an early stage of development creating a product or service. In terms of company size, start-up companies represent a segment of small and medium-sized companies (Saini and Plowman, 2007). In our research of 47 start-up companies, each company had no more than 15 employees and thus can be classified as a small company according to the European Commission standards (European Commission, 2015). Another definition comes from Blank and Dorf (2012), who describe start-up company as a temporary organisation in search of a scalable, repeatable and profitable business model (Blank and Dorf, 2012). While for Bürgel (1998) start-up company is legally independent company not older than ten years operating in one or more high-tech sectors. The oldest start-up company in our research is six years old company. Concerning the high-tech issue Chorev and Anderson (2008) proposed definition of high-tech start-up company. According to them, high-tech start-up company is heavily dependent upon innovation in science and technology.

2.1 Funding sources of start-up companies

Finding investment sources to set up or to expand a start-up is a big obstacle faced by many entrepreneurs. Usually start-up project founders do not have their own financial resources and therefore need external investments. There are several traditional funding sources such as subsidised bank loan, business angel, risk capital and structural fund that can be used.

Subsidised bank loan represents a loan, which borrower pays no interest for. In other words, interest rate reaches a zero level at all or it is paid by the third party, who subsidises borrowing business.

Company supported by business angel is a very common case in field of financing newly founded start-up firms. Business angels are investors who help start-up companies to realize their business ideas. Additionally, business angels help by sharing their know-how, experience and financial resources which is the additional option for survival of the companies (Čalopa, Horvat and Lalić, 2014).

Risk capital investments can come from individuals, companies or funds that invest in individual companies in order to help their development. Risk capital is not affected by company's cash flow.

Structural fund denotes a kind of financial funding coming from the institutions of the European Union. These structural funds are aimed at development of the particular sectors of the national economics in the certain regions. They focus on aid to the member states to raise entrepreneurship not only in the manufacturing sector but also in the service sector.

2.2 Phase of development of start-up companies

Start-up companies during their life cycle go through different stages of development. As argued by Maurya (2012), one can distinguish three main different stages.

The first stage is the initial phase which investigates whether the market has a problem that needs to be solved. In that phase the founding start-up team is formed and a business plan is created. During this phase innovative start-ups tend to require eminent amount of investment thus, training programmes, legal and management advice offered free of charge or through low-cost consulting services can be very helpful for them (Muller and Rammer, 2012).

It is also claimed that financing of start-up companies depends on the phase of development (Cvijanović, Marović and Sruk, 2008; Čalopa, Horvat and Lalić, 2014). In the initial phase companies mainly use subsidised bank loans, business angels, and venture capital funds. A large number of researches claim that finding investment sources at the initial phase is a obstacle faced by many start-up companies. Since start-ups are mostly set up by young people, who do not own property in many cases, it is difficult to demonstrate advance proof of innovative competence and economic performance (Lejpras, 2012), so bank or investors cannot accurately assess the potentiality of them (Leland and Pyle, 1977). Moreover, many start-up companies hesitate to reveal detailed information about the project as they have a fear of disclosure to potential rivals. In summary, if the market is not sufficiently developed to serve the financing needs of innovative start-ups, funding programmes, such as grant, guarantees and loan, are inevitable.

At the second stage, the focus is on developing the product and the start-up is essentially a product development team (Kazanjian, 1988). The company incorporates and raises seed capital. This stage is frequently named as start stage in the entrepreneurship literature.

The third phase involves the expansion and growth of start-up companies, which leads to higher number of employees and market shares or to higher income. Company makes the transition from start-up to real business. In this stage the product takes off and the start-up makes transition into a formal company as organisational structure begins to form (Skuladotir, 2013). In the expansion phase, the most common sources of funds are venture capital funds and loan funds (Čalopa, Horvat and Lalić, 2014). In this stage of development it is indeed important to increase awareness of innovative start-up business among the general population and to create a positive entrepreneurial climate. Giving awards to start-ups that have successfully established innovative business models or introduced innovative products can be a useful tool for this.

In this paper we provide information on how the funding sources and specific needs vary according to the stage of development by testing two hypotheses.

Hypothesis 1: there is a statistically significant relationship between the stage of development and funding source used by start-up companies.

Hypothesis 2: there is a statistically significant relationship between the stage of development and specific demanded and availed services.

2.3 Start-up companies and collaboration activities

Collaboration activities are sources of additional or complementary knowledge and know-how that are not available within the firm (George, Zahra and Wood, 2002). Moreover, collaboration helps in overcoming the legitimacy problem (Lejpras, 2012) and in better innovation performance (Spišáková, 2010). Especially for young start-up companies it is difficult to prove advance proof of innovative competence and economic performance. Therefore, links with partners (university or firms) may provide the firm with a reputation by association for reliability and quality (Gübeli and Doloreux, 2005) and enable access to the finance resources. Additionally, collaboration activities and networking may have significantly impact on decreasing a firm's costs. These cost reductions and innovation outputs can result in competitive advantage and improved financial performance (Grant 1998; Lerner 1994; Liebeskind, et al. 1996). Thus, we proposed following hypothesis:

Hypothesis 3: collaboration activities enhance start-up profitability and access to finance sources.

3 DATA

The primary research was conducted through questionnaire survey administered to selected 47 start-up companies located in the Košice region. The research questionnaire have 16 questions divided into three main areas. The first area with the title Main characteristics of start-ups contain the questions about their clients, collaboration activities and their stage of development. The second area focus on economic condition and competition. This area address demanded and used services for start-up companies at the different stage of development. The last part deal with the questions about their investment, research and development activities. This part helps to define the source of their financing at the stage of development and thus, to specify an expectation. To statistically visualise the gathered data and to establish the basic characteristics of the sample, correspondence analysis and chi-square tests are applied. Correspondence analysis is a statistical technique constructed to visually express relations involved in the dataset. This set of methods manages to handle both quantitative and qualitative data. Obvious way of an input is a contingency table. Standard form of an outcome is diagram or similarity table. There are several superstructures built upon correspondence analysis with their specific purposes – for instance multiple correspondence analysis, detrended correspondence analysis and canonical correspondence analysis.

4 METHODOLOGY

To analyse relation between the development phase of the particular start-up company and its source of funding, we compute phase profile and funding profile for each type of these dimensions. Profile calculation expresses a share of a certain case of the dimension of the total number of all the instances of the dimension. Development phase profile is quantified in this way:

$$PP_{p:f} = \frac{P_{p:f}}{\sum_{p=1}^m P_{p:f}}$$

- $PP_{p:f}$ – phase profile of the p development phase according to the f funding source;
- p – development phase;
- f – funding source;
- $P_{p:f}$ – a number of start-up companies positioned in the p development phase and financed by the f funding source;
- m – a number of development phases.

Calculation of funding profile is based on the following formula:

$$FP_{p:f} = \frac{F_{p:f}}{\sum_{f=1}^n F_{p:f}}$$

- $FP_{p:f}$ – funding profile of the f funding source according to the p development phase;
- p – development phase;
- f – funding source;
- $F_{p:f}$ – a number of start-up companies financed by the f funding source and positioned in the p development phase;
- n – a number of funding sources.

To measure differences between the development phases and the funding sources themselves we calculated chi-squared distance (Yelland, 2010). Chi-squared distance is quantified for development phase profile in a following way:

$$D_{p_1;p_2} = \frac{PP_{p_1:f} - PP_{p_2:f}}{APP_p}$$

- $D_{p_1;p_2}$ – chi-squared distance between the p_1 development phase and the p_2 development phase;
- p_1, p_2 – development phases;
- f – funding source;
- $PP_{p_1:f}$ – phase profile of the p_1 development phase according to the f funding source;
- $PP_{p_2:f}$ – phase profile of the p_2 development phase according to the f funding source;
- APP_p – average phase profile of the p development phase according to the f funding source.

For funding profile it is done as follows:

$$D_{f_1:f_2} = \frac{FP_{p:f_1} - FP_{p:f_2}}{AFP_p}$$

- $D_{f_1:f_2}$ – chi-squared distance between the f_1 funding source the f_2 funding source;
- p – development phase;
- f_1, f_2 – funding sources;
- $FP_{p:f_1}$ – funding profile of the p development phase according to the f_1 funding source;
- $FP_{p:f_2}$ – phase profile of the p development phase according to the f_2 funding source;

- AFP_f – average funding profile of the f funding source according to the p development phase.

5 EMPIRICAL RESEARCH RESULTS

The aim of conducted research was to identify the stage of development of start-up companies, their financing methods, collaboration activities and their used and demanded services. By applying correspondence analysis, specific characteristics of start-up companies were perceived. The results of the research showed that 36 % of start-up companies are just at the initial phase in which their business plan is completed and now they are searching for potential source of finance, 39 % start-up companies are in the stage of start phase and 25 % companies are at the growth phase where the emphasis is put on higher sales of their products or services.

5.1 Analysis of funding sources

Researching the source of funding has shown that the most similar funding sources are subsidised bank loan and business angel, which correspondence is given by chi-squared distance of only 0.088 as seen in the Table 1. This situation is confirmed by the fact that these two funding sources were important at the start phase of development. Additionally, almost all start-up companies at their initial used subsidised bank loans. The second most similar relation lies between a pair of business angel and structural funds with chi-squared distance at level of 0.142. This similarity is based on the fact, that these sources of funding were rarely used by companies at their initial phase of development, but mostly by companies at their start phase of development. Results are thus not in correspondence with theoretical expectations that business angel will be mainly used at the initial phase. The Business Angels Network was established in 2011, hence Slovakia was the penultimate country of the entire European Union to have such a network. In Slovakia the Business Angels Network (SBAN) was established in 2011, and Slovakia was the penultimate country of the EU 27 to have such a network. It seems that there is a lower reputation and awareness of Business angel Networks amongst start-up companies at their initial phase. According to several additional interviews with start-up companies the explanation of this finding can be in found in two issues. The first is the cultural problem – Slovakia start-up entrepreneurs usually have small propensity to swap equity for external funding. The second issue is that the risk capital in Slovakia usually offers fewer funds for higher equity than in western countries. The start-up companies' considers this rate as disadvantageous.

The mostly different funding sources are subsidised bank loan and risk capital. Their mutual chi-squared distance reaches value of 0.726. This seems relatively clear in light of the fact that risk capital is obviously offered in case when no financial institution is willing to support initiation of start-up company. Usually

those companies try to introduce a new technology and it is unclear if there is a market for this. Because of that high uncertainty and lack of collateral there is lower chance to get finance from banks. Risk capital was therefore mainly used by companies at their growth phase of development.

Table 1 – Similarity of funding sources

Funding	Subsidised bank loan	Structural funds	Business angel	Risk capital
Subsidised bank loan	0	0.384	0.088	0.726
Structural funds	0.384	0	0.142	0.366
Business angel	0.088	0.142	0	0.409
Risk capital	0.726	0.366	0.409	0

Source: compiled as own elaboration by authors

To sum up, it can be stated that differentiation of the funding sources according to position in the particular development phase is considerably visible. Above mentioned statement can be formulated into the two following hypotheses:

- H_0 : *there is no statistically significant relationship between the stage of development and funding source used by start-up companies.*
- H_1 : *there is statistically significant relationship between the stage of development and funding source used by start-up companies.*

We have applied standardised Pearson's residuals to investigate, which of these hypotheses is statistically true. The Pearson's chi-square test statistics reaches a value of 10.7838 at 42 degrees of freedom. Its p-value stands at 0.0014. Therefore, we reject the zero hypothesis H_0 and we claim that there is statistically significant relationship between the stage of development and funding source used by start-up companies. Although the fact, that funding tools are in Košice used in different ways than in western countries, must be highlighted here.

5.2 Analysis of collaboration activities

In the next part of the analysis we consider whether the collaboration activities enhance start-up profitability and access to potential finance sources. Start-up companies were therefore asked to evaluate their level of profitability and access to finance. All these indicators were evaluated by scale from 1 to 10, where 1 means the lowest value of the indicator and 10 expresses the highest value of the indicator. The following diagrams visualise residual values of the explored data. Residual represents difference between the observed value of the indicator and the estimated value of the same indicator. In this way it can be examined, in which situation the observed indicator has higher or lower value than it would reach in a case of uniform distribution. Blue coloured shape describes the

situation when the indicator rises to higher value than it is expected, whilst grey coloured shape expresses a situation with lower value or neutral zone that demonstrates a case with approximately expected value.

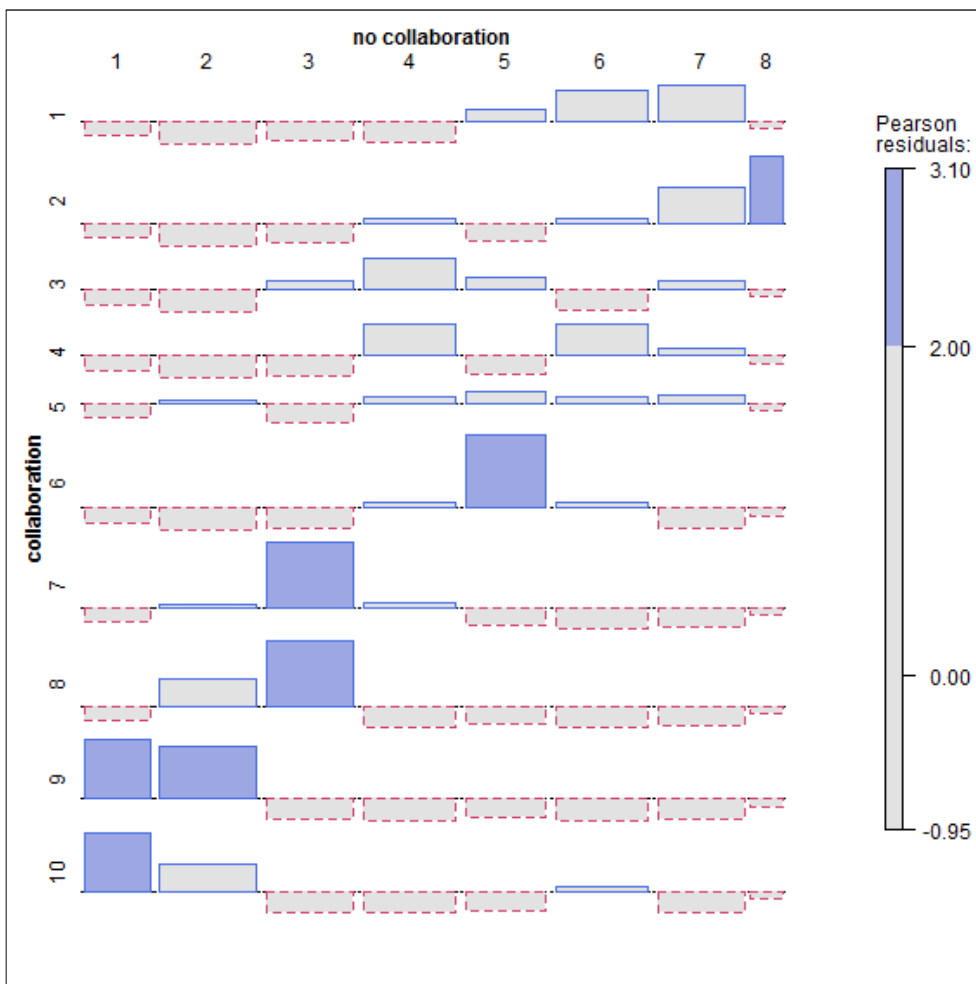

Figure 1 – Evaluation of profitability of start-up companies according to collaboration

The Figure 1 demonstrates how profitability of start-up companies change according to state of their collaboration. The highest profitability is reached by start-up companies, which collaborate with other organisations (firms or universities). It is caused by the fact that commercial partners may help start-up companies in cost reduction as cooperative research and development undertaking is lower than those of individual research and development. Further, the findings show that none of the start-up companies assign values 9 or 10 to their profitability in no collaboration state. On the other hand, there are several

start-up companies that assign the two highest marks to their profitability and at the same time had collaboration state.

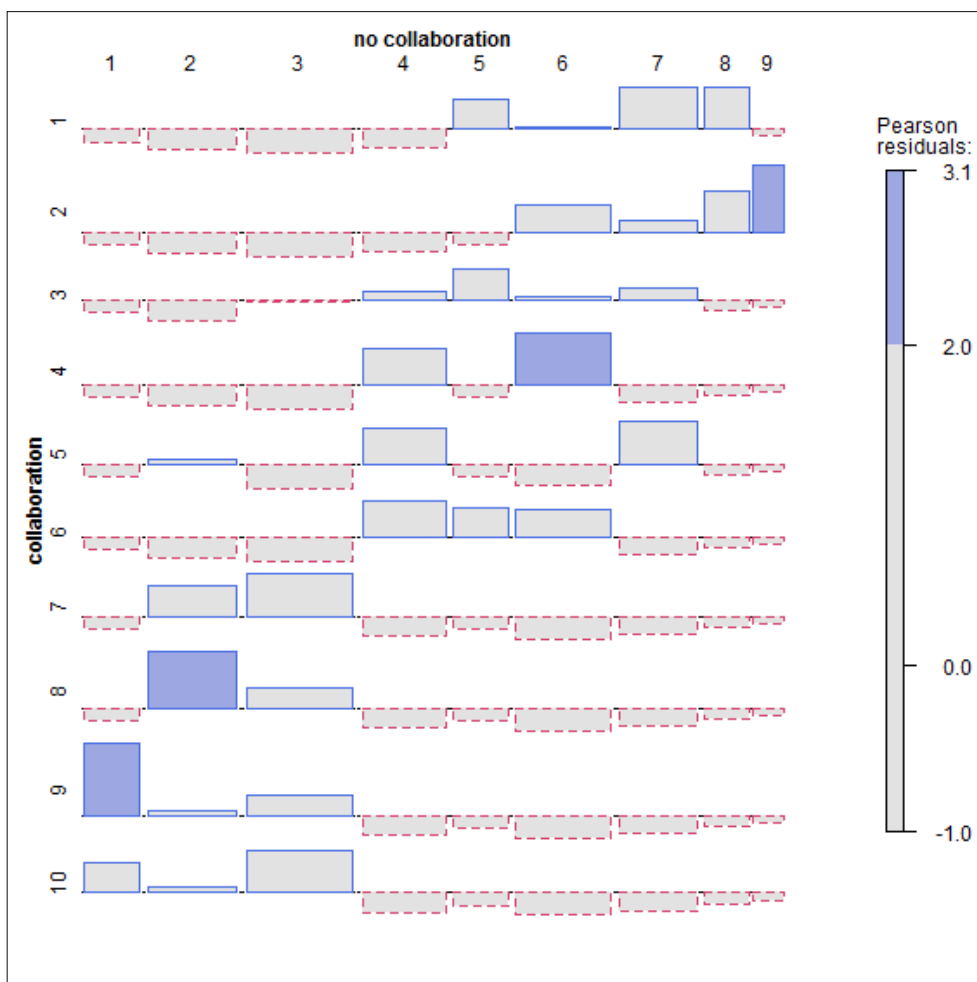

Figure 2 – Evaluation of access to funding sources of start-up companies according to collaboration

The Figure 2 demonstrates how the access to funding sources varies according to state of start-up collaboration. The findings show that collaboration with universities or other firms behaves as an assumption for better access to funding sources for more start-up companies. Better access to finance, which is demonstrated by values 9 and 10, is reached by companies with collaboration activities.

5.3 Analysis of demanded and availed services

As it is stated in the theoretical overview start-up companies have different needs according to their stage of development. Therefore, start-up companies were

asked to select from 22 proposed services those services, which they used or they want use but have no access to them. Results of correspondence analysis are presented below.

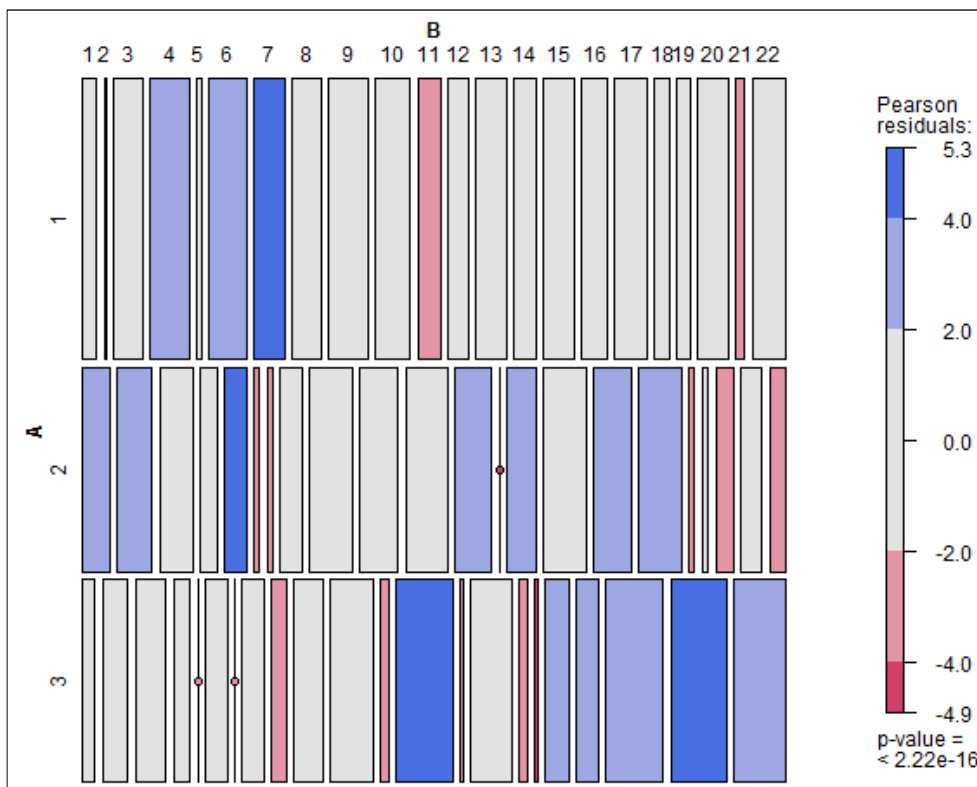

Figure 3 – The demanded services by the start-up companies according to the development phase

Legend of the A axis – development phase: 1 – initial phase, 2 – start phase, 3 – growth phase. Legend of the B axis – services: 1 – accounting services, 2 – management services, 3 – marketing services, 4 – financial services, 5 – creative services, 6 – lectures with successful entrepreneurs, 7 – supporting in creation of business plan, 8 – mentoring in field of development of product and services, 9 – mentoring in field of company funding, 10 – mentoring in field of advice about company growth, 11 – free or subsidised access to law advice, 12 – free or subsidised access to accounting services, 13 – free or subsidised access to creating business plan services, 14 – free or subsidised access to opportunity of company funding, 15 – free or subsidised access to patent and intellectual property, 16 – free or subsidised access to company setup, 17 – free or subsidised access to partner searching, 18 – privileged access to office space, 19 – privileged access to technology and production space, 20 – privileged access to technological equipment, 21 – privileged access to accelerator and incubator services, 22 – competition and events organised by public and private institutions.

In the case of the demanded services (Figure 3), the highest value of Pearson's residuals was investigated in the services aimed at supporting the creation of business plan, helping in financial services and organizing giving lectures with successful entrepreneurs. This type of services was demanded from companies at their initial phase, while companies at their start phase demand for management, accounting and creative services; free or subsidised access to partner searching and company funding. Finally, companies at their growth phase demand for privileged access to office space, technology, equipment and especially to accelerator and incubator. The higher value of Pearson's residuals was observed also in the services organizing competition and events.

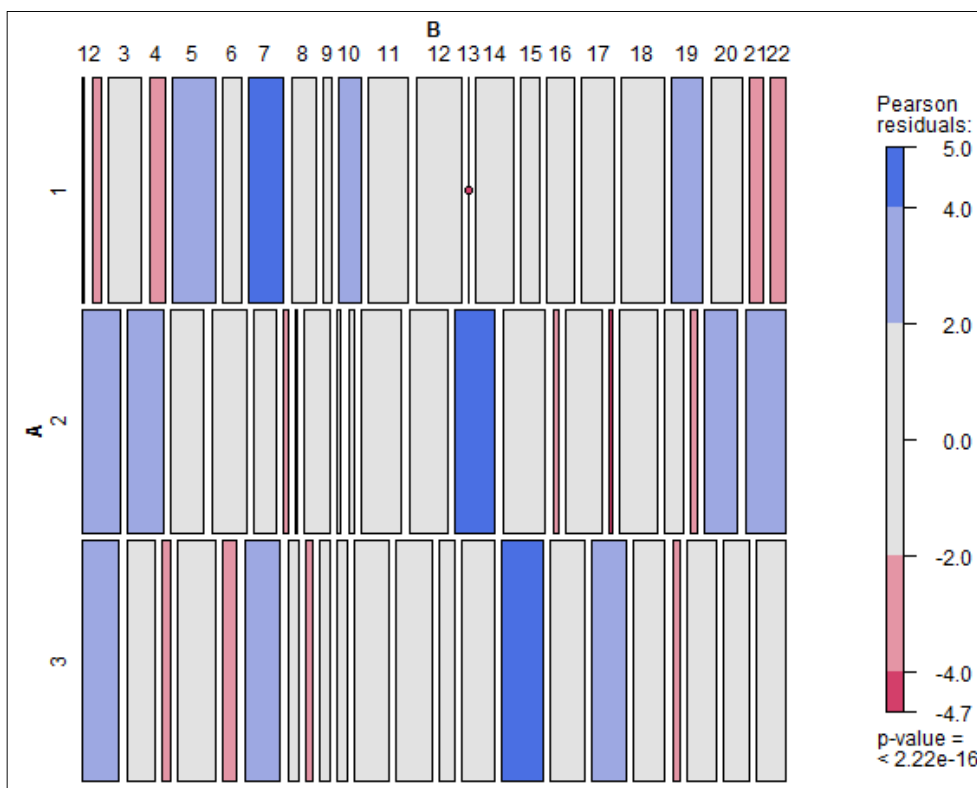

Figure 4 – The availed services by the start-up companies according to the development phase

Further, we investigate the availed services that start-up companies requested and also used for their better performance in competition among other companies in the market as seen in the Figure 4. The higher positive Pearson's residual at the initial phase were observed in services aimed at supporting the creation of business plan and mentoring services intended on giving advice about company growth. At the start phase they mostly availed services concerning to free or subsidised access to creating bussiness plan and to accounting and management

services. Start-up companies at their growth phase of development used mainly services helping in access to partner searching and in access to law advice.

Further in our analysis we propose two following hypotheses to statistically test the obvious relationship between stage of development and different kind of demanded and availed services:

- H_0 : *there is no statistically significant relationship between the stage of development and specific demanded and availed services.*
- H_1 : *there is statistically significant relationship between the stage of development and specific demanded and availed services.*

To find out, which one of these hypotheses is statistically true, we have applied the Pearson's chi-square test. Its statistics stands at a level of 5.4282 at 42 degrees of freedom with p-value reaching a value of 0.0049. Hence, we are able to reject the zero hypothesis H_0 and admit hypothesis H_1 , which means that there is statistically significant relationship between the stage of development of start-up companies and kind of demanded and availed services.

6 CONCLUSION

Presented study empirically investigates start-up companies in terms of their specific needs they required and their source of funding. The analysis of start-up in the Košice region has shown that there is significant change in funding depending on the development stage of start-up companies. Subsidised bank loans are important formal financial sources for many start-up companies at their initial and start phase of development. After surviving the first initial phase, start-up companies gain enough courage to find financial support from other funding sources, such as business angels and structural funds. As start-up companies face several challenges in their efforts to access the finance, central government should collaborate effectively with private sector institutions to ensure adequate access to finance. As in Slovakia there is a just a small number of business angels and also public awareness about venture capital is low, government initiatives should support public awareness of entrepreneurship by activities such as advertising campaigns, awards or business plan competition. We also found, that the start-up community sees less favourable conditions in risk funding in Slovakia compared to western EU countries. This can cause outflow of interesting and competitive start-ups from Slovakia, which can have negative impact on the economy.

Our results also revealed that there exist significant relationship between stage of development of start-up companies and their specific needs. While in the initial stage of their development they need financial services, at the start phase they seek potential new partners and at the growth phase they look for access to incubators or accelerators. Incubators can help to modernise the regional

economy and to retain local resources. Public support to establish and run incubators or accelerators should be provided by local or regional governments. The results of analysis also reveal that, at first glance, start-up companies, which collaborate with the firms or universities, have higher level of profitability and better access to finance. Frequent collaboration may be a driving force behind firm prosperity. To be prosperous in later stages of development, regional innovation policy should provide and also promote incentives for firm cooperation. To sum up, conducted research provides an interesting key input for both public decisions makers and representatives, who can draw implications for adjustment of policy instruments for supporting start-up companies. Those instruments have a potential to ensure sustainable socio-economic development.

ACKNOWLEDGMENTS

This paper was created within the project supported by the Scientific Grant Agency of the Ministry of Education, Science, Research and Sport of the Slovak Republic 1/0548/14 Analysis of differences in innovation performance of spin-off and start-up firms in Slovakia.

REFERENCES

- Alweendo, T., 2004. *Keynote Address at the Opening Ceremony of the 6th African Development Finance Conference and SMME Awards*, Cape Town, South Africa, 20–21 October 2004.
- Blank, S. and Dorf, B., 2012. *The startup owner's manual: the step-by-step guide for building a great company*. Pescadero: K & S Ranch.
- Bürgel, O., Fier, A., Licht, G. and Murray, G., 1998. *Internationalisation of High-Tech Start-Ups and Fast Growth - Evidence for UK and Germany*. [pdf] Available at: <http://ftp.zew.de/pub/zew-docs/dp/dp0035.pdf> [Accessed 25 November 2015].
- Chorev, S., and Anderson, A., 2008. Success factors for high-tech start ups: Views and lessons of Israeli experts. In: A. Groen et al., ed. 2008. *New technology-based firms in the new millenium*. Emerald Group Publishing, pp. 44–68.
- City of Košice, 2015. *Guide to investment in Košice*. [pdf] Available at: http://www.kosice.sk/static/prilohy/KE_investment_bulletin2015.pdf [Accessed 25 November 2015].
- Cvijanović, V., Marović, M. and Sruck, B., 2008. *Financiranje malih i srednjih poduzeća*. Zagreb: Binoza Press.
- Čalopa, M.K., Horvat, J. and Lalić, M., 2014. Analysis of financing sources for start-up companies. *Management*, 19(2), pp.19–44.

- Džupka, P., Vajda, V., 2014. Start-up and Spin-off Does They Require Different Support? In: *5th Central European Conference in Regional Science*. Košice, Slovakia, pp. 205–214. Available at: <http://www3.ekf.tuke.sk/cers/files/zbornik2014/PDF/Dzupka,%20Vajda.pdf> [Accessed 25 November 2015].
- European Commission, 2015. *User guide to the SME definition*. [pdf] Available at: <http://ec.europa.eu/DocsRoom/documents/10109/attachments/1/translations/en/renditions/pdf> [Accessed 25 November 2015].
- George, G., Zahra, S.A. and Wood, D.R., 2002. The effects of business-university alliances on innovative output and financial performance: a study of publicly traded biotechnology companies. *Journal of Business Venturing*, 17(6), pp. 577–609. DOI: 10.1016/S0883-9026(01)00069-6.
- Grant, R.M., 1998. *Contemporary strategy analysis*. 8th ed. New York: Blackwell.
- Gübeli M.H., Doloreux, D., 2005. An empirical study of university spin-off development. *European Journal of Innovation Management*, 8(3), pp. 269–282.
- Kazanjian, R.K., 1988. Relation of dominant problems to stages growth in technology-based new ventures. *Academy of Management Journal*, 31(2), pp. 257-279.
- Lavčák, M., Hudec, O., 2015. *The Late Turn-Out of the Slovak Startup Factories: Locational and Institutional Factors*. [pdf] Available at: <http://www-sre.wu.ac.at/ersa/ersaconfs/ersa15/e150825aFinal01242.pdf> [Accessed 25 November 2015].
- Lejpras, A., 2012. How Innovative Are Spin-Offs at Later Stages of Development? Comparing Innovativeness of Established Research Spin-Offs and Otherwise Created Firms. *Small Business Economics*, 43(2), pp.327–351. DOI: 10.1007/s11187-013-9534-4.
- Lerner, J., 1994. The Importance of Patent Scope - an Empirical-Analysis. *RAND Journal of Economics*, 25(2), pp.319–333.
- Leland, H., Pyle, D., 1977. Informational asymmetries, financial structure, and financial intermediation. *Journal of Finance* 32(2), pp.371–387.
- Liebesskind, J.P., Oliver, A.L., Zucker, L. and Brewer, M., 1996. Social networks, learning, and flexibility: Sourcing scientific knowledge in new biotechnology firms. *Organization Science*, 7(4), pp. 428–443. DOI: 10.3386/w5320.
- Mazania, M., Fatoki, O., 2012. Perceptions of Start-up Small and Medium-Sized Enterprises (SMEs) on the Importance of Business Development Services Providers (BDS) on Improving Access to Finance in South Africa. *Journal of social sciences*, 30(1), pp.31–41.

Maurya, A., 2012. *Running Lean: Iterate from Plan A to a Plan That Works*. California: O'Reilly Media.

Muller, B., Rammer, Ch., 2012. *Start-up promotion instruments in OECD countries and their application in developing countries*. [pdf] GIZ GmbH. Available at: <http://ftp.zew.de/pub/zew-docs/gutachten/start-up-promotion2012.pdf> [Accessed 25 November 2015].

Saini, S., Plowman, K., 2007. Effective communications in growing pre-IPO startups. *Journal of Promotion Management*, 13(3), pp.203–232. DOI: 10.1080/10496490802308547.

Skuladotir, Á., 2013. "It is like asking someone: how do you walk?" *The role of communication in start-up companies*. MSc. Aalto University. Available at: http://epub.lib.aalto.fi/en/ethesis/pdf/13207/hse_ethesis_13207.pdf [Accessed 25 November 2015].

Spišáková, E., 2010. Analysis of innovation activity of Slovak and Czech enterprises. *Quality Innovation Prosperity*, 14(1–2), pp.42–56. DOI: 10.12776/qip.v14i1-2.33.

Yelland, P. M., 2010. An Introduction to Correspondence Analysis. *The Mathematica Journal*, 12(1), pp.86–109. Available at: <http://www.mathematica-journal.com/data/uploads/2010/09/Yelland.pdf> [Accessed 25 November 2015].

ABOUT THE AUTHORS

Peter Džupka is associate professor and head of the Department of Regional Science and Management of the Faculty of Economics of the Technical University of Košice, Slovakia. E-mail contact: peter.dzupka@tuke.sk.

Slávka Klasová is assistant professor at the Department of Regional Science and Management of the Faculty of Economics of the Technical University of Košice, Slovakia. E-mail contact: slavka.klasova@tuke.sk.

Viliam Kováč is young researcher at the Department of Finance of the Faculty of Economics of the Technical University of Košice, Slovakia. E-mail contact: viliam.kovac@tuke.sk.

Corporate Digital Incident Investigation

DOI: 10.12776/QIP.V20I1.656

Jaromír Veber, Lea Nedomová, Petr Doucek

Received 16 December 2015, Revised 09 April 2016, Accepted 19 May 2016

ABSTRACT

Purpose: Information and communication technology are fundamental part of most business entities. Unfortunately, use of these technologies needs to be secured, and in the case that stipulated and legal regulations are not observed, it is very important to not only recognize but also prove such actions/incidents on time. Therefore, the ability to investigate the events/incidents in organization using traces in the information systems may be key component for regulation enforcement.

Methodology/Approach: We propose a model for digital investigations within the organization, based on ISO standards and existing models for common digital investigations.

Findings: The result of our work is a model that can serve as a guide to draft procedures for digital investigations within the organization. Such a procedure should provide evidence of a quality comparable to forensic evidence.

Research Limitation/implication: Our model provides an overview of the entire process and recommendations for its implementation; However, it does not provide a list of specific examination methods, because they vary depending on the case.

Originality/Value of paper: Most of the previously presented models for digital investigations were focused on the investigation of the police forensic laboratories. The originality of our model lies in its focus on investigations in the business organization.

Category: Conceptual paper

Keywords: digital investigation; business; organization; ISO; process; model.

1 INTRODUCTION

As information and communication technologies (ICT) keep developing and are being increasingly used in e-commerce, e-government, social networks and other areas, they more and more influence the regular life of citizens as well as the running of organizations regardless of their legal form. An information society (Webster, 1994) brings rapid information changes. This speed is a big challenge for those who - for some reason - need to keep reliable and provable information. These can be businessmen, officials, attorneys, judges or investigators.

This is an interdisciplinary issue since provability and reliability are terms associated with law, i.e. the legal sector, while safety and information are terms associated with the IT industry. This issue is the subject-matter of the discipline called forensic investigation.

Forensic investigation is a very fast growing branch that adjusts to all IT trends, in particular to everything related to data processing and storing and the means of communication. If we want to secure evidence in digital form, it is necessary to particularly observe the following principles (Jeong, 2006; ISO, 2011a):

Relevance – evidence must clearly correspond with the subject-matter of investigation and must be important for the investigation of an incident and there must be a good reason why evidence should be included in the investigation. Evidence must clearly confirm or disconfirm certain claims and may not allow more possibilities or interpretations.

Reliability – all processes used in analyzing potential digital evidence must be repeatable and auditable; evidence must be obtained in a provable, possibly repeatable and certainly documented or auditable way from reliable media (e.g. disks verified by their owner, the police or an expert in this field).

Sufficiency – qualified authorized persons (person), who conduct the initial securing of digital evidence, should take into consideration the size of an examined data sample in order to perform all activities necessary for requested findings; this includes information about the quantity of materials that they received for processing or, as the case may be, information about which material from which entity they requested and how this request was satisfied.

Digital evidence cannot be procured by just any person. It should be a person who is qualified and especially authorized to do so. Authorization means that such a person has the right to procure digital evidence, e.g. expert institutions or experts. In both cases, it is necessary to consider the qualifications of both institutions and experts. It is not possible e.g. to ask a constitutional law expert to secure digital evidence. Well, it is possible but if you submit such evidence e.g. in court proceedings, its value shall be a zero.

These principles represent the so-called Forensic Investigation Triangle, Fig. 1 (Jeong, 2006).

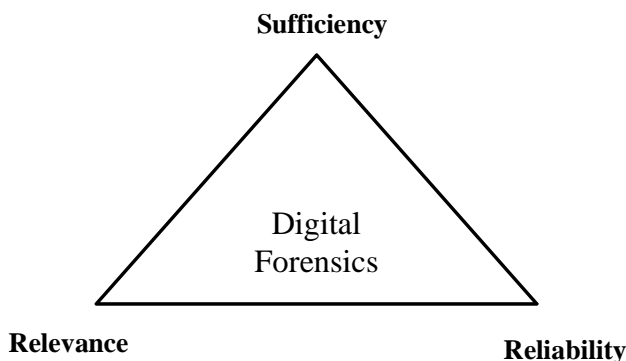

Figure 1 – Digital Forensic Investigation Fundamental, Source: (Jeong, 2006)

The actual principles of forensic investigation must be observed but for an investigation to be effective and purposeful, it is also necessary to take into consideration the processes and potential procedural models designed for forensic investigation. It especially concerns the famous Zachman model (Zachman, 2002). A simple model presented in (Carrier and Spafford, 2004) is shown in Fig. 2.

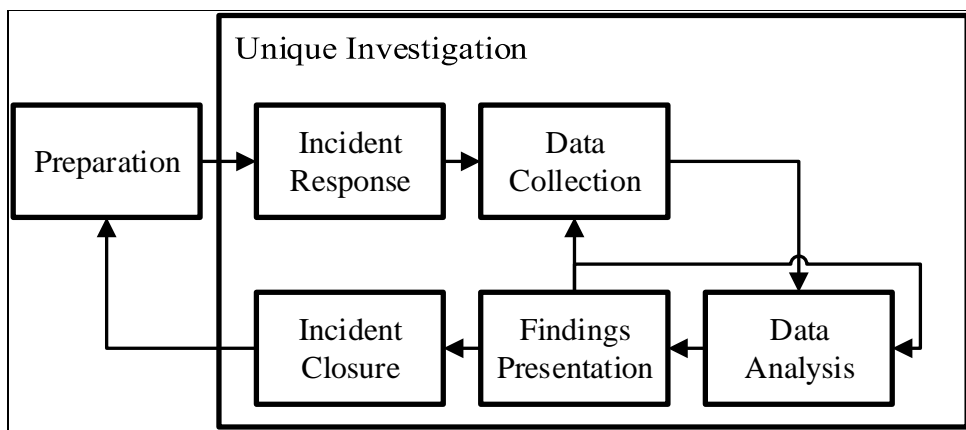

Figure 2 – Forensic Iteration Framework, Source: (Carrier and Spafford, 2004)

This model combines the procedures in securing digital evidence very well. It interrelates the preventive solutions of security incidents (Preparation), a response to an incident, data collection and follow-up data analysis. The analysis then provides data which must be interpreted and based on which the entire model of investigation may be modified.

The model (Carrier and Spafford, 2004) is then followed on with a procedural model of investigation on a higher level, which groups individual steps into phases. The advantage of the model is that it includes the phase of formulation of work hypotheses that are then verified. An example is provided in following Fig. 3.

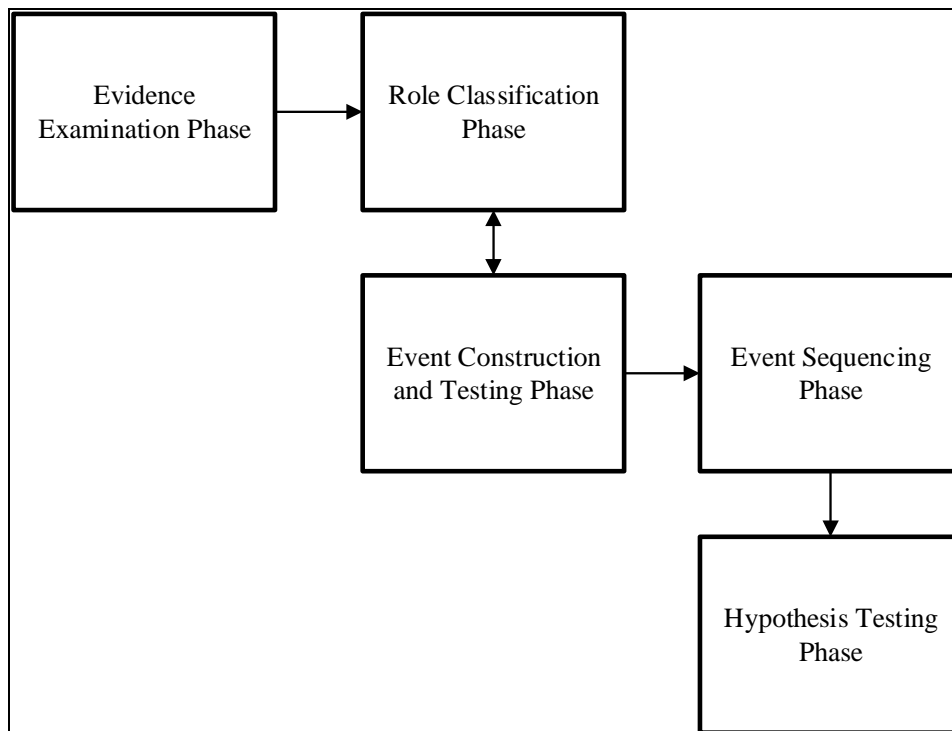

Figure 3 – Event Reconstruction Phases, Source: (Beebe and Clark, 2005)

The disadvantage of the model is that it does not include feedback allowing its permanent improvement and perfection, based e.g. on the ideas of the PDCA method. This is why the model is used more for *one-off application* rather than for *systematic investigation management*.

The area keeps developing and there are attempts for its standardization not only on the part of scientific workplaces (Beebe and Clark, 2005; Carrier and Spafford, 2004) but also on the part of ISO organizations. However, the majority of these publications mainly focuses on how **state authorities (the police)**, which most often conduct such investigations, should proceed.

2 STATEMENT OF PROBLEM

As the value and quantity of stored digital data keep growing, so does the risk that someone will try to make such data unavailable, to steal them or to tamper with them. For example surveys (Filkins, 2013; Villatte, 2015) present the most common threats to corporate security. A fairly large part of these incidents is currently illegal; however, their investigation and proving are usually not very successful. Moreover, there will always be incidents which are not punished by law yet disturb the running of an organization, and even these incidents must be

investigated and possibly punished. This concerns mainly misdeeds against in-house standards and regulations of a certain economic entity.

In this article, we focus on the procedures **in in-house investigations within an organization**. It concerns mainly misdeeds¹ that can be proven by forensic investigation. A thus defined area includes a relatively large number of misdeeds that may not be just of a “cybernetic” nature, but their traces are available in digital form and their consistent and correct analysis can provide necessary evidence proving such misdeeds. The investigation of different incidents can also be a part of an audit (Svatá, 2012).

We present general process (procedures) – that an organization should follow in order to obtain valid evidence from digital traces to prove incidents that violate the regulations of an organization. We also present how the process of digital investigation should be integrated into the organization.

We would like to point out that we will focus on the Czech Republic; however, our proposed recommendations should also apply to a large part of the European Union that already has a partly unified law as to working with information. We assume that the organizations, which are planning to implement our presented recommendations, already have an existing and functioning security management system, e.g. based on the recommendations of the family of standards ISO 27000. Furthermore, we would like to point out that our presented procedures are not designed for obtaining audiovisual evidence. To obtain audiovisual evidence, it may require using other procedures and techniques.

3 METHODOLOGY

Standardization in this area has been already tackled in (Hykš and Koliš, 2014; Veber and Klíma, 2014); however, the creation of a unified and comprehensive methodology requires more than that, it mostly requires a thorough analysis of the already existing models (Beebe and Clark, 2005; Bulbul, Yavuzcan and Ozel, 2013; Carrier and Spafford, 2004; Jeong, 2006; ISO, 2015a) together with the analysis of the law of the Czech Republic and the EU. In creating the model, we also included information received from experts who collect evidence in expert and police practice in the Czech Republic. Thanks to this, we were able to create a model that tries to take into consideration the recommendations from the models already presented in the past, including the model presented as part of ISO 27000. Our proposed model especially takes into account both the law of the Czech Republic and the specifics of investigation in an organization.

¹ This term is understood to mean any conduct that violates law or the in-house policies (regulations) of an organization.

4 RESULTS

In order to conduct a successful digital investigation, it is necessary to:

- detect/recognize an incident and,
- record sufficient data about the incident.

If an organization already have an incident management in place (Forte, 2007; ISO, 2011b; Mitropoulos, Patsos and Douligeris, 2006; Susanto, Almunawar and Tuan, 2011) it should be easy to detect and recognize an incident. If we do not recognize, or recognize late, such an event, we obviously cannot start a successful investigation.

The second necessity is to have *sufficient recorded data* about the event (incident). If we know that the incident occurred, but we do not have a sufficient quantity of recorded data about such an event, it will be difficult not only to identify the culprit but also to collect sufficient evidence to prove the investigated incident in order to achieve this goal it is necessary to focus a bit more on incident preparation phase.

Digital investigation process should be included as a process related to the incident management process. The conceptual incorporation of digital investigation in incident management is shown in Fig. 4.

Not until an incident (misdeed) is processed and sufficient information about the incident is collected can we start an actual investigation and use the methodology proposed by us. Of course, all this applies if it is necessary/appropriate to investigate the incident and to try to identify the culprit and to prove his misdeed.

However, before we start discussing the actual investigation, it is necessary to determine who will conduct the investigation, which depends on the seriousness of the misdeed. Let's divide misdeeds into three categories, depending on who is responsible for their investigation. Let's point out that the categories are mutually exclusive and therefore, if we are not sure, we should choose the category of a more serious misdeed. The categories are as follows:

- crime,
- civil dispute,
- violation of directives/policies of an organization.

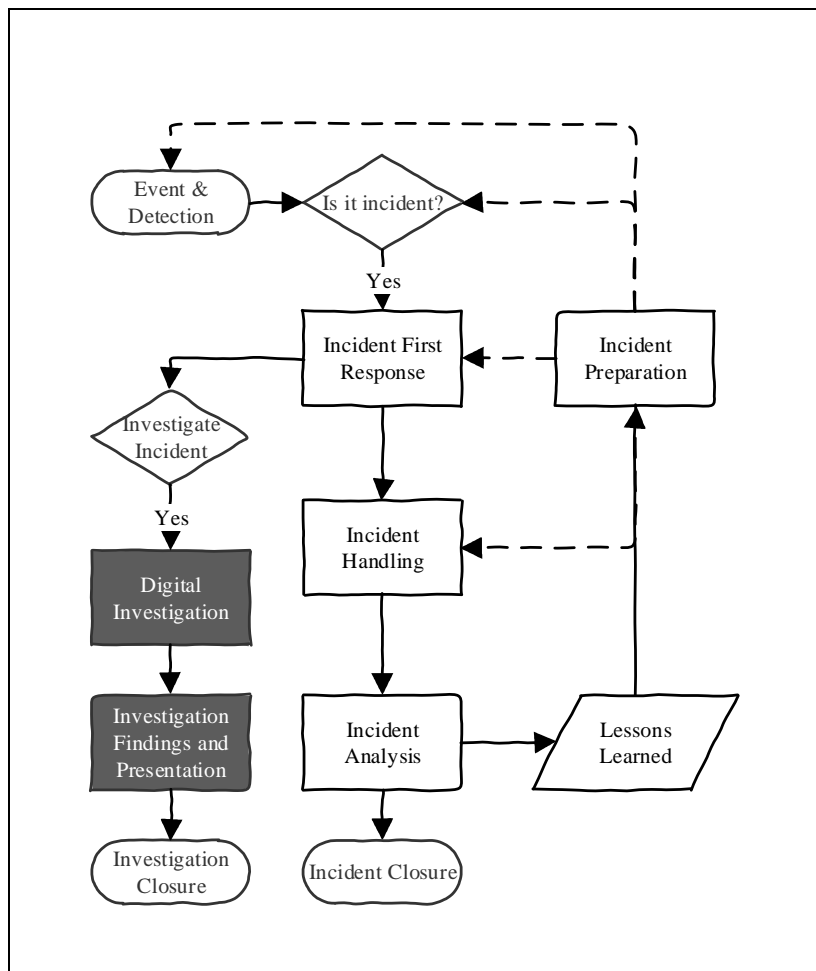

Figure – 4 Overall Event Handling Scheme, Source: (Authors)

The misdeeds, which fall under the crime category, are punished pursuant to the Penal Code and very often result in a considerable damage (over 5,000 CZK) or a grievous bodily injury. Evidence concerning a crime is collected by the police and the crime must be proven in court by the investigating authority. In such a case, an organization will only provide sufficient data and information to the police who will collect, process (analyze), store and interpret such data. Let's also mention that this kind of investigation is free of charge because police is funded by the state.

The misdeeds, which fall under the civil dispute category, are also resolved in court, but do not fall under the crime category (and for this reason they will not be investigated by the police). However, evidence used in court must be of legal value and for this reason, digital evidence must be prepared by a court expert. In such a case, if an organization wants to win the assumed civil dispute, it must hire a court expert experienced in digital investigation and provide him with

sufficient data/information for obtaining sufficient evidence. The hired court expert is then responsible for investigation.

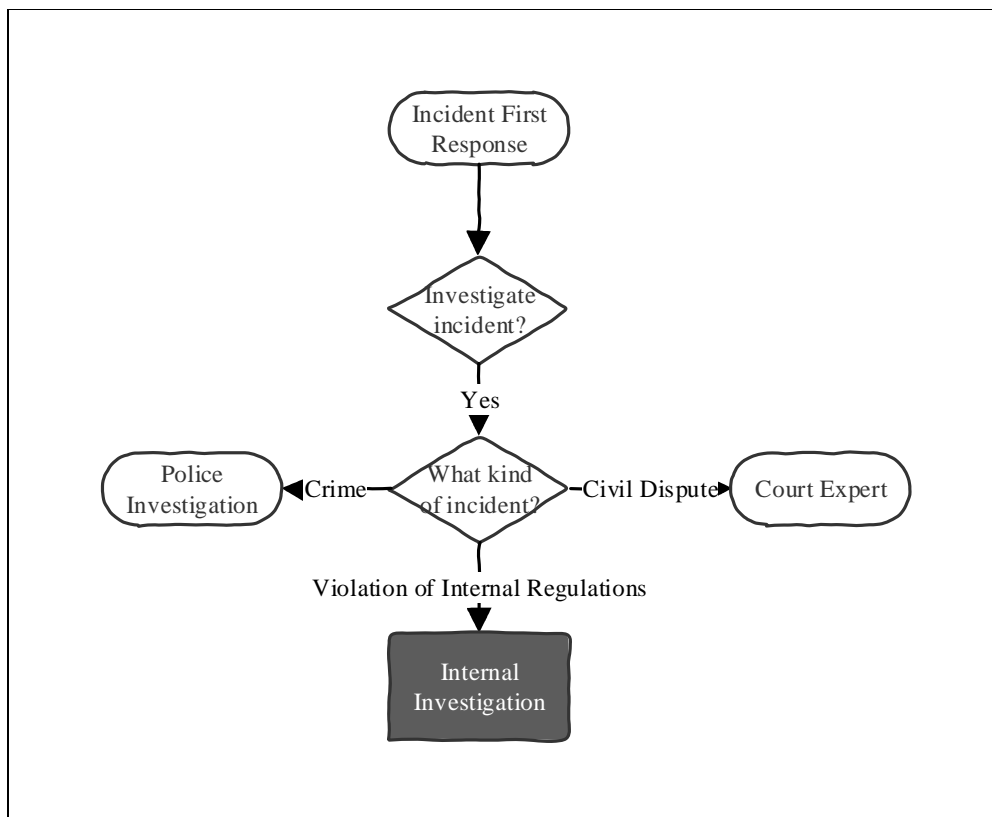

Figure 5 – Decision on the investigation procedure, Source: (Authors)

The last possibility is that a misdeed, which does not fall under any of the previous categories but violates directives/policies of an organization, and the organization management wishes to investigate it in order to find the culprit and prove his misdeed. In such a case, it is possible to use internal resources of the organization to investigate the entire matter. However, even in this case, an investigation should be conducted, using standard investigation methods. This is not only because it is necessary to prove the authenticity of obtained evidence to all parties involved, but also because there is a rather big risk that this misdeed will end up in court.

The initial investigation phase including incident detection and investigation decisions is demonstrated in Fig. 5.

In-house Investigation

Rules that cannot be neglected

An entire in-house investigation must be conducted in a very similar (same) way as the investigation of the police or a court expert. The main reason is the

provability and indisputability of obtained digital evidence for all parties involved, especially for the aggrieved party and the culprit. For this reason, the investigation process must observe the following requirements:

- Repeatability.
- Auditability.
- Justifiability.

Repeatability is understood to mean that an investigator, who obtained certain evidence, should be able to reach such evidence repeatedly, using documented procedures.

Auditability is understood to mean that the investigation procedures and results should be verifiable by any independent authorized party. For this reason, original data must always be available and must be recorded, and any procedure and method of data handling must be documented.

Justifiability is understood to mean that an investigator should be able to defend his actions and procedures. To defend is understood to mean to prove that the selected procedures and methods are the best way to obtain all possible pieces of evidence.

Personal Activities and Responsibilities

Digital investigation is strongly linked to incident management thus it is also possible that persons responsible for incident resolution may also do the digital investigation. In such case, the incident is resolved with regard to possible further investigation, and then followed by the actual search for digital evidence.

Despite sharing the responsibilities for incident management and investigation may suit smaller organizations it is certainly better to introduce two distinguish groups of employees, where both are responsible for the incident preparation phase, but as soon as security incident occurs, one group is responsible for incident resolution and the other for digital investigation, because it allows both processes to run simultaneously.

Overview of the entire investigation procedure

An investigation can be described as a sequence of consecutive steps, even though some steps can occur concurrently. First of all, let's visualize the entire investigation as described in Fig. 6.

The initial phase has already been described above (Fig. 5). During this phase it is necessary to make several decisions, including the most important one, i.e. whether or not to investigate the problem/misdeed. Not until it is decided to investigate will the entire process of investigation start. During this phase, it must be also decided about who will conduct the investigation.

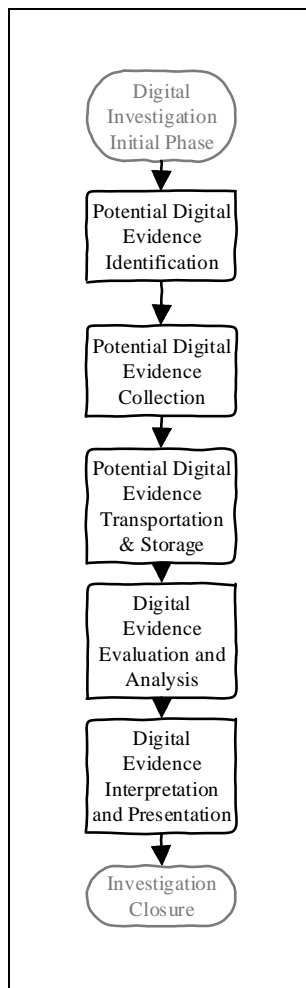

Figure 6 – Detailed investigation process, Source: (Authors)

During the **digital evidence identification** phase, it is necessary to arrive at the place where digital evidence will be collected. The place should be first documented (with photographs, if possible). After that it is necessary to find out what can contain digital evidence, i.e. what must be collected/acquired during investigation. Digital traces are most often found in devices that are able to store data in digital form. Such devices include all types of computers (PC, telephones, tablets,...), different portable data storage devices (flash disks, optical disks, self-contained hard disks,...) as well as other digital devices containing potentially important information (network elements, different built-in devices, ...). Certain information related to the investigation can be hidden as a note on a piece of paper – these are often passwords, schemes or other information important for the investigation and for this reason, the entire investigated place should be thoroughly searched. If the investigation is conducted in an organization, it is very important that an investigator mainly focuses on whether or not a device

relates to the case – the publications (Leigland and Krings 2004; Beebe and Clark 2005) can be helpful here.

The phase of **collection of potential digital evidence** is illustrated in Fig. 7. During this phase, an investigator will evaluate whether or not it is possible to obtain digital traces from a device and how. In the case that an investigator secures data (binary image), he must right away also produce image hashes and document them. The entire data collection should be documented, i.e. which devices were identified in the previous phase, which devices were secured and from where, who secured them and how. During this phase, an *impartial person* should participate in the investigation and confirm by signing the secured digital traces report that the traces were secured in a standard way and that the obtained hash sums are authentic.

During the phase of **transport and storage of potential digital evidence**, an investigator must mostly make sure that potential digital evidence will not be modified or damaged, i.e. that nobody could tamper with them. He must also protect them from damage by different natural and other forces. During the transport phase as well, it is better that the secured devices (if any) be supervised (in addition to an investigator) by an impartial person. Secured data and data in secured devices should be kept for at least half a year after the case is closed.

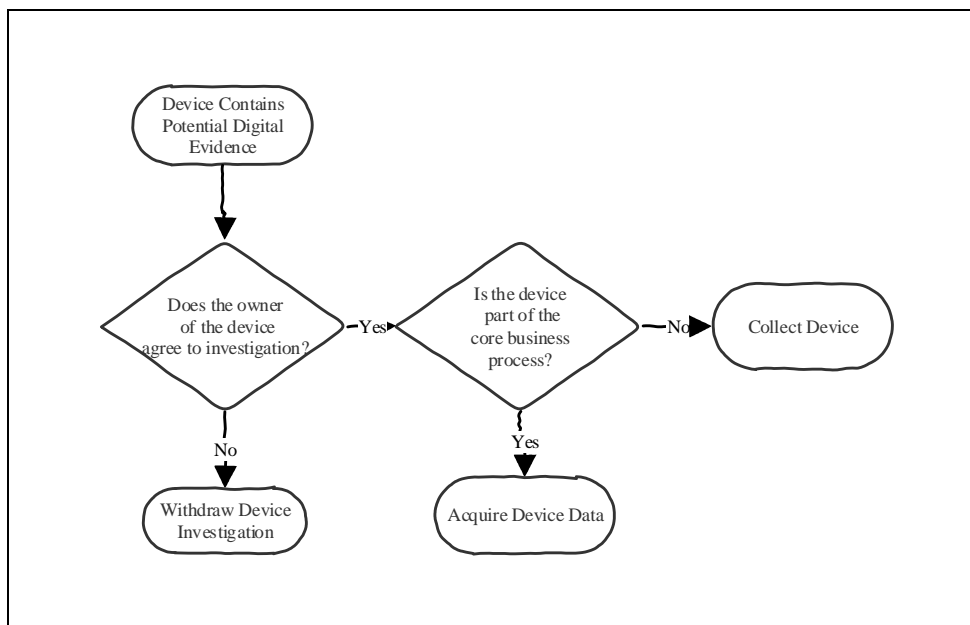

Figure 7 – Detailed potential digital evidence collection, Source: (Authors)

During the phase of **evaluation and analysis of potential digital evidence**, a search for evidence with respect to the given case is conducted. If devices were secured, the first task of an analyst is to obtain data (image) containing digital traces from such devices. Again, an impartial person should be present during this task and confirm (by signing the report) that the data were obtained from

secured devices and that hash sums above obtained data correspond. During this phase, it is possible to use different tools searching for strings or other information in the data. The tools that should be used are very well described e.g. in (Arasteh et al., 2007; Leigland and Krings, 2004; Srihari and Leedham, 2003); the use of valid methods is formalized e.g. in the international standard ISO/IEC 27042 (ISO, 2015b). An investigator should never work with original data, only with a copy or a copy of a copy, mainly so that the secured original data would not be damaged. Also, an investigator usually does not run any programs with secured data (except when programs are analysed, but even then, they must be run in an isolated environment – a sandbox).

During the phase of **interpretation and presentation of results**, the task of an investigator is to present the conclusions of his own investigation to third parties. An investigator must be able to clearly interpret and present investigation results to all parties involved. An investigator must be able to support his conclusions with obtained evidence and to prove that he obtained such evidence by means of his own documented procedures.

The closing of investigation is the last phase of investigation. The investigation reaches this phase when all parties agree with the conclusions and consequences of investigation.

5 COMPARISON TO EXISTING MODELS

Previous models (Beebe and Clark, 2005; Bulbul, Yavuzcan and Ozel, 2013; Carrier and Spafford, 2004; Jeong, 2006; ISO, 2015a) were focused on investigation itself - led by forensic experts or the police. We did not change the model for investigation itself, we think it is well developed; however, it is not that easy to fit it to business processes of the organization. We considered basic ideas of existing models for forensic investigation and we have added steps, needs and options of the environment within the organization. This means that our model should be easy to deploy in the organization.

We have also used charts based on business process notation making the process of digital investigation well understandable also for the top management of the organization. There is also a chart (Fig. 5) that should help with the most important decision (of the process) whether to start the internal investigation and who should be responsible for it.

Presented process model introduces the base for the *systematic investigation management* in the company led by its employees considering all the requirements of professional investigation.

6 CONCLUSIONS

This article presents a simple framework that can be used in investigating misdeeds in an organization after a security event or incident occurred. Using this presented framework should help organizations to implement digital investigation process. It is designated for public and state administration organizations as well as for the private sector. It is not designated for the investigating bodies of courts, experts or expert institutions. In view of the used legislation, the proposed procedure is primarily designated for organizations in the Czech Republic and is based on the conceptual chart shown in Fig. 6. The steps in the chart are progressively analyzed and their main activities are specified. The model is currently being tested in Czech practice in cooperation with the company RAC, s.r.o.

ACKNOWLEDGEMENTS

This paper describes the outcome of a research that has been accomplished as a part of research program funded by University of Economics, Prague IGA 74/2014 Innovation management system of digital forensics laboratories.

REFERENCES

- Arasteh, A.R., Debbabi, M., Sakha, A. and Saleh, M., 2007. Analyzing multiple logs for forensic evidence. *Digital Investigation*, 4, September, pp.82–91.
- Beebe, N.L. and Clark, J.G., 2005. A hierarchical, objectives-based framework for the digital investigations process. *Digital Investigation*, 2(2), pp. 147–167.
- Bulbul, H.I., Yavuzcan, H.G. and Ozel, M., 2013. Digital forensics: An Analytical Crime Scene Procedure Model (ACSPM). *Forensic science international*, 233(1-3), pp.244–256.
- Carrier, B. and Spafford, E.H., 2004. An event-based digital forensic investigation framework, In: *Proceedings of the 2004 digital forensic research workshop (DFRWS)*. Baltimore, Maryland , 11-13August, 2004.
- Filkins, B., 2013. *The SANS 2013 Help Desk Security and Privacy Survey*. SANS Institute.
- Forte, D., 2007. Security standardization in incident management: the ITIL approach. *Network Security*, 2007(1), pp.14–16.
- Hykš, O. and Koliš, K., 2014. Development of the Digital Forensic Laboratory Management System Using ISO 9001 and ISO/IEC 17025. In. *IDIMT – Interdisciplinary Information Management Talks*. Linz: Trauner Verlag, pp.87-94.

Ieong, R.S., 2006. FORZA–Digital forensics investigation framework that incorporate legal issues. *Digital Investigation*, 3, September, pp.29–36.

ISO, 2011a. ISO/IEC 27005:2011, *Information technology – Security Techniques – Information security risk management*. International Organization for Standardization, Geneva, Switzerland.

ISO, 2011b. ISO/IEC 27035:2011, *Information technology – Security techniques – Information security incident management*. International Organization for Standardization, Geneva, Switzerland.

ISO, 2015a. ISO/IEC 27043:2015 *Information technology – Security techniques – Incident investigation principles and processes*. International Organization for Standardization, Geneva, Switzerland.

ISO, 2015b. ISO/IEC 27042:2015 *Information technology – Security techniques – Guidelines for the analysis and interpretation of digital evidence*. International Organization for Standardization, Geneva, Switzerland.

Leigland, R. and Krings, A.W., 2004. A formalization of digital forensics. *International Journal of Digital Evidence*, 3(2), pp.1–32.

Mitropoulos, S., Patsos, D. and Douligeris, C., 2006. On Incident Handling and Response: A state-of-the-art approach. *Computers and Security*, 25(5), pp.351–370.

Srihari, S.N., Leedham, G., 2003. A survey of computer methods in forensic document examination, In: *Proceedings of the 11th Conference of the International Graphonomics Society (IGS2003)*, Scottsdale, Arizona, USA, 2-5 November 2003, pp.278–282.

Susanto, H., Almunawar, M.N. and Tuan, Y.C., 2011. Information security management system standards: A comparative study of the big five. *International Journal of Electrical & Computer Sciences*, 11(05), pp.23–29.

Svatá, V., 2012. *Audit informačního systému*. Vyd. 2. Praha: Professional Publishing.

Veber, J. and Klíma, T., 2014. Influence of Standards ISO 27000 Family on Digital Evidence Analysis, In. *IDIMT – Interdisciplinary Information Management Talks*. Linz: Trauner Verlag, pp.103–114.

Villatte, N., 2015. *2015 Data Breach Investigations Report*. Verizon Enterprise Solutions.

Webster, F., 1994. What Information Society? *The Information Society*, 10(1), pp.1-23.

Zachman, J., 2002. The zachman framework for enterprise architecture. *Zachman International*.

ABOUT THE AUTHORS

Ing. **Jaromír Veber**, Ph.D. is the academic staff at the Department of System Analysis at University of Economics, Prague, Czech Republic. His main research and development work is specifically focused on the IS/ICT security management and cloud services, e-mail: jaromir.veber2@vse.cz

Mgr. **Lea Nedomová** has been working as assistant professor of the Department of System Analysis at the Faculty of Informatics and Statistics at the University of Economics, Prague, Czech Republic since 1996. Her main research and development topics include system approach to global society, sustainable development and its relation integrated management, e-mail: nedomova@vse.cz

Prof. **Petr Doucek**, Ph.D. heads the Department of System Analysis at University of Economics, Prague, Czech Republic. His main research and development work is focused on information management, IS/ICT security management, project management and impacts of information society on human and economy, e-mail:doucek@vse.cz

Lean Service Implementation Success Factors in Polish District Heating Companies

DOI: 10.12776/QIP.V20I1.640

Krystyna Lisiecka, Iwona Burka

Received 17 November 2015, Revised 10 April 2016, Accepted 25 May 2016

ABSTRACT

Purpose: The aim of this study was to assess the validity of the factors which have influence on the Lean Service (LS) principles implementation process that serves to improve the organization and economics of district heating companies operating on the Polish market.

Methodology: Diagnostic survey carried out in the selected trade industries.

Findings: Assessing the significance of the effective LS principles implementation factors, which serves to improve the functioning of district heating companies, has revealed the most important factor, which is – according to the respondents – a focus on minimizing waste in processes. Several waste groups were identified and distinguished. They are for example: waste resulting from the employees passive behaviors, unused creativity of employees, unnecessary motion. Answering the question asked in the title of the paper – according to the research - you can ascertain that the effective LS conception principles implementation success factors are, in particular: the involvement of management in process improvement, staff attitude to minimize waste in processes. The research resulted in the formulation of conclusions, one of which says that an effective remedy for the organization members passive behaviors can be Lean Behaviours.

Originality: This is a first unique study on the topic of the Lean Service implementation success factors in the heat engineering. The achieved results can be useful for district heating companies as a guidance to improve management systems in those organizations.

Category: Research paper

Keywords: factors; district heating; Lean Behaviours; Lean Service; waste

1 INTRODUCTION

The aim of the study was to present relevant, important Lean service (LS) implementation success factors and evaluation of their importance in the process of implementing this conception for improving the organization and the economics of district heating companies operating on the Polish market.

The authors have adopted the following research hypothesis: the greatest importance for improving the functioning of district heating companies to minimize wastage identified in the processes of heat transfer is the attitude and behaviour of management and employees.

In the study the diagnostic survey was applied, which is the data collection method to collect information about multiple objects research based on answers to the same questions given by specific group of people (Nachnias and Frankfort-Nachmias, 2001). The study used purposeful sampling, one of the types of non-probability selection (Babbie, 2004). Purposeful selection of cases to study allows to choose the cases in terms of their usefulness. The criteria for selection of the sample to diagnostic survey was to possess a legal license for heat transmission and distribution (condition of doing business in the heat transmission and distribution) and membership to the Polish District Heating Chamber of Commerce (IGCP).

2 LEAN SERVICE AS A CONCEPTION OF MANAGEMENT IN SERVICE ORGANIZATIONS

In developed countries there has been a dynamic development of the service sector (Kawa, 2010). Here you can include for example: IT services, telecommunications, call centers, medical etc. These countries are in the third period of economic development, post-industrial, in which economic situation is still growing and the economic activity was moved to a post-industrial service sector, where employment was about 75% of the workers (Waters, 2001). In 2000, in Poland the share of services in employment exceeded 50% and since then it has been steadily increasing. In the first quarter of 2014 employment in services was 57.6% of total employment (Rynekpracy.org, 2015).

The modern level of proportions of products and services is 40/60 (Sobanska, 2010). Services are therefore development area, according to Bicheno (2008).

The basic assumptions of LS conception in service organizations, such as: determining the value, identifying value streams, flow, pulling and striving for perfection have similar applications to manufacturing organizations. Service organizations, like manufacturing, have in their processes certain repetitive tasks. The principles of the conception, as defined by Allway and Corbett (2002), have been stolen and appropriated by service organizations in the form of Lean Service.

Lean service organization is not just an application of LS conception, properly matched to the type of its activities, but also a set of behaviors conducive to minimizing waste. Graphical representation of the elements influencing the creation of a Lean organization is shown in Figure 1.

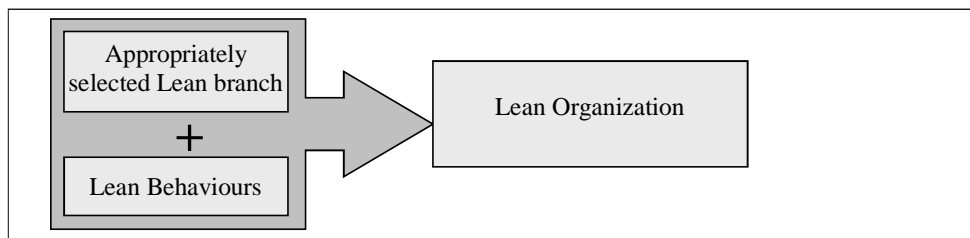

Figure 1 – Elements influencing the formation of a Lean organization
 Source (Benjamin, 2013)

The conception of lean management in the organization focuses on waste reduction and removing or minimizing the variability in the processes too. Variability is inherent in the implementation of individual operations/activities. According to Gliatis, Minis and Lavasa (2008) variability is strongly linked with errors and failures; affects their level. Quoted authors described the effect of failures and errors on the functioning of lean service organization, concluding that it is important to implement appropriate setbacks management strategies.

Most of the publications in the field of Lean refers to the mapping value streams in processes where activities are repeated. Due to the wide range of service processes it is difficult to believe that any of the types of service processes can be mapped in the same way; that one type of map can be applied to describe each process. In his book "The Lean Toolbox for Service Systems" J. Bicheno described other ways of mapping the value stream adequate to service processes. He distinguished four types of service processes, which depend on the following parameters (Bicheno, 2008): the involvement of the customer and the repetition of steps in the process (from the perspective of the service provider). Each of the types of service processes was assigned with the right kind of value streams map.

Implementations of Lean in service sectors generate a lot of effects. Service sectors in which there were numerous implementations of the Lean principles and have been described in the literature are, inter alia: the banking sector and the health service (Burgess and Radnor, 2012). Implementations meet favorable conditions: they help to improve the quality of its services, significantly shorten the time of the service (by reducing the steps in the process as well as unnecessary downtime and waiting), increase level of service quality by avoiding foreseeable errors, reduce costs of service (less consumption of resources and better design processes), increase employee motivation and job satisfaction, and increase customer satisfaction (Fillingham, 2007; Radnor and Boaden, 2008; Bowen and Youngdahl, 1998; Youngdahl, 1998; Hummer and Daccarett, 2009). In the LS approach the customer takes the first place. Teehan and Tucker (2010)

write about the need to listen to "the voice of the customer", an important process in defining the value of the product and its requirements. LS is the process of creating value in service organizations, which supports listening to the "voice of the customer". It is also an innovation process comprising both, evolution and revolution, which is connected to the distribution decision-making "down" of the processes. Womack and Jones (2010) formulated six indications inducing customers to think. These are: "Fix my problem as a whole. Do not waste my time. You give me exactly what I want. Deliver value where I want. Fix my problem when I want. Give me a solution, which I actually want."

LS is characterized by the versatility. Implementation in areas such as healthcare (Burgess and Radnor, 2013; Fillingham, 2007; Burgess and Radnor, 2012; Hummer and Daccarett, 2009), banking (Mojarana and Morelli; 2012), education (Emiliani, 2004), insurance (Hammer, 2004), consulting (Ball and Maleyeff, 2003), finance (Piercy and Rich, 2009), fast food restaurants (Womack and Jones, 2010), public administration (Suarez-Barraza, Smith and Dahlgaard-Park, 2009), legal services (Hines, Martins and Beale, 2008), information technology (Brandt, 2012; Womack and Jones, 2010), airline (Bowen and Youngdahl, 1998) or telephone information services – call centers (Piercy and Rich, 2009; Teehan and Tucker, 2010) show the universality of the conception, which, according to the processes in which it is implemented, is called different names. In Figure 2, an attempt was made to present fields of application of lean management concept and "pillars of the tree" (roots) where the roots are continuous improvement and common sense.

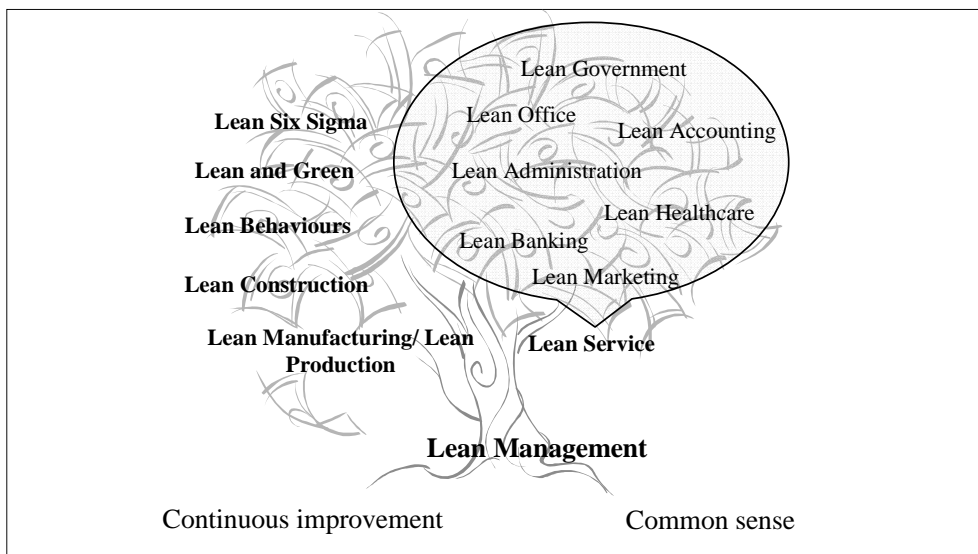

Figure 2 – Lean tree

Source: own study on the basis of (Lisiecka and Burka, 2011; Lisiecka and Burka, 2013)

Many service systems are systems in which subsequent processes are carried out on the basis of pull (Maleyeff, 2006). This is due to the fact that several tasks are initiated by the client.

Spear and Bowen (1999) proposed a framework for constructing a system based on the principles of Lean and identified four rules:

- 1) steps must be highly standardized (in terms of deadlines, timeout, sequences of actions, results and conditions for customer satisfaction),
- 2) each contact (communication) between the internal customers (in both directions) should be direct and unambiguous manner,
- 3) the flow of each product and service should be direct,
- 4) improving of the production processes structure must be perfectly designed and carefully thought over.

They are only conceptual framework. This means that you can not treat them as a guide for implementation, but they can be useful when building a lean management systems in service environment, including the internal services in the production organizations.

There are four categories of internal systems containing intra-organizational service processes (Maleyeff, 2006):

- systems that provide support for the functioning of human resources,
- systems that in the first place focus on serving external customers,
- systems that provide the technical support of the organization,
- systems that provide business support (mainly financial and reporting).

In the processes of their effective improvement you can be supported by the conception of LS.

3 LEAN SERVICE IMPLEMENTATION SUCCESS FACTORS IN LIGHT OF THE LITERATURE

Cultural and social implementation Japanese management conceptions factors are described in literature, in comparison with other cultures (Aluchna and Ploszajski, 2008; Liker and Hoseus, 2008; Womack, Jones and Roos, 1990; Mann, 2005; Shook, 2010; Bhasin, 2013; Vermaak, 2008; Jakonis, 2011). The authors drew a synthetic list of the factors placing them in defined groups as shown below (Table 1). The list included those factors that recurred in the analyzed sources and where their validity was raised by the authors.

Table 1 – Lean Service implementation success factors

Group of factors	Lean Service implementation success factors transmission in the Polish district heating companies
Financial	The need to minimize costs
	Focus on minimizing waste in the processes
	The introduction of close, long-term cooperation and partnership in relations with suppliers
Cultural	The desire to change the philosophy of the organization (targeting at the elimination of waste)
	The introduction of transparency within the organization
Connected with Human Resources	Employees discipline in implementing new solutions
	The employees' work involvement
	Teamwork
	Employee development – improving their competences
Managerial	Management commitment to the process improvement
	Changing the managers work orientation from overseeing to the continuous improvement process
	Changing the management way (from a task to process)
	Changing the mentality of managers (from the "governance" to the partnership and constructive workers support)
	Current problems analyzing, their sources and developing improvements
	The elimination of the so-called "Management from beyond the desk"
Organizational	Aiming at the development of a learning organization
	The introduction of competitions and awards system, motivating employees (promoting improvements and innovation proposals)
	Change and "flattening" of the organizational structure (from the most frequently used formal structure on the process one)
	Transfer of responsibility and decision-making to lower levels of the organization
	The introduction of visual management (use of visualization tables, graphs)
Process	The introduction of standardized work
	The need to simplify processes, reduce complexity
Environmental	Focus on minimizing waste (environmental) generation
	Focus on reducing the consumption of energy used for processes

Source: (Vermaak, 2008; Radnor *et al.*, 2006; Aluchna and Ploszajski, 2008; Liker and Hoseus, 2008; Womack *et al.*, 1990; Mann, 2005; Shook, 2010; Walentynowicz, 2011)

The table distinguished groups of factors such as financial, cultural, organizational, managerial, process, environmental and the latter relating to the personnel management (HRM), process and environmental.

4 BARRIERS TO IMPLEMENTATION IN PRACTICE OF THE PRINCIPLES OF LS DISTRICT HEATING COMPANIES

To assess the level of implementation LS to practice one should be aware of the factors impeding its implementation. In literature the results of research on barriers related to the introduction of the LS to the organization were rarely made public. Suarez-Barraza and Ramis-Pujol (2010) made attempts to research the factors limiting the implementation of the principles of lean management in service processes of public organizations in Mexico. They are specified a few of them:

- classic bureaucratic system of organization, creating your own "farm",
- the impact of trade unions, which are not interested in change (or negligible),
- opposition of workers to the changes, especially if they are related to prohibit someone "power" gained on the approval of the trade unions,
- lack of professional training in Lean and Kaizen,
- lack of credibility – such implementations are often treated as transient whim of the chief executive officer or something imposed on the employees,
- additional regulations that may block workers thinking about improving provided services,
- opposition to the implementation of measurement processes,
- lack of strong Lean management connection with human resources.

The above-mentioned factors inhibiting the implementation of Lean in service environment are "universal", they are found in almost every country.

Having done the research in the heating sector enterprises in Poland, it turned out that the above-mentioned factors inhibiting the implementation of Lean in a service environment are also present in the surveyed organizations in Poland; this confirms their "universal" character.

Respondents representing the interests of district heating companies in Poland during the case study research, preceding the analyzed diagnosis of research, as factors possible to appear and impeding the successful implementation of Lean, pointed the following factors:

- lack of management commitment,
- opposition of workers to the changes,
- regulations,
- lack of understanding on the part of employees, associated with ignorance of the LS rules,
- trade unions,
- the reluctance of managers to delegate powers (empowerment),
- lack of interest on the part of chief executives in minimizing the costs (in connection with heat pricing regulations),
- concerns about the introduction of transparency within the organization,
- reluctance to teamwork among older, experienced workers,
- management "behind the desk".

The listed factors apply when implementing Lean principles in services environment. The above table shows the importance of management involvement in making changes in the organization, the need to change management philosophy, closely related to organizational culture in the researched enterprises and focus on building organizational learning.

5 EVALUATION OF IMPORTANCE OF THE LS CONCEPTION PRINCIPLES IMPLEMENTATION TO IMPROVE THE FUNCTIONING OF SERVICE DISTRICT HEATING COMPANIES

Implementation of a new management conception in organizations entails the need to meet specific, characteristic conditions of the conception and taking into consideration the circumstances affecting the success associated with its implementation.

In this paper purposeful sampling was used. The criteria for selection of the sample to diagnostic survey were to possess a legal license for heat transmission and distribution (condition for doing business in the heat transmission and distribution) and membership in the Polish District Heating Chamber of Commerce (IGCP).

At the beginning of the year 2013 four hundred and five organizations had a license for the transmission and distribution of heat and 258 organizations and individuals were actively participating in IGCP. The questionnaires were distributed to 225 district heating companies that met the conditions given. The study was conducted in the last quarter of 2013. Thirty nine questionnaires were

received back, which accounted for 17.33%. One questionnaire was filled in part, that is why the questions that had not been filled were excluded from the research.

At the survey authors asked for identifying the importance of individual lean management implementation factors. Respondents evaluated, on a scale of 1 to 5, the importance of conditions for improving the functioning of the organization, where 0 indicated that the condition did not apply. The results are presented in Table 2 and 3, and in Figure 3 and 4. The analysis classified thirty eight questionnaires. In one of the surveys the question about factors was not answered.

In terms of assessing the significance of individual factors for improving the functioning of the organization it was assumed that obtaining the following results indicated the following groups of meanings:

- 0 – factor does not matter,
- 0.01-1.99 – factor has little importance,
- 2-2.99 – importance of the factor rated as average,
- 3-5 – factor is important.

Table 2 – Lean Service conception successful implementation factors

The factor importance for improving the functioning of the organization		LS conception successful implementation factors – number of replies													
Factor does not matter	0	The need to minimize costs	0	0	0	0	0	0	0	0	0	0	0	0	4
Assessment of the factor importance: 1	1	Focus on minimizing waste in the processes	0	0	0	0	4	0	0	0	0	0	0	0	4
Assessment of the factor importance: 2	3	The introduction of close, long-term cooperation and partnership in relations with suppliers	4	8	0	0	0	4	0	0	0	0	0	0	8
Assessment of the factor importance: 3	4	The desire to change the philosophy of the organization (targeting at the elimination of waste)	1	0	0	17	0	4	4	4	4	4	4	13	4
Assessment of the factor importance: 4	9	The introduction of transparency within the organization	9	9	5	26	14	0	9	4	4	4	21	14	
Assessment of the factor importance: 5	21	Employees discipline in implementing new solutions	21	24	12	16	8	16	8	16	16	16	20	4	4
Total	38	The employees' work involvement	38	38	38	38	38	38	38	38	38	38	38	38	38
		Teamwork													
		Employee development – improving their competences													
		Management commitment to the process improvement													
		Changing the managers work orientation from overseeing to the continuous improvement process													
		Changing the management way (from a task to process)													

The factor importance for improving the functioning of the organization		LS conception successful implementation factors – number of replies													
		Factor does not matter	Assessment of the factor importance: 1	Assessment of the factor importance: 2	Assessment of the factor importance: 3	Assessment of the factor importance: 4	Assessment of the factor importance: 5	Total	Factor does not matter	Assessment of the factor importance: 1	Assessment of the factor importance: 2	Assessment of the factor importance: 3	Assessment of the factor importance: 4	Assessment of the factor importance: 5	Total
	Changing the mentality of managers (from the "governance" to the partnership and constructive workers support)	0	0	0	0	0	0	0	0	0	0	0	0	0	0
	The elimination of the so-called "Management from beyond the desk"	0	0	0	0	0	0	0	0	0	0	0	0	0	0
	Aiming at the development of a learning organization	0	0	0	0	0	0	0	0	0	0	0	0	0	0
	The introduction of competitions and awards system, motivating employees (promoting	0	0	0	0	0	0	0	0	0	0	0	0	0	0
	Change and "flattening" of the organizational structure	0	8	4	5	4	13	9	8	16	4	16	15	24	
	Transfer of responsibility and decision-making to lower levels of the organization	0	4	4	4	1	13	9	8	16	4	16	15	24	
	The introduction of visual management (use of visualization tables, graphs)	0	4	4	4	1	13	9	8	16	4	16	15	24	
	The introduction of standardized work	4	8	0	0	0	12	9	8	16	4	16	15	24	
	Current problems analyzing, their sources and developing improvements	0	0	0	0	0	0	0	0	0	0	0	0	0	
	The need to simplify processes, reduce complexity	0	8	0	0	0	8	9	8	16	4	16	15	24	
	Focus on minimizing waste (environmental) generation	0	0	0	0	0	0	0	0	0	0	0	0	0	
	Focus on reducing the consumption of energy used for processes	0	0	0	0	0	0	0	0	0	0	0	0	0	
Total		38	38	38	38	38	38	38	38	38	38	38	38	38	

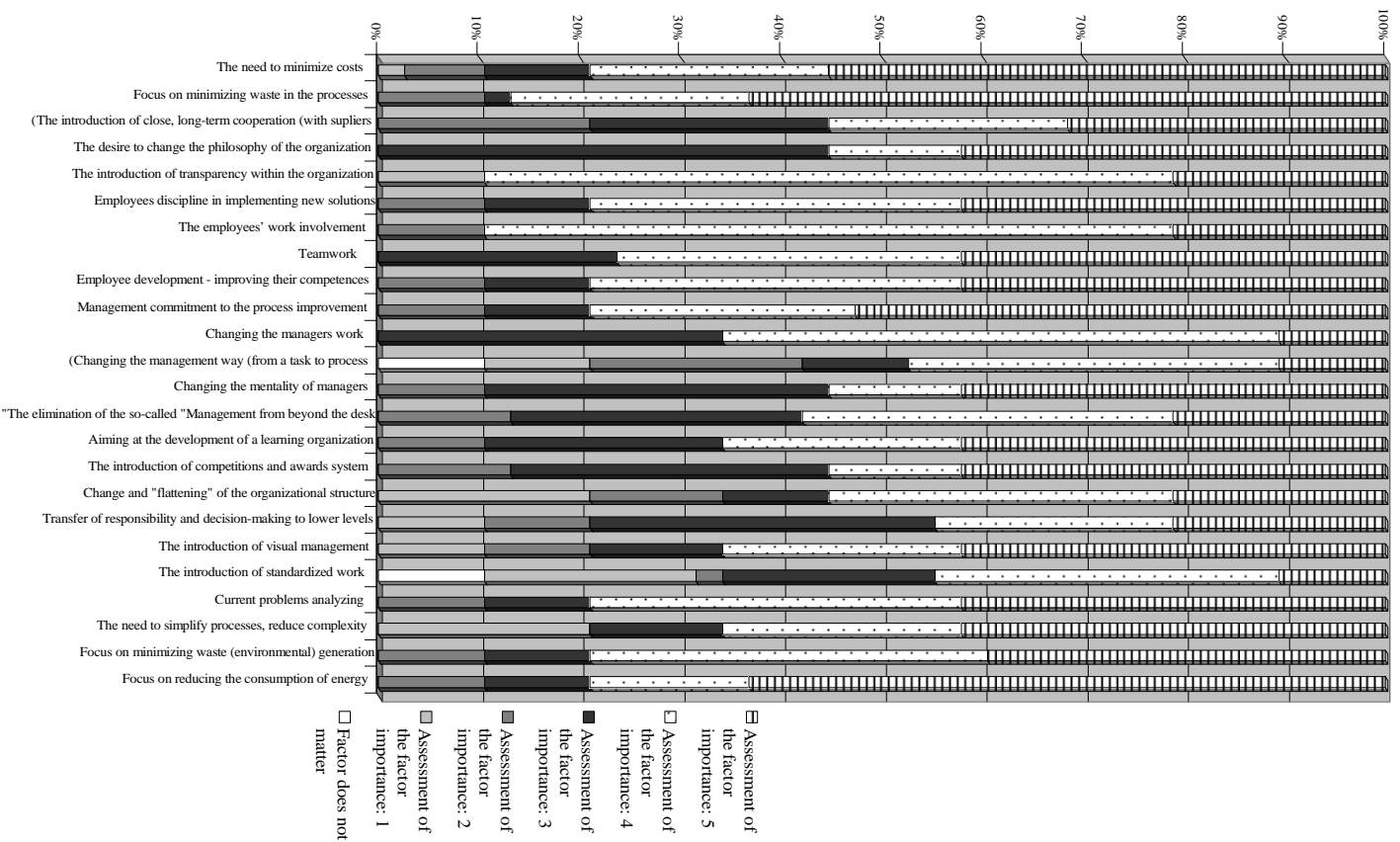

Figure 3 – LS conception successful implementation factors - the percentage of ratings (Source: own study based on the survey results)

Table 3 – LS conception successful implementation factors – the average assessment and evaluation of current significance of a given factor

The factor importance for improving the functioning of the organization			LS conception successful implementation factors - number of replies
Evaluation of current significance of a factor	Average assessment of the factor relevance		
factor is important	4.21	The need to minimize costs	
factor is important	4.39	Focus on minimizing waste in the processes	
factor is important	3.66	The introduction of close, long-term cooperation and partnership in relations with suppliers	
factor is important	3.97	The desire to change the philosophy of the organization (targeting at the elimination of waste)	
factor is important	3.89	The introduction of transparency within the organization	
factor is important	4.11	Employees discipline in implementing new solutions	
factor is important	4.00	The employees' work involvement	
factor is important	4.18	Teamwork	
factor is important	4.11	Employee development - improving their competences	
factor is important	4.21	Management commitment to the process improvement	
factor is important	3.76	Changing the managers work orientation from overseeing to the continuous improvement process	
importance of the factor rated as average	2.84	Changing the management way (from a task to process)	

The factor importance for improving the functioning of the organization		LS conception successful implementation factors – number of replies
Average assessment of the factor relevance	Evaluation of current significance of a factor	
3.87	factor is important	Changing the mentality of managers (from the "governance" to the partnership and constructive workers support)
3.66	factor is important	The elimination of the so-called "Management from beyond the desk"
3.97	factor is important	Aiming at the development of a learning organization
3.84	factor is important	The introduction of competitions and awards system, motivating employees (promoting improvements and innovation proposals)
3.21	factor is important	Change and "flattening" of the organizational structure (from the most frequently used formal structure on the process one)
3.34	factor is important	Transfer of responsibility and decision-making to lower levels of the organization
3.76	factor is important	The introduction of visual management (use of visualization tables, graphs)
2.79	importance of the factor rated as average	The introduction of standardized work
4.00	factor is important	Current problems analyzing, their sources and developing improvements
3.66	factor is important	The need to simplify processes, reduce complexity
4.08	factor is important	Focus on minimizing waste (environmental) generation
4.32	factor is important	Focus on reducing the consumption of energy used for processes

Source: own study based on the survey results

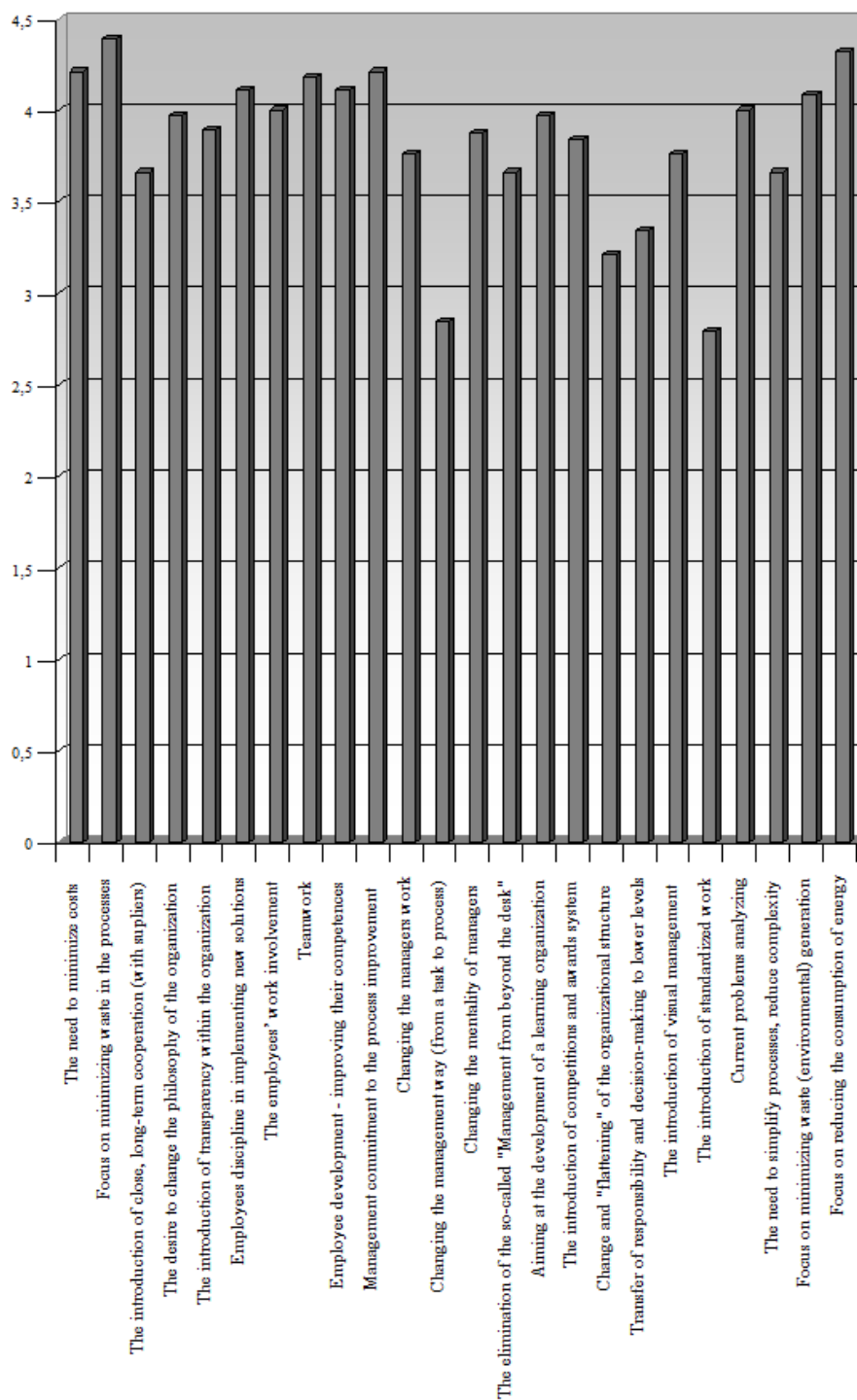

Figure 4 – Lean Service conception successful implementation factors - the average assessment (Source: own study based on the survey results)

The averaged results obtained from the survey were analyzed. The analysis found that:

- there were no cases in which the factor is not relevant to the organization,
- there were no cases of minor factor importance for the organization,
- there were only two cases in which a factor has an average importance to the organization (changing the management way from a task to process and the introduction of standardized work),
- other factors were rated by respondents as having great importance for the organization.

The analysis of the LS implementation success factors importance in district heating companies also showed that:

- the analyzed issues are important to district heating companies,
- important LS implementation success factors for the organizations are: focus on minimizing waste in processes, attitudes to reduce energy consumption used for processes, the need to minimize costs and teamwork.

District heating companies highly value the importance of each factor. Awareness of the importance of each factor is a good symptom of organizational maturity level. These organizations therefore have a good chance of successful implementation of Lean principles. It was assumed that, if 80% of the factors for the studied organizations are of great importance, it means that the surveyed companies meet the conditions for effective lean conception principles implementation. 83% score was obtained.

For the tested organizations the most important factor of effective LS conception principles implementation is the attitude of staff and management to minimize waste in the processes.

Representatives of the organizations, including line employees and middle management, were also asked to estimate the intensity of types of waste appearing in their organizations. Rating 0 applies to cases where the type of waste does not occur. If, in the respondent opinion, the type of waste occurs, it was assessed according to a scale from 1 to 5, where 1 refers to the lowest intensity of incidence, and 5 to maximum (relatively to other types of waste).

In the assessment of the intensity of the occurrence of particular groups of waste it was accepted that obtaining the following results means degrees of intensity as follows:

- 0 - waste is not present,
- 0.01-1.99 - waste presents in small quantities,
- 2-2.99 - the average amount of waste is presented,
- 3-5 - there is a large amount of waste (remedial action is needed).

The results of the study are presented in Table 4 and Figure 5.

Table 4 – Waste in the surveyed organizations

The intensity of the waste occurrence	Waste in the surveyed organizations											
	Waste is not present	Assessment of occurrence - 1	Assessment of occurrence - 2	Assessment of occurrence - 3	Assessment of occurrence - 4	Assessment of occurrence - 5	Total	The average rate of occurrence	waste ratings	the average amount of waste is presented	the average amount of waste is presented	waste presents in small quantities
	8	4	4	12	0	4	38	2.00	Overproduction			
	4	9	9	16	4	0	38	2.18	Expectation			
	4	17	9	4	10	0	38	1.66	Unnecessary transportation			
	12	4	10	12	8	0	38	1.58	Excessive or incorrect processing			
	0	13	17	8	0	4	38	1.87	Excessive inventories			
	0	16	6	8	4	4	38	2.32	Unnecessary movement			
	0	4	13	13	8	0	38	1.66	Defects			
	0	12	5	13	13	0	38	2.45	Unused creativity of employees			
	8	13	13	4	0	0	38	1.34	Loss of quality			
	4	9	25	0	0	0	38	1.55	Waste in accounting processes			
	4	8	13	5	8	0	38	2.13	Data waste			
	0	8	17	13	0	0	38	2.13	Waste in the office processes			
	12	4	6	12	4	0	38	1.79	Waste of managers' time			
	0	16	2	8	8	4	38	2.53	Waste resulting from employees passive behaviors			
	12	9	5	12	0	0	38	1.45	Waste associated with "backwardness" of technology			

Source: own study based on the survey results

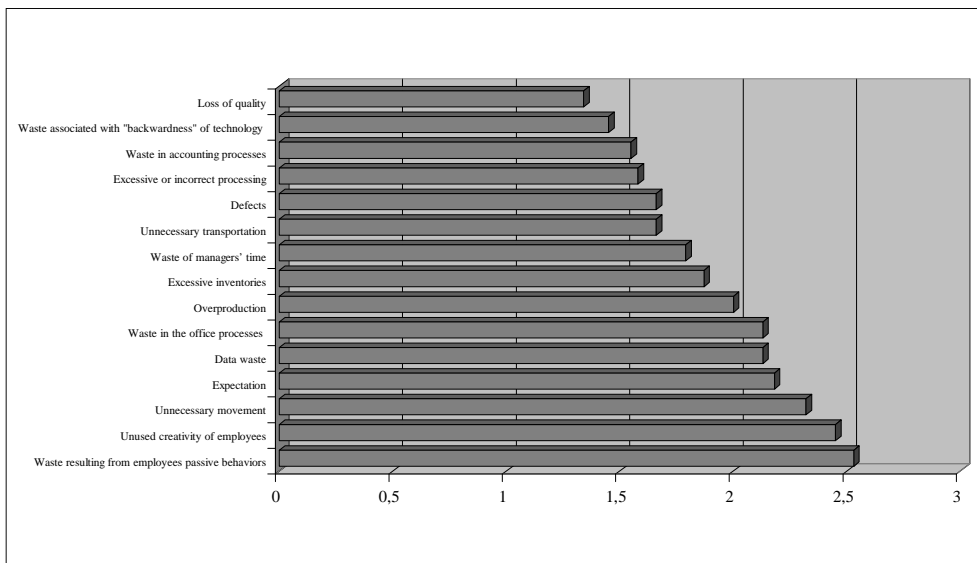

Figure 5 – Waste in the surveyed organizations - the average ratings
 Source: own study based on the survey results

Authors analyzed the averaged results obtained from the survey. The analysis found that:

- there were no cases where a particular type of waste did not occur at all,
- there were no cases of large amounts of waste,
- the occurrence of waste in the average amount was indicated by the respondents for the following groups: overproduction, waiting, unnecessary motion, unused employee creativity, data waste, waste office processes and waste resulting from employees passive behaviours.

Above analysis also shows that:

- in the surveyed organizations the potential for certain types of waste was assessed as low, which may indicate poor awareness of employees in defining the types, sources and seeking ways to minimize waste,
- the most troublesome type of waste, according to the respondents (the highest intensity of appearance) is a waste resulting from passive behaviours of employees and unused employee creativity,
- according to respondents in organizations they represent the least it is the waste associated with loss of quality; interesting enough is the fact that the possibility of waste associated with technological “backwardness” is also assessed as low; that contradicts the claim, widely accepted and propagated by the industries, that in the heating, both heat sources and heating networks are largely obsolete.

During the study the respondents were also asked to answer the open question about another kind of waste that may occur in the tested organization. None of the companies respond to this question.

6 CONCLUSIONS FROM THE STUDY. SUGGESTIONS FOR FURTHER RESEARCH

As a result of the study authors evaluated the intensity of particular groups of waste in the surveyed organizations. They identified and distinguished several groups of waste. They are: waste resulting from passive employees behaviors, the unused creativity of employees, unnecessary motion, waiting, waste in the office processes, data and information waste, overproduction, excessive inventories, a waste of managers' time, defects (including errors in the processes of heat transfer), unnecessary transportation, excessive or incorrect processing, waste in accounting processes, waste associated with technological "backwardness" and losses caused by poor quality.

The conducted survey shows that the greatest importance for improving the functioning of district heating companies, according to respondents, is the attitude of employees and the management to minimize the waste identified in the processes of heat transfer. It is the passive attitude of staff, lack of commitment in the implementation process which can be one of the biggest sources of waste. It should therefore lead to further research projects on the implementation of Lean Behaviours in organizations (see Figure 6).

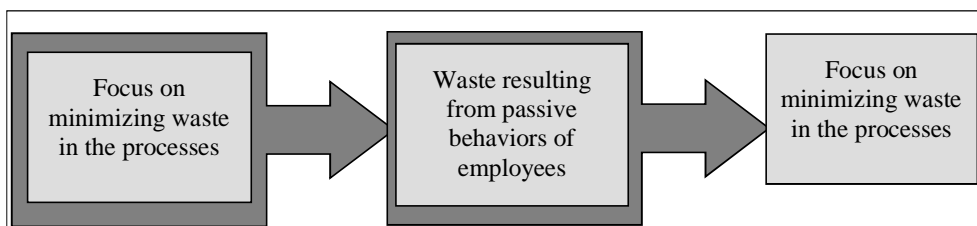

Figure 6 – Lean Behaviours in district heating company (Source: own study based on the survey results)

The term Lean Behaviours was first introduced by M.L. Emiliani. He compiled a list of forty-one anti-Lean or "Fat" conducive to the formation of wasteful behaviors stakeholders. They included, among others: irritation of shareholders, blind obedience, broken promises, unanswered talks, conflict, embarrassment, crisis management, delay in operation, destructive politics, disappointment employees, fluctuation of employees, elitism, intolerance of failure, favoritism, fear, low remuneration, secrets or too many procedures. He drew attention to combining tasks and behavioral work items, to build "healthy" work environments that influence the growth of productivity of the organization.

The study also helped define the barriers that have arisen in connection with the implementation of the principles of this conception in this type of enterprises. These barriers are largely related to the passive attitude of the members of the surveyed organizations, and mostly to the lack of management commitment. The evaluation of importance to the effective LS principles implementation to improve the functioning and service of district heating companies has allowed the emergence of the quintessential factor, which - according to the respondents - is the attitude to minimize waste in the processes.

7 SUMMARY

Human behavior can have positive and negative impact on value creation in the organization. It is important to choose not only employees with appropriate qualifications and experience, but also the ability to influence the elimination of waste in the processes.

In the light of the study can be concluded that the success factors of effective LS implementation principles are in particular: management' commitment to process improvement, the attitude of staff to minimize waste in processes to reduce energy consumption used for processes implementation, as well as to the need to minimize costs, teamwork and raising awareness of employees by investing in their competences.

REFERENCES

- Allway, M. and, Corbett S., 2002. Shifting to lean service: stealing a page from manufacturers' playbooks. *Journal of Organizational Excellence*, 21(2), pp.45-54.
- Aluchna, M. and Ploszajski P., 2008. *Zarządzanie japońskie. Ciągłość i zmiana* [Japanese management. Continuity and Change]. Warsaw: SGH
- Babbie, E., 2004. *Social research in practice*. Warsaw: Scientific Publishers PWN.
- Ball, D.R. and Maleyeff, J., 2003. Lean Management of Environmental Consulting. *Journal of management in engineering*, 1(17), pp.17-24.
- Benjamin, C.T., 2013. A Study of Behaviours that Retard the Implementation of Lean Operations. *The Journal of the Association of Professional Engineers of Trinidad and Tobago*, 41(1), pp.43-48.
- Bhasin, S., 2013. Impact of corporate culture on the adoption of the Lean principles. *International Journal of Lean Six Sigma*, 4(2), pp.118-140.
- Bicheno, J., 2008. *The Lean Toolbox for Service Systems*. PICSIE Books, Buckingham.

Bowen, D.E. and, Youngdahl, W.E., 1998. Lean service: in defense of a production-line approach. *International Journal of Service Industry Management*, 9(3), pp.207-225.

Brandt, D., 2012. A lean take on Edison's lab. *Industrial Engineer*, 44(3), pp.50-52.

Burgess, N. and, Radnor, Z., 2013. Evaluating Lean in healthcare. *International Journal of Health Care Quality Assurance*, 26(3), pp.220-235.

Burgess, N. and Radnor, Z.J., 2012. Service improvement in the English National health service: Complexities and tensions. *Journal of Management & Organization*, 18(5), pp.594-607.

Emiliani, M.L., 2004. Improving business school courses by applying lean principles and practices. *Quality Assurance in Education*, 12(4), pp.175-187.

Fillingham, D., 2007. Can Lean save lives. *Leadership in Health Services*, 20(4), pp.231-241.

Gliatis, V., Minis, I. and Lavasa, K.M., 2008. Assessing the impact of failures in service operations using experimental design with simulation. *International Journal of Quality & Reliability Management*, 30(1), pp.23-46.

Hammer, M., 2004. Deep change: how operational innovation can transform your company. *Harvard Business Review*, 82(4), pp.84-95.

Hines, P., Martins, A.L. and Beale, J., 2008. Testing the boundaries of lean thinking: observations from the legal public sector. *Public Money & Management*, 28(1), pp.35-40.

Hummer, J. and Daccarett, C., 2009. Improvement in Prescription Renewal Handling by Application of the Lean Process. *Nursing Economic\$,* 27(3), pp.197-201.

Jakonis, A., 2011. Kulturowe uwarunkowania Lean management [Cultural conditioning of Lean Management]. In: Trippner P., ed. 2011, Znaczenie mikro i makroprocesów w funkcjonowaniu i rozwoju systemu społeczno - ekonomicznego [The importance of micro and macro processes in the functioning and development of socio-economic system], *Przedsiębiorczość i zarządzanie*, XII(12), pp.29-56.

Kawa, M., 2010. Tendencje zmian zatrudnienia w sektorze usług w Polsce na tle krajów Unii Europejskiej, Available at: <http://www.ur.edu.pl/pliki/Zeszyt17/33.pdf>, [Accessed 12 April.04. 2015].

Liker, J.K. and Hoseus, M., 2008. *Toyota Kultura: The Heart and Soul of the Toyota Way*. Warsaw: MT Biznes.

Lisiecka, K. and Burka, I., 2011. Koncepcja Lean Management i kierunki jej rozwoju, *Problemy Jakości*, 2011(6), pp.18-25.

- Lisiecka, K. and Burka, I., 2013. O rodzajach marnotrawstwa w dorobku literatury nauk o zarządzaniu [The types of waste in the achievements of literature management sciences]. In: A. Bajdak, M. Nowak, A. Samborski, H. Zawadzki, eds. 2013, *Tendencje w zarządzaniu. Konteksty teoretyczne i rozważania praktyczne [Trends in management. Theoretical and practical considerations contexts]*. Katowice: Uniwersytet Ekonomiczny w Katowicach, pp.15-25.
- Maleyeff, J., 2006. Exploration of internal service systems using lean principles. *Management Decision*, 44(5), pp.674-689.
- Mann, D., 2005. *Creating a Lean Culture. Tools to Sustain Lean Conversion*. New York: Productivity Press.
- Mojarana, F. and Morelli, A., 2012. *Lean banking*. Cracow: Wydawnictwo M.
- Nachmias, D. and Frankfortr-Nachmias, Ch., 2001. *Metody badawcze w naukach społecznych [Research methods in social sciences]*. Poznan: Publisher Zysk i S-ka
- Piercy, N. and Rich, N., 2009. High quality and low cost: the lean service centre. *European Journal of Marketing*, 43(11/12), pp.1477-1497.
- Radnor, Z., Walley, P., Stephens, A. and Bucci, G., 2006. *Evaluation of the lean approach to business management and its use in the public sector*. Edinburgh: Scottish Executive Social Research.
- Radnor, Z.J. and Boaden, R., 2008. Lean in public services – Panacea or paradox? *Public Money and Management*, 28(1), pp.3–7.
- Rynekpracy.org, 2015. *Pracujący w rolnictwie, przemyśle i usługach*. [Online] Available at: <http://rynekpracy.org/x/989321> [Accessed 26 08 2015].
- Shook, J., 2010. How to change a culture: Lessons from NUMMI. *MITSloan Management Review*, 51(2), pp.62-68.
- Sobanska, I., 2010. *Rachunkowość zarządcza. Podejście operacyjne i strategiczne [Managerial Accounting. Operational and strategic approach]*. Warsaw: C.H. Beck
- Spear, S. and Bowen, H.K., 1999. Decoding the DNA of the Toyota production system. *Harvard Business Review*, 77(5), pp.96-106.
- Suarez-Barraza, M. F. and Ramis-Pujol, J., 2010. Implementation of Lean-Kaizen in the human resource service process. A case study in a Mexican public service organization. *Journal of Manufacturing Technology Management*, 21(3), pp.388-410.
- Suarez-Barraza, M.F., Smith, T. and Dahlgaard-Park, S.M., 2009. Lean-kaizen public service: an empirical approach in Spanish local governments. *The TQM Journal*, 21(2), pp.143-167.

Teehan, R. and Tucker, W., 2010. A simplified lean method to capture customer voice. *International Journal of Quality and Service Sciences*, 2(2), pp.175-188.

Vermaak, T.D., 2008. *Critical success factors for the implementation of Lean Thinking in South African manufacturing organization*, PhD. University of Johannesburg.

Walentyłowicz, P., 2011. *Determinanty sukcesu wdrażania szczupłej organizacji w przedsiębiorstwach w Polsce* [Determinants of successful implementation of lean organization in companies in Poland]. In: Nogalski, B., Wierzbicka, B., eds. 2011, *Systemowe aspekty zarządzania organizacjami* [Systemic aspects of organizational management]. Sopot: University of Gdansk.

Waters, D., 2001. *Operational management. Goods and services*. Warsaw: Scientific Publishers PWN.

Womack, J.P. and Jones, D.T., 2010. *Lean Solutions: How Companies and Customers Can Create Value and Wealth Together*. Wrocław: LEI Poland.

Womack, J.P., Jones, D.T. and Roos, D., 1990. *The machine that changed the world*. New York: Macmillan Publishing Company.

Youngdahl, W.E., 1998. Lean service: in defense of a production-line approach. *International Journal of Service Industry Management*, 9(3), pp.207-225.

ABOUT THE AUTHORS

Krystyna Lisiecka, Prof. PhD. – Professor of management sciences on the Faculty of Management at the University of Economics in Katowice. Lecturer, consultant, trainer and external lead auditor of Quality Management Systems. e-mail: krystyna.lisiecka@ue.katowice.pl. Postal address: ul. Bałtycka 42k, 47-778 Katowice, Poland.

Iwona Burka, PhD. – A specialist in heat engineering market, an internal auditor and a consultant in the field of quality and environmental management systems, lecturer and trainer. e-mail: iburka@poczta.onet.pl. Postal address: ul. Targowa 4, 43-430 Skoczów, Poland.

Legal Metrology and System for Calibration and Verification of the Radar Level Sensors

DOI: 10.12776/QIP.V20I1.694

Jaromír Markovič, Jozef Mihok, Stanislav Ďuriš, Zbyněk Schreier

Received 31 March 2016, Revised 26 May 2016, Accepted 17 June 2016

ABSTRACT

Purpose: The paper deals with the legal metrology that is principally responsible for assuring the uniformity and correctness of measurements and presents the results of the scientific and research work in the cross-disciplinary fields. The design of the new measuring system for the verification of the radar level gauges.

Methodology/Approach: The requirements on performing verification of the measuring instruments are changed significantly, especially the requirement for reducing the time necessary for putting the measuring instruments out of service. Slovak legal metrology (SLM) has developed a number of its own systems for verification of the legally controlled measuring instruments.

Findings: The paper presents the results of the research activities aimed to refine and improve metrological continuity and metrological control of selected types of measuring instruments.

Research Limitation/implication: This paper are based on the theoretical and practical knowledge from the field of metrology, the analysis of the legislative and normative requirements on the measuring instruments metrological assurance, and knowledge gathered during the practical performance of the measuring instruments metrological control.

Originality/Value of paper: In the paper, there are presented those results of solving the tasks in the research and development fields that lead to the higher measurement accuracy, and to the elimination of the undesired influences that may occur during a measurement.

Category: Technical paper

Keywords: legal metrology; measurement accuracy; radar level gauges; measuring instrument; uncertainty

1 INTRODUCTION

The legal metrology is the metrology applied in the practical life in order to assure the uniformity and correctness of measurements both on the national and international levels, creating thereby conditions for eliminating the technical barriers to trade and assuring the adequate protection of consumers. The legal metrology belongs to the technical regulations and requires for its operation a set of legislative and normative documents specifying the requirements on measurement procedures and measuring instruments. In the Slovak Republic, the basic terms for such a regulation are stipulated in the Act No. 142/2000 Coll. on metrology and in the implementing rule Decree No. 210/2000 Coll. on measuring instrument and metrological control. The Act on metrology specifies the legally controlled measuring instruments, that means the instruments used for measurements related with payments, health, security, property and environment protection that are liable to the mandatory metrological control before being put on the market, or in operation. Under the term the metrological control in operation (in use) the verification of the measuring instrument shall be understood that means the confirmation that its metrological characteristics are in compliance with the required metrological characteristics stipulated in the above mentioned Decree (Zgodavova and Slimak, 2008; Zgodavova, 2010). The radar level gauges also belong to the group of the legally controlled measuring instruments. They are used in the industry in relation with the storage of liquid and loose materials (Liberman, 2012). The verification and calibration of these level gauges are the subject matter of the present article, in which the current status of the measuring systems for the level gauges control is described, including the description of the new designed equipment that contributes to reduce the impact of the measuring system arrangement on the measurement result.

2 EQUIPMENT FOR THE CALIBRATION AND VERIFICATION OF THE RADAR LEVEL GAUGES

In case of the automatic level gauges, two principles of the level height measurement are used: the contact and the non-contact ones. In case of the contact method, the liquid level height sensor is usually the float being in contact with the measured medium, while the float is immersed into the medium completely or partially. The non-contact (electronic) way of measurement uses the principle of the electromagnetic waves radiation and their reflection from the measured medium. Thanks to the progress in the field of electronics, the non-contact method becomes even more currently used – nowadays, we may observe the increase in number of non-contact level gauges, especially the radar ones (Oréans and Heide, 2000). The radar level gauges not only prove the good metrological properties, but they show a number of practical advantages as well, such as safety, absence of any movable mechanical parts, and their capability to function under the adverse environmental conditions (fog, high temperature, high pressure, aggressive ambient conditions). The initiative to develop a measuring

system for the calibration and verification of the radar level gauges came from their manufacturers and suppliers themselves (Třebuňa, 2014; Pekarčíková, 2014; Popovič, 2015). The automatic level gauges are rather often used also for measurements related with payment purposes, as the legally controlled measuring instruments under the Act on metrology (Motzer, 2000).

2.1 Physical principle

The radar level sensors are based on two operating principles: the pulse radar sensor (TOF – Time of Flight) and the frequency modulated radar sensor (FMCW – Frequency Modulated Continuous Wave).

Pulse radar sensor

The basis for the distance determination is the measurement of the signal transition path time. The short clusters (so called packets) of the electromagnetic pulses of some milli or nanoseconds are sent by the transmitter, they bounce off the measured material, return back and are caught by the receiver. The number of waves and pulses times depend on the transmission frequency. The time delay of the transmitted packets is relatively long, enough for catching their reflection by the receiver. The time difference t_d between the transmitted and received pulse is equal to the time that the signal needs to pass the distance from the transmitter to the measured material and back, i.e. double of the measured distance. The measured distance L is continuously calculated using the formula:

$$L = \frac{c \cdot t_d}{2} \quad (1)$$

where c is the speed of the electromagnetic waves propagation (see Fig. 1) (Burenin, Pakov and Sizikov, 1998; Gu et al., 2014).

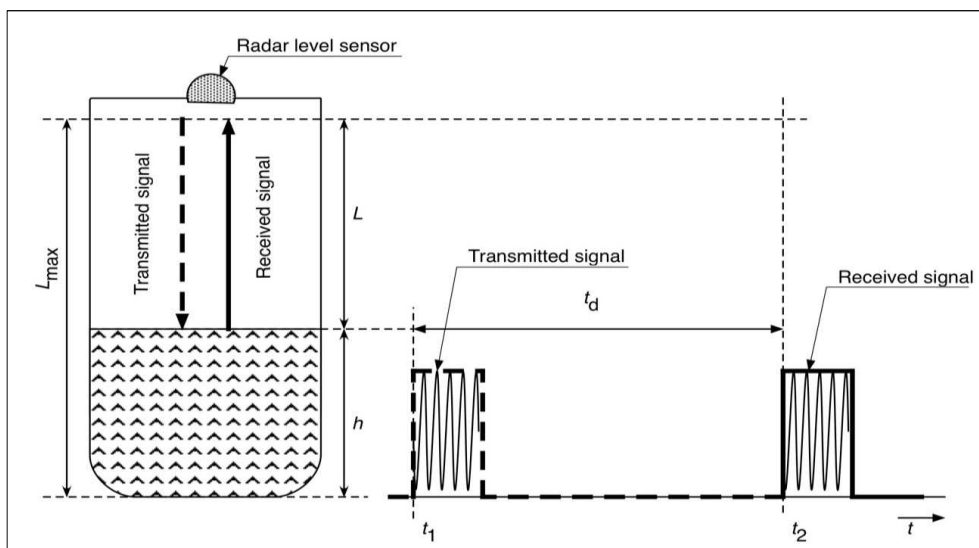

Figure 1 – Operating principle of TOF radar level sensor

Frequency (FMCW) radar sensor

The frequency modulated signal is transmitted continuously towards the measured object. The time slope of the transmitted frequency is linear and usually it has the saw-toothed shape. The reflected and received signal is compared with the transmitted signal, while the frequency difference f_d is measured corresponding to the time difference t_d for the calculation of the measured distance L . The frequency difference may be measured very precisely, and therefore also the measured distance may be determined with a high accuracy (see Fig. 2) (Kim and Lee, 2012; Wang et al., 2013; Mikuš and Hart'anský, 2013; Mikuš, Hart'anský and Čičáková, 2014).

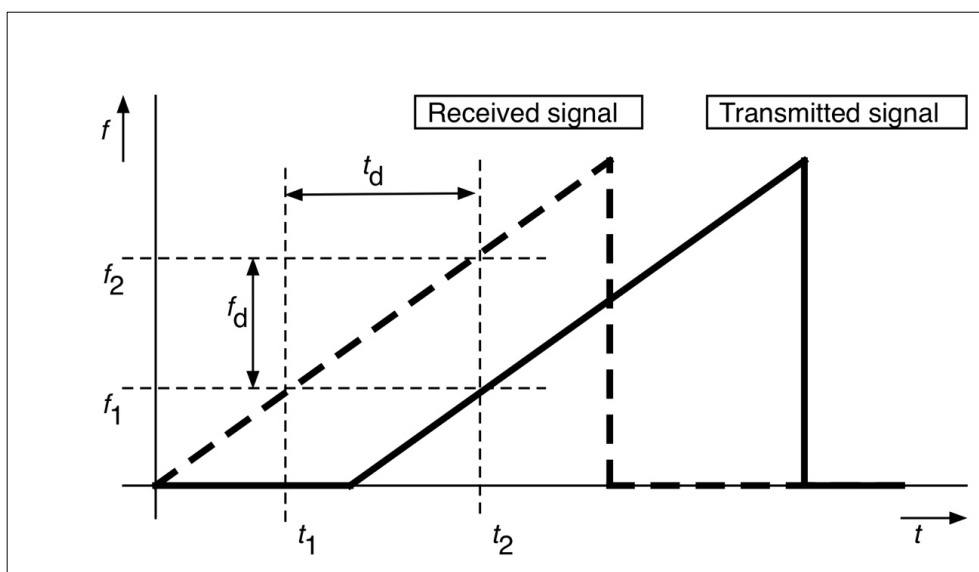

Figure 2 – Operating principle of FMCW radar level sensor

2.2 Legislative and normative requirements

When designing the above mentioned measuring system, the requirements of Decree No. 210/2000 Coll, Annex No. 68 "Automatic level gauges" on measuring instruments and metrological control were taken into consideration specifying both the requirements on maximum permissible error and methods of the level gauges verification. In addition, the design observes also the requirements of the International recommendation of OIML R 85 (Palenčár and Halaj, 1999; Palenčár, Kureková and Halaj, 2007).

2.3 Principle of operation and description of realized measurement systems

The operational principle of the original measuring system is based on the simulating the change of level using the reflection board - its distance from the calibrated/verified level gauge is measured by the laser interferometer

(Michalecki, 2001; Wei, Xu and Ma, 2013). For the scheme of the realized measuring system for the level gauges calibration see Fig. 3. The reflection board (2) is mounted on the linear guide runner (1) of the total length of 16 m. The angle of the reflection board may be set in two axes - vertical and horizontal - so it is set perpendicularly to the axis of the verified level gauge (4). The linear displacement of the reflection board is assured horizontally. The tested level gauge (4) is placed on the measurement table over which the standard - the laser interferometer is mounted (3) (Kim and Nguyen, 2003). The axes of the both devices shall be precisely aligned before the measurement, as any misalignment causes the cosine error of measurement. The precise appliances were prepared for fixing the measuring instruments (Mikuš, Harťanský and Smieško, 2016).

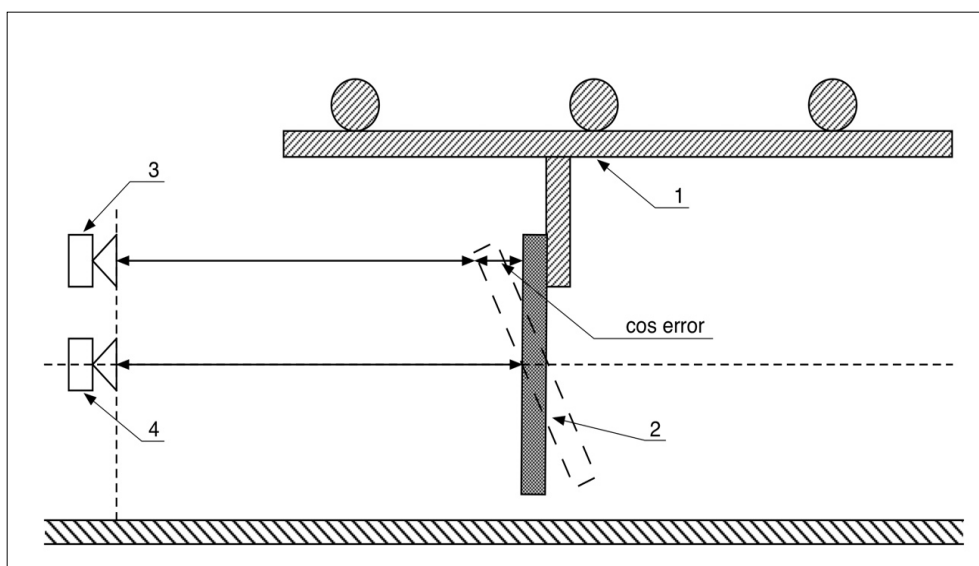

Figure 3 – Scheme of the original measurement system for calibration and verification of level gauges

In order to eliminate the cosine error, the new arrangement of the measuring system was designed. Therefore, in the new system, the interferometer is placed behind the reflection board; so its radiated beam is aligned with the radiated beam of the electromagnetic wave of the radar level gauge. This arrangement is shown in the Fig. 4.

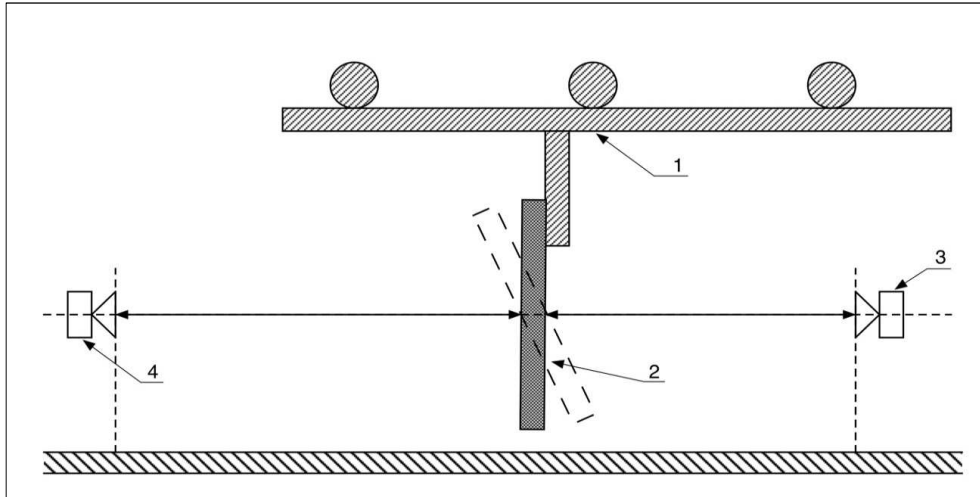

Figure 4 – Scheme of the new measurement system for calibration and verification of level gauges

Reviewing the benefits of the new arrangement of measuring system

In order to assess the new arrangement, the measurements before and after the adaptation of the measuring system were performed. The measurements were carried out within the length from 2 m up to 10.5 m in steps of 0.5 m so that the equal measurements conditions were assured. The measured results are recorded in the chart (see Fig. 5).

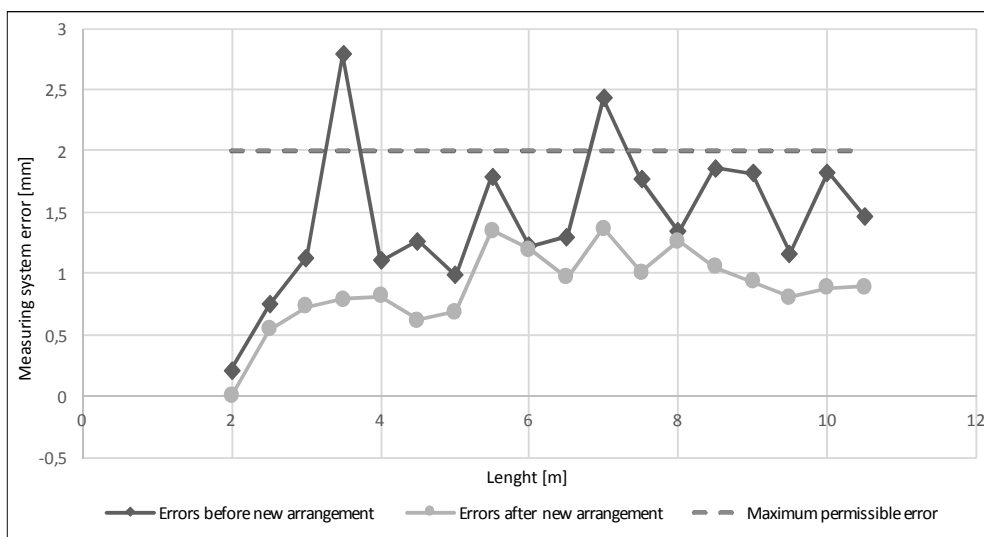

Figure 5 – Comparison of the measured values

The chart of the measured values shows clearly that the new arrangement of the measuring system resulted in the decreased influence of the cosine error on the measurement result.

3 CONCLUSION

The radar method of the level measurements is getting under the spotlight still more and more; nevertheless the main obstacle for putting the respective legally controlled measuring instruments on the market up to now was the insufficient metrological assurance of the radar level gauges. The necessity to solve this situation resulted in the development of the new measuring equipment construction. However, this equipment had some gaps due to the cosine error. The new arrangement of the measuring system eliminated this default so that the error contribution caused by the original arrangement was decreased.

The use of the developed equipment will not be limited only to the radar level gauges, but it will enable to calibrate and verify also the level gauges operating on different measurement principles.

ACKNOWLEDGMENTS

This article was created by implementation of the grant project VEGA 1/0708/16 "Development of a new research methods for simulation, assessment, evaluation and quantification of advanced methods of production".

REFERENCES

- Burenin, P.V., Pakov, S.V. and Sizikov, O.K., 1998. Reducing the measurement error of pulse-radar level gauges for bulk media. *Measurement Techniques*, 41(6), pp. 533-535, ISSN 05431972.
- Gu, C., Xu, W., Wang, G., Inoue, T., Rice, J.A., Ran, L. and Li, C., 2014. Noncontact Large-Scale Displacement Tracking: Doppler Radar for Water Level Gauging. *IEEE Microwave and Wireless Components Letters*, 24(12), pp.899-901; DOI: 10.1109/LMWC.2014.2352852.
- Kim, S.D. and Lee, J.H., 2012. A new transmitted-reference FMCW-UWB radar for gasoline tank level gauge. *Proceedings of the 2012 International Conference on Image Processing, Computer Vision, and Pattern Recognition, IPCV 2012*. 2, pp.1171-1174. ISBN: 978-160132225-8, Available at. https://www.researchgate.net/publication/290573100_A_new_transmitted-reference_FMCW-UWB_radar_for_gasoline_tank_level_gauge
- Kim, S. and Nguyen, C., 2003. A displacement measurement technique using millimeter-wave interferometry (2003). *IEEE Transactions on Microwave Theory and Techniques*, 51(6), pp.1724-1728. DOI: 10.1109/TMTT.2003.812575.
- Lieberman, V.V., 2012. Level measurement using radar level gauges. *Automation and Remote Control*, 73(3), pp.566-574, ISSN 00051179 DOI: 10.1134/S0005117912030149.

Michalecki, G., 2001. Automatic calibration of gauge blocks measured by optical interferometry. *Measurement Science Review*, 1(1), pp.93-96. Available at: <http://www.measurement.sk/Papers3/Michalec.pdf>

Mikuš, P. and Harťanský, R., 2013. The Errors in Radar Level Gauge Calibration. *Measurement Science Review MEASUREMENT 2013, Proceedings of the 9th International Conference, Smolenice, Slovakia*, pp.355-358. Available at: http://www.measurement.sk/M2013/doc/proceedings/355_Mikus-1.pdf

Mikuš, P., Harťanský, R. and Čičáková, O., 2014. Diffraction Problem in Radar Level Gauge Verification. *Universal Journal of Electrical and Electronic Engineering*. 2(4), pp. 165-169, DOI: 10.13189/ujeee.2014.020404. Available at: <http://www.hrpub.org/download/20140305/UJEEE4-14901774.pdf>

Mikuš, P., Harťanský, R. and Smieško, V., 2016. The proposal of the laboratories for calibration of radar level Gauges. *Przegląd Elektrotechniczny*, 92(2), pp.72-74, ISSN 00332097, DOI: 10.15199/48.2016.02.21. Available at: <http://pe.org.pl/articles/2016/2/21.pdf>

Motzer, J., 2000. PULS RADAR gauge for level measurement and process control. *Proceedings of the 1999 IEEE MTT-S International Microwave Symposium; Boston, MA, USA*, 3, pp.1563-1566, ISSN 0149645X.

Oréans, L. and Heide, P., 2000. Novel Radar Level Gauge Using 24-GHz-Technology. *Technisches Messen*, 67(5), pp.214-219, ISSN 01718096.

Palenčár R. and Halaj, M., 1999. *Metrologické zabezpečenie systémov riadenia kvality* [Metrological assurance of the quality systems management]. 2nd ed. Bratislava: STU Bratislava. ISBN 80-227-1171-3.

Palenčár R., Kureková E. and Halaj, M., 2007. *Meranie a metrologia pre manažérov* [Measurement and metrology for managers]. Bratislava: STU Bratislava, ISBN 978-80-227-2743-3.

Pekarčíková, M., Trebuňa P. and Fiľo, M., 2014. Methodology for classification of material items by analysis abc/xyz and the creation of the material portfolio. *Applied Mechanics and Materials*, Vol. 611, pp.358-365, ISSN 1660-9336.

Popovič R., Kliment M., Trebuňa P. and Pekarčíková, M., 2015. Simulation as a tool for process optimization of logistic systems. *Acta Logistica*, 2(3), pp.1-5, Available at: http://www.actalogistica.eu/issues/2015/III_2015_01_Popovic_Kliment_Trebuna_Pekarcikova.pdf [Accessed 5 September 2015].

Trebuňa P., Kliment M., Edl, M. and Petrik, M., 2014. Document creation of simulation model of expansion of production in manufacturing companies. *Procedia Engineering*, Vol. 96, pp.477-482, Available at: <http://www.sciencedirect.com/science/article/pii/S1877705814031695> [Accessed 5 September 2015].

Wang, G., Gu, C., Rice, J., Inoue, T. and Li, C., 2013. Highly accurate noncontact water level monitoring using continuous-wave Doppler radar. *WiSNet*

2013 - *Proceedings: 2013 IEEE Topical Conference on Wireless Sensors and Sensor Networks - 2013 IEEE Radio and Wireless Week, RWW 2013*. pp.19-21; DOI: 10.1109/WiSNet.2013.6488620.

Wei, M. , Xu, K.J. and Ma, Y., 2013. An echo signal processing method without reference curve for guided wave radar level gauge. *IEEE International Conference on Control and Automation, ICCA*. pp.972-977, DOI: 10.1109/ICCA.2013.6565025.

Zgodavova, K., 2010. Complexity of entities and its metrological implications, 0365-0367, *Annals of DAAAM for 2010 & Proceedings of the 21st International DAAAM Symposium, ISBN 978-3-901509-73-5, ISSN 1726-9679, pp.0365-0366, B. Katalinic (ed.), Published by DAAAM International, Vienna, Austria 2010*; DOI:10.1073/pnas.1002194107, Available at: http://www.daaam.info/Downloads/Pdfs/proceedings/proceedings_2010/20162_Annals_1_head.pdf

Zgodavova, K. and Slimak, I., 2008. Advanced improvement of quality. *Annals of DAAAM and Proceedings of the International DAAAM, Published by DAAAM International, Vienna, Austria 2010*, pp.1551-1552, ISSN 17269679, ISBN 978-390150968-1, Available at: <http://www.freepatentsonline.com/article/Annals-DAAAM-Proceedings/225316745.html>

ABOUT THE AUTHORS

Ing. **Jaromír Markovič**, PhD., Slovak legal Metrology, Banská Bystrica, Slovakia; e-mail: slm@slm.sk.

Dr. h. c. Prof. Ing. **Jozef Mihok**, PhD., Technical University of Košice, Faculty of Mechanical Engineering, Department of Industrial Engineering and Management, Košice, Slovakia; e-mail: jozef.mihok@tuke.sk.

Assoc. Prof. Ing. **Stanislav Ďuriš**, PhD., Slovak University of Technology in Bratislava; Faculty of Mechanical Engineering, Bratislava, Slovakia; e-mail: stanislav.duris@stuba.sk.

Ing. **Zbyněk Schreier**, CSc., Slovak Office of Standards, Metrology and Testing; Bratislava, Slovakia; e-mail: zbynek.schreier@normoff.gov.sk.

Analysis of Request for Proposals in Construction Industry

DOI: 10.12776/QIP.V20I1.686

Michal Tkáč, Radoslav Delina, Martina Sabolová

Received 23 February 2016, Revised 17 June 2016, Accepted 24 June 2016

ABSTRACT

Purpose: The purpose of this paper is to identify and determine reasons why construction companies reject some of the request for proposals (RFPS) suitable for them.

Methodology/Approach: The research has several parts. Within the first part the list of reasons which lead to rejection of RFPS and thus potential client are identified. Then the comparison of differences between groups of rejected RFPS with different configuration is made. The last part of research use Pareto analysis to determine most obvious and most costly reasons of rejection of RFPS.

Findings: The paper identifies 12 reasons, why construction companies decline to prepare proposal for their potential clients. It also doesn't confirm that configuration of RFPS has significant impact on the rejection of RFPS. Moreover the results on the other hand showed that insufficient trust represent the main barrier which influences the rejection of RFPS in selected company.

Research Limitation/implication: The main limitation of the research is that it is based on single case study. Although, the quantitative results have to be generalised very carefully, on the other hand paper provide list of the possible reasons why construction companies decline to compete for an offer.

Originality/Value of paper: The paper provides unique perspective because apart from traditional attitude, where only the submitted RFPS are evaluated, this paper analyses rejected RFPS and tries to identify and determine reasons why construction companies decide not to prepare proposal and thus reduce the possibility to acquire new contract.

Category: Case study

Keywords: procurement; construction; RFPS; tender; one-bid offer; trust

1 INTRODUCTION

The construction industry is known for its special attributes which have to be determined in order to understand how companies operate. The one speciality is that most products produced within this sector are unique, which cause a small level of product standardisation (Zunk et al., 2014). It is also a reason why the construction companies have to prepare unique proposals for every product that want to sell and their performance often directly dependent on the success of their offerings within various tenders, selections and procurements processes (Ibem and Laryea, 2014). Therefore it is not surprising that procurement processes conducted within construction industry have been detailed studied and analysed for more than 50 years. The one area is how the numbers of bidders affect the bidding process and outcome. Although it is discussed from 1956 by Lawrence Friedman, the results are still inconclusive. The studies conducted in U.S. and UK during the 80. and 90. showed that number of bidders is one of the three most important factors that have impact on bidding decision (Ballesteros-Pérez et al., 2016). Findings like these raise questions regarding the factors, which influence the number of bidders. Majority of the research were focus on factors like size of the contract and market condition. Other studies investigate factors like project type, client, specific location etc. Detailed description of them and their results can be found on Ballesteros-Pérez et al. (2016). According to their study it is very hard to determine what influence the number of bidder in the bidding process. They stated *“Nonetheless, forecasting the number and identity of bidders is challenging, since no conclusive solution has yet been found for its accurate prediction, nor exists a suitable quantitative model to forecast the identities of a single or a group of specific key competitors likely to submit a future tender”*.

In this paper we tried to look on the problem from different perspective. In terms of research question, we tried to determine the factors which influence the bidders not to be part of the bidding process. Motivation for research is that although it is hard to *“forecast the identities of a single or a group of specific key competitors likely to submit a future tender”*, it can be easier to identify the reasons why competitors are not willing to submit proposals for a future tender. Therefore, this paper is focused on the process of offer's elimination. We analyse 170 offers of middle-sized construction company from east Slovakia with an aim to determine the main reasons which lead to elimination of offers from the bidding process.

2 CONSTRUCTION COMPANIES IN A PROCESS OF OFFER SELECTION

The vast majority of the research, regarding the procurement processes in construction industry, deals with type of mechanisms, configuration of mechanisms and characteristics of the investors or RFPS. For more information about these studies see Ballesteros-Pérez et al. (2015; 2016), Ruparathna and

Hewage (2015), Szabo (2015), Delina (2014), Ibem and Laryea (2014), Zunk et al. (2014), Eriksson and Westerberg (2011), Eadie, Perera and Heaney (2010), Doucek (2004). We decided to study the beginning of the procurement process, the phase, where the construction company decides to participate in tender. This study tries to describe the process of competition selection from the bidders/participants point of view. It is done by analysis of the bids and RFPs of concrete construction company.

The evaluation and the management of company's performance are usually based on analysis of all relevant processes conducted within and outside of the company. The performance of the company with a history of many unsuccessful tenders (or other procurement competitions) can be hardly considered as efficient. Based on research conducted in our previous works (Sabolova and Tkáč, 2015; Tkáč and Sabolova, 2015) we can claim that unsuccessful tenders represent for construction company, not only missed opportunities, but also sunk costs of proposal preparation. Although the costs of proposal preparation are usually small compare to the price of winning offer, but there is also a question of capacity management. The people and sources that were used for preparation of losing proposal could be used to preparation of the one that could win. Based on these claims, there are logically two types of mistakes made by construction companies in the process of offer selection. First type of mistake is to select the request for proposal that company shouldn't select (because it is not the winning one). Second mistake is reject request for proposal that company should have selected (because the proposal would be the winning one). The costs of first mistake are costs of proposal preparation. They represent pure loss in company accounting. The costs of second mistake are cost of missed opportunity. The problem with these mistakes is that construction companies can make both of them at the same time. Based on capacity restriction of realization team they choose to prepare proposal for offer that they should not and reject the offer that they should accept. The issue of missed opportunities is also interesting from the perspective of performance measurement. It is hard to quantify the expected profit that could be obtained if the construction company wins the competition that the company decides not to take part in. Such evaluation can't be estimated from accounting of winning firm as well as from any previous information provided by investor. Moreover not winning represents for participant's company some kind of loss, because its expectation was not fulfilled. Moreover the exact size of this loss is unknown, it is called hidden loss.

For construction companies (in terms of their performance) in order to minimize mentioned mistakes is important to improve the process of selection and preparation of offers. Company must continuously analyse their losses, winnings as well as the rightfulness of their selection procedures to determine which competitions are suitable for them. The importance of such analyses became more obvious when company take part in public procurement. Even a small inadequacy, during the process of applying for public offer, can lead to disqualification of offer from competition. In private procurement, the investor

can overcome some inadequacies and decide whether offer will be disqualified or not. Therefore, the characteristics of request for proposal significantly affect not only the company's decision regarding participation in the contests, but also, the outcome of contests and realization of construction projects. Consequently, historical analysis of previous offers and competitions from practitioner's point of view can assure better sustainability of construction companies in construction industry.

3 DESCRIPTION OF THE SAMPLE

The research in this paper is based on requests for proposal (RFPS) collected in the particular construction company from 2009 to 2014. Based on internal company documentation, we have compiled a table that provides information about the various construction projects. The cases were defined by places of realization, the estimated cost of the contract, price of realization, type of procurement mechanism and type of investors. The object of the examination was medium-sized construction company operating in the Košice region in the Slovak Republic. The company was founded Dec. 4, 1992 as a limited liability company. The company has a total of 50 employees, which are broken down by categories. The structure of the company's staff can be seen in Figure 1.

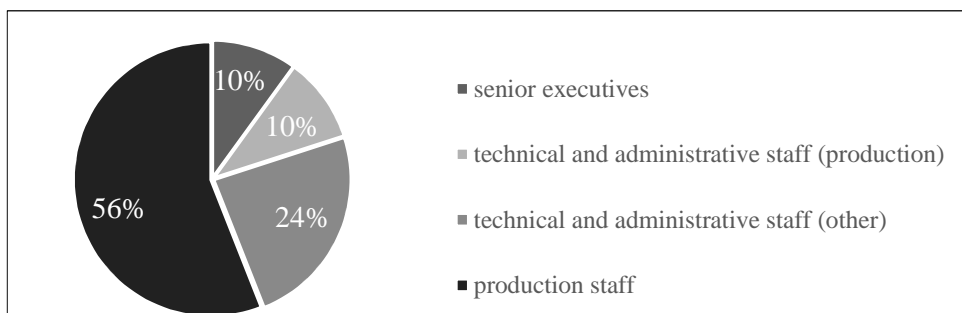

Figure 1 – Structure of employees by categories

Source: authors

The team for realization of construction projects has 28 professionals, concretely 14 bricklayers and concrete workers, two carpenters, one electrician, two steelmakers, 5 drivers and operator of construction machines, two locksmiths and two auxiliary construction workers.

During the mentioned 5 year period company analysed 170 requests for proposals (RFPS). Most of these (126) were transformed into proposals and company use them in various selection and procurement processes. On the other hand closely to one quarter (40) of all RFPS were rejected without any proposal preparation procedure. The winning rate, (55%) apart from losing rate (19%) suggests that company carefully selects which competitions are suitable and which are not. The detailed structure of analysed RFPS is described in Figure 2.

In the study we will focus on the offers that were rejected, in order to determine main reasons why company decided not to participate in these particular competitions.

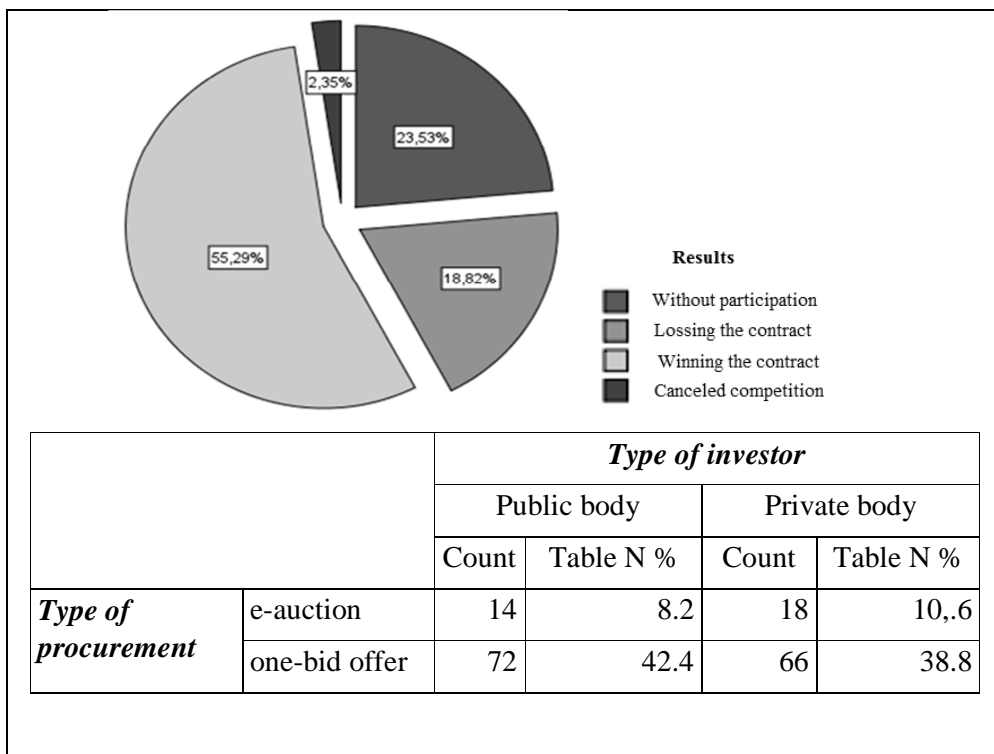

Figure 2 – Structure of RFPS based on company the results
Source: authors

4 METHODOLOGY

The research in paper has two parts. First part is based on basic comparison of rejected RFPS based on their characteristics. Although every single RFPS was unique, we manage do identify 3 parameters, which can be recognized from all of them. These parameters are:

- Predetermined estimated price of project
- Type of investor (private procurement vs. public procurement)
- Type of procurement (e-auction vs. one-bid offer)

According to these characteristics, we create descriptive tables to identify differences in rejected offers based on different type of investors or procurement method. Motivation for such analyses is to determine whether some type of

procurement methods or some types of investors are rejected more frequently than others.

Second part of research focus tries to identify main reasons why these offer were rejected. The information system of the company require from the managers to state the reasons of rejection of RFPS. Based on these statements, we identified several key causes of rejection. The frequencies of these reasons were analysed by statistical methods known as Pareto analysis. Pareto analysis is a specific type of histogram, which helps to identify priorities and determine problem areas. It is used for effects' determinations of corrective measures or a variance analysis between two or more methods (Doležal, Fireš and Míková, 1992) defines three types of Pareto analysis:

- 1) The fundamental analysis that identifies the causes of the most common problems of quality management,
- 2) Comparative analysis that solves outbreaks of any option,
- 3) The weighted analysis providing measurement of significant factors which do not appear at first sight.

The analysis is based on the Pareto principle: 80% consequences due to the 20% of causes. According to Veber (2004) analysis helps identify priorities that need to be targeted (on which products, processes, activities) rearrange items according to frequency of occurrence and determine the relative cumulative frequency.

5 THE RESEARCH

The first part of research focus on analysis of RFPS based on their different features to find out whether specific group of them isn't rejected more likely than the others. As was mentioned in the methodology the RFPS were divided based on characteristics such as type of investor and type of procurement method into four groups. The distribution of rejected requests is presented in the first table of the Table 1. Second table of the Table 1 represent the same division of RFPS into the four groups, but instead of frequencies it presents sums (in €) of estimated project prices predetermined in particular RFPS.

As can be seen from Table 1, there are small differences between groups of rejected RFPS. The differences became even smaller when the results from rejected RFPS are compared to the sample of all RFPS (Figure 2). The distribution presented in the sample of all RFPS is very similar to distribution of rejected RFPS. In both of the samples the public one-bid offers represent majority of RFPS. The presented results of rejected RFPS don't show significant change in distribution of RFPS in compare with overall distribution of the whole

database. It seems that, type of procurement method or type of investor doesn't seem to be a barrier for the construction company to participate in competition.

Table 1 – Distribution of rejected RFPS based on their characteristics (Source: authors)

		<i>Type of investor</i>			
		Public body		Private body	
		Count	Table N %	Count	Table N %
<i>Type of procurement</i>	e-auction	6	15.0	6	15.0
	one-bid offer	17	42.5	11	27.5

		<i>Type of investor</i>	
		Public body	Private body
		Sum [€]	Sum [€]
<i>Type of procurement</i>	e-auction	11 601 998.39	11 058 019.39
	one-bid offer	14 082 992.32	10 968 960.10

The second part of research is based on the use Pareto analysis, in order to determine main reasons for rejection of RFPS. Based on reasons of rejections stated in the information system of the company we identified 12 reasons why company rejected selected RFPS. The identified reasons are: Time issue - short term of realization, Time issue - short term for proposal preparation, Financial incapability, Uncomplete project documentation, Insufficient capacities, Obscure financing - private investor, Unfavourable contract condition, Unattractive contract, Different type of construction, References, Technical difficultness of construction. Based on these reasons we created two Pareto diagrams. First diagram (Figure 3) represents the frequency of the causes and the second one (Figure 4) represents value of the causes. The value of the cause is determinate as sum of estimated projects prices predetermined in RFPS which were rejected because of this particular cause.

As can be seen from Figure 3 and Figure 4 almost all the reasons for which the company has decided not to participate in the competition are not related to any “insurmountable” obstacles, and therefore they can be seen as a missed opportunity of the company.

In term of frequency, the cause the largest share in the sample was “unattractive contract.” For the company unattractive contract means that it is a contract which is not big enough for its realization, i.e., the company realizes bigger buildings and management was not interested in the project. The second reason for

rejection of the RFPS was that the company does not realize this type of construction. These types of RFPS represent technologically advanced, water or historical buildings projects. It should be highlighted that the RFPS on construction projects which cannot be realized by selected company because of its incompetency were removed from sample and analysis. The cause “different type of construction” represents buildings which can be built by the company but from a certain point of view, they are unusual and company decided that this extra effort is not worth it.

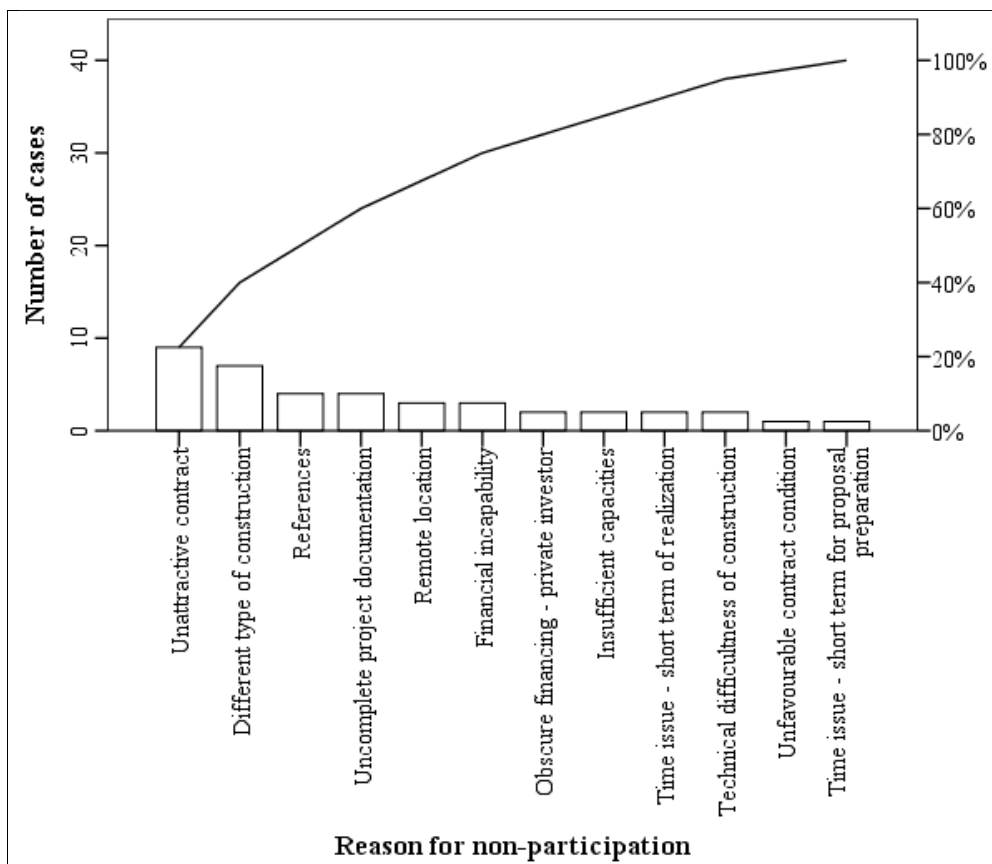

Figure 3 – Pareto diagram of reasons for non-participation in the competition based on count of RFPS
 Source: authors

The third reason for rejection is represented by insufficient references. The RFPS state the volume and type of references that should be provided by company in order to be part of competition. Usually in this case the applicant must provide a reference letter with the name and company name of the customer, the address of its registered office, name and company name of the contractor, the name of the subject of contract, the total contract price in EUR without VAT, dates of commencement and completion of work, places of realization and a brief

description of the contract which expressed that the work has been performed in accordance with the contract and with the required quality. The references should also include customer's contact person (name, phone number), who can verify these information.

The uncomplete project documentation was the fourth reason why the company has decided not to participate in the competition. Reason why this cause occur so frequently is that procurement's documents (RFPS, contracts) issued manly by public bodies regularly include statements, which disadvantage construction companies. Investors' motivation for inclusion of such statements is to get rid of responsibility for the completeness and correctness of the entries. The statements usually held construction companies financially responsible of errors in the project, poor technical specifications, insufficient specifications of the contract and poor budget planning. This is the reason why construction companies usually choose to participate only in competitions, where the project documentation is done correctly.

Remoteness of location was also one of the reasons why the company decided not to participate in the competitions. Company operates in regions of Košice and Prešov. When RFPS requires carrying out construction outside these territories, the company declined such contract.

The same frequency of occurrence had the reason called "financial incapability", which is given in terms of Bulletin of Public Procurement. Company for example, must provide ownership confirmation of bank account. Separate candidate must also have access to credit and other financial facilities in order to ensure cash flow during the realization of the contract / order. Another condition for the fulfilment of economic and financial capability is the certificate of insurance liability for damage caused at pursue the occupation or proof of insurance liability for damage, as well as the presentation of the income statement or statement of income and expenses for the specified years as well as certified photocopies provided by the tax authority while the candidate must colour-highlight its turnover. The candidate has to also provide the sum of turnovers for the specified years and so on (UVO, 2016). In term of the investigated firm insufficient financial sources was main reason why investigated company decide to reject these RFPS.

In case of private investors, the construction company generally verifies the liquidity of investor, as well as the riskiness of such contract. If there was a doubt that potential contract with company would have obscure (unclear) funding from the private investor, company generally decided to ignore the competition.

Insufficient capacities were also impulse for the non-participation of company in the competition. Here company need to consider whether the estimated price of project and subject of the contract will be so interesting for a company that it would risk its name and outsource capacities from other company.

In a few cases the reason for rejection was technical difficultness of construction or technical capability. In the latter case the applicant has to provide a list of construction works conducted within past few years with are similarly oriented as construction in RFPS. The list must also include required budgetary costs and must be supplemented with at least three reference letters. The content of these reference letters was mentioned earlier. The candidate also has to appoint at least one person directly responsible for managing of construction works. This person need to be professionally competent as construction manager, i.e., must have a certificate SKSI or equivalent about passing the professional examination in accordance with the Act. No.138/1992 Coll. of authorized architects and authorized building engineers, as amended, authorizing the implementation of selected activities under construction in accordance with § 45 of the Act. No.50/1976 Coll. Building Act, as amended. Construction manager submits a copy of SKSI or equivalent certificate with original signature and stamp of the professionally qualified body. The candidate also stated in the affidavit the persons with appropriate qualifications and which are competent to realize the contract.

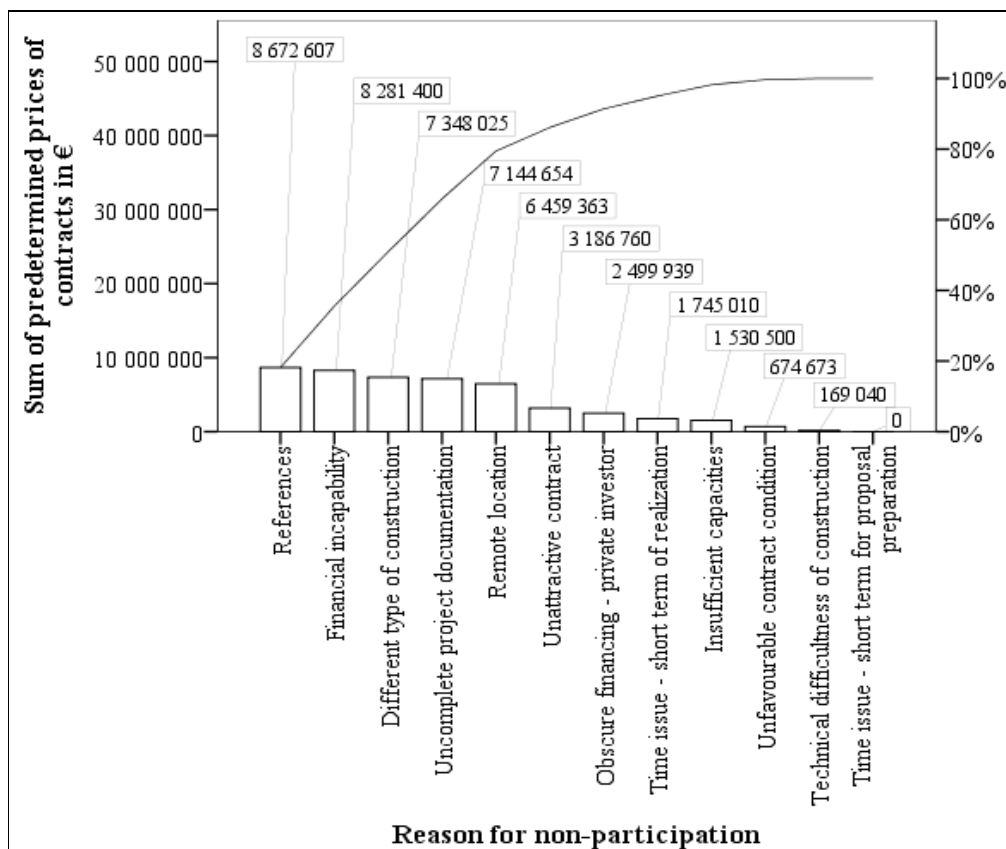

Figure 4 – Pareto diagram of reasons for non-participation in the competition based on sum of predetermined prices of RFPS

Source: authors

The value (in €) of the cause of rejection is represented by Figure 4. Interestingly, cause of insufficient references represents most expensive bulk of rejected RFPS. On the other hand, the financial capability is usually requested in expensive and large projects, so it can't be surprise that financial incapability is between the most expensive reasons for rejection of RFPS.

6 DISCUSSION AND FINDINGS

The analyses provided in this paper lead to some interesting conclusions. Firstly, it should be mention, that research was done based on the results of one particular construction company. That is the reason why, one has to be very careful to generalize quantitative results to the whole construction industry. On the other hand, one of the main purposes of this paper was to determine the reasons why company decline RFPS and thus eliminate their chance to compete for contract and to attract new client. We identified 12 such reasons which should be considered in any Slovak construction company. The next part of the study focus on basic characteristics of RFPS. It tries to determine whether the characteristics, such as type of investor and method of procurement have influence on decision of the company to decline the RFPS. The results showed, that distribution of rejected RFPS in term of number of cases and total sum offers' price are nearly the same, when you divide the sample according to method of procurement or type of investors. Based on these results, we can't confirm that rejection of RFPS is significantly influenced by type of procurement method or by type of investors. The companies had their own internal reasons, why they reject the RFPS. As was mentioned before, we identify 12 of them. As our study shows, some of the reasons are completely dependent on decisions of these companies (unattractive contract, different type of construction), others represent the barriers determined by the investors through the RFPS and procurement restrictions. They are recognized as barriers because, these restrictions cause that construction companies cannot be part of competition, even if they want to. Interestingly, the analyses showed that most frequently recognized cause as well as most expensive cause represents the same barrier. It is the barrier of insufficient trust between investor and contestants. The insufficient trust is the reason why investors secure their RFPS with the one of the simplest of trust building mechanisms, the references. Moreover, this barrier of distrust is not efficient both for investor as well as for contestant. Insufficient trust would prevent healthy company with good record to provide proposal maybe better than the proposal of winning company. The question also is what an appropriate number of references is. Is company with three references worse than company with only a two? Moreover, the references mentions only the successful projects not the unsuccessful ones. It doesn't provide any success ratio of a construction company. Although it is understandable, that in construction sector the trust is an issue, but the current business environment provide some other more advanced trust building mechanisms, which increase trust and don't penalize investors and the company. The problem with references as a system is,

that in order to get some references, there must be an investor, who is willing to hire company without any previous references. Therefore, to get a chance to a new company to compete, the trust of the investor should be assured by other trust building tools. The insufficient trust of contestant to private investors can be also an issue. For example the unclear funding of the investor was recognized as one of the reasons why perfectly capable company lose their interest in participation on competition.

7 CONCLUSION

Presented paper analyses the process of selection of requests for proposal in the construction company. The motivation for such research is to determine reasons which influence construction companies to select competitions appropriate for them. Research was based on analysis of 140 Request for proposals. From these requests we identified 40 offers which company consider as not suitable for preparation of proposals. These offers were analysed in order to determine reasons why they were rejected. The study identified 12 reasons the construction company decline the RFPS. Pareto analysis was then used to describe most common reasons. Based on analysis, it can be assume, that apart from other specific reasons, there is a significant barrier of insufficient trust which prevent the construction company to take part in competitions.

ACKNOWLEDGMENTS

This work was supported by Scientific Grant Agency VEGA of Slovak Republic within the grant No. 1/0855/14 “Determinants of efficient purchasing supported by electronic solutions”.

REFERENCES

- Ballesteros-Pérez, P., Skitmore, M., Pellicer, E. and González-Cruz, M.C., 2015. Scoring rules and abnormally low bids criteria in construction tenders: a taxonomic review. *Construction Management and Economics*, 33(4), pp.259-278. Available at: <http://www.tandfonline.com/doi/pdf/10.1080/01446193.2015.1059951>
- Ballesteros-Pérez, P., Skitmore, M., Pellicer, E. and Gutiérrez-Bahamondes, J.H., 2016. Improving the estimation of probability of bidder participation in procurement auctions. *International Journal of Project Management*, 34(2), pp.158-172. Available at: <http://www.sciencedirect.com/science/article/pii/S0263786315001775>
- Delina, R., 2014. Transparency In Electronic Business Negotiations–Evidence Based Analysis. *Quality Innovation Prosperity*, 18(2), pp.79-89. Available at: <http://www.qip-journal.eu/index.php/QIP/article/view/417>

Doležal, J., Fireš, B. and Míková, M., 1992. *Finanční účetnictví* [Financial Accounting]. Praha: Grada.

Doucek, P., 2004. E-society–perspectives and risks for European Integration. In: Proceedings *IDIMT-2004*, České Budejovice, Czech Republic, 15 – 17 September 2004, edited by Ch. Hofer and G. Chroust. Schriftenreihe Informatik, 12, pp.35-42.

Eadie, R., Perera, S. and Heaney, G., 2010. A cross-discipline comparison of rankings for e-procurement drivers and barriers within UK construction organisations. *Journal of Information Technology in Construction (ITcon)*, 15, pp.217-233. Available at: http://www.itcon.org/cgi-bin/works/Show?2010_17

Eriksson, P.E. and Westerberg, M., 2011. Effects of cooperative procurement procedures on construction project performance: A conceptual framework. *International Journal of Project Management*, 29(2), pp.197-208. Available at: <http://www.sciencedirect.com/science/article/pii/S0263786310000050>

Ibem, E.O. and Laryea, S., 2014. Survey of digital technologies in procurement of construction projects. *Automation in Construction*, 46, pp.11-21. Available at: <http://www.sciencedirect.com/science/article/pii/S092658051400154X>

Ruparathna, R. and Hewage, K., 2015. Sustainable procurement in the Canadian construction industry: current practices, drivers and opportunities. *Journal of Cleaner Production*, 109, pp.305-314. Available at: <http://www.sciencedirect.com/science/article/pii/S0959652615008872>

Szabo, S., 2015. Determinants of Supplier Selection in E - procurement Tenders. *Journal of Applied Economic Sciences*, 10(7), pp.1153-1159.

Sabolová, M. and Tkáč, M., 2015. Characterization of procurement process in the construction company. *Investment management and financial innovations: international research journal*, 12, pp.166-170.

Tkáč, M. and Sabolová, M., 2015. The Analysis of price offers in construction industry from participant's point of view. In: *IDIMT-2015. Information technology and society interaction and interdependence : 23rd Interdisciplinary information management talks*, 9-11 September 2015. Poděbrady, Czech Republic, pp.271-278.

UVO: Úrad pre verejné obstarávanie: *Zákon o verejnom obstarávaní a o zmene a doplnení niektorých zákonov* [UVO: The Office for Public Procurement: Law on public procurement and on the amendment of certain laws]. [online]. Available at: <https://www.uvo.gov.sk/zakon> [Accessed 10 January 2016].

Veber, J., 2004. Nové prístupy managementu - II. Část [New attitudes to management – II. Part]. *Ekonomika a management podniku*, 2(2), pp.6-19.

Zunk, B., Marchner, M., Uitz, I., Lerch, C. and Schiele, H., 2014. The Role of E-Procurement in the Austrian Construction Industry: Adoption Rate, Benefits and Barriers. *International journal of industrial engineering and management*, 5(1), pp.13-21. Available at:
http://www.iim.ftn.uns.ac.rs/casopis/volume5/ijiem_vol5_no1_2.pdf

ABOUT AUTHORS

Ing. **Michal Tkáč**, PhD. – Assistant Professor at Faculty of Business Economics with seat in Košice, Department of Financial Management, Tajovského 13, 041 30 Košice, Slovak Republic, michal.tkac1@euke.sk

Doc. **Ing. Radoslav Delina**, PhD.– Assoc. Professor, Head of Department of Banking and Investment at Faculty of Economics at Technical University of Kosice, Letna 9, 042 00 Kosice, Slovak Republic, radoslav.delina@tuke.sk

Ing. **Martina Sabolová**, PhD. – Assistant Professor at Faculty of Business Economics with seat in Košice, Department of Financial Management, Tajovského 13, 041 30 Košice, Slovak Republic, martina.sabolova@euke.sk