

**EDUCATIONAL MODELS FOR MECHATRONIC COURSES**

Tatiana Kelemenová; Peter Frankovský; Ivan Virgala; Ľubica Miková; Michal Kelemen; Lukáš Dominik

*Received: 23 Nov. 2016**Accepted: 02 Dec. 2016***EDUCATIONAL MODELS FOR MECHATRONIC COURSES****Tatiana Kelemenová**Technical University of Kosice, Faculty of Mechanical Engineering, Letna 9, Kosice, Slovak Republic,  
tatiana.kelemenova@tuke.sk**Peter Frankovský**Technical University of Kosice, Faculty of Mechanical Engineering, Letna 9, Kosice, Slovak Republic,  
peter.frankovsky@tuke.sk**Ivan Virgala**Technical University of Kosice, Faculty of Mechanical Engineering, Letna 9, Kosice, Slovak Republic,  
ivan.virgala@tuke.sk**Ľubica Miková**Technical University of Kosice, Faculty of Mechanical Engineering, Letna 9, Kosice, Slovak Republic,  
lubica.mikova@tuke.sk**Michal Kelemen**Technical University of Kosice, Faculty of Mechanical Engineering, Letna 9, Kosice, Slovak Republic,  
michal.kelemen@tuke.sk**Lukáš Dominik**Technical University of Kosice, Faculty of Mechanical Engineering, Letna 9, Kosice, Slovak Republic,  
lukas.dominik@tuke.sk**Keywords:** mechatronics, education, embedded systems, microcontroller**Abstract:** The paper deals educational model based on embedded system via using the microcontroller. The quality of education is supported through the using of these educational models. Students learn on practical exercises and experiences. That is the best way how to teach mechatronics.**1 Introduction**

Mechatronics is defined as synergic combination of mechanics, electronics and computer controlling for improving of properties of existing products and developing of new products.

Mechatronics grows up last years as research and business approach to product design and developing. It is possible to say that almost every sophisticated product has mechatronic background. The product involves new functions as monitoring of its state parameters – self-diagnostic, self-repairing, guider to easy use with interactive user-friendly interface, self-calibration, remote wireless communication with user, events history saving, protection before damaging etc. The product has improved previous functions but also mechatronics approach enables to involve set of the new functions, which cannot be realized before (airbags system, automatic parallel and perpendicular parking system, drive efficiency assistant etc.) These functions help to customers to safely use of the product and some functions is automatically executed with product. Product becomes to intelligent system which removes amount of liability from customer upon the product. Products with these properties are very attractive and preferred by customers. These products also ensure the business successful and profitable position on unstable market. All these

mentioned facts are as the motivation for teaching of the mechatronics approach to product design and development. This paper tries to show didactic aids and methods which are currently used at mechatronics courses at our university. Students work with similar building parts as in real practice and obtain experiences with design of such products. It is possible to say that mechatronics also going directly through the student hands and that is the perfect way how students can learn mechatronic thinking [1-6].

**2 From the system structure to building parts**

Design of new products starts with design of system structure on the level of function subsystem and organs. System structure shows which main subsystems are needed and how the relations between them are. Students can generate various alternatives of subsystems after multi-level decomposition of designed system. The last step is selection of base building parts after evaluation of subsystem decomposition.

This process cannot be successful without perfect knowledge of base building parts properties. Consequently, our student have a lot of function model of base building parts which can be used for quickly composing of function model of designed subsystem or

**EDUCATIONAL MODELS FOR MECHATRONIC COURSES**

Tatiana Kelemenová; Peter Frankovský; Ivan Virgala; Ľubica Miková; Michal Kelemen; Lukáš Dominik

overall product. Students under supervision of teacher can use heuristic methods for system design. They can verify of their design ideas and they obtain experiences about base building parts behaviours. Students obtain basic ability for experimentally work and prototyping. Another main advantage is that students become to skilled user of laboratory equipments and machines devoted for measurement, testing, signal processing etc.

Set of functional models of basic building parts and subsystems are consist of microcontroller modules, switches modules, variable resistive modules, relay modules, transistor switch modules, LED diodes modules, AD and DA converters, signal amplifiers, signal filter modules, various sensor modules, LCD modules, speaker modules, actuator modules (DC motor, stepping motors, rotational RC servos, linear servos, SMA actuators, piezo actuators, electromagnetic actuators), water pumps, air fans, XY stage for testing etc (fig. 1).

Microcontrollers are belonging to group of embedded systems, which are applicable for control of processes and product functions. This purpose needs to capture information about the product and also about surround. These information's have to be processed inside the microcontroller and after processing the microcontroller makes decision about next steps if it is necessary. Right decision depends on suitable selected sensors and processing of captured information. Data capturing and processing is the main role of microcontroller. Microcontrollers have a miniature dimensions and it enables to integrate inside to products. It belongs to group of embedded systems, which have main role – controlling of product activity and man-machine interface between product and user. These products are user friendly and microcontroller helps to user with successful using of products.



Figure 1 Several parts of building items for prototyping of mechatronic systems

Students can build very quickly any construction and they can experimentally verify function and behaviours of it without a lot of hours of soldering (fig. 2). They learn

that everything has to be examined and verified, because of mistakes which are very often mentioned in datasheets.

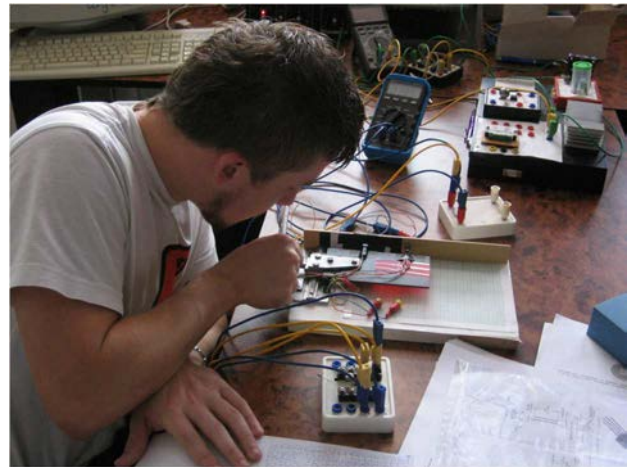

Figure 2 Student experimental working with mechatronic subsystems

Students also use the microcontrollers on solderless breadboard (fig. 3). This is another way how to support student skills and experiences. Students can build by himself electronic circuits and make testing before the making of printed circuit board.

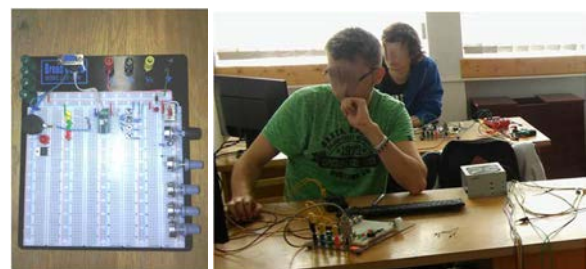

Figure 3 Exercises with embedded systems on solderless breadboard

The didactic process lies on using of heuristic method for solving of case studies. Teacher as supervisor defines problems, which are necessary to solve and students generate working as team of designers and developers. They generate possible solution of defined problems via using of brainstorming and collaborative work. Students invent new effects and behaviours of base parts and subsystems.

They exercise to build basic conventional and unconventional structures used in mechatronic products. They obtain basic knowledge, skills and experience from area of sensors, signal processing, electromechanical systems, actuators, embedded systems (microcontroller, programmable logic controller), design of various control algorithms, logical systems, power electronic and driving of AC and DC motors and stepping motors etc.

More complex subsystems (fig. 4) enable to directly build various types of mechatronic systems. For these



**EDUCATIONAL MODELS FOR MECHATRONIC COURSES**

Tatiana Kelemenová; Peter Frankovský; Ivan Virgala; Ľubica Miková; Michal Kelemen; Lukáš Dominik

reason students can work with linear positional units, drive systems with DC motors, water tank with regulated level. These didactic aids enable to try PID control and two-stage regulation and also combination and sequential logic systems.

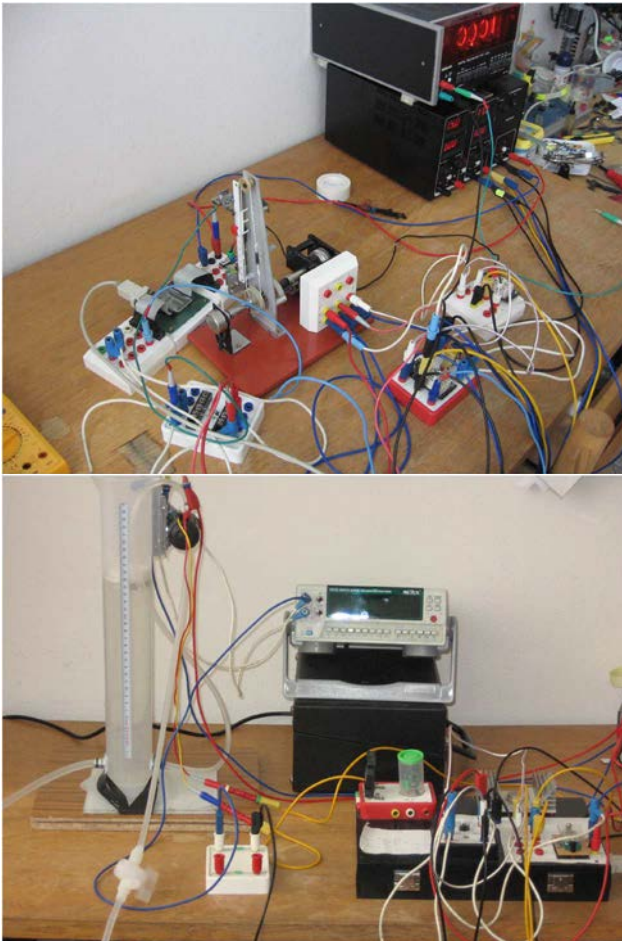

Figure 4 Linear position regulated system and water tank with level regulation

**3 Didactic mechatronic models with variables wiring and structures**

More sophisticated didactic models are also used in educational process. Students design flowcharts for realization of specified functions and after that can write source code for programming of microcontroller.

Lift model as complex model (fig. 5) has been developed. Several master thesis and bachelor thesis have been defended on partial problems of this topic.

The concept of lift model is structured as modular system for embedded system training, measurement and data processing training, control algorithm training etc. Lift model has modular structure and it allows varying structure. Consequently, students have possibilities to do experiments and verification of own designs.

Line follower LINA 2010 (fig. 6) didactic model is developed for competition between students. Every student works on own algorithm and trains on this robot. After optimization and completing of program students can compete. The main goal of competition is to follow line but also obstacle avoiding of brick is necessary. Line follower LINA 2010 also has to pass through the bridge and through the tunnel with door. Door is opened only when robot moves switching cube at minimum of 2 cm in any direction. The winner is who is the most quickly.

Solution of this robot seems to be easy but several key issues raised up on prototype of the robot. That is a typical example, that also design of simple product can has also many problems. Practical experiences are very important for students, because students are better prepared for practice. That is something what is not possible to learn from books. Consequently, practical exercises bring skills and experiences to students.

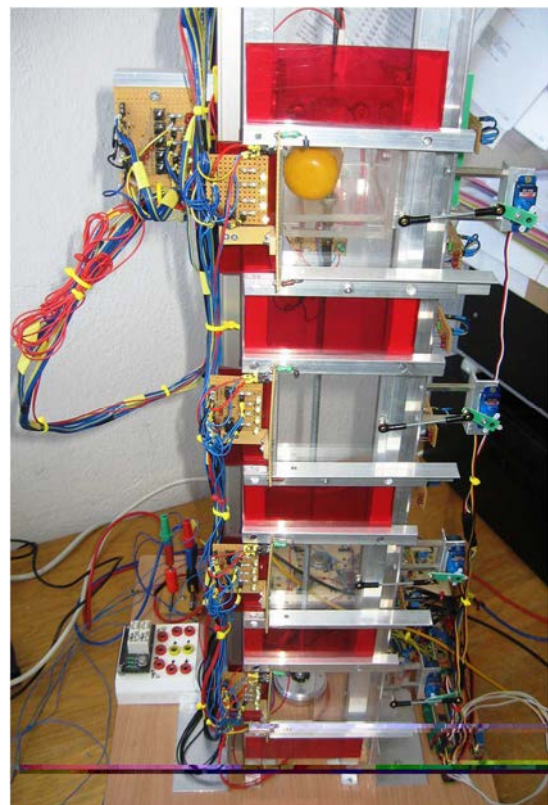

Figure 5 Didactic model of the lift

Problem of obstacle avoiding is as main task of the two wheeled robot VDU2004 with differential controlling (fig. 7 left). It includes collision infrared reflective sensor which uses frequency modulated light for obstacle sensing. This didactic model is also reconfigurable. Students can modify the wiring of it. One of the exercises involves the maze competition for students.

GTR2010 is a four wheel didactic model of inspection robot for inspection of hardly accessible places (fig. 7 right). Every wheel is driven via independent DC motor.

**EDUCATIONAL MODELS FOR MECHATRONIC COURSES**

Tatiana Kelemenová; Peter Frankovský; Ivan Virgala; Ľubica Miková; Michal Kelemen; Lukáš Dominik

Students work on problem of generating of the trajectory and controlling of the wheels with electronic synchronization of rotation velocity and torque.

the rough terrain with obstacle avoiding with respecting of their stability.

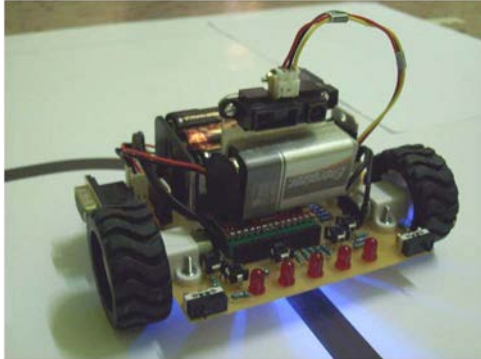

Figure 6 Didactic model of linefollower robot

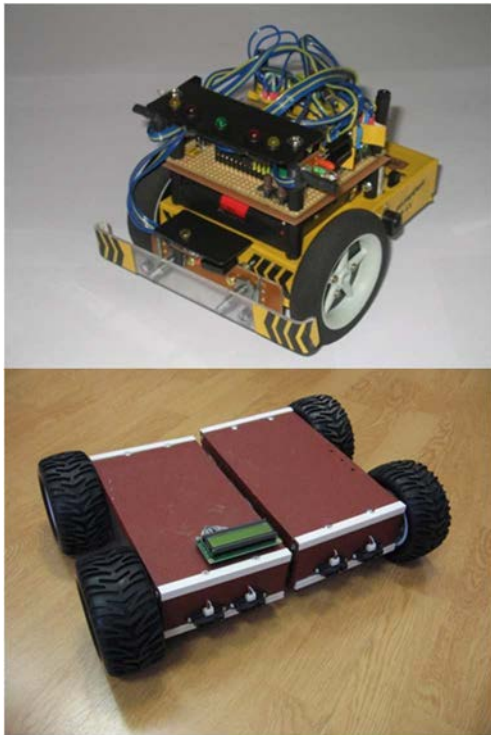

Figure 7 Wheeled didactic models

Linear manipulator XYZ and articulated manipulator with 5 DOF (degree of freedom) are also available. Students have possibility to practically practice the solving of the inverse kinematics problems and algorithms of feedback controlling. Also legged robots have been developed as didactic model for training on mechatronic courses. Several of them are shown on figure 8. Students can propose the algorithms of locomotion and they can also make optimization of locomotion with experimental verification. Practice of feedback position controlling under variable loading is allowed on these models. More complex tasks are as locomotion through

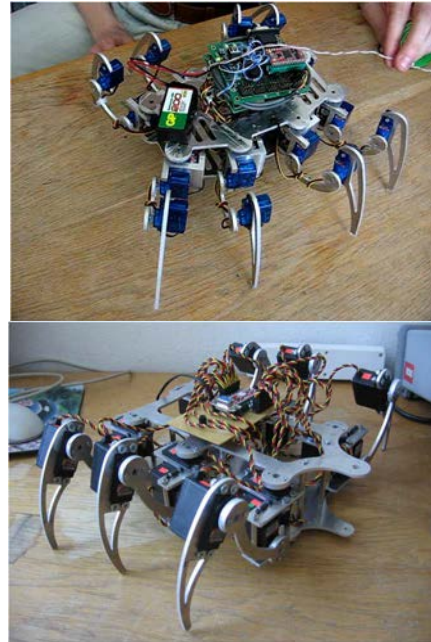

Figure 8 Didactic models of legged robots

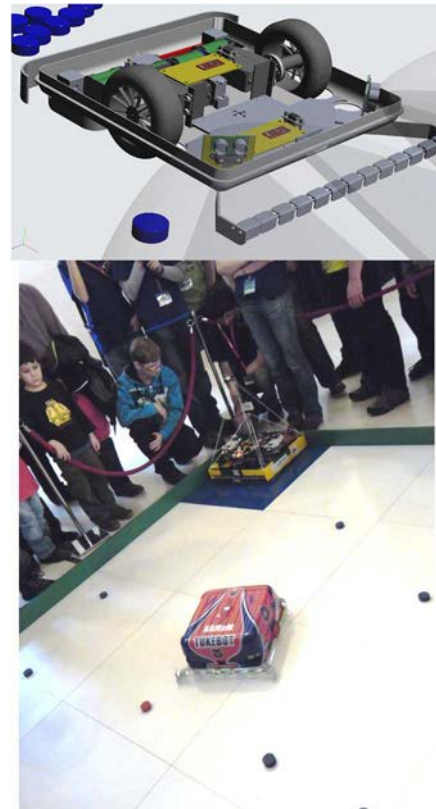

Figure 9 Puck collecting robot

Puck collecting is a competition category at RobotChallenge. The aim of this competition is to find and collect pucks with defined colour (blue or red) and



## EDUCATIONAL MODELS FOR MECHATRONIC COURSES

Tatiana Kelemenová; Peter Frankovský; Ivan Virgala; Ľubica Miková; Michal Kelemen; Lukáš Dominik

place them to home position with same colour. The robot has two wheeled undercarriage with differentially driven wheels. Robot (fig. 9) works as autonomous system and it has two microcontrollers for parallel controlling of processes. Robot is able to find and recognize puck and place it to home position defined with same colour. The designed robot Tukebot attended the competition RobotChallenge 2012.

Our students obtain many experiences and skills from robot design. For this reason, we are sure that this competition is perfect possibility for improvement of knowledge base of our students. Practice will also asks for solving of many complicated problems and situations.

Educational mobile hovercraft robot (fig. 10) has been developed by students. For lift and movement of hovercraft were selected blowers of type GWS 40B 6000KV, which have a built-in three-phase brushless motor with revolution KV=6000 (6000 revolutions per minute to 1V). The engine belongs between the inrunners, because the rotor spins inside. This brushless motor was preferred before DC motor and it's mainly due to the performance and service life. DC battery voltage is to be transformed into a three alternating voltage with phase displacement  $120^\circ$ , which will be fed into the blower. This transformation of the DC voltage to AC voltage allows us regulators of brushless engines.

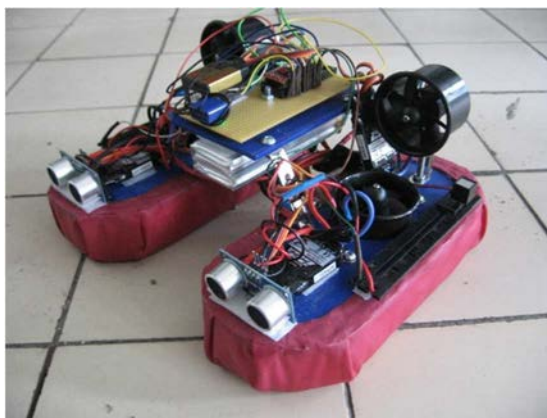

Figure 10 Mobile hovercraft robot

## 4 Conclusion

Mechatronics is multidisciplinary scientific area and training and exercises should be realized very practically. Everything what students learn at lectures is possible to try at exercises with working on didactic models. Students can also build own structures from basic building units. They can practice case study on real models through the heuristic methods. Teacher only defines the problem and input conditions. After that students can generate the possible solution with analysis and experimental verification of partial problems. Students can practice the team collaborative work or individual work. Consequently, students learn through the play. They can also attend of competition as RobotChallenge or Istrobot.

Didactic models help to prepare our students better for practice in real word [7-14].

During the educational process it is important for students to absorb the theoretical knowledge earned during the lectures and then to realize it practically in the laboratories. The level of the presented absorption of the knowledge depends, to a great extent, on realized cognitive methods and utilized didactic tools. The proposed didactic models are supporting the applied educational approach by solving the defined problem situation. This approach, first of all, applies the problem interpretation-method and heuristic and the research methods. The problem solving philosophy of the education is based on the fact that during the problem task solving and the same by the model situation problem solving processes the students are acquiring the experience from their creative activity and they are creatively mastering their knowledge and the ways of their activity. The students are joining the problem searching and problem solving processes through the activities of the teacher. This way the students are learning how to earn the new knowledge independently and they are applying their earlier acquired knowledge and along with it they are personally experienced from their creative activities. The practical realization of the task and the personal involvement in problem solving are imitating the team work and the individuals may be aware of their importance within it. This approach is also of psychological and social natures both for the individual person and for the realization team.

The creative thinking rises during the problem solving situation when the student collides with an obstruction, some difficulty in his activity, some conflict if he impacts something unknown and uneasy and surprising and incomprehensible, whereas he does not know the way of overcoming the problem or the obstruction and he can not solve it on the basis of his actual knowledge. In other words, the mechatronics is not only about the lectures and it has to pass to the students' hands. So that the hands may act, they are directed by the brain. The brain has to think what directive to get out and what activities will be performed by the hands. If something is coming to the student's hands really it means the integral chain of consideration and researching and the individual study and consultations among the team members and also with the pedagogue who is both the guardian and the anchorman of the entire project. In this manner the students are learning the philosophy of the mechatronics approach to the project of the products. Their, both the thinking and the creativity, are getting a new dimensions enabling the student's capability to get under better control the problem situations solving in the practice. And this manner trained graduates markedly increase the probability of their practice. The same they may to fortify the competitiveness of their employers [7-17].

**EDUCATIONAL MODELS FOR MECHATRONIC COURSES**

Tatiana Kelemenová; Peter Frankovský; Ivan Virgala; Ľubica Miková; Michal Kelemen; Lukáš Dominik

**Acknowledgement**

The authors would like to thank to Slovak Grant Agency – project VEGA 1/0872/16 and KEGA 048TUKE-4/2014. Authors also thank to Foundation of Tatra Banka for grant program project of Tatra banka eTalent 2016: ARMatic - Research of control algorithms of redundant robotic arm and project Quality of education 2016: DidacticBot - Innovation of teaching process of robotics and mechatronics.

**References**

- [1] ACAR, M., and PARKIN, R.M.: Engineering Education for Mechatronics, *IEEE Trans. on Industrial Electronics*, vol. 43, no. 1, pp. 106-112, Feb. 1996.
- [2] CASTLES, R. T., ZEPHIRIN, T., LOHANI, V. K., KACHROO, P.: Design and Implementation of a Mechatronics Learning Module in a Large First-Semester Engineering Course, *IEEE Trans. on Education*, vol. 53, no. 3, pp. 445-454, Aug. 2010.
- [3] OSTOJIC, G., STANKOVSKI, S., TARJAN, L., SENK, I. and JOVANOVIĆ, V.: Development and Implementation of Didactic Sets in Mechatronics and Industrial Engineering Courses, *Int. J. of Eng. Education*, vol. 26, no. 1, Tempus publications, 2010.
- [4] BRADLEY, D.: What is Mechatronics and Why Teach It?, *Int. J. of Electrical Eng. Education*, 41, (2004), pp. 275-291, 2004.
- [5] BRADLEY, D.: Mechatronics - More questions than answers, *Mechatronics*, vol. 20, no. 8, Special Issue on Theories and Methodologies for Mechatronics Design, pp. 827-841, Dec. 2010.
- [6] VITKO, A., JURIŠICA, L., BABINEC, A., DUCHOŇ, F., KLÚČIK, M.: *Some Didactic Problems of Teaching Robotics*, Proceedings of the 1st International Conference Robotics in Education 2010. Bratislava, 16.-17. 9. 2010, Bratislava, Slovak University of Technology in Bratislava, pp. 27-30, 2010.
- [7] OSTERTAGOVÁ, E.: *Computer aided learning at FEI TU Košice*. In: Proceeding of Int. Scientific Conf. on Innovation proces in e-learning. Bratislava, march, 10<sup>th</sup> 2011. pp. 1-5, 2011. (in Slovak).
- [8] van BEEK, T. J., ERDENA M. S., TOMIYAMAA, T.: Modular design of mechatronic systems with function modeling, *Mechatronics*, vol. 20, no. 8, pp. 850-863, Dec. 2010.
- [9] WANG, Y., YUA, Y., XIEA, Ch., WANGA, H., FENG, X.: Mechatronics education at CDHAW of Tongji University: Laboratory guidelines, framework, implementations and improvements, *Mechatronics*, vol. 19, no. 8, pp. 1346–1352, Dec. 2009.
- [10] KELEMEN, M., KELEMENOVÁ T. and JEZŇNÝ, J.: Four legged robot with feedback control of legs motion. In: *Bulletin of Applied Mechanics*. Vol. 4, no. 16 (2008), p. 115-118, 2008.
- [11] VIRGALA, I., VACKOVÁ, M., KELEMEN, M.: Two-legs walking robot "Wirgil". In: *Medical and treatment*. Vol. 40, no. 2 (2010), p. 32-35, 2010.
- [12] MIKOVÁ, Ľ., KELEMEN, M., KELEMENOVÁ, T.: Four wheeled inspection robot with differential controlling of wheels. In: *Acta Mechanica Slovaca*. Roč. 12, č. 3-B (2008), p. 548-558, 2008.
- [13] DUCHOŇ, F., HUBINSKÝ, P., HANZEL, J., BABINEC, A., TÖLGYESSY, M.: Intelligent Vehicles as the Robotic Applications, *Procedia Engineering*, Volume 48, 2012, Pages 105–114. 2012.
- [14] KONIAR, D., HARGAŠ, L., ŠTOFAN, S.: Segmentation of Motion Regions for Biomechanical Systems, *Procedia Engineering*, Volume 48, 2012, Pages 304–311. 2012.
- [15] BOŽEK, P., CHMELÍKOVÁ, G.: *Virtual Technology Utilization in Teaching*, Conference ICL2011, September 21 -23, 2011 Piešťany, Slovakia, pp- 409-413. 2011.
- [16] TURYGIN, Y., . BOŽEK, P.: Mechatronic systems maintenance and repair management system. *Transfer of innovations*, 26/2013. pp. 3-5. 2013.
- [17] HARGAŠ, L., HRIANKA, M., KONIAR, D., IZÁK, P.: *Quality Assessment SMT Technology by Virtual Instrumentation*. Applied Electronics 2007, 2007.

**Review process**

Single-blind peer reviewed process by two reviewers.

**USE OF CHILDREN'S GAMES IN ROBOTICS**

František Duchoň; Peter Beňo; Andrej Babinec; Martin Dekan; Jozef Dúbravský; Tomáš Jurnický; Josip Musič

Received: 22 Nov. 2016

Accepted: 03 Dec. 2016

**USE OF CHILDREN'S GAMES IN ROBOTICS****František Duchoň**

Slovak University of Technology, Vazovova 5, Bratislava, 81107, Slovak Republic, frantisek.duchon@stuba.sk

**Peter Beňo**

Slovak University of Technology, Vazovova 5, Bratislava, 81107, Slovak Republic, peter.beno@stuba.sk

**Andrej Babinec**

Slovak University of Technology, Vazovova 5, Bratislava, 81107, Slovak Republic, andrej.babinec@stuba.sk

**Martin Dekan**

Slovak University of Technology, Vazovova 5, Bratislava, 81107, Slovak Republic, martin.dekan@stuba.sk

**Jozef Dúbravský**

Slovak University of Technology, Vazovova 5, Bratislava, 81107, Slovak Republic, jozef.dubravsky@stuba.sk

**Tomáš Jurnický**

Slovak University of Technology, Vazovova 5, Bratislava, 81107, Slovak Republic, tomas.jurnicky@stuba.sk

**Josip Musič**

University of Split, Livanjska 5, Split, 21000, Croatia, jmusic@fesb.hr

**Keywords:** gesture, OpenCV, Kinect, game**Abstract:** The aim of this paper is overall proposal of artificial or robotic player for the game Rock – Paper – Scissors. The main contribution of this paper is the algorithm, which guarantees invincibility of artificial player against human player. Such algorithm could be than expanded by probabilistic model imitating other human players. As the basic hardware component RGB-D camera was chosen. Developed software is based on free libraries like OpenNI or OpenCV allowing wide distribution of such artificial player among scientific and professional public.**1 Introduction**

Game Rock – Paper – Scissors is a simple and well known game. This game was created in the 19th century in Japan and it is played by two players, which swing the one hand up and down for three times. In the third swing the player must choose from one of the following gestures: rock, paper, or scissors. Relations between the gestures are defined:

- Paper defeats rock.
- Rock defeats scissors.
- Scissors defeat paper.

In the case both players chose the same gesture, they must repeat whole round. It may seem as a lottery, but the game make possible some training, which allows the player to recognize opponent's gesture. The aim of this research is to propose such system (Fig. 1) which will be unbeatable in this game. Such system must use suitable visual systems, which allows detection of the gestures of human hands. Moreover, the system must be extendible to playing with robotic hand.

**2 State of the art**

The most known and probably the only robot that always beats the human in Rock – Paper – Scissors is named Janken [1]. This robotic hand was developed in Japan and it uses high speed camera (600 fps) with the resolution 1280x700 pixels. Due to used high speed camera, the whole system is unbeatable by human [2, 3]. Janken is

equipped by three fingers allowing it to show all the gestures (Fig. 2). First version of this robot recognized the human gesture after the human hand stopped its movement. Consequently system recognized the gesture and represented the opposite gesture by the rules of the game. This version had time delay 20 ms. As the human is able to recognize time delay between 30 and 60 ms, the human player does not aware the principle used in Janken. However, when the game is recorded by high speed camera, it is clear that robotic hand reacts later than human hand [1].

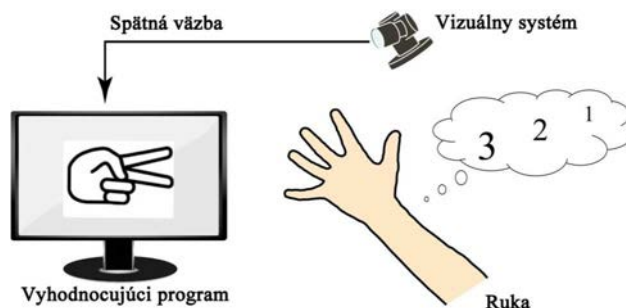

Figure 1 Architecture of the system

Second prototype of Janken solves this timing problem and the gesture of the robot is represented together with human one. Janken have 8 joints and 3 fingers [2]. Generally this robotic hand is characterized by



## USE OF CHILDREN'S GAMES IN ROBOTICS

František Duchoň; Peter Beňo; Andrej Babinec; Martin Dekan; Jozef Dúbravský; Tomáš Jurnický; Josip Musič

low weight, high speed, acceleration and accuracy. Janken have 9 DOF.

Another robot playing this game is called Berti (Bristol Elumotion Robotic Torso) (Fig. 3). It is a humanoid robot, which was learnt to play the game [2]. This robot does not use any visual system. Human opponent must use artificial glove, which is used for the gesture recognition. Such system is slow despite the fact that Berti is not used only for this game.



Figure 2 Robotic hand Janken from the University of Tokyo



Figure 3 Robot Berti

As the suitable visual system for the game Rock – Paper – Scissors camera Microsoft Kinect [4] was selected. There were several reasons:

- Is is cheap.
- It has depth measurement.
- It is easy to find human skeleton with the usage of already existing libraries.

Despite these advantages, there are some disadvantages, which may make it difficult to solve. Especially lower camera resolution and frame rate are the properties, which are disadvantageous compared to above mentioned applications.

### 3 Gestures detection

Infrared emitter used in Microsoft Kinect transmits the structured pattern with the wave-length 830 nm. Deformations of this pattern are detected by coupled camera. Consequently distances of each pixel on RGB camera are computed. Measuring range is dependent on used technology. With the usage of OpenNI library [5] 0.4 m minimal measuring distance and 4.5 maximal

measuring distance can be achieved (Fig. 4). Accordingly the human player must stand in front of the Kinect camera somewhere between these two distances.



Figure 4 Disparity map obtained from Microsoft Kinect. Black dots represent incorrect measurements. This is due to objects situated closer than minimal measuring range or visible light, which transilluminates the transmitter.

Gestures detection implemented in the algorithm is based on the detection of hand, palm and fingers. First step of the algorithm is to find the human player. This was done with the NiTE library [6], which already contains functions to find human bodies and their skeletons in the Kinect data. Output of the library can provide identification of human body (skeleton) with up to 15 joints. Consequently, only right hand of the human player is chosen from this skeleton. Synchronization of the game is performed by point, which must be “touched” by human player’s right hand (Fig. 5). Let’s name this point a red point. This point represents some imaginary centre of the palm. If the red point touched the synchronization point (green circle) then the game is started and the algorithm starts to trace the hand’s movement.

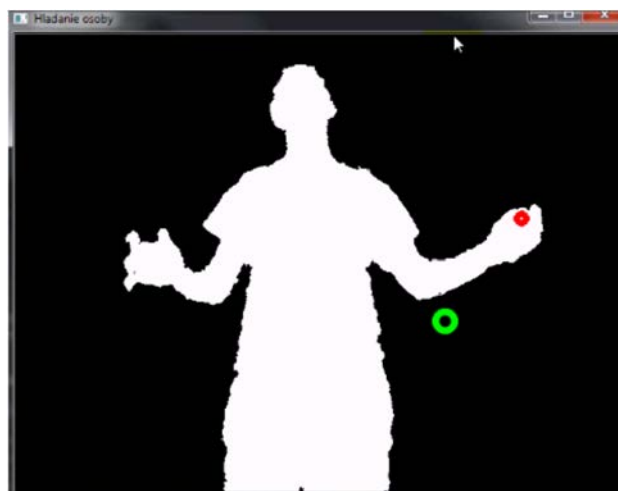

Figure 5 Skeleton identified by NiTE library. A red circle marks the right hand (human stands in front of the camera) and a green circle is the synchronization point.



**USE OF CHILDREN'S GAMES IN ROBOTICS**

František Duchoň; Peter Beňo; Andrej Babinec; Martin Dekan; Jozef Dúbravský; Tomáš Jurnický; Josip Musič

Second step of the algorithm uses the detected joint of the right palm. Consequently, ROI around this joint is created (Fig 6). Actual gestures of the right hand are detected by the positions of the fingers. These positions are determined by the simpler objects, e.g. contours. Such contours are easy to create, for example algorithm Suzuki85 can be used [7] (Fig. 6).



Figure 6 ROI around the right palm and corresponding contours detected by Suzuki85 algorithm.

Detection of the fingers is based on the convex defects. Therefore it is needed to create the convex hull of the hand. Convex hull is defined as the smallest set of the points in the Euclidean space, which contains all of the given points. It can be easily visualized as an elastic band stretched around all of the given points. For the detection of the convex hull Skalansky82 algorithm (Fig. 7) can be used [8].

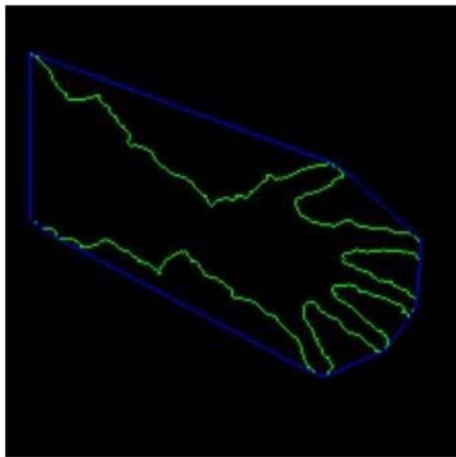

Figure 7 Convex hull of the right hand.

Convex defects (or convexity defects) of the hand are shown in Fig. 8. Black line marks the convex hull. Convex defects are defined as a space between contours of the object and its convex hull. On the hand 8 convex defects can be defined.

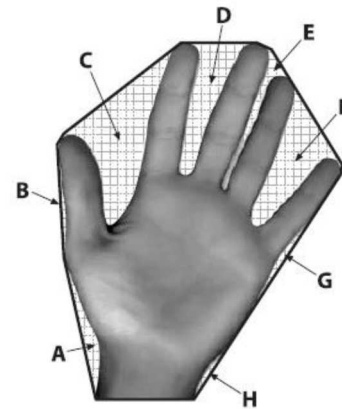

Figure 8 Convex defects between contours and convex hull of the hand. Defects are marked by the letters A – H.

Proposed algorithm identifies these three states (Fig. 9):

- The number of the defects is more than four – the human player showed the gesture of paper.
- The number of the defects is in the range from one to four – the human player showed the gesture of scissors.
- The number of defects is in the range from zero to one – the human player showed the gesture of rock.

This gesture detection was derived empirically.

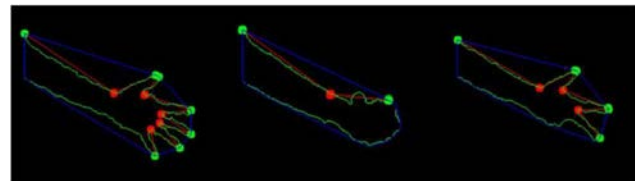

Figure 9 Three gestures distinguishable by number of convex defects (red circles) and points of convex hull (green circles) (from left to right: paper, rock, and scissors).

The game Rock – Paper – Scissors does not consist only of detection of gestures, but also so-called “hip hap hop” movement of hand must be performed and well detected. In proposed algorithm this is done by the detection of red point, which remarks the position of the right hand (Fig. 5). However, the library NiTE does not detect the hand with 100% accuracy. This causes the detection of hand’s movement despite the hand is in static position. Such noise should be filtered – if the difference between two consequent points in the y axis is positive and is larger than:

$$\frac{30px}{HandDistance/1000} \quad (1)$$

Then the hand moves upwards. The movement downwards is detected in similar way. If the difference is negative, then the hand moves downwards. The parameter *HandDistance* is determined by depth measurements of Kinect camera. If the Kinect is not able to determine the distance to the hand (i.e. red point marking the hand), then the closest pixel with value different from 0 is taken

## USE OF CHILDREN'S GAMES IN ROBOTICS

František Duchoň; Peter Beňo; Andrej Babinec; Martin Dekan; Jozef Dúbravský; Tomáš Jurnický; Josip Musič

into account. The general purpose of this computation is the various movement of the hand measured in the pixels, which is dependent on the distance between human and Kinect sensor. Within the last movement of “hip hap hop” algorithm detects the ROI with corresponding gesture.

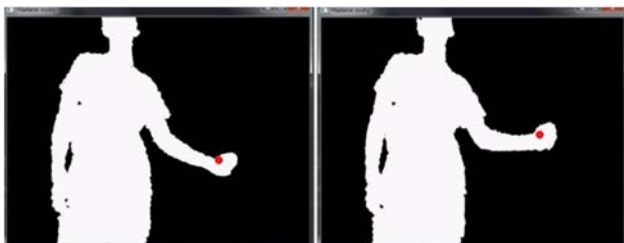

Figure 10 Scanning of the hand's movement – movement of the hand between two consequent frames.

## 4 Results

Accurate percentage of success gesture's detection cannot be expressed, because it is dependent on several conditions:

### 1. The distance of human player from the camera.

With increasing distance of human player from the camera, the resolution of the hand in the image is reduced. Consequently, the number of pixels representing the hand is reduced and the algorithm is unable to determine the convex defects. Lower number of defects and corners of convex hull causes wrong detection of the gesture. Sufficient resolution of the hand is provided, when the human player stands in the distance range from 0.6 to 1.2 meters (Fig. 11).

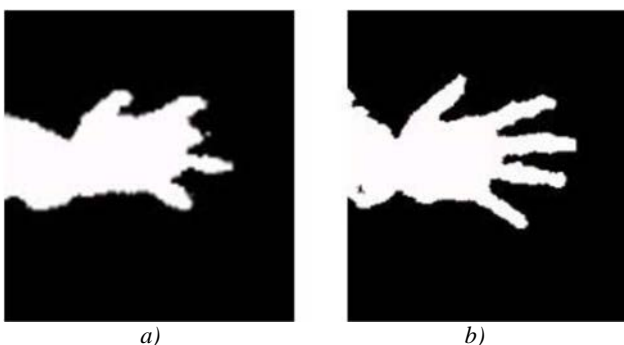

Figure 11 Resolution of the hand in the image – a) insufficient in the distance 2 m b) sufficient in the distance 0.7 m.

### 2. Accurate detection of the gesture itself.

If the gesture is detected, there can be problem with distinction between gestures scissors and rock. This is shown in Fig. 12. Such situation could occur when the scissors and rock gestures have equal number of defects (red points) and convex hull points (green points). Correct detection of the scissors gesture may be increased by the rising the thumb. The largest number of correct detections was obtained within the gesture paper.

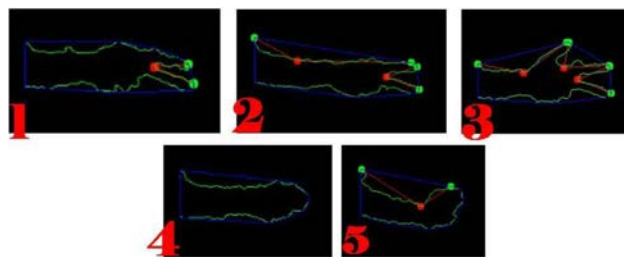

Figure 12 Problematic distinction between two different gestures – scissors in 1 and rock in 5.

### 3. Capture of the hand's movement.

This is the largest source of the errors of the whole algorithm. If the algorithm does not correctly register all the six hip-hap-hop movements (each is defined by two consequent moves – up and down), whole process fails. In that case the game is needed to be restarted. Other error can occur if the right palm is incorrectly detected in NiTE library.

### 4. The position of the human player with respect to the camera's position.

If the position of the human player is not perpendicular to the camera, or the hand is covered by the player's body, the detection of the hand may fail. Correct position of the human player is shown in Fig. 13.

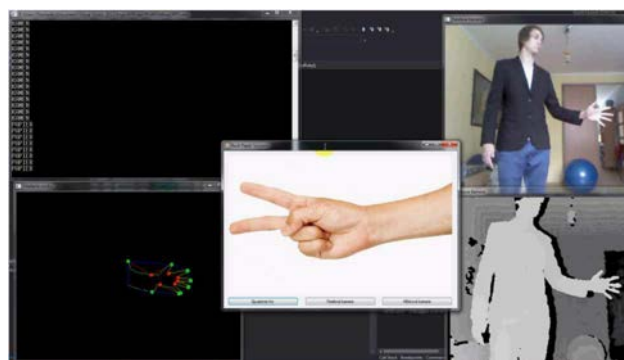

Figure 13 Correct position of the human player with respect to the camera's position.

If all these conditions are fulfilled, then the algorithm is almost unbeatable. From twenty attempts algorithm won over our human player eighteen times. Both non-winning attempts were caused by incorrect detection of the hand's movement (hip-hap-hop).

## 5 Conclusion and future work

The most common problem of created artificial player was scanning of hand's motion. It was based on the available libraries for Kinect. These libraries not always return correct position of the joints, which means complete stop of the actual game. If the scanning is correct then the accuracy of gesture detection is over 95 %. This was also confirmed by testing of the application on the event Istrobot 2016, where the game was played by

**USE OF CHILDREN'S GAMES IN ROBOTICS**

František Duchoň; Peter Beňo; Andrej Babinec; Martin Dekan; Jozef Dúbravský; Tomáš Jurnický; Josip Musič

random passers-by. However, this testing also revealed that human players are anticipating some movement of virtual hand and there were some problems with the initial posture of human players. That is why the future work on this project will require the usage of more accurate sensor. This could be provided by sensor Kinect 2.0, which is more accurate than its first version. Moreover, the resolution of Kinect 2.0 is higher, so we are expecting also higher accuracy of hand's scanning. Improvement in enjoyment of the game should be brought also by a real robotic hand, e.g. Shadow Dexterous Hand [9], or 5-Finger Servo Electric Gripping Hand SVH from company SCHUNK [10,11]. However these robotic hands are very expensive (their price may be higher than a few thousand of EUR), and at that moment we had not owned any such device. It is obvious that proposed system is almost unbeatable, but it also allows some fun for humans in a modern way. This is confirmed by recorded video [11].

- [9] Shadow Robot Company, [Online], Available: <https://www.shadowrobot.com/products/dexterous-hand/> [30 Nov 2016], 2016.
- [10] ĎUROVSKÝ, F.: *Smart Robotic System. SRS.* [Online], Available: <http://www.smartroboticsys.eu/?p=928>, 2015.
- [11] JOHNSON, J.: Children, robotics, and education, *Artificial Life and Robotics*, Vol. 7 No. 1-2, pp. 16-21, 2003.
- [12] YouTube, [Online], Available: <https://www.youtube.com/watch?v=YCRaT4TClns&feature=youtu.be> [30 Nov 2016], 2016.

**Review process**

Single-blind peer reviewed process by two reviewers.

**Acknowledgement**

This work was supported by grants KEGA 003STU-4/2014, APVV-14-0894, VEGA 1/0065/16.

**References**

- [1] Tokyo, The University of. Ishikawa Watanabe Laboratory. [Online], Available: <http://www.k2.t.u-tokyo.ac.jp/fusion/Janken/index-e.html> [29 Nov 2016], 2011.
- [2] NAMIKI, A., IMAI, Y., ISHIKAWA, M., KANEKO, M.: *Development of a high-speed multifingered hand system and its application to catching*, In: Intelligent Robots and Systems, Proceedings. 2003 IEEE/RSJ International Conference on Vol. 3, pp. 2666-2671, 2003.
- [3] YIRKA, B.: *Robot hand wins at rock, paper, scissors every time*, [Online], Available, <http://phys.org/news/2012-06-robot-paper-scissors-video.html> [29 Nov 2016], 2012.
- [4] JURNICKÝ, T.: *Využitie špeciálneho vizuálneho systému v servisnej robotike*, Bakalárska práca. Bratislava: FEI STU, 2014. (Original in Slovak)
- [5] Open NI Library, [Online], Available: <https://github.com/OpenNI/OpenNI> [30 Nov 2016], 2012.
- [6] NiTE Library, [Online], Available: <http://openni.ru/files/nite> [30 Nov 2016], 2012.
- [7] OpenCV Documentation, [Online], Available: [http://docs.opencv.org/2.4/modules/imgproc/doc/structural\\_analysis\\_and\\_shape\\_descriptors.html?highlight=findcontours#findcontours](http://docs.opencv.org/2.4/modules/imgproc/doc/structural_analysis_and_shape_descriptors.html?highlight=findcontours#findcontours) [30 Nov 2016], 2016.
- [8] OpenCV Documentation, [Online], Available: [http://docs.opencv.org/2.4/modules/imgproc/doc/structural\\_analysis\\_and\\_shape\\_descriptors.html?highlight=convexhull#convexhull](http://docs.opencv.org/2.4/modules/imgproc/doc/structural_analysis_and_shape_descriptors.html?highlight=convexhull#convexhull) [30 Nov 2016], 2016.



*Received: 27 Nov. 2016**Accepted: 15 Dec. 2016*

## **COMPUTER SIMULATION OF THE MECHANICAL SYSTEM WITH ONE DEGREE OF FREEDOM**

**Darina Hroncová**

Department of Mechatronics, Faculty of Mechanical Engineering, Technical University of Košice, Park Komenského 8, 042 00 Košice, Slovakia, darina.hroncova@tuke.sk

**Alexander Gmitterko**

Department of Mechatronics, Faculty of Mechanical Engineering, Technical University of Košice, Park Komenského 8, 042 00 Košice, Slovakia, alexander.gmitterko@tuke.sk

**Tomáš Lipták**

Department of Mechatronics, Faculty of Mechanical Engineering, Technical University of Košice, Park Komenského 8, 042 00 Košice, Slovakia, tomas.liptak@tuke.sk

**Mojmír Bruchánek**

Faculty of Mechanical Engineering, Technical University of Košice, Letná 9, 042 00 Košice, Slovakia, mojmir.bruchanek@tuke.sk

**Keywords:** simulation, mechanical system, equation of motion, Matlab, Simulink

**Abstract:** This paper deals with analyze the model of the oscillating mechanical system with one degree of freedom. In this article the vibration of the car seat with driver is solved. It is a problem that is common in technical practice in the assessment of driver comfort when driving a car. It presents the possibilities of physical modeling in Matlab/Simulink. When used, it is necessary to describe the studied system with dynamic equations. The task of the paper is to create a mathematical model and computer simulation model. The results of these solutions are created in the form of graphs.

### **1 Introduction**

Modeling of mechanical systems using available software tools is a frequently occurring phenomenon in engineering practice. Compilation of the models, systems, whether mathematical or dynamical expressed by mathematical modeling and experimental identification is the current issues in the engineering industry. Such simulated respectively modeled situations mechanical systems we can examine in Matlab and Simulink. In modeling and simulating computer may change the parameters systems conduct without any risk disrepair [1].

### **2 Modeling of the objects**

Object modeling modeling process is a system where certain criteria assigns physical or abstract model. There are two types of models, original and abstract. In the original model can not perform experiments, as with abstract models, where we simulate real situations. We create simulations with the help of mathematical models and solution is done using numerical methods with differential equations in simulation programs.

Abstract model we can compare with the original model, but three types of similarities are known, which represent the characteristics of the model:

1. physical similarity - the same substance of the system and of the processes and also of the parameters and state space parameters,

2. mathematical similarity - is the mathematical description of systems and processes,

3. cybernetics similarity - mathematical similarity in the behavior of the internal systems. System information in the internal structure and internal variables are unknown to us [1].

### **3 External description of the dynamical systems**

In engineering practice we can meet the following forms of external description of linear dynamic systems [2]:

1. Differential equation
2. The Laplace transform
3. Frequency response
4. Impulse response
5. Transfer characteristics
6. Nyquist response
7. Bode characteristics

### **4 Modeling of mechanical systems**

In studying properties in mechanical systems always we replace true system with the simulation model that has the same properties. In examining of the dynamic phenomena are replacing real system with dynamic model. For this then we compiled mathematical model. In addressing vibration of mechanical systems,

**COMPUTER SIMULATION OF THE MECHANICAL SYSTEM WITH ONE DEGREE OF FREEDOM**

Darina Hroncová; Alexander Gmitterko; Tomáš Lipták; Mojmír Bruchánek

constructed a mathematical model is describes with the system of differential equations [6].

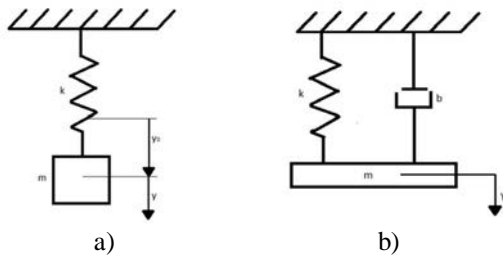

Figure 1 Mechanical system a) mass and spring, b) mass, spring and damper

In the initial phase of the analysis it is appropriate as first used simple models of mechanical systems that analyze the basic properties. Basic models can be used to describe the behaviour of different pieces of equipment. There utilize for it the simple mechanical systems with one degree of freedom of movement. Types of simple vibration patterns in different types of drive power are shown in Figure 1 to Figure 3 [1], [2].

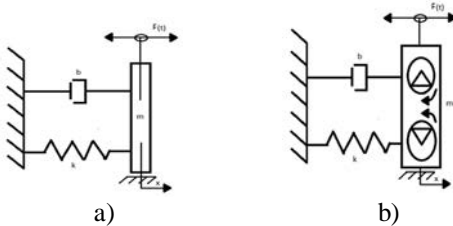

Figure 2 Mechanical system a) excitation force, b) harmonic excitation

In the following parts the article pays attention derivation to derive the dynamical equations to solve the mechanical system and its solution using Matlab and Simulink [4-5]. Use them to derive dynamical equations using Newton's equations, the method of release.

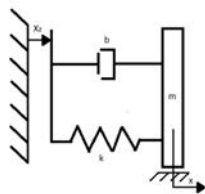

Figure 3 Mechanical system with kinematic excitation

The next part contains a model with one degree of freedom, which is the car seat with driver and his vibration.

## 5 Mechanical system

Anatomic car seat (Figure 4) must meet the exacting requirements that are placed on the health, comfort, convenience and safety. The emphasis is on utility ergonomic and aesthetic qualities and the ability of damping. The car seat is equipped with displacement and

uprise, increased lateral edge opera guarantees a relaxed and comfortable seating [2].

In order to derive analytical mathematical model of car seat we can be based on a simplified model. This is essentially a mass  $m$  consist mass of driver  $m_v$ , car seat and all devices for damping resilient suspension with mass  $m_s$  [3].

This mechanical system is a mass  $m$  mounted on the frame with springs  $k$  and dampers  $b$  and load by the gravitational force of the driver (Figure 4c). It is the mechanical system with one degree of freedom of movement. The equation of motion is expressed by linear differential equations with constant coefficients with the right side (1). After the creating of a dynamic and mathematical model it used to simulate the program Matlab/Simulink [6], [7].

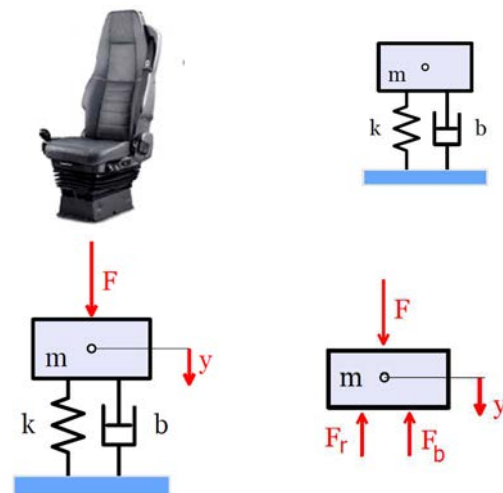

Figure 4 Mechanical system a) of car seat, b) model of the car seat, c) model with external excitation, d) model with the reaction forces and external excitation

Solving the problem of system is considered with the weight of car seat 20 kg and weight force of the driver 100 kg . The weight of the car seat with the driver is then  $m=120$  kg . It is envisaged acceleration of gravity  $g = 9.81 \text{ m.s}^{-2}$ , the spring constant  $k=9600 \text{ N/m}$  and damping coefficient  $b=2400 \text{ N.s/m}$ . It is considered the excitation force that represents the gravitational force of the driver of vehicle  $F=m_v \cdot g = 981 \text{ N}$  [3]. The system consists of the mass  $m$ , which is mounted on the frame with the spring with spring constant  $k$  and damper with the damping factor  $b$  (Figure 4b). In the next picture the model is loaded with constant force  $F$  and displacement of the system (Figure 4c) is  $y(t)$ . Compile equations of motion is made using Newton's laws of motion. The seat is released from the bonds and the bonds are replaced by reactions as shown in Figure 4d.

Dynamical equation of the mechanical system is shown in form:

**COMPUTER SIMULATION OF THE MECHANICAL SYSTEM WITH ONE DEGREE OF FREEDOM**

Darina Hroncová; Alexander Gmitterko; Tomáš Lipták; Mojmír Bruchánek

$$m \ddot{y} + b \dot{y} + k y = F \quad (1)$$

where

$m$  – mass of the car seat and driver [kg],

$F$  – excitation force of driver [N],

$k$  – spring constant [N/m],

$b$  – dumping constant [N/(m/s)].

## 6 Numerical solution of differential equations in Matlab

Derived equation of motion in this chapter adjusted to the system of two differential equations of first order [6]. These can also be resolved, for example, using the Matlab [14]. Equations are entered in m-files for values:  $m=120$  kg,  $k=9600$  N/m,  $b=2400$  N.s/m,  $F=981$  N.

Marking:

$$x(1) = y(t), \quad (2)$$

$$x(2) = \frac{dy(t)}{dt}, \quad (3)$$

we write the two first order differential equations in the form:

$$\frac{dx(1)}{dt} = x(2), \quad (4)$$

$$\frac{dx(2)}{dt} = -\frac{b}{m}x(2) - \frac{k}{m}x(1) + \frac{F}{m} \quad (5)$$

M-file in Matlab simulation [7]:

```
% car seat and driver
[t,x]=ode45(@funkcia_seat,[0 5],[0;0]);
% [0 5] - Time Simulation ,
% [0;0] - Initial Condition,
plot(t,x)
title('Displacement and velocity y(t), ...
v(t)');
xlabel('Time (sec)');
ylabel('y(t) , v(t)');
grid on;
legend('y=y(t)', 'v=v(t)')
```

Function is in form:

```
function dx=funkcia_seat(t,x)
m=120; k=9600; b=2400;
F=981;
dx=[x(2); -k * x(1) / m - b * x(2) / m...
+ F/m];
```

The results of the simulation are displacement  $y(t)$  and velocity  $v(t)$  of car seat with driver (Figure 5).

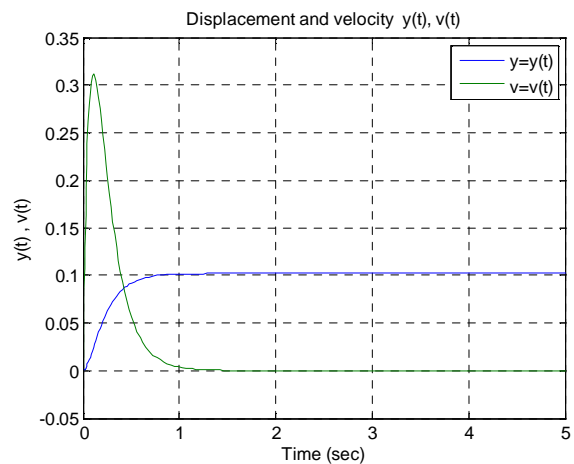

Figure 5 Displacement and velocity of car seat

Dynamic system with car seat vibration is according to the profile displacement and velocity stable [15]. After touch down on the car seat there is a transient, who is the ultimate time practically ceased. After a reasonable period of time will be displacement of car seat  $y = 981/9600 = 0.102$  m.

## 7 Computer simulation in Simulink

### 7.1 Differential equation of the mechanical system

Using Simulink [10] in this chapter shows how to compile block diagrams by blocks located in different libraries Simulink, which is one of the best known and most widely used Matlab extensions. It uses Matlab [11] for modeling, simulation and analysis in an easy graphical user interface. Equations in the form:

$$\ddot{y} = -\frac{b}{m} \dot{y} - \frac{k}{m} y + \frac{1}{m} F \quad (6)$$

is used in the simulation program Matlab/Simulink [12], and from there is constructed a further block diagram of the picture(Figure 6).

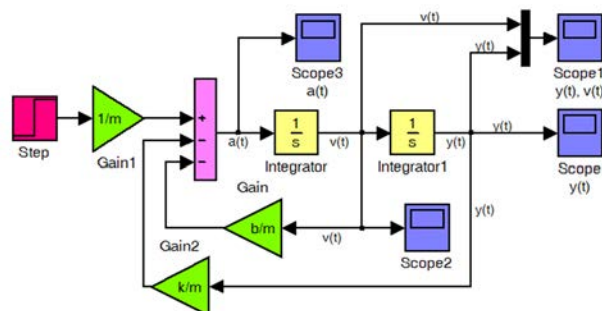

Figure 6 Block scheme of the differential equation (6) in Simulink

From equation (4) and (5):

$$\frac{dy(t)}{dt} = v(t), \quad (7)$$



**COMPUTER SIMULATION OF THE MECHANICAL SYSTEM WITH ONE DEGREE OF FREEDOM**

Darina Hroncová; Alexander Gmitterko; Tomáš Lipták; Mojmír Bruchánek

$$\frac{dv(t)}{dt} = -\frac{b}{m}v(t) - \frac{k}{m}y(t) + \frac{1}{m}F, \quad (8)$$

is compile the following block diagram (Figure 7). The results of the solutions are the same as we expected (Figure5).

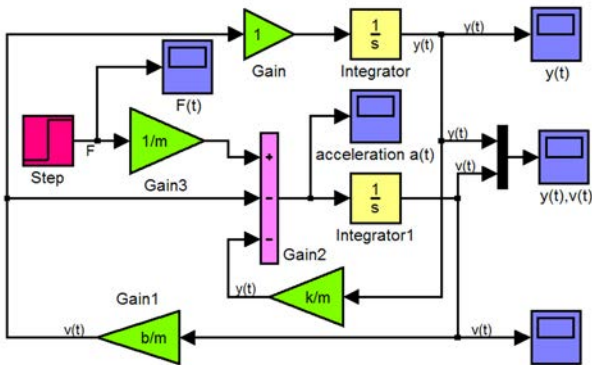

Figure 7 Block scheme of the differential equation (7) and (8)

Time course of kinematics variables of car seat and driver are displacement (Figure 8), velocity (Figure 9) and acceleration (Figure 10) in graphical form [6], [7] shown below:

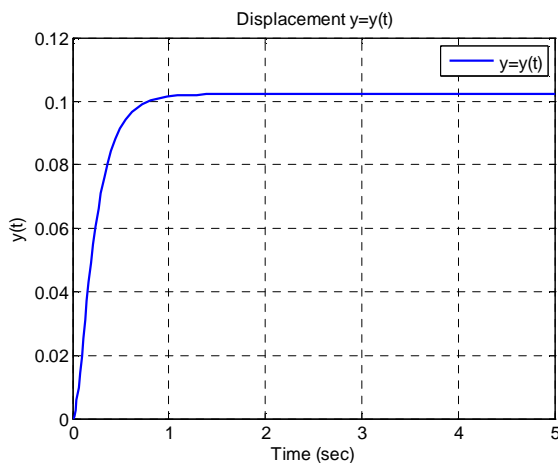

Figure 8 Displacement of the mechanical system

M-file in form:

```
figure(1)
set(1,'Name','Displacement y=y(t)')
plot(Scope_y.time,Scope_y.signals.values ...
(:,1:1),'b','LineWidth', 1.5)
title('Displacement y=y(t)'),...
legend('y=y(t)'),
xlabel('Time (sec)'),...
ylabel('y(t)'),...
grid on
```

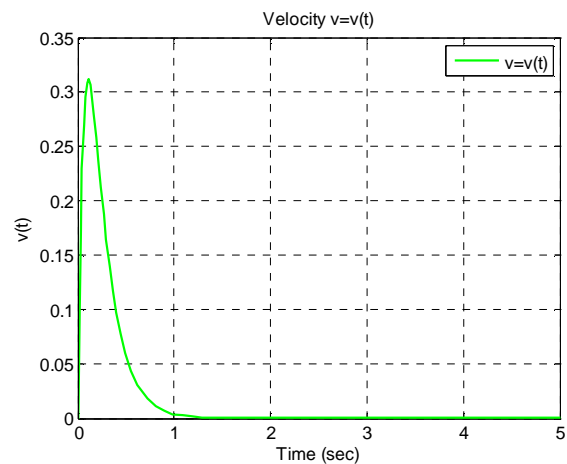

Figure 9 Velocity of the mechanical system

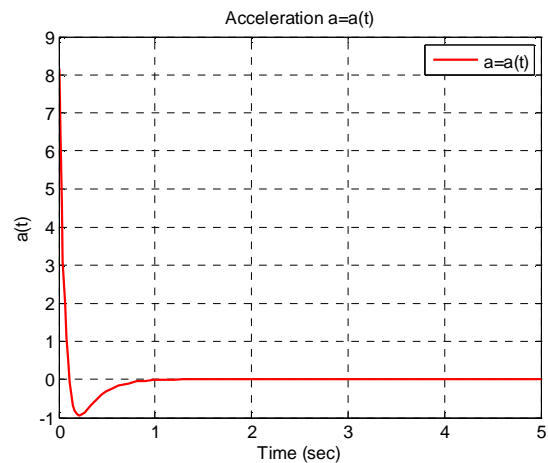

Figure 10 Acceleration of the mechanical system

## 7.2 Transfer function of mechanical system

Transfer function of the system is defined in form:

$$G(s) = \frac{Y(s)}{U(s)} \quad (9)$$

where

$Y(s)$  – is Laplace s-domain of the time domain function  $y(t)$ , the output of system,

$U(s)$  – is Laplace s-domain of the time domain function  $F(t)$ , the input force of system.

For initial condition in form  $y(0)=0$ ,  $v(0)=0$ , we write the equation of motion (1) in next form [9]:

$$mY(s)s^2 + bY(s)s + kY(s) = U(s) \quad (10)$$

Transfer function is shown in form:

$$G(s) = \frac{1/m}{s^2 + (b/m)s + (k/m)} \quad (11)$$

After compile the block diagram in Simulink (Figure 11) is the result of the solution of mechanical system with using the transfer function of the system (Transfer Fcn) the output  $y(t)$ , which is the displacement of the mechanical system [14],[15].

**COMPUTER SIMULATION OF THE MECHANICAL SYSTEM WITH ONE DEGREE OF FREEDOM**

Darina Hroncová; Alexander Gmitterko; Tomáš Lipták; Mojmír Bruchánek

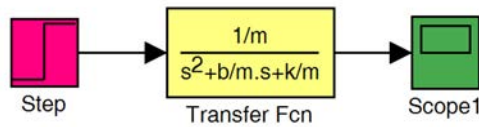

Figure 11 Simulation scheme with Transfer Fcn.

Results of the simulation with block scheme in Simulink are identical with the course in Figure 8.

### 7.3 State - space of the mechanical system

State-space equation of the mechanical system [7-8] in matrix form we write:

$$\begin{bmatrix} \frac{dx(t)}{dt} \\ \frac{dv(t)}{dt} \end{bmatrix} = \begin{bmatrix} 0 & 1 \\ -\frac{k}{m} & -\frac{b}{m} \end{bmatrix} \cdot \begin{bmatrix} x(t) \\ v(t) \end{bmatrix} + \begin{bmatrix} 0 \\ \frac{1}{m} \end{bmatrix} \cdot F(t) \quad (12)$$

The most general state-space representation of a linear system is written in the following form:

$$\dot{\mathbf{x}}(t) = \mathbf{A} \cdot \mathbf{x}(t) + \mathbf{B} \cdot \mathbf{u}(t) \quad (13)$$

$$\mathbf{y}(t) = \mathbf{C} \cdot \mathbf{x}(t) + \mathbf{D} \cdot \mathbf{u}(t) \quad (14)$$

can be written as:

$$\begin{bmatrix} \dot{x} \\ \dot{v} \end{bmatrix} = \mathbf{A} \cdot \begin{bmatrix} x \\ v \end{bmatrix} + \mathbf{B} \cdot F(t) \quad (15)$$

$$y = \mathbf{C} \cdot \begin{bmatrix} x \\ v \end{bmatrix} + \mathbf{D} \cdot F(t) \quad (16)$$

The state space matrix are in the form:

$$\mathbf{A} = \begin{bmatrix} 0 & 1 \\ -\frac{k}{m} & -\frac{b}{m} \end{bmatrix}, \quad \mathbf{B} = \begin{bmatrix} 0 \\ \frac{1}{m} \end{bmatrix}, \quad (17)$$

$$\mathbf{C} = [1 \quad 0], \quad \mathbf{D} = [0], \quad (18)$$

written as:

$$\begin{bmatrix} \dot{x} \\ \dot{v} \end{bmatrix} = \begin{bmatrix} 0 & 1 \\ -\frac{k}{m} & -\frac{b}{m} \end{bmatrix} \cdot \begin{bmatrix} x \\ v \end{bmatrix} + \begin{bmatrix} 0 \\ \frac{1}{m} \end{bmatrix} \cdot F(t) \quad (19)$$

where

input  $u(t)$  is the excitation force  $F(t)$  and output  $y(t)$  is the displacement,

$u(t)$  - is called the input (or control) vector,

$y(t)$  - is called the output vector,

$x(t)$  - is called the state vector,

$A$  - is the state (or space) matrix,

$B$  - is the input matrix,

$C$  - is the output matrix,

$D$  - is the feedforward matrix (for many physical systems is the null matrix).

The scheme in Simulink:

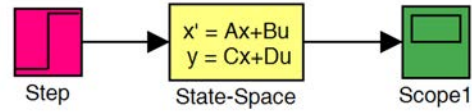

Figure 12 Block scheme with State Space

For the comparison of the results is given in the following scheme:

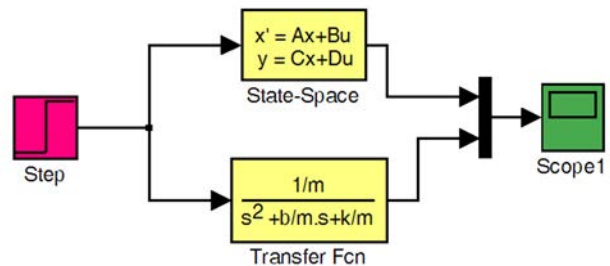

Figure 13 Simulink scheme with State Space and Transfer Fcn

Write in the command line is rendered characteristics of the transfer function, which is displacement of the model seat of car [3]. The matrix  $B$  is multiplied by the input, in dealing with a case, force  $u = F$ :

```
<<step(A,u*B,C,D)
```

The output of the solution is the characteristics of the transfer function, which is deflection of seat [15]:

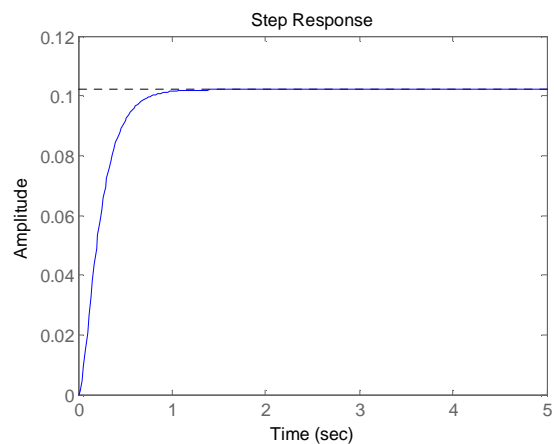

Figure 14 Step response in Simulink

Type in the command line is defined the transfer function of the system in Matlab with transformation from State-Space [12-13]:

```
>> [num,den] = ss2tf(A,B,C,D)
```

Answer from Matlab:

```
num =
0 0 0.0083
den =
1 20 80
```

Type in the command line is defined the characteristics of transfer function Step Response of the system. Numerator multiplied with inputs  $u$ , in solving

**COMPUTER SIMULATION OF THE MECHANICAL SYSTEM WITH ONE DEGREE OF FREEDOM**

Darina Hroncová; Alexander Gmitterko; Tomáš Lipták; Mojmír Bruchánek

case with force  $F = 981\text{N}$  and we define simulation time  $T=5$  seconds:

```
>> step(u*num,den,T)
```

A window with characteristics of transfer function opens. It is identical with the course in Figure 14.

## Conclusions

In this paper they were shown to solve the dynamic equations of motion of a mechanical system with one degree of freedom of the oscillating system car seat with driver. The system was calculated using computer simulation. From assembled block diagrams in Simulink program, compiled m-files in Matlab and 2D graphics are acquired waveforms kinematics variables of the system car seat with driver. The results obtained are illustrated in the number of outputs in the form of graphs and were used various block diagrams investigating mechanical system. Simulation models are compiled in different ways, using the full range of the blocks includes a library of Matlab and Simulink. The result is more detailed and deeper acquaintance with that issue. The processed results can be utilized in further addressing similar problems in mechanics and mechatronics. Article in its form is a powerful draw lessons for teaching purposes in subjects with a focus on solving dynamic systems in subject mechanics and mechatronics.

## Acknowledgement

This work was supported by grant projects KEGA 048TUKE-4/2014 Increasing of knowledge base of students in area of application of embedded systems in mechatronic systems, KEGA 054TUKE-4/2014 The use of advanced numerical methods of mechanics as the basis for constructing the scientific development of the knowledge base of students second and third degree university study, grant projects VEGA1/0872/16 Research of synthetic and biological inspired locomotion of mechatronic systems in rugged terrain and grant projects VEGA 1/0731/16 Development of advanced numerical and experimental methods for the analysis of mechanical.

## References

- [1] STRADIOT, J., MICHALÍČEK, M., MUDRÍK, J., SLAVKOVSKÝ, J., ZÁHOREC, O., ŽIARAN, S.: *Dynamika strojov*, Vydavateľstvo Alfa, Bratislava, 1991. (Original in Slovak)
- [2] BRUCHÁNEK, M.: *Modelovanie mechanických systémov popísaných lineárnymi diferenciálnymi rovnicami*, Bakalárska práca, TU Košice, Košice, 2015. (Original in Slovak)
- [3] KOZÁK, Š.: *Dynamické modely II, Aplikácie-simulácie*, ES ČVUT, Praha, 2004. (Original in Slovak)

- [4] KELEMEN, M., MIKOVÁ, E., VIRGALA, I.: *Informatika*, Edícia študijnej literatúry TU Košice, Košice, 2014. (Original in Slovak)
- [5] KELEMEN, PUŠKÁR M., VIRGALA, I., MIKOVÁ, E.: *Meranie v mechatronike*, Edícia študijnej literatúry TU Košice, Košice, 2014. (Original in Slovak)
- [6] GMITERKO, A., ŠARGA, P., HRONCOVÁ, D.: *Mechatronika I*, Edícia študijnej literatúry TU Košice, Košice, 2011. (Original in Slovak)
- [7] GMITERKO, A., ŠARGA, P., HRONCOVÁ, D.: *Teória dynamických systémov*, Edícia študijnej literatúry TU Košice, Košice, 2010. (Original in Slovak)
- [8] KELEMENOVÁ, T., FRANKOVSKÝ, P., VIRGALA, I., MIKOVÁ, E., KELEMEN, M.: *Machines for inspection of pipes*, Acta Mechatronica, Vol. 1, No. 1, pages 1-7, 2016.
- [9] VÍTEČKOVÁ, M., SALOKY, T., TAKÁČ, R.: *Laplaceova a Z transformácia v automatizácii*, Edícia študijnej literatúry, Košice, 2004. (Original in Slovak)
- [10] PIRNÍK, R., HRUBOŠ, M., NEMEC, D., BOŽEK, P.: *Navigation of the autonomous ground vehicle utilizing low-cost inertial navigation*, Acta Mechatronica, Vol. 1, No. 1, pages 19-23, 2016.
- [11] BOŽEK, P., TURYGIN, Y.: *Measurement of the operating parameters and numerical analysis of the mechanical subsystem*, Measurement Science Review, Vol. 14, No. 4, pages 198-203, 2014.
- [12] ABRAMOV, I. V., NIKITIN, Y. R., ABRAMOV, A. I., SOSNOVICH, E. V., BOŽEK, P.: *Control and Diagnostic Model of Brushless DC Motor*, Journal of Electrical Engineering. Volume 65, Issue 5, pages 277–282, 2014.
- [13] LIPTÁK, T., KELEMEN, M., GMITERKO, A., VIRGALA, I., HRONCOVÁ, D.: *The control of holonomic system*, Acta Mechatronica, Vol. 1, No. 1, pages 15-20, 2016.
- [14] KARBAN, P.: *Výpočty a simulace v programech Matlab a Simulink*, Computer Press, Brno, 2006. (Original in Czech)
- [15] VÉGH, P.: *Zbierka riešených úloh a zadaní z teórie automatického riadenia so simuláciami v prostredí MATLAB a SIMULINK*, Vydavateľstvo STU Bratislava, Bratislava, 2009. (Original in Slovak)

## Review process

Single-blind peer reviewed process by two reviewers.