

**DISPLACEMENT AMPLIFYING SYSTEMS**

Tatiana Kelemenová; Miroslav Dovica; Peter Sedlačko

*Received: 20 June 2016**Accepted: 17 July 2016***DISPLACEMENT AMPLIFYING SYSTEMS****Tatiana Kelemenová**

Technical University of Kosice, Faculty of Mechanical Engineering, Letna 9, Kosice, Slovak Republic,  
tatiana.kelemenova@tuke.sk

**Miroslav Dovica**

Technical University of Kosice, Faculty of Mechanical Engineering, Letna 9, Kosice, Slovak Republic,  
miroslav.dovica@tuke.sk

**Peter Sedlačko**

Technical University of Kosice, Faculty of Mechanical Engineering, Letna 9, Kosice, Slovak Republic,  
peter.sedlacko@tuke.sk

**Keywords:** mechatronics, actuator, displacement, amplifying, stroke

**Abstract:** Actuator is a part of mechatronic product and low stroke actuator are frequently used mainly in small dimension mechatronic product. Low stroke actuators include piezoelectric actuators (PZT), magnetostrictive actuators (GMA), shape memory alloy actuator (SMA) etc. These actuators have higher efficiency in small scale dimensions than electromagnetic actuators, but these actuators has lower stroke. This problem can be solved via using of amplifying system. Paper presents possible way of amplifying system and application of these systems.

## 1 Introduction

Evolution in area of mechatronics leads to miniature mechatronic products. It is possible to say, that almost every product are mechatronic. Micro mechatronics is the synergetic integration of mechanical, electronic and control systems based on scaling effects in the micro world. In this time the micro mechatronics and MEMS products are very often used in almost every product around us. Very often it is not visible, but it is included in cameras, mobile phones, microwave oven, photocopier, washing machine, CD and DVD players etc.

Developing of miniature mechatronic products requires also smaller sensors, actuators, mechanisms and electronics. Actuators are key problem in miniaturization of mechatronic products. Selection of the actuators and sensors in area of mechatronics is limited with their dimensions and efficiency. Actuators as piezoelectric (PZT), shape memory alloy (SMA), giant magnetostrictive alloy (GMA) etc. which are applicable in mechatronics systems, have small displacement (several microns) but they have a lot of force potential (hundreds of Newtons). Mechatronics area includes a lot of applications, where much higher displacement is needed. In these cases, "displacement amplifying system" have place for using. Displacement amplifying system, also called as enlarging system, is described as transformation system, which is able to transform input mechanical energy (small displacement and high force) to output mechanical energy with desired parameters (higher displacement and lower force) [1].

The problem with displacement amplifying is also coupled with area of metrology. It is possible to meet with measuring equipment's for small displacement sensing (measurement of geometric deviations of dimension,

measurement of geometric shape and position, measurement of roughness etc.) These applications use only transformation of information about small displacement. Different situation is in case of piezoelectric actuator (with diameter 8 mm and length 20 mm). Its blocking force is 1500N and displacement is only 30 $\mu$ m and this combination is not suitable for almost mechatronics application. It is necessary to enlarge the small displacement. The displacement amplifying causes force decreasing. Consequently, it is necessary to use displacement amplifying system for power transformation. These systems are also called as "displacement amplifier" [1], [2], [3].

The aim of this paper is to introduce taxonomy of displacement amplifying systems from the viewpoint of physical principle, which is useful in mechatronics systems.

## 2 Displacement Amplifiers

There are a lot of displacement amplifiers, which can be divided into these main groups:

- displacement amplifiers based on mechanical principle,
- displacement amplifiers based on fluid principle,
- another displacement amplifiers for indication purposes (aerodynamics principle, pneumatic principle, optical principle, electrical principle) etc.

Displacement amplifiers based on mechanical and fluid principle are classified from the viewpoint of used principle and type of transformation medium for displacement:

1. Levers
2. Flexure bridges

**DISPLACEMENT AMPLIFYING SYSTEMS**

Tatiana Kelemenová; Miroslav Dovica; Peter Sedláčko

3. Gears and friction gearing for displacement amplifiers.

4. Displacement amplifiers with deformation parts.
5. Hydraulic displacement amplifier.
6. Inchworm motors
7. Ultrasonic traveling – wave motors

It is not fixed dividing. It shows only on possibilities how to solve problem with displacement amplifying. Specific solution could be also designed as system created from combination of mentioned displacement amplifier types otherwise it could be only analogy to the mentioned types.

### 3 Levers and Flexure Bridges

Levers are mechanisms which depend on distance ratio between joints and high transverse stiffness of lever. Principle of lever is shown on Figure 1 [1], [2].

Levers bring the simplest form of displacement amplifying. Advantage of lever using lies on practical applicability (there is no fluid leakage). However, levers are need very high production precision. Many parts in stage lever mechanisms bring another resonance frequency to the system. These facts cause problems in many mechatronics application [2].

Flexure bridges are gripped with quasi pin – jointed and depend on longitudinal stiffness of parts. This property causes more compact design than levers (Figure 2).

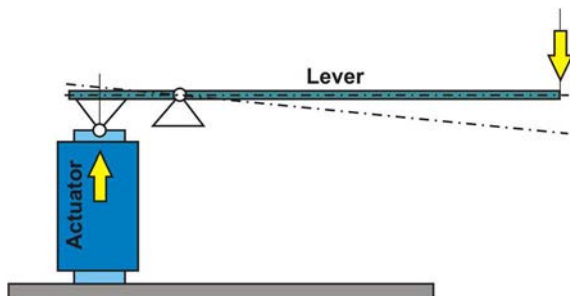

Figure 1 Lever displacement amplifier

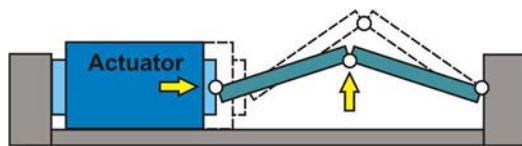

Figure 2 Flexure bridges displacement amplifier

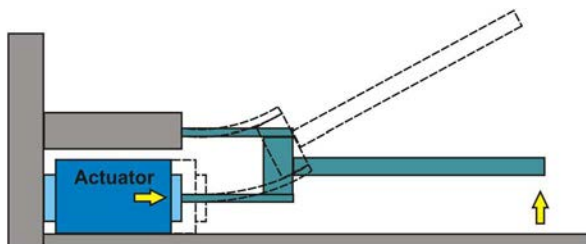

Figure 3 Levers with leaf springs

Levers and flexure bridges can be designed as rigid body mechanism with conventional joints or as compliant mechanisms with spring joints. Many mechatronics applications contain compliant mechanisms with spring joints, because conventional rigid bodies and bearings cause several problems. Application of spring joints brings the desired backlash free motion, which is needed for small displacement actuators [3].

Displacement amplifying is also possible to realize via using levers with short leaf springs (Figure 3). This way of displacement amplifying allows amplifying displacement 300x. This way is very often used in projection microscope [1], [2], [3].

Spring joint (Figure 4) is rotation coupling with limited angle of rotation. They are very often used in equipment's because of their many advantages:

- no friction and other passive resistance,
- backlash free motion,
- do not need lubricate and service,
- insensitive on dirties,
- wear resistance.

The main disadvantage of spring joint is their dependence of rotation axis on applied forces. Deformation of the spring joint needs another additional energy, which is accumulated inside spring joint. It causes loss in deformations and part of energy dissipates to heat energy. These facts decrease efficiency of system.

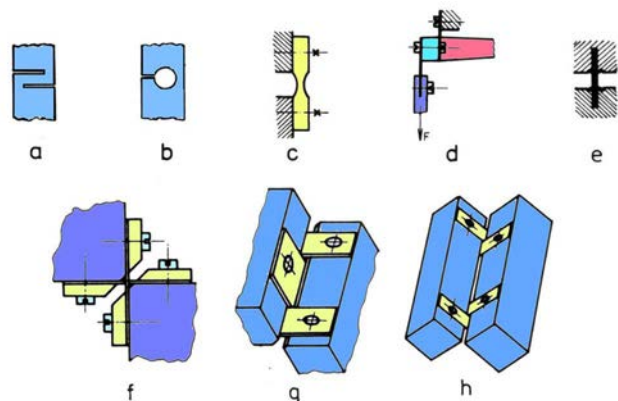

Figure 4 Example of spring joint

### 4 Displacement Amplifiers with Deformation Parts

Deformation of low stiffness parts is also useful for displacement amplifying. These low stiffness parts can be made as perforated ribbon, which is twisted and pulled in marked direction (Figure 5). It causes rolling and unrolling of ribbon coupled with indicator pointer. This way allows amplifying small displacement with very high precision without backlash (indicator for measurement of geometric deviations).

**DISPLACEMENT AMPLIFYING SYSTEMS**

Tatiana Kelemenová; Miroslav Dovica; Peter Sedlačko

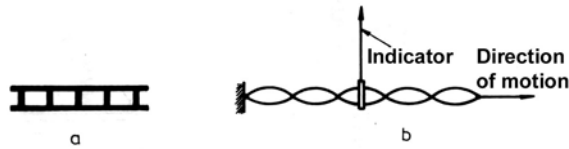

Figure 5 Displacement amplifier with deformation part

**5 Gearing and Friction Gearing for Displacement Amplifying**

Problem with displacement amplifying can be also solved with combination of lever and gearing (Figure 6 left). The main disadvantage of this solution is backlash between gears. Another way is using of friction gearing (Figure 6 right), but slipping can be occurs in this solution.

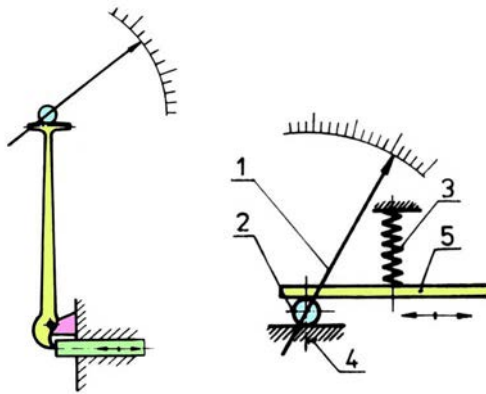

Figure 6 Gearing and friction gearing for displacement amplifying

**6 Hydraulic Amplifying Systems**

Using of elastic medium (rubber, fluids like oil or water) is suitable solution for displacement amplifying. Fluid behaves as non-compressible medium. This property is main advantage for using in displacement amplifying system (Figure 7) [2].

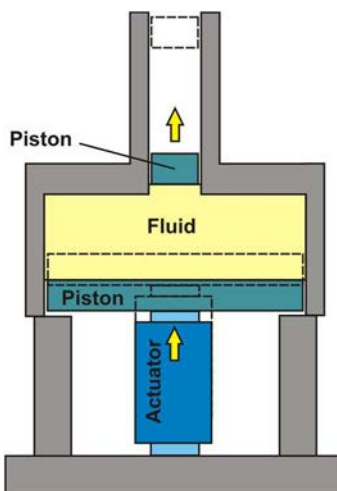

Figure 7 Hydraulic displacement amplifier

The hydraulic displacement amplifier allows bigger place for flexibility of design and lower loss caused with deformation of amplifier structure. Marginal problem occurs in chamber sealing to avoid the fluid loss.

Dynamic behaviour of hydraulic displacement amplifier is determined with time needed for wave transition through the transport medium (fluid) [2].

**7 Inchworm Motors**

The term „Inchworm“ is registered trademark of Burleigh Instrument, Inc. and it is used as name for structure (Figure 8), which generates motion via using of conception based on three piezoelectric actuators (also called as PZT). Suitable configuration and control algorithm allows the amplified motion against the one piezoelectric actuator. Although it has amplified displacement, it has also extremely high mechanical resolution (about 4 nm) [4].

The term inchworm comes from biological inspiration from biological pattern called with the same name “inchworm”. Principle of the motion is based on three PZT actuators placed on guiding rod. Two actuators place on edges are called as clamp actuator. Middle piezoelectric actuator is able to change distance between both clamp actuators. Suitable designed algorithm of actuator exciting causes forward motion on guiding rod.

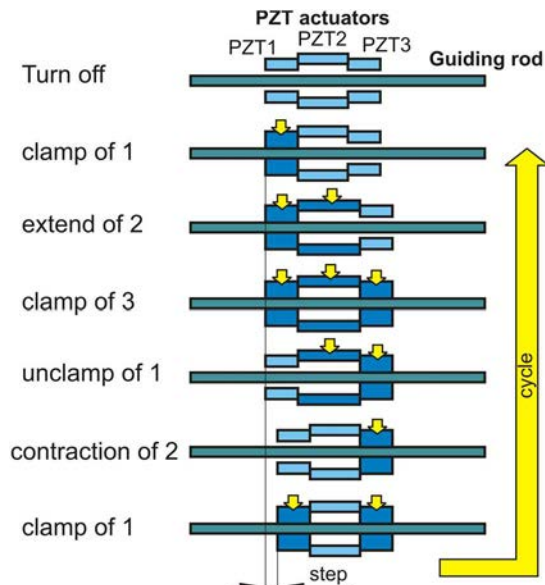

Figure 8 Inchworm motor [4]

Inchworm motors with ultra-high resolution are made as various versions with resolution from 1 nanometre (10<sup>-6</sup>m) to 2,5 angstroms (2,5.10<sup>-10</sup>m) , what is relative to atom size. These properties are used as positioning systems in raster microscopes [4].



**DISPLACEMENT AMPLIFYING SYSTEMS**

Tatiana Kelemenová; Miroslav Dovica; Peter Sedlačko

**8 Ultrasonic motors based on traveling wave**

Ultrasonic motor converts ultrasonic mechanical energy to mechanical energy via friction force between the sliding segment and stator. This type of the motion is called as traveling wave. The principle of the ultrasonic motor is described on Figure 9 [5].

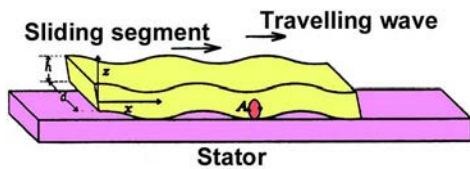

Figure 9 Principle of the planar ultrasonic motor [5]

Traveling wave traverses through these every elements of surface on the sliding segment and consequently these elements move on elliptical trajectory. If any object will be in contact with the segment, then this object will move through the friction force effect generated between them. Principle of the motion in ultrasonic motor has analogy in surf plate moves on sea waves. The ultrasonic motor has several advantages. It has compact design and it has still force also without exciting. It has bigger torque also in low motion speeds. The main disadvantage is requirement of high frequency power supply [5].

Principle of the rotation ultrasonic motor (Figure 10) is the similar to the planar ultrasonic motor. Rotation ultrasonic motor is very often used in cameras for focusing in objective [6].

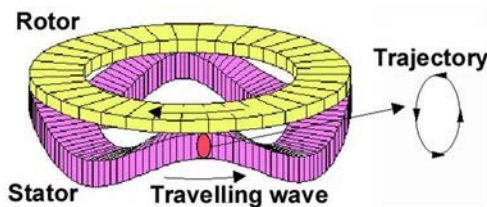

Figure 10 Principle of the rotation ultrasonic motor [6]

**9 Application of actuators with displacement amplification**

Inchworm principle is very often applied as locomotion principle for in-pipe machines (Figure 11). Original principle is modified, because pipe wall is instead of previous guiding rod. Fast repeating of inchworm strategy enables the in-pipe locomotion. Clamping module has low stroke and another amplification principle is necessary for this reason. Also it could be problematic if any pipe wall geometric deviation, sediments on inner wall or pipe wall deformation occurs.

Another solution of clamping module is used in another in-pipe machine (Figure 11).

Contact of machine with inner pipe wall is ensured via using of elastic bristles, because they enable better adaptation to inner pipe wall irregularities. Clamping function of bristles is ensured with amplifying system, which consists of flexible joint levers. Figure 12 shows simulation of displacement amplification function of designed compliant system.

Piezoactuators with traveling wave ultrasonic motor are frequently used for camera focusing, because of small dimension, small weight and very good efficiency.

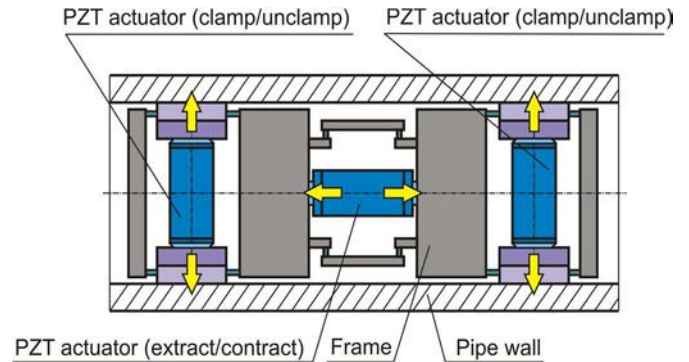

Figure 11 Inchworm principle applied to in-pipe machine locomotion

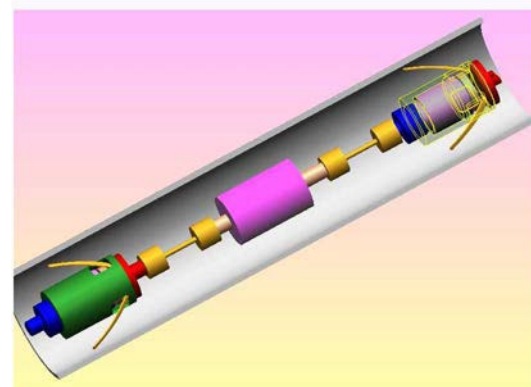
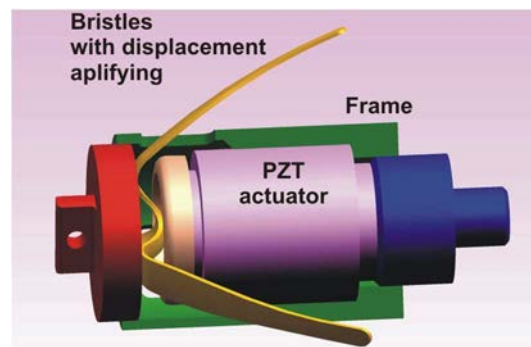

Figure 12 Miniature bristled in-pipe machine with displacement amplified PZT actuator

**DISPLACEMENT AMPLIFYING SYSTEMS**

Tatiana Kelemenová; Miroslav Dovica; Peter Sedlačko

**10 Conclusion**

In this paper we introduced the displacement amplifying system used in mechatronic products. Miniaturization plays key role in developing of mechatronic products. Because of scale effect of actuators, unconventional actuators (PZT, GMA, SMA etc.) with low stroke are very often used. For this reason it is necessary to develop and use the displacement amplification system [7], [8], [9], [10].

**Acknowledgement**

The work has been accomplished under the research projects No. VEGA 1/0182/15 and KEGA 014STU-4/2015 financed by the Ministry of Education.

**References**

- [1] THORNLEY, J., KING, T., XU, W.: 'Piezoceramic actuators for mechatronic applications', Proc. of ICMA '94 International conference on machine automation, mechatronics spells profitability, Tampere Finland. Feb. 15-18, 1994.
- [2] JENDRITZA, D. J., JANOCHA, H., SCHMIDT, H., 'Displacement amplifier for solid -state actuators', Proc. of Int. Conf. on New Actuators - Actuators 96, Bremen, Germany, 26-28 June 1996.
- [3] TORRES, J., ASADA, H. H.: 'High-Gain, High Transmissibility PZT Displacement Amplification Using a Rolling-Contact Buckling Mechanism and Preload Compensation Springs', *IEEE Transactions on Robotics*, Vol. 30, No. 4, August 2014.
- [4] BURLEIGH INSTRUMENTS, Inc.: 'The Power of Precision in Nanopositioning - Nanopositioning Systems', . USA, 1995.
- [5] HOSHI, N., KAWAMURA, A.: "Analysis of primary - on - slider type piezoelectric actuator and application to two degree of freedom plane actuator", *IEEE Transaction on industrial electronic.*, Vol. 43, No. 1, pp. 192-199. February 1996.
- [6] LIH, S.S., , COHEN J. B., 'Rotary Ultrasonic Motors Actuated By Traveling Flexural Waves', SPIE International Conference, Smart Structures and Materials Symposium, Enabling Technologies: Smart Structures and Integrated Systems, San Diego, CA, 3-6 March 1997. [online]. c2003, last revision not refered, cit. [2016-03-05]. <<http://ndea.jpl.nasa.gov/nasa-nde/lommas/spie-usm97.htm>>.1997.
- [7] DUCHON, F., HUBINSKÝ, P., HANZEL, J., BABINEC, A., Tolgyessy, M., "Intelligent Vehicles as the Robotic Applications", *Procedia Engineering*, Vol. 48, Pages 105-114, 2012.
- [8] KONIAR, D., HARGAS, L., STOFAN, S., "Segmentation of Motion Regions for Biomechanical Systems", *Procedia Engineering*, Vol. 48, Pages 304-311, 2012.
- [9] BOŽEK, P., TURYGIN, Y.: Measurement of the operating parameters and numerical analysis of the mechanical subsystem, *Measurement Science Review*, Vol. 14, No. 4, 2014, pp. 198-203.
- [10] ABRAMOV, I. V., NIKITIN, Y. R., ABRAMOV, A. I., SOSNOVICH, E. V., BOŽEK, P.: Control and Diagnostic Model of Brushless DC Motor, *Journal of Electrical Engineering*. Volume 65, Issue 5, Pages 277-282, 2014.

**Review process**

Single-blind peer reviewed process by two reviewers.

**DIGITAL TRACKING CONTROL OF PRECISION MOTION SERVOSYSTEM**

Lukáš Dominik; Peter Frankovský; Alexander Gmiterko; Michal Kelemen; Peter Trebuňa

Received: 22 June 2016

Accepted: 18 July 2016

# DIGITAL TRACKING CONTROL OF PRECISION MOTION SERVOSYSTEM

**Lukáš Dominik**

Department of Mechatronics, Faculty of Mechanical Engineering, Technical University of Košice, Park Komenského 8, 042 00 Košice, Slovakia, e-mail: lukas.dominik@tuke.sk

**Peter Frankovský**

Department of Mechatronics, Faculty of Mechanical Engineering, Technical University of Košice, Park Komenského 8, 042 00 Košice, Slovakia, e-mail: peter.frankovsky@tuke.sk

**Alexander Gmiterko**

Department of Mechatronics, Faculty of Mechanical Engineering, Technical University of Košice, Park Komenského 8, 042 00 Košice, Slovakia, e-mail: alexander.gmiterko@tuke.sk

**Michal Kelemen**

Department of Mechatronics, Faculty of Mechanical Engineering, Technical University of Košice, Park Komenského 8, 042 00 Košice, Slovakia, e-mail: michal.kelemen@tuke.sk

**Peter Trebuňa**

Department of Industrial Engineering and Management, Faculty of Mechanical Engineering, Technical University of Košice, Nemcovej 32, 04 200 Košice, peter.trebuna@tuke.sk

**Keywords:** digital control, trajectory tracking, servomechanism, feedforward

**Abstract:** This paper presents model based digital tracking controller design for precision motion systems. As a demonstrating motion system is used geared permanent magnet DC motor with position sensor. Proposed controller consists of two parts. A feedback part allows tracking the reference signal and rejecting the plant disturbances and a feedforward part improves the tracking accuracy, especially in case of use time varying reference signal. Simulation results are presented.

## 1 Introduction

Motion systems are used in many different application areas, including industrial NC machines, hard disk drives in consumer electronics and so on. Typically the position or velocity of machines is controlled by using geared electric motors, pneumatic actuators or hydraulic actuators. Despite the large differences in application areas, these motion systems share a common aspect - control is essential for achieving speed and accuracy requirements. To fulfil these demands is commonly used combination of feedback and feedforward control (Figure 1), where the feedback controller  $C_1$  allows tracking the reference signal and improves the disturbance rejection and the feedforward controller  $C_2$  improves the tracking accuracy.

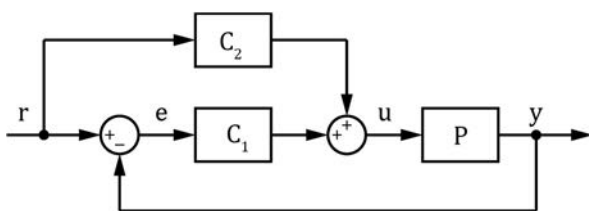

Figure 1 Two degree of freedom control architecture

The feedback controller works based on the difference between reference input  $r$  and output  $y$ . The most

commonly used feedback controller in industry is PID controller in consideration of its stability and robustness against disturbances. However, the tracking error  $e$  cannot be avoided when only the feedback controller is used. To reduce the tracking error feedforward controller is used together with the feedback controller in order to make up for the feedback controller's disadvantage and enable a system to track the desired reference path. The feedforward controller is an open loop controller and generates the output with calculations based on the pre-specified system model. The reference input is directly fed forward to the plant  $P$  in the feedback control loop, which consequently improves response characteristics of the feedback loop. Transfer function from the reference to the controlled variable is

$$\frac{Y(z)}{R(z)} = \frac{C_1(z)P(z) + C_2(z)P(z)}{1 + C_1(z)P(z)} \quad (1)$$

Suppose that the desired output track the reference signal. In that case  $Y(z) = R(z)$  is achieved and from the above equation we can derive feedforward controller as

$$C_2(z) = \frac{1}{P(z)} \quad (2)$$

**DIGITAL TRACKING CONTROL OF PRECISION MOTION SERVOSYSTEM**

Lukáš Dominik; Peter Frankovský; Alexander Gmitterko; Michal Kelemen; Peter Trebuňa

By another point of view we can redraw mentioned controller into form shown in (Figure 2). After modifying the reference input by feedforward filter, the modified input is fed to the feedback control loop.

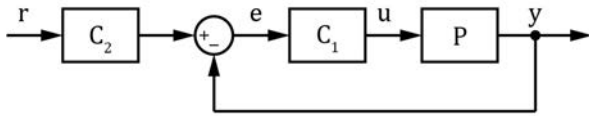

Figure 2 Alternative two degree of freedom control architecture

Transfer function from the reference signal to the controlled variable is

$$\frac{Y(z)}{R(z)} = C_2(z) \frac{C_1(z)P(z)}{1 + C_1(z)P(z)}, \quad (3)$$

and the desired output track the reference signal when  $Y(z) = R(z)$  is achieved. Feedforward controller in this case is

$$C_2(z) = \frac{1 + C_1(z)P(z)}{C_1(z)P(z)}. \quad (4)$$

In this alternative architecture, the feedforward controller transfer function is more complex because there is also included transfer function of feedback controller. However, when the plant has unstable zeros, inverted plant transfer function yields to unstable feedforward controller and modification is necessary. In this case, the second type is more suitable than first. As a typical technique of this second type feedforward controller is ZPETC [1].

## 2 Plant dynamics

In this paper we are focused to the control of a geared permanent magnet DC motor with position sensor, which represents servomechanism. This servomechanism consists of electrical and mechanical part. As input to this system is voltage source  $v$  applied to the motor's armature, while the output is the angular position  $\varphi$  of the gearbox shaft.

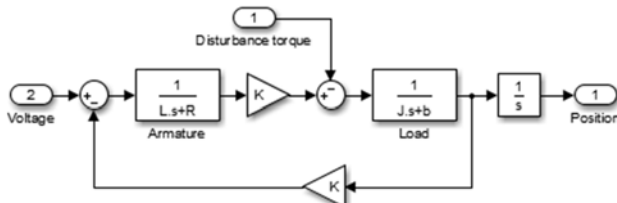

Figure 3 Model of permanent magnet DC motor with gearbox and position sensor

In order to model of servomechanism shown in (Figure 3), the parameters and variables are defined as follows:

- L - armature winding inductance
- R - armature winding resistance
- K - torque; electrical constant
- J - overall inertia at output shaft
- b - overall damping at output shaft

Continuous-time transfer function of the servomechanism's velocity loop is

$$\frac{\dot{\Phi}(s)}{V(s)} = \frac{K}{(Ls + R)(Js + b) + K^2}. \quad (5)$$

Table 1 Parameters of servomechanism

L	0.001	[H]
R	2.4	[Ω]
K	3.8	[Nm/A; Vs/rad]
J	0.5	[kgm <sup>2</sup> ]
b	0.001	[Nms/rad]

For the purpose of design of a digital control system we need to create a sampled model of the servomechanism. It is necessary to choose a frequency with which the continuous-time plant is sampled. Sampling frequency must be fast compared to the dynamics of the system in order that the sampled output of the system captures the system's full behaviour. It is appropriate to relate the sampling rate to the bandwidth.

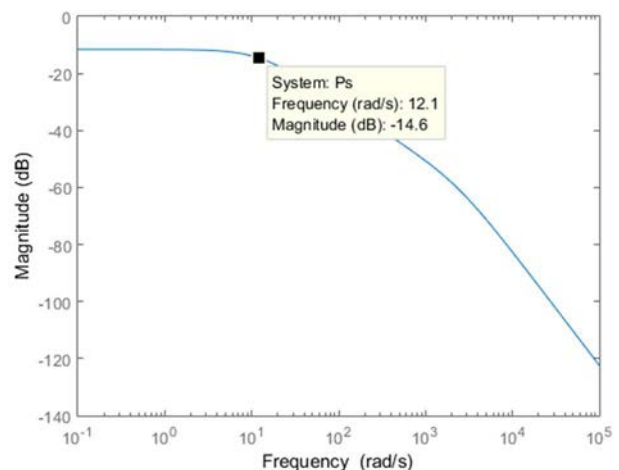

Figure 4 Bode plot of the servomechanism's velocity loop

The resulting -3dB bandwidth  $f_{BW}$  of the servomechanism is 1.92 Hz. As a general rule of thumb, the sampling period  $T$  should be chosen in the range



**DIGITAL TRACKING CONTROL OF PRECISION MOTION SERVOSYSTEM**

Lukáš Dominik; Peter Frankovský; Alexander Gmitterko; Michal Kelemen; Peter Trebuňa

$$\frac{1}{40f_{BW}} < T < \frac{1}{10f_{BW}}. \quad (6)$$

With respect to this rule the sampling period was chosen as  $T = 0.05$  s. Next step is to convert the continuous-time transfer function of the servomechanism's velocity loop to the discrete z-domain. As a type of hold circuit we will choose a zero-order hold method. Discrete-time transfer function of the velocity's loop is then

$$\frac{\dot{\Phi}(z)}{V(z)} = \frac{0.1187z + 0.0007}{z(z - 0.5462)}. \quad (7)$$

### 3 Controller design

Controller of the velocity's loop consist of a feedback and a feedforward part. A feedback part allows tracking the reference signal and rejecting the plant disturbance and a feedforward part improves the tracking accuracy.

#### 3.1 Feedback

As a feedback compensator is used PI controller, where the proportional control  $P$  have the effect of reducing the rise time and the steady-state error and integral control  $I$  have the effect of eliminating the steady-state error for a constant input. Transfer function of a PI controller is

$$C_1(s) = P + \frac{I}{s}. \quad (8)$$

Discretizing the above continuous-time transfer function of PI controller by using zero order hold method we achieve digital PI controller form as

$$C_1(z) = \frac{Pz - P + IT}{z - 1}. \quad (9)$$

The required step response of servomechanism's velocity loop is achieved by choosing proportional gain as  $P = 4$  and integral gain as  $I = 35$ . Digital PI controller's transfer function then takes form

$$C_1(z) = \frac{4z - 2.25}{z - 1}. \quad (10)$$

#### 3.2 Feedforward

Feedforward control requires integration of the mathematical model into the control algorithm such that it is used to determine the control actions based on what is known about the system being controlled. Reference signal is, according to knowledge of behaviour of the system, at first modified and modified input signal is then

fed to servomechanism's feedback control loop. Servomechanism's velocity feedforward is based on minimal realization of inverse of velocity's feedback control loop as

$$C_2(z) = \frac{z^2 - 1.131z + 0.2877}{0.4412z^2 - 0.2832z - 0.0016}. \quad (11)$$

Pole-zero map of the above discrete-time transfer function shows that all poles and zeros are inside the unit circle what means that designed feedforward controller is causal and stable.

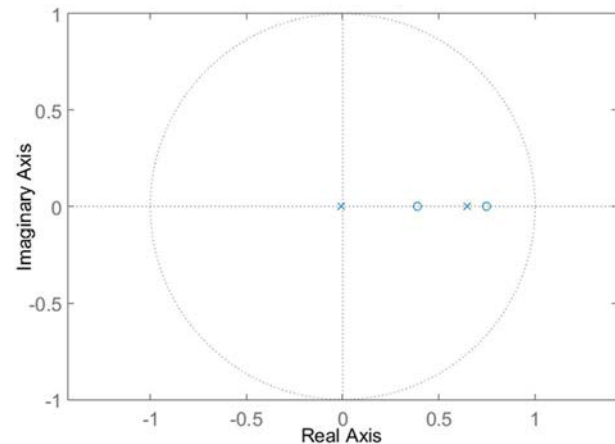

Figure 5 Pole-zero map of feedforward controller  $C_2$

Servomechanism's position controller consist of cascaded position and velocity loop with feedforward. Feedforward path speeds the response of controller by taking the command around the slower position loop directly to the velocity loop which improves the dynamics of the servomechanism.

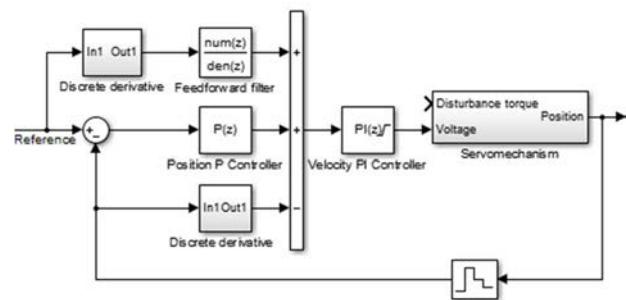

Figure 6 Cascaded position and velocity loop with feedforward

## 4 Simulations and analysis

Simulation results of servomechanism ability to track the reference signal with and without feedforward controller path are shown in (Figure 7). As a testing reference input was chosen sine signal with frequency of 1 rad/s. Ability of servomechanism to track the reference



**DIGITAL TRACKING CONTROL OF PRECISION MOTION SERVOSYSTEM**

Lukáš Dominik; Peter Frankovský; Alexander Gmiterko; Michal Kelemen; Peter Trebuňa

signal without feedforward controller is not enough sufficient considering to significant phase shift between reference signal and servomechanism's output. Observed phase shift cause to significant error between reference and output signal, which is in precision motion systems inappropriate. Adding feedforward path to servomechanism's controller yields to better behaviour of servomechanism's output.

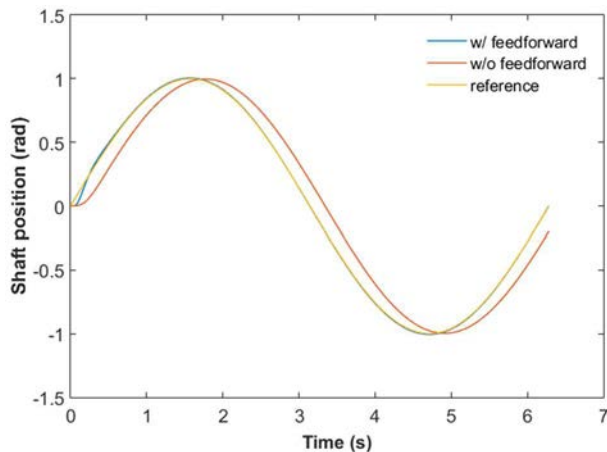

Figure 7 Reference trajectory tracking with and without velocity feedforward

By adding of feedforward path to the controller the ability of servomechanism to track the reference signal is significantly improved.

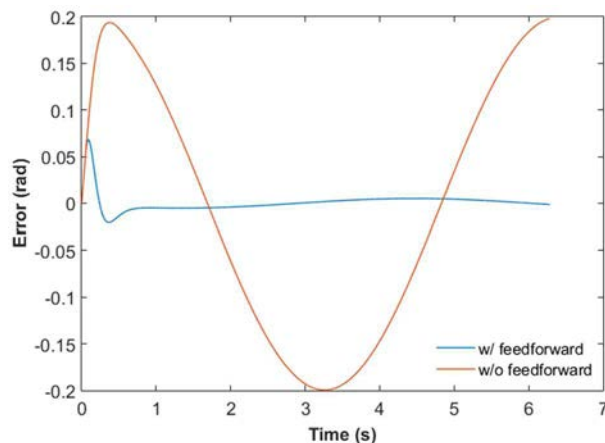

Figure 8 Tracking error with and without velocity feedforward

## 5 Conclusion

Controller design and simulation results of precision motion servomechanism are presented. The proposed controller based on combination of feedback and feedforward control loop shows that it can be provided impressive tracking performance by adding of feedforward path to controller. Result of adding of feedforward path to controller is significant reduction of

error between reference signal and servomechanism's output.

## Acknowledgement

VEGA 1/0872/16 Research of synthetic and biological inspired locomotion of mechatronic systems in rugged terrain.

## References

- [1] TOMIZUKA, M.: On the Design of Digital Tracking Controllers, *Journal of Dynamic Systems Measurement and Control*, Vol.115, p.412-418, 1993.
- [2] TOMIZUKA, M.: Zero Phase Error Tracking Algorithm for Digital Control, *Journal of Dynamic Systems Measurement and Control*, Vol.109, p.65-68, 1987.
- [3] BUTTERWORTH, J., PAO, L., ABRAMOVITCH, D., The Effect of Nonminimum-phase Zero Locations on the Performance of Feedforward Model-inverse Control Techniques in Discrete-time Systems, *American Control Conference*, pp.2696-2702, 2008.
- [4] BOERLAGE, M., STEINBUCH, M., LAMBRECHS, P., WAL, M.: *Model-based feedforward for motion systems*, Control Applications, 2003.
- [5] RAMESH, R., MANNAN, M., POO, A.: Tracking and Contour Error Control in CNC Servo Systems, *International Journal of Machine Tools & Manufacture*, Vol.45, p.301-326, 2005.
- [6] WANG, Y., XIONG, Z., DING, H.: Robust Internal Model Control with Feedforward Controller for a High-speed Motion Platform, *International Conference of Intelligent Robots and Systems*, p.187-192, 2005.
- [7] FRANKLIN, G., POWEL, D., WORKMAN, M.: *Digital Control of Dynamic Systems*, 1998.
- [8] LEVINE, W.: *Control System Fundamentals*, 2011
- [9] DUCHOŇ, F., DEKAN, M., BABINEC, A., CHOVANEC, L., VITKO, A.: Detection of Welds in Automated Welding. In *Applied Mechanics and Materials*, 611, 2014, pp. 519-528.
- [10] DOMEK, G., DUDZIAK, M., KOLODZIEJ, A.: Timing belt gear design for mechatronics system. *Procedia Engineering*, 96, 2014, pp. 39-43.
- [11] PAPACZ, W., KURYŁO, P., TERTEL, E.: The Composite Control Arm-Analysis of the Applicability in Conventional Suspension. *American Journal of Mechanical Engineering*, 1.7, 2013, pp. 161-164.

## Review process

Single-blind peer reviewed process by two reviewers.

*Received: 05 July 2016**Accepted: 20 July 2016*

## PARAMETRIC STRUCTURING OF PRODUCTION SYSTEMS TROUGHT ZONAL MODELS

**Gabriela Ižaríková**

TU of Košice, Faculty of Mechanical Engineering, Institute of Special Technical Sciences, Department of Applied Mathematics and Informatics, Letná 9, 042 00 Košice, Slovakia, gabriela.izarikova@tuke.sk

**Vladimír Rudy**

TU of Košice, Faculty of Mechanical Engineering, Institute of Technology and Management, Department of Industrial Engineering and Management, Park Komenského 9, 042 00 Košice, Slovakia, vladimir.rudy@tuke.sk

**Keywords:** zonal parameterization, project preparation of production, mathematical modification, spatial optimization

**Abstract:** Spatial optimization of machine production is an important element of project preparation of future production. The paper points out the fact that optimal dimensional models of future production is not just a matter of physical positions of manufacturing techniques, but it is also multicriterial function dependant for example on construction configuration of device and its peripheral elements, dimensional characteristics of production facilities, ergonomics, service availability, etc. CAD is a modifying variant of the production structure. In general is valid a principle that every unused space is costing us money. However, under sizing spatial patterns of production structures may cause us full range of partial issues for instance in logistics etc. An important implementation to tackle the problem is approaches based on mathematical modelling. The paper illustrates the mathematical modification of partial spatial analysis of possible 2D zonal solution as a necessary part in creating of the final model production. The suggested models of topological relations of constructed equipment of production models provide possibility of optimization of location problems. The models of topological relations in production systems are characterized of universality in application conditions and are suitable for designing automated production systems.

### 1 Introduction

#### 1.1 Design of production systems

Engineering production has changed qualitative and organizationally. The current production systems integrate a large number of building elements (machines, robots, warehouses, transport system, control equipment, people) among which there are many complex linkages.

Designing is a creative process in space and time. The creation of production clusters defined its objective function. The reality of mutual compatibility of technical equipment, software, materials and people effectively guaranteeing the required functionality of future production unit addresses on the technical, economic and social base.

The work of the designer includes a series of complex intellectual activities associated with the process of collecting and processing information and application of the general patterns of production and technical procedures in order to achieve the creation of modification of the most effective forms of operating manufacturing market desired products. Project stages must be designed to achieve the highest efficiency solutions and take into account the latest scientific knowledge and knowledge practices. The designed system must operate reliably in real terms, to be technically and economically optimal throughout its use. Particular attention must be paid to issues of functional and spatial relationships that result in processing layout.

The output of the project activity is processing technology disposition production sites guaranteeing the required transformation of materials into the final product. Post illustrates the mathematical modifications partial spatial analysis of 2D zonal solutions occurring in the real structure of production clusters.

The project structure of the production system is a 2D/3D model (Fig.1) indicating a techno-organizational nature of the production process with spatial and temporal arrangement of production and aids. These are interconnected material and information flows and through them implement manufacturing operations on objects of production.

The current production systems integrate a large number of building elements (machines, robots, warehouses, transport system, control equipment, people) among which there are many complex linkages. The structure of the system model production system includes:

- objects that are undergoing the required transformation (material, parts, etc.),
- active agents (operators) that perform transformations (people, machines, tools, plant, equipment, physical environment),
- processes by which changes are made form, size, configuration, location etc.,
- inputs and outputs, which linked components with the environment, material flows, energy and information that form the overall architecture of

**PARAMETRIC STRUCTURING OF PRODUCTION SYSTEMS TROUGHT ZONAL MODELS**

Gabriela Ižaričková; Vladimír Rudy

the system and its associated elements into a whole,

- auxiliary components which are not directly involved in the outputs, but the ability to provide service system (maintenance, tools, etc.),
- space and time as necessary attributes of each system.

The general principle is that the unused space costs money. Spatial optimization of machine production is an important component of project preparation for future production. Optimal sized models of future production reports are not just a matter of physical deployment of production techniques, but also multicriterial function

dependent eg. the structural configuration of the device and its peripheral components and dimensional characteristics of the object manufacturing, ergonomics, service and service availability etc..

Example of defining the functional areas of business in the grid of the space of the hall is in Fig. 2. The entire working area can be divided into grids, respectively into zones. The zone is bounded by space within the reference area, which involves a certain function or activity of entire production process. The number of zones and their geometric and qualitative characteristics determine the vastness of space to be placed production system and its structure.

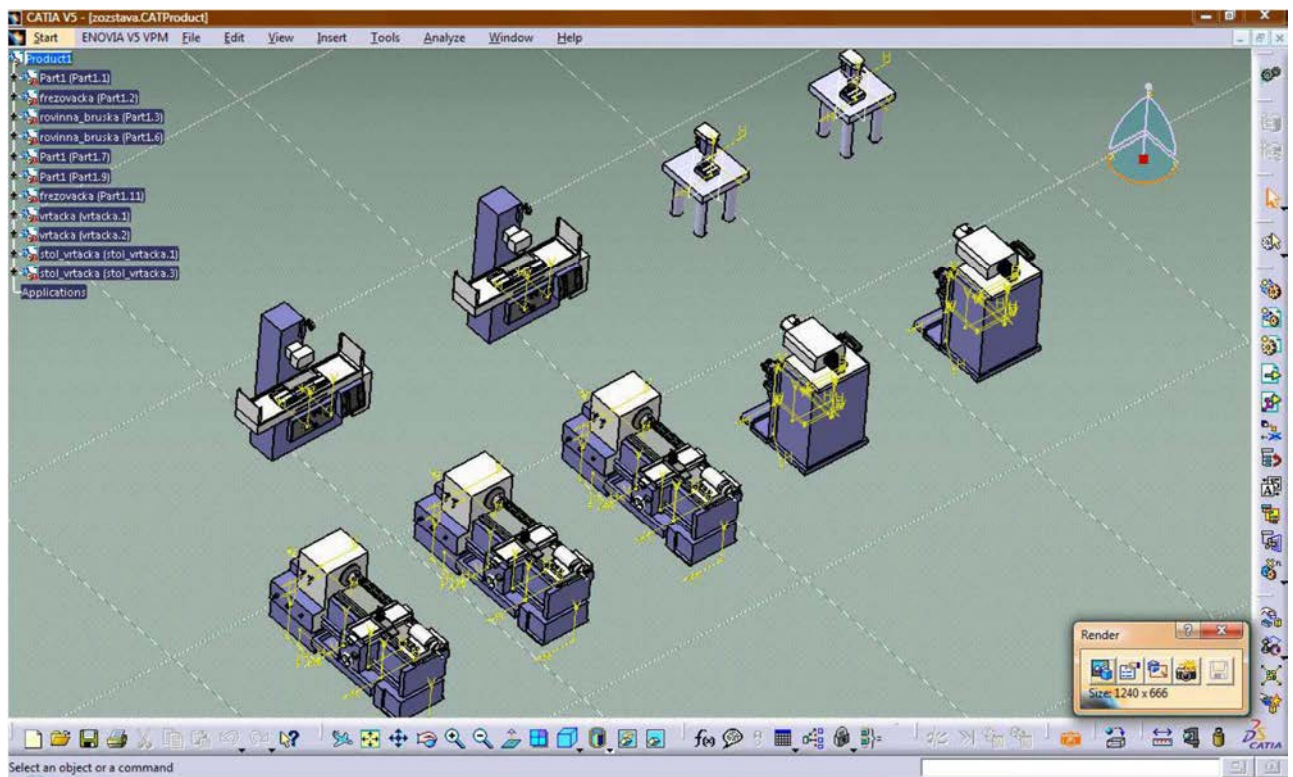

Figure 1 Example of modifying 3D CAD production structure

**PARAMETRIC STRUCTURING OF PRODUCTION SYSTEMS TROUGHT ZONAL MODELS**

Gabriela Ižaríková; Vladimír Rudy

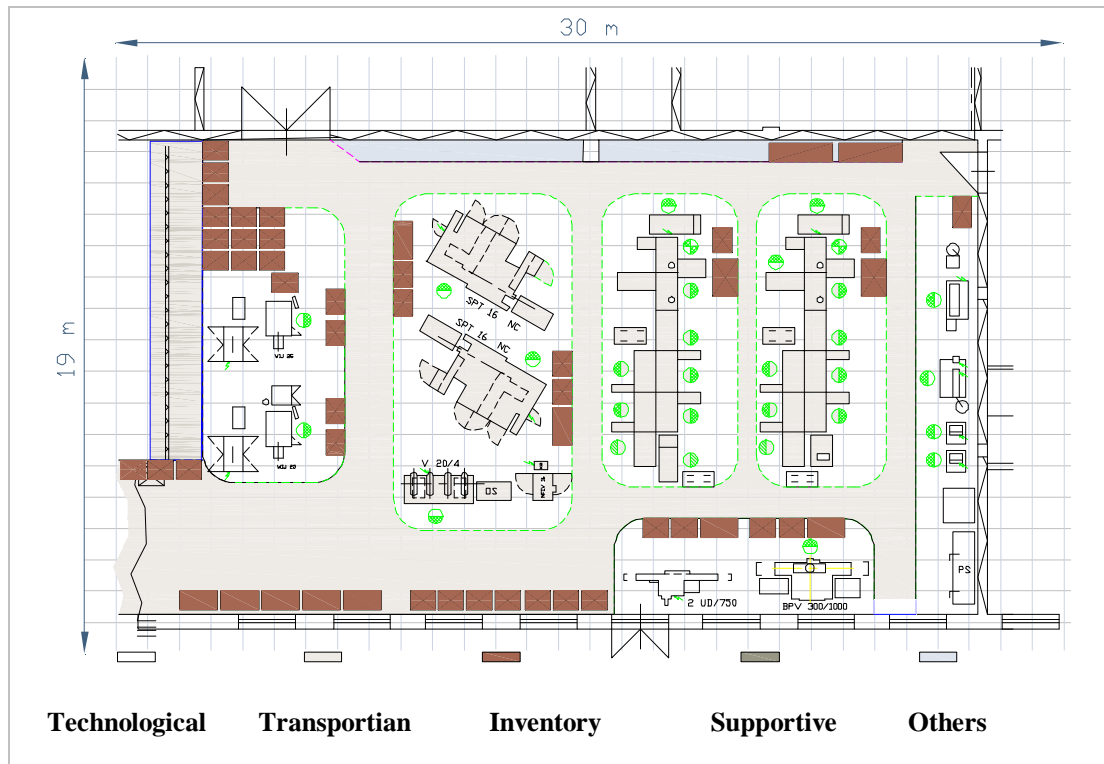

Figure 2 Defining the functional areas of activity in the grid of the space

Generally it can be described in its zone of its volume (in space) or in the examined section. By using this approach, the whole task is reduced to the description of the area bounded by the curves. After a suitable choice of the position coordinate system (depending on the particular case) is determined equation curves bounding zone and zone itself is then expressed as a set of points bounded by these curves. General form of the described area is as follows:

$$z = \{[x, y]: f(x_1), f(x_2), \dots, f(x_i)\} \text{ where}$$

- $x, y$  - coordinates of the points zone of the construction element in the chosen coordinate system,
- $f(x_i)$  - function expressing the shape of the curves bounding zone,
- $i$  - number of curves bounding zone.

In describing the various zones and calculation of area proceed as follows:

1. Choose a coordinate system - the beginning of the coordinate system and orientation of the axes of the coordinate system (mostly right-handed Cartesian system).
2. The zone divides into elementary area. Elementary region is the set of points  $[x, y]$  of

the plane, for which the following applies:

$$a \leq x \leq b, f(x_i) \leq y \leq f(x_j)$$

- functions  $f(x_i)$  and  $f(x_j)$  are continuous on  $\langle a, b \rangle$ ,
  - leave that to them  $(a, b)$  is  $f(x_i) < f(x_j)$ .
3. The shape of the elemental areas (according to the type of functions that bound elemental area) describes the area in question.
  4. The size of the elemental surface area can be expressed by the double integral:
 
$$P = \iint_Z dx dy,$$

$$Z: a \leq x \leq b, f(x_i) \leq y \leq f(x_j).$$
  5. The size of surface area is then the sum of the size of the areas of each elementary area.

The zones can be described by a Cartesian or polar coordinates, the choice depends on the shape of the elementary areas. If the limits in the elemental segment are lines or a polynomial function then it is more appropriate, to describe the area using a Cartesian coordinates and if limit elemental area is a circle or its part, then is more appropriate to describe area by using polar coordinates.



Examples of types of elementary area production zones work:

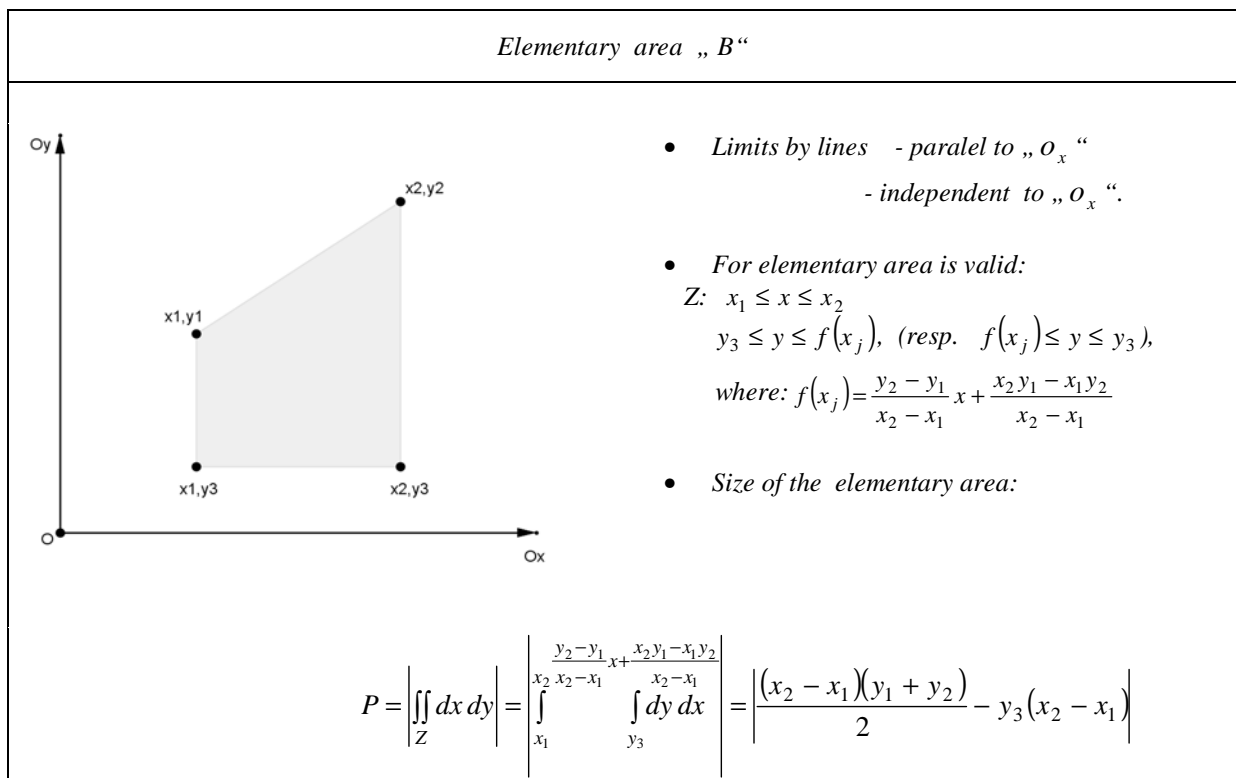
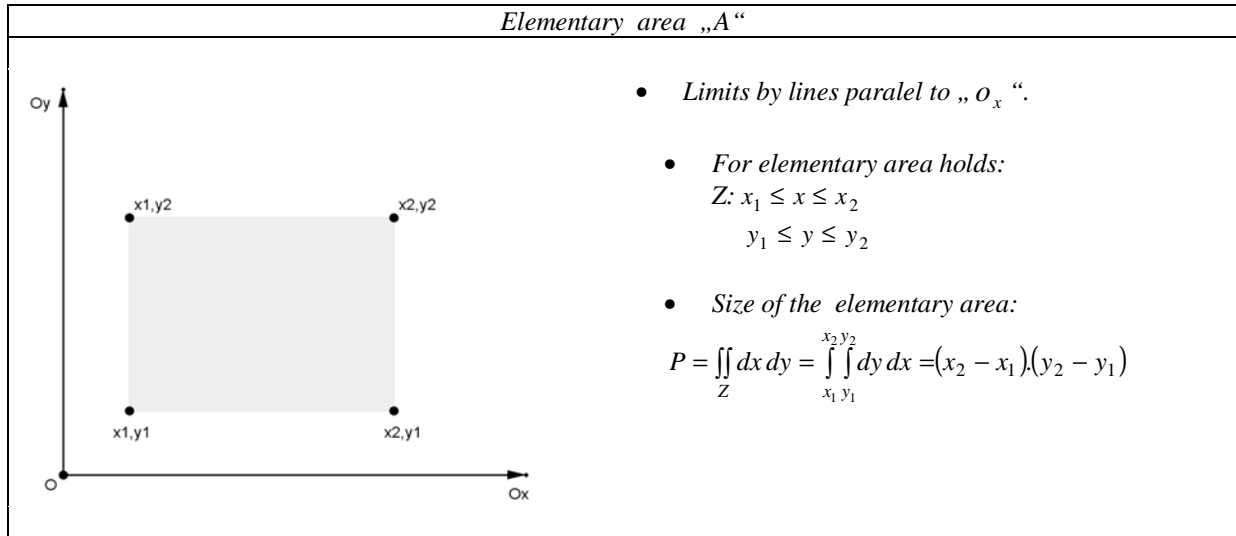

**PARAMETRIC STRUCTURING OF PRODUCTION SYSTEMS TROUGHT ZONAL MODELS**

Gabriela Ižaričková; Vladimír Rudy

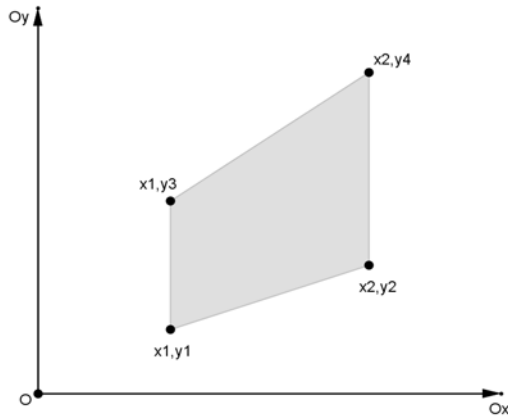
*Elementary area „ C “*

- Limits by lines independent to „  $O_x$  “

- For elementary area is valid:

$$Z: x_1 \leq x \leq x_2$$

 $f(x_i) \leq y \leq f(x_j)$ , where

$$f(x_i) = \frac{y_2 - y_1}{x_2 - x_1} x + \frac{x_2 y_1 - x_1 y_2}{x_2 - x_1}$$

$$f(x_j) = \frac{y_4 - y_3}{x_2 - x_1} x + \frac{x_2 y_3 - x_1 y_4}{x_2 - x_1}$$

- Size of the elementary area:

$$P = \iint_Z dx dy = \int_{x_1}^{x_2} \int_{\frac{y_2 - y_1}{x_2 - x_1} x + \frac{x_2 y_1 - x_1 y_2}{x_2 - x_1}}^{\frac{y_4 - y_3}{x_2 - x_1} x + \frac{x_2 y_3 - x_1 y_4}{x_2 - x_1}} dy dx = \frac{(x_2 - x_1)(y_4 + y_3 - y_2 - y_1)}{2}$$

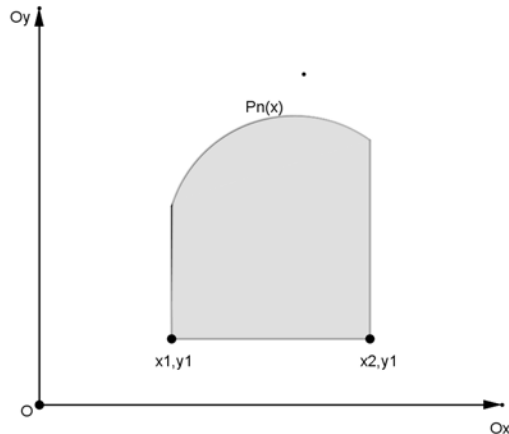
*Elementary area „ D “*

- Limits by lines paralel to „  $O_x$  “ and polynomial n-th degree (eg. second degree polynomial)

- For elementary area is valid:

$$Z: x_1 \leq x \leq x_2$$

$$y_1 \leq y \leq a_2 x^2 + a_1 x + a_0$$

- Size of the elementary area:

$$P = \iint_Z dx dy = \int_{x_1}^{x_2} \int_{y_1}^{a_2 x^2 + a_1 x + a_0} dy dx = \frac{a_2}{3} (x_2^3 - x_1^3) + \frac{a_1}{2} (x_2^2 - x_1^2) + (a_0 - y_1)(x_2 - x_1)$$

**PARAMETRIC STRUCTURING OF PRODUCTION SYSTEMS TROUGHT ZONAL MODELS**

Gabriela Ižaričková; Vladimír Rudy

*Elementary area „E“*

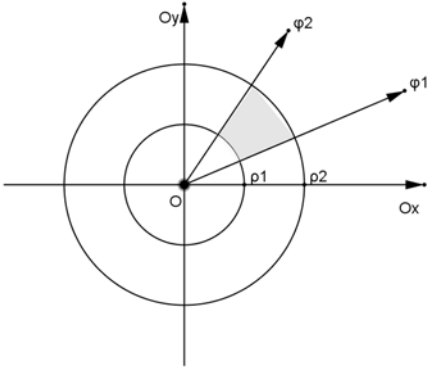

- *Limits by circle or part circle:*
- *When elements working in a different coordinate system then for rectangular, it is possible to use the transformation of polar coordinates:*  
 $\rho, \varphi, (0 \leq \rho \leq \infty, 0 \leq \varphi \leq 2\pi)$ .
- *For elementary area is valid:*  
 $Z: \rho_1 \leq \rho \leq \rho_2$   
 $\varphi_1 \leq \varphi \leq \varphi_2$
- *Size of the elementary area:*

$$P = \iint_Z \rho \, d\rho \, d\varphi = \int_{\varphi_1}^{\varphi_2} \int_{\rho_1}^{\rho_2} \rho \, d\rho \, d\varphi = \frac{(\rho_2^2 - \rho_1^2)(\varphi_2 - \varphi_1)}{2}$$

In addition to functional activities in the zone for a zone is characterized by the following basic parameters:

- *The shape of the zone.* It is possible to express analytically the system of equations. Equation surfaces bounding zone in the reference room, for example. the Cartesian workspace are:  
 $x_{\min} \leq x \leq x_{\max}, \quad y_{\min} \leq y \leq y_{\max},$   
 $z_{\min} \leq z \leq z_{\max},$  where  
 $x_{\min}, y_{\min}, z_{\min}$  minimum size of the work area,  
 $x_{\max}, y_{\max}, z_{\max}$  maximum size of the work area.  
 This statement, however, is characterized as marginal areas workspace. More exactly, the working area (eg. in a robot) expressed train "n" inequalities  $f_i(x, y, z)$ ,  $i = 1, 2, \dots, n$ , since they are characterized by all points of desk area, not only points lying on the boundary surfaces.
- *Size of the area.* Depends on the size of each dimension of space, with elements of make depends on the extent of movement axes.
- *Accessibility zone.* It can be defined by the vector passing through the work zone point in the direction of the best access to the zone.
- *The position and orientation of the zone.* It is defined with respect to the coordinate system of space, respectively as a part of the construction element.

*Workspace device* is a set of all points in the reference area undergoing a functional activity. The limited space is referred as control zone facilities. Important features include: shape, size and volume of the work area accessible to the work area, the position and orientation of the work area with respect to the reference coordinate system.

Example of *real space* (RS) is in Fig. 3, this is actually a plan view of the built physical plant. This space is possible by suitable choice of the coordinate system, for example, divided into two elementary region of type A - C or elemental area of type A - B - B. The size of the actual surface area (footprint) is simply the sum of the sizes of areas of the elementary area.

Example *wasted space* (WS) is in Fig. 4. Utilizable workspace has a space that is covered by various auxiliary components such as structural components of construction equipment (protruding actuator, the end position of motion axes, etc.). This space is possible by suitable choice of the coordinate system (a combination of cartesian and polar coordinates) divided into elementary areas type A - D - E. Floor area wasted space is then given by the sum of the sizes of areas of the elementary area.

**PARAMETRIC STRUCTURING OF PRODUCTION SYSTEMS TROUGHT ZONAL MODELS**

Gabriela Ižaričková; Vladimír Rudy

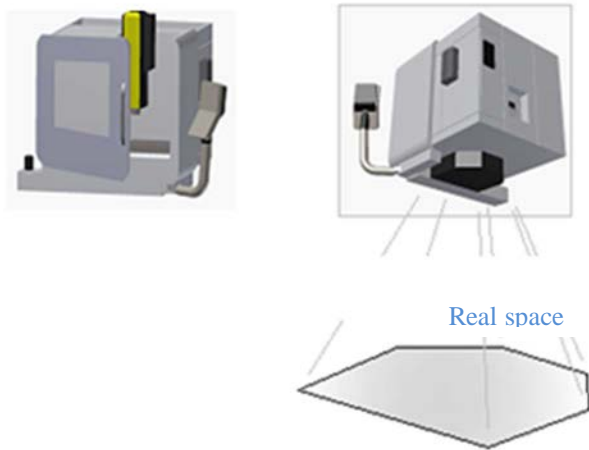

Figure 3 Real space

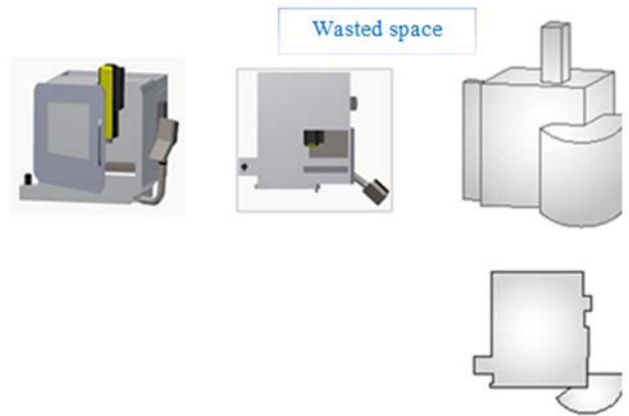

Figure 4 Wasted space

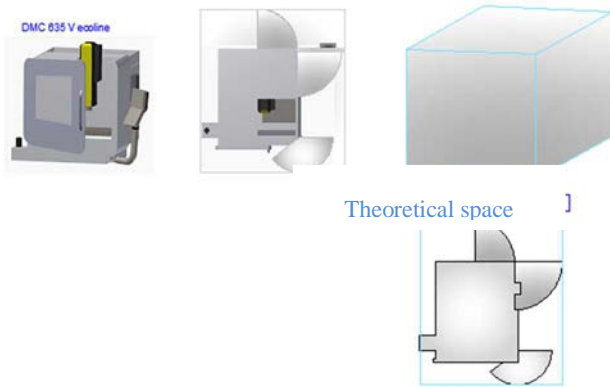

Figure 5 Theoretical space

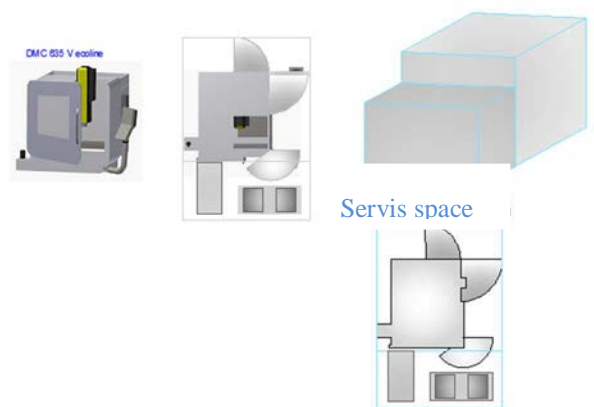

Figure 6 Service space

Example *theoretical space* (TS) is in Fig. 5. Theoretical work space has a real space occupied by manufacturing facilities including service, control and energy footprint (space permitting open electrical cabinets, access to filtered air conditioning, tool magazines, etc.). This space is possible by suitable choice of the coordinate system (a combination of cartesian and polar coordinates) divided into elementary areas type A - D - E. Floor area of theoretical space is then the sum of the sizes of areas of the elementary area.

Example of the total *service space* (SS) is in Fig. 6. The confinement production structure realizes all the technological operations operate production equipment. In its definition should be based on size and weight characteristics of object registration. This area is removed by the appropriate choice of the coordinate system divided into elementary zones of types A, D and E. Floor

area service area is then given by the sum of the size of areas of the elementary area.

When designing autonomous, modular modifications and their use, for example small business, resp. the business is in the production of space requirements for the equipment necessary to consider also the space for peripherals necessarily chosen to operate the production facility, for example compressor unit for compressed air and alike. Another determining factor can be inter-character and surgical manipulation (movement of the crane, etc.).

Comparing the size of the areas of different types of spaces it is valid:

$$P_{RS} < P_{WS} < P_{TS} < P_{SS} \text{ with } P_{SS} = \sum P_{RS} + P_{WS} + P_{TS} .$$

To determine the spatial characteristics of different types of spaces built production facility continues to be valid (Table 1).



**PARAMETRIC STRUCTURING OF PRODUCTION SYSTEMS TROUGHT ZONAL MODELS**

Gabriela Ižaríková; Vladimír Rudy

Table 1 Mathematical description of the calculation of the spatial claims

Type of space	Elementary area	Size of the area
Real space	type A – C	$P = P_A + P_C = \iint_{Z_A} dx dy + \iint_{Z_C} dx dy$
Theoretical space	type A – D – E	$P = P_{A1} + P_{A2} + P_{A3} + P_D + P_{E1} + P_{E2} + P_{E3} + P_{E4} =$ $P = \iint_{Z_{A1}} dx dy + \iint_{Z_{A2}} dx dy + \iint_{Z_{A3}} dx dy + \iint_{Z_D} dx dy +$ $+ \iint_{Z_{E1}} \rho d\rho d\phi + \iint_{Z_{E2}} \rho d\rho d\phi + \iint_{Z_{E3}} \rho d\rho d\phi + \iint_{Z_{E4}} \rho d\rho d\phi$
Wasted space	type A – D – E	$P = P_{A1} + P_{A2} + P_{A3} + P_{A4} + P_{A5} + P_D + P_{E1} + P_{E2} =$ $P = \iint_{Z_{A1}} dx dy + \iint_{Z_{A2}} dx dy + \iint_{Z_{A3}} dx dy + \iint_{Z_{A4}} dx dy + \iint_{Z_{A5}} dx dy +$ $+ \iint_{Z_D} dx dy + \iint_{Z_{E1}} \rho d\rho d\phi + \iint_{Z_{E2}} \rho d\rho d\phi$
Servis space	type A – B – D – E	$P = P_{A1} + P_{A2} + P_{A3} + P_{A4} + P_B + P_D + P_{E1} + P_{E2} =$ $P = \iint_{Z_{A1}} dx dy + \iint_{Z_{A2}} dx dy + \iint_{Z_{A3}} dx dy + \iint_{Z_{A4}} dx dy + \iint_{Z_B} dx dy +$ $+ \iint_{Z_D} dx dy + \iint_{Z_{E1}} \rho d\rho d\phi + \iint_{Z_{E2}} \rho d\rho d\phi$

### Conclusions

An analysis of current approaches to the description of the premises and areas show a relatively high degree of fragmentation. Most descriptions of a formal nature and its design is virtually little usable. For practical use are needed more exact descriptions, using mathematical and other principles applicable especially in automation design.

The proposed models workspaces manufacturing facilities provide the possibility of such deployment optimization problems. Models decomposition into elementary space area is characterized by considerable versatility in terms of application conditions, because they are suitable for design automation, as well as traditional manufacturing facilities.

### Acknowledgement

This article was supported by implementation of the grant project VEGA 1/0708/16 “Development of a new research methods for simulation, assessment, evaluation and quantification of advanced methods of production”.

### References

- [1] DANESHJO, N., KRAVEC, M.: *Perspectives on supply chain management, Interdisciplinarity in theory and practice*, Arad-Romania, 2015.
- [2] KOVÁČ, J.: *Projektovanie výrobných procesov a systémov*, SjF TU v Košiciach, 2006. (Original in Slovak)

- [3] IŽARÍKOVÁ, G.: *Modely pre automatizované projektovanie montážnych systémov*, Dizertačná práca, SjF TU v Košiciach, 2008. (Original in Slovak)
- [4] RUDY, V.: *Inovačné postupy a metódy pre projektovanie výrobných systémov*, Habilitačná práca. SjF TU v Košiciach, 2009. (Original in Slovak)

### Review process

Single-blind peer reviewed process by two reviewers.