

1

2017



Slovak Journal of Food Sciences

www.potravinarstvo.com

Potravinárstvo Slovak Journal of Food Sciences

Volume 11

Issue 1

2017

ISSN 1337-0960 (online)

Scientific journal for food industry
Vedecký časopis pre potravinárstvo



potravinárstvo®

**Slovak Journal of
Food Sciences**

• Journal title: Potravinárstvo Slovak Journal of Food Sciences • Volume: 11, Issue: 1/2017 • Evidence no. of the Ministry of Culture of Slovak Republic: 3771/09 • ISSN 1337-0960 (electronic version, online) • Publisher: Association HACCP Consulting, Slivková 12, 951 01 Nitrianske Hrnčiarovce, Slovakia, European Union • Publisher cooperates with Department of Food Hygiene and Safety, Faculty of Biotechnology and Food Sciences, Slovak University of Agriculture in Nitra • Editor: Ing. Peter Zajác, PhD. • Periodicity: Articles are published continuously in 1 issue per year • Form of the publishing: electronic online journal • Journal language: English • Journal website: www.potravinarstvo.com • Address of Editor office: Potravinárstvo Slovak Journal of Food Sciences, Slivková 12, 951 01 Nitrianske Hrnčiarovce, Slovakia, European Union • E-mail: info@potravinarstvo.com • Tel.: +421908164361, +421904138562 • Linguistic editing: Published articles have not undergone language editing, authors are fully responsible for grammar in the articles • Graphic design: Association HACCP Consulting • Price: not for sale • Distributor: Association HACCP Consulting via the www.potravinarstvo.com • Place of publication: Nitra, Slovakia, European Union • Legal information and authors rights: authors and advertisers are legally responsible for information published in articles or advertisement. Potravinárstvo Slovak Journal of Food Sciences, Editor and Editorial Board are not responsible for any third parties damages or claims for compensation arising out of or in connection with published articles or advertisement in Potravinárstvo Slovak Journal of Food Sciences or journal website www.potravinarstvo.com • Journal is indexed in: SCOPUS, CrossRef, DOAJ Directory of Open Access Journals, EBSCO Host, CAB Abstracts and CABI Full text, FSTA – The Food Science Resource, UIUC OAI registry, AGRIS/FAO, DRJI Directory of Research Journals Indexing, Google Scholar, OCLC The OAIster database, INDEX Copernicus, UlrichsWeb Global Serials Directory, MENDELEY, EZB Electronic Journals • Name and abbreviation of journal used for indexation in international databases: *Potravinárstvo Slovak Journal of Food Sciences* (*Potravinárstvo S. J. F. Sci.*). Former journal title: Potravinárstvo®.

Copyright: © 2007 – 2017 **Potravinárstvo Slovak Journal of Food Sciences**. Articles can be used according to License: CC BY 3.0. **Potravinárstvo®** is registered mark of the Association HACCP Consulting and can not be used with our written permission.



Scope of the Potravinarstvo Slovak Journal of Food Sciences

Articles published in the journal are peer reviewed and freely available online. Journal covers areas including: food hygiene, food safety and quality, food microbiology, food laws and regulations, ingredients and ingredient functionality, nutraceuticals, product formulation, sensory science and sensory statistical analysis, process control and its contribution to food processing operations, food chemistry, food toxicology, food engineering, food technology and biotechnology, nourishment, public health, primary production of food, food adulteration, food economics and marketing, environmental effect on food and food machinery.



Open Access

We are providing free online access to all published articles in our journal. You are free to:

- Share — copy and redistribute the material in any medium or format.
- Adapt — remix, transform, and build upon the material for any purpose, even commercially.
- The licensor cannot revoke these freedoms as long as you follow the license terms.

If you decide to use articles published in our journal you have to:

- Make statement (citation), that article was published first time in our journal according to the example presented below in the copyright.



<https://creativecommons.org/licenses/by/3.0/>



Plagiarism Policy

Potravinarstvo Slovak Journal of Food Sciences does not allow any form of plagiarism. Plagiarism is considered to be a serious breach of scientific ethics by the Journal. We are using Crossref Similarity Check Powered by iThenticate to protect authors rights.

Journal Metrics

Powered by **Scopus**

SNIP 2014: **0.035**, IPP 2014: **0.031**, SJR 2014: **0.109**



Školenia pre potravinárske firmy

Školenia sú akreditované Ministerstvom školstva SR

- **Školenie:** Zásady Správnej výrobnjej praxe a systému HACCP. Osobná hygiena a prevádzková hygiena.
- **Školenie:** Systém manažérstva bezpečnosti potravín podľa STN EN ISO 22000:2005
- **Individuálny prístup, školenie priamo u Vás, modelové situácie**

**Vydávame osvedčenie o absolvovaní školenia s
celoživotnou platnosťou**

- HACCP
- IFS
- BRC
- ISO 22000
- ISO 9001
- Recenzia etikiet
- Prevádzkové poriadky
- Audity

HACCP Consulting
0908164361, 0904138562
www.haccp.szm.sk

Editor:

Ing. Peter Zajác, PhD.

 Slovak University of Agriculture in Nitra, Faculty of Biotechnology and Food Sciences, Department of Food Hygiene and Safety, Slovakia

Deputy of Editor:

prof. Ing. Jozef Golian, Dr.

 Slovak University of Agriculture in Nitra, Faculty of Biotechnology and Food Sciences, Department of Food Hygiene and Safety, Slovakia

Manager for communication:

Ing. Vladimír Vietoris, PhD.

 Slovak University of Agriculture in Nitra, Faculty of Biotechnology and Food Sciences, Department of Storing and Processing of Plant Products, Slovakia

Sub-Editors:

doc. Ing. Radoslav Židek, PhD.

 Slovak University of Agriculture in Nitra, Faculty of Biotechnology and Food Sciences, Department of Food Hygiene and Safety, Slovakia

Ing. Vladimír Vietoris, PhD.

 Slovak University of Agriculture in Nitra, Faculty of Biotechnology and Food Sciences, Department of Storing and Processing of Plant Products, Slovakia

Ing. Jozef Čapla, PhD.

 Slovak University of Agriculture in Nitra, Faculty of Biotechnology and Food Sciences, Department of Food Hygiene and Safety, Slovakia

Ing. Martin Vencelík, PhD.

 Regional Office of The Public Health Authority of The Slovak Republic in Nitra, Slovakia

Ing. Dagmar Kozelová, PhD.

 Slovak University of Agriculture in Nitra, Faculty of Biotechnology and Food Sciences, Department of Food Hygiene and Safety, Slovakia

Chairman Editorial Board:

prof. Ing. Jozef Golian, Dr.

 Slovak University of Agriculture in Nitra, Faculty of Biotechnology and Food Sciences, Department of Food Hygiene and Safety, Slovakia

Editorial Board:

prof. Ing. Mária Angelovičová, CSc.

 Slovak University of Agriculture in Nitra, Faculty of Biotechnology and Food Sciences, Department of Food Hygiene and Safety, Slovakia

doc. MVDr. Bohuslava Tremlová, PhD.

 University of Veterinary and Pharmaceutical Sciences Brno, Czech Republic

prof. Ing. Stanislav Kráčmar, DrSc.

 Tomas Bata University in Zlín, Faculty of Technology, Department of Food Technology, Czech Republic

prof. MVDr. Jozef Nagy, PhD.

 University of Veterinary Medicine in Košice, Slovakia

doc. Ing. Jolana Karovičová, CSc.

 Slovak University of Technology in Bratislava, Slovakia

doc. Ing. Róbert Toman, Dr.

 Slovak University of Agriculture in Nitra, Slovakia

prof. Dr. Teresa Fortuna, DSc.

 Agricultural University of Cracow, Poland

prof. Tadeusz Trziszka, Ph.D., DSc.

 University of Wroclaw, Poland

Ing. Roman Labuda, PhD.

 Institute of Agrobiotechnology, Tulln, Austria

Ing. Zuzana Bírošová, CSc.

 Ministry of Agriculture SR

Prof. Dr. Shamim Ahmed

 Institute of ophtalmology. J.N. Medical College, India

Dr. Oksana Belous

 State Research Institute of Xisco, Russia

Ana Carla Marques Pinheiro, Ds.

 UFLA Lavras, Brazil

prof. Gábor Gécsi

 Szent István University, Hungary

Dr. Péter Korzenszky, PhD. associate professor

 Szent István University, Hungary

MVDr. Ing. Václav Trojan

 Mendel University in Brno, Czech Republic

prof. Dr. Peter Raspor, Dr.h.c.mult., Uni. dipl. eng.

 University of Primorska, Slovenia

Mgr. Maroš Jakab, PaedDr.

 St. Vincents Private Hospital, Dublin, Ireland

M.Sc Mohammad Ali Shariati

 Islamic Azad University, Tehran, I. R. Iran

M.Sc. Bahareh Hajirostamlo

 Islamic Azad University, Sabzevar Branch, I. R. Iran

prof. M.A. Paiman Mahasti, PhD.

 Islamic Azad University, Sabzevar Branch, I. R. Iran

prof. M.Sc. Salam, A., Ibrahim, PhD.

 North Carolina A&T State University,
Greensboro, NC, USA

prof. Dr. Julijana Tomovska

 University "St. Kliment Ohridski" – Bitola, Former
Yugoslav Republic Macedonia

Ing. MVDr. Ján Buleca, PhD.

 Technical University in Košice, Slovakia

Pharm Dr. Maciej Bilek, PhD.

 University of Rzeszow, Faculty of Biology and
Agriculture, Department of Food and Agriculture
Production Engineering, Poland

Assoc. Prof. Birzhan Nurgaliyev, PhD.

 West Kazakhstan Agrarian-Technical University,
Zhangir Khan, Uralsk, Republic of Kazakhstan

Assoc. Prof. Assylbek Zhanabayev, PhD.

 Seifullin Kazakh Agro-Technical University,
Astana, Republic of Kazakhstan

H A C C P

CONSULTING

PODPORUJEME VEDU A VÝSKUM

www.haccp.sk



EVALUATION OF THE PRESSING PROCESS DURING OIL EXTRACTION FROM GRAPE SEEDS

Patrik Burg, Vladimír Mašán, Kazimierz Rutkowski

ABSTRACT

This study evaluated the physical properties and oil extraction from grape seeds from three white (Welschriesling, Green Veltliner, Hibernál) and two red (Zweigelt and Saint Laurent) must varieties of grapevine by cold screw pressing as the appropriate extraction process. Pressing was carried out by a screw press UNO FM 3F by Farnet Company, Czech Republic. The pressing device consists of a matrix, 220 mm screw, head, heating mantle, nozzle holder, and a nozzle of 10 mm in diameter. The minimal and maximal screw rotation speeds were chosen within the press characteristics in order to achieve a correct expression and to avoid press overload. For successful pressing of the seeds and their storage, their initial moisture content was lowered from 40 to 45% to about 5 to 8% in a chamber dryer. The temperature in the chamber dryer did not exceed 40 °C. Seeds of all varieties were pressed at the same speeds of 20, 40, 60, and 80 rpm. The characteristics of the grape seeds are as follows: The density ranges from 602.7 to 606.3 kg.m⁻³, thousand seeds weigh is between 21.9 – 26.6 g, humidity between 5.6 – 7.1% of dry matter and seed oil content, determined by extraction and depending on the variety, ranges from 15.3 to 17.5% in dry basis. The results have confirmed that when the screw rotation speed is changed from 20 to 80 rpm, the press capacity increases on average from 0.84 kg.h⁻¹ to 1.75 kg.h⁻¹, but simultaneously the oil yield reduces from 9.85 to 6.75%. This means that one kilogram of seed may produce 67.5 to 98.5 g of oil. The quantity of the pressed oil ranges from 67.5 to 98.5 g.kg⁻¹ and thus depends on the variety. The measured results can be used in commercial practice for optimizing the pressing process for pressing of oil from grape seeds.

Keywords: grape seeds; grape seed oil; screw press; rotation speed; physical properties

INTRODUCTION

A large volume of winery waste remains unexploited every year on an international level. Grape production is considered to be one of the most important agro-economic activities in the world, with more than 77 million tons of grapes (*Vitis vinifera* L.) produced globally in 2013, with about 45 million tons of them produced in the European Union (FAO, 2013). Grape processing and subsequent production of wine is associated with the production of large quantities of waste. The most common among them are grape marc and wine lees.

Winemaking wastes, traditionally considered an economic and environmental problem, are now increasingly becoming recognised as valuable commodities for the production of value added products, such as grappa or vine seed oil (Passos, 2009).

Oil from grape seeds can be obtained in two ways. Mechanical extraction (pressed oil) and chemical or solvent extraction (Soxhlet methods and hexane as solvent) are the most common and widespread methods of extracting grape seed oil. To ensure higher oil quality, mechanical pressing is preferred. It uses lower process

temperature and no solvent however, lower yields between 55 – 95% are achieved depending on the processed raw material (Singh and Bargale, 2000). Screw pressing has been studied for a large variety of oilseeds, including linseed, canola, crambe, and chia seeds (Savoire et al., 2013).

In this respect, the major aim of this research work is to explore possible ways for the use of winery wastes, specifically separation of seeds from grape marc and their subsequent extraction by a small-capacity screw press.

According to the Codex Standards for Fats and Oils from Vegetable Sources, grape seed oil is the oil which is produced from the grape seeds of *Vitis vinifera* L. The oil content in the grape seeds and the content of bioactive compounds in whole grapes are characteristics specific for each variety and depend on environmental conditions (Pardo et al., 2009). For commonly grown varieties of grapes in Central European conditions these data are not yet available. According to data from literature, the amount of oil in dried seeds is between 5 – 20% (Tobar et al., 2005, Baydar et al., 2007, Tangolar et al., 2009, Yousafi et al., 2013).

The grape seed oil is rich in linoleic acid (65 to 72%), oleic acid (12 to 23%), palmitic acid (4 to 11%), and stearic acid (8.5 to 15%). Linoleic acid found in grape seed oil plays an important role as it is not synthesized in the human body itself and this is why products containing it have significant nutritional value. Corresponding recommendations in linoleic acid has sunflower oil, soybean oil, safflower oil (member of the sunflower family), corn oil, and poppy seed oil. The oleic acid also contributes to nutritional value of oil as it affects the oxidative stability of oils (Aparicio et al., 1999, Frančáková et al., 2015).

This paper is aimed at determining the physical properties and mechanical extraction (pressed oil) from different varieties of grape seeds using a small-capacity screw press.

MATERIAL AND METHODOLOGY

Grape seeds

Collection of grape marc for the separation of seeds was carried out in the 2015 processing season at the Agropol Mikulov Company. A prototype of vibratory separator was used to separate the seeds from marc. This machine applies the principle of mechanical vibrations transmitted on three flat screens with different shapes and sizes of holes. Separation of seeds was carried out separately from marc from three white (Welschriesling – VR, Green Veltliner – VZ, and Hibernál – HIB) as well as two red (Zweigelt – ZW and Saint Laurent – SV) must varieties of grapevine. For successful pressing of the seeds and their storage, their initial moisture content was lowered from 40 to 45% to about 5 to 8% in a chamber dryer. The temperature in the chamber dryer did not exceeded 40 °C. Material was kept in a closed bag, at room temperature until screw pressing.

Determination of water content and density

Water content of grape seeds was determined by dehydration at 103 °C according to CSN EN ISO 665 (461025) Oilseeds – Determination of moisture and volatile matter content. Analysis was made on 5 g of grinded sample, weighted with an accuracy of 0.1 mg. Results are expressed as the ratio of water loss per gram of dried sample. Determination of water content was performed in triplicate. Density of oil was determined pycnometrically according to CSN EN ISO 6883. This international standard specifies a method for the determination of the conventional mass per volume (“litre weight in air”) of vegetable fats and oils.

Determination of the total lipid content in the seeds through extraction

To determine the total lipid content, the Soxhlet extractor was used with hexane as a solvent.

Crushing the seeds of a given variety always took place immediately prior to the extraction of oil using an ETA grinder. Emphasis was always placed on precise cleaning of the grinder in order to avoid distorting the results. For seeds of each variety after grinding, the water content of the sample. The temperature of the extraction mixture was kept by the heating mantle closely around the boiling point of hexane (70 °C). Extraction was always carried out for 32 hours. Subsequently, the hexane was evaporated and

the sample weighed twice at intervals of two days. During this time, the sample of oil was kept in a dark environment.

Screw press parameters

Screw press type UNO FM 3F from the Farnet Company, Czech Republic, served for experimental measurements. This model is intended for pressing of all kinds of oilseeds. The drive is configured for three-phase voltage with variable speed of the main drive using a frequency converter, which enables better optimization of pressing parameters. The press is composed of an electric motor (1.5 kW power), transmission, pressing device, motor starter, and frequency converter, which allows precise adjustment of rpm. The screw rotation speed could be adjusted from 10 to 150 rpm. The pressing device consists of a matrix, 220 mm screw, head, heating mantle, nozzle holder, and a nozzle of 10 mm in diameter.

Pressing process and experimental domain

Four variables, named factors hereafter, were investigated: the seeds of evaluated grape varieties, the screw rotation speed, the press performance, and oil yield (the preheating temperature).

Before screw pressing experiments, the press head was pre-heated at the desired temperature for 20 minutes using a temperature-regulated heating ring. Pressing experiments were conducted without external heating (cold pressing). During pressing, grape seeds were fed into the press on demand by gravity through the hopper and seeds level was maintained constant to ensure a constant press performance. The minimal and maximal screw rotation speeds were chosen within the press characteristics in order to achieve a correct expression and to avoid press overload. Seeds of all varieties were pressed at the same speeds of 20, 40, 60, and 80 rpm.

Statistical analysis

The data were analysed using a linear model with interactions by using the linear regression tool of Excel software (Microsoft, 2012). The *p*-values were used as a tool to check the significance of the effects and interactions. For all statistical tests a 95% confidence level was used.

RESULTS AND DISCUSSION

The values of the main parameters, namely seed density, weight of thousand seeds, as well as water and oil contents were determined in the grape seed varieties by the procedures described in the methodology (Table 1).

The measured values indicate that densities of seeds range from 602.7 to 606.3 kg.m⁻³. Other authors (Hardie et al., 1996) studied the determination of density of seeds and listed its values from 600 to 612 kg.m⁻³, while (Kiliçkan et al., 2010) showed the values to range between 613.1 – 626.1 kg.m⁻³.

The determined weight of thousand seeds in the evaluated samples ranged from 21.9 to 26.6 g, with humidity between 5.6 – 7.1% of dry matter. The highest values occurred in the Saint Laurent variety (25.4 g), while the lowest rates were in the Riesling variety (21.9 g). The mass of thousand grape seeds at moisture ranging from

Table 1 Characteristics of the processed grape seeds.

Seeds from grape variety	Densities of seeds (kg.m ⁻³ ±SD)	Thousand grain weight (g ±SD)	Water content (% dry basis ±SD)	Oil content (% dry basis ±SD)
Welschriesling	602.7 ±1.1	21.9 ±0.5	5.6 ±0.2	17.5 ±0.4
Green Veltliner	605.1 ±0.2	25.3 ±0.4	6.3 ±0.2	15.9 ±0.7
Hibernal	604.5 ±0.5	25.2 ±0.1	6.1 ±0.1	16.8 ±1.5
Zweigelt	604.4 ±0.4	26.6 ±0.1	6.5 ±0.3	15.3 ±0.3
Saint Laurent	606.3 ±0.6	25.4 ±0.1	7.1 ±0.2	16.7 ±0.3

8.26 to 26.14% in dry basis varies between 23.39 – 24.82 g (Kiliçkan et al., 2010).

The Soxhlet type extractor was used to determine the oil content of ground seeds. The oil content was expressed as the weight of extracted oil relative to the dry weight of the seed. The results indicate that the seed oil content, depending on the variety, ranges between 15.3% in Zweigelt and 17.5% in Riesling. The oil content in seeds of grape varieties grown in Turkey ranged from 11.6 to 19.6% (v/w) (Baydar and Akkurt, 2001). More authors reported similar values for different grape cultivars the oil content to range between 9.9 – 20.0% (Ohnishi et al., 1990, Schuster, 1992).

The pressing of seeds was carried out at speeds 20, 40, 60, and 80 rpm, while the screw rotation speed significantly affected the press capacity. When the screw rotation speed changes from 20 to 80 rpm, the press capacity increases on average from 0.84 kg.h⁻¹ to 1.75 g.h⁻¹ as indicated by the results (Table 2 and Figure 1 – Figure 4). At the same time, the results also indicate that at higher speeds of the press, the oil yield drops from 9.85 to

6.75%. This means that one kilogram of seed may produce 67.5 to 98.5 g of oil. The higher screw rotation speed reduces the oil yield (Savoire et al., 2013). This effect could be attributed to the conveying capacity of the press that increases with screw rotation speed (Vadke and Sosulski, 1988, Poustkova et al., 2010).

Cold pressing on a small-capacity UNO FM 3F press can thus generate, depending on the variety of seeds, between 42 – 54% of the total amount of oil contained in the seeds. The remaining amount of 46 to 58% of oil, contained in the residue after pressing (cake), may optionally be at a loss in quality obtained by the above extraction. The density of oil, depending on the variety, ranges between 904 – 942 kg.m⁻³.

When evaluating the values listed (Figure 1, Figure 2, Figure 3 and Figure 4), we have used their linear trendline, determined regression equations, and reported the coefficient of determination R². All evaluated variants show a very strong dependency.

The screw rotation speed significantly affected the oil yield (Savoire et al., 2013, Rombaut et al., 2015). Oil

Table 2 Values of oil yield (%) and the press performance (kg.h⁻¹) depending on the speed.

Variety	Densities of oil (kg.m ⁻³)	Controlling factor	Revolutions per minute (rpm)			
			20	40	60	80
Welschriesling	904	Values of oil yield (%)	9.85	9.43	9.18	8.94
		Press performance (kg.h ⁻¹)	0.87	1.18	1.53	1.92
Green Veltliner	942	Values of oil yield (%)	9.35	9.03	8.76	8.72
		Press performance (kg.h ⁻¹)	0.81	1.04	1.50	1.68
Hibernal	928	Values of oil yield (%)	7.38	7.28	6.90	6.75
		Press performance (kg.h ⁻¹)	0.85	1.11	1.52	1.77
Zweigelt	935	Values of oil yield (%)	9.10	8.78	8.63	8.32
		Press performance (kg.h ⁻¹)	0.85	1.15	1.51	1.75
Saint Laurent	913	Values of oil yield (%)	9.15	8.95	8.74	8.58
		Press performance (kg.h ⁻¹)	0.82	1.05	1.42	1.63

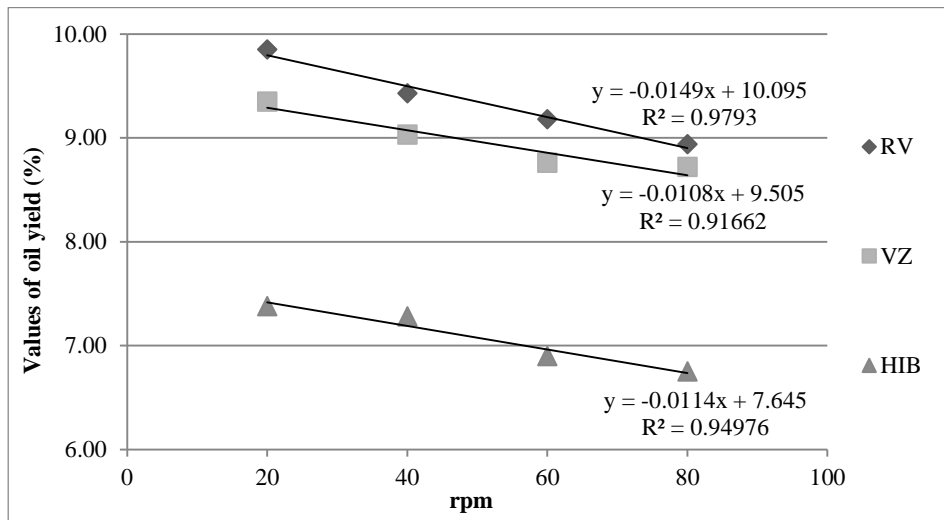

Figure 1 Effect of the number of revolutions of the press spindle for oil yield (%) in seeds of white grape varieties.

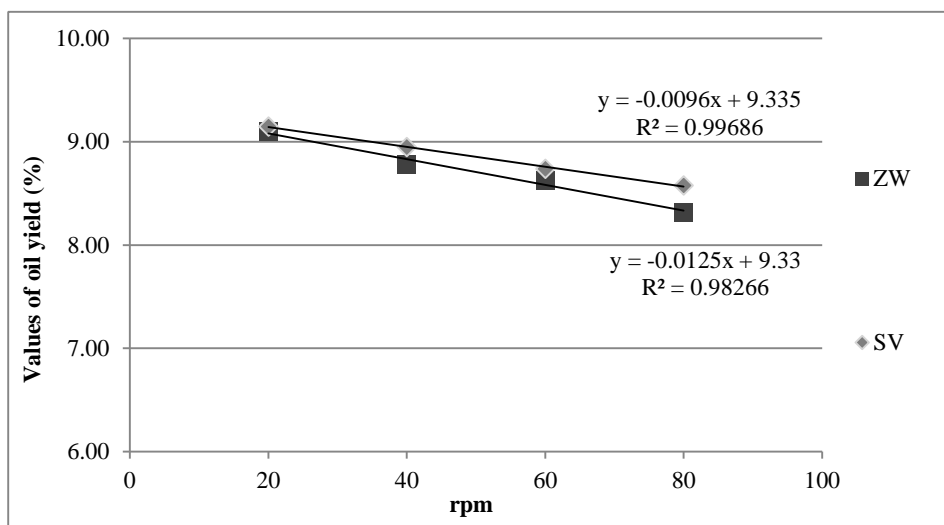

Figure 2 Effect of the number of press spindle revolutions on the oil yield (%) in seeds of red grape varieties.

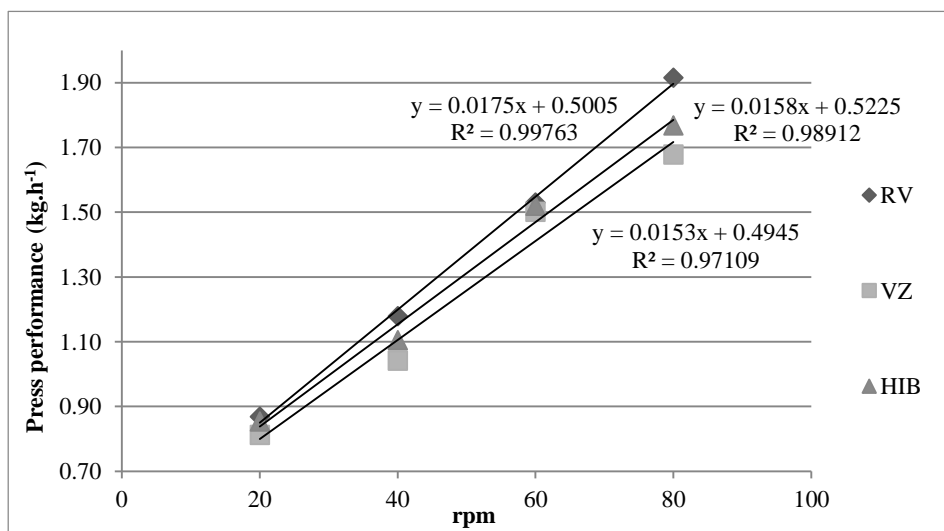

Figure 3 Effect of the number of press spindle revolutions on press capacity (kg.h⁻¹) in seeds of white grape varieties.

yield decreased on average from 58.6% at 40 rpm to 52.8% at 70 rpm. This effect already observed, especially (Vadke and Sosulski, 1988), is attributed to a decrease of pressure within the barrel with screw rotation speed.

Oil yield depends on the pressing speed, attained pressing pressure, duration of pressure action, conditions of outflow

of oil at a maximum pressure, viscosity, and oil temperature (Black and Bewley, 2000).

The material throughput and thus the achieved press performance can be increased by providing higher purity of pressed wine seeds (Savoire et al., 2013). It is therefore appropriate to ensure a high quality and efficient

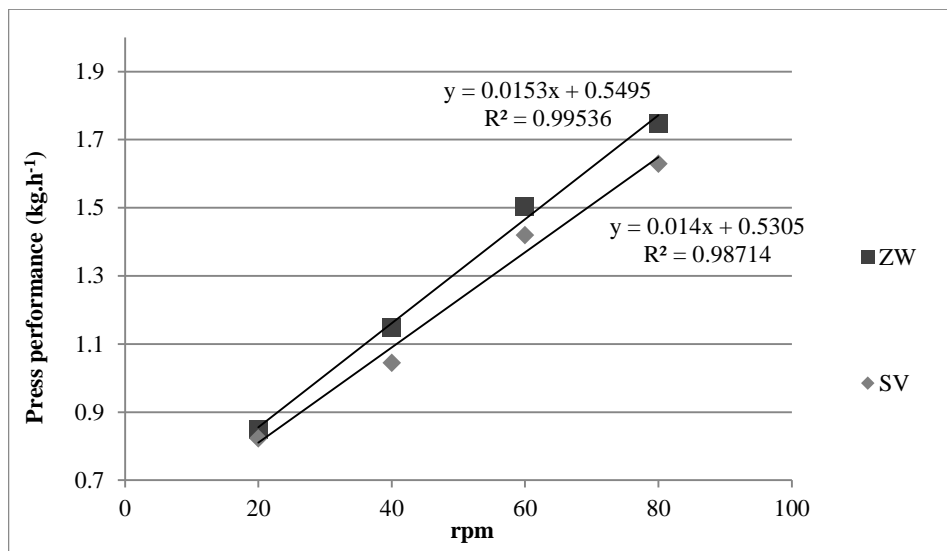

Figure 4 Effect of the number of revolutions of the press on press capacity (kg.h⁻¹) in seeds of red grape varieties.

separation of seeds and to remove the bulk of small impurities in the form of fragments or residues of stem and peel, which degrade the obtained product and prevent its further use for pressing. The quantity of foreign particles may comprise 12 to 18% of the total volume of mechanically separated seeds and may cause clogging of the press head.

In determining the grape oil yield and the associated economics of pressing operation, it is necessary not to forget the varietal difference in oil content of seeds collected from different grape varieties, including varietal differences in dimensions, size, and hardness of seeds (Kulp and Ponte, 2000). Decisive influence on the pressing process has the moisture content of seeds entering the press and the content of impurities entering together with the seeds into the press.

CONCLUSION

At present, the technology of producing grape seed oil has been technologically sufficiently mastered. However, in the conditions of the Central European countries, it is not widespread among viticultural activities. Grape seeds containing very important biologically active substances end up in most cases as completely unused waste material. Our experiments have focused on the evaluation of seeds in five must varieties of grapevine, namely Green Veltliner, Welschriesling, Hibernál, Zweigelt, and Saint Laurent. The characteristics of the grape seeds indicate that the density ranges from 602.7 to 606.3 kg.m⁻³, thousand seed weight ranges from 21.9 to 26.6 g, at a humidity of between 5.6 and 7.1% of dry matter, and seed oil content, determined by extraction, depending on the variety ranges between 15.3 and 17.5%. Seed samples were pressed using a screw press (UNO FM 3F made by Farnet, Czech Republic) at various speeds of 20, 40, 60, and 80 rpm. The results confirmed that when increasing the speed from 20 to 80 rpm, the efficiency of the press is increased by more than 100%. However, at the same rpm, oil yield decreases on average by approximately 46%. The statistical evaluation of all the analysed samples has shown a very strong dependency. Obtained data also indicate that one kilogram of seed can produce 67.5 – 98.5 g of oil through pressing. The measured results can be used in

commercial practice for optimizing the pressing process for pressing of oil from grape seeds.

REFERENCES

- Aparicio, R., Roda, L., Albi, M. A., Gutierrez, F. 1999. Effect of various compounds on virgin olive oil stability measured by Rancimat. *Journal of Agricultural and Food Chemistry*, vol. 47 no. 10, p. 4150-4155. <https://doi.org/10.1021/jf9812230> [PMid:10552782](https://pubmed.ncbi.nlm.nih.gov/10552782/)
- Baydar, N. G., Akkurt, M. 2001. Oil Content and Oil Quality Properties of Some Grape Seeds. *Turkish Journal of Agriculture and Forestry*, vol. 25, p. 163-168.
- Baydar, N. G., Özkan, G., Çetin, E. S. 2007. Characterization of grape seed and pomace oil extracts. *Grasas y Aceites*, vol. 58, no. 1, p. 29-33.
- Black, M., Bewley, J. D. 2000. *Seed technology and its biological basis*. Sheffield, UK : Sheffield Academic Press. 427 p. ISBN 1-84127-043-1.
- FAO 2013. FAOSTAT database collections. Food and Agriculture Organization of the United Nations. Rome [online] s.a. [cit. 2013-04-22] Available at: <http://faostat.fao.org>.
- Frančáková, H., Ivanišová, E., Dráb, Š., Krajčovič, T., Tokár, M., Mareček J., Musilová, J. 2015. Composition of fatty acids in selected vegetable oils. *Potravinarstvo*, vol. 9, no. 1, p. 538-542. <https://doi.org/10.5219/556>
- Hardie, W. J., O'Brien, T. P., Jaudzems, V. G. 1996. Morphology, anatomy and development of the pericarp after anthesis in grape, *Vitis vinifera* L. *Australian Journal of Grape and Wine Research*, vol. 2, no. 2, p. 97-142. <https://doi.org/10.1111/j.1755-0238.1996.tb00101.x>
- Kiliçkan, A., Üçer, N., Yalçın, I. 2010. Moisture-dependent physical properties of black grape (*Vitis vinifera* L.) seed. *Scientific Research and Essays*, vol. 5, no. 16, p. 2226-2233.
- Kulp, K., Ponte, J. G. Jr. 2000. *Handbook of cereal science and technology*. 2. ed., rev. and expanded. New York, NY : CRC Press, 424 p. ISBN 9780824782948
- Ohnishi, M., Hirose, S., Kawaguchi, M., Ito, S., Fujino, Y. 1990. Chemical Composition of Lipids, Especially Triacylglycerol, in Grape Seeds. *Agricultural and Biological Chemistry*, vol. 54, no. 4, p. 1035-1042.
- Pardo, J. E., Fernández, E., Rubio, M., Alvarruiz, A., Alonso, G. L. 2009. Characterization of grape seed oil from different grape varieties (*Vitis vinifera* L.). *European Journal*

of *Lipid Science and Technology*, vol. 111, no. 2, p. 188-193.

<https://doi.org/10.1002/ejlt.200800052>

Passos, C. P., Silva, R. M., Silva, F. A. D., Coimbra, M. A., Silva, C. M. 2009. Enhancement of the supercritical fluid extraction of grape seed oil by using enzymatically pretreated seed. *Journal of Supercritical Fluids*, vol. 48, no. 3, p. 225-229. <https://doi.org/10.1016/j.supflu.2008.11.001>

Poustkova, I., Babička, L., Kouřimská, L., Siegrová G., Staruch, L. 2010. Quality of hemp seed oil depending on its obtaining. *Potravinárstvo*, vol. 4, no. 3, p. 53-57. <https://doi.org/10.5219/32>

Rombaut, N., Savoie, R., Thomasset, B., Castello, J., Van Hecke, E., Lanoisellé, J. L. 2015. Optimization of oil yield and oil total phenolic content during grape seed cold screw pressing. *Industrial Crops and Products*, vol. 63, p. 26-33. <https://doi.org/10.1016/j.indcrop.2014.10.001>

Savoie, R., Lanoisellé, J. L., Vorobiev, E. 2013. Mechanical continuous oil expression from oilseeds: a review. *Food Bioprocess Technol.*, vol. 6, no. 1, p. 1-16. <https://doi.org/10.1007/s11947-012-0947-x>

Schuster, W. H. 1992. *Ölpflanzen in Europa* [online] s.a. [cit. 2013-04-22] Available at: https://www.vbio.de/vbio/content/e25/e19417/e19560/e19652/e32572/Oelpflanzen_ger.pdf.

Singh, J., Bargale, P. C. 2000. Development of a small capacity double stagecompression screw press for oil expression. *Journal of Food Engineering*, vol. 43, no. 2, p. 75-82. [https://doi.org/10.1016/S0260-8774\(99\)00134-X](https://doi.org/10.1016/S0260-8774(99)00134-X)

Tangolar, S. G., Ozogul, Y., Tangolar, S., Torun, A. 2009. Evaluation of fatty acid profiles and mineral content of grape seed oil of some grape genotypes. *International Journal of Food Sciences and Nutrition*, vol. 60, no. 1, p. 32-39. <https://doi.org/10.1080/09637480701581551>

[PMid:17886077](https://doi.org/10.1080/09637480701581551)

Tobar, P., Moure, A., Soto, C., Chamy, R., Zúñiga, M. E. 2005. Winery solid residue revalorization into oil and antioxidant with nutraceutical properties by an assisted process. *Water Science and Technology*, vol. 51, no. 1, p. 47-52.

Vadke, V. S., Sosulski, F. W. 1988. Mechanics of oil expression from canola. *Journal of the American Oil Chemists' Society*, vol. 65, no. 7, p. 1169-1176. <https://doi.org/10.1007/BF02660576>

Yousafi, M., Nataghi, L., Gholamian, M. 2013. Physicochemical properties of two type of shahrodi grape seed oil (Lal and Khalili). *European Journal of Experimental Biology*, vol. 3, no. 5, p. 115-118.

Acknowledgments:

Results are based on the solution of the research project IGA ZF MENDELU IGA – ZF/2016 – AP002, solved in the year 2016.

Contact address:

Patrik Burg, Mendel University in Brno, Faculty of Horticulture, Department of Horticultural Machinery, Valtická 337, 691 44 Lednice, Czech Republic, E-mail: patrik.burg@mendelu.cz

Vladimir Masan, Mendel University in Brno, Faculty of Horticulture, Department of Horticultural Machinery, Valtická 337, 691 44 Lednice, Czech Republic, E-mail: vladimir.masan@mendelu.cz

Kazimierz Rutkowski, University of Agriculture, Faculty of Production and Power Engineering, Institute of Agricultural Engineering and Informatics, ul. Balicka 116 B, pok. 402, 30-149 Krakow, Poland, E-mail: kazimierz.rutkowski@ur.krakow.pl

STUDY ON FATTY ACIDS COMPOSITION OF LIPID CLASS IN FISH OIL, PROXIMATE ANALYSIS AND CALORIE VALUE OF KIJAR IN IRAN

Ali Aberoumand, Narges Mohamedi, Maryem Zemanpoor

ABSTRACT

This aim of this research was to determine fatty acids and raw proximate composition and calorie value of fish Kijar in Iran. The fatty acids and proximate composition Kijar was determined. The established AOAC (Association of Official Agricultural Chemist, USA) methods were followed for composition bio chemical of fish. Mean moisture, fat, protein, ash, carbohydrate contents and calorie value of raw fish were 70.81%, 5.88%, 17.80%, 3.41%, 2.1% and 132.52 kcal, respectively. Among fatty acids, palmitic acid was a major fatty acid while stearic acid was the other major constituent. Unsaturated monoenoic fatty acids (oleic and palmitoleic acids were major constituents. Important unsaturated fatty acids such as EPA and DHA, were also identified. percentage composition of fatty acids in the lipid classes of oil of *Saurida undosquamis* which the saturated fatty acids ranges from 58% to 72.14%. Palmitic acid is predominant and its composition ranges 38.64% to 48.98% while stearic acid ranges from 11.35% to 19.50%. Among unsaturated fatty acids, monoenoic are the major fatty acids. Oleic acid ranges from 12.15% to 27.48%. It is concluded that fish kijar found as health seafood for Iranian southern peoples form point of view of nutritional values and valuable fatty acids. Therefore it is recommended people put this fish in diet basket and it consumed three times in the week.

Keywords: Kijar; biochemical composition; fish oil; oil fatty acids

INTRODUCTION

Fish is an essential, important, valuable, excellent and irreplaceable seafood item in the Iranian diet. Fish body composed of mainly water, lipid, vitamins, antioxidants, minerals (macro and trace), ash and protein though small amounts carbohydrates and non-protein compounds are present in a small amount (Harris, 1997; Garc A-arias et al., 2003; Siddique et al., 2012). The beneficial effects on health by including fish in a diet are well known and have been documented in several studies. Fish intake is associated with improved body health (Damsgaard et al., 2006). It is clear that, n-3 and n-6 polyunsaturated fatty acids are two families of essential fatty acids that must be provided in food such as seafood (Kaur et al., 2012). The highly unsaturated ω 3-polyunsaturated fatty acids (PUFA) docosahexaenoic acid (DHA, C22:6, ω -3), which is directly obtained from fish and other seafood and is essential and functional for body cells normal growth and development and may play an important and vital role in the prevention and treatment of coronary artery disease, hypertension, diabetics, arthritis, other inflammatory and autoimmune disorders ad cancer (Wang and Jones, 2004).

Food scientists who are interested in developing fish and other seafood into high-protein foods, while ensuring the finest quality organoleptic and safety obtainable with maximum nutritive value (Elagba et al., 2010). The aim of this research was to determination of fatty acids and raw proximate composition and calorie value of Kijar in Iran.

MATERIAL AND METHODOLOGY

Materials and preparation of sample

Kijar (approximately 8 kg) used in this research were purchased from a local fish market in Behbahan in Khuzestan, Iran on May 28 2012. The number of fish used was 12. They were kept inside the iced – boxes and transferred to the laboratory in 1.5 h. These fishes were chosen because they are readily available, cheap, affordable and within the reach of an average Iranian. On arrival to laboratory, fish were washed with tap water to remove adhering blood and slime. They were then prepared using common household practices, namely eviscerating and beheading. Cleaned fish were washed with tap water several times to remove blood. Raw samples were homogenized in blender and each group was analyzed. All samples were homogenized prior to analysis.



Figure 1 Fresh Kijar fish.

Analytical procedures

The recommended methods of the Association of Official Analytical Chemists were adopted for the analyses of the samples (AOAC, 2000). Ash was determined by the incineration Kjeldahl of 1.0 g samples placed in a muffle furnace maintained at 550 °C for 5 h (Kjeldahl, 1883). Moisture content was determined by heating 2.0 g of each sample to a constant weight in a crucible placed in an oven maintained at 105 °C. Crude fat was obtained by exhaustively extracting 5.0 g of each sample in a Soxhlet apparatus (High Performance Soxhlet Extractor grain oil testing apparatus Shanghai CC Instruments Co., Ltd. Chinese) using petroleum ether (b.p. 40 – 60 °C) as the extractant (AOCS, 1979). Crude protein (% total nitrogen x 6.25) was determined by the Kjeldahl method, using 2.0 g samples. Energy value was calculated by Atwater method (Falch Overrian et al., 2010).

Extraction of lipid

A homogenizer, Janke and kunkel IKA Wert Ultra Turax Type TP 18/10 (Germany) was used to homogenize the fish. The homogenized tissues were shaken with CHCl₃:MeOH (2:1,v/v) and the combined extract was fractionated and washed with distilled water to remove the impurities. The solvent layer was evaporated in vacuum, which in turn became enriched with the oil components (Khan et al., 1970).

Identification of lipid component

In general, the components were identified. The total fatty acids composition of fish oil been known. Only after the development and widespread application of GLC (Gas Manufacturing Corp., Model 0211-V45F-G8CX). by co-chromatography with reference standards was it possible to identify these components. The results are quoted as an average of fish in all cases.

Fatty Acids Composition

Fatty acids composition was carried out by gas chromatographic (GC) method using BF₃-methanol

(AOCS, 1979). 1 µL of extracted methyl-esters solution using BF₃-methanol method was injected directly into a gas chromatograph (Hewlett Packard Series II) equipped with a flame ionization detector (FID) and capillary column 30 m long, 0.25 mm inner diameter and a 0.25 µm film (Omegawax 320). The column oven was programmed at 200 °C, injection temperature at 220 °C and detector temperature at 250 °C. Helium was used as carrier gas at a flow rate of 25 cm.sec⁻¹. Quantitative data were analyzed using Hewlett Packard 3396A model integrator against fatty acids standards.

$$\% \text{ fatty acid composition} = (A/B) \times 100$$

where, A = area of specific fatty acid; B = total area of fatty acids present.

Statistical analysis

Results are expressed as mean of triplicate trials. Data were analyzed by one way analysis of variance on the means of values ($p < 0.05$).

RESULTS AND DISCUSSION

The biochemical compositions of the different kinds of raw, roasted, boiled and fried cooked samples are shown in Table 1. Proximate composition of raw Kijar was determined as moisture, fat, protein, ash, carbohydrate contents and calorie value, 70.81%, 5.88%, 17.80%, 3.41%, 2.1% and 132.52 kcal, respectively. Rate of crude protein, crude lipid, moisture and ash of Kijar were found to be different to rate of crude protein (19.56%), crude lipid (4.72%) and moisture (73.80%), ash (1.39%) content of fish (*Engraulis encrasicolus*) (Puwastien et al., 1999). Since fishes are consumed as a major protein source in seafood, it is very important that the protein content should not be compromised during table preparation. It is significant to note therefore that all the table processing different methods reduced the crude protein contents but the reduction did not follow a particular order or fish type. Fresh Kijar had the low crude protein content (Table 1).

Table 1 Proximate composition and calorie values of raw kijar.

	Moisture (%)	Crude Fat (%)	Crude Protein (%)	Crude Ash (%)	Carbohydrate (%)	Calorie (Kcal)
Raw	70.81 ± 0.61 ^a	5.88 ± 0.68 ^a	17.80 ± 0.33 ^a	3.41 ± 0.11 ^a	2.1 ± 0.12 ^a	132.52 ± 0.21 ^a

Note: The data are mean values ± Standard deviation (SD) of three replicates. a, b, c, d within the column, value with different letters are significantly different ($p < 0.05$).

Table 2 Fatty acids composition of lipid class in the oil of Kijar.

Fatty acids	Weight (%)					
	PL	MG	DG	FFA	TG	SE
Saturated						
C _{12:0}	2.56	0.37	0.16	0.04	0.32	3.80
C _{14:0}	2.33	2.24	1.47	0.09	1.95	8.10
C _{16:0}	58.46	51.01	50.95	35.50	47.47	40.88
C _{18:0}	11.49	10.61	11.07	10.05	0.96	13.51
Unsaturated						
C _{16:1}	15.92	9.12	11.49	13.32	16.02	7.46
C _{18:1}	4.82	20.36	22.98	0.35	29.06	18.52
C _{18:2}	-	0.65	-	55.07	-	0.81
C _{18:3}	-	0.22	0.34	-	0.29	-
C _{18:4}	1.56	1.32	0.85	0.08	0.59	1.64
C _{20:2}	2.15	2.13	1.32	-	0.72	2.45
C _{20:3}	-	2.76	1.62	1.24	-	2.08
C _{20:4}	0.51	0.70	-	3.93	0.24	-
C _{20:5}	0.68	0.39	-	-	0.19	0.89
C _{22:1}	1.05	0.45	0.21	-	0.15	-
C _{22:5}	2.25	1.25	1.45	0.63	-	3.93
C _{22:6}	0.52	0.95	2.43	-	0.09	1.05

The short hand designation of class lipids are represented as: PL: Phospholipids, MG: Monoglycerides, DG: Diglycerides, TG: Triglycerides, Free fatty acids.

Disappearance of water soluble amino acids during high temperature of heat processing may be responsible for the reduction in amino acid content and consequently a reduction in the protein content. Table 2 shows the percentage composition of fatty acids in the lipid classes of oil of *Saurida undosquamis* which the saturated fatty acids ranges from 58% to 72.14%. Palmitic acid is predominant and its composition ranges 38.64% to 48.98% while stearic acid ranges from 11.35% to 19.50%. Among unsaturated fatty acids, monoenoic are the major fatty acids. Oleic acid ranges from 12.15% to 27.48%. Significant increase of oleic acid and palmitic acid in fried fish sample is due to the type of cooking oil used thus further explaining the fat-moisture exchange that happens during frying process and excess fat absorption from cooking oil (Yanar et al., 2007). The dienoic and trienoic are minor constituents. Poly unsaturated fatty acids (PUFA) range from 5.28% to 16.26% in which EPA and DHA contain this class. However, monoacylglycerol, diacylglycerol, free fatty acids and sterylester fractions of lipid classes do not contain EPA. The same component has been examined in silver carp and bighead carp at similar ratios (Kubow, 1992). The effect of cooking methods on fatty acids were not investigated, because research was limited.

CONCLUSION

Medicinally important fatty acids like PUFA and ω -3 are abundant in the marine fish. Diets enriched with fish would be helpful in avoiding preventing heart problems. The studied fish contains unsaturated fatty acids and proximate composition such as ash, protein, fat and energy suitable values. Therefore, it can be concluded that the studied fish fillet was good form point of view of nutritive

value for Iran southern people consumption, for two times in a week for peoples health.

REFERENCES

- AOAC. 2000. Association of Official Analytical Chemists. Official methods of analysis (14th ed.) Arlington, VA.
- Kjeldahl J. 1883. Determination of protein nitrogen in food products. Encyclopedia of Food Science. p.439-441.
- AOCS. 1979. Official and Tentative Methods of the American Oil Chemists' Society. Vol.1, AOCS, Champaign, IL.
- Damsgaard, C. T., Schack-Nielsen, L., Michaelsen K. F. 2006. Fish oil affects blood pressure and the plasma lipid profile in healthy Danish infants. *Journal of Nutrition*, vol. 136, p. 94-99.
- Elagba, H. A. M., Rabie, A., Mansour, H. M. 2010. Proximate composition, amino acid and mineral contents of five commercial Nile fishes in Sudan. *African Journal of Food Science*, vol. 4, no. 10, p. 650-654.
- Falch Overrian, I., Solberg, C., Slyzyete, R. 2010. Compositions and calories In Nolle, L. M. L. And Toldrá, F. Handbook of seafood and seafood product analysis. New Boca Raton, FL : CRC Press. Taylor and Francies Group. p. 257-288.
- García-Arias, M. T, Álvarez-Pontez, E, García-Linares, M.C., García-Fernández, M. C., Sánchez-Muniz, F. J. 2003. Cooking-freezing-reheating (CFR) of sardine (*Sardinapichardus*) fillets, effect of different cooking and reheating procedures on the proximate and fatty acid compositions. *Food Chemistry*, vol. 83, no. 3, p.349-356. [https://dx.doi.org/10.1016/S0308-8146\(03\)00095-5](https://dx.doi.org/10.1016/S0308-8146(03)00095-5)
- Harris, W. S. 1997. n-3 fatty acids and serum lipoproteins: human studies. *American Journal of Clinical Nutrition*, vol. 65, no. 164, p. 5S-54S.
- Kaur, N., Chugh, V., Gupta, A. K. 2012. Essential fatty acids as functional components of foods – a review. *Journal*

of *Food Science and Technology*, vol. 51, no. 10, p. 2289-2303.

<https://doi.org/10.1007/s13197-012-0677-0>
[PMid:25328170](https://pubmed.ncbi.nlm.nih.gov/25328170/)

Khan, A. H., Khalid, Q., Ali, S. S. 1970. Studies on the seed oil of *Abrus precatorius*. L. Composition of the lipid classes. *Pakistan Journal of Science of Industry Research*, vol. 13, p. 391.

Kubow, S. 1992. Routes of formation and toxic consequences of lipid oxidation products in foods. *Free Radical Biological Medicine*, vol. 12, p. 63-81.

Puwastien, P., Judprasong, K., Kettwan, E. 1999. Proximate composition of raw and cooked Thai freshwater and marine fish. *Journal of Food Composition and Analysis*, vol. 12, p. 9-16. <https://doi.org/10.1006/jfca.1998.0800>

Siddique, M. A. M., Mojumder, P., Zamal, H. 2012. Proximate composition of three commercially available marine dry fishes (*Harpodon nehereus*, *Johnius dussumieri* and *Lepturacanthus savala*). *American Journal of Food Technology*, vol. 7, no.7, p. 429-436. <https://doi.org/10.3923/ajft.2012.429.436>

Wang, Y. W., Jones, P. J. H. 2004. Conjugated linoleic acid and obesity control: efficacy and mechanisms. *International Journal of Obesity and Related Metabolic Disorders*, vol. 28, p. 941-955.

<https://doi.org/10.1038/sj.ijo.0802641>

[PMid:15254484](https://pubmed.ncbi.nlm.nih.gov/15254484/)

Yanar, Y., Küçükgülmez, A., Ersoy, B., Çelik, M. 2007. Cooking effects on fatty acid composition of cultured sea bass (*Dicentrarchus labrax*) fillets. *Journal of Muscle Foods*, vol.18, p.88-94. <https://doi.org/10.1111/j.1745-4573.2007.00068.x>

Acknowledgments:

The author is grateful to Behbahan Katam Alanbia University for providing necessary laboratory facilities and for financially supports this project.

Contact address:

Ali Aberoumand, Behbahan Khtam Alanbia University of Technology, Iran. Department of Fisheries, Postal address: No: 22, second Alley of Ab va barg, Zolfegari street, Behbahan, Khuzestan, Iran, Tel.: 00919166716540, E-mail: aberoumand@ybkatu.ac.ir

Narges Mohamedi, student of Department of Fisheries, Behbahan Khtam Alanbia University of Technology, Iran. E-mail: mohamedi@yahoo.com

Maryem Zemanpoor, student of Department of Fisheries, Behbahan Khtam Alanbia University of Technology, Iran, E-mail: zemanpoor@yahoo.com

EFFECTIVENESS OF A DEVELOPED POTATO STORAGE SYSTEM IN SHELF LIFE AND NUTRITIONAL QUALITY COMPARED TO TRADITIONAL PRACTICE IN BANGLADESH

Fahad Jubayer, Burhan Uddin, Abu Taher Muhammad Ziauddin

ABSTRACT

This research was carried out to achieve the objective of finding out the performance of a developed potato storage system in storage life and nutritional quality and comparing the system to the traditional practice in Bangladesh. A laboratory version of improved design of potato store and its construction was made at Bangladesh Agricultural University which consisted an evaporative cooling chamber, made of reinforced concrete cement; partially filled-in with water. Two varieties of potato (Diamant and Lal Pakri) were used in this research. Both large and small types for each kind of potato varieties were taken. Experimental design was set up for both improved storage bin and farmer's traditional practice. Spoilage, sprouting, shrinkage, moisture content, vitamin C, and total sugar content of potato were determined for both methods of storage at a regular interval and results were compared. Economic benefit of the developed storage system over traditional practice was also determined. From the result of the study, it appeared that the improved potato storage bin was better in shelf life and nutritional quality for storing potato than the farmer's traditional practice.

Keywords: Evaporative cooling; potato; sprouting; shrinkage; storage

INTRODUCTION

Potato is one of the most important staple crops in the human diet around the world. Potatoes have been grown in Bangladesh since the 19th century. By the 1920s, the first commercial production of the crop was established in the country (Islam, 1983). Nowadays, potato has emerged as a major food crop in Bangladesh and is being cultivated throughout the country. The total production of potato is 6648 thousand tons from the area of 400 thousand hectares (BBS, 2008). About 81% of the total potatoes produced in the country are harvested from January to April and are available for market, but only 28% of those potatoes are demanded as ware potatoes during the period. This creates a surplus of 53% of ware potatoes, which have to be used or stored over the next 6 months from May to November (Hossain et al., 2009). With respect to the role of post-harvest technology in the development of Asian economies, Tsubota (1999) noted that post-harvest technologies become more complex along with economic development. Potato is one of the major food items in Bangladesh which are preserved in cold storage for commercial storage purpose. During 2007 – 2008 potato coverage of 402 thousand hectare, production of 6650 thousand MT and average productivity of 16.6 t.ha⁻¹ have been reported. (Rabbani et al., 2010). During 2009 – 2010

production of potato was even higher than the previous years. Due to lack of storage space in nearby cold storage and limitation of household storage facilities it has been quite difficult for farmers to store it in nearby cold storages. At present, only 25 – 30% of the total potatoes produced in the country can be preserved in cold storages. Therefore, there is a need for both short and long term storage of potato. During post harvest operations, some losses occur which is called post-harvest losses (Ritenour, 2003). There are about 300 cold storages in Bangladesh with a capacity of 2.2 million tons. In the year 2008, about 27.5% of total production of potato was stored in the cold storage including seeds (Rashid, 2008). Rest of the potatoes was stored by using traditional storage system.

The chemical composition of the potato tuber is dependent on the cultivar, growing season, location, soil temperature, soil water quality, fertilization, as well as the duration and condition of storage (Burton et al., 1992; Kumley et al., 2002). Variations in chemical composition have a major impact on processing stability and quality (Iritani, 1981; Burton et al., 1992; Shock et al., 1993; Kumlay et al., 2002). Good storage should prevent excessive loss of moisture, development of rots, and excessive sprout growth. It should also prevent accumulation of high concentration sugars in potatoes,

which results in dark-colored processed products (Hossain et al., 2009). To help prevent the Maillard reaction accompanied by undesirable sensory symptoms, low reducing sugar content is appropriate (Mareček et al., 2016). Temperature, humidity, carbon dioxide and air movement are the most important factors during storage (Harbenburg et al., 1986; Maldegem, 1999). When potatoes lose excessive moisture they shrink and may become unmarketable. Sprouting will significantly increase water loss in stored and transported potatoes. Sprouting will also diminish the nutritive quality of the potato. Therefore, sprout inhibitors are required after potatoes pass their dormant phase (Shetty et al., 1998).

In India, Central Potato Research Institute (Ilangantileke et al., 1996) has developed a community level Evaporative Cooled Store (ECS) for potato that could store potato up to 120 days beyond the growing season. Moreover, to overcome the problem of inadequate cold storage capacity and heavy price reduction short term non-refrigerated storage of potatoes has been recommended in northern plains of India in a potato store (ECS) cooled by passive evaporative cooling (Kaul et al., 1984). Evidence from on-farm trials showed that, with good management, use of evaporative cool stores (ECS) could reduce storage losses by half compared with farmers' traditional storage methods. With evaporative cooling system, on-farm potato storage can be extended to up to four months, compared

with one to three months using traditional methods. Therefore, the present experiment was carried out to design and construct a laboratory version of an improved potato storage bin based on the principles of forced evaporative cooling system, to conduct experiment with the developed potato storage bin and farmers traditional practice as well as to compare the performance between the developed and existing methods of potato stores.

MATERIAL AND METHODOLOGY

Experimental site and period

A potato storage bin was installed inside a newly built Post-harvest Preservation and Processing Laboratory in the Department of Farm Power and Machinery, Bangladesh Agricultural University, Mymensingh, Bangladesh. The experiment was started on 1st April 2013 and continued up to 30th November 2013. Laboratory experiments for the determination of nutritional parameters were conducted in laboratory of Food Technology and Rural Industries, Bangladesh Agricultural University, Mymensingh, Bangladesh.

Design of improved potato storage bin

The improved potato storage bin works on the principle of evaporative cooling. The height and diameter of the experimental storage structure were 3.0 m and 2.0 m

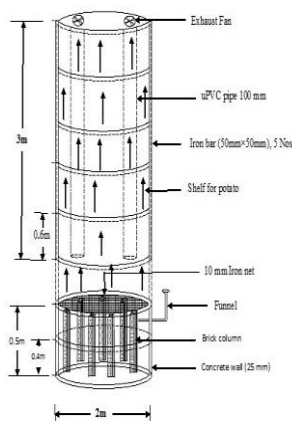

Figure 1 Improved potato storage bin (a) Complete drawing with dimensions (b) Photographic view.

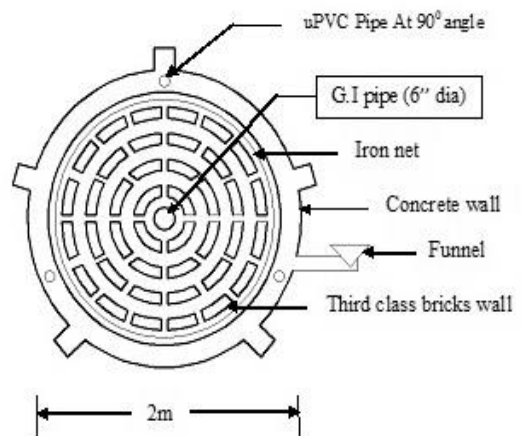

Figure 2 Evaporative cooling chamber (a) Photographic (b) Top view.

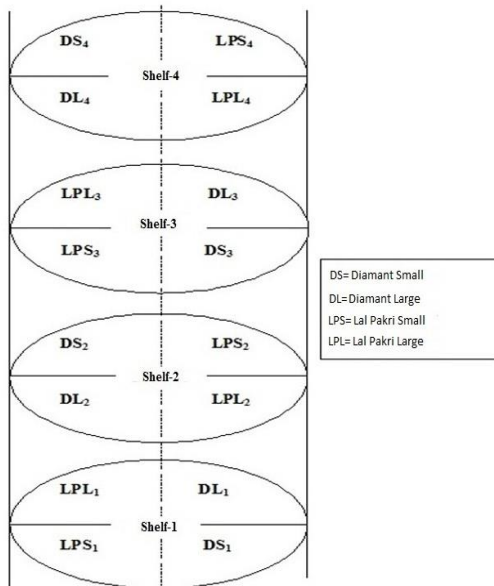

Figure 3 Loading pattern of potato in the improved storage bin.

respectively and the height of each shelf was 0.6 m. To facilitate evaporation and successive cooling action, two exhaust fans that powered by solar panel were used. Four perforated PVC pipe at 90° angles were used so that cool and moist air flowed from evaporative cooling chamber passed uniformly thorough the improved storage bin. A schematic diagram and an experimental prototype of the bin and its cooling chamber are shown in Figure 1 and Figure 2

Description of principle of forced evaporative cooling of stored potato

Evaporative Cooling System (ECS) store is a small store house where potato could be stored in bulk on a raised platform inside an insulated closed structure. Improved ECS was constructed using locally available material such as cement, sand, and M.S. rod. Reinforced cement concrete and bricks were used to build the evaporative

chamber having 2.0 m diameter and 0.5 m height at the bottom of the store. At least half of the chamber holds water all the time so that rest of the brick block (having water soaking properties) at upper portion can get wet by capillary action. Water was poured in to the evaporative chamber time to time to maintain a constant level of water. An outside transparent plastic tube indicated the required level of water. A forced air ventilation by a rotary exhaust fan, powered by solar panel, located at the top of the storage bin helped accelerate evaporate water from the evaporative chamber kept below the storage bin. Cool and moist air flow helped maintain the inside storage temperature below the air temperature inside the bin. Two exhaust fans (each 300 mm dia), placed on the top of the storage bin and powered by three solar panels forced the inside air out so that the potato enjoyed fresh air/oxygen from outside the bin. These exhaust fans generated an airflow rate of 0.6 m³/m²/sec and was operational only during 12 hours day time.

Selected varieties of potato for the experiment

Two potato varieties (Lal pakri and Diamant) in two different sizes (small and large), were stored inside the bin on 25 March 2013. Before loading into the bin the potatoes were sorted and allowed several days for curing. Potatoes were stored in four different shelves. Each shelf contained four categories of potatoes (Lal Pakri-small, Lal Pakri-large, Diamant-small, and Diamant-large). All potatoes were stored in nylon netted sack of 10 kg each. In addition, ten small nylon netted sack of one kg potato from each category was placed in each shelf for determination of moisture content, vitamin C, and total sugar content. Equivalent Farmers’ Traditional Storage (here after called Farmer’s Practice) was also maintained inside the laboratory with the same categories of the potato.

Design of experiment

The principle of Completely Randomized Block Design (CRBD) with 3 factors, 4 replications was considered for experimentation. There were eight treatment combinations (2×2×2=8) as follows:

- Factor A (Storage condition: 2 levels): (a) Improved storage (b) Normal storage,
- Factor B (varieties of potato: 2 levels): (a) Diamant (b) Lal Pakri,
- Factor C (Size of tubers: 2 levels): (a) Large (b) small.

Sixty kg (in 6 bags) potatoes of each of (a) Diamant Large (about 100 gm/tuber), (b) Diamant Small (about 51 gm.tuber⁻¹), (c) Lal pakri Large (about 23 gm/tuber) and (a) Lal Pakri Small (about 11 gm.tuber⁻¹) were loaded on all the 4 shelves of the Improved Storage Bin as per loading pattern shown in Figure 3. In total, 960 kg potatoes were loaded into the Improved Storage Bin for experimentation.

For the Equivalent Farmer’s Traditional Storage (Farmer’s Practice) 115 kg of Diamant Large, 110 kg of Diamant Small, 85 kg of Lal Pakri Large and 120 kg of Lal Pakri Small potatoes were kept on C.C. floor (over a bamboo mat with a thin layer of dry sand) inside the same room in which the Improved Storage Bin was located.



Figure 4 Photographic view of equivalent farmer's traditional practice.



Figure 5 Photographic view of data measuring instruments: (a) Data logger (b) Digital thermometer, hygrometer, anemometer, and blower.

Loading pattern of potato into the improved storage bin

There were two varieties (Lal pakri and Diamant) of two different sizes (small and large) of potato. Before loading into the bin potatoes were sorted and kept laid on the floor for several days for curing. Sorting was done manually. Potatoes were stored in four different shelves. Each shelf contained four categories of potatoes: Lal Pakri-small (LPS), Lal Pakri-large (LPL), Diamant-small (DS) and Diamant-large (DL). Every 10 kg of potato was kept in nylon netted sack. In addition, ten small nylon netted sacks containing 1 kg potato from each category was placed in each shelf for determination of moisture, vitamin C, and sugar content. Potato loading pattern for experimentation is shown in Figure 3.

Equivalent farmer's traditional practice

Farmer's traditional equivalent practice was also maintained inside the laboratory for comparing with the improved potato storage bin for different categories of potatoes viz. Lal Pakri-small (120 kg), Lal Pakri-large (85 kg), Diamant-small (110 kg), and Diamant-large (115 kg) (Figure 4). Potatoes were observed to figure out spoilage, sprouting, shrinkage, moisture content, vitamin C, and sugar content.

Experimental data collection

Experimental data collection was started on April 2013 and continued up to November 2013. Air temperature above four shelves (inside the bin) and the temperature of potato at sixteen points were recorded by a data logger and

Lab View software (Figure 5). Air flow through the bin, relative humidity of air inside the bin, and ambient air temperature were measured. Sample potato was taken from 16 different cells of the shelves to find out the spoilage, sprouting, shrinkage, moisture content, vitamin C, and total sugar content.

Determination of biological parameters

Determination of potato spoilage

Number of potato spoiled (i.e. unacceptable due to rotten) was recorded by observation method at 15 days interval for all categories and population of potato kept in the sacks. The amount (by weight) of spoiled potato was calculated multiplying the number of spoiled potato found by the mean weight per potato tuber. Similarly, same method was followed to determine the spoilage found in farmer's traditional practice. Thus, monthly spoilage of potato was obtained for both the storage methods.

Determination of sprouting

The method of eye observation and measured by length of sprouts was considered in estimating the percent of potato sprouted in each sack kept in four shelves of the experimental potato storage bin as well as potato of Farmer's Equivalent Traditional Storage. Sprouting of a potato was considered here for its growth 10 mm and above. It was observed when potato samples were taken for determination of other parameters mentioned above.

Determination of shrinkage

Shrinkage is another phenomenon of natural potato stores. It was estimated by the volume decreased in a

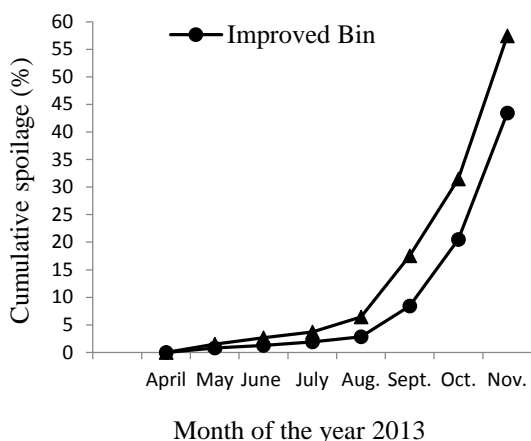

Figure 6 Spoilage of Diamant (small) variety.

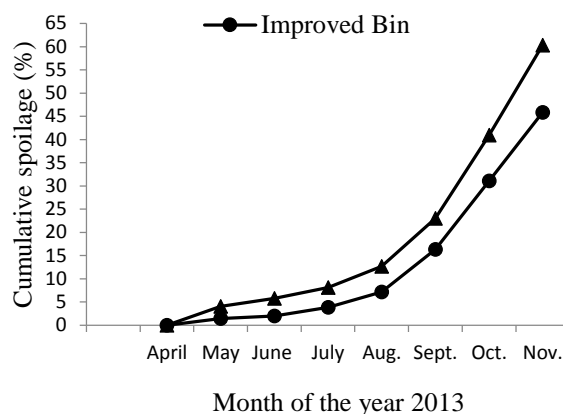

Figure 8 Spoilage of Lal Pakri (large) variety.

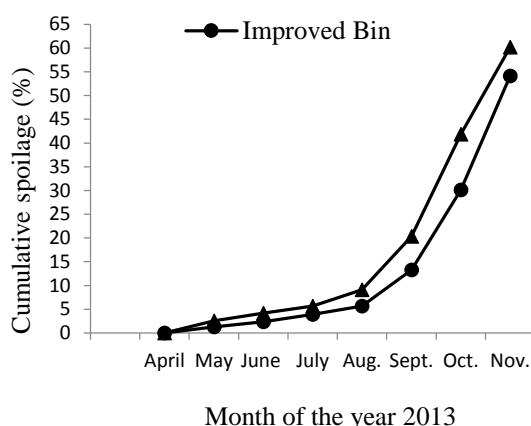

Figure 7 Spoilage of Diamant (large) variety.

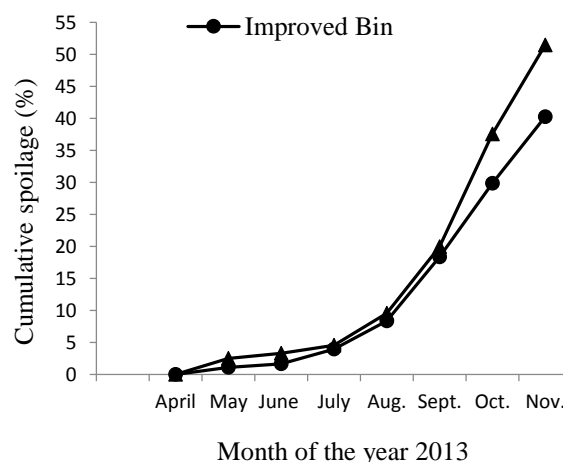

Figure 9 Spoilage of Lal Pakri (small) variety.

particular time of sample collection and was recorded by observation method and scaled using Likert scale (0 – 5) of quality assessment. Zero (0) and 5 indicates 0% and 50% shrinkage by volume, respectively.

Determination of nutritional parameters

Determination of moisture content

Moisture content was determined by following the AOAC official method 934.06 (2005).

Determination of vitamin c content

Vitamin C content was determined by using AOAC International Methods of Analysis volume 16 Method 967.21 (1995)

Determination of sugar content

Total sugar content of the sample was determined by following the method of Rangana (1991)

Economic benefit

Ignoring the fixed cost of the facilities, calculation of the gross economic benefit using improved storage bin may be calculated using the following model. The model determines the relative savings of potato from loss in the Improved Storage Bin over farmer’s traditional storage.

$$B = p \times [(ps - plsp \times ldsp - plsk \times ldsk)] \tag{1}$$

Where:

- B = Gross benefit in the improved storage bin over farmer's storage in any month, Tk.kg⁻¹,
- p = Unit market price of potato, Tk.kg⁻¹,
- ps = Percent of potato saved,
- plsp = Price loss factor for sprouting, fraction,
- ldsp = Percent loss difference due to sprouting,
- plsk = Price loss factor for shrinkage, fraction,
- ldsk = Percent loss difference due to shrinkage.

Optimum duration of storage

The optimum duration of potato stored in the improved storage bin may be determined by the time unit (month) when the economic benefit (B) becomes maximum. Mathematically, it could be obtained by taking first derivative of the benefit equation (1) and equating to zero value. That is:

$$d(B)/d(t) = p \times [(ps - plsp \times ldsp - plsk \times ldsk)] = 0$$

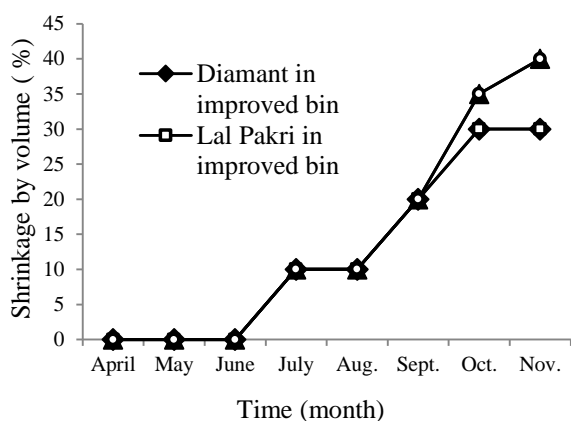

Figure 10 Shrinkage of different varieties of potato for improved bin and farmer’s practice.

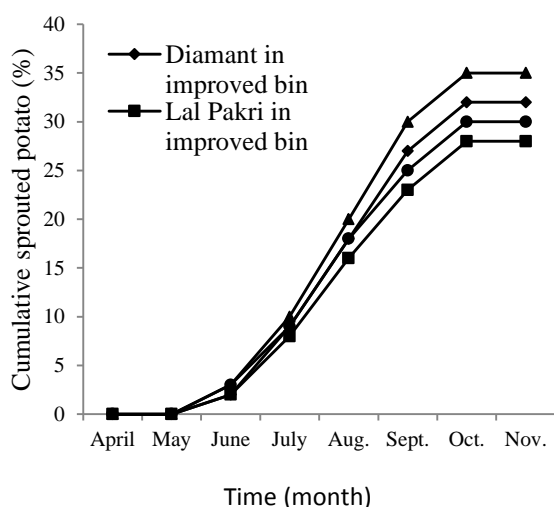

Figure 11 Sprouting of different varieties of potatoes for improved bin and farmer’s practice

RESULTS AND DISCUSSION

Potato spoilage

Spoilage of potatoes is shown in Figure 6 to Figure 9, for four categories of potatoes. These figures indicate that the average spoilage of all four categories of potatoes in the Improved Storage Bin was 20.06% lower than that of Farmer’s Traditional Practice. On the other hand, the figures also show that the spoilage rate was also higher in Farmer’s Practice than that of Improved Storage Bin. The quality in terms of physical appearance of potatoes (before and after experimentation) found better in the Improved Storage Bin than that of Farmer’s Practice. No difference of spoilage of potatoes was found between the shelves of the Improved Storage Bin. The Evaporative Cooling Chamber at the bottom of the Improved Storage Bin positively contributed in cooling the potato as well as maintaining the required humidity inside the bin. As a result the spoilage and the shrinkage of potato were found 20.06% and 25.00% less, respectively, in the Improved Storage Bin than that of farmer’s practice.

Shrinkage

Shrinkage is another phenomenon of natural potato stores. Figure 10 shows the percent of shrinkage of potato

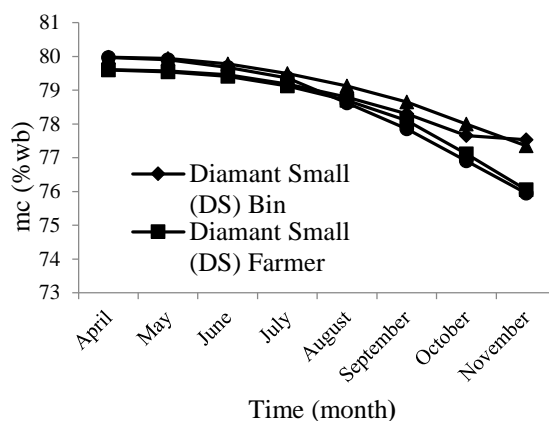

Figure 12 Moisture content of potato (Diamant variety) for improved bin and farmer’s practice.

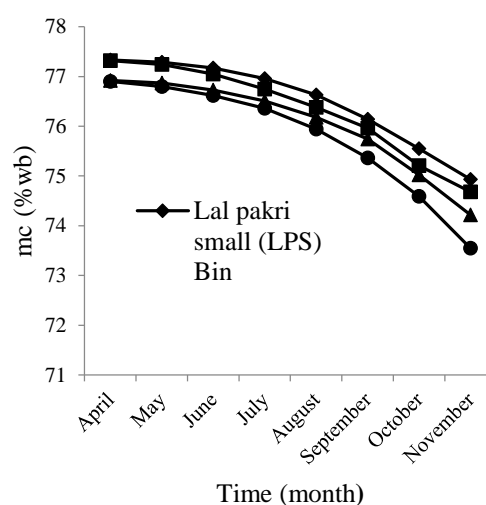

Figure 13 Moisture content of potato (Lal pakri variety) for improved bin and farmer’s practice.

over time. Shrinkage increased with the increase of time. It was observed after six months of storing (i.e. beyond September); it was 25% higher in case of farmer’s practice than that of improved bin. It revealed that shrinkage of potato was lower in the Improved Storage Bin than that of farmer’s practice.

Sprouting

Sprouting was the common phenomenon of stored potato in both the method of storage. Sprouting of potato started after four months of storing but growth stopped after six months in both the method. Figure 11 represents the growth of sprout. It indicates that the percent of sprouting was 8.57% lower for Diamant variety in the Improved Storage Bin than that of farmer’s practice. Sprouting was found lowest (6.66%) in case of Lal Pakri stored in the Improved Storage bin. That means Improved Storage Bin performed better regarding control of sprouting. It may be mentioned here that no control measure for sprouting was undertaken in both the storage methods.

Moisture content of potato

Moisture content of stored potatoes decreased with the increase of time. The average moisture content of Diamant

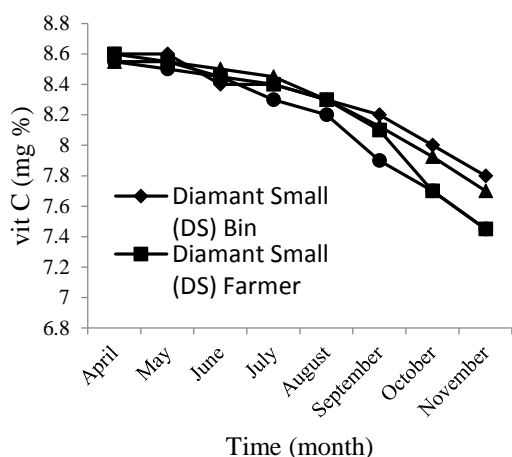

Figure 14 Vitamin C content of potato (Diamant variety) for improved bin and farmer's practice.

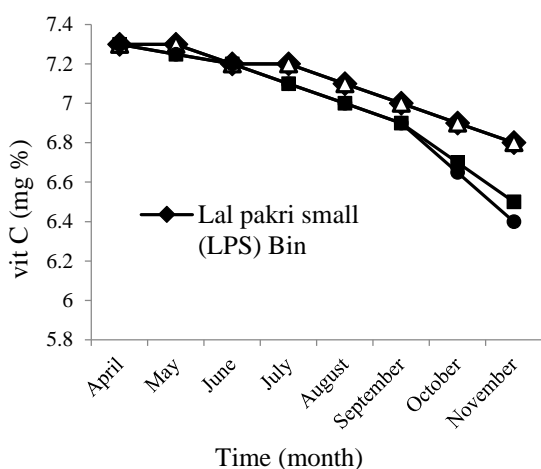

Figure 15 Vitamin C content of potato (Lal pakri variety) for improved bin and farmer's practice

variety as measured in the beginning of storing was about 79 percent for both the method of storage. The rate of moisture loss for Diamant variety with respect to time is shown in Figure 12. It can be said that potatoes from improved bin had experienced a less amount of moisture loss during the eight month period while moisture loss of potatoes from farmer's practice was higher. Moisture loss of Diamant small variety in improved bin and farmer's practice was 2.61% and 4.4% respectively. In case of Diamant large variety it was 3.28% and 5.02% respectively. Similar types of results were observed in Lal Pakri variety as shown in Figure 13. Loss of moisture of Lal Pakri small variety in improved bin and farmer's practice was 3.10% and 3.41% respectively, where loss of moisture of Lal Pakri large variety in improved bin and farmers' practice was 3.51% and 4.32% respectively.

Vitamin-c content

Vitamin C content of stored potatoes decreased with the increase of time. Figure 14 shows that the loss of vitamin C content was found 4.07% and 2.92% higher in Diamant small and Diamant large varieties, respectively, in farmer's practice than that stored in the Improved Storage Bin. Same kind of trends can be seen in case of Lal Pakri small and Lal Pakri large varieties from Figure 15 where loss of

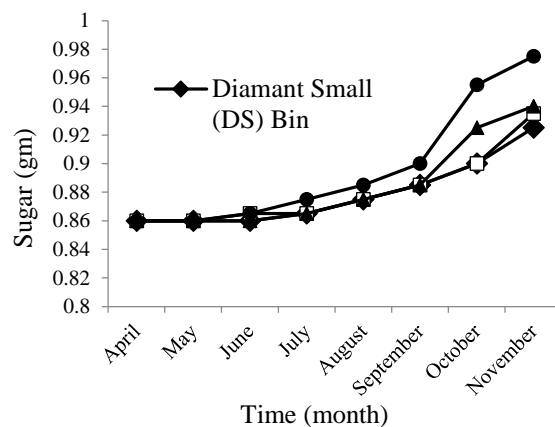

Figure 16 Sugar content of potato (Diamant variety) for improved bin and farmer's practice

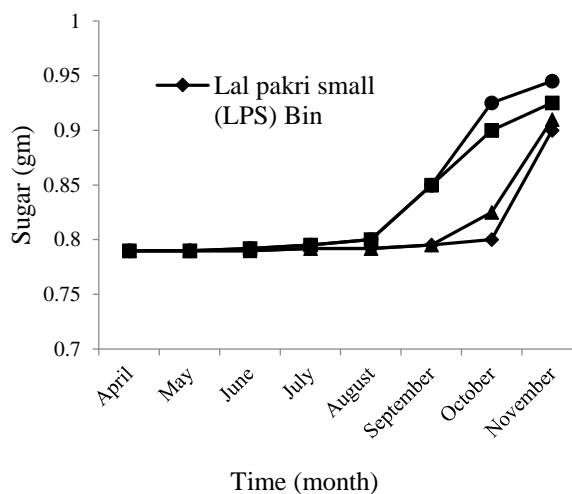

Figure 17 Sugar content of potato (Lal pakri variety) for improved bin and farmer's practice.

vitamin C was found 4.1% and 5.47% higher respectively in farmer's practice than that of improved storage bin. However, the level of vitamin C loss was higher in the Diamant variety than that of Lal Pakri variety. It may be concluded that the Improved Storage Bin could help maintain higher level of vitamin C than that of farmer's practice.

Sugar content

When stored at relatively low temperature, tubers of conventional potato varieties accumulate sugars. Figure 16 and Figure 17 indicates that Diamant Large variety accumulated much sugar than Diamante Small variety and Lal Pakri Large variety accumulated much sugar than that of the Lal Pakri small variety. However, total sugar content of stored varieties in farmer's practice found slightly higher than that of improved storage bin.

Economic benefit

The economic benefit depends mainly on market price of potato. If the price of potato increases significantly with time of storage then the Improved Storage Bin will be more beneficial and attractive to the potato farmers and traders. In 2013, the increase of market price of potato beyond harvest season was not significant with compare to

last couple of years. The price trend of potato is graphically presented in Figure 18. This price trend was used to calculate the gross benefit of use of Improved Storage Bin over farmer's traditional practice. Gross benefit decreases with increased rate of sprouting and shrinkage. The price loss due to sprouting and shrinkage considered here were 10% and 80%, respectively. Ignoring

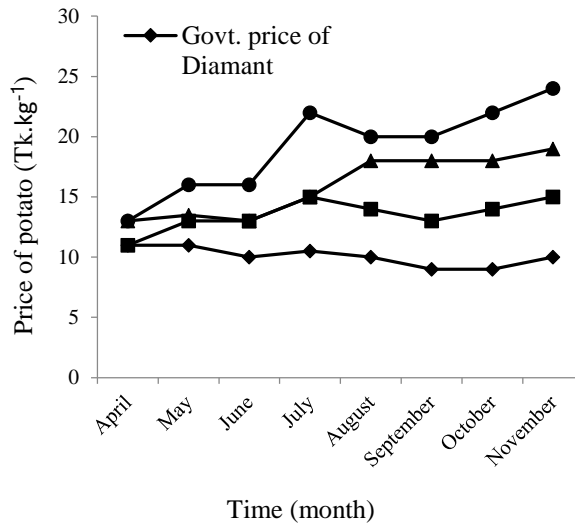

Figure 18 Government and market price of potato in the year 2013.

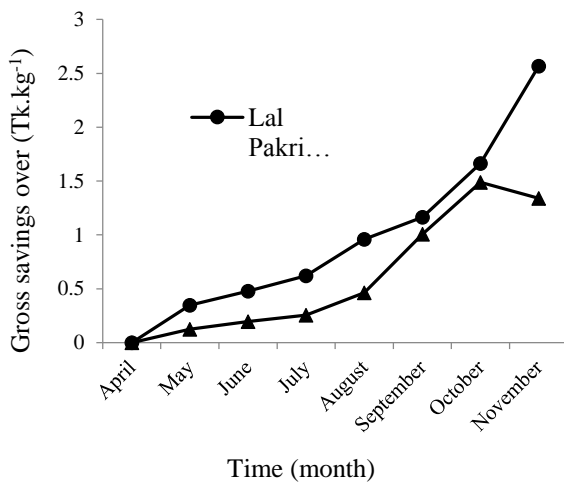

Figure 19 Gross savings in improved potato storage bin over farmer's practice.

fixed cost of the storage methods, the gross benefit of using improved storage bin over farmer's practice was calculated using equation no. 1 mentioned above and is presented in Figure 19. Fixed cost has been ignored here because the laboratory version of the storage structure cannot be compared with Farmer's Practice until a farmer version is available. Therefore, only the variable costs were considered. It reveals that the maximum gross benefit of storing Diamant variety using improved storage bin found in the month of October. Beyond October the gross benefit started decreasing due to price loss for higher level of shrinkage and/or sprouting. In other words, Diamant variety could be stored up to seven months after harvest. On the other hand, Lal Pakri could be stored in the improved storage bin for longer period with higher profit.

This was mainly due to higher market price of Lal Pakri than that of Diamant variety. Figure 19 indicates that Lal Pakri would bring gross profit by Tk. 2.57 per kg (calculated using market price of November 2013) over Farmer's Practice, if stored up to November. On the other hand, Diamant variety would bring gross profit by Tk. 1.34 per kg over Farmer's Practice, if stored up to November.

CONCLUSION

Experimental results revealed that there was always a significant temperature difference between potato and air inside the bin. Potato spoilage gradually increased proportionally with the months. This trend was found in farmer's traditional practice also. But percentage of cumulative spoilage was lesser in the improved bin. No significant difference of spoilage was found among different layers of potato laid inside of the improved bin. Spoilage of potato progressively increased from April to November. Sprouting was found from the mid of June. It was higher in farmer's practice than that of storage bin. Sprouting of potato gradually increased from June to October, but stopped in November. Shrinkage of potato was almost same in both of the practices but found higher in farmer's practice than that of storage bin from October to November. In case of nutritional parameters the improved storage showed a good level of performances. Moisture content of potato kept decreasing at a gradual rate. But potatoes in the improved bin experienced a less amount of moisture loss than that of farmer's traditional practice. Same type of trend also found in case of vitamin C content. Besides, the sugar accumulation in the improved bin was a bit less than the farmer's practice. Moreover, the improved storage bin may bring benefit for both Diamant and Lal Pakri varieties but higher gross benefit and longer safe storage for Lal Pakri variety. In this study, we have also possibility of further research. The technology may be tested for multi-purpose use with similar crops so that it could be more profitable and attractive to farmers. Finally, it can be said that the improved potato storage bin was better for storing potato than the farmer's traditional practice.

REFERENCES

AOAC. 2005. *Official Methods of Analysis, Eighteenth edition*. Association of Official Analytical Chemists, Washington, D.C.

AOAC. 1995. *Official Methods of Analysis, Association of Official Analytical Chemists*, Washington, D.C.

BBS. 2008. *Statistical Yearbook of Bangladesh*. Bangladesh Bureau of Statistics, Statistics Division, Ministry of Planning, Government of the People's Republic of Bangladesh, Dhaka, Bangladesh.

Burton, W. G., Van, E. A., Hartmans K. J. 1992. *The physics and physiology of storage*. In: *The Potato Crop*, 2nd ed. NEW YORK, USA : Springer. ISBN: 978-94-010-5034-0. https://doi.org/10.1007/978-94-011-2340-2_14

Hardenburg, R. E., Watada, A. E., Yang, C. Y. 1990. *The commercial storage of fruits, vegetables, and florist and nursery stocks*. Agriculture Handbook (Washington), 66 p. Available at: <https://www.ars.usda.gov/ARSUserFiles/oc/np/CommercialStorage/CommercialStorage.pdf>

- Hossain, M. A., Miah, M. M. A. 2009. Post Harvest Losses and Technical Efficiency of Potato Storage Systems in Bangladesh. Available at: http://www.nfpcsp.org/agridrupal/sites/default/files/Ayub-final_Report_CF2.pdf.
- Ilangantileke, S. G., Khatana, V. S., Singh, J. P., Kumar, D. 1997. Improved rustic storage in South Asia. Working Paper (CIP).
- Iritani, W. M. 1981. Growth and preharvest stress and processing quality of potatoes. *American Potato Journal*, vol. 58, no. 1, p. 71-80. <https://doi.org/10.1007/BF02855381>
- Islam, M. A. 1983. Report on Potato Production in Bangladesh. International Potato Course: Production, Storage and Seed Technology. Report of Participants. International Agricultural Center, Wageningen, The Netherlands.
- Kaul, H. N., Sukumaran, N. P. 1984. A potato store run on passive evaporative cooling. Technical Bulletin. Available at: [http://cpri.egranth.ac.in/cgi-bin/koha/opac-detail.pl?biblionumber=19353&query_desc=se%2Cphr%3A%22\(Technical%20bulletin](http://cpri.egranth.ac.in/cgi-bin/koha/opac-detail.pl?biblionumber=19353&query_desc=se%2Cphr%3A%22(Technical%20bulletin).
- Kumlay, A. M., Kaya, C., Olgun, M., Dursun, A., Pehlivan, M., Dizikisa, T. 2002. Comparison of seasonal change of specific gravity, dry matter accumulation and starch content of four potato (*Solanum tuberosum* L.) varieties. *ISHS Acta Horticulturae*, vol. 579, p. 255-258.
- Maldegem, J. P. V. 1999. State of the art techniques for the potato storage. In *Global Conference on Potato*, New Delhi.
- Mareček, J., Ivanišová, E., Frančáková, H., Musilová, J., Krajčovič, T., Mendelová, A. 2016. Evaluation of primary and secondary metabolites in selected varieties of potatoes. *Potravinarstvo*, vol. 10, no. 1, p.145-151. <https://doi.org/10.5219/562>
- Rabbani, M. G., Siddique, M. A., Islam, M. M., Islam, M. S. 2010. The Potato Sector in *Bangladesh: Its Challenges and Opportunities*. Katalyst, Dhaka : Bangladesh, pp. 144.
- Ranganna, S. 1991. Lane and Eynon Method for Total Sugar Determination. Handbook of Analysis and Quality Control for fruit and vegetable products. 2nd ed. New Delhi, India: Tata McGraw-Hill Publishing Company Limited. ISBN: 978-0-07-451851-9.
- Rashid, M. H. 2008. Food security during natural disasters. In Seminar on 'Engineers' Day' organized by the Institution of the Engineers. Bangladesh : Institution of the Engineers.
- Ritenour, M. A. 2003. Postharvest 101: Overview of postharvest biology (presentation). Ft. Pierce, FL, USA : University of Florida, IRREC Indian River Research and Education Center. Available at: http://irrec.ifas.ufl.edu/postharvest/pdfs/past_events/2003_presentations/Postharvest_Biology.pdf
- Shock, C. C., Holmes, Z. A., Stieber, T. D., Eldredge, E. P., Zhang, P. 1993. The effect of timed water stress on quality, total solids and reducing sugar content of potatoes. *American Potato Journal*, vol. 70, no. 3, p. 227-241. <https://doi.org/10.1007/BF02849311>
- Shetty, K., Casada, M., Zhu, H., Thornton, M., Nolte P. 1998. *Fresh-Pack Potatoes. Handling, Packaging and Transportation in Refrigerated Railcars*. Kimberly, USA : University of Idaho, College of Agriculture, Idaho Agricultural Experiment Station. Available at: <http://www.cals.uidaho.edu/edcomm/pdf/BUL/BUL0804.pdf>
- Tsubota, K. 1999. Relation between post-harvest technologies and economic development. In: Nawa, Y. Takagi, H., Noguchi, A., and Tsubota, K. *Post-harvest Technology in Asia. A step forward to stable supply of food products*. JIRCAS International Symposium Series, vol. 7, p. 25-32.

Acknowledgments:

The study was conducted with financial and logistic support from the project, "Improved Potato Storage Facility for Farm Household" supported by SPGR, Bangladesh Agricultural Research Council (BARC).

Contact address:

Md. Fahad Jubayer, Department of Food Technology and Rural Industries, Bangladesh Agricultural University, Mymensingh-2202, Bangladesh. E-mail: fahadbau21@hotmail.com

Md. Burhan Uddin, Department of Food Technology and Rural Industries, Bangladesh Agricultural University, Mymensingh-2202, Bangladesh. E-mail: burhan992003@yahoo.com

Abu Taher Muhammad Ziauddin (A.T.M. Ziauddin), Department of Farm Power and Machinery, Bangladesh Agricultural University, Mymensingh-2202, Bangladesh. E-mail: ziauddin_atm@yahoo.com

COPPER CONTENT IN CEREALS GROWN IN THE MODEL CONDITION

*Luboš Harangozo, Peter Lazor, Miriama Kopernická, Pavol Trebichalský,
Janette Musilová, Július Árvay, Daniel Bajčan*

ABSTRACT

The consumption of cereals in Slovakia but also worldwide is increasing by every year. From 30000 to 50000 tons of mercury circulates through the biosphere that gets into the atmosphere degassing of the earth's crust and world oceans. Trace element as copper is one of the most efficient antioxidants in the body, often referred to as an element of beauty. It acts as a powerful catalyst for many enzymes and vitamins, through which already small amounts affects many activities in the body (strengthens immunity, reduces levels of histamine). It accumulates in the barley, beans, cucumber, nuts or milk and so on. The aim of our work was the evaluation of transfer of mercury from sludge to edible part of chosen cereals. The objectives were achieved in simulated conditions of growing pot experiment. We used agricultural soil from the location of Výčapy – Opatovce for the realization of the experiment. The sludge, which was added at various doses, was taken from Central Spiš area from locality of Rudňany near the village where mined iron ore that contains mainly copper and mercury during last few decades was. We used three types of cereals: barley (*Hordeum sativum* L.) variety PRESTIGE, spring wheat (*Triticum aestivum* L.) variety ISJARISSA and oat (*Avena sativa* L.) variety TATRAN. The length of growing season was 90 days. From the obtained results of two years can be concluded that the accumulation of copper by seed follows barley < oat < wheat. Even though that the barley is characterized by the highest accumulation of copper in the seeds, the content did not exceed the maximum level specified by The Codex Alimentarius of the Slovak Republic (CA SR). The results shows that the suitable cultivation of the cereals in localities, which are contaminated with heavy metals, especially by copper, that the high content of copper in soil do not pose a risk of accumulation of the metal into the cereal grain.

Keywords: heavy metals; cereals; contamination; copper; seeds

INTRODUCTION

Soil pollution by heavy metals is a global environmental problem as it has affected about 235 million hectares of arable land worldwide (Bermudez et al., 2012).

Copper is one of the most common metal contaminants in terrestrial surface ecosystems. It can originate from smelters and from the use of copper fungicides (Helling et al., 2000) or from the use of pig slurry as fertilizer. Copper is rarely the only heavy metal present in contaminated land. Most often, copper contamination occurs in combination with a mixture of other different heavy metals such as zinc, lead and cadmium (Holmstrup et al., 2011).

The continuous use of fungicides has caused copper (Cu) accumulation in soils, which represent a major environmental and toxicological concern. Despite being an important micronutrient, Cu can be a potential toxicant at high concentrations since it may cause morphological, anatomical and physiological changes in plants, decreasing both food productivity and quality (Brunneto et al., 2016).

Copper is a micronutrient necessary for normal plant growth and development; however, its deficiency and redundancy result in some defects in plant metabolism, especially photosynthesis. Plants are evolved to counterattack the adverse effects of copper by developing protective mechanisms, one of which is exclusion of copper ions from the cells by sequestration, which is a kind of isolation Cu from cellular components. The other way is reduction of ion uptake by roots. When the roots are exposed to excess copper, then detoxification strategies such as metal chelation and transport and activation of signal mechanisms, hormones, proteins, and antioxidant system are induced (Salgam et al., 2016).

Excess Cu can affect important physiological processes in plants and cause problems in plant growth and development. Cu taken from the soil must be transported, distributed, and compartmentalized within different tissues and organelles for healthy plant growth and development (Habiba et al., 2015). On the other hand, excessive Cu is characterized by a reduced plant biomass, leaf chlorosis,

inhibited root growth, bronzing, and necrosis. The effect of Cu toxicity is largely on root growth and morphology, which has particular importance for the whole plant. Because water and nutrients enter plants by the roots, any defect or malformation of the roots creates problems for plant growth and development (Marschner, 2011).

Generally, vegetable plants are more sensitive for metal toxicity than crop plants with lower toxicity thresholds (Bo et al., 2015).

The cereals are probably the most important source of food for humans and feed for animals. Consequently, the low level of contamination can affect the health of consumers. Chemical contamination can occur from growing of cereals to their processing and storage (Alldrick, 2012).

The cereals are the most common crops that are grown on arable land of EU. The fifty percent of cereal production in Southern Europe consists of wheat and then barley and maize. Other cereals as oat and rye are grown to a limited amount (Finch et al., 2014).

Cereals contain various types of proteins, including water-soluble albumins, saline-soluble globulins, alcohol-soluble prolamins, and insoluble glutenins. The absolute and relative amounts of these protein types vary considerably among cereals, as do their digestibility and immunogenicity. The prevalence of allergies to cereals is low, although no exact frequencies are known. Most commonly mentioned, and described in this review, are allergies to wheat, maize and rice, of which occupational bakers' asthma has the highest economic impact (Gilissen, Van der Meer and Smulders, 2014).

All cereals are starchy foods and contain protein that does not meet the essential aminoacid balance required by growing infants. They are considered a good source of energy, most B vitamins, and dietary fiber when consumed as whole grains (Serna Saldivar, 2016).

The cereals and cereal products are the main sources of carbohydrates in food for humans and feed for animals. Cereal grains are an important source of energy and nutrients in the form of protein, fat, fiber, minerals and vitamins (Beverly, 2014).

The cereals are as well as the most important source of fructans in our daily diet. Nowadays are hotly discussed and compared a lot of different cereals in the terms of fructans structure. Their degradation during processing of food is considered as a potential health benefit. Recent published data suggest that they may also have a prebiotic effect (Verspreeta et al., 2015).

The cereals and cereal bran obtained a significant position as a functional food. They are a source of carbohydrates (arabinoxylan, beta – glucan), phenolic acids (ferulic acid), flavonoids (anthocyanins), oil (γ -oryzanol), vitamins, carotenoids, folates and sterols. Their physico – chemical properties makes them a necessary ingredient for food fortification. The bran of rice, wheat, oat, barley, millet, rye and corn contain a huge amount of health-promoting ingredients. The anti-atherogenic, anti-hypertensive and hypoglycemic properties were verified. Further, it was found the effect against oxidative stress. They reduce insulin resistance prevent the risk of obesity by inducing the feel of fullness (Patel, 2015).

Recent large-scale epidemiological studies have shown that regular consumption of whole grain cereals can reduce

the risk of heart disease and certain cancers by 30 percent. One of the factors that increase the functionality of foods is the so-called in digestible resistant starch (Duchonová and Šturdík, 2010).

MATERIAL AND METHODOLOGY

The aim of our work was the evaluation of transfer of mercury from sludge to edible part of chosen cereals. The objectives were achieved in simulated conditions of growing pot experiment. We used agricultural soil from the location of Výčapy – Opatovce for the realization of the experiment. The sludge, which was added at various doses, was taken from Central Spiš area from locality of Rudňany near the village where was mined iron ore that contains mainly copper and mercury during last few decades. We used three types of cereals: barley (*Hordeum sativum L.*) variety PRESTIGE, spring wheat (*Triticum aestivum L.*), variety ISJARISSA and oat (*Avena sativa L.*) variety TATRAN. The length of growing season was 90 days.

Before the establishment growing pot experiment we performed all necessary analyses in soil and sludge. We determined soil reaction, content of nitrogen by Kjeldahl method, phosphorus content, potassium and magnesium content by Mehlich II solution. Subsequently, we determined the content of heavy metals in the acid mixture HNO₃ and HCl (decomposition by aqua regia) by AA Swith Varian AA240FS (Australia). For analysis of each element, we used the multi-element standard Sigma Aldrich (Germany).

To every one of all tested pots was weighed 5 kg of soil with 1 kg of silica sand, while the bottom of the container was filled with a small drainage layer of gravel. In each pot was applied the calculated dose of sludge.

Table 1 Variants of the experiments.

variants	
A	soil 100 %
B	soil 90 %, sludge 10%
C	soil 80 %, sludge 20 %
D	soil 70 %, sludge 30 %

Determination of heavy metals (by AAS) on the device VARIAN AA 240FS

By analytical weight were weighted 1 – 2 g samples of dried vegetables. Mineralization of samples was in a mixture of distilled water with concentrated nitric acid in a ratio 1:1. The weighed samples were put into teflon vessels with 5 cm³ of distilled water with 5 cm³ of concentrated nitric acid. Closed vessels with a samples were mineralized by microwave digestion unit MARS X-press (USA).

After mineralization were analyzed samples filtered through quantitative filter paper MUNKTELL (Germany) grade 390.84 g.m⁻² (green) to volumetric flasks (50 cm³).

Flasks were refilled with distilled water to the mark and after that was the determination of heavy metals by VARIAN AA 240FS (Australia) under the conditions:

Table 2 The process of mineralization – time, temperature (total time 55 minutes).

Stage	Power (W)	Power (%)	Initialization Time (min)	Temp. (°C)	Duration time (min)
Initialization	800	90	15	160	0
Mineralization	800	90	0	160	20
Cooling	–	–	–	–	20

Cd – detection limit - 0.001 mg.L⁻¹, sensitivity 0.01 mg.L⁻¹

Pb – detection limit - 0.02 mg.L⁻¹, sensitivity 0.1 mg.L⁻¹

Cu – detection limit - 0.002 mg.L⁻¹, sensitivity 0.03 mg.L⁻¹

Zn – detection limit - 0.006 mg.L⁻¹, sensitivity 0.008 mg.L⁻¹

Co – detection limit - 0.005 mg.L⁻¹, sensitivity 0.05 mg.L⁻¹

Cr – detection limit - 0.003 mg.L⁻¹, sensitivity 0.04 mg.L⁻¹

Ni – detection limit - 0.008 mg.L⁻¹, sensitivity 0.06 mg.L⁻¹

Mn – detection limit - 0.003 mg.L⁻¹, sensitivity 0.02 mg.L⁻¹

Fe – detection limit - 0.005 mg.L⁻¹, sensitivity 0.04 mg.L⁻¹

Analysis determination has not a deviation more than 3%, the gas flow: air: 13.5 L.min⁻¹, acetylene 2.0 L.min⁻¹.

For statistical evaluation of results was used a statistical program STATISTICA 6.0 Cz. The results tested on the level of descriptive statistical evaluation, and overall visual indication of the level factor, variability and deviations were expressed as text. We used T-test at the confidence level $p \leq 0.05$.

Table 3 The contents of heavy metals in the soil (decomposition by aqua regia) and comparison of Slovak decree No. 220/2004 Coll. (mg.kg⁻¹).

	Cd	Pb	Cu	Zn	Cr	Ni
soil	0.70	18.2	18.4	55.6	17.2	30.6
220/2004	0.70	70	60	150	70	50

RESULTS AND DISCUSSION

Soil from the locality of Výčapy – Opatovce has not alkaline soil reaction with medium level of humidity. It is characterized by good content of phosphorus and potassium and a high content of magnesium. The contents of heavy metals do not exceed the limit values (Slovak decree No. 220/2004 Coll.).

Sludge from the locality of Rudňany has a strongly

Table 4 Copper content in the seeds of spring barley variety Prestige in 2014 and 2015 (mg.kg⁻¹) and the comparison of copper content with Codex Alimentaria of the Slovak Republic (CA SR), median $n = 4$.

BARLEY		
variants	2014	2015
A	4.20	4.05
B	5.30	5.70
C	5.45	5.75
D	6.60	5.75
CA SR	10	10

alkaline soil reaction. It is characterized by a very low content of phosphorus and potassium. Mercury content (520 mg.kg⁻¹) does not exceed the maximum permissible amount (Act No. 188/2003 Coll.).

The highest content of copper in the grain of barley during years 2014 and 2015 was in D Variant. Highest content of copper was 6.60 mg.kg⁻¹.

Copper content in seeds of barley in D variant increased 1.5 times in 2014 compared to variant A (soil without the addition of sludge). Increasing amount of sludge that was added into the soil is proportionally reflected in mercury content in seeds of barley.

The content of copper in seeds of barley in all variants was exceeded the maximum levels permitted under Codex Alimentarius of the Slovak Republic.

A statistically significant difference between 2014 and 2015 in copper content in seeds of barley in all variants was not determined.

The highest content of copper in seeds of wheat was in D variant in 2015, where the Cu content in seeds was almost 1.5 times higher than in A variant.

Increasing amount of sludge that was added to the soil is

Table 5 Copper content in seeds of wheat variety Jarissa in 2014 and 2015 (mg.kg⁻¹) and the comparison of copper content with Codex Alimentarius of the Slovak Republic (CA SR), median $n = 4$.

WHEAT		
variants	2014	2015
A	2.50	3.00
B	3.25	4.05
C	3.45	4.10
D	3.60	4.40
CA SR	10	10

Table 6 Copper content in seeds of oat variety Tatran in 2014 and 2015 (mg.kg⁻¹) and the comparison of copper content with Codex Alimentaria of the Slovak Republic (CA SR) median $n = 4$.

OAT		
variants	2014	2015
A	3.50	2.45
B	4.55	4.10
C	4.75	4.50
D	5.40	5.45
CA SR	10	10

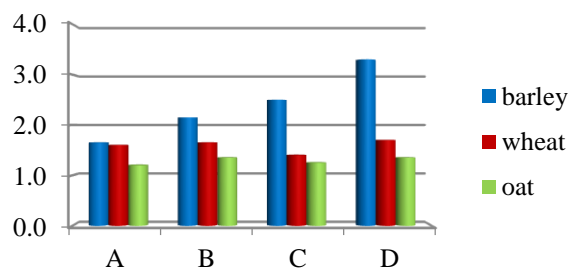

Figure 1 Copper content in aboveground biomass of various cereals in all variants (mg.kg⁻¹) that were grown in 2014.

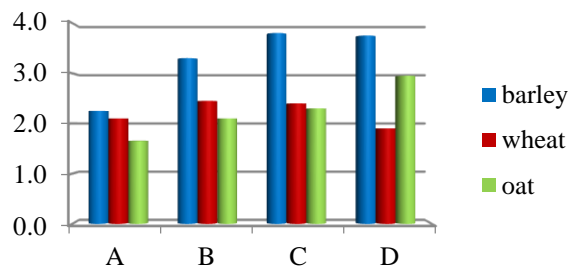

Figure 3 Copper content in aboveground biomass of various cereals in all variants (mg.kg⁻¹) that were grown in 2015.

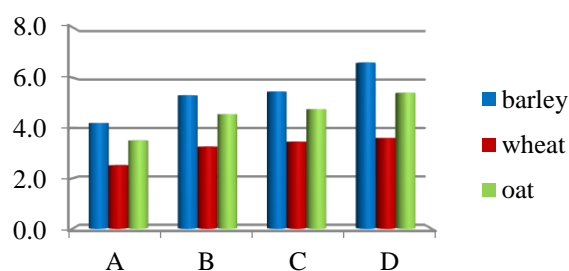

Figure 2 Copper content in seeds of various cereals in all variants (mg.kg⁻¹) that were grown in 2014.

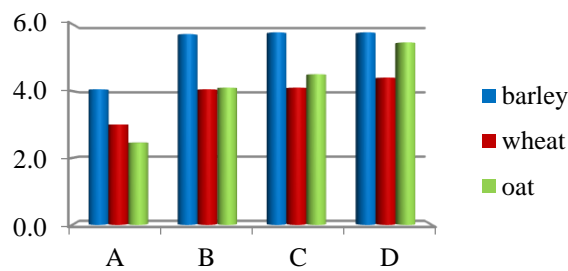

Figure 4 Copper content in seeds of various cereals in all variants (mg.kg⁻¹) that were grown in 2015.

proportionally reflected in mercury content in the seeds of wheat. The difference between the highest copper content in seeds of wheat in D variant compared to years 2014 and 2015 was similar as in the case of barley.

The copper content in seeds of wheat in all variants was not exceeded the maximum levels permitted under Codex Alimentarius of the Slovak Republic.

A statistically significant difference between 2014 and 2015 in copper content in seeds of wheat was determined in all variants.

Copper content in oat seeds in D variant (highest addition of sludge) was 2.2 times higher than in A variant in 2015. Compared to 2014, the content of copper in the seeds was almost identical.

The copper content in seeds oat was exceeded the maximum levels permitted under Codex Alimentarius of the Slovak Republic.

In all variants was not a statistically significant difference of copper content in seeds of oat between harvested biomass in years 2014 and 2015.

The following figures show the comparison of copper content in aboveground biomass and in seeds of commodities in different variants.

Increasing of copper content in different variants in the aboveground biomass was determined only in samples of barley. The highest copper content of aboveground biomass was in barley variety PRESTIGE in D variant with value of 3.3 mg.kg⁻¹. Demirevska-Kepovaa et al. (2004) found the copper content in leaves of barley 20 ± 4.33 mg.kg⁻¹, which compared with our results of five times greater.

Comparing the copper content of individual variants in biomass of oat and wheat was not significant changes. The lowest accumulation of copper in samples was in

aboveground biomass of oat variety TATRAN with value of 1.35 mg.kg⁻¹. The copper content in the biomass of oat was 9.5 ± 0.3 mg.kg⁻¹ in uncontaminated soil (Moustakas et al., 1994).

The copper content in aboveground biomass of cereals in 2014 was in the order barley < wheat < oat.

The graph 2 shows that the copper content of seeds of cereals in B, C and D variants increases with increasing addition of sludge into the soil.

The smallest accumulation of copper by seeds was in spring wheat variety IS JARISSA (2.5 mg.kg⁻¹), which is more than 6 times lower than the value measured Quartacci et al. (2000).

In a D variant was 3.6 mg.kg⁻¹ of copper content, which is almost half of the amount than was accumulated by barley seeds of variety PRESTIGE (6.6 mg.kg⁻¹). Antolín et al. (2005) measured copper content in the seeds of barley 3.5 – 4.3 mg.kg⁻¹, depending on the addition of the sludge into the soil.

Increasing of copper in different variants in aboveground biomass was determined in samples of barley and oat.

The aboveground biomass of wheat was measured the smallest amount of copper accumulated in D variant with value of 1.9 mg.kg⁻¹.

The highest copper content was measured in barley biomass (3.75 mg.kg⁻¹) which is almost two times more than copper content in biomass of wheat.

Comparing the results of copper that was accumulated in aboveground biomass and grains of selected crops in charts, it can be concluded that cereal grains have a higher accumulation of copper as their aboveground biomass.

The copper content in biomass of selected cereals was in 2015 in the order as follows barley < oat < wheat.

In Figure 4 is similar situation as in Figure 2, thus increasing doses of sludge into soil and it is also reflected

by increasing copper content in seeds of all selected varieties of crops.

The copper content in the seeds oat was 2.45mg.kg⁻¹. Reith (2009) measured the copper content in oats 1.1 mg.kg⁻¹, which is half as much as us found quantities.

From the obtained results of two years can be concluded that the accumulation of cooper by seed follows barley < oat < wheat.

Increased copper content in soil of all variants was caused by addition of sludge and had a statistically significant effect on copper content of seeds in all variants of each crop in the level of $p < 0.05$.

The additions of sludge into soil have a statistically significant effect on copper content in biomass of selected varieties of all crops in the level of $p < 0.05$.

CONCLUSION

The results showed that the amount of sludge added in specified amounts into soil increases mercury content in seeds of crops. Although barley was characterized by the highest accumulation of mercury in the seeds. Mercury content was not exceeded the maximum permissible amount permitted under Codex Alimentarius of the SR. From the obtained results in 2014 and 2015 can be concluded that the accumulation of cooper by seeds is in the order barley < oat < wheat. The results showed that the suitable cultivation of the cereals in localities, that are contaminated with heavy metals, especially by cooper with high content of this metal in soil do not pose a risk of accumulation of contaminant in grains. Increasing number of risk metals in soil leads to an increasing content of these metals in crops and subsequently in animal products. This may have adverse effects on people who consume these products.

There are two main reasons why the contamination of the environment with heavy metals causes concern. First, it can reduce the productivity of plants used as human food and animal feed. Second, it affects the quality of agricultural products.

REFERENCES

Alldrick, A. J. 2012. *Chemical Contaminants and Residues in Food*. UK : Campden, BRI, p. 421-446. ISBN: 978-0-85709-058-4. <https://doi.org/10.1533/9780857095794.3.421>

Antolín, M. C., Inmaculada, P., Garcíab, C., Poloc, A., Sánchez-Díaza, M. 2005. Growth, yield and solute content of barley in soils treated with sewage sludge under semiarid Mediterranean conditions. *Field Crops Research*, vol. 94, no. 2-3, p. 224-237. <https://doi.org/10.1016/j.fcr.2005.01.009>

Bermudez, G. M. A., Jasan, R., Plá, R., Pignata, M. L. 2012. Heavy metals and trace elements in atmospheric fall-out: their relationship with topsoil and wheat element composition. *Journal of Hazardous Materials*, no. 213-214, p. 447-456. <https://doi.org/10.1016/j.jhazmat.2012.02.023> PMID:22390956

Beverly, R. L. 2014. Safety of Food and Beverages: Cereals and Derived Products In Motarjemi, Y. (ed.) *Encyclopedia of Food Safety*, vol. 3, p. 309-314. ISBN: 978-0-12-378613-5

Brunetto, G., Bastos De Melo, G. W., Terzano, R., Del Buono, D., Astolfi, S., Tomasi, N., Pii, Y., Mimmo, T., Cesco, S. 2016. Copper accumulation in vineyard soils: Rhizosphere processes and agronomic practices to limit its toxicity. *Chemosphere*, vol. 162, p. 293-307.

<https://doi.org/10.1016/j.chemosphere.2016.07.104> PMID:27513550

Codex Alimentarius of the Slovak Republic (Potravínový kódex SR 2006, Výnox č. 18558/2006-SL [online] s.a. [cit. 2015-09-29] Available at: http://www.svps.sk/legislativa/legislativa_kodex.asp.

Demirevska-Kepovaa, K., Simova-Stoilovaa, L., Stoyanovaa, Z., Hölzerb, R., Fellerb, U. 2004. Biochemical changes in barley plants after excessive supply of copper and manganese. *Environmental and Experimental Botany*, vol. 52, no. 3, p. 253-266. <https://doi.org/10.1016/j.envexpbot.2004.02.004>

Duchoňová, L., Šturdík, E. 2010. Cereals as basis of preventing nutrition agains tobesity. *Potravinárstvo*, vol. 4, no. 4, p. 6-15. <https://dx.doi.org/10.5219/76>

Finch, H. J. S., Samuel, A. M., Lane, G. P. F. 2014. *Lockhart & Wiseman's Crop Husbandry Including Grassland, 13 Cereal*, 9th ed., UK : Woodhead Publishing, p. 287-336. ISBN: 978-1-78242-371-3. <https://doi.org/10.1533/9781782423928.3.287>

Gilissen, L. J. W. J., Van der Meer, I. M., Smulders, M. J. M. 2014. Reducing the incidence of allergy and intolerance to cereals. *Journal of Cereal Science*, vol. 59, no. 3, p. 337-353. <https://doi.org/10.1016/j.jcs.2014.01.005>

Habiba, U., Ali, S., Farid, M., Shakoor, M. B., Rizwan, M., Ibrahim, M., Abbasi, G. H., Hayat, T., Ali, B. 2015. EDTA enhanced plant growth, antioxidant defense system, and phytoextraction of copper by *Brassica napus* L. *Environmental Science and Pollution Research*, vol. 22 no. 2, p. 1534-1544. <https://doi.org/10.1007/s11356-014-3431-5> PMID:25163559

Helling, B., Reinecke, S. A., Reinecke, A. J. 2000. Effects of the fungicide copper oxychloride on the growth and reproduction of *Eisenia fetida* (*Oligochaeta*). *Ecotoxicology and Environmental Safety*, vol. 46, no. 1, p. 108-116. <https://doi.org/10.1006/eesa.1999.1880> PMID:10806001

Holmstrup, M., Sørensen, J. G., Overgaard, J., Bayley, M., Bindsbøl, A. M., Slotsbo, S., Fisker, K. V., Maraldo, K., Waagner, D., Labouriau, R., Asmund, G. 2011. Body metal concentrations and glycogen reserves in earthworms (*Dendrobaena octaedra*) from contaminated and uncontaminated forest soil. *Environmental Pollution*, vol. 159, no. 1, p. 190-197. <https://doi.org/10.1016/j.envpol.2010.09.005> PMID:20870326

Li, B. Liu, J. F., Yang, J. X., Ma, Y. B., Chen, S. B. 2015. Comparison of phytotoxicity of copper and nickel in soils with different chinese plant species. *Journal of Integrative Agriculture*, vol. 14, no. 6, p. 1192-1201. [https://doi.org/10.1016/S2095-3119\(14\)60906-0](https://doi.org/10.1016/S2095-3119(14)60906-0)

Marschner, P. 2011. *Mineral Nutrition of Higher Plants*. 3rd ed. London : Academic Press. p. 672. ISBN 978-0-12-384905-2.

Moustakas, M., Lanaras, T., Symeonidis, L., Karataglis, S. 1994. Grown and some photosynthetic characteristics of field grown *Avena sativa* under copper and lead stress. *Photosynthetica*, vol. 30, no. 3, p. 389-396.

Patel, S. 2015. Cereal bran fortified-functional foods for obesity and diabetes management: Triumphs, hurdles and possibilities. *Journal of Functional Foods*, vol. 14, no. 24, p. 255-269. <https://doi.org/10.1016/j.jff.2015.02.010>

Quartacci, M. F., Pinzino, C., Cristina L. Sgherri, M., Dalla Vecchia, F., Navari-Izzo, F. 2000. Growth in excess copper induces changes in the lipid composition and fluidity of PSII-enriched membranes in wheat. *Physiologia Plantarum*, vol.

108, no. 1, p. 87-93. <https://doi.org/10.1034/j.1399-3054.2000.108001087.x>

Reith, J. W. S. 2009. Copper deficiency in crops in north-east Scotland. *The Journal of Agricultural Science*, vol. 70, no. 1, p. 39-45. <https://doi.org/10.1017/S0021859600017160>

Sağlam, A., Yetişsin, F., Demiralay, M., Terzi, R. 2016. Copper Stress and Responses in Plants. In Parvaiz, A. *Plant Metal Interaction, Emerging Remediation Techniques*. Elsevier. p 21-40. ISBN: 978-0-12-803158-2. <https://doi.org/10.1016/B978-0-12-803158-2.00002-3>

Serna-Saldivar, S. O. 2016. Cereals: Types and Composition. In Caballero, B, Finglas, P. M, Toldrá, F. (ed.) *Encyclopedia of Food and Health*. 1st ed. Academic Press. p. 718-723, ISBN: 978-0-12-384953-3. <https://doi.org/10.1016/B978-0-12-384947-2.00128-8>

Slovak decree No. 188/2003 Coll. *Of Laws about application of sewage sludge and bottom sediments into soil and completing of Law No. 223/2001 Collection of Laws about wastes and changes and completing of some laws as amended of later Acts*.

Slovak decree No. 220/2004 Coll. *On the conservation and use of agricultural land, amending the Act No. 245/2003 Coll. on integrated pollution prevention and control, amending and supplementing of certain acts, as amended*.

Verspreeta, J., Dorneza, E., Endeb, W. V. D., Delcoura, J. A., Courtina, Ch. M. 2015. Cereal grain fructans: Structure, variability and potential health effects. *Trends in Food Science & Technology*, vol. 43, no. 1, p. 32-42. <https://doi.org/10.1016/j.tifs.2015.01.006>

Acknowledgments:

This work was supported by grant KEGA No. 015SPU-4/2016.

Contact address:

Luboš Harangozo, Slovak University of Agriculture, Faculty of Biotechnology and Food Sciences, Department Chemistry, Tr. A. Hlinku 2, 949 76 Nitra Slovakia, E-mail: harangozolubos@gmail.com

Peter Lazor, Slovak University of Agriculture, Faculty of Biotechnology and Food Sciences, Department Chemistry, Tr. A. Hlinku 2, 949 76 Nitra Slovakia, E-mail: peter.lazor@uniag.sk

Miriama Kopernická, Slovak University of Agriculture, Faculty of Biotechnology and Food Sciences, Department Chemistry, Tr. A. Hlinku 2, 949 76 Nitra Slovakia, E-mail: m.kopernicka@gmail.com

Pavol Trebichalský, Slovak University of Agriculture, Faculty of Biotechnology and Food Sciences, Department Chemistry, Tr. A. Hlinku 2, 949 76 Nitra Slovakia, E-mail: palotre@atlas.sk

Janette Musilová, Slovak University of Agriculture, Faculty of Biotechnology and Food Sciences, Department Chemistry, Tr. A. Hlinku 2, 949 76 Nitra Slovakia, E-mail: janette.musilova@uniag.sk

Július Árvay, Slovak University of Agriculture, Faculty of Biotechnology and Food Sciences, Department Chemistry, Tr. A. Hlinku 2, 949 76 Nitra Slovakia, E-mail: julius.arvay@uniag.sk

Daniel Bajčan, Slovak University of Agriculture, Faculty of Biotechnology and Food Sciences, Department Chemistry, Tr. A. Hlinku 2, 949 76 Nitra Slovakia, E-mail: daniel.bajcan@uniag.sk



NUTRITIONAL AND TOXICOLOGICAL COMPOSITION ANALYSIS OF SELECTED CASSAVA PROCESSED PRODUCTS

*Kuda Dewage Supun Charuni Nilangeka Rajapaksha, Madame Arachchige Dulani Somendrika,
Indira Wickramasinghe*

ABSTRACT

Cassava (*Manihot esculanta* Crantz) is an important food source in tropical countries where it can withstand environmentally stressed conditions. Cassava and its processed products have a high demand in both local and export market of Sri Lanka. MU51 cassava variety is one of the more common varieties and boiling is the main consumption pattern of cassava among Sri Lankans. The less utilization of cassava is due to the presence of cyanide which is a toxic substance. This research was designed to analyse the nutritional composition and toxicological (cyanide) content of Cassava MU51 variety and selected processed products of cassava MU51 (boiled, starch, flour, chips, two chips varieties purchased from market) to identify the effect of processing on cassava MU51 variety. Nutritional composition was analysed by AOAC (2012) methods with modifications and cyanide content was determined following picric acid method of spectrophotometric determination. The Flesh of MU51 variety and different processed products of cassava had an average range of moisture content (3.18 – 61.94%), total fat (0.31 – 23.30%), crude fiber (0.94 – 2.15%), protein (1.67 – 3.71%) and carbohydrates (32.68 – 84.20%) and where they varied significantly in between products and the variety MU51, where no significance difference ($p > 0.05$) observed in between MU51 flesh and processed products' ash content where it ranged (1.02 – 1.91%). However, boiled product and MU51 flesh had more similar results in their nutritional composition where they showed no significant difference at any of the nutrient that was analysed. Thus, there could be no significant effect on the nutrient composition of raw cassava once it boiled. Cyanide content of the MU51 flesh and selected products (boiled, starch, flour and chips prepared using MU51 variety), showed wide variation ranging from 4.68 mg.kg⁻¹ to 33.92 mg.kg⁻¹ in dry basis. But except boiled cassava all processed products had cyanide content <10 mg.kg⁻¹, which is the safe level recommended by the Codex Alimentarius Committee of the FAO/WHO. Thus, preparing products such as flour, starch and chips using MU51 variety could be safe for human consumption.

Keywords: Cassava; cyanide; MU51; nutritional composition; toxicological content

INTRODUCTION

Cassava (*Manihot esculanta* Crantz) is long tuberous root crop which is first originated in Brazil and then dispersed to other parts of the world such as Africa, India and South East Asia. Cassava belongs to the family of Euphorbiaceae and cassava root has three distinctive areas as phelloderm (peel), parenchyma and central vascular core in its raw form (Somendrika et al., 2016). World production of Cassava is around of about 160 million tons per year (Lincoln and John, 2009). In Africa and tropical Asia cassava has become established as an important human food source supplying carbohydrates and energy. Over 500million people around the world relies on cassava as a food (Abu et al., 2006). Cassava is the third most important food source after rice and maize and in the tropics, it is a major metabolic source of energy for millions in world (Somendrika et al., 2016).

Cassava can be considered as a solution for the food insecurity problems as it can tolerate drought conditions and grow well. Therefore, it can be grown in highly environmentally stressed areas where most of the other crops cannot grow and yield crops. In Democratic Republic of Congo, processed cassava is a major staple food which may provide more than 60% of the daily energy requirements (Ngudi et al., 2002). Although it grows well in stressed conditions cassava is highly perishable root crop where it can be stored only for 2 to 3 days after harvesting for human consumption (Hahn, 1989; Oyewole and Aibor, 1992). Reasons for high perishability of cassava are physiological deterioration due to mechanical damage during harvesting and handling (Booth, 1976) and secondary deterioration due to microbial spoilage (Booth and Coursey, 1974).

Cyanogenic glucoside is the toxicological factor which present in cassava root and leaves in three different forms as linamarin, acetonehydrin (lotaustralin) and free HCN (Emmanuel et al., 2012). Enzymatic breakdown of linamarin & lotaustralin make them into free cyanide which is toxic for both humans and animals. Under tropical conditions cyanogenic glucoside readily hydrolysed liberating HCN (Udedibie et al., 2008). However, there are some other compounds in cassava such as amygladin which form cyanide as well (Kováčová et al., 2016). Long-term consumption of lower amount of cyanide may cause several health disorders in human such as neuropathy, glucose intolerance and when combined with low iodine intake, goiter (Delange et al., 1994; Harris and Koomson, 2011) as well. According to the FAO/WHO (1991), in order to prevent acute toxicity in human cassava or its derivative products should contain HCN <10 mg.kg⁻¹.

In Sri Lanka most common cassava varieties are CARI 555, MU51 & Kirikawadi (Wickramasinghe et al., 2009) and most popular form of consumption of cassava is domestic consumption in boiled or curry form. In Sri Lanka, cassava has higher harvesting amount than its production (Somendrika et al., 2016) where major limitations to the utilization of cassava are low shelf life of tubers, presence of toxicological factors such as cyanogenes (Nartey, 1968; Rickard, 1985). The estimated annual production of cassava in year 2014 was 302,767 Metric tons (National Accounts of Sri Lanka, 2014). According to Sri Lanka Export Development Board (2013), export value of Cassava was 1.29 US\$ Mn at 2010, Where it was 2.89 US\$ Mn at 2011 showing 124.03% of growth rate (EDB, 2013).

Although *Manihot esculanta* tubers are widely consumed in Sri Lanka for years, there is, to our knowledge, no much available data concerning the nutritional composition and toxicological content of these tubers. The purpose of the study was to determine nutritional composition and cyanide content as a toxicological factor in MU51 variety and its selected processed products (boiled, flour, starch, chips) and to determine if there were any statistical differences in the nutrient content of fresh MU 51 tubers due to its processing method and to determine the variation of toxicological content between fresh MU 51 tubers and its processed conditions: boiled, chips, flour and starch products. This study will cause to increase the industrial uses of cassava in Sri Lanka and will improve its processing patterns to both local and export market at Sri Lanka. Also, it will provide knowledge on the nutritional and toxicological composition of commonly consuming cassava variety of MU51 in Sri Lanka, which will help to ensure better health condition of people who consuming cassava as a major food source.

MATERIALS AND METHODS

Sample collection

Random samples of cassava MU51 raw tuber were selected and collected from market areas of Homagama, Sri Lanka. Collected samples were immediately transported carefully to the laboratory of the Department of Food Science and Technology, University of Sri Jayewardenepura. At the laboratory, the samples were

sealed and packed in airtight containers for further analysis and were stored in refrigerated condition (Temperature 4 °C to 0 °C) until taken to analysis and sample preparations (Maximum duration 2 weeks).

The selected cassava products taken for analysis were 3 samples of cassava Chips, Flour, starch which were popular processed products and boiled cassava which was commonly consumed pattern by Sri Lankan community. Out of three Cassava chips categories, two were market samples which obtained using large scale and small scale industrial processes to closely reflect the way that people consume these products. These market samples were randomly selected from market at Wijerama area.

Rest of the products were prepared using the cassava MU51 which were previously collected and stored at the refrigerated conditions in the laboratory.

Sample preparation

The processing method for every product was mentioned as follows:

Cassava Chips:

The tubers were washed, hand peeled, and trimmed to remove defective parts. Then the tubers were cut into thin slices (about 0.2 cm) and were deep fried using coconut oil. The chips samples were sealed and packed in airtight containers for further analysis.

Cassava Flour:

The tubers were washed, hand peeled, and trimmed to remove defective parts. Then the tubers were cut into thin pieces (about 2 cm x 2cm) and dried in an air convection oven at 40 °C for 24 h. The dried pieces were powdered using a laboratory scale grinder and sifted through a 300 µm sieve. The flour samples were sealed and packed in airtight containers for further analysis.

Cassava Starch:

Fresh tubers were washed, peeled, and grated. These grated tubers were wet milled at low speed in a laboratory scale blender with 1:4 weight/volume of tap water for 2 min(s) and filtered through a gauze cloth. Residue was repeatedly wet milled and filtered for four times and suspension was kept overnight for settling of starch. The supernatant was decanted and the settled residue was collected into a drying tray and was dried at 40 °C for 5h, sifted through a 300 µm sieve, sealed, and packed in airtight containers for analysis.

Boiled cassava:

Fresh tubers were washed, peeled, and cut into cubes (about 5 cm of thickness). The cubes were added to a cooking vessel full of water and cooked until the middle part of the cubes were become soft. The excess water was filtered and boiled cassava was analysed for its moisture content. The rest was chopped and dried in dehydrator at 400 °C for 5 h, sealed and packed in airtight containers for further analysis.

All the prepared samples were stored at room temperature (18 °C – 32 °C), until they were taken into further analysis.

Sample preparation for analysis

The MU51 tubers stored in refrigerator were taken and the peel was removed carefully from the flesh. The flesh of the tubers were ground using mortar and the pestle to decrease the particle size and taken in to analysis. All the other selected products which were stored in airtight containers, were grounded using mortar and pestle and taken into proximate analysis.

Proximate composition analysis of samples

The moisture, crude protein (N x 6.25), fat, ash and crude fibre contents were determined by following AOAC (2012) methods with modification. Every determination of composition values were performed in triplicates. The carbohydrate content was calculated by the difference.

Analysis of moisture %

Moisture content was determined gravimetrically using oven drying method of AOAC (2012) through drying 5 g of the samples in a moisture oven (Model B3535S) until obtained a constant weight at 105 °C.

Analysis of crude protein %

The protein content was determined using AOAC (2012), micro kjeldhal method of nitrogen analysis with VELP scientific F30200120 Kjeldhal digestion kit.

About 0.05 g of each sample was digested with concentrated sulphuric acid using Murcury containing kjeldhal tablet catalyst. The digest was distilled with 32% NaOH and liberated ammonia is collected in to 5 mL of 4% boric acid solution and titrated with 0.02 M HCL acid in the presence of Kjeldhal indicator. The crude protein in the samples was obtained by multiplying the Nitrogen content of the sample from a conversion factor 6.25.

Analysis of ash %

Ash content was determined gravimetrically by using AOAC (2012) method.

About 5 g of each sample was added in to previously weighed porcelain crucible and was incinerated. Then ashing was done in a Muffle furnace (Wisetherm) at 550 °C until it obtained completely white color residue in the crucible.

Analysis of crude fat %

Total fat or crude fat content of each sample was determined by extracting the fat of the dried food material with 6N HCl acid as refer to the AOAC (2012) method.

Analysis of crude fiber %

Crude fiber content was determined using an acid followed by alkaline hydrolysis method as refer to the AOAC (2012) method with modifications.

Approximately 2 g of the dried sample was weighed and defatted by pet ether washing. Wet sample was added into a conical flask and boiled with 200 mL of 1.25% sulphuric acid and 200 mL of 1.25% Sodium hydroxide respectively

and filtered the content through a Buchner funnel in to an ash less filter paper. Then filter paper with the filter bad was dried in the moisture oven (Model B3535S) at 105 °C and ashed at 550 °C.

Carbohydrate content %

Carbohydrate content was calculated with following formula:

Carbohydrate = 100 - (Moisture + ash + protein + fat + crude fiber)

Toxicological composition analysis (Cyanogenic glucoside content) - Spectrophotometric Determination of Cyanide Picric acid method

Cyanide content was determined refer to the methods described by Wood (1965) and Vogels Text Book of Quantitative Inorganic Analysis (1978).

About 20 g of sample was weighed and the initial weight was taken. Then the sample was introduced in to a round bottom distillation flask containing 200 mL of distilled water. About 50 mL of 2N H₂SO₄ was added to the round bottom distillation flask. Immediately the flask was connected to the steam generator and the distillate was collected in 50 mL of 5% Na₂CO₃ solution till it becomes 200 mL. The solution was transferred in to a 250 mL volumetric flask and the volume was made up to the volume.

To the 10.00 mL of the distillate, 4.00 mL of 1% Picric acid was added and it was immersed in a boiling water bath for 12 minutes. Then the solution was let to cool to room temperature and volume was made up to 25 mL. The readings of sample solutions were achieved using a spectrophotometer (UV mini 1240, SHIMADZU, A109347) at 530 nm. The concentration was calculated based on the equation of (Absorbance = - 0.01200 + 0.004680 Concentration), which was been first developed using standard concentration series of KCN solution for the machine UV mini 1240, SHIMADZU, A109347 under the same conditions.

Statistical Analysis

The collected data were analysed using Minitab (17 version) statistical software packages. One way ANOVA used to analyse the significant differences of mean values of each sample, followed by Dunnett multiple comparison test to analyse the samples that had significant difference from control (MU51 flesh) sample. Samples which had significant difference from control sample, was analysed to identify the relationship and regression equation was developed in between the samples which had Pearson correlation > ±0.85. All test procedures were made at 5% significant level. Microsoft Office Excel 2013 package was used to graphical representation of data.

RESULTS AND DISCUSSION

Proximate analysis

Table 1 Nutritional Composition of fresh cassava MU51, market products and processed products (Mean ±SD, n = 3).

Sample	Moisture (%)	Ash Content* (%)	Total Fat Content* (%)	Protein Content* (%)	Crude fiber Content* (%)	Carbohydrate* (%)
MU51 flesh	61.00 ±0.60 ^a	1.37 ±0.06 ^a	0.71 ±0.18 ^a	2.09 ±0.22 ^a	2.15 ±0.43 ^a	32.68 ±1.35 ^a
Boiled ¹	61.94 ±1.61 ^a	1.28 ±0.37 ^a	0.31 ±0.04 ^a	1.67 ±0.15 ^a	1.95 ±0.76 ^a	32.84 ± 2.24 ^a
Flour ¹	12.15 ±0.47	1.09 ±0.04 ^a	0.68 ±0.02 ^a	2.00 ±0.21 ^a	1.10 ±0.49 ^a	82.98 ± 0.14
Starch ¹	11.13 ±0.63	1.14 ±0.08 ^a	0.52 ±0.05 ^a	2.07 ±0.26 ^a	0.94 ±0.42	84.20 ±1.22
Chips ¹	3.65 ±0.03	1.02 ±0.00 ^a	23.30 ± 1.47	3.71 ±0.53	2.02 ±0.26 ^a	66.64 ±1.61
Large scale chips ²	3.18 ±0.12	1.71 ±0.14 ^a	17.05 ±1.69	3.60 ±0.05	1.58 ±0.46 ^a	72.88 ±2.40
Small scale chips ²	5.69 ±0.11	1.91 ±0.65 ^a	20.49 ±1.65	3.52 ±0.21	1.36 ±0.55 ^a	67.03 ±1.25

Note: In each column means not labeled with the letter ‘a’ are significantly different from the control level mean (MU51 flesh) at $p < 0.05$.

¹processed products from MU51 variety and ²products randomly purchased from Market
* values reported in dry weight basis.

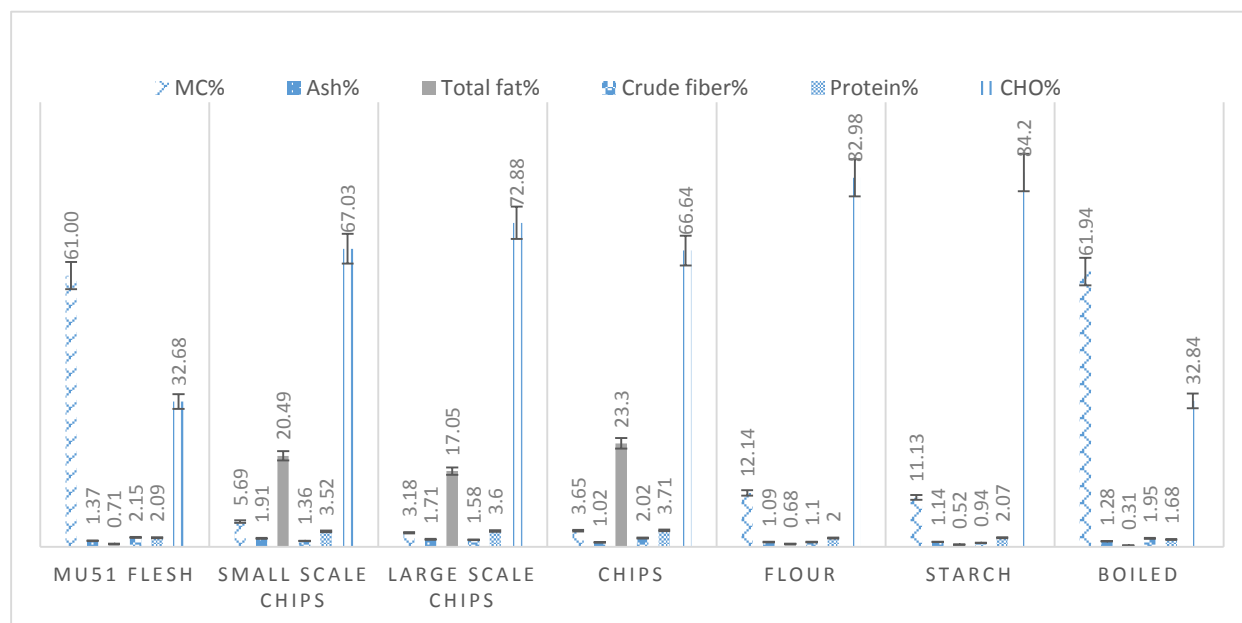

Figure 1 Average proximate composition of MU51 flesh and differently processed products.

The results of proximate composition of MU51 flesh and cassava products (Table 1) showed variations in each nutrient with processing. The nutritional composition of the MU51 flesh and cassava products showed that except ash content all the other nutrients were affected by the processing, where they showed significant differences ($p < 0.05$) with the control sample (MU51 flesh). The variation of nutrients with the processing can be clearly seen with the Figure 1, which it showed what happens to each nutrient when MU51 flesh processed to boiled, chips, and flour and starch forms.

The moisture content of cassava products ranged from 3.18% to 61.94% in which boiled sample had the highest percentage of 61.94 ±1.61%. Flesh of MU51 tuber and

Boiled product were similar in their moisture percentage ($p < 0.05$) where all the other products were less in their moisture percentage compared to the flesh MU51. This results from the processing techniques involved in preparation of products such as drying, frying and grinding. The observed ranges (61.00 ±0.60%) of MU51 flesh was higher, those (33.14% – 45.86%) reported by Emmanuel et al. (2012) on four improved cultivars and two traditional cultivars obtained from Ghana. But the observed moisture percentage of MU51 flesh was much lower compared to the range 75% to 80% which was reported by Oluwole et al. (2004). The variation probably be due to the climatic changes and varietal differences. According to Somendrika et al. (2016) reported moisture



Figure 2 Small scale chips.



Figure 3 Casava flour.



Figure 4 Large scale chips.



Figure 5 Cassava starch.



Figure 6 Cassava MU 51 tubers.

content of Kirikawadi variety flesh ranged $62.92 \pm 1.85\%$ in Sri Lanka which is more similar to the observed range. And also, the observed range comparable to the range of 60.3% to 87.1% reported by **Padonou et al. (2005)** on twenty improved cassava cultivars. As **Chijindu and Boateng (2008)** reported, the moisture percentage of the chips prepared in Ghana had a range of 8.0% to 9.3% which is much higher compared with the observed moisture range of 3.18% to 5.69% for different chips samples. This reduction of observed values, could be as a result of different processing methods that employed. Cassava flour had the moisture content of $12.15 \pm 0.47\%$ which was accordance to the codex standard (13%) for edible cassava flour (**CODEX, 1989**).

Ash content represents the all the inorganic minerals consist within the sample (**Somendrika et al., 2016**). The

observed ranges of all the samples were similar in their ash content ($p < 0.05$) with the control sample (MU51 flesh) which says there's no effect on the ash content due to the processing method. Although there were no significant difference between the samples, the figures of ash content in small scale and large scale chips were $1.91 \pm 0.65\%$ and $1.71 \pm 0.14\%$ respectively where they were higher than the ash content observed with MU51 flesh, $1.37 \pm 0.06\%$. This might due to addition of salt with chips processing because the chips processed in laboratory without addition of salt, showed less ash content ($1.02 \pm 0.00\%$) than in MU51 flesh. MU51 variety had $1.37 \pm 0.06\%$ ash content which is somewhat similar to the ash percentage reported as $1.32 \pm 0.03\%$ for the flesh of Kirikawadi by **Somendrika et al. (2016)**. The varietal difference might cause to the little variation. The observed values of ash content of the flesh

was comparable to the range 0.4% – 1.7% as reported by **Montagnac et al. (2009)**.

Fat can act as an alternative energy source. The total fat content of all the chips samples were high and it ranged from 17.05% to 23.30%, while in all the other samples' total fat content was much lower (0.31% – 0.71%) and significantly different ($p < 0.05$) from all the chips samples. The reason might due to the deep-frying condition involved with the production of chips increase the amount of fat in the cassava chips. Further analysis showed that chips sample had a positive correlation with MU51 flesh with its fat percentage as the Pearson correlation factor was 0.971 ($> \pm 0.85$) in between those two. Therefore, the regression equation was calculated between chips sample & MU51 flesh and it was, (Chips = 17.84 + 7.684 MU51 flesh) with 94.2% R-Sq value.

Large scale and small scale chips had lower ($< \pm 0.85$) Pearson correlation value which showed no relationship of the variation in total fat content with MU51 flesh. As reported by **Somendrika et al. (2016)** fat content of Kirikawadi flesh was 0.41 \pm 0.14% where it was lower than the observed value of 0.71 \pm 0.18% for MU51 flesh. The variation could probably due to the varietal difference and the observed values were taken in dry weight basis where the reported values of **Somendrika et al. (2016)** were taken in wet basis.

The results of the protein content showed that, protein content of MU51 flesh and all the chips samples were significantly difference ($p < 0.05$). This could be when preparing chips, raw cassava flesh get concentrated and dried than that of the other products preparation (Boiled, Flour, Starch). The protein content of MU51 flesh showed a much higher value than that of the reported value of 0.72 \pm 0.09% by **Somendrika et al. (2016)**. The variation could be due to the reported figures were from wet basis and observed figures were from dry basis and also the variation in the soil, variety might also can be reasons. However, the observed value for protein content of MU51 flesh (2.09 \pm 0.22%) comparable with the range (0.3% – 3.5%) reported by **Montagnac et al. (2009)**. Pearson correlation analysis between significant difference variables showed that only MU51 flesh and Large scale chips had a significant positive correlation value of 0.910 ($> \pm 0.85$) followed by derivation of regression equation, (Large scale chips = 3.138 + 0.2224 MU51 flesh) with 82.9% R-Sq value. Except chips samples, Protein content of all the other samples were lower than MU51 flesh probably due to processing conditions that involved with.

However, flour had much lower protein value (2.00 \pm 0.21%) than starch which had 2.07 \pm 0.26% of protein percentage. This may probably due to that in starch making cassava was grated while in making flour it was cut in to pieces. In starch making these grated samples were mixed with water and grinded where the temperature increment was much lower compared to the grinding process in flour making process. Therefore, it could state that, in flour making grinding process might cause to lose some of the protein. In starch making process grinded content was kept for sedimentation where some of the protein could leached out and in the sedimentation process the leached protein would again settled down with starch as it was kept for overnight. The lowest protein value was

Table 2 Cyanide content of flesh of MU51 cassava variety and its processed products.

Sample	Cyanide Content* (mg.kg ⁻¹)
Fresh MU51	33.92
Boiled	15.12
Flour	6.03
Starch	7.05
Chips	4.68

Note: * Values were reported in dry weight basis.

observed in boiled sample (1.67 \pm 0.15%) which might be due to the leaching of protein with cooking of raw cassava. Crude fiber is made up with cellulose and lignin (**Somendrika et al., 2016**) and cause to increase the satiety after consumption. Constipation and colon diseases may result from consumption of lower amount of fiber (**Okon, 1983; Rock, 2007**). Observed crude fiber content of MU51 flesh (2.15 \pm 0.43%) was much similar ($p < 0.05$) to the crude fiber content in all the products that analysed except in starch. Starch had the lowest fiber content where it was 0.94 \pm 0.42%. The reason was in processing starch all most all the fiber was removed before sedimentation. The observed fiber content in MU51 flesh was much higher (2.15 \pm 0.43%) than the reported value of **Gil and Buitrago (2002)**, crude fibre content which does not exceed the limit 1.5%. This might due to the difference in variety and geography. The Pearson correlation analysis between MU51 flesh and starch had much lower value - 0.138 ($< \pm 0.85$) which said there was no correlation between these variables.

The main source of energy in human nutrition is carbohydrates (**Kouřimská et al., 2014**). Except for boiled product, all the other products showed significant difference ($p < 0.05$) with control sample in their carbohydrate content. Lowest carbohydrate content 32.68 \pm 1.35% was observed in MU51 flesh due to the presence of high amount of moisture. Boiled sample also had carbohydrate content of 32.84 \pm 2.24% which was similar to the MU51 flesh and due to same reason. As **Montagnac et al. (2009)** reported carbohydrate in fresh cassava roots had a range from 25.3% to 35.7% and 33.73 \pm 1.69% of carbohydrate content was reported by **Somendrika et al. (2016)**, the both figures were comparable with the carbohydrate content of MU51 flesh and boiled sample. Although MU51 flesh and boiled sample had more similar carbohydrate figures, boiled sample had higher carbohydrate content than in MU51 flesh. That showed boiling could increase the amount of carbohydrate than in raw form. And all the other products were also had high carbohydrate content than in raw form which showed processing techniques could increase the amount of carbohydrate present in final product. Highest carbohydrate content of 84.20 \pm 1.22% showed by starch, because in production of starch it causes to separation of much of the total carbohydrates from other parts of the tuber specially separating fiber part. Three chips samples showed comparable amount in their carbohydrate content which might due to the similarity with their processing method.

Toxicological analysis

The cyanide level observed with each product was mentioned in Table 2. According to that, raw MU51 flesh showed highest cyanide level of 33.92 mg.kg⁻¹ in dry weight basis.

Boiled product showed the low cyanide level of 15.12 mg.kg⁻¹ in dry basis. This might due to the heating which can cause to liberate more free cyanide in its gaseous form (HCN) and according to **Pieris and Jansz (1975)** heating cause to decomposition of the cyanohydrins. The observed cyanide content of boiled product was higher than the cyanide content reported 5.4 – 10.2 mg.kg⁻¹ by **Okolie et al. (2012)** for selected garri samples in Lagos Metropolis. The variation might due to the changes in the processing methods. Chips had lowest cyanide content as 4.68 mg.kg⁻¹ in dry basis, as chips were processed to high temperatures while deep frying the same phenomena could occur as in boiled sample. In chips the extent of heating and temperature increment (about 172 °C) was much higher than boiled product (about 110 °C), and also when making chips cassava tuber was sliced into much thin layers which might cause to increase the linamarin-linamarase reaction and liberate much of the free cyanide available. But in boiling cassava was cut into cubes which might cause to lower the enzyme substrate contact. Thus, chips production could give much lower cyanide content than with boiling. Starch had cyanide content of 7.05 mg.kg⁻¹ in dry basis. This might due to the processing conditions such as grating and overnight sedimentation caused to increase the enzyme substrate contact and enzyme activity which caused to release more bound cyanide (**Pieris and Jansz, 1975**) thus reduce the residual cyanide level in starch. However, the cyanide content in starch was higher than that of the chips because in chips processing conditions were much harsh than starch processing conditions that involved. Flour had second lowest cyanide content 6.03 mg.kg⁻¹ than in fresh MU51. This reduction might due to the processing methods such as drying & grinding that followed in flour preparation (**Jansz et al., 1974**). According to **Pieris and Jansz (1975)** flour can liberate much of its cyanide by moistening because with flour processing steps such as cutting, drying, grinding most of the bound cyanide and linamarase enzyme was not fully destroyed. However, the observed cyanide content of flour was lower than the reported value of 17.5 ± 6.2 mg.kg⁻¹ by **Adindu, Olayemi and Nze-Dike, (2003)**.

CONCLUSION

From this study boiled sample showed more comparable results with the control sample (MU51 flesh) with all the analysed nutritional composition which showed that boiling had no significant effect for the nutritional composition of the raw form. But production of flour, starch and chips had a significant effect on the nutrition composition of the raw cassava (MU51 flesh). And also, production of starch can cause to increase the carbohydrate value and production of chips can increase the food value of protein in raw cassava. The studied cassava products (flour, chips, starch and boiled) had low cyanide levels which were all below the WHO/FAO recommendations (<10 mg.kg⁻¹) and thus could all be safely recommended for consumption without acute toxicity to humans. The

impact of producing chips for the cyanide content were higher. Therefore, chips can be identified as a suitable product for consumption of cassava as much of the problems in raw cassava such as low protein content, presence of cyanide, high perishability and bulkiness can be reduced with chips which it had more protein value and lower cyanide value compare to the raw cassava.

REFERENCES

- Abu, J. O., Muller, K., Daodu, K. G., Minnar, A. 2006. Gamma irradiation of cowpea (*Vigna unguiculata* L. Walp) flours and pastes: Effects on functional, thermal and molecular properties of isolated proteins. *Food Chemistry*, vol. 95, no. 1, p. 138-147. <https://doi.org/10.1016/j.foodchem.2004.12.040>
- Adindu, M. N., Olayemi, F. F., Nze-Dike, O. U. 2003. Cyanogenic potential of some cassava products in Port Harcourt markets in Nigeria. *Journal of Food Composition and Analysis*, vol. 16, no. 1, p. 21-24. [https://doi.org/10.1016/S0889-1575\(02\)00128-X](https://doi.org/10.1016/S0889-1575(02)00128-X)
- Booth, R. H. 1976. Storage of fresh cassava (Manihot esculenta) 1: post-harvest deterioration and its control. *Experimental Agriculture*, vol. 12, no. 2, p. 103-111. <https://doi.org/10.1017/S001447970000716X>
- Booth, R. H., Coursey, D. G. 1974. Storage of cassava roots and related postharvest problems. In: Araullo, E. V., Nestel, B., Campbell, M. (eds) *Cassava processing and storage. Proceedings of an Interdisciplinary Workshop*. IDRC, Ottawa, p. 43-49.
- Chijindu, E. N., Boateng B. A. 2008. Effect of Nutritional Content of Processed Cassava Chips on Development of *Prostephanus truncatus* (Horn). *World Journal of Agricultural Sciences*, vol. 4, no. 3, p. 404-408.
- Codex Standard For Edible Cassava Flour. 1989. Codex Committee on Methods of Analysis and Sampling, Food and Agriculture Organization of the United Nations, p. 176.
- Delange, F., Ekpechi, Louis O., Rosling, H. 1994. Cassava cyanogenesis and iodine deficiency disorders. *Acta Horticulturae (ISHS)*, vol. 375, p. 289-294. <https://doi.org/10.17660/ActaHortic.1994.375.29>
- Emmanuel, O. A., Clement, A., Agnes S. B., Chiwona-Karlton L., Drinah, B. N. 2012. Chemical composition and cyanogenic potential of traditional and high yielding CMD resistant cassava (*Manihot esculenta* Crantz) varieties. *International Food Research Journal*, vol. 19, no. 1, p. 175-181.
- Export development board, Sri Lanka. 2013. Sri Lanka Export Development Board [online] s.a. [cit. 2016-09-15] Available at: <http://www.srilankabusiness.com/>.
- Gil, J. L., Buitrago, A. J. A. 2002. La yuca en la alimentacion animal. In: Ospina B, Ceballos H, editors. *La yuca en el tercer milenio: sistemas modernos de produccion, procesamiento, utilizacion y comercializacion*. Cali. Colombia: CentroInternacional de Agricultura Tropical, p. 527-569.
- Hahn, S. K. 1989. An overview of African traditional cassava processing and utilization. *Outlook on Agriculture*, vol. 18, no. 3, p. 110-111.
- Harris, M. A., Koomson, C. K. 2011. Moisture-Pressure Combination Treatments for Cyanide Reduction in Grated Cassava. *Journal of Food Science*, vol. 76, no. 1, p. T20-T24. <https://doi.org/10.1111/j.1750-3841.2010.01942.x>
- Jansz, E. R., Pieris, N., Jeyaraj, E. E., Abeyratne, D. J. 1974. Cyanogenic glucoside content of manioc: Detoxification of Manioc chips and flour. *Journal of the*

- National Science Council of Sri Lanka, vol. 2, no. 2, p. 129-134.
- Jeffery, G. H., Bassett, J., Mendham, J., Denney, R. C. 1978. Vogel's Text book of quantitative inorganic analysis, 5th ed. Harlow, England : Longman Group UK Limited, p. 345.
- Kouřimská, L., Kubaschová, K., Sus, J., Nový, P., Dvořáková, B., Koudela, M. 2014. Comparison of the carbohydrate content in apples and carrots grown in organic and integrated farming systems. *Potravinárstvo*, vol. 8, no. 1, p. 178-183. <https://dx.doi.org/10.5219/362>
- Kováčová, V., Omelka, R., Šarocká, A., Šranko, P., Adamkovičová, M., Toman, R., Halenár, M., Kolesárová, A., Martiniaková, M. 2016. Histological analysis of femoral bones in rabbits administered by amygdalin. *Potravinárstvo*, vol. 10, no. 1, p. 393-399. <https://doi.org/10.5219/625>
- Lincoln, M. M., John, H. L. 2009. Plant guide: Cassava [online] s.a. [cit. 2016-09-15] Available at: https://plants.usda.gov/plantguide/pdf/cs_maes.pdf.
- Montagnac, J. A., Davis, C. R., Tanumihardjo, S. A. 2009. Nutritional Value of Cassava for use as a Staple Food and Recent Advances for Improvement. *Comprehensive Review in Food Science and Food Safety*, vol. 8, no. 3, p. 181-188. <https://doi.org/10.1111/j.1541-4337.2009.00077.x>
- Nartey, F. 1968. Studies on cassava *Manihot utilisima* Pohl I Cyanogenesis: the biochemistry of linamarin and lotaustrolin in etiolated seedling. *Phytochemistry*, vol. 7, no. 8, p. 1307-1312. [https://doi.org/10.1016/S0031-9422\(00\)85629-0](https://doi.org/10.1016/S0031-9422(00)85629-0)
- Official Methods of Analysis of AOAC International. 2012. 18th ed. USA: Gaithersburg, Md.
- Okolie, I. C., Okparaocha, C. O., Chinweze, C. E., Udedibie, A. B. I. 2012. Physicochemical and hydrogen cyanide content of three processed cassava products used for feeding poultry in Nigeria. *Asian Journal of Animal and Veterinary Advances*, vol. 7, no. 4, p. 334-340. <https://doi.org/10.3923/ajava.2012.334.340>
- Oluwole, O. B., Olatunji, O. O., Odunfa, S. A. 2004. A process technology for conversion of dried cassava chips into garri. *Nigerian Food Journal*. vol. 22, no. 1, p. 65-77.
- Oyewole, O. B., Aibor, A. M. 1992. Fermentation of cassava with cowpea and soyabean for an enriched "ifufu". *Journal of Tropical Science*, vol. 23, p. 9-15.
- Padonou, W., Mestres, C., Nago, M. C. 2005. The quality of boiled cassava roots: instrumental characterization and relationship with physicochemical properties and sensorial properties. *Food Chemistry*, vol. 89, no. 2, p. 261-270. <https://doi.org/10.1016/j.foodchem.2004.02.033>
- Pieris, N., Jansz, E. R. 1975. Cyanogenic glucoside content of manioc: Fate of bound cyanide on processing and cooking. *Journal of the National Science Council of Sri Lanka*, vol. 3, no. 1, p. 41-50.
- Pieris, N., Jansz, E. R. 1976. Cyanide liberation from linamarin: Purification and some properties of the cyanide liberating enzymes of manioc rind. *Journal of the National Science Council of Sri Lanka*, vol. 4, no. 1, p. 29-47.
- Rickard, J. E. 1985. Physiological deterioration in cassava roots. *Journal of the Science of Food and Agriculture*, vol. 36, no. 3, p. 167-176. <https://doi.org/10.1002/jsfa.2740360307>
- Rock, C. L. 2007. Primary dietary prevention: is the fiber story over? *Recent Results in Cancer Research*, vol. 174, p. 171-177. https://doi.org/10.1007/978-3-540-37696-5_14
- Somendrika, M. A. D., Wickramasinghe, I., Wansapala, M. A. J., Peiris S. 2016. Analyzing Proximate Composition of Macro Nutrients of Sri Lankan Cassava Variety "Kirikawadi". *Pakistan Journal of Nutrition*, vol. 15, no. 3, p. 283-287. <https://doi.org/10.3923/pjn.2016.283.287>
- Somendrika, M. A. D., Wickramasinghe, I., Wansapala, M. A. J., Peiris, S. 2016. Quantification of the Material Flow of Raw Cassava Tubers Processing for Export Market. *European Journal of Academic Essays*, vol. 3, no. 3, p. 105-108.
- Udedibie, A. B. I., Enyenihi, G. E., Akpan, M. J., Obasi, O. L., Solomon, I. P. 2008. Physicochemical nature and nutritive value of dried cassava fufu meal for laying hens. *Nigeria Agricultural Journal*, vol. 39, p. 44-49.
- Wickramasinghe, H. A. M., Takigawa, S., Matsuura-Endo, C., Yamauchi, H., Noda, T. 2009. Comparative analysis of starch properties of different root and tuber crops of Sri Lanka. *Food Chemistry*, vol. 112, no. 1, p. 98-103. <https://doi.org/10.1016/j.foodchem.2008.05.046>
- Wood, T. 1965. The cyanogenic glucoside content of cassava and cassava products. *Journal of the Science of Food and Agriculture*, vol. 16, no. 6, p. 300-305. <https://doi.org/10.1002/jsfa.2740160603>

Acknowledgments:

This research was financially supported by the University grant of University of Sri Jayewardenepura, Sri Lanka and it is highly appreciated.

Contact address:

Ms. Kuda Dewage Supun Charuni Nilangeka Rajapaksha, Department of Food Science and Technology, Faculty of Applied Sciences, University of Sri Jayewardenepura, Gangodawila, Nugegoda, Sri Lanka. E-mail: supuz1991@gmail.com

Ms. Madame Arachchige Dulani Somendrika, Lecturer, Department of Food Science and Technology, Faculty of Applied Sciences, University of Sri Jayewardenepura, Gangodawila, Nugegoda, Sri Lanka. E-mail: dsomendrika@sci.sjp.ac.lk

Dr. (Ms.) Indira Wickramasinghe, Senior Lecturer, Department of Food Science and Technology, Faculty of Applied Sciences, University of Sri Jayewardenepura, Gangodawila, Nugegoda, Sri Lanka.

E-mail: indiraw@sjp.ac.lk

QUALITY CHANGES OF LONG-LIFE FOODS DURING THREE-MONTH STORAGE AT DIFFERENT TEMPERATURES

*Zuzana Bubelová, Michaela Černíková, Leona Buňková, Jaroslav Talár,
Václav Zajíček, Pavel Foltín, František Buňka*

ABSTRACT

The aim of this study was to describe quality changes of eight long-life foods (instant potato purée with milk, instant goulash soup, canned white-type cheese, pre-baked baguette, szeged goulash meal-ready-to-eat, canned chicken meat, pork pate and canned tuna fish) during three-month storage at 4 different temperatures (-18 °C, 5 °C, 23 °C and 40 °C). These temperatures were chosen to simulate various climatic conditions in which these foods could be used to ensure the boarding during crisis situations and military operations to provide high level of sustainability. Foods were assessed in terms of microbiological (total number of aerobic and/or facultative anaerobic mesophilic microorganisms, number of aerobic and anaerobic spore-forming microorganisms, number of enterobacteria, number of yeasts and/or moulds), chemical (pH-values, dry matter, fat, crude protein, ammonia and thiobarbituric acid reactive substances contents), texture profile (hardness) and sensory (appearance, consistency, firmness, flavour and off-flavour) analyses. Microbiological analyses showed expected results with the exception of szeged goulash, pork pate and tuna fish, which, although being sterilised products, contained some counts of bacteria. The decrease of pH-values and increase of dry matter, ammonia and thiobarbituric acid reactive substances contents were observed during the storage of all foods due to prolonged storage time and/or elevated storage temperature. Furthermore, according to texture profile analysis, hardness of cheese and baguette rose as a result of both storage temperature and time. Finally, the highest storage temperature (40 °C) resulted in a deterioration of sensory quality (especially flavour) of most foods; the exceptions were pate and tuna fish which retained good sensory quality throughout 3-month storage at all temperatures.

Keywords: long-life foods; long-term storage; quality changes; crisis boarding; combat ration

INTRODUCTION

Minimum shelf-life of foods used in combat rations (CR) of several armies is according to requirements of **STANAG 2937 (2015)** minimally 24 months. CR are developed with an aim to meet complete daily nutrition needs of individuals in environments where standard food cannot be supplied by common means (e.g. in natural disasters, war conflicts, etc.). Energy and nutritional values of CR are in accordance with the needs of members of the army during a long-term strenuous physical activity and comply with the requirements for a basic 24-hour food ration in NATO armies. Foods designed primarily for CR can also be used as a part of emergency relief programmes operated by national and regional authorities. In addition, such foods may be utilized during recreational and sports activities when refrigeration facilities are not available. Foods from Czech CR are suitable for temperate climatic zone (guaranteed 24-month shelf life when stored at temperatures from 0 to 25 °C and relative humidity of up to 70%); however, the army could operate also in arctic

(up to -20 °C) or tropical (over 30 °C) climate zones. Furthermore, temperatures exceeding temperate climate zone can be expected during crisis boarding. Thus, not only ambient, but also frozen and elevated temperature conditions should be considered during the analysis of quality changes of foods intended for CR and crisis boarding.

Various changes leading to the reduction of nutritive value, the decrease of protein/starch digestibility and the worsening of some nutrient bioavailability (essential amino acids, etc.) could be expected during a 2-year storage of food products. Several reactions are responsible for most degradation of basic nutrients such as proteins, lipids, and carbohydrates, but also some minor food components (**Zasyplin and Lee, 2002**). Even sterilized or dehydrated food products are not completely stable and their long-term storage is connected with significant physico-chemical development, especially at elevated temperatures (**Gliguem and Birlouez-Aragon, 2005**). Nutritive deterioration of proteins is mainly due to

nonenzymatic Maillard reactions that leads to amino acid losses, reduced digestibility owing to protein cross-linking, colour changes (darkening), texture toughening, and off-flavour development (Barnett and Kim, 1998; Pizzoferrato et al., 1998; Kristensen et al., 2001). The extent of nonenzymatic browning during storage develops as a result of rising amount of reducing sugars, higher storage temperature, and increased origination of oxidized lipids (Kristensen et al., 2001; Schär and Bosset, 2002; Gaucher et al., 2008). The most important amino acid destructive reactions are Strecker degradation giving rise to ammonia, racemization, and oxidative reactions (Adamiec et al., 2001). Furthermore, some amino acids, especially lysine, could undergo reactions resulting in the formation of bonds that are not cleaved by enzymes in human digestive tract and thus, these amino acids are not bio-available (Ferrer et al., 2000; Torbatinejad et al., 2005). Lipids are subjected to lipolysis, autoxidation, and enzymatic oxidation by lipoxygenases. Lipolysis promotes off-flavour development and changes in functional properties of lipids; lipid oxidation causes rancid off-flavour enhancement, colour and texture changes and nutritional quality deterioration (Nawar, 1998; Kristensen and Skibsted, 1999; Tkáčová et al., 2015). Starch retrogradation, that induces crystallization of amylose and amylopectin together with hydrogen bond formation, is the main reason for texture toughening of starch-containing food products (Gordon and Davis, 1998). Reducing sugars (monosaccharides and disaccharides) are involved in Maillard reactions, as was mentioned above.

The shelf-stability of long-life food products could be improved by e.g. vacuum-packaging with high barrier materials, reformulation of the products, innovative preservation technologies, novel packaging materials, and/or antimicrobial additives (Zasyplin and Lee, 2002).

Physical, chemical and nutritive changes in a variety of selected products should be monitored during at least 2 years of storage at different temperatures to ensure that foods retain good nutritive and sensory quality and meet food safety requirements. Similar studies dealing with long-term storage of such wide range of foods at different temperatures are very scarce. Most of the research works on changes in food products are limited to six-month storage period and/or deal only with two storage temperatures. Other data are derived from accelerated storage tests conducted at elevated temperatures during several days or weeks.

This paper is a kick-off work of 24-month storage study; the complete results will be published subsequently. Moreover, further storage experiments with different types of food will be set promptly. The objective of this work was to determine quality changes (microbiological, chemical, textural and sensory) of various foods during 3-month storage at -18, 5, 23 and 40 °C.

MATERIAL AND METHODOLOGY

Eight types of foods were chosen for the storage experiment: (i) instant potato purée with milk (Natura Inc., Czech Republic); (ii) instant goulash soup (Hügli Food Ltd., Czech Republic); (iii) canned white-type cheese (Mlékárna Polná Ltd., Czech Republic), pre-baked baguette (IBIS Backwarenvertriebs BmbH, Germany); (iv) szeged goulash meal-ready-to-eat (Hamé Ltd., Czech

Republic); (v) canned chicken meat (Hamé Ltd., Czech Republic); (vi) pork pate (Hamé Ltd., Czech Republic); and (vii) canned tuna fish (Gaston Ltd., Czech Republic; country of origin: Spain). The minimum shelf-life of these foods is 2 years, with the exception of purée and soup (1 year), cheese (4 months) and baguette (3 months), which were selected as the representatives of dehydrated, milk and bakery products with the longest shelf-life. Furthermore, one of the goal of this work was to examine the shelf-life of these foods. Potato purée, goulash soup, baguette and szeged goulash were treated according to the instructions for use (i.e. poured with hot water, baked and heated, respectively) before sensory analysis; other foods did not require any preparation.

Storage experiment with 8 types of food was performed in a freezer (-18 °C), refrigerator (5 °C), storeroom (23 °C) and thermostat (40 °C). Generally, all foods were subjected to microbiological (total number of aerobic and/or facultative anaerobic mesophilic microorganisms, number of aerobic and anaerobic spore-forming microorganisms, number of enterobacteria, number of yeasts and/or moulds), chemical (pH-values, dry matter, fat, crude protein, ammonia and thiobarbituric acid reactive substances contents), texture and sensory analyses at the beginning of the experiment and after 3-month storage at 4 temperatures. Furthermore, food products kept at 40 °C were assessed also after 1-month storage. These exceptions were applied during the experiment: (i) number of enterobacteria was determined only in cheese and baguette, (ii) fat and crude protein contents were considered only at the beginning of the experiment, and (iii) texture profile analysis was applied only in cheese, baguette, chicken meat and pate.

Total number of aerobic and/or facultative anaerobic mesophilic microorganisms was determined according to ISO 4833-1:2013, number of aerobic and anaerobic spore-forming microorganisms according to Harrigan (1998), number of enterobacteria according to ISO 4832:2006 and number of yeasts and/or moulds according to ISO 6611:2004.

Values of pH were measured using a pH meter with spear electrode (Eutech Instruments). Dry matter content was provided after evaporating the water content at 103 ± 2 °C until constant mass loss was obtained; see sand was used as a soaking agent if necessary. Fat and crude protein contents were evaluated using Soxhlet and Kjeldahl methods, respectively. Ammonia content was estimated by means of Conway method, as was described by Buňka et al (2004). Thiobarbituric acid reactive substances (TBARS) content was utilized to consider the secondary products of lipid oxidation; method characterised in Kristensen and Skibsted (1999) was used. Wavelength $\lambda = 450$ nm was used for foods providing yellow products (i.e. potato purée, white-type cheese, baguette and szeged goulash), whereas $\lambda = 538$ nm was used for foods giving rise to red products (i.e. goulash soup, chicken meat, pate and tuna fish). The absorption maxima were obtained from the absorbance spectrum (200 – 800 nm). Results were expressed as absorbance units at particular wavelength per mg of sample; i.e. either as A450·mg⁻¹ or A538·mg⁻¹. All of the basic chemical analyses were performed at least in triplicate.

The texture analysis was carried out by means of Texture Analyser TA.XTPlus (Stable Micro Systems). The samples were subjected to double compression by 80% of the initial sample's height using a 100 mm plate (speed of the probe 1 mm.s⁻¹, trigger force of 5 g). The results obtained were recorded as force-displacement/time curves describing the force (N) needed to deform the sample proportionally with time (s). Hardness (maximum force during the first compression cycle; N) was determined according to these curves (Szczesniak, 2002; Weiserová et al., 2011). The measurement was performed at room temperature (21 ± 2 °C) and each sample was analysed three times.

Sensory evaluation was accomplished by a sensory panel consisted of 12 selected assessors trained according to the ISO 8586:2012. A seven-point hedonic scale (1 – excellent, 4 – good, 7 – unacceptable) was used for the assessment of appearance, consistency and flavour, whereas a seven-point intensity scale (1 – negligible, 4 – medium, 7 – excessive) was used for the establishment of firmness and off-flavour intensity. Results were presented as medians.

RESULTS AND DISCUSSION

The results of microbiological analysis of examined food products throughout the 3-month storage showed that the highest counts of microorganisms were detected in two dehydrated instant products, i.e. potato purée and goulash soup (up to 10⁵ CFU.g⁻¹). Cans and the rest of foods contained less microorganisms (maximally 10⁴ CFU.g⁻¹). The only product containing small amounts of yeast and/or moulds was, as expected, white-type cheese. However, surprising results were obtained in monitored cans stored in thermostat. Whereas chicken meat did not involve any microorganisms, pate and tuna fish comprised some counts of total number of aerobic and/or facultative anaerobic mesophilic microorganisms and, furthermore, szeged goulash also some spore-forming microorganisms (up to 10² CFU.g⁻¹). These outcomes indicate germinating of spores which were not inactivated in the sterilisation process.

Results of basic chemical analyses are presented in Table 1 and 2. Values of pH obtained are common values for various food products. pH-values of samples did not show expressive alteration during 3-month storage; however, there was a slight decrease of pH observed in most of the foods owing to growing storage temperature (see Table 1). Dry matter of samples ranged from 20.6 (in tuna fish) to 98.4% (in dehydrated samples – purée and soup). There were only minor changes of dry matter content detected in canned food (chicken meat and tuna fish) during the storage. On the other hand, foods packed in different containers with worse barrier characteristics showed increase of dry matter content through 3-month storage; this growth was more significant at higher temperature. The most intensive changes were noticed in white-type cheese – dry matter of cheese stored for 3 months in thermostat raised about 20% compared to the beginning of the experiment (Table 1). Both fat (Table 1) and crude protein (Table 2) contents analysed in all foods were in accordance with nutrition declaration on packaging.

Ammonia is an important product of various reactions occurring during food storage (e.g. Maillard reactions, Strecker degradation of amino acids, and other deamination reactions) whose high amounts can be considered as food spoilage marker (Friedman, 1996; Efigênia et al., 1997; Pizzoferrato et al., 1998; Adamiec et al., 2001). Ammonia content varied from 14.9 to 161.8 mg.kg⁻¹. Both higher storage temperature and length of storage provoked elevated concentration of ammonia in all food products. These changes were more distinctive in foods with higher protein content. The most expressive ammonia amount growth was registered in goulash soup; sample stored for 3 months in thermostat showed 4 times higher ammonia concentration compared to the beginning of the storage experiment (Table 2). Increasing ammonia contents due to elevated storage temperature (37 °C) were reported for processed cheese by Bubelová et al. (2015).

The primary lipid oxidation products, peroxides, were found to provide little information about the oxidative process in food. Thus, secondary lipid oxidation products (mainly aldehydes) originating from peroxides at later stages of oxidation process are mostly considered as a marker of lipid oxidation intensity (Kristensen et al., 2001). The amount of the secondary products of lipid oxidation was assessed as TBARS. Whereas yellow pigments are formed when secondary lipid oxidation products originate from peroxides of monounsaturated fatty acids, red pigments come from oxidized polyunsaturated lipids (Hoyland and Taylor, 1991). TBARS contents ranged between 6.7 – 477.6 absorbance units per mg of sample. The rise of TBARS was caused by both storage length and higher storage temperature. The highest TBARS levels were detected in samples stored for three months at 40 °C in the case of all products. The greatest rising was noticed in white-type cheese, baguette and pork pate; thermostat samples of these foods after 3-month storage showed 4 – 5 times higher TBARS amounts compared to the beginning of the experiment (Table 2). An increase in TBARS owing to higher storage temperature (37 °C) of processed cheese was noted by Kristensen et al. (2001) and Kristensen and Skibsted (1999).

Results of texture analysis (hardness) are shown in Figure 1. Samples of cheese, unpredictably, hardened very quickly, and, thus, already after 1 month of storage, it was not possible to use 80% compression. Similarly, baguette samples stored for three months in thermostat were not possible to compress by 80%. Therefore 50% compression was employed instead in these samples. Consequently, results obtained with different compressions cannot be compared mutually. Nevertheless, it can be concluded from the available results that both cheese and baguette samples became harder due to both storage length and elevated storage temperature.

On the other hand, chicken meat and pate samples did not alter hardness significantly through the storage. These findings are in good agreement with those for dry matter content (see Table 1). While the dry matter of cheese and baguette increased during the storage, dry matter of chicken meat and pate remained almost constant owing to containers with good barrier efficiency.

Table 1 Results of pH-values, dry matter and fat content during 3-month storage.

Food	Length of storage (months)	Temperature of storage (°C)	pH (-)	Dry matter (%)	Fat content (%)
Potato purée	0	-	6.04 ±0.01	94.81 ±1.09	2.29 ±0.03
	1	40	5.91 ±0.01	95.68 ±1.14	NA
		-18	6.00 ±0.00	96.66 ±1.26	NA
	3	5	5.98 ±0.01	96.52 ±1.18	NA
		23	5.97 ±0.00	96.24 ±1.19	NA
		40	5.90 ±0.00	97.27±1.10	NA
Goulash soup	0	-	5.58 ±0.01	95.51 ±1.18	12.73 ±0.21
	1	40	5.49 ±0.01	95.17 ±1.24	NA
		-18	5.77 ±0.01	98.41 ±1.35	NA
	3	5	5.74 ±0.03	98.40 ±1.29	NA
		23	5.64 ±0.01	98.41 ±1.14	NA
		40	5.39 ±0.01	97.68 ±1.17	NA
Cheese	0	-	5.00 ±0.02	41.04 ±0.91	20.95 ±0.26
	1	40	4.80 ±0.01	55.05 ±0.40	NA
		-18	4.69 ±0.01	46.86 ±0.52	NA
	3	5	4.48 ±0.00	48.17 ±0.24	NA
		23	4.37 ±0.02	55.57 ±0.38	NA
		40	4.30 ±0.00	60.63 ±0.43	NA
Baguette	0	-	5.56 ±0.01	64.57 ±0.53	1.27 ±0.01
	1	40	5.50 ±0.02	70.73 ±0.67	NA
		-18	5.73 ±0.04	67.19 ±0.50	NA
	3	5	5.67 ±0.01	67.16 ±0.47	NA
		23	5.66 ±0.00	67.82 ±0.51	NA
		40	5.51 ±0.01	76.53 ±0.82	NA
Szeged goulash	0	-	4.54 ±0.01	15.82 ±0.39	9.73 ±0.10
	1	40	4.40 ±0.01	17.55 ±0.43	NA
		-18	4.67 ±0.02	16.82 ±0.16	NA
	3	5	4.61 ±0.01	16.07 ±0.26	NA
		23	4.60 ±0.01	17.42 ±0.10	NA
		40	4.59 ±0.01	17.69±0.15	NA
Chicken meat	0	-	6.37 ±0.01	27.09 ±0.30	6.13 ±0.08
	1	40	6.33 ±0.00	27.80 ±0.36	NA
		-18	6.72 ±0.01	24.40 ±0.19	NA
	3	5	6.69 ±0.01	25.82 ±0.34	NA
		23	6.67 ±0.01	26.21 ±0.28	NA
		40	6.68 ±0.02	26.45 ±0.25	NA
Pate	0	-	6.04 ±0.01	43.55 ±0.45	28.14 ±0.37
	1	40	6.05 ±0.00	45.17 ±0.57	NA
		-18	6.14 ±0.02	45.16 ±0.41	NA
	3	5	6.10 ±0.01	45.28 ±0.39	NA
		23	6.08 ±0.00	45.27 ±0.53	NA
		40	6.09 ±0.01	46.68 ±0.37	NA
Tuna fish	0	-	5.72 ±0.01	21.29 ±0.26	1.80 ±0.02
	1	40	5.53 ±0.02	21.16 ±0.22	NA
		-18	6.00 ±0.01	21.42 ±0.19	NA
	3	5	6.00 ±0.01	21.65 ±0.23	NA
		23	5.97 ±0.00	20.89 ±0.37	NA
		40	5.95 ±0.01	20.61 ±0.24	NA

Note: * Results are presented as means ± SD. NA – not analysed.

Hardening of cheese as a consequence of dry matter increase could be most likely attributed to the rearranging of protein matrix (e.g. cross-linking of casein network); these modifications were probably more intense at higher storage temperature (Karami et al., 2009). Concerning the baguette, increased hardness reflects the gluten network

alteration and starch retrogradation. Hardness enhancing of baguette bread during the 45-day storage was noted by Rashidi et al. (2016). Similarly, Sha et al. (2007) observed hardening during the prolonged storage of traditional Chinese steamed bread.

Table 2 Results of crude protein, ammonia and TBARS contents during 3-month storage.

Food	Length of storage (months)	Temperature of storage (°C)	Crude protein (%)	Ammonia (mg·kg ⁻¹)	TBARS (A ₄₅₀ ·mg ⁻¹ or A ₅₃₈ ·mg ⁻¹)
Potato purée	0	-	8.84 ±0.12	38.08 ±0.74	55.67 ± 1.04
	1	40	NA	49.77 ±0.96	90.40 ±2.56
		-18	NA	37.83 ±0.67	60.53 ±1.12
	3	5	NA	38.69 ±0.80	119.53 ±2.45
		23	NA	39.38 ±0.84	121.20 ±2.17
		40	NA	56.21 ±1.02	129.13 ±2.62
Goulash soup	0	-	12.50 ±0.21	39.92 ±0.87	136.20 ±3.08
	1	40	NA	95.20 ±2.73	157.07 ±3.19
		-18	NA	101.43±2.91	143.47 ±3.12
	3	5	NA	128.20 ±3.04	144.28 ±3.20
		23	NA	152.32 ±3.16	154.80 ±3.29
		40	NA	161.84 ±3.63	306.67 ±5.64
Cheese	0	-	15.78 ±0.30	15.23 ±0.28	7.20 ±0.12
	1	40	NA	43.16 ±0.91	18.47 ±0.41
		-18	NA	15.47 ±0.30	23.80 ±0.49
	3	5	NA	20.31 ±0.43	24.53 ±0.53
		23	NA	38.08 ±0.67	28.13 ±0.58
		40	NA	53.31 ±1.12	35.94 ±0.64
Baguette	0	-	7.39 ±0.09	14.97 ±0.24	102.87 ±2.11
	1	40	NA	24.73 ±0.52	311.20 ±5.67
		-18	NA	15.09 ±0.27	245.87 ±4.63
	3	5	NA	16.12 ±0.26	260.81 ±4.85
		23	NA	17.96 ±0.39	321.09 ±5.08
		40	NA	27.93 ±0.57	477.60 ±8.76
Szeged goulash	0	-	4.43 ±0.04	45.70 ±0.96	167.00 ±3.26
	1	40	NA	55.85 ±1.13	241.42 ±4.69
		-18	NA	48.23 ±0.99	208.84 ±4.07
	3	5	NA	50.77 ±1.07	218.39 ±4.23
		23	NA	53.31 ±1.10	236.07 ±4.58
		40	NA	60.93 ±1.27	299.71 ±5.02
Chicken meat	0	-	17.95 ±0.36	71.08 ±1.50	6.73 ±0.13
	1	40	NA	93.93 ±1.76	13.20 ±0.25
		-18	NA	88.85 ±1.52	11.87 ±0.21
	3	5	NA	91.39 ±1.68	12.33 ±0.20
		23	NA	93.20 ±1.71	15.53 ±0.24
		40	NA	106.62 ±1.97	29.81 ±0.63
Pate	0	-	8.66 ±0.13	30.46 ±0.59	28.20 ±0.59
	1	40	NA	53.37 ±1.08	39.73 ±0.78
		-18	NA	40.62 ±0.67	32.53 ±0.65
	3	5	NA	43.16 ±0.52	37.60 ±0.69
		23	NA	45.70 ±0.71	41.72 ±0.74
		40	NA	57.12 ±0.98	61.87 ±1.53
Tuna fish	0	-	22.13 ±0.41	68.54 ±1.40	30.80 ±0.61
	1	40	NA	76.16 ±1.49	56.23 ±1.37
		-18	NA	70.07 ±1.42	31.07 ±0.63
	3	5	NA	72.34 ±1.37	53.33 ±1.27
		23	NA	79.16 ±1.50	56.20 ±1.39
		40	NA	88.63 ±1.62	77.27 ±1.56

* Results are presented as means ± SD. NA – not analysed.

Results of sensory analysis are illustrated in Table 3. Appearance, consistency, flavour and off-flavour intensity were assessed in all foods. Firmness was evaluated only in cheese, baguette, chicken meat, pate and tuna fish. Potato purée worsened its flavour during the storage at the highest temperature; off-flavour was described as rancid and

musty, which was probably caused by the presence of milk powder. Appearance, consistency and flavour were deteriorated through the storage of goulash soup at 40 °C; mainly owing to darkening, disintegrated croutons and unpleasant flavour. White-type cheese maintained its very good/good quality only when stored in a refrigerator.

Table 3 Results of sensory analysis during 3-month storage.

Food	Length of storage (months)	Temp. of storage (°C)	Appearance	Consistency	Firmness	Flavour	Off-flavour
Potato purée	0	-	2	2	NA	2	2
	1	40	2	2	NA	3	2
		-18	2	2	NA	2	2
	3	5	2	2	NA	2	2
		23	2	2	NA	4	4
		40	2	2	NA	6	6
Goulash soup	0	-	2	2	NA	2	1
	1	40	5	5	NA	3	2
		-18	2	2	NA	2	1
	3	5	2	4	NA	2	1
		23	2	4	NA	2	1
		40	5	6	NA	7	7
Cheese	0	-	1	1	4	1	1
	1	40	7	6	6	7	7
		-18	5	7	2	5	5
	3	5	2	2	4	2	2
		23	2	3	6	5	5
		40	7	6	7	7	7
Baguette	0	-	2	2	4	2	1
	1	40	2	3	4	4	2
		-18	4	4	4	4	2
	3	5	4	4	4	4	2
		23	2	3	4	4	3
		40	6	7	6	7	6
Szegeed goulash	0	-	2	2	NA	1	1
	1	40	3	4	NA	5	4
		-18	2	3	NA	1	1
	3	5	2	2	NA	1	1
		23	2	2	NA	1	1
		40	3	3	NA	5	4
Chicken meat	0	-	1	1	4	2	1
	1	40	3	3	4	6	5
		-18	1	1	4	3	2
	3	5	1	1	4	3	2
		23	1	1	4	4	3
		40	3	3	5	6	5
Pate	0	-	3	3	3	3	1
	1	40	4	3	3	3	1
		-18	4	3	3	3	1
	3	5	4	3	3	3	1
		23	4	3	3	3	1
		40	4	3	3	4	2
Tuna fish	0	-	2	2	4	2	1
	1	40	3	3	4	3	2
		-18	2	3	4	2	1
	3	5	2	2	4	2	1
		23	2	2	4	2	1
		40	3	3	4	3	2

* Results are presented as medians. NA – not analysed.

Freezing caused undesirable appearance, consistency and flavour changes; thermostat storage led to unacceptable sensory quality concerning all features. Darkening of cheese stored in thermostat could be referred to Maillard browning (Pizzoferrato et al., 1998; Kristensen et al., 2001). The connection between Maillard reactions and

colour and flavour changes was proven by Gaucheron et al. (1999). Bubelová et al. (2015) observed deteriorating of consistency and flavour of sterilized processed cheese due to high storage temperature (40 °C). Similarly, to white-type cheese, baguette samples stored at 40 °C were described as unacceptable after 3 months.

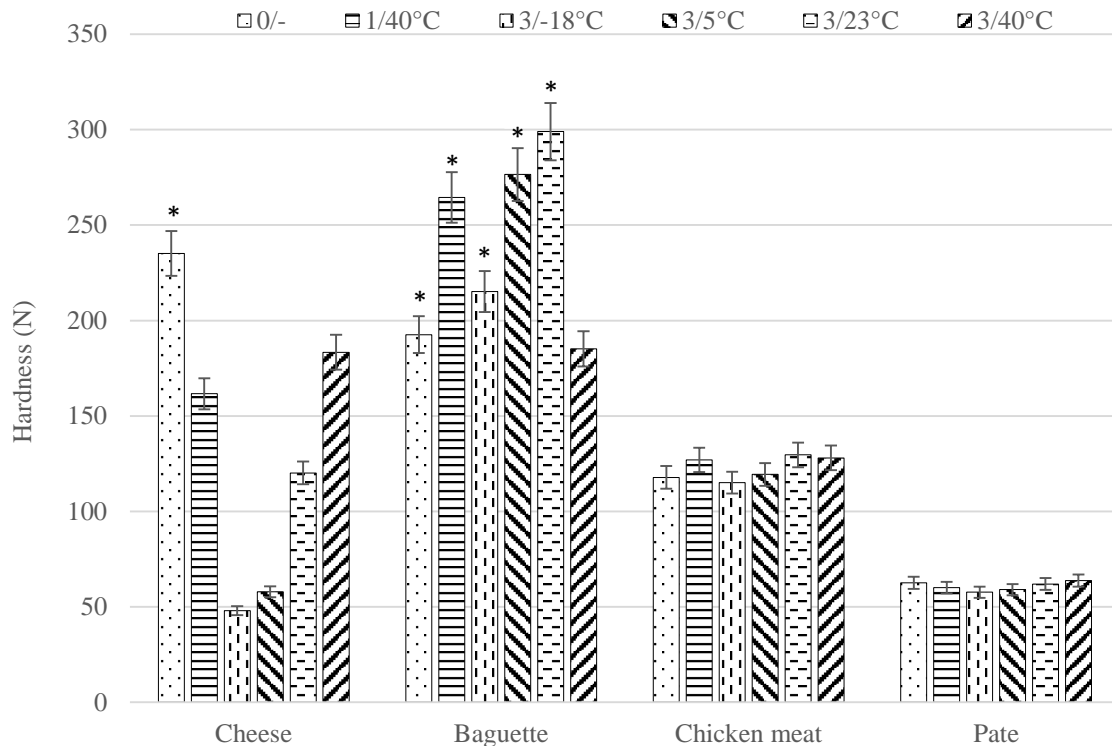

Figure 1 Results of hardness (N) during 3-month storage. Results are presented as means \pm SD. Samples of cheese and baguette marked with asterisk (*) were compressed by 80%, other cheese and baguette samples by 50%.

Rashidi et al. (2016) published aroma and taste reduction through the storage of baguette bread. Ascending firmness of cheese and baguette (especially at 40 °C) correlated well with above mentioned hardness growth established during TPA analysis (see Figure 1). Szeged goulash and chicken meat worsened mainly their flavour when kept in thermostat. Sepúlveda et al. (2003) evaluated the sensory quality of beef-based meal-ready-to-eat during the storage at different temperatures. The authors concluded that elevated storage temperatures (27 and mainly 38 °C) negatively affected flavour and texture properties of beefsteak and beef stew. Worsening of overall sensory quality due to high storage temperature (38 °C) was mentioned also for black bean and rice burrito meal-ready-to-eat (Rodríguez et al., 2003). Finally, pate and tuna fish retained very good or good overall sensory quality throughout 3-month storage at all temperatures. All four lastly mentioned foods (i.e. szeged goulash, chicken meat, pate and tuna) are cans; maintaining of acceptable sensory quality through long-term shelf-life (up to 4 years) could be expected due to sterilization process. However, thermostat storage did not seem suitable for szeged goulash and chicken meat.

CONCLUSION

The effect of four storage temperatures (simulating different climate conditions) on the quality of various types of food with long shelf-life was assessed during three-month storage. Most of the food products did not represent any microbial risk for the potential consumers. However, canned szeged goulash, pork pate and tuna fish, which should be free of microorganisms owing to sterilisation process, contained some counts of bacteria. These microorganisms presumably originated from spores

that germinated during the thermostat storage. The storage in the freezer and in the refrigerator appeared to be the most suitable for most of the foods; products kept at these temperatures for three months maintained usually the best sensory quality and also shown the lowest ammonia and TBARS contents (markers of undesirable protein changes and lipid oxidation, respectively). One of the exceptions was frozen cheese whose appearance and consistency was evaluated negatively compared to samples stored at 5 and 23 °C. By contrast, thermostat storage was not appropriate for majority of the foods. Flavour (and in the case of some food products also appearance and consistency) impaired significantly throughout the 3-month storage at 40 °C and, simultaneously, ammonia and TBARS levels raised markedly. Thus, deamination reactions and oxidation of lipids proceeded more extensively at 40 °C. Based on these findings, it can be recommended to keep the foods at elevated temperature for a maximum period of one month. Finally, ambient storage seemed quite advisable for most of the foods, since the quality of majority foods stored at this temperature was better compared to the thermostat storage. The best sensory quality of all foods examined during the 3-month storage (regardless the storage temperature) was determined in pork pate and tuna fish. Amounts of both ammonia and TBARS did not enhance dramatically in these cans. On the other hand, the most excessive negative changes were detected in instant goulash soup, canned white-type cheese and pre-baked baguette. Current storage experiment is proceeding at the moment and will be evaluated as a whole after 2-year storage. Furthermore, different types of foods with long shelf-life (e.g. porridge, jam, honey, another instant foods and meal-ready-to-eat) will be chosen for additional trial with similar storage conditions.

REFERENCES

- Adamiec, J., Cejpek, K., Rössner, J., Velišek, J. 2001. Novel Strecker degradation products of tyrosine and dihydroxyphenylalanine. *Czech Journal of Food Sciences*, vol. 19, p.13-18.
- Barnett, R. E., Kim, H. J. 1998. Protein instability. In Taub, I. A., Singh, R. P. (Eds.) *Food Storage Stability*. New York, NY : CRC Press, p. 75-88. ISBN: 978-0-8493-2646-2.
- Bubelová, Z., Tremlová, B., Buňková, L., Pospiech, M., Vitová, E., Buňka, F. 2015. The effect of long-term storage on the quality of sterilized processed cheese. *Journal of Food Science and Technology*, vol. 52, no. 8, p. 4985-4993. <http://dx.doi.org/10.1007/s13197-014-1530-4>
- Buňka, F., Hrabě, J., Kráčmar, S. 2004. The effect of sterilisation on amino acid contents in processed cheese. *International Dairy Journal*, vol. 14, no. 9, p. 829-831. <http://dx.doi.org/10.1016/j.idairyj.2004.02.008>
- Efigênia, M., Povoas, B., Moraes-Santos, T. 1997. Effect of heat treatment on the nutritional quality of milk proteins. *International Dairy Journal*, vol. 7, no. 8-9, p. 609-612. [http://dx.doi.org/10.1016/S0958-6946\(97\)00049-6](http://dx.doi.org/10.1016/S0958-6946(97)00049-6)
- Ferrer, E., Alegría, A., Farré, R., Abellán, P., Romero, F. 2000. Effects of thermal processing and storage on available lysine and furfural compounds contents of infant formulas. *Journal of Agricultural and Food Chemistry*, vol. 48, no. 5, p. 1817-1882. <http://dx.doi.org/10.1021/jf9911971>
- Friedman, M. 1996. Food browning and its prevention. *Journal of Agricultural and Food Chemistry*, vol. 44, no. 3, p. 632-653. <http://dx.doi.org/10.1021/jf950394r>
- Gaucher, I., Mollé, D., Gagnaire, V., Gaucheron, F. 2008. Effects of storage temperature on physico-chemical characteristics of semi-skimmed UHT milk. *Food Hydrocolloids*, vol. 22, no. 1, p. 130-143. <http://dx.doi.org/10.1016/j.foodhyd.2007.04.007>
- Gaucheron, F., Mollé, D., Briard, V., Léonil, J. 1999. Identification of low molar mass peptides released during sterilization of milk. *International Dairy Journal*, vol. 9, no. 8, p. 515-521. [http://dx.doi.org/10.1016/S0958-6946\(99\)00121-1](http://dx.doi.org/10.1016/S0958-6946(99)00121-1)
- Gliguem, H., Birlouez-Aragon, I. 2005. Effect of sterilization, packaging, and storage on vitamin C degradation, protein denaturation, and glycation in fortified milks. *Journal of Dairy Science*, vol. 88, no. 3, p. 891-899. [https://doi.org/10.3168/jds.S0022-0302\(05\)72755-7](https://doi.org/10.3168/jds.S0022-0302(05)72755-7)
- Gordon, J., Davis, E. 1998. Biochemical processes: Carbohydrate instability. In Taub, I. A., Singh, R. P. (Eds.) *Food Storage Stability*. New York, NY : CRC Press, p. 105-124. ISBN: 978-0-8493-2646-2.
- Harrigan, W. F. 1998. *Laboratory Methods in Food Microbiology*. 3rd ed. London, UK : Academic Press. 568 p. ISBN-13: 978-0123260437.
- Hoyland, D. V., Taylor, A. J. 1991. A review of the methodology of the 2-thiobarbituric acid test. *Food Chemistry*, vol. 40, no. 3, p. 271-291. [http://dx.doi.org/10.1016/0308-8146\(91\)90112-2/](http://dx.doi.org/10.1016/0308-8146(91)90112-2/)
- ISO 4832:2006. *Microbiology of food and animal feeding stuffs – Horizontal method for the enumeration of coliforms – Colony-count technique*.
- ISO 4833-1:2013. *Microbiology of the food chain – Horizontal method for the enumeration of microorganisms – Part 1: Colony count at 30 degrees C by the pour plate technique*.
- ISO 6611:2004. *Milk and milk products – Enumeration of colony-forming units of yeasts and/or moulds – Colony-count technique at 25 degrees C*.
- ISO 8586:2012. *Sensory analysis – General guidelines for the selection, training and monitoring of selected assessors and expert sensory assessors*.
- Karami, M., Ehsani, M. R., Mousavi, S. M. Rezaei, K., Safari, M. 2009. Changes in the rheological properties of Iranian UF-Feta cheese during ripening. *Food Chemistry*, vol. 112, no. 3, p. 539-544. <http://dx.doi.org/10.1016/j.foodchem.2008.06.003>
- Kristensen, D., Hansen, E., Arndal, A., Appelgren Trinderup, R., Skibsted, L. H. 2001. Influence of light and temperature on the colour and oxidative stability of processed cheese. *International Dairy Journal*, vol. 11, no. 1, p. 837-843. [http://dx.doi.org/10.1016/S0958-6946\(01\)00105-4](http://dx.doi.org/10.1016/S0958-6946(01)00105-4)
- Kristensen, D., Skibsted, L. H. 1999. Comparison of three methods based on electron spin resonance spectrometry for evaluation of oxidative stability of processed cheese. *Journal of Agriculture and Food Chemistry*, vol. 47, no. 8, p. 3099-3104. <http://dx.doi.org/10.1021/jf981396p>
- Nawar, W. W. 1998. Biochemical processes: Lipid instability. In Taub, I. A., Singh, R. P. (Eds.) *Food Storage Stability*. New York, NY: CRC Press, p. 89-104. ISBN: 978-0-8493-2646-2.
- Pizzoferrato, L., Manzi, P., Vivanti, V., Nicoletti, I., Corradini, C., Cogliandro, E. 1998. Maillard reaction in milk-based foods: nutritional consequences. *Journal of Food Protection*, vol. 61, no. 2, p. 235-239. <https://doi.org/10.4315/0362-028X-61.2.235> PMID:9708288
- Rashidi, A., HadiNezhad, M., Rajabzadeh, N., Yarmand, M. S., Nemati, S. 2016. Frozen baguette bread dough II. Textural and sensory characteristics of baked product. *Journal of Cereal Science*, vol. 70, p. 9-15. <https://doi.org/10.1016/j.jcs.2016.05.019>
- Rodríguez, J. J., Olivas, G. I., Sepúlveda, D. R., Warner, H., Clark, S., Barbosa-Cánovas, G. 2003. Shelf-life study of retort pouch black bean and rice burrito combat rations packaged at selected residual gas levels. *Journal of Food Quality*, vol. 26, no. 5, p. 409-424. <http://dx.doi.org/10.1111/j.1745-4557.2003.tb00256.x>
- Schär, W., Bosset, J. O. 2002. Chemical and physico-chemical changes in processed cheese and ready-made fondue during storage. A review. *Lebensmittel-Wissenschaft und Technologie – Food Science and Technology*, vol. 35, no. 1, p. 15-20. <http://dx.doi.org/10.1006/food.2001.0820>
- Sepúlveda, D. R., Olivas, G. I., Rodríguez, J. J., Warner, H., Clark, S., Barbosa-Cánovas, G. 2003. Storage of retort pouch beefsteak and beef stew packed under four headspace levels. *Journal of Food Processing and Preservation*, vol. 27, no. 3, p. 227-242. <http://dx.doi.org/10.1111/j.1745-4549.2003.tb00514.x>
- Sha, K., Qian, P., Wang, L. J., Lu, Z. H., Li, L. T. 2007. Effect of Storage Time on the Physicochemical and Sensory Properties of Man-tou (Chinese Steamed Bread). *International Journal of Food Engineering*, vol. 3, no. 3, p. 1-17. <http://dx.doi.org/10.2202/1556-3758.1217>
- STANAG 2937, Standard NATO, (Ed. 5). 2015. *Requirements of Operational Rations for Military Use*.
- Szczeszniak, A. S. 2002. Texture is a sensory property. *Food Quality and Preference*, vol. 13, no. 4, p. 215-225. [http://dx.doi.org/10.1016/S0950-3293\(01\)00039-8](http://dx.doi.org/10.1016/S0950-3293(01)00039-8)
- Tkáčová, J., Angelovičová, M., Haščík, P., Bobko, M. 2015. Oxidative stability of chicken meat during storage influenced by the feeding of alfalfa meal. *Potravinarstvo*, vol. 9, no. 1, p. 106-111. <http://dx.doi.org/10.5219/444>
- Torbatinejad, N. M., Rutherford, S. M., Moughan, P. J. 2005. Total and reactive lysine contents in selected cereal-

based food products. *Journal of Agricultural and Food Chemistry*, vol. 53, no. 11, p. 4454-4458. <http://dx.doi.org/10.1021/jf050071n>

Weiserová, E., Doudová, L., Galiová, L., Žák, L., Michálek, J., Janiš, R., Buňka, F. 2011. The effect of combinations of sodium phosphates in binary mixtures on selected texture parameters of processed cheese spreads. *International Dairy Journal*, vol. 21, no. 12, p. 979-986. <https://doi.org/10.1016/j.idairyj.2011.06.006>

Zasyplin, D., Lee, T. C. 2002. Storage stability and nutritive value of food for long-term manned space mission. In Welti-Chanes, J., Barbosa-Cánovas, G.V., Aguilera, J.M. (Eds.) *Engineering and Food for the 21st Century*. Boca Raton, FL : CRC Press, p. 979-991. ISBN: 978-1-56676-963-1.

Acknowledgments:

This work was kindly supported by a project of the internal grants of Tomas Bata University in Zlin no. IGA/FT/2016/003 funded from the resources of specific university research and a project of University of Defence in Brno no. DZRO-K109: ROZVOLOG/2016-2020.

Contact address:

Zuzana Bubelová, Tomas Bata University in Zlin, Faculty of Technology, Department of Food Technology,

nam. T. G. Masaryka 5555, 760 01 Zlin, Czech Republic, E-mail: bubelova@ft.utb.cz

Michaela Černíková, Tomas Bata University in Zlin, Faculty of Technology, Department of Food Technology, nam. T. G. Masaryka 5555, 760 01 Zlin, Czech Republic, E-mail: cernikova@ft.utb.cz

Leona Buňková, Tomas Bata University in Zlin, Faculty of Technology, Department of Environmental Protection Engineering, nam. T. G. Masaryka 5555, 760 01 Zlin, Czech Republic, E-mail: bunkova@ft.utb.cz

Jaroslav Talár, University of Defence, Faculty of Military Leadership, Department of Logistics, Kounicova 65, 662 10 Brno, Czech Republic, E-mail: jaroslav.talar@unob.cz

Václav Zajíček, University of Defence, Faculty of Military Leadership, Department of Logistics, Kounicova 65, 662 10 Brno, Czech Republic, E-mail: vaclav.zajicek@unob.cz

Pavel Foltin, University of Defence, Faculty of Military Leadership, Department of Logistics, Kounicova 65, 662 10 Brno, Czech Republic, E-mail: pavel.foltin@unob.cz

František Buňka, Tomas Bata University in Zlin, Faculty of Technology, Department of Food Technology, nam. T. G. Masaryka 5555, 760 01 Zlin, Czech Republic, E-mail: bunka@ft.utb.cz



EVALUATION OF TOTAL POLYPHENOL CONTENT AND ANTIOXIDANT CAPACITY OF DIFFERENT VARIETY LUPIN SEEDS

Ismael Sulaiman Dalaram

ABSTRACT

Legumes, including lupins, beans, lentil and chickpea, are one of the most important crops in the world because of their nutritional quality. Lupin seeds have been used as human food and animal feed since ancient times. It was known that antioxidant photochemical in foods have many health benefits including prevention of various diseases associated with oxidative stress such as cancer, cardiovascular disease, neuro-degeneration and diabetes. Lupin grains are rich sources of complex carbohydrates, protein, vitamins and minerals. Antioxidants can be found naturally in foods. Total polyphenols content and antioxidant activity were measured in four varieties of lupin, namely in white lupin, blue lupin, yellow lupin and Mutabilis lupin species. A majority of antioxidants naturally present in foods occur in phenolic structures and especially in flavonoid structures. The content of the total polyphenols was determined by using the Folin-Ciocalteu reagent (FCR). Antioxidant activity was measured by using a compound DPPH[•] (2,2-diphenyl-1-picrylhydrazyl). In the present experiment according to the average contents of total polyphenols (TPC) in dry matter of lupin seeds there was the following line: *L. Angustifolius* (blue) lupin (696.212 mg GAE.100g⁻¹) > *L. Albus* (white) lupin (614.13 mg GAE.100g⁻¹) > *L. Luteus* (yellow) lupin (467.78 mg GAE.100g⁻¹) > *L. Mutabilis* (pearl) lupin (367.36 mg GAE.100g⁻¹). Based on the measured values of total antioxidant capacity (TAC) of lupin samples can be classified as follows: *L. Albus* (white) lupin (43.44%) > *L. Angustifolius* (blue) lupin (38.27%) > *L. Luteus* (yellow) lupin (22.29%) > *L. Mutabilis* (Pearl) lupin (20.80%). The relationship of antioxidant capacity with total polyphenolic was discussed. According to used statistical analyzes. Correlation between the phenolic contents and antioxidant capacity was significantly positive ($r = 0.88$). Our results confirmed that legumes can be a good source of bioactive compounds in the human nutrition. The main objective of the present work was to evaluate the content of total polyphenols and an antioxidant capacity of four Lupine species.

Keywords: total polyphenols; antioxidant capacity; variety lupine seeds

INTRODUCTION

Legumes used by humans are commonly called food legumes or grain legumes. The food legumes can be divided into two groups, the pulses and the oilseeds. Grain legumes can offer ecosystem services such as renewable N input, the improvement of soil fertility and the diversification of cropping systems, Jensen et al. (2012). Animal proteins being more expensive, especially people in developing countries depend largely on plant to fulfill their protein requirements. Moreover, it is also a good source of minerals (Kirmizi and Guleryuz, 2007). Leguminous seeds present one of the most promising alternative protein sources for the nutritional supplementation and technological improvement of traditional foods (Martinez-Villaluenga et al., 2009). Lupin is a representative of legume family which includes over 450 species are known, from which only four are of agronomic interest Reinhard et al. (2006). *L. Albus* L.: white lupin, *L. Angustifolius* L.: blue or narrow-leafed

lupin, *L. Luteus* L.: yellow lupin and *L. Mutabilis* L.: pearl or Tarrwi lupin (Reinhard et al., 2006; Uzun et al., 2007). The first three species originate from the Mediterranean area, including Turkey, while *L. Mutabilis* belongs to South America (Mulayim et al., 2002). *Lupinus Albus* native to Mediterranean area is agriculturally important (Kirmizi and Guleryuz, 2007). white lupine and spring wheat or spring triticale, was most successful in yield and protein content. Also, harvest dates are as crucial as seeding rates for lupin/cereal forage because time of harvest determines the stage of maturity and therefore, forage quality. Harvesting between 116 – 130 days is recommended (Azo et al., 2012). Lupin seeds have been used as human food and animal feed since ancient times. White lupine can be a phosphorus efficient plant and could help reduce the need for P fertilizer and enhance yields. It forms cluster roots in response to phosphorus starvation (Cheng et al., 2011). The bitter seeds contain the quinolizidine alkaloids lupanine and

sparteine. The presence of these alkaloids limits the use of lupine seed as food and feed. Human consumption of lupines has increased in recent years (Kohajdová et al., 2011). Antioxidants are compounds that protect cells against the damaging effects of reactive oxygen species, such as singlet oxygen, superoxide, peroxy radicals, hydroxyl radicals and peroxynitrite. Reactive oxygen species generated in tissues and cells can damage DNA, proteins, carbohydrates and lipids (Gill and Tuteja, 2010). Lupin is an economically and agriculturally valuable plant (Sujak et al., 2006; Gulewicz et al., 2008). Lupin grains are particularly rich in dietary fibre, as they store beta-galactan rather than oil or starch. Lupin fibre and lupin protein, mostly from blue lupin, are being developed as functional food additives in Australia. In spite of these benefits and in the context of agricultural intensification, the cultivation of legume crops has gone through a long decline in Europe, leading to a dependence on protein imports (Stoddard et al., 2009). Lupin grains are rich sources of complex carbohydrates, protein, vitamins and minerals. A majority of antioxidants naturally present in foods occur in phenolic structures and especially in flavonoid structures. In addition to fiber, legume grains also contain many substances to improve health such as vitamins, minerals, and other substances, including phenolic compounds (Afshin et al., 2014). Phenolic compounds are resistant to oxidation and protect cell damage to prevent the risk of degenerative diseases thanks to antioxidative, anti-inflammatory, antiallergic and anticarcinogenic activities. (Nderitu et al., 2014; Xu et al., 2009). Cholesterol-free legumes in combination with their low sodium content form a good food stuff not only for people living in developing countries but also for those living in industrialized nations (Sebastian et al., 2001). As a protein source, they are obtained cheaply compared to animal protein sources. Moreover; they are fairly good sources of phytochemicals with antioxidant capacity such as polyphenols, mainly tannins and flavonoids (Zielinska et al. 2008; Martinez-Villalunga et al. 2009). White lupine seeds are generally classified as sweet or bitter depending on the alkaloid content, which ranges from 0.01 to 4% (Bhardwaj and Hamama, 2012). It is an interesting grain legume due to its low alkaloid lines and higher protein content (34 – 45 %), similar to that of soybean (Annicchiarico, 2008; Laudadio and Tufarelli, 2011). Lupine is commonly consumed as a snack in the Middle East and is coming into use as a high-protein soy substitute in the other parts of the world (Kurzbaum et al., 2008). Moreover, white lupine has a higher level of essential amino acids and important dietary minerals (iron and potassium) compared with other rainfed legumes such as pea, faba bean and narrow leafed lupine (*L. Angustifolius* L.), which are useful as innovative ingredients of functional or healthy food products (Annicchiarico et al., 2014; Chiofalo et al., 2012). *Lupinus Mutabilis* is currently under development in Western Australia due to its high protein and oil contents (Clements et al., 2008). Lupin-derived protein ingredients have to provide both adequate nutritional and useful technological functionality to the foods in which they are incorporated in order to meet the needs of consumers and the food industry (Zraly et al., 2008). Lupin is a good source of nutrients, not only proteins but lipids, dietary

fibre, minerals and vitamins (Martínez-Villaluenga et al., 2006). However, although lupin seed is one of the legumes with the lowest levels of non-nutritional compounds (trypsin inhibitors, phytic acid, saponins and lectins) Martínez-Villaluenga et al. (2006), it contains large amounts of α -galactosides (7 – 15%) that are associated with negative physiological functions when consumed in high amounts, as recently reviewed by Martínez-Villaluenga et al. (2008). In contrast to other leguminous plants such as peas, soy beans, *Lupinus Albus* contain extremely low amounts of trypsin inhibitors, lectins, isoflavones, saponins and cyanogens (Joray et al., 2007, Zralý et al., 2007). Lupin have traditionally been used for animal feed but are gaining recognition as a health food for humans, due to their unique dietary composition. Total phenolics and antioxidant activities of grains and germinated grains have been widely investigated. Germination produced high phenolic content and consequently increased the antioxidant activities of lupine seeds. Legumes have been shown to help manage both cholesterol and blood glucose (Bazzano et al., 2011; Sevenpiper et al., 2009). Increased intakes are linked to the prevention of heart disease, diabetes and some cancers (Bazzano et al., 2001; Hwang et al., 2009). It is found that phytochemicals from legumes may be responsible effects (Campost-Vega et al., 2010). The interest in natural antioxidants has increased considerably in recent years because of their beneficial effects of prevention and risk reduction in several diseases. Due to low glycemic index of lupin seeds, it was found that lupin kernel fibres have appetite suppression (Archer et al., 2004) and cholesterol lowering properties, that they lower blood glucose and insulin levels (Hall et al., 2005). The profiles and quantities of polyphenols and tannins in legumes are affected by processing due to their highly reactive tances, which are considered to be natural antioxidants (Rybarczyk and Amarowicz, 2007; Dueñas et al., 2009) nature, which may affect their anti-oxidant activity and the nutritional value of foods (Dlamini et al., 2009). The quantitative determination of phenolic compound content as well as their antioxidant capacity may provide valuable information in considering health-promoting properties of lupin seeds. Lupin does not contain gluten, thus it is sometimes used as a functional ingredient in gluten free foods (Scarafoni et al., 2009). There is potential risk of lupine allergy appear (Zielinska et al., 2008). But some dietary fiber constituents such as inulin are also believed to improve minerals absorption, for example to enhance uptake of calcium by altering the pH value in the colon (Chawla and Patil, 2010). A new research has shown that the choice of carbohydrate consumed, not just the amount, also has an impact on blood glucose levels (McGonigal and Kapustin, 2008). Moreover, there are data suggesting that consuming a high fibre diet (50 g fibre.day⁻¹) reduces glycemia in subjects with type 1 diabetes and glycemia, hyperinsulinemia, and lipemia in subjects with type 2 diabetes (American Diabetes Association, 2008). The phenolic content and composition of *L. Angustifolius*, despite its weak antioxidant capacity, may have positive implications for reducing the risk of cardiovascular disease due to its protective effects on blood vessel health (Oomah et al., 2006). Moreover, lupin seeds also contain constituents that alter satiety and other features of human

health with the prospect of pharmaceutical potential (Lee et al., 2006; Duranti et al., 2008). In general, the human body has its own natural antioxidant system to stand against free radicals using certain enzymes. Antioxidants can be found naturally in foods (Kedare and Singh, 2011). A majority of antioxidants naturally present in foods occur in phenolic structures and especially in flavonoid structures. Sweet lupins, such as those grown in Western Australia, have low levels of alkaloids (Australia New Zealand food authority, 2001). In comparison with the bitter one, sweet *Lupinus Albus* has lesser amount of anti-nutritional factors, particularly quinolizidine alkaloids (Zralý et al., 2007). These sweet varieties have been obtained through breeding programmes. These varieties have advantages of having low alkaloid content but they are also less resistant to disease and herbivore attack (Sanchez et al., 2004).

MATERIAL AND METHODOLOGY

Material: Lupin Samples were collected from the market, but information such as the variety, were not mentioned, four species of lupin seeds (*L. Albus* (white), *L. Angustifolius* (blue), *L. Luteus* (yellow), *L. Mutabilis* (pearl)) were purchased.

Chemicals and reagents: Folin-Ciocalteu reagent, 2,2-diphenyl-1-picrylhydrazyl (DPPH), Sodium carbonate (Na_2CO_3), Methanol(CH_3OH).

Extraction: For 12 hours extraction, dry material (5 g) was used and continuously extracted by a Twisselmann extractor with methanol (80%, v/v).

Determination of total polyphenols

Total polyphenols were determined by the method of Lachman et al. (2003) and expressed as mg of gallic acid equivalent per 100 g dry mater. Gallic acid is usually used as a standard unit for phenolics content determination because a wide spectrum of phenolic compounds. The total polyphenol content was estimated using Folin-Ciocalteu assay, Folin-Ciocalteu reagent was added to the extract solutions. After 4 min, 5 mL of Na_2CO_3 (20%) was added, the volume was adjusted to 50 mL by adding distilled water and the mixture was stored at room temperature for 2 h, the absorbance values was measured at 765 nm of wavelength against methanol blank on the spectrophotometer Shimadzu 710 (Japan). The concentration of polyphenols was calculated from a standard curve plotted with known concentration of gallic acid.

Determination of antioxidant activity

Antioxidant activity was measured by the Brand et al. (1995) method-using a compound DPPH[•] (2,2-diphenyl-1-picrylhydrazyl). 2,2-diphenyl-1-picrylhydrazyl (DPPH[•]) was pipetted to cuvette (3.9 cm³) then the value of absorbance, which corresponded to the initial concentration of DPPH[•] solution in time A_0 was written. Then 0.1 cm of the lupin extracted was added. Solution in the cuvette was mixed and then was immediately started to measure the dependence $A = f(t)$. The absorbance after 10 minutes was measured at 515 nm in the spectrophotometer Shimadzu UV/VIS-1240 was mixed and measured. The percentage of inhibition

reflects how antioxidant compound are able to remove DPPH[•] radical at the given time.

$$\text{Inhibition (\%)} = (A_0 - A_t / A_0) \times 100$$

Statistical analysis

Results were statistically evaluated by the Analysis of Variance. All the assays were carried out in triplicates and results are expressed as mean \pm SD. The data were subjected to the F-test in the one-way analysis of variance (ANOVA) If the p-value of the F-test is less than 0.05, there is a statistically significant difference between the means at the 95% confidence level; the Multiple Range Tests will tell which means are significantly different from which others. The method currently being used to discriminate among the means of Fisher's least significant difference (LSD) procedure. Analysis was conducted using SAS software 9.4.

RESULTS AND DISCUSSION

On the base of reached results there were estimated changes in the total polyphenols content and also changes in total antioxidant capacity values in dependence on varieties of lupin seeds.

Evaluation of total polyphenol content and values of antioxidant capacity in lupin Species

Phenols are compounds that have the ability to destroy radicals because they contain hydroxyl groups. These important plant components give up hydrogen atoms from their hydroxyl groups to radicals and form stable phenoxyl radicals; hence, they play an important role in antioxidant activity. Therefore, determination of the quantity of phenolic compounds is very important in order to determine the antioxidant capacity of plant extracts (Das and Pereira, 1990). Following the total polyphenol content parameter in lupin species (*L. Albus* L.: white lupin, *L. Angustifolius* L.: blue or narrow-leaved lupin, *L. Luteus* L.: yellow lupin and *L. Mutabilis* L.: pearl or Tarrwi lupin). (Table 1 and Table 2; Figure 1 and Figure 2). According to the obtained results, the polyphenols content (TPC) in the tested was significantly different, and varied with the species, it was detected, that polyphenols content in samples ranges from 367.36 \pm 35.95 mg GAE.100g⁻¹ (in species *L. Mutabilis*) to 696.212 \pm 24.44 mg GAE.100g⁻¹ (in species *L. Angustifolius*). Statistically significant highest value of total polyphenols was recorded in species (*L. Angustifolius*). Statistically significant the lowest content of total polyphenols was recorded in species (*L. Mutabilis*). According to the average contents of total polyphenols in dry matter of lupin there is the following line in present work: *L. Angustifolius* (blue) lupin (696.212 mg GAE.100g⁻¹) > *L. Albus* (white) lupin (614.13 mg GAE.100g⁻¹) > *L. Luteus* (yellow) lupin (467.78 mg GAE.100g⁻¹) > *L. Mutabilis* (pearl) lupin (367.36 mg GAE.100g⁻¹). As shown in (Table 2; Figure 2.), there were statistically significance differences in total polyphenol (TPC) content within lupin species. (Wang and Clements, 2008) were found the highest value of total phenolic content in variety *L. Mutabilis* P28725 (2660.4 mg GAE.100g⁻¹) and the two varieties of

Table 1 Total phenolic content and antioxidant capacity (mean and standard deviation values). In chosen species of lupin.

Species	Colors	TAC %	TPC (mg GAE.100g ⁻¹)
<i>L. Albus</i>	white	43.4363 ±1.05 a	614.13 ±50.40 a
<i>L. Angustifolius</i>	blue	38.2685 ±0.74 b	696.212 ±24.44 b
<i>L. Luteus</i>	yellow	22.2919 ±55.30c	467.78 ±60.26 c
<i>L. Mutabilis</i>	pearl	20.7950 ±0.24 d	367.36 ±35.95 d

Note: Data expressed as means of six replications ±standard deviation. Values in the same column with different letters present significant differences $p < 0.05$ using F-test for independent samples.

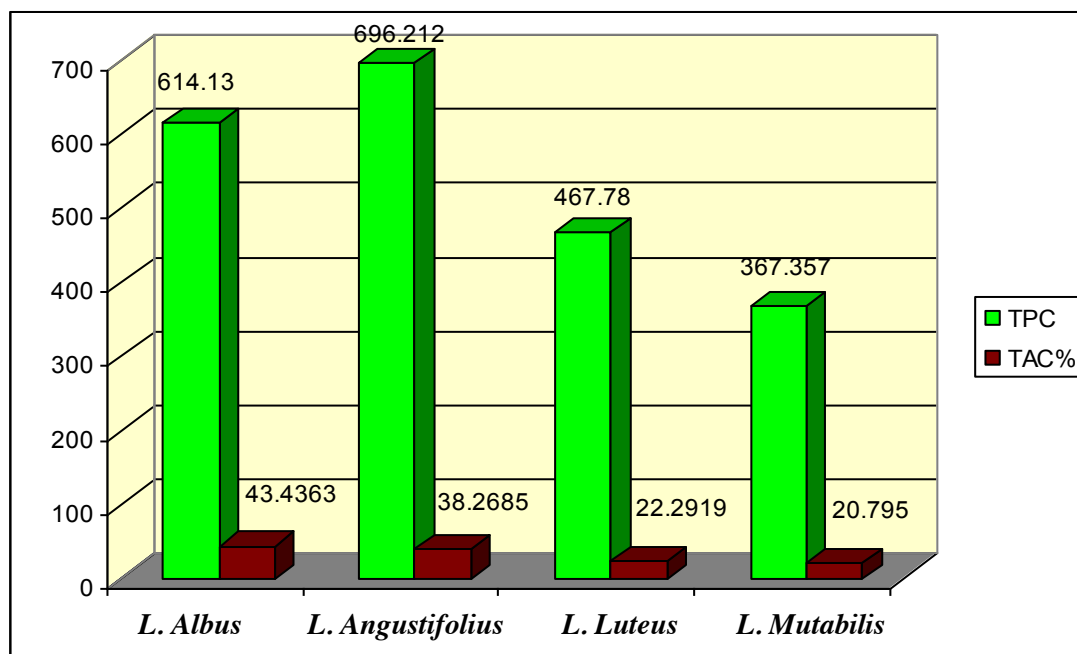

Figure 1 Average content of total polyphenols TPC (mg GAE.100g⁻¹) and Average content of total antioxidant capacity TAC (%) in chosen four species of lupin seeds.

L. Luteus were contained the lowest total phenolic (369.2, 374.4 mg GAE.100g⁻¹). In *L. Albus*. Etho 66, was 1661.2 mg GAE.100g⁻¹, in Andromeda variety was 451.6 mg GAE.100g⁻¹, in unknown variety name was 444.4 mg GAE.100g⁻¹. In comparison to determined values of polyphenols their results were lower value than present result in *L. Albus* with (614.13 mg GAE.100g⁻¹) with exception Etho 66 variety with 1661.2 mg GAE.100g⁻¹. Also the polyphenols content in *L. Angustifolius* in present result with the value (696.212 mg GAE.100g⁻¹) higher than their results with (553.4, 578.4, 578.0, 535.1 mg GAE.100g⁻¹). Our result in *L. Luteus* with (467.78 mg GAE.100g⁻¹) higher than their results with (374.4, 369.2 mg GAE.100g⁻¹), but in *L. Mutabilis* their results with (799.1, 2660.4 mg GAE.100g⁻¹) were higher than present result with (367.36 mg GAE.100g⁻¹). **Siger et al. (2012)**, reported the highest values of total polyphenols in *L. Luteus*, Parys Cultivar with (317.88 ±2.69 mg GAE.100g⁻¹ d.m), followed by *L. Albus*, Boros Cultivar with (271.25 ±3.75 mg GAE.100g⁻¹ d.m) and *L. Angustifolius* Bojar Cultivar with (269.72 ±9.97mg GAE.100g⁻¹ d.m). When we comperesen present result, in *L. Luteus*

unknown Cultivar with (467.78 mg GAE.100g⁻¹ d.m) in *L. Albus* with (614.13 ±50.40 mg GAE.100g⁻¹ d.m), in *L. Angustifolius* with (696.212 ±24.44 mg GAE.100g⁻¹ d.m) their results were lower value of phenolic contents than the present result and present result higher value phenolic contents than the result of **Wang and Clements (2008)**, in both Cultivar of *L. latus* with (374.4 mg CAE.100g⁻¹, 369.2 mg CAE.100g⁻¹). **Ahmed (2014)** determined the content of total polyphenols in lupine flour with [(138.17 ±8.35 µg GAE.g⁻¹ d.w) which equal to 1381.7 ±8.35 mg CAE.100g⁻¹]. Also **Walaa et al. (2015)** determined the content of total polyphenols in lupine flour with [(136 ±8.33 µg GAE.g⁻¹ d.w) which equal to 1360 ±8.33 mg CAE.100g⁻¹]. In comparison to our determined values of total polyphenols their results were higher than our results value of polyphenols content in all species of lupin seeds in present result. **Gamal and Ismail (2013)** determined the content of total polyphenols in Lupinustermis seeds with [(14.23 ±1.38 µg GAE.g⁻¹ d.m) which equal to 142.3 ±8.35 mg CAE.100g⁻¹], their result was lower than present results.

Table 2 Total phenolic content and antioxidant capacity (mean and standard deviation values with the group). In chosen four species of lupin seeds.

species	TAC%			TPC (mg GAE.100g ⁻¹)		
	Mean	Std dev	Group	Mean	Std dev	Group
<i>L. Albus</i>	43.44	1.05	a	614.13	50.40	a
<i>L. Angustifolius</i>	38.27	0.74	b	696.21	24.44	b
<i>L. Luteus</i>	22.29	0.55	c	476.78	60.26	c
<i>L. Mutabilis</i>	20.80	0.24	d	367.36	35.95	d

Note: All the assays were carried out in triplicates and results are expressed as mean ±SD. The data were subjected to one-way analysis of variance (ANOVA) and the differences between various concentrations were determined Fisher LSD test using SAS software.

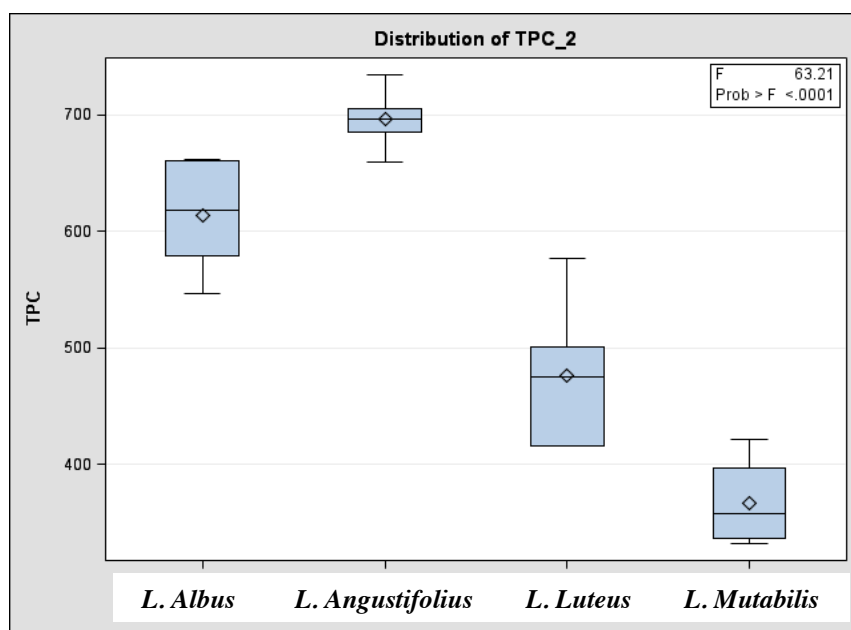
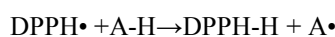

Figure 2 Box-plot of the content of total polyphenols TPC (mg GAE.100g⁻¹) in four species of lupin.

Statistical evaluation of antioxidant capacity(TAC) differences significance within the frame of chosen species

Another indicator that has been evaluated and compared was the changes in total antioxidant capacity values in lupin seeds. This method is based on decreased absorbance of DPPH radical read at 515 nm, due to the action of antioxidants. A 0.1 mL volume of the sample was added to 3.9 mL of DPPH• dissolved in methanolic solution and carefully homogenized. Free radical was freshly prepared before each assay while protected from light. The DPPH method is a preferred method because it is fast, easy and reliable and does not require a special reaction and device. The free radical scavenging activities of extracts depend on the ability of antioxidant compounds to lose hydrogen and the structural conformation of these components (Shimada et al., 1992). The DPPH free radical, which is at its maximum wavelength at 517 nm, can easily receive an electron or hydrogen from antioxidant molecules to become a stable diamagnetic molecule (Soares et al., 1997). Owing to the DPPH radical's ability to bind H, it is considered to have a radical scavenging property. A solution of DPPH radicals prepared in methanol is converted into DPPH-H (diphenylhydrazine) molecules in the presence of an

antioxidant agent, as shown in the following equation. Discoloration occurs due to the decreasing quantity of DPPH radicals in the environment. The discoloration of the DPPH therefore reflects the radical scavenging activity of the analyzed extract (Guo et al., 2007). The method is based on the reduction of alcoholic DPPH• solutions in the presence of a hydrogen donating antioxidant (AH) to the non radical form DPPH-H.



In the present work as shown in (Table 1, 2; Figure 1, 3), it was found that, antioxidant capacity in samples ranges from 20.795% to 43.4363%. Statistically the highest value of antioxidant capacity (43.4363%) was recorded in *L. Albus* species (white color). The lowest value of antioxidant capacity (20.795%) was recorded in *L. Mutabilis* species (pearl color). In the case of *L. Angustifolius* (blue color) was (38.2685%), and (22.2919%) for Luteus species (yellow color). Ahmed (2014) published that the value of antioxidant capacity in lupine flour was (20.26 ±1.22). Gamal and Ismail (2013) determined that antioxidant activity by DPPH (Inhibition %) was (19.21 ±0.345%) in lupin seeds, (*Lupinus termis* L.).

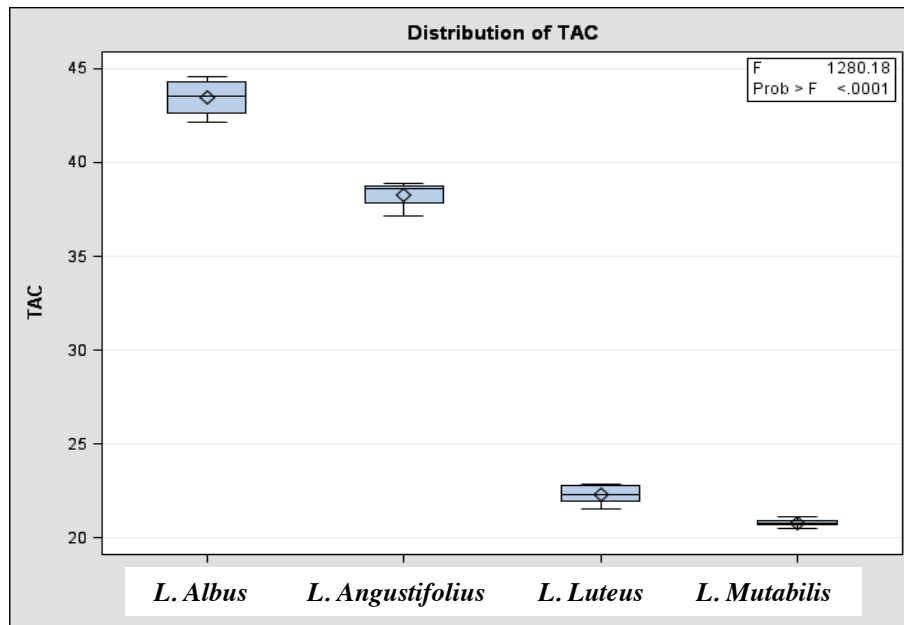

Figure 3 Box-plot of the content of total antioxidant capacity TAC (%) in four species of lupin.

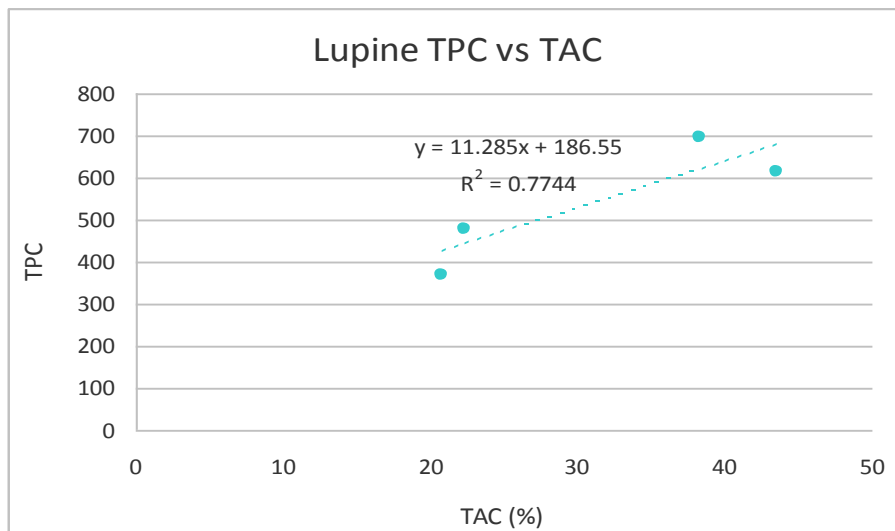

Figure 4 Correlation between TP and TAC of four species of lupin.

Walaa et al. (2015) published that the value of antioxidant capacity in sweet lupine flour was (20.7 ± 1.22%). The results by those authors in comparison to our measured values in *L. Mutabilis* species (pearl color), their results were similar to our result. (Wang and Clements, 2008) determined that antioxidant activity in *L. Luteus* unknown variety name was (0.217 mg Trolox Eq.g⁻¹), and in *L. Angustifolius* unknown variety name was (0.424 mg Trolox Eq.g⁻¹), in two varieties of *L. Albus* were (0.153 mg Trolox Eq.g⁻¹) In comparison to our measured values of antioxidant activity their result was similar to the present value in *L. Luteus* with (22.29%) and present result in *L. Albus* with (43.44%) higher than their results in *L. Albus* but present result in *L. Angustifolius* with (38.27%) lower than their result in *L. Angustifolius* with (0.424 mg Trolox Eq.g⁻¹).

Correlation between the total antioxidant activity values and total phenolics contents

ANOVA linear correlation coefficients were used to assess the relationships between TPC and TAC, Correlation: Our result confirmed a strong statically correlations between total polyphenol content and total antioxidant capacity values. A statistically strongly significant correlation (R = 0.88; p < 0.05) was found (Figure 4). Wang and Clements (2008) found that the free radical scavenging activity is not well correlated with total phenolic contents (R = 0.204) in different species and varieties of lupin seeds. Amarowicz et al. (2005) analyzed the extracts of fababean, broad bean, adzuki bean, red bean, pea, red lentil and green lentil seeds using 80% (v/v) acetone and confirmed a statistically significant correlation between the total antioxidant activity values and total phenolics (p = 0.01). A strong correlation between total polyphenol content and antioxidant activity (R = 0.86; p < 0.05) was observed also by Akond et al. (2011) in common bean and a statistically strongly significant correlation (p-value 2.391E-06; R = 0.802) was found between total

polyphenol content and total antioxidant capacity values by Dalaram et al., (2013) in lentil cultivar. A strong correlation between total polyphenol content and antioxidant activity ($R = 0.783645$; $p < 0.05$) was observed by Dalaram (2015) in different cowpea species and varieties. According these authors this finding suggests that total polyphenolic content is a good predictor of in vitro antioxidant activity.

CONCLUSION

In this study we compared the total phenolic content and antioxidant capacity of (four species lupin seeds). The correlation between total phenol content and antioxidant activity was good, suggesting that phenolic compounds are the most responsible compounds contributing to antioxidant activity of investigated samples despite the *L. Angustifolius* with a higher (TPC) content than *L. Albus* (TPC) content, recorded the lower antioxidant capacity (TAC%). It may be due to the phenolic compound structure and particularly hydroxyl position in the molecule determine antioxidant activity or on the ability to donate hydrogen or electron to a free radical. The positive interrelationship between these two parameters demonstrates that the antioxidant activity depends mainly on polyphenols contents.

REFERENCES

- Abdelrahman R. A. 2014. Influence of Chemical Properties of Wheat-Lupine Flour Blends on Cake Quality. *American Journal of Food Science and Technology*, vol. 2, no. 2, p. 67-75. <https://doi.org/10.12691/ajfst-2-2-4>
- Afshin, A., Micha, R., Khatibzadeh, S., Mozaffarian, D. 2014. Consumption of nuts and legumes and risk of incident ischemic heart disease, stroke, and diabetes: A systematic review and meta-analysis. *The American Journal of Clinical Nutrition*, vol. 100, no. 1, p. 278-288. <https://doi.org/10.3945/ajcn.113.076901> PMID:24898241
- Akond, G. M. A. S. M., Khandaker, L., Berthold, J., Gates, L., Peters, K., Delong, H., Hossain, K. 2011. Anthocyanin, total polyphenols and antioxidant activity of common bean. *American Journal of Food Technology*, vol. 6, no. 5, p. 385-394. <https://doi.org/10.3923/ajft.2011.385.394>
- Amarowicz, R., Troszynska, A., Barylko-Pikielna, N., Shahidi, F. 2004. Polyphenolics extracts from legume seeds: correlations between total antioxidant activity, total phenolics content, tannins content and astringency. *Journal of Food Lipids*, vol. 11, no. 4, p. 278-286. <https://doi.org/10.1111/j.1745-4522.2004.01143.x>
- Amarowicz, R., Troszyńska, A., Barylko-Pikielna, N., Shahidi, F. 2005. Polyphenolics extracts from legume seeds: Correlations between total antioxidant activity, total phenolics content, tannins content and astringency. *Journal of Food Lipids*, vol. 11, no. 4, p. 278-286. <https://doi.org/10.1111/j.1745-4522.2004.01143.x>
- American Diabetes Association. 2008. Nutrition recommendations and interventions for diabetes. *Diabetes Care*, vol. 31, no. suppl. 1, p. S61-S78.
- Aniess, W. I. M., Khalil, A. F., Mosa, Z. M. 2015. Phenolic compounds and antioxidants capacity of sweet lupine derivatives-wheat Flour mixtures and the effects on diabetic rats. *IOSR Journal of Environmental Science, Toxicology and Food Technology*, vol. 9, no. 5, p. 61-69.
- Annicchiarico, P. 2008. Adaptation of cool-season grain legume species across climatically contrasting environments of southern Europe. *Agronomy Journal*, vol. 100, p. 1647-1654. <https://doi.org/10.2134/agronj2008.0085>
- Annicchiarico, P., Manunza, P., Arnoldi, A., Boschin, G. 2014. Quality of *Lupinus Albus L.* (white lupin) seed: extent of genotypic and environmental effects. *Journal of Agricultural and Food Chemistry*, vol. 62, no. 28, p. 6539-6545. <https://doi.org/10.1021/jf405615k> PMID:24934884
- Archer, B. J., Johnson, S. K., Devereux, H. M., Baxter, A. L. 2004. Effect of fat replacement by inulin or lupin-kernel fibre on sausage patty acceptability, postmeal perceptions of satiety and food intake in men. *British Journal Nutrition*, vol. 91, no. 4, p. 591-599. <https://doi.org/10.1079/BJN20031088> PMID:15035686
- Asian Productivity Organization, 2003. Processing and Utilization of Legumes [online] s.a. [cit. 2016-10-25] Available at: http://www.apo-tokyo.org/00e-books/AG-12_Legumes/AG-12_Legumes.pdf.
- Australia New Zealand Food Authority, 2001. Lupin alkaloids in food. A toxicological review and risk assessment. *Technical Report Series*, no. 3, p 1-21.
- Azo, W. M., Lane, G. P. P., Davis, W. P., Cannon, N. D. 2012. Bi-cropping white lupins (*Lupinus Albus L.*) with cereals for wholecrop forage in organic farming: The effect of seed rate and harvest dates on crop yield and quality. *Biological Agriculture and Horticulture*, vol. 28, no. 2, p. 86-100. <https://doi.org/10.1080/01448765.2012.671722>
- Bazzano, L. A., He, J., Ogden, L. G., Loria, C., Vupputuri, S., Myers, L., Whelton, P. K. 2001. Legume consumption and risk of coronary heart disease in US men and women. NHANES I epidemiologic follow-up study. *Archives of Internal Medicine*, vol. 161, no. 21, p. 2573-2578. <https://doi.org/10.1001/archinte.161.21.2573> PMID:11718588
- Bazzano, L. A., Thompson, A. M., Tees, M. T., Nguyen, C. H., Winham, D. M. 2011. Non-soy legume consumption lowers cholesterol levels: a meta-analysis of randomized controlled trials. *Nutrition, Metabolism and Cardiovascular Disease*, vol. 21, no. 2, p. 94-103. <https://doi.org/10.1016/j.numecd.2009.08.012> PMID:19939654
- Bhardwaj, H. L., Hamama, A. A. 2012. Cultivar and growing location effects on white lupin immature green seeds. *Journal of Agricultural Science*, vol. 4, no.2, p. 135-138. <https://doi.org/10.5539/jas.v4n2p135>
- Brand-Williams, W., Cuvelier, M. E., Berset, C. 1995. Use of free radical method to evaluate antioxidant activity. *Food Science and Technology*, vol. 28, no. 1, p. 25-30. [https://doi.org/10.1016/s0023-6438\(95\)80008-5](https://doi.org/10.1016/s0023-6438(95)80008-5)
- Campos-Vega, R., Loarca-Piña, G., Oomah, B. D. 2010. Minor components of pulses and their potential impact on human health. *Food Research International*, vol. 43, no. 2, p. 461-482. <https://doi.org/10.1016/j.foodres.2009.09.004>
- Clements, J., Prilyuk, L., Quealy, J., Francis, G. 2008. Interspecific a crossing among the new world lupin species for lupinus Mutabilis crop improvement. In *Lupinus for Health and Wealth*, Fremantle : Westwrm Australia, Proceedings of the 12th International Lupin Conference, pp. 324-327.
- Dalaram, I. S. 2015. Total polyphenol content and antioxidant capacity of cowpea effect of variety and locality, *Potravinárstvo*, vol. 9, no. 1, p. 358-364. <https://dx.doi.org/10.5219/508>

- Dalaram, S. I., Vollmannova, A., Timoracka, M. 2013. Bioactive compounds in commonly utilized legume cultivars from Iraq. *Journal of Microbiology, Biotechnology and Food Sciences*, vol. 2, sp. no. 1, p. 2032-2042.
- Das, N. P., Pereira, T. A., 1990. Effects of flavonoids on thermal autooxidation of palm oil: structure-activity relationship. *Journal of the American Oil Chemists' Society*, vol. 67, no. 4, p. 255-258. <https://doi.org/10.1007/BF02540652>
- Dlamini, N. R., Dykes, L., Rooney, L. W., Waniska, R. D., Taylor, J. R. N. 2009. Condensed tannins in traditional wet-cooked and modern extrusion-cooked sorghum porridges. *Cereal Chemistry*, vol. 86, no. 2, p. 191-196. <https://doi.org/10.1094/CCHEM-86-2-0191>
- Dueñas, M., Hernández, T., Estrella, I., Fernández, D. 2009. Germination as a process to increase the polyphenol content and antioxidant activity of lupin seeds (*Lupinus Angustifolius* L.). *Food Chemistry*, vol. 117, no 4, p. 599-607. <https://doi.org/10.1016/j.foodchem.2009.04.051>
- Duranti, M., Consonni, A., Magni, Ch., Sessa, F., Scarafoni, A. 2008. The major proteins of lupin seed: Characterisation and molecular properties for use as functional and nutraceutical ingredients. *Trends in Food Science and Technology*, vol. 19, no. 12, p. 624-633. <https://doi.org/10.1016/j.tifs.2008.07.002>
- Ghazal, G. M., Shahhat, I. M. A. 2013. Polyphenols, Flavonoids, Carotenoids and Antioxidant Activity of Lupine (*Lupinus termis* L.) Seeds Affected by Vitamin C, vitamin B3 and Turmeric Rhizomes Extract. *Advances in Environmental Biology*, vol. 7, no. 14, p. 4914-4924.
- Gill, S. S., Tuteja, N. 2010. Reactive oxygen species and antioxidant machinery in abiotic stress tolerance in crop plants. *Plant Physiology and Biochemistry*, vol. 48, no. 12, p. 909-930. <https://doi.org/10.1016/j.plaphy.2010.08.016> PMID:20870416
- Gulewicz, P., Martinez-villaluenga, C., Frias, J., Ciesiolka, D., Gulewicz, K., Vidal-Valverde, C. 2008. Effect of germination on the protein fraction composition of different lupin seeds. *Food Chemistry*, vol. 107, no. 2, p. 830-844. <https://doi.org/10.1016/j.foodchem.2007.08.087>
- Guo, X. Y., Wang, J., Wang, N. L., Kitanaka, S., Yao, X. S., 2007. 9,10-Dihydrophenanthrene derivatives from *Pholidota yunnanensis* and scavenging activity on DPPH free radical. *Journal of Asian Natural Products Research*, vol. 9, no. 2, p. 165-174. <https://doi.org/10.1080/10286020500480522> PMID:17454314
- Hall, R. S., Johnson, S. K., Baxter, A. L., Ball, M. J. 2005. Lupin kernel fibre-enriched foods beneficially modify serum lipids in men. *European Journal of Clinical Nutrition*, vol. 59, no. 3, p. 325-33. <https://doi.org/10.1038/sj.ejcn.1602077> PMID:15508014
- Hwang, Y. W., Kim, S. Y., Jee, S. H., Kim, Y. N., Nam, C., M. 2009. Soy food consumption and risk of prostate cancer: a meta-analysis of observational studies. *Nutrition and Cancer*, vol. 61, no. 5, p. 598-606. <https://doi.org/10.1080/01635580902825639> PMID:19838933
- Chawla, R., Patil, G. R. 2010. Comprehensive Reviews in Food Science and Food Safety. *Acta Chimica Slovaca*, vol. 4, no. 1, p. 95-114.
- Cheng, L., Bucciarelli, B., Shen, J., Allen, D., Vance, C. P. 2011. Update on white lupin cluster root acclimation to phosphorus deficiency. *Plant Physiology*, vol. 156, no. 3, p. 1025-1032. <https://doi.org/10.1104/pp.111.175174> PMID:21464472
- Chiofalo, B., Lo Presti, V., Chiofalo, V., Gresta, F. 2012. The productive traits, fatty acid profile and nutritional indices of three lupin (*Lupinus* spp.) species cultivated in a Mediterranean environment for the livestock. *Animal Feed Science and Technology*, vol. 171, p. 230-239. <https://doi.org/10.1016/j.anifeedsci.2011.11.005>
- Jensen, E. S., Peoples, M. B., Boddey, R. M., Gresshoff, P. M., Hauggaard-Nielsen, H., Alves, B. J., Morrison, M. J. 2012. Legumes for mitigation of climate change and the provision of feedstock for biofuels and biorefineries: a review. *Agronomy for Sustainable Development*, vol. 32, no. 2, p. 329-364. <https://doi.org/10.1007/s13593-011-0056-7>
- Joray, M. L., Rayas-Duarte, P., Mohamed, A., Van Santen, E. 2007. Coated Lupin Bean Snacks. *Journal of Food Quality*, vol. 30, no. 2, p. 267-279. <https://doi.org/10.1111/j.1745-4557.2007.00120.x>
- Kedare, S. B., Singh, R. P., 2011. Genesis and development of DPPH method of antioxidant assay. *Journal of Food Science and Technology*, vol. 48, no. 4, p. 412-422. <https://doi.org/10.1007/s13197-011-0251-1> PMID:23572765
- Kirmizi, S., Guleryuz, G. 2007. Monitoring Protein Mobilization During Seed Germination of Broad Bean (*Vicia faba* L.). *Asian Journal of Plant Sciences*, vol. 6, p. 374-378.
- Kohajdová, Z., Karovičová, J., Schmidt, Š. 2011. Lupin composition and possible use in bakery a review. *Czech Journal of Food Science*, vol. 29, no. 3, p. 203-211. <https://doi.org/10.3923/ajps.2007.374.378>
- Kurzbaum, A., Safori, G., Monir, M., Sinsolo, C. 2008. Anticholinergic syndrome in response to lupin seed toxicity. *Israeli Journal of Emergency Medicine*, vol. 8, no. 2, p. 20-22.
- Lachman, J., Proněk, D., Hejtmánková, A., Pivec, V., Faitová, K. 2003. Total polyphenol and main flavonoid antioxidants in different onion (*Allium cepa* L.) varieties. *Scientia Horticulturae*, vol. 30, p. 142-147.
- Laudadio, V., Tufarelli, V. 2011. Dehulled-micronised lupin (*Lupinus Albus* L. cv. *Multitalia*) as the main protein source for broilers: influence on growth performance, carcass traits and meat fatty acid composition. *Journal of the Science of Food and Agriculture*, vol. 91, no. 11, p. 2081-2087. <https://doi.org/10.1002/jsfa.4426> PMID:21520452
- Lee, Y. P., Mori, T. A., Sipsas, S., Barden, A., Puddey, I. B., Burke, V., Hall, R. S., Hodgson, J. M. 2006. Lupin-enriched bread increases satiety and reduces energy intake acutely. *The American Journal of Clinical Nutrition*, vol. 84, no. 5, p. 975-80. PMID:17093146
- Martín-Cabrejas, M., Díaz, M., Aguilera, Y., Benítez, V., Mollá, E., Esteban, R. 2008. Influence of germination on the soluble carbohydrates and dietary fibre fractions in non-conventional legumes. *Food Chemistry*, vol. 107, no. 3, p. 1045-1052. <https://doi.org/10.1016/j.foodchem.2007.09.020>
- Martínez-Villaluenga, C., Bringe, N. A., Berhow, M. A., Gonzalez de Mejia, E. 2008. Beta-conglycinin embeds active peptides that inhibit lipid accumulation in 3T3-L1 adipocytes in vitro. *Journal of Agricultural and Food Chemistry*, vol. 56, no. 22, p. 10533-10543. <https://doi.org/10.1021/jf802216b> PMID:18947234
- Martínez-Villaluenga, C., Dia, V. P., Berhow, M., Bringe, N. A., Gonzalez de Mejia, E. 2009. Protein hydrolysates from beta-conglycinin enriched soybean genotypes inhibit lipid accumulation and inflammation in vitro. *Molecular Nutrition and Food Research*, vol. 53, no. 8, p. 1007-1018. <https://doi.org/10.1002/mnfr.200800473> PMID:19603404

- Martínez-Villaluenga, C., Frias, J., Vidal-Valverde, C. 2006a. Functional lupin seeds (*Lupinus Albus* L. and *Lupinus Luteus* L.) after extraction of α -galactosides. *Food Chemistry*, vol. 98, no. 2, p. 291-299. <https://doi.org/10.1016/j.foodchem.2005.05.074>
- Martínez-Villaluenga, C., Zielinski, H., Frias, J., Piskula, M. K., Kozłowska, H., Vidal-Valverde, C. 2009. Antioxidant capacity and polyphenolic content of highprotein lupin products. *Food Chemistry*, vol. 112, no. 1, p. 84-88. <https://doi.org/10.1016/j.foodchem.2008.05.040>
- McGonigal, A., Kapustin, J. 2008. Low glycemic index diets: should they be recommended for diabetics? *The Journal for Nurse Practitioners*, vol. 4, no. 9, p. 688-696. <https://doi.org/10.1016/j.nurpra.2008.07.020>
- Mülayim, M., Tamkoç, A., and Babaoglu, M. 2002. Sweet white lupins versus local bitter genotype: agronomic characteristics as affected by different planting densities in the Göller region of Turkey. *European Journal of Agronomy*, vol. 17, no. 3, p. 181-189. [https://doi.org/10.1016/S1161-0301\(02\)00007-2](https://doi.org/10.1016/S1161-0301(02)00007-2)
- Nderitu, A. M., Dykes, L., Awika, J. M., Minnaar, A., Duodu, K. G. 2013. Phenolic composition and inhibitory effect against oxidative DNA damage of cooked cowpeas as affected by simulated in vitro gastrointestinal digestion. *Food Chemistry*, vol. 141, no. 3, p. 1763-1771. <https://doi.org/10.1016/j.foodchem.2013.05.001> PMID:23870889
- Oomah, B. D., Tiger, N. Olson, M., Balasubramanian. P. 2006. Phenolics and antioxidative activities in narrow-leafed lupins (*Lupinus Angustifolius* L.). *Plant Foods for Human Nutrition*, vol. 61, no. 2, p. 91-97. <https://doi.org/10.1007/s11130-006-0021-9> PMID:16804740
- Reinhard, H., Rupp, H., Sager, F., Streule, M., Zoller, O. 2006. Quinolizidine alkaloids and phomopsins in lupin seeds and lupin containing food. *Journal of Chromatography A*, vol. 1112, no. 1-2, p. 353-360. <https://doi.org/10.1016/j.chroma.2005.11.079> PMID:16359686
- Rybarczyk, A., Amarowicz, R. 2007. Silica gel column chromatography of phenolic compounds in sweet lupin seeds extract. *Bromatologia i Chemia Toksykologiczna*, vol. 4, p. 375-379.
- Sanchez, M. C., Altares, P., Pedrosa, M. M., Burbano, C., Cuadrado, C., Goyoaga, C., Muzquiz, M., Jimenez-Martinez, C., Davila-Ortiz, G. 2004. Alkaloid Variation During Germination in Different Lupin Species. *Journal of Food Chemistry*, vol. 90, no. 3, p. 347-355. <https://doi.org/10.1016/j.foodchem.2004.04.008>
- Scarafoni, A., Ronchi, A., Duranti, M. 2009. A realtime PCR method for the detection and quantification of lupin flour in wheat flour-based matrices. *Food Chemistry*, vol. 115, no. 3, p. 1088-1093. <https://doi.org/10.1016/j.foodchem.2008.12.087>
- Sebastia, V., Barbera, R., Farre, R and Lagarda, M. J. 2001. Effects of Legume Processing on Calcium, Iron and Zinc Contents and Dialysabilities. *Journal of Sciences of Food and Agriculture*, vol. 81, no. 12, p.1180-1185. <https://doi.org/10.1002/jsfa.927>
- Shimada, K., Fujikawa, K., Yahara, K., Nakamura, T., 1992. Antioxidative properties of xanthone on the auto oxidation of soybean in cyclodextrin emulsion. *Journal of Agricultural and Food Chemistry*, vol. 40, p. 945-948. <https://doi.org/10.1021/jf00018a005>
- Sievenpiper, J., Kendall, C. W., Esfahani, A., Wong, J. M., Crelton, A. J., Jiang, H. Y., Bazinet, R. P., Vidgen, E., Jenkins, D. J. 2009. Effect of non-oil-seed pulses on glycaemic control: a systematic review and meta-analysis of randomised controlled experimental trials in people with and without diabetes. *Diabetologia*, vol. 52, no. 8, p. 1479-1495. <https://doi.org/10.1007/s00125-009-1395-7> PMID:19526214
- Siger, A., Czubinski, J., Kachlicki, P., Dwiecki, K., Lampart-Szczapa, E., Nogala-Kalucka, M. 2012. Antioxidant activity and phenolic content in three lupin species. *Journal of Food Composition and Analysis*, vol. 25, no. 2, p.190-197. <https://doi.org/10.1016/j.jfca.2011.10.002>
- Soares, J. R., Dins, T. C. P., Cunha, A. P., Almeida, L. M., 1997. Antioxidant activity of some extracts of *Thymus zygis*. *Free Radical Research*, vol. 26, no. 5, p. 469-478. <https://doi.org/10.3109/10715769709084484> PMID:9179593
- Stoddard, F. L., Hovinen, S., Kontturi, M., Lindström, K., Nykänen, N. 2009. Legumes in Finnish agriculture: History, present status and future prospects. *Agricultural and Food Science*, vol. 18, no. 3-4, p. 191-205. <https://doi.org/10.2137/145960609790059578>
- Sujak, A., Kotlarz, A., Strobel, W. 2006. Compositional and nutritional evaluation of several lupin seeds. *Food Chemistry*, vol. 98, no. 4, p. 711-719. <https://doi.org/10.1016/j.foodchem.2005.06.036>
- Uzun, B., Arslan, C., Karhan, M., Tokar, C. 2007. Fat and fatty acids of white lupin (*Lupinus Albus* L.) in comparison to sesame (*Sesamum indicum* L.). *Food Chemistry*, vol. 102, no. 1, p. 45-49. <https://doi.org/10.1016/j.foodchem.2006.03.059>
- Wang, S., Clements, J. 2008. Antioxidant Activities of Lupin Seeds. *Lupinus for Health and Wealth, Fremantle : Westwrn Australia, Proceedings of the 12th International Lupin Conference*, pp. 324-327. ISBN 0-86476- 153-8.
- Xu, J. G., Tian, C. R., Hu, Q. P., Luo, J. Y., Wang, X. D., Tian, X. D. 2009. Dynamic changes in phenolic compounds and antioxidant activity in oats (*Avena nuda* L.) during steeping and germination. *Journal of Agricultural and Food Chemistry*, vol. 57, no. 21, p. 10392-10398. <https://doi.org/10.1021/jf902778j> PMID:19827789
- Zielinska, D., Frias, J., Piskula, M. K., Kozłowska, H., Zielinski, H., Vidal-Valverde, C. 2008. Evaluation of the antioxidant capacity of lupin sprouts germinated in the presence of selenium. *European Food Research and Technology*, vol. 227, p. 1711-1720. <https://doi.org/10.1007/s00217-008-0898-7>
- Zralý, Z., B. Písaříková, B., Trčková, M., Doležal, M., Thiemel, J., Simeonovová, J., Jůzl, M. 2008. Replacement of soya in pig diets with white lupine cv. Butan. *Czech. Journal of Animal Science*, vol. 53, p. 418-430.
- Zralý, Z., B. Písaříková, B., Trčková, M., Herzigl, I., Jůzl, M., Simeonová, J. 2007. The Effect of White Lupine on the Performance, Health, Carcass Characteristics and Meat Quality of Market Pigs. *Veterinarní Medicina*, vol. 52, no. 1, p. 29-41.

Acknowledgments:

This work was supported by grant VEGA No. 12345.

Contact address:

Ismael Sulaiman Dalaram, Department of Food Technology, College of Agriculture, Salahaddin University in Erbil, Iraq Republic, E-mail: dlaram.dizayee@gmail.com



POLYPHENOLS CONTENT AND ANTIOXIDANT ACTIVITY OF PAPRIKA AND PEPPER SPICES

Soňa Škrovánková, Jiří Mlček, Jana Orsavová, Tünde Juríková, Pavla Dřimalová

ABSTRACT

Paprika spices (*Capsicum annuum*) and black pepper spices (*Piper nigrum*) are very popular seasonings for culinary and industrial utilization due to the change of sensory quality (taste, aroma, color) of foods and meals with their addition; their health promoting properties; and also, relevant antioxidant activity. Polyphenols are often responsible for the antioxidant capacity of plant products therefore in our study the content of polyphenols (TP) and antioxidant activity (TAA) were assessed in two common culinary spices - paprika spices (12, ground powder spices) and pepper spices (20, unground and ground, black, green, white and colored spices) of Czech, Austrian, and Slovak producers. These parameters were determined using spectrometric method, for total polyphenols method with Folin-Ciocalteu reagent; the antioxidant activity (TAA) of aqueous and ethanolic extracts of spices was measured by DPPH method with IC50 evaluation. For paprika the total polyphenol content ranged from 14.67 to 28.78 mg GAE.g⁻¹. However, there is only weak connection between the pungency of the spices and the polyphenolic amount, the hotter samples of paprika spices have slightly higher values of TP than sweet types. Also, more pungent paprika products showed a higher potency in scavenging of DPPH free radical than sweeter ones; and ethanolic extracts had slightly higher TAA values (8.73 to 16.17 mg AAE.g⁻¹) than aqueous spice extracts (4.45 to 16.24 mg AAE.g⁻¹). Phenolic amount for pepper spices was assessed in the range of 12.03 to 22.88 mg GAE.g⁻¹. Generally, paprika spices contained more polyphenols than pepper spices. The values of TAA of pepper spices were in the range from 7.07 to 15.81 mg AAE.g⁻¹ for aqueous extracts and from 8.25 to 15.93 mg AAE.g⁻¹ for ethanolic extracts respectively. The highest TAA values were observed for white ground pepper and unground black pepper spices. Unground black pepper samples had higher TAA than ground black pepper. The extent of antioxidant activity of paprika and pepper spices was quite similar. The total phenolics contents in spices were correlated to antioxidant activity only slightly.

Keywords: paprika; pepper; polyphenol; antioxidant activity; DPPH

INTRODUCTION

Sweet pepper or its hot varieties (*Capsicum annuum* L.) are important vegetable crops that could be used for the production of seasonings such as paprika spices. It could be a source of intensive natural colorant (Koncsek et al., 2016) and important also due the change of sensory quality (taste, aroma, color) of foods and meals with their addition. This very popular spice is traditionally produced by sun drying when peppers are spread on the soil where they are exposed to the solar radiation and the wind action. The traditional method is quite slow and dependent on the weather conditions, but there are new possibilities to shorten the time of drying such as microwave-convective drying (Soysal et al., 2009) or tunnel greenhouse driers (Condorí et al., 2001). Some physical, structural, chemical and nutritional alterations could occur during drying (Vega-Gálvez et al., 2009). Drying conditions affect significantly rehydration capacity of dehydrated

pepper, paprika spice (Ramos et al., 2003) that should be rehydrated for consumption of prepared foodstuffs.

In paprika the most important compounds are carotenoids, capsaicinoids, and vitamins E and C. There are about forty carotenoids, β -carotene and β -cryptoxanthin as major. Gnayfeed et al. (2001) determined that concentration of β -carotene increased markedly due light-independent carotenogenesis with the highest level in the overripe pods. Carotenoids are responsible for the color of paprika and their contents are related to variety, ripeness and growing condition (rainy and cool season yields fruits with more β -carotene (Márkus et al., 1999), and technological factors. From the group of pungent capsaicinoids capsaicin and dihydrocapsaicin are the dominant constituents, nordihydrocapsaicin and homocapsaicin are minor ones (Perucka and Materska, 2003). About nine flavonoid and phenolic acid compounds determined Materska et al.

(2005). The main compounds from red pepper were sinapoyl and feruloyl glycosides; trans-p-feruloyl-beta-d-glucopyranoside, trans-p-sinapoyl-beta-d-glucopyranoside, trans-p-feruloyl-alcohol-4-O-[6-(2-methyl-3-hydroxy-propionyl)] glucopyranoside, and also luteolin and quercetin glycosides.

These compounds have antioxidant activity and show potential health benefits such as prevention of cardiovascular diseases, cancers, or stimulation of the immune system, urinary problems (Paterson et al., 2006) and other biological activities.

Black pepper, and also other types, green, or white peppers are very popular condiments used worldwide. To its active components belong volatile essential oil, oleoresins, and alkaloids.

Piperine is a major bioactive compound present in black pepper and white pepper, an alkaloid found naturally in plants belonging to the pyridine group of Piperaceae family, such as *Piper nigrum* (Butt et al., 2013; Nahak and Sahu, 2011).

Black pepper has several health benefits, particularly in enhancing digestive tract function, possesses anti-inflammatory and antimicrobial properties and contains antioxidant constituents. Vijayakumara et al. (2004) indicated that supplementation with black pepper or the active principle of black pepper - piperine, can reduce high-fat diet induced oxidative stress to the cells. Piperine also protects against oxidation of various chemicals, decreases mitochondrial lipid peroxidation, inhibition of aryl hydroxylation. Piperine inhibits mitochondrial oxidative phosphorylation, growth stimulatory activity and has chemopreventive effect (Ahmad et al., 2012). It is widely used in various herbal cough syrups and it is also used in anti-inflammatory, anti-malarial, anti-leukemia treatment (Nahak and Sahu, 2011). However, black pepper was found to be less effective against yeast and *Enterococcus*, coliform bacteria than clove, or garlic (Cwiková et al., 2010). Also, green pepper is important condiment that contains relevant phenolic compounds such as 3,4-dihydroxyphenyl ethanol glucoside, 3,4-dihydroxy-6-(N-ethylamino) benzamide and phenolic acid glycosides in the concentrations suggesting a high radical scavenging activity of them (Chatterjee et al., 2007).

MATERIAL AND METHODOLOGY

There were analyzed 12 spices of ground paprika, powder – Austrian (1 – 7), Czech (8 – 10), and Slovak (11 – 12) producers from food markets; and 20 spices of unground and ground black, green, white and colored pepper spices of Austrian (1 – 6), Czech (7 – 16, 19 – 20), and Slovak (17 – 18) producers from food markets, the origin of the spices were mostly Vietnam, India and Indonesia.

For the determination of TP aqueous spice extracts were used, for TAA evaluation aqueous and ethanol extracts were used. They were prepared with 1 g of spice that was extracted with 100 mL demineralized water (100 °C) or ethanol, under stirring in a shaker for 10 min. The extract was filtered through a paper filter and used for the analyses of TP and TAA.

For the determination of total polyphenols (TP) content by spectrometric method Folin-Ciocalteu reagent was used by the modified method of Blainski et al. (2013). To

aqueous spice extract (0.1 mL) demineralized water (1 mL) of and diluted Folin-Ciocalteu agent (1 mL) was added and after agitation it was left for 5 min in the dark at lab temperature, then 1 mL of 10% sodium carbonate solution was added and mixed again. After 15 min. standing in the dark at lab temperature absorbance of samples was measured against blank at wavelength $\lambda = 750$ nm on the spectrophotometer (Libra S6 Biochrom, GB). Results of TP were calculated using gallic acid as standard and expressed as gallic acid equivalents (GAE) in $\text{mg}\cdot\text{g}^{-1}$ sample. Determinations were made in triplicate.

Total antioxidant activity (TAA) was measured by spectrometric method after the reaction of spices extracts with free stable DPPH-radical (1,1-diphenyl-2-picrylhydrazyl) that results in a decrease of absorption over time. The method was modified according to Bystrická et al. (2015). Aqueous or ethanolic spice extract (0.1 mL) was added to 1.9 mL ethanolic solution of DPPH and 1 mL acetate buffer (pH = 5.5). The reaction mixture in capped glass was shaken vigorously and left for 1 h. at lab temperature without light exposure. Absorbance of samples (A) was then measured at wavelength $\lambda = 515$ nm against blank on the spectrophotometer (Libra S6 Biochrom, GB). Also absorbance of control samples (K) was measured at 515 nm against blank. Inactivation (I) was calculated from the decrease of absorbance (%) according to relation (1).

$$(1) \quad I = \frac{K - A}{K} \cdot 100$$

Results of TAA were calculated using ascorbic acid as standard and expressed as ascorbic acid equivalents (AAE) in $\text{mg}\cdot\text{g}^{-1}$ sample. Average results were obtained from three parallel determinations.

The IC50 values were determined for 3 paprika and 3 pepper samples with the highest TAA. They express the concentration of spices extract that is required to scavenge 50% of DPPH free radicals, 50% inactivation. There were prepared 4 diluted aqueous spices extract solutions in the range 2.5 – 10 $\text{mg}\cdot\text{mL}^{-1}$. The reactive mixtures with DPPH solution were made in the same way as for TAA. The IC50 values were quantified graphically (plotting the absorbance against the used extract concentration) and afterwards calculated by linear regression.

Statistic evaluation of the results was made by Statistica program by the analysis of variance (ANOVA) at a 5% significance level and multiple regression analysis.

RESULTS AND DISCUSSION

Polyphenols are often responsible for the antioxidant capacity of plant products. They could be important constituents to explain the protective effects of plant-derived foods and beverages (Habauzit and Morand, 2012).

The results of the total phenolic (TP) content of paprika spices, measured with Folin-Ciocalteu reagent by spectrometric method, are given in Table 1, for pepper spices there are in Table 2.

The values of TP contents for paprika spices were in the range from 14.67 to 28.78 mg equivalents of gallic acid (GAE) per gram of sample. Therefore, the sample with the lowest TP content (sweet paprika spice) had only about 50% of the content of paprika delicate with the highest

Table 1 Polyphenols and antioxidant activity of paprika spices.

Spices	TP (mg GAE. g ⁻¹ ±SD)	Iw (%)	TAAw (mg AAE. g ⁻¹ ±SD)	Ie (%)	TAAe (mg AAE. g ⁻¹ ±SD)
Paprika sweet 1	14.67 ±0.1	27.19	9.08 ±0.1	36.04	11.70 ±0.2
Paprika hot 1	15.65 ±0.1	28.87	9.59 ±0.2	31.22	10.30 ±0.1
Chilli	25.57 ±0.2	35.05	11.47 ±0.1	34.15	11.20 ±0.3
Chilli Jalapeños	28.18 ±0.2	47.32	15.23 ±0.3	50.43	16.17 ±0.2
Paprika goulash	27.18 ±0.1	48.02	15.44 ±0.1	41.52	13.45 ±0.2
Paprika delicate	28.78 ±0.3	31.13	10.28 ±0.2	39.79	12.92 ±0.1
Chilli pepperoncini	24.46 ±0.2	50.65	16.24 ±0.2	48.57	15.61 ±0.1
Paprika hot 2	17.59 ±0.1	36.30	11.86 ±0.1	41.20	13.36 ±0.2
Paprika sweet 2	22.25 ±0.3	34.60	11.34 ±0.2	44.02	14.22 ±0.2
Paprika sweet 3	17.62 ±0.2	12.06	4.45 ±0.1	26.06	8.73 ±0.2
Paprika sweet 4	19.90 ±0.2	37.35	12.18 ±0.3	34.10	11.19 ±0.1
Paprika hot 3	16.45 ±0.1	32.83	10.79 ±0.2	37.81	12.32 ±0.1

Note: w – water extract, e – ethanolic extract.

Table 2 Polyphenols and antioxidant activity of pepper spices.

Spices	TP (mg GAE. g ⁻¹ ±SD)	Iw (%)	TAAw (mg AAE. g ⁻¹ ±SD)	Ie (%)	TAAe (mg AAE. g ⁻¹ ±SD)
Pepper black 1	14.87 ±0.2	44.85	14.47 ±0.2	44.18	14.27 ±0.3
Pepper black ground 1	12.99 ±0.2	26.90	8.98 ±0.1	34.13	11.20 ±0.1
Pepper green 1	15.01 ±0.1	42.76	13.83 ±0.2	35.93	11.75 ±0.2
Pepper white ground 1	13.33 ±0.2	49.23	15.81 ±0.3	43.49	14.06 ±0.1
Pepper 4kinds 1	12.03 ±0.1	27.55	9.18 ±0.1	28.64	9.52 ±0.1
Pepper black spice 1	20.31 ±0.2	42.40	13.72 ±0.1	48.35	15.54 ±0.3
Pepper black 2	18.36 ±0.2	48.26	15.51 ±0.1	33.26	15.93 ±0.2
Pepper black 3	16.62 ±0.3	47.73	15.35 ±0.2	49.62	15.93 ±0.2
Pepper black 4	19.27 ±0.3	40.64	13.18 ±0.2	24.49	8.25 ±0.1
Pepper black 5	19.40 ±0.1	30.83	10.18 ±0.1	30.40	10.06 ±0.3
Pepper black 6	20.04 ±0.1	43.07	13.93 ±0.2	43.70	14.12 ±0.1
Pepper black 7	21.34 ±0.2	25.21	8.47 ±0.1	39.11	12.72 ±0.1
Pepper black 8	19.13 ±0.3	37.15	12.12 ±0.2	46.28	14.91 ±0.1
Pepper black ground 2	15.28 ±0.3	24.53	8.26 ±0.1	30.35	10.04 ±0.2
Pepper black 9	22.88 ±0.1	19.73	6.79 ±0.2	28.23	9.39 ±0.2
Pepper black ground 3	13.63 ±0.1	34.97	11.45 ±0.1	38.24	12.45 ±0.1
Pepper black 10	21.61 ±0.2	39.15	12.73 ±0.3	44.19	14.27 ±0.3
Pepper black ground 4	14.10 ±0.2	20.64	7.07 ±0.1	25.17	8.46 ±0.2
Pepper black 11	14.37 ±0.1	47.86	15.34 ±0.2	42.36	13.71 ±0.1
Pepper black ground 5	16.95 ±0.3	39.95	12.97 ±0.1	41.92	10.52 ±0.1

Note: w – water extract, e – ethanolic extract.

value. Generally, there is only weak connection between the pungency of the spices and the polyphenolic amount. However, the hotter samples of paprika spices have slightly higher values of TP than sweet types what is in agreement with the results of **Zaki et al., (2013)**.

The amount of polyphenols, flavonoids in paprika products could be influenced by variation, and be dependent also on the time of harvesting and processing (**Zaki et al., 2013; Márkus et al., 1999**).

The lowest TP values of pepper spices were evaluated for grounded black pepper spices, however the lowest amount had unground pepper spice consisted of all types of pepper – black, green, and white. Also, white pepper sample had

quite low amount of polyphenols, green pepper was in the middle of the phenolic scale. It is in agreement with the study of **Agbor et al. (2006)** who determined that the hydrolyzed and nonhydrolyzed extracts of black pepper contained significantly more polyphenols compared with those of white pepper. The highest values had unground samples of black pepper of Czech and Slovak producers.

In comparison, paprika spices contained more polyphenols than pepper spices (12.03 – 22.88 mg GAE.g⁻¹ sample) but the volume variance is not meaningful as the antioxidant capacity is dependent on phenolic content only for some kinds of plant products. In paprika there are the most important for antioxidant capacity carotenoids,

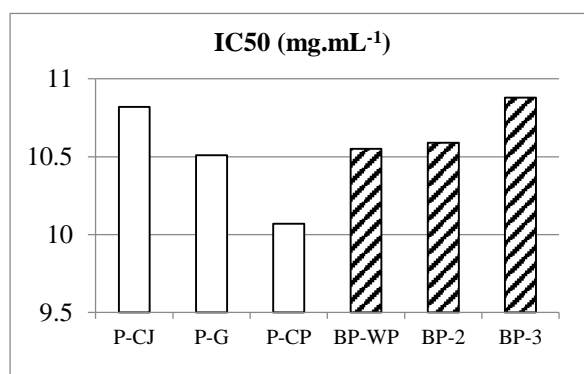

Figure 1 IC₅₀ (mg.mL⁻¹) values of paprika (P) and pepper (BP) extracts.

Note: Extracts: P-CJ = Chilli Jalapenos, P-G = Goulash, P-CP = Chilli pepperoncini, BP-WP = White pepper ground, BP-2 = Black 2, BP-3 = Black 3.

capsaicinoids, and vitamins E (α -tocopherol, γ -tocopherol in seeds), and C (ascorbic acid) (Gnayfeed et al., 2001; Márkus et al., 1999; Kim et al., 2011). Vega-Gálvez et al. (2009) found that the total phenolic content in paprika decreased as air-drying temperature increased from low temperatures (50, 60 °C) to high temperatures (80 and 90 °C). Marín et al. (2004) evaluated that immature peppers showed the highest content of polyphenols.

To evaluate antioxidant potential of paprika and pepper spices the antioxidant activity (TAA) of aqueous and ethanolic extracts of spices was measured by DPPH method. The TAA values for paprika spices are shown in Table 1, in Table 2 there are results for pepper spices.

Many fruits (Skrovankova et al., 2015), vegetables (Shetty et al., 2013), and their products contain substances, bioactive compounds, that individually or combined, possess high antioxidant activity. They can scavenge free radicals and protect foodstuffs or human organisms against oxidative damage.

Extracts exhibited different extent of antioxidant activity. The extent of paprika antioxidant activity in our study is from 4.45 to 16.24 mg of ascorbic acid equivalents per gram of sample for aqueous extracts and from 8.73 to 16.17 mg AAE.g⁻¹ for ethanolic extracts respectively. More pungent extracts (Chilli pepperoncini, Chilli Jalapeños, Paprika goulash) showed a higher potency in scavenging of DPPH free radical than sweeter samples of paprika extracts, both aqueous and ethanolic. This may be related to the high amount of different bioactive compounds with antioxidant power such as capsaicinoids in paprika.

Ethanolic extracts had in general higher TAA values, although in few cases the values were lower than for extracts with water. Therefore, ethanol is supposed to be better solution than water to obtain extract with higher antioxidant activity. In the study of Kim et al. (2016) the paprika ethanolic extracts showed lower values of bioactivity than the water ones.

The radical scavenging activity expresses higher TAA values at used high temperatures (80-90 °C) rather than at low temperatures (50-70 °C) as detected Vega-Gálvez et

al. (2009). Also, growing season can influence TAA values (Zaki et al., 2013), as paprika produced in November, showed higher radical scavenging activity in DPPH assay than the one produced in September, December or October.

The values of TAA of pepper spices were in the range from 7.07 to 15.81 mg AAE.g⁻¹ of sample for aqueous extracts and from 8.25 to 15.93 mg AAE.g⁻¹ for ethanolic extracts respectively. The highest TAA values were observed for white ground pepper (origin in Vietnam) and unground black pepper spices of Czech and Austrian producers. In the study of Agbor et al. (2006) the black pepper extracts were evaluated as more effective than white one as observed in the free radical and reactive oxygen species scavenging activities. Suhaj et al. (2006) determined that the anti-radical activity changes of black pepper caused by storage were not significant.

Generally, unground black pepper samples had higher TAA than ground, black pepper powder. The samples with the lowest TAA values (unground black pepper of Czech producers and ground spices, 4kinds pepper) had only about 50% of the activity of other black pepper samples, similarly to phenolic content.

Analogous to paprika samples, ethanolic extracts had in general higher TAA values with few cases of lower values. Gülçin (2005) determined that both water extract and ethanol extract of black pepper exhibit strong total antioxidant activity. Water extract showed stronger DPPH scavenging activity rather than ethanol one, however this difference was not found significant, and both extracts have a noticeable effect on scavenging free radical.

Figure 1 shows the amount of spice extracts (selected with the highest TAA) needed for 50% inhibition (IC₅₀). Lower IC₅₀ value indicates higher antioxidant activity. IC₅₀ concentrations of paprika aqueous extracts were quite similar, in short range 10.07 – 10.82 mg.mL⁻¹. The IC₅₀ extent for pepper spices (10.55 – 10.88 mg.mL⁻¹) was also alike paprika samples.

Overall antioxidant activity of paprika spices and pepper spices was quite similar, without significant differences among them.

Our results revealed that the total phenolics contents in paprika spices were correlated to antioxidant activity only slightly. The correlation coefficients for aqueous and ethanolic extracts were R₂ = 0.66 and R₂ = 0.72 respectively. However, Zaki et al. (2013) found strong correlation between the total phenolic contents and DPPH values (R₂ = 0.95) in Moroccan sweet paprika and that the total phenolic contents could serve as a useful indicator for the antioxidant activity of paprika.

The values of correlation coefficients for TP contents in pepper spices were also correlated to antioxidant activity only very weakly (R₂ = 0.23 and R₂ = 0.38, for aqueous and ethanolic extracts respectively).

Due to our determinations polyphenols contribution to antioxidant activity of spices is, based on low regression values, quite low. Other compounds might contribute to TAA more as stated Kim et al. (2011). The amounts of capsanthin and L-ascorbic acid correlate well with antioxidant activity. Also, Materska and Perucka (2005) found a high correlation between the content of capsaicin and dihydrocapsaicin and the antioxidant activity.

CONCLUSION

Addition of paprika spices (dried fruits of the pepper family) and pepper spices (mainly black pepper, white or green peppers) could change foods sensory quality and also, due to the antioxidants presence, lower oxidation in the foods. Antioxidants help to control oxidation in foods effectively, therefore usage of spices such as paprika or pepper spices are also of great economical interest.

Polyphenols are often responsible for the antioxidant capacity. The total polyphenols of analyzed paprika spices ranged from 14.67 to 28.78 mg GAE.g⁻¹. The hotter samples of paprika spices have slightly higher values of TP than sweet types. They also showed a higher potency in scavenging of DPPH free radical. Ethanolic extracts had slightly higher TAA values (8.73 to 16.17 mg AAE.g⁻¹) than aqueous ones (4.45 to 16.24 mg AAE.g⁻¹). Pepper spices (12.03 to 22.88 mg GAE.g⁻¹) contained less polyphenols than paprika spices. TAA of pepper spices (7.07 – 15.81 mg AAE.g⁻¹ for aqueous extracts; 8.25 – 15.93 mg AAE.g⁻¹ for ethanolic extracts respectively) was quite similar to paprika spices. Therefore, both spices could be sources of antioxidants for oxidation protection.

REFERENCES

- Agbor, G. A., Vinson, J. A., Obenc, J. E., Ngogang, J. Y. 2006. Comparative analysis of the in vitro antioxidant activity of white and black pepper. *Nutrition Research*, vol. 26, no. 12, p. 659-663. <https://doi.org/10.1016/j.nutres.2006.09.019>
- Ahmad, N., Fazal, H., Abbasi, B. H., Farooq, S., Ali, M., Khan, M. A. 2012. Biological role of Piper nigrum L. (Black pepper): A review. *Asian Pacific Journal of Tropical Biomedicine*, vol. 2, no. 3, p. S1945-S1953. [https://doi.org/10.1016/S2221-1691\(12\)60524-3](https://doi.org/10.1016/S2221-1691(12)60524-3)
- Blainski, A., Lopes, G. C., Palazzo de Mello, J. C. 2013. Application and Analysis of the Folin Ciocalteu Method for the Determination of the Total Phenolic Content from *Limonium Brasiliense* L. *Molecules*, vol. 18, no. 6, p. 6852-6865. <https://doi.org/10.3390/molecules18066852> PMID:23752469
- Butt, M. S., Pasha, I., Sultan, M. T., Randhawa, M. A., Saeed, F., Ahmed, W. 2013. Black pepper and health claims: a comprehensive treatise. *Critical Reviews in Food Science and Nutrition*, vol. 53, no. 9, p. 875-886. <https://doi.org/10.1080/10408398.2011.571799> PMID:23768180
- Bystrická, J., Musilová, J., Tomáš, J., Kavalcová, P., Lenková, M., Tóthová, K. 2015. Varietal dependence of chemoprotective substances in fresh and frozen spinach (*Spinacia oleracea*, L.). *Potravinárstvo*, vol. 9, no. 1, p. 468-473. <https://doi.org/10.5219/519>
- Chatterjee, S., Niaz, Z., Gautam, S., Adhikari, S., Variyar, P. S., Sharma, A. 2007. Antioxidant activity of some phenolic constituents from green pepper (*Piper nigrum* L.) and fresh nutmeg mace (*Myristica fragrans*). *Food Chemistry*, vol. 101, no. 2, p. 515-523. <https://doi.org/10.1016/j.foodchem.2006.02.008>
- Condorí M., Echazú, R. Saravia, L. 2001. Solar drying of sweet pepper and garlic using the tunnel greenhouse drier. *Renewable Energy*, vol. 22, p. 447-460. [https://doi.org/10.1016/S0960-1481\(00\)00098-7](https://doi.org/10.1016/S0960-1481(00)00098-7)
- Cwiková, O., Gregor, T., Šottníková, V., Mašková, H. 2010. Antimicrobial Activity of Spices. *Potravinárstvo*, vol. 4, special no., p. 381-386. Available at: http://www.potravinarstvo.com/dokumenty/mc_februar_2010/pdf/4/Cwikova.pdf
- Daood, H. G., Palotás, G., Palotás, G., Somogyi, G., Péka, Z., Helyes, L. 2014. Carotenoid and antioxidant content of ground paprika from indoor-cultivated traditional varieties and new hybrids of spice red peppers. *Food Research International*, vol. 65, Part B, p. 231-237.
- Daood, H. G. 2009. Analytical and technological aspects of bioactive compounds in spice red pepper. *Acta Alimentaria*, vol. 38, suppl. No. 1, p. 87-97. <https://doi.org/10.1556/AAlim.38.Suppl.6>
- Daood, H. G., Kapitány, J., Biacs, P., Albrecht, K. 2006. Drying temperature, endogenous antioxidants and capsaicinoids affect carotenoid stability in paprika (red pepper spice). *Journal of the Science of Food and Agriculture*, vol. 86, no. 14, p. 2450-2457. <https://doi.org/10.1002/jsfa.2639>
- Gnayfeed, M. H., Daood, H. G., Biacs, P. A., Alcaraz, C. F. 2001. Content of bioactive compounds in pungent spice red pepper (paprika) as affected by ripening and genotype. *Journal of the Science and Food Agriculture*, vol. 81, no. 15, p. 1580-1585. <https://doi.org/10.1002/jsfa.982>
- Gülçin, İ. 2005. The antioxidant and radical scavenging activities of black pepper (*Piper nigrum*) seeds. *International Journal of Food Sciences and Nutrition*, vol. 56, no. 7, p. 491-499. <https://doi.org/10.1080/09637480500450248> PMID:16503560
- Habauzit, V., Morand, C. 2012. Evidence for a protective effect of polyphenols-containing foods on cardiovascular health: an update for clinicians. *Therapeutic Advances in Chronic Disease*, vol. 3, no. 2, p. 87-106. <https://doi.org/10.1177/2040622311430006> PMID:23251771
- Kim, H. G., Bae, J. H., Jastrzebski, Z., Cherkas, A., Heo, B. G., Gorinstein, S., Ku, Y. G. 2016. Binding, Antioxidant and Anti-proliferative Properties of Bioactive Compounds of Sweet Paprika (*Capsicum annum* L.). *Plant Foods for Human Nutrition*, vol. 71, no. 2, p. 129-136. <https://doi.org/10.1007/s11130-016-0550-9> PMID:27184000
- Kim, J. S., Ahn, J., Lee, S. J., Moon, B., Ha, T. Y., Kim, S. 2011. Phytochemicals and antioxidant activity of fruits and leaves of paprika (*Capsicum Annum* L., var. special) cultivated in Korea. *Journal of Food Science*, vol. 76, no. 2, p. C193-198. <https://doi.org/10.1111/j.1750-3841.2010.01891.x> PMID:21535734
- Kim, J. S., An, C. G., Park, J. S., Lim, Y. P., Kim, S. 2016. Carotenoid profiling from 27 types of paprika (*Capsicum annum* L.) with different colors, shapes, and cultivation methods. *Food Chemistry*, vol. 201, p. 64-71. <https://doi.org/10.1016/j.foodchem.2016.01.041> PMID:26868549
- Koncsek, A., Kruppai, L., Helyes, L., Bori, Z., Daood, H. G. 2016. Storage Stability of Carotenoids in Paprika from Conventional, Organic and Frost-Damaged Spice Red Peppers as Influenced by Illumination and Antioxidant Supplementation. *Journal of Food Processing and Preservation*, vol. 40, no. 3, p. 453-462. <https://doi.org/10.1111/jfpp.12623>
- Marín, A., Ferreres, F., Tomás-Barberán, F. A., Gil, M. I. 2004. Characterization and quantitation of antioxidant constituents of sweet pepper (*Capsicum annum* L.). *Journal of Agricultural and Food Chemistry*, vol. 52, no. 12, p. 3861-3869. <https://doi.org/10.1021/jf0497915> PMID:15186108
- Márkus, F., Daood, H. G., Kapitány, J., Biacs, P. A. 1999. Change in the carotenoid and antioxidant vitamin content of spice red pepper (paprika) as a function of ripening and some

technological factors. *Journal of Agricultural and Food Chemistry*, vol. 47, no. 1, p. 100-107.

<https://doi.org/10.1021/jf980485z>

PMid:10563856

Materska, M., Perucka, I. 2005. Antioxidant activity of the main phenolic compounds isolated from hot pepper fruit (*Capsicum annuum* L.). *Journal of Agricultural and Food Chemistry*, vol. 53, no. 5, p. 1750-1756.

<https://doi.org/10.1021/jf035331k>

PMid:15740069

Nahak, G., Sahu, R. K. 2011. Phytochemical Evaluation and Antioxidant activity of Piper cubeba and Piper nigrum. *Journal of Applied Pharmaceutical Science*, vol. 1, no. 8, p. 153-157.

Paterson, J. R., Srivastava, R., Baxter, G. J., Graham, A. B., Lawrence, J. R. 2006. Salicylic acid content of spices and its implications. *Journal of Agricultural and Food Chemistry*, vol. 54, no. 8, p. 2891-2896.

<https://doi.org/10.1021/jf058158w>

PMid:16608205

Perucka, I.; Materska, M. 2003. Antioxidant activity and content of capsaicinoids isolated from paprika fruits. *Polish Journal of Food and Nutrition Sciences*, vol. 12, no. 2, p. 15-18.

Ramos, I. N., Brandao, T. R. S., Silva, C. L. M. 2003. Structural Changes During Air Drying of Fruits and Vegetables. *Food Science and Technology International*, vol. 9, no. 3, p. 201-206.

<https://doi.org/10.1177/1082013030335522>

Shetty, A. A., Magadam, S., Managanvi, K. 2013. Vegetables as Sources of Antioxidants. *Journal of Food Nutrition and Disorder*, vol. 2, p. 1.

<https://doi.org/10.4172/2324-9323.1000104>

Soysal, Y., Ayhan, Z., Eştürk, O., Arıkan, M. F. 2009. Intermittent microwave-convective drying of red pepper: Dimerizing kinetics, physical (colour and texture) and sensory quality. *Biosystems Engineering*, vol. 103, no. 4, p. 455-463.

<https://doi.org/10.1016/j.biosystemseng.2009.05.010>

Suhaj, M., Rácová, J., Polovka, M., Brezová, V. 2006. Effect of γ -irradiation on antioxidant activity of black pepper (*Piper nigrum* L.). *Food Chemistry*, vol. 97, no. 4, p. 696-704.

<https://doi.org/10.1016/j.foodchem.2005.05.048>

Vega-Gálvez, A., Di Scala, K., Rodríguez, K., Lemus-Mondaca, R., Miranda, M., López, J., Perez-Won, M. 2009.

Effect of air-drying temperature on physico-chemical properties, antioxidant capacity, colour and total phenolic content of red pepper (*Capsicum annuum*, L. var. *Hungarian*). *Food Chemistry*, vol. 117, no. 4, p. 647-653.

<https://doi.org/10.1016/j.foodchem.2009.04.066>

Vijayakumara, R. S., Suryaa, D., Nalinia, N. 2004. Antioxidant efficacy of black pepper (*Piper nigrum* L.) and piperine in rats with high fat diet induced oxidative stress. *Redox Report*, vol. 9, no. 2, p. 105-110.

<https://doi.org/10.1179/135100004225004742>

PMid:15231065

Zaki, N., Hakmaoui, A., Ouattmane, A., Hasib, A., Fernández-Trujillo, J. P. 2013. Bioactive Components and Antioxidant Activity of Moroccan Paprika (*Capsicum annuum* L.) at Different Period of Harvesting and Processing. *Biology Agriculture and Healthcare*, vol. 3, no. 8, p. 1-8.

Acknowledgments:

This work was supported by grant IGA/FT/2017/006.

Contact address:

Ing. Soňa Škrovánková, Ph.D., Tomas Bata University in Zlín, Faculty of Technology, Department of Food Analysis and Chemistry, nám. T. G. Masaryka 5555, 760 01 Zlín, Czech Republic, E-mail: skrovankova@ft.utb.cz

doc. Ing. Jiří Mlček, Ph.D., Tomas Bata University in Zlín, Faculty of Technology, Department of Food Analysis and Chemistry, nám. T. G. Masaryka 5555, 760 01 Zlín, Czech Republic, E-mail: mlcek@ft.utb.cz

Mgr. Jana Orsavová, Tomas Bata University in Zlín, Faculty of Humanities, Language Centre, nám. T. G. Masaryka 1279, 760 01 Zlín, Czech Republic, E-mail: orsavova@fhs.utb.cz

doc. RNDr. Tünde Juríková, Ph.D., Institute for Teacher Training, Faculty of Central European Studies, Constantine the Philosopher University in Nitra, Drážovská 4, 949 74 Nitra, Slovakia, E-mail: tjurikova@ukf.sk

Ing. Pavla Dřimalová, Tomas Bata University in Zlín, Faculty of Technology, Department of Food Analysis and Chemistry, nám. T. G. Masaryka 5555, 760 01 Zlín, Czech Republic, E-mail: Pavla.Drimalova@seznam.cz

INFLUENCE OF SELENIUM AND VITAMIN E SUPPLEMENTATION DURING PREGNANCY ON UDDER HEALTH AND MILK QUALITY IN DAIRY COWS AT PARTURITION

František Zigo, Milan Vasil', Zuzana Farkašová, Martina Zigová, Juraj Elečko

ABSTRACT

Selenium and vitamin E ranks among very important antioxidant agents protecting the organism from the effect of reactive oxygen forms. The deficiency of both nutrients during pregnancy in cows often result in metabolic disorders and increased of cases of related diseases (mastitis, retained placenta and other reproductive disorders). The aim of the present work was to study the influence of different dose of parenteral administration selenium and vitamin E in dairy cows prior to parturition on selected metabolic parameters, udder health and milk quality. A total in herd of 270 Holstein cattle in east of Slovakia in a two-four lactation-gestation cycle the control group (C) and 2 experimental groups (D, D1) were selected. All groups were similarly housed, managed and fed with the diet containing from 36 to 42 mg vitamin E and 0.2 mg.kg⁻¹ Se of DM through the study period. In group D a products containing vitamin E and selenium were administered IM four weeks prior to the expected date of parturition in total dose of 1000 mg of dl- α -tocopherol acetate and of 44 mg sodium selenite per cow, respectively. In group D1 the same products were administered twice, four and two weeks prior to parturition. Blood samples were 4 weeks prior to predicted calving date (the time of treatment), on parturition day and at 14th day after calving for assessment of plasma vitamin E and selenium concentrations. Blood samples of the calves were drawn from *jugular vein* at birth and first colostrum was also collected. The occurrence of the mastitis and retained placenta during the first 14th day after calving were evaluated in all groups. Higher plasmatic and colostrum concentrations of selenium and vitamin E were found only in group with repeat application of Se and vitamin E (D1) collected on the day of parturition. At the 14th day of postpartal period a trend of lower occurrence of mastitis was observed in group D1 compared to D group, administered IM once and control group. Parenteral supplementation of selenium and vitamin E during pregnancy had no impact on their transmission into the milk and on the presence of bacterial agents in raw milk obtained from dairy cows diagnosed with mastitis.

Keywords: dairy cows; injection; milk; mastitis; vitamin E; selenium

INTRODUCTION

Most diseases in dairy cows occur at or just after calving, which is a period associated with immune suppression, resulting in an increased susceptibility to infections. Parturition immune suppression is multifactorial but is associated with endocrine changes and decreased intake of critical nutrients. Among the most important nutrients but often deficient in compound feeding stuffs, involved in the biological functions and antioxidative activity are vitamin E, and selenium (Se) compounds (Persson et al., 2007; Kafizadeh et al., 2014).

The vitamin E (α -tocopherol) status of dairy cows is one important component of a well-functioning immune system because of its antioxidant effects on cows and young dairy calves (Meglia et al., 2006; Persson et al., 2007).

Along with Se, vitamin E ranks among very important antioxidant agents protecting the organism from the effect of reactive oxygen forms. As an extinguisher of peroxidation reactions in membranes, vitamin E is probably the most important antioxidant in cell membranes (Pavlata et al., 2004; Balicka and Jastrzębski, 2014).

The antioxidant effect of Se depends mainly on glutathione peroxidase (GPx), in which selenium is contained (Horký et al., 2013).

Vitamin E and GPx operate at different sites in the cell. The function-site for GPx is cell cytosol and vitamin E operates within lipid membranes (Meglia et al., 2006; Mehri et al., 2013).

According to Pavlata et al. (2005), diets containing under 0.3 mg of Se.kg⁻¹ of DM, and 500 IU of vitamin

E/cow per day are deficient in antioxidants and decrease immunostimulation of organism in the dry period.

The status of both these nutrients in the blood is essential for the health and performance of cows during the periparturition period as well as the offsprings (Lacetera et al., 1996; Pavlata et al., 2012).

Application of synthetic injectable forms of Se and vitamin E seems to be the most effective solution of the problem of the requirements of the organism to both antioxidants. Especially in the periparturition period, when the oral supplementation fails to increase their reduced concentration in the blood plasma of dairy cows and is one of the ways how to increase selenium and vitamin E in functional foods from animal sources (Horký, 2014; Kafizadeh et al., 2014).

The aim of the experiment was to study the influence of different dose of parenteral administration selenium and vitamin E in dairy cows prior to parturition on selected antioxidant parameters, occurrence of mastitis and milk quality.

MATERIAL AND METHODOLOGY

Animal management

The experiment was carried out in herd of 270 Holstein cattle in east of Slovakia. Dairy cows were kept in a free housing system with a separate calving barn and equipped with individual boxes with bedding and were allowed *ad libitum* access to water. All animals received the diets based on a total mixed ration (TMR) that is required for the cows during the dry period and the beginning of lactation. The pariparturition cows were fed with the diets containing grass hay (3.8%), corn silage (45.0%), clover-grass silage (33.3%), grass haylage (3.5%), triticale grain (10.2%), soybean meal (2.8%) and concentrate (1.4%) as presented in Table 1. During *pre partum* and *post partum*, all cows received the diets containing 36 and 42 mg of vitamin E per kg of DM, respectively, but with the same amount of Se (0.2 mg.kg⁻¹ DM) in both diets. The calves were separated from the dams immediately after the birth and were artificially fed with 2 L of colostrum using a calf nursing bottle with nipple for the next 8 – 10 hours.

The mean daily intake for the dry period and at 5th day after calving under study was 10 kg and 18 kg of DM respectively. The average milk yield of the dairy cows was

7,500 ±40 kg per lactation. Milking took place in the parallel parlour Boumatic 2 x 10 Xpressway (Wisconsin, USA). Before drying was applied intramammary antibiotic preparation Orbenin Dry cow *a.u.v.* (Pfizer, IT) to every quarter of udder.

Parenteral administration of selenium and vitamin E

In total 45 cows (aged 2.5 – 5 years) in the final period of pregnancy an average weight of 628 ±19 kg were randomly assigned into three groups (C, D, D1). Four weeks prior to the expected parturition were the cows in groups C, D and D1 treated as follows:

D – experimental group of 15 animals to which the injectable products Selevit inj. *a.u.v.* (sodium selenite 2.2 mg, dl- α -tocopherol acetate 25 mg in 1 mL of the solution) and Erevit sol. inj. (dl- α -tocopherol acetate 300 mg in 1 mL of the solution) were administered IM once during the dry period (4 weeks prior to expected parturition) in the dose 20 mL *pro toto* of Selevit inj. *a.u.v.* and 1.7 mL *pro toto* of Erevit sol. inj. (total dose of 44 mg of sodium selenite and 1000 mg of dl- α -tocopherol acetate per cow, respectively).

D1 – experimental group of 15 animals to which the injectable products Selevit inj. *a.u.v.* and Erevit sol. inj. were administered twice during the dry period (4 and 2 weeks prior to expected parturition), on the same dose of sodium selenite and dl- α -tocopherol acetate as the group D (total dose of 88 mg of sodium selenite and 2 000 mg of dl- α -tocopherol acetate).

The control group (C, n = 15) was without parenteral supplementation of vitamin E and Se.

Collection of samples and laboratory examination

Blood samples were collected into 12 mL heparinised test tubes from the *jugular vein* of cows four weeks before the expected time of calving, on parturition day and at 14th day after calving. Blood samples of the calves were drawn from *jugular vein* at birth (before suckling). We also collected colostrum into 10 mL tubes immediately after the parturition.

On the basis of the comprehensive examinations on the 12th day according to Jackson and Cockcroft (2002)

Table 1 Nutrient composition of the pre partum and post partum rations fed.

Item	Composition	
	Pre partum	Post partum
DM (g.kg ⁻¹)	475	460
CP (g.kg ⁻¹ DM)	123.1	147.05
Fat (g.kg ⁻¹ DM)	24.7	27.9
NDF (g.kg ⁻¹ DM)	339.6	328.2
ADF (g.kg ⁻¹ DM)	222.1	209.1
NSP (g.kg ⁻¹ DM)	371.2	415.1
Starch (g.kg ⁻¹ DM)	252.2	309.1
NDP (g.kg ⁻¹ DM)	23.4	16.1
NE, MJ.kg ⁻¹	6.2	6.7
Se mg.kg ⁻¹ DM	0.2	0.2
* Vitamin E IU.kg ⁻¹	36	42

Note: *Composition – analysed values; DM – dry matter, CP – crude protein, NDF – neutral detergent fibre, ADF – acid detergent fibre, NSP – non-starch polysaccharides, NDP – non-degraded protein, NE – net energy, *IU – international unit of vitamin E defined as 1 mg (\pm) α -tocopherol acetate.

which consisted of a clinical examination, examination of milk from each quarter of the udder and California mastitis test (CMT). From the sampling 10 mL of the milk sample at a 45° angle to the microbiological examination was assessed the health status of the mammary gland of dairy cows and were detected different forms of mastitis (latent, subclinical, subacute and acute). For the purpose of determining the nutritional values as well as selected mineral element, were sampled 1 kg comprehensive sample of TMR from feed troughs was taken according to Van Soets et al. (1991).

The blood plasma obtained by high speed centrifugation of heparinised blood at 3000 rpm during 15 min. Plasma from each sample was divided into two 3 mL tubes, from which the later setting concentrations of Se and vitamin E. All samples of blood plasma and colostrums together with 2 mL (detection of GPx) of heparinised blood samples were stored at -54 °C until analysis.

The concentration of the Se in samples of feed, plasma, colostrum were determined after wet mineralization in a closed system using a microwave (Milestone MLS 1200) digestion technique with HNO₃ and H₂O₂ by atomic absorptive spectrometer Zeman 4100 (Perkin Elmer, USA) equipped with generating device system, according to the analytical procedure standardised by Pechova et al. (2005).

The GPx activity in heparinized whole blood was measured photometrically using a set supplied by Ransel (Randox RS 505) and the automatic analyser Cobas Mira, and expressed in terms per gram of haemoglobin in the erythrocytes (U.g⁻¹ of Hb). Haemoglobin was analyzed by Haemoglobin kits (Randox-Ransel, UK).

After the extraction of the samples of plasma, colostrum and milk in N-heptane, its evaporation and subsequent dissolution in methanol was determined in duplicate by the content of α-tocopherol analysis according to the HPLC method of Hess et al. (1991). Determination of vitamin E from the homogenized sample from TMR after saponification and extraction by HPLC method was carried out by Politis et al. (1996).

Milk samples (0.05 mL) were inoculated onto blood agar (Oxoid, UK) and cultivated at 37 °C for 24 h. Based on the colony morphology, bacteria *Staphylococcus* spp. were selected for the tube coagulase test (Staphylo PK, ImunaPharm, SR). Suspect colonies *Staphylococcus* spp., *Streptococcus* spp. and *Enterobacteriaceae* spp. were isolated on blood agar, cultivated at 37 °C for 24 h and identified biochemically using the STAPHY-test,

STREPTO-test, resp. ENTERO-test and identification by software TNW Pro 7.0 (Erba-Lachema, CZ). Dry matter was acquired by 48 h drying sample at 105 °C. The nutritional values of TMR were determining by the AOAC methods (1995).

Statistical analysis

Tukey's post tests were used to compare all three experimental groups was indicated by ANOVA. Differences between the mean values of the different treatment groups were considered assuming significance levels of 0.05 and 0.01. Values in tables are means (M) and standard deviation (SD).

RESULTS AND DISCUSSION

Improved intake of selenium and vitamin E is important for dairy cows because of a positive effect of these substances in prophylaxis of many health disorders, which frequently occur in cows and calves already in the early postpartum period. Such disorders consist of nutritional muscular dystrophy, reproductive disorders (retained placenta, increased incidence of endometritis and ovarian cysts), increased somatic cell count, higher occurrence of clinical forms of mastitis, immunity disorders, frequent occurrence of respiratory and gastrointestinal infections in calves (Bouwustra et al., 2010; Meyer et al., 2014).

The lowest plasma of Se and α-tocopherol concentrations are generally observed between 1 week prepartum and 2 weeks postpartum (Kafilzadeh et al., 2014).

In experimental group (D1) higher concentration ($p < 0.01$) of selenium and α-tocopherol (μg.mL⁻¹) in blood plasma and colostrum was found in comparison to D group, administered IM once during the dry period and control group (C) on the day of parturition (Table 2 and 3). Mean α-tocopherol concentrations in blood plasma in all groups were to range from 5.1 – 5.8 μg.mL⁻¹ four weeks before the expected time of calving. Tables 2 and 3 furthermore shows that in all groups not was found the differences in concentration of selenium and vitamin E in the milk at 14th day after calving.

Plasma levels of α-tocopherol up to 4.0 mg.mL⁻¹ have been reported to be adequate in cattle. Canadian researchers testing 10 clinically normal cows from 5 different herds found mean serum vitamin E concentrations in the 5 herds to range from 3.2 – 5.3 mg.mL⁻¹ (Lacetera et al., 1996).

Table 2 Effect of parenteral supplementation of selenium and vitamin E on the concentrations of α-tocopherol (μg.mL⁻¹) in blood plasma, milk and colostrum.

Period		C	D	D1
		M ±SD	M ±SD	M ±SD
28 th day <i>a. p.</i>	cows	5.5 ±0.58	5.8 ±0.54	5.1 ±0.62
	cows	4.4 ±0.76 ^a	4.1 ±0.62 ^a	6.4 ±0.86 ^b
parturition	calves	3.7 ±0.42	3.3 ±0.68	4.1 ±0.74
	colostrum	9.8 ±1.7 ^a	10.8 ±2.6 ^a	14.4 ±2.1 ^b
14 th day <i>p. p.</i>	cows	4.6 ±0.58	4.8 ±0.52	5.1 ±0.76
	milk	0.56 ±0.17	0.63 ±0.18	0.71 ±0.23

Note: D – parenteral supplemented group on 28th day before parturition; D1 – parenteral supplemented group on 28th and 14th day before parturition; C - control group; *a. p.* - ante partum; *p. p.* - post partum; ^{a, b} significance level $p < 0.05$ is presented by different superscribes in a row.

Table 3 Effect of parenteral supplementation of selenium and vitamin E on the concentrations of selenium ($\mu\text{g.L}^{-1}$) in blood plasma, milk and colostrum.

Period		C M \pm SD	D M \pm SD	D1 M \pm SD
28 th day <i>a. p.</i>	cows	75.1 \pm 6.8	76.3 \pm 7.2	74.1 \pm 6.5
	cows	69.4 \pm 6.7 ^a	67.2 \pm 7.8 ^a	81.3 \pm 6.7 ^b
parturition	calves	62.3 \pm 5.1	61.8 \pm 5.8	65.3 \pm 6.9
	colostrum	30.5 \pm 4.4 ^a	33.4 \pm 4.8 ^a	41.2 \pm 5.7 ^b
14 th day <i>p. p.</i>	cows	70.6 \pm 6.1	69.9 \pm 7.7	75.7 \pm 8.7
	milk	15.6 \pm 3.8	16.8 \pm 2.7	18.1 \pm 3.2

Note: D – parenteral supplemented group on 28th day before parturition; D1 – parenteral supplemented group on 28th and 14th day before parturition; C – control group; *a. p.* - *ante partum*; *p. p.* - *post partum*; ^{a, b} significance level $p < 0.01$ is presented by different superscribes in a row.

According to Mohri et al. (2005) calves are born with physiologically low stores of vitamin E, a fat-soluble vitamin that crosses the bovine placenta in limited amounts. Low plasma levels below 4.0 mg.mL^{-1} in the present study have been reported in calves from the control and D groups.

Studies on vitamin E supplementation in late gestation dairy cattle have focused on enhancing cow immunity and performance, whereas such studies in beef cattle have focused on the benefits to the calf. The effects of vitamin E supplementation in pregnant beef cows have varied across experiments. Parenteral administration of 3000 IU of vitamin E to crossbred beef cows approximately one month prior to parturition increased plasma vitamin E concentrations in calves and enhanced their passive immune status (Gunter et al., 2003).

Scholz and Stöber (2002) described as also adequate a

blood level of selenium greater than $100 \mu\text{g.L}^{-1}$. At the beginning of the period considered, the measured values of Se in the blood plasma of dairy cows were in the range of $74.1 - 76.3 \mu\text{g.L}^{-1}$, which can be considered as marginal concentration of this element. The animals of the supplemented group D1 had significantly higher ($p < 0.01$) blood Se concentrations at day of parturition than the controls but the persistence of increased plasma levels at 14th day after parturition was not recorded.

It has been reported that blood Se concentrations below $50 \mu\text{g.L}^{-1}$ are considered diagnostic of frank deficiency, and clinical signs, such as nutritional myodegeneration, can occur at these levels. Se is known to cross the placenta to the calf easily however it is not transferred well through colostrum or milk. Therefore, the Se status of the cow before calving is an important determinant in the Se status of calves (Grunter et al., 2003; Pavlata et al., 2004).

Table 4 Effect of parenteral supplementation of selenium and vitamin E on the activity of GPx (U.g^{-1} of Hb) in blood of dairy cows and calves.

Period		C M \pm SD	D M \pm SD	D1 M \pm SD
28 th day <i>a. p.</i>	cows	397 \pm 35.3	405 \pm 36.7	398 \pm 34.2
	cows	406 \pm 36.8	493 \pm 46.2	431 \pm 40.8
parturition	calves	274 \pm 24.5	289 \pm 26.2	317 \pm 30.4
	cows	443 \pm 42.4	428 \pm 37.4	438 \pm 35.6

Note: D – parenteral supplemented group on 28th day before parturition; D1 – parenteral supplemented group on 28th and 14th day before parturition; C – control group; *a. p.* - *ante partum*; *p. p.* - *post partum*.

Table 5 Influence if injectable supplementation of selenium and vitamin E on occurrence of mastitis, milk yield and retained placenta in multiparous dairy cows.

groups	Σ^h		Σ^i		Rejected quarters*	Infected quarters	Mastitis forms from infected quarters in % (n^{iq})				Milk production*	Retained placenta
	n	%	n	%			L	SC	SA	A		
C	11	73.3	4	26.7	2	11	9.1	18.2	18.2	36.4	33.4 \pm 6.8	0
D	11	73.3	4	26.7	0	10	0	30.0	50.0	20.0	32.6 \pm 7.9	1*
D1	13	86.6	2	13.3	1	7	0	0	57.1	42.9	34.5 \pm 6.4	0

Note: Σ^h – number of healthy dairy cows, Σ^i – number of infected dairy cows, n^{iq} – infected quarters, rejected quarters – dairy cows with atrophy or fibrosis in the mammary gland, L – latent mastitis, SB - subclinical mastitis, SA – subacute mastitis, A - acute mastitis, D –parenteral supplemented group on 28th day before parturition; D1 – parenteral supplemented group on 28th and 14th day before parturition; C – control group, Milk production* – milk production in the first month, 1* – a cow with the retained placenta was not included into the evaluation of the milk production in the first month.

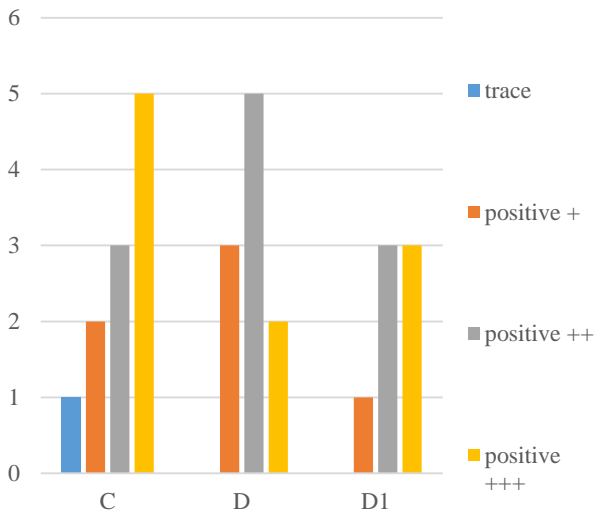

Figure 1 Number of infected mammary quarters detected by CMT at 14th day after calving in selected groups.

Legend: trace – in somatic cell up to 400 x 10³; positive (+) - somatic cell range 400 x 10³ to 1200 x 10³; positive (++) - somatic cell range 1200 x 10³ to 5000 x 10³; positive (+++) - somatic cell range over 5000 x 10³.

Glutathione peroxidase activity is considered to be an indicator of long-term Se supply, as it depends on the erythrocyte life cycle. However, it has been discussed how rapidly the GPx activity reflects changes in the Se status (Pilarczyk et al., 2011; Pechová et al., 2012).

Glutathione peroxidase activity in erythrocytes from cows during the experiment did not differ between all both groups injected with Se and cows without Se. Also, GPx activity did not differ in calves from injected groups in compared with control (Table 4).

For practical use, Pavlata et al. (2002) recommend the lower limit of the reference value of GPx in whole blood of cattle of 250 U.g⁻¹ of Hb. In our study, the activity of GPx throughout the period under review in all experimental groups of cows and calves that is considered to be adequate for optimal GPx activity.

Table 5 shows that after repeat parenteral administration of the selenium-vitamin supplements in group D1 was observed the reduction infected quarters and cases of mastitis. In D1 group was observed reduction in the incidence of mastitis by 13.3% compared to control group. Smith et al. (1997) observed reduction of intramammary infection after repeat intramuscular injection of 2 mg of α-tocopherol acetate and 0.1 mg selenium.kg⁻¹ of body weight at 42nd and 21st days prepartum. In early lactation was determined decrease occurrence the intramammary gland infections from 37% compared to control group supplemented with 100 IU of vitamin.day⁻¹ and with low selenium diet (<0.10 mg.kg⁻¹ DM). Figure 1 shows the number of infected mammary quarters detected by CMT at 14th day after calving in selected groups. The repeat parenteral supplemented group (D1) had 13.4% positive quarters and in the control group had a 11.2% increase of infected quarters (24.6%).

Positive (+) CMT were the most frequently recorded in the three cases of infected quarters group D. Positive

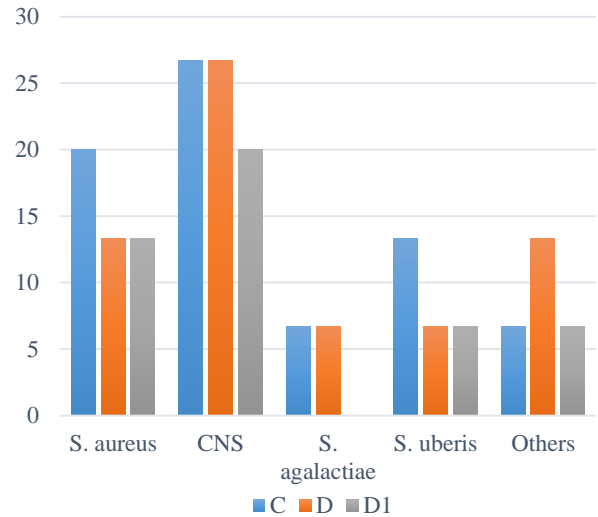

Figure 2 Aetiology of mastitis at 14th day after calving in multiparous dairy cows (%).

Legend: CNS – (coagulase negative staphylococci) - *S. epidermidis*, *S. chromogenes*, *S. xylosus* and *S. schleiferi*, Others - *Bacillus* spp. and *Enterococcus* spp.

quarters (++) were recorded in five quarters in group D and in three cases in control and D1 group. The most quarters with positive scores (+++) were recorded in control and D1 group. This explains the increase in the incidence of subacute and acute forms of mastitis in all selected groups.

Staphylococci and streptococci are the main aetiological agents of ruminant IMI. *Staphylococcus aureus* with coagulase-negative species (CNS) are the most frequent isolates from subclinical and clinical cases IMI (Vasil' et al., 2012).

CNS infection is generally seen as an increase in the SCC in milk of the infected quarter. Milk SCC usually remains below 500,000 cells.mL⁻¹ (Djabri et al., 2002). In a study in which dairy cows were followed-up throughout the whole lactation, the geometric mean SCC was over 600,000 cells.mL⁻¹ in quarters with persistent CNS infection, but only 60,000 cells.mL⁻¹ in healthy quarters (Taponen et al., 2007).

The annual incidence of clinical IMI in dairy herds is generally lower than 5%, but in a small percentage of herds the incidence may exceed 30 – 50% of the animals, causing mortality (gangrenous mastitis) or culling of up to 70 % of the herd (Vautor et al., 2009).

In figure 2 by our analysis of the quarter samples were mainly confirmed CNS in all experimental groups. Further been confirmed *Staphylococcus aureus* *Streptococcus uberis*, *Streptococcus agalactiae*, which are most often associated with the formation of the subacute and acute forms of mastitis. CNS and mixed infection caused subclinical and latent forms of mastitis in all experimental groups.

In a study carried out in the US and Canada, 15% of new intramammary infections post-partum were due to CNS (Dingwell et al., 2004). In an earlier Canadian study, quarter prevalence of CNS infections ranged from 5% to 6% during early lactation and increased from 14% to 17%

towards the end of lactation (Davidson et al., 1992). In a survey from Estonia, 16% of the quarters positive for bacterial growth harbored CNS (Haltia et al., 2006). The highest prevalence of intramammary infections with CNS and *S. aureus* was reported in Finland, where CNS and *S. aureus* were isolated from 50% of the positive quarters.

CONCLUSION

It can be therefore concluded that repeat parenteral administration of the product containing vitamin E and Se to pregnant dairy cows showed a positive effect on the increase of α -tocopherol and Se concentrations in blood plasma and in colostrum on the day of parturition as well as the reduction of clinical forms of mastitis but it does not affect the presence of bacterial agents in milk obtained from mastitis suffering cows. The data obtained in this study also suggest that duration of higher plasma Se and α -tocopherol concentrations after repeat administration is relatively short and do not affect on their transmission into the milk.

REFERENCES

- AOAC. 1995. *Department of Population Medicine, University of Guelph, Ontario, Canada, Association of Official Analytical Chemists*. Official Methods of Analysis, 16th ed; AOAC: Arlington VA, USA.
- Balicka-Ramisz, A., Jastrzębski, G. 2014. Effect of selenium on the development of selected indicators of fertility in dairy cows. *Veterinary World*, vol. 7, no. 10, p. 863-867. <http://dx.doi.org/10.14202/vetworld.2014.863-867>
- Bouwstra, R. J., Nielen, M., Stegeman, J. A., Dobbelaar, P., Newbold, J. R., Jansen, E. H., Van Werven, T. 2010. Vitamin E supplementation during the dry period in dairy cattle. Part I: adverse effect on incidence of mastitis postpartum in a double-blind randomized field trial. *Journal of Dairy Science*, vol. 93, no. 12, p. 5684-5695. <https://doi.org/10.3168/jds.2010-3159> PMID:21094740
- Davidson, T. J., Dohoo, I. R., Donald, A. W., Hariharan, H., Collins, K. 1992. A cohort study of coagulase negative staphylococcal mastitis in selected dairy herds in Prince Edward Island. *Canadian Journal of Veterinary Research*, vol. 56, no. 4, p. 275-280. PMID:1477796
- Dingwell, R. T., Leslie, K. E., Schukken, Y. H., Sargeant, J. M., Timms, L. L., Duffield, T. F., Keefe, G. P., Kelton, D. F., Lissemore, K. D., Conklin, J. 2004. Association of cow and quarter-level factors at drying-off with new intramammary infections during the dry period. *Preventive Veterinary Medicine*, vol. 63, no. 1-2, p. 75-89. <https://doi.org/10.1016/j.prevetmed.2004.01.012> PMID:15099718
- Djabri, B., Bareille, N., Beaudeau, F., Seegers, H. 2002. Quarter milk somatic cell count in infected dairy cows: a meta-analysis. *Veterinary Research*, vol. 33, no. 2002, p. 335-357. <https://dx.doi.org/10.1051/vetres:2002021>
- Gunter, S. A., Beck, P. A., Phillips, J. M. 2003. Effects of supplementary selenium source on the performance and blood measurements in beef cows and their calves. *Journal of Animal Science*, vol. 81, no. 4, p. 856-864. <https://doi.org/10.2527/2003.814856x> PMID:12723072
- Hall, J. A., Bobe, G., Vorachek, W. R., Kasper, K., Traber, M. G., Mosher, W. D., Pirelli, G. J., Gamroth, M. 2014. Effect of supranutritional organic selenium supplementation on postpartum blood micronutrients, antioxidants, metabolites, and inflammation biomarkers in selenium-replete dairy cows. *Biological Trace Element Research*, vol. 161, no. 3, p. 272-287. <http://dx.doi.org/10.1007/s12011-014-0107-4>
- Haltia, L., Honkanen-Buzalski, T., Spiridonova, I., Olkonen, A., Myllys, V. 2006. A study of bovine mastitis, milking procedures and management practices on 25 Estonian dairy herds. *Acta Veterinaria Scandinavica*, vol. 48, p. 22. <https://doi.org/10.1186/1751-0147-48-22> PMID:17118211
- Hess, D., Keller, H. E., Oberlin, B., Bonfanti, R., Schüep, W. 1991. Simultaneous determination of retinol, tocopherols, carotenes and lycopene in plasma by means of high-performance liquid chromatography on reversed phase. *International Journal for Vitamin and Nutrition Research*, vol. 61, no. 3, p. 232-238. [https://doi.org/10.1016/S0076-6879\(99\)99035-3](https://doi.org/10.1016/S0076-6879(99)99035-3)
- Horký, P. 2014. Effect of protein concentrate supplement on the qualitative and quantitative parameters of milk from dairy cows in organic farming. *Annals of Animal Science*, vol. 14, no. 2, p. 341-352. <http://dx.doi.org/10.2478/aoas-2014-0008>
- Horký, P., Ruttkay-Nedecky, B., Kremplöva, M., Krystofova, O., Kensova, R., Hynek, D., Babula, P., Zitka, O., Zeman, L., Adam, V., Kizek, R. 2013. Effect of different doses of organically bound selenium on antioxidant status and levels of metal ions in postpartum sows. *International Journal of Electrochemical Science*, vol. 8, p. 6162-6179.
- Jackson, P., Cockcroft, P. 2002. *Clinical Examination of Farm Animals*. Oxford, UK : Blackwell Science Ltd, Wiley-Blackwell, p. 154-166. ISBN 0-632-05706-8. <https://doi.org/10.1002/9780470752425>
- Kafilzadeh, F., Kheirmanesh, H., Karami Shabankareh, H., Targhibi, M. R., Maleki, E., Ebrahimi, M., Yong Meng, G. 2014. Comparing the effect of oral supplementation of vitamin e, injective vitamin e and selenium or both during late pregnancy on production and reproductive performance and immune function of dairy cows and calves. *Scientific World Journal*, vol. 2014. <https://doi.org/10.1155/2014/165841> PMID:25045726
- Lacetera, N., Bernabucci, U., Ronchi, B., Nardone, A. 1996. Effects of selenium and vitamin E administration during a late stage of pregnancy on colostrum and milk production in dairy cows, and on passive immunity and growth of their offspring. *American Journal of Veterinary Research*, vol. 57, no. 12, p. 1776-1780. PMID:8950434
- Meglia, G. E., Jensen, S. K., Lauridsen, C., Persson Waller, K. 2006. Alpha-tocopherol concentration and stereoisomer composition in plasma and milk from dairy cows fed natural or synthetic vitamin E around calving. *Journal of Dairy Research*, vol. 73, no. 2, p. 227-234. <https://doi.org/10.1017/S0022029906001701> PMID:16774694
- Mehdi, Y., Hornick, J. L., Istasse, L., Dufresne, I. 2013. Selenium in the environment, metabolism and involvement in body functions. *Molecules*, vol. 18, no. 3, p. 3292-3311. <https://doi.org/10.3390/molecules18033292> PMID:23486107
- Meyer, U., Heerdegen, K., Schenkel, H., Dänicke, S., Flachowsky, G. 2014. Influence of various selenium sources on selenium concentration in the milk of dairy cows. *Journal für Verbraucherschutz und Lebensmittelsicherheit*, vol. 9, no. 2, p. 101-109. <https://doi.org/10.1007/s00003-014-0870-3>
- Mohri, M., Seifi, H. A., Khodadadi, J. 2005. Effects of preweaning parenteral supplementation of vitamin E and selenium on hematology, serum proteins, and weight gain in dairy calves. *Comparative Clinical Pathology*, vol. 14, no. 3, p. 149-154. <https://doi.org/10.1007/s00580-005-0581-3>

- Oltramari, C. E., Pinheiro, M. G., De Miranda, M. S., Arcaro, J. R. P., Castelani, L., Toledo, L. M., Ambrósio, L. A., Leme, P. R., Manella, M. Q., Arcaro Jr., I. 2014. Selenium sources in the diet of dairy cows and their effects on milk production and quality, on udder health and on physiological indicators of heat stress. *Italian Journal of Animal Science*, vol. 13, no. 1, p. 48-52. <https://doi.org/10.4081/ijas.2014.2921>
- Pavlata, L., Illek, J., Pechová, A., Matějčíček, M. 2002. Selenium status of cattle in the Czech Republic. *Acta Veterinaria Brno*, vol. 71, no. 1, p. 3-8. <https://doi.org/10.2754/avb200271010003>
- Pavlata, L., Misurova, L., Pechova, A., Husakova, T., Dvorak, R. 2012. Direct and indirect assessment of selenium status in sheep – a comparison. *Veterinární Medicína*, vol. 57, no. 5, p. 219-223.
- Pavlata, L., Podhorsky, A., Pechova, A., Dvorak, R. 2005. Incidence of hypovitaminosis E in calves and therapeutic remedy by selenium-vitamin supplementation. *Acta Veterinaria Brno*, vol. 74, p. 209-216. <https://doi.org/10.2754/avb200574020209>
- Pavlata, L., Prasek, J., Filipek, A., Pechova, A. 2004. Influence of parenteral administration of selenium and vitamin E during pregnancy on selected metabolic parameters and colostrum quality in dairy cows at parturition. *Veterinární Medicína*, vol. 49, no. 5, p. 149-155.
- Pechova, A., Pavlata, L., Illek, J. 2005. Blood and tissue selenium determination by hydride generation atomic absorption spectrophotometry. *Acta Veterinaria Brno*, vol. 74, p. 483-490. <https://doi.org/10.2754/avb200574040483>
- Pechova, A., Sevcikova, L., Pavlata, L., Dvorak, R. 2012. The effect of various forms of selenium supplied to pregnant goats on selected blood parameters and on the concentration of se in urine and blood of kids at the time of weaning. *Veterinární Medicína*, vol. 57, no. 8, p. 394-403.
- Persson, W. K., Sandgren, C. H., Emanuelson, U., Jensen, S. K. 2007. Supplementation of RRR- α -tocopheryl acetate to periparturient dairy cows in commercial herds with high mastitis incidence. *Journal of Dairy Science*, vol. 90, no. 8, p. 3640-3646. <https://doi.org/10.3168/jds.2006-421> [PMid:17638974](https://pubmed.ncbi.nlm.nih.gov/17638974/)
- Pilarczyk, B., Pilarczyk, R., Tomza-Marciniak, A., Kowieska, A., Wójcik, J., Sablik, P., Tylkowska, A., Hendzel, D. 2011. Selenium concentrations in the serum and milk of cows from organic and conventional farms in west pomerania. *Tierärztliche Umschau*, vol. 66, p. 248-253.
- Politis, I. M., Hidioglou, J. H., White, J., Gilmore, S. N., Williams, H., Scherf, H., Frigg, M. 1996. Effects of vitamin E on mammary and blood leukocyte function with emphasis on chemotaxis in periparturient dairy cows. *American Journal of Veterinary Research*, p. vol. 57, no. 4, p. 468-471.
- Scholz, H., Stöber, M. 2002. Enzootische myodystrophie des präruminanten Kalbes. [Enzootic myodystrophia in preruminant calves]. In: Dirksen G., Gründer H. D., Stöber M. (eds.). *Innere Medizin und Chirurgie des Rindes. [Internal Medicine and Surgery of Cattle]*. Berlin, Germany : Parey. p. 1000-1004. ISBN 978-3-8304-4169-4.
- Van Soest, P. J., Robertson, J. B., Lewis, B. A. 1991. Methods for dietary fiber, neutral detergent fiber and non-starch polysaccharides in relation to animal nutrition. *Journal of Dairy Science*, vol. 74, no. 10, p. 3583-3597. [https://doi.org/10.3168/jds.S0022-0302\(91\)78551-2](https://doi.org/10.3168/jds.S0022-0302(91)78551-2)
- Vasil', M., Elečko, J., Farkašová, Z., Zigo, F. 2012. Diagnostic importance of the concentration of milk amyloid A in quarter milk samples from dairy cows with mastitis. *Acta Veterinaria Brno*, vol. 81, p. 133-138. <https://doi.org/10.2754/avb201281020133>
- Vautor, E., Cockfield, J., Le Marechal, C., Le Loir, Y., Chevalier, M., Robinson, A. D., Thiery, R., Lindsay, J. 2009. Difference in virulence between *Staphylococcus aureus* isolates causing gangrenous mastitis versus subclinical mastitis in a dairy sheep flock. *Veterinary Research*, vol. 40, no. 6, p. 56. <https://doi.org/10.1051/vetres/2009039> [PMid:19576164](https://pubmed.ncbi.nlm.nih.gov/19576164/)

Acknowledgments:

This work was supported by grant VEGA No. 1/0510/16.

Contact address:

MVDr. František Zigo, PhD., Department of Animal Husbandry, UVLF, Komenského 73, 041 81 Košice, E-mail: frantisek.zigo@uvlf.sk

Doc. MVDr. Milan Vasil', CSc., Department of Animal Husbandry, UVLF, Komenského 73, 041 81 Košice, tel: +421 55 2982 630, E-mail: milan.vasil@uvlf.sk

MVDr. Zuzana Farkašová, PhD., Department of Animal Husbandry, UVLF, Komenského 73 041 81, Košice, E-mail: zuzana.farkasova@uvlf.sk

MVDr. Martina Zigová, PhD., Department of Pharmacology, Pavol Jozef Šafárik University of Košice, Šrobárova 1014/2, 040 01 Košice E-mail: chripkova.martina@gmail.com

MVDr. Juraj Elečko, CSc., Department of Animal Husbandry, UVLF, Komenského 73, 041 81 Košice, E-mail: juraj.elecko@uvlf.sk

EVALUATION AND COMPARISON OF THE CONTENT OF TOTAL POLYPHENOLS AND ANTIOXIDANT ACTIVITY IN GARLIC (*ALLIUM SATIVUM* L.)

Marianna Lenková, Judita Bystrická, Alena Vollmannová, Tomáš Tóth, Ján Kovarovič

ABSTRACT

Garlic (*Allium sativum* L.) is one of the oldest cultivated plants in the world and highly valued throughout the ages as a culinary spice. It is a hardy perennial belonging to the *Alliaceae* family. The garlic bulb is the most commonly used portion of the plant, composed of 5 – 20 individual. It is a very good source of manganese, selenium, vitamin C and vitamin B6 (pyridoxine). In addition, garlic is a good source of other minerals, including phosphorous, calcium, potassium, iron and copper. Many of the perceived therapeutic effects of garlic are thought to be due to its active ingredient allicin. This sulphur-containing compound gives garlic its distinctive pungent smell and taste. Garlic possesses antiviral, antibacterial, anti-fungal properties allowing it to stand against all infections. This work has focused on the evaluation and comparison of total content of polyphenols and antioxidant activity in five varieties of garlic – Mojmír, Záhorský, Lukan, Havran and Makoi. Samples of plant material were collected at the stage of full maturity in the area of Nitra. The total content of polyphenols was determined using the spectrophotometric method of Folin-Ciocalteu agents. Determined the content of total polyphenols in garlic were in the range 621.13 mg.kg⁻¹ (Záhorský) to 763.28 mg.kg⁻¹ (Havran). Total polyphenols content in garlic declined in the following order: Havran >Mojmír >Makoi >Lukan >Záhorský. Antioxidant activity was measured by the spectrophotometric method using a compound DPPH (2,2-diphenyl-1-picrylhydrazyl). Statistically significant highest value of antioxidant was recorded in 20.22% (Mojmír) and the lowest value was in 13.61% (Záhorský). The values of antioxidant activity observed in the varieties of garlic may be arranged as follows: Mojmír >Havran >Lukan >Makoi >Záhorský. In all the analysed varieties of garlic was confirmed by the strong dependence of the antioxidant activity and the total content of polyphenols.

Keywords: antioxidant activity; garlic; total polyphenols

INTRODUCTION

Fruits and vegetables have historically been considered rich sources of some essential dietary micronutrients and fibers, and more recently they have been recognized as important sources for a wide array of phytochemicals that individually, or in combination, may benefit health (Elhamidi, 2010). Epidemiological studies have indicated that the consumption of vegetables is associated with a reduced risk for the development of chronic diseases, such as cardiovascular disease and cancer (Yang et al., 2004). Genus *Allium* is characterized by large number of primary and secondary types of nutritional and medicinal components (Rizwani and Shareef, 2011) and contains a number of pharmacological effects, including chemopreventive activity and tumor cell growth inhibition (Vlase et al., 2013). *Allium* species, the most important genus of the *Alliaceae* family, are among the oldest

cultivated vegetables. They have been used as ornamentals, spices, vegetables, or as medicines for curing various diseases (Tepe et al., 2005). The *Allium* genus includes more than 800 species widely distributed all over the world (Fritsch et al., 2010) and appreciated due to their flavour, easy growth and long storage time. The species may differ in form and taste, but they are close in biochemical and phytochemical contents (Lanzotti, 2006). Garlic (*Allium sativum* L.) and onion (*Allium cepa* L.) are the most important *Allium* species consumed all over the world (Kim et al., 2004). The genus is characterized by having bulbs enclosed in membranous tunics. Most species produce remarkable amounts of cysteine sulphoxides causing the well-known characteristic aroma and taste. The genus is naturally distributed in southwest and central Asia, in Europe and North America. *Allium* includes some economically important species like common onion, garlic,

chives, leek and also species used as herbal crops, as traditional medicines and as ornamental plants (Fritsch and Friesen, 2002).

Garlic (*Allium sativum* L.) is a plant which has been grown for more than 5000 years for culinary and therapeutic purposes. Bulb is used for its medical properties, which is formed of several cloves, wrapped in individual membrane (Trifunski et al., 2015). The importance of garlic has already been recognized in early Egyptian, Chinese and Indian civilizations centuries ago as an herbal or traditional medicine. Today, in many parts of the world garlic is being used as prophylaxis and for the cure of numbers of diseases including acute and chronic infections like pneumonia, dysentery, typhoid fever, cholera, gastritis, tuberculosis, diabetes mellitus, heart disease and hypertension (Srivastava and Pathak, 2012). Garlic is a source of various biologically active phytochemicals, including organosulfur compounds, polyphenolics (phenolic acid, flavonoids) and vitamins. The health properties of garlic depend on its bioactive compounds and particularly on phenolic compounds. Garlic is used to protect humans against oxidative stress (Chen et al., 2013).

Polyphenols are bioactive substances widely distributed in natural products. They have been reported to have multiple biological properties, such as antioxidant, antimutagenic, antibacterial, antiviral and anti-inflammatory activities. Medicinal plants rich in polyphenols can retard the oxidative degradation of lipids and improve the quality and nutritional value of food (Vlase et al., 2013). More than 8000 phenolic structures are currently known, and among them over 4000 flavonoids have been identified. Polyphenols have been classified by their source of origin, chemical structure and biological function. The majority of polyphenols in plants exist as glycosides with different sugar units and acylated sugars at different positions of the polyphenol skeletons. Distribution of polyphenols according to the chemical structures: phenolic acids, flavonoids, polyphenolic amides, other polyphenols (Tsao, 2010). Flavonoids can be classified in different subclasses (flavones, flavanones, flavonols, isoflavones, flavanonols, flavanols, chalcones and anthocyanins) according to the degree of unsaturation and degree of oxidation of the 3-carbon skeleton. Subclasses of flavonoids can be further differentiated on the basis of the number and nature of substituent groups attached to the rings. Flavonols and anthocyanins are the main subclasses of flavonoids present in genus *Allium* (Pérez-Gregorio et al., 2009).

An antioxidant can be defined as: "any substance that when present in low concentrations compared to that of an oxidisable substrate significantly delays or inhibits the oxidation of that substrate" (Young and Woodside, 2001). There are two major groups of antioxidants: enzymatic antioxidants and non-enzymatic antioxidants. These groups are divided into several subgroups. The enzymatic antioxidants are divided into primary and secondary enzymatic defenses. The primary defense is composed of three important enzymes that prevent the formation of and neutralize free radicals: glutathione peroxidase, catalase, superoxide dismutase. The secondary enzymatic defense includes glutathione reductase and glucose-6-phosphate dehydrogenase. The group of non-enzymatic antioxidants

contains several subgroups, the main ones being: vitamins (A, E, C), enzyme cofactors (Q10), minerals (zinc and selenium), peptides (glutathione), phenolic acids, and nitrogen compounds (uric acid) (Shebis et al., 2013). The antioxidants protect against oxidative stress, causing serious damage to the cells, resulting in various human diseases such as Alzheimer's disease, Parkinson's disease, atherosclerosis, cancer, arthritis, immunological disorders and neurodegenerative the failure (Shalaby and Shanab, 2013). The aim was to determine and compare the content of total polyphenols and antioxidant activity in 5 varieties of garlic (*Allium sativum* L.).

MATERIAL AND METHODOLOGY

The local climate conditions

This study was performed in area of Nitra, Slovak Republic. She is situated on the southern Slovakia. Nitra belongs to warmer areas in Slovakia. Nitra has very good natural and climatic conditions for crop growth, without any adverse effects. The average annual rainfall is 550 – 600 mm and the average annual temperature is 9.9 °C.

Samples of plant material

The samples of plant material – garlic (Mojmír, Záhorský, Lukan, Havran and Makoi) were collected in the phase of full ripeness from area of Nitra. For analysis was used fresh material soil samples and plant, samples were analysed by selected methodologies (determination of total polyphenols and antioxidant activity). All samples of plant material were grown under the same conditions. The soil samples from the area, where was grown plant material, was analysed (Table 1 and Table 2). The analysis of soil samples was carried out four times in four sampling sites. Only NPK fertilization (200 g per m²) was used for the achievement of favourable soil macroelements content.

Preparations of samples

Extract was prepared from the 25 g samples garlic, which were shaken (shaker GFL 3006, 125 rpm) in 50 ml of 80% ethanol for sixteen hours. Samples were kept at laboratory room temperature in dark conditions until the analysis. Each determination was carried out in six replications.

Determination of total polyphenols

Total polyphenols content (TPC) was determined by the method according to Lachman et al. (2003). It is expressed as mg of gallic acid equivalent per kg of fresh matter. Total polyphenols content was determined using the Folin-Ciocalteu reagent. 2.5 mL of Folin-Ciocalteu reagent was added to 100 µL extract to volumetric flask. The content was mixed. After 3 minutes, 5 mL 20% solution of sodium carbonate was added. Then the volume was adjusted to 50 mL with distilled water. After 2 hours, the samples were centrifuged (centrifuges UNIVERSAL 320, 15000 rpm) for 10 minutes. The absorbance was measured of the spectrophotometer Shimadzu UV/VIS – 1240 at 765 nm. The concentration of polyphenols was calculated from a standard curve with known concentration of gallic acid.

Table 1 Agrochemical characteristic of soil substrate in mg.kg⁻¹, content of nutrients from locality Nitra.

Vegetable	K	Ca	Mg	P	pH _{KCl}	Humus %	Cox %
garlic	392 ±4.67	3861.7 ±2.15	1312.3 ±0.98	97.4 ±3.61	6.91 ±0.073	2.9 ±0.026	1.68 ±0.011

Table 2 Content of heavy metals (mg.kg⁻¹) in soil substrate (extraction by aqua regia).

Vegetable	Zn	Cu	Ni	Pb	Cd
garlic	55.7 ±2.03	27.1 ±1.43	42.3 ±1.87	40.7 ±1.69	4.04 ±0.042
Limit *	150	60	50	70	0.7

* Limit value for aqua regia – Law No. 220/2004.

Determination of antioxidant activity

Antioxidant activity (AOA) was measured according to **Brand-Williams et al. (1995)**. The method is based on using DPPH[·] (2,2-diphenyl-1-picrylhydrazyl). DPPH[·] (3.9 ml) was pipetted into the cuvette and the absorbance was measured using the spectrophotometer Shimadzu UV/VIS – 1240 at 515.6 nm. The measured value corresponds to the initial concentration of DPPH[·] solution at the time A₀. Then 0.1 cm³ extract was added to start measuring dependence A = f*(t). The content of cuvette was mixed and the absorbance was measured at 1, 5 and 10 minutes in the same way as DPPH solution. The percentage of inhibition expresses how antioxidant compounds are able to remove DPPH[·] radical at the given period of time. Inhibition (%) = (A₀ - A_t / A₀) x 100

Statistical analysis

Results were statistically evaluated by the Analysis of Variance (ANOVA – Multiple Range Tests, Method: 95.0 percent LSD). It was used by the statistical software STATGRAPHICS (Centurion XVII, USA).

RESULTS AND DISCUSSION

The total content of polyphenols in the studied samples are presented in Table 3. The total content of polyphenols of the samples is varied from 621.13 ±4.45 to 763.28 ±3.60 mg.kg⁻¹ and statistically significant differences in the strength of total polyphenols content were also detected among analysed crops. The highest value of total polyphenols was observed in Havran. The lowest level of total polyphenols was measured in Záhorský. In Havran average level of total polyphenols is 1.22-times higher than in Záhorský and 1.09-times higher than in Mojmír. According to determined values of TPC the analysed samples of garlic can be arranged in the following order: Havran >Mojmír >Makoi >Lukan >Záhorský. **Charles (2013)** indicated highest total polyphenol content in garlic is 812 mg.kg⁻¹. In comparison with this study highest content of TPC in garlic (780 mg.kg⁻¹) was measured by **Batcioglu et al. (2012)** as well as by. Some authors reported even a lower value of TPC in garlic: 410 mg.kg⁻¹ (**Wangcharoen and Morasuk, 2007**), 436 mg.kg⁻¹ (**Chekki et al., 2014**), 493 mg.kg⁻¹ (**Jastrzebski et al.,**

Table 3 Average content of total polyphenols (mg.kg⁻¹) and antioxidant activity (% inhibition).

Vegetable	Variety	TPC	AOA
Garlic	Mojmír	698.82 ±3.43 ^c	20.22 ±0.62 ^d
	Záhorský	621.13 ±4.45 ^a	13.61 ±0.38 ^a
	Lukan	628.76 ±8.61 ^a	15.25 ±0.40 ^b
	Havran	763.28 ±3.60 ^d	16.52 ±0.32 ^c
	Makoi	678.18 ±6.43 ^b	13.71 ±0.35 ^a
	HD _{0.05}	8.52866	0.646596
	HD _{0.01}	11.7908	0.893914

Note: Multiple Range Tests, Method: 95.0 percent LSD, Different letters (a, b, c and d) between the factors show statistically significant differences (p <0.05) – LSD test, TPC – total polyphenols content, AOA – antioxidant activity.

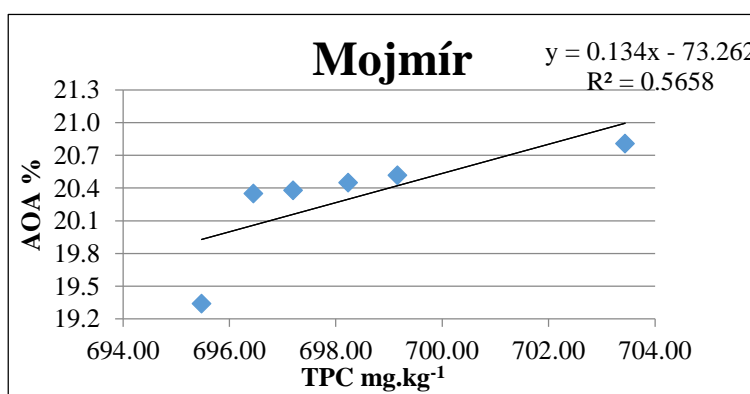

Figure 1 Relationship between TPC and AOA in Mojmír.

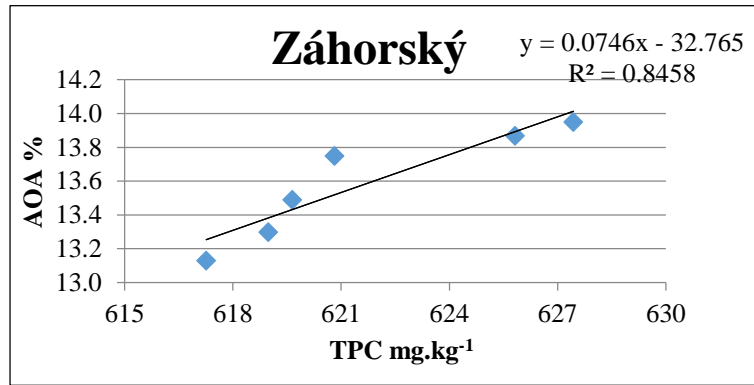

Figure 2 Relationship between TPC and AOA in Záhorský.

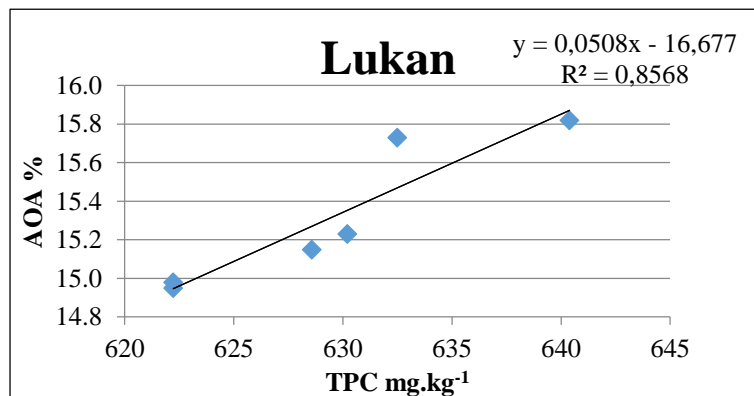

Figure 3 Relationship between TPC and AOA in Lukan.

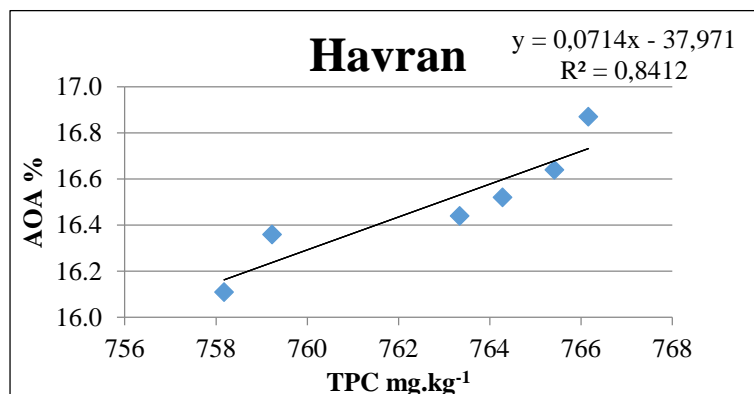

Figure 4 Relationship between TPC and AOA in Havran.

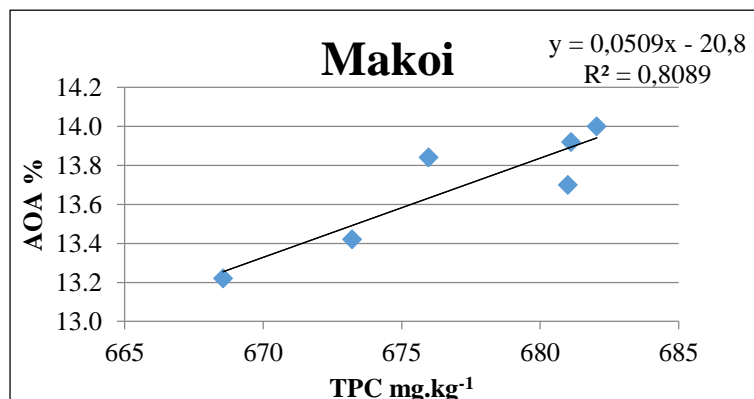

Figure 5 Relationship between TPC and AOA in Makoi.

2007). By way of contrast Wangcharoen and Morasuk (2009) measured in another study higher level of TPC (1290 mg.kg⁻¹).

The values antioxidant activity in the samples ranges from 13.61 ±0.38% to 20.22 ±0.62% (Table 3). Statistically significant differences in the antioxidant

activity were detected among all analysed varieties of garlic. The highest value of antioxidant activity was measured in Mojmír. The lowest antioxidant activity was observed in Záhorský. In Mojmír average value of antioxidant activity is 1.49-times higher than in Záhorský and 1.22-times higher than in Havran. The determined quantity of antioxidant activity in the analysed samples can be arranged in the following order: Mojmír > Havran > Lukan > Makoi > Záhorský. **Elhamidi and Elshami (2015)** indicate that the values of the antioxidant activity of garlic move in wide range from 16.39% to 27.25%. **Chen et al. (2013)** provides a greater range of antioxidant activity of garlic, which in the wide range from 3.60% to 45.63%. **Charles (2013)** indicates that the value of the antioxidant activity of garlic is 15.5%, which good correlate with the results of this work.

Relations among the content of polyphenols and the antioxidant activity in analysed varieties of garlic (Mojmír, Záhorský, Lukan, Havran and Makoi) were evaluated (Figure 1 – 5). The coefficient of correlation ($r = 0.7522 - 0.9195$) confirmed strong dependency between the content of polyphenols and the antioxidant activity and the results are in good agreement with the findings of **Hu (2012)**, **Chekki et al. (2014)**, **Ramkissoo et al. (2012)** and **Chen et al. (2013)**, who also indicated correlations between antioxidant activity and content of polyphenols in garlic, onion and other vegetable.

CONCLUSION

The total content of polyphenols and antioxidant activity of different varieties of garlic (Mojmír, Záhorský, Lukan, Havran and Makoi), grow in locality Nitra were comparable with literature. The statistically significant differences in both the antioxidant activity and the total content of polyphenols were detected among all varieties of garlic (Mojmír, Záhorský, Lukan, Havran and Makoi). The highest value of total polyphenols was determined in Havran ($763.28 \text{ mg.kg}^{-1}$) and the highest level of antioxidant activity was found in Mojmír (20.22%). The lowest value of both followed indicators as well as determined in Záhorský (AOA -13.61%, TPC $-621.12 \text{ mg.kg}^{-1}$). The coefficient of correlation ($r = 0.7522 - 0.9195$) confirmed strong dependency between the total content of polyphenols and the antioxidant activity. Garlic should we include into our diet, it is an important raw material for our health, because they provide culinary, nutritional and health benefits.

REFERENCES

Act No. 220/2004 Coll. Of Laws of Slovak Republic. On the conservation and use of agricultural land, amending the Act No. 245/2003 Coll. on integrated pollution prevention and control, amending and supplementing of certain acts, as amended.

Batcioglu, K., Yilmaz, Z., Satilmis, B., Uyumlu, A. B., Erkal, H. S., Yucel, N., Gunals, S., Serin, M., Demirtas, H. 2012. Investigation of in vivo radioprotective and in vitro antioxidant and antimicrobial activity of garlic (*Allium sativum*). *European Review for Medical and Pharmacological Sciences*, vol. 16, suppl no. 3, p. 47-57. [PMid:22957418](https://pubmed.ncbi.nlm.nih.gov/22957418/)

Brand-Williams, W., Cuvelier, M. E., Berset, C. 1995. Use of a free radical method to evaluate antioxidant activity.

Lebensmittel-Wissenschaft and Technologie, vol. 28, no. 1, p. 25-30. [http://dx.doi.org/10.1016/S0023-6438\(95\)80008-5](http://dx.doi.org/10.1016/S0023-6438(95)80008-5)

Charles, D. J. 2013. Antioxidant Properties of Spices, Herbs and Other Sources. NY: Springer science. ISBN: 978-1-4614-4310-0.

Chekki, R. Z., Snoussi, A., Hamrouni, I., Bouzouita, N. 2014. Chemical composition, antibacterial and antioxidant activities of Tunisian garlic (*Allium sativum*) essential oil and ethanol extract. *Mediterranean Journal of Chemistry*, vol. 3, no. 4, p. 947-956. <http://dx.doi.org/10.13171/mjc.3.4.2014.09.07.11>

Chen, S., Shen, X., Cheng, S., Li, P., Du, J., Chang, Y., Meng, H. 2013. Evaluation of Garlic Cultivars for Polyphenolic Content and Antioxidant Properties. *Plos One*, vol. 8, no. 11, p. e79730. <http://dx.doi.org/10.1371/journal.pone.0079730>

Elhamidi, M. Y. 2010. The Contribution of Fruit and Vegetable Consumption to Human Health. In de la Rosa, L. A., Alvarez-Parrilla, E., González-Aguilar, G. A. *Fruit and Vegetable Phytochemicals: Chemistry, Nutritional value and Stability*. Wiley-Balwell, p. 3-53. ISBN: 978-0-8138-0320-3.

Elhamidi, M., Elshami, S. M. 2015. Scavenging Activity of Differnet Garlic Extracts and Garlic Powder and their Antioxidant Effect on Heated Sunflower Oil. *American Journal of Food Technology*, vol. 10, no. 4, p. 135-146. <http://dx.doi.org/10.3923/ajft.2015.135.146>

Fritsch, M. R., Friesen, N. 2002. *Evolution, domestication and taxonomy*. Wallingford UK : CABI Publishing. ISBN: 0851995101. <https://doi.org/10.1079/9780851995106.0005>

Fritsch, R. M., Blattner, F. R., Gurushidze, M. 2010. New classification of *Allium* L. subg. *Melanocrommyum* (Webb & Berthel) Rouy (*Alliaceae*) based on molecular and morphological characters. *Phyton*, vol. 49, no. 2, p. 145-220.

Hu, Ch. 2012. Factors affecting phytochemical composition and antioxidant activity of Ontario vegetable crops. Ontario Canada : Guelph. 208 p. <http://dx.doi.org/10.2144/3592>

Jastrzebski, Z., Leontowicz, H., Leontowicz, M., Namiesnik, J., Zachwieja, Z., Barton, H., Pawelzik, E., Arancibia-Avila, P., Toledo, F., Gorinstein, S. 2007. The bioactivity of processed garlic (*Allium sativum* L.) as shown in vitro and in vivo studies on rats. *Food and Chemical Toxicology*, vol. 45, no. 9, p. 1626-1633. <http://dx.doi.org/10.1016/j.fct.2007.02.028>

Kim, J. W., Huh, J. E., Kyung, S. H., Kyung, K. H. 2004. Antimicrobial activity of alk(en)yl sulfides found in essential oils of garlic and onion. *Food Science and Biotechnology*, vol. 13, no. 2, p. 235-239.

Lachman, J., Proněk, D., Hejtmanková, A., Dudjak, J., Pivec, V., Faitová, K. 2003. Total polyphenol and main flavonoid antioxidant in different onion (*Allium cepa* L.) varieties. *Horticultural Science*, vol. 30, no. 4, p. 142-147.

Lanzotti, V. 2006. The analysis of onion and garlic. *Journal of Chromatography A*, vol. 1112, no. 1-2, p. 3-22. <http://dx.doi.org/10.1016/j.chroma.2005.12.016>

Pérez-Gregorio, R. M., Garcia-Falcon, M. S., Simal-Gandara, J., Rodriguez, A. S., Almeida, D. P. F. 2009. Identification and quantification of flavonoids in traditional cultivars of red and white onions at harvest. *Journal of Food Composition and Analysis*, vol. 23, no. 6, p. 592-598. <http://dx.doi.org/10.1016/j.jfca.2009.08.013>

Ramkissoo, J. S., Mahomoodally, M. F., Ahmed, N., Subratty, A. H. 2012. Relationship between total phenolic content, antioxidant potencial, and antiglycation abilities of common culinary herbs and spices. *Journal of Medical Food*, vol. 15, no. 12, p. 1116-1123. <http://dx.doi.org/10.1089/JMF.2012.0113>

- Rizwani, G. H., Shareef, H. 2011. Genus *Allium*: The Potential Nutritive and Therapeutic Source. *Journal of Pharmacy and Nutrition Sciences*, vol. 1, no. 2, p. 158-165. <http://dx.doi.org/10.6000/1927-5951.2011.01.02.11>
- Shalaby, E. A., Shanab, S. M. M. 2013. Antioxidant compounds, assays of determination and mode of action. *African Journal of Pharmacy and Pharmacology*, vol. 7, no. 10, p. 528-539. <http://dx.doi.org/10.5897/AJPP2013.3474>
- Shebis, Y., Iluz, D., Kinel-Tahan, Y., Dubinski, Z., Yehoshua, Y. 2013. Natural Antioxidants: Function and Sources. *Food and Nutrition Sciences*, vol. 4, no. 6, p. 643-649. <http://dx.doi.org/10.4236/fns.2013.46083>
- Srivastava, S., Pathak, P. H. 2012. Garlic (*Allium sativum*) extract supplementation alters the glycogen deposition in liver and protein metabolism in gonads of female albino rats. *International Journal of Pharmaceutical Sciences and Drug Research*, vol. 4, no. 2, p. 126-129.
- Tepe, B., Sokmen, M., Akpulat, H., Sokmen, A. 2005. In vitro antioxidant activities of the methanol extract of five species from Turkey. *Food Chemistry*, vol. 92, no. 1, p. 89-92. <http://dx.doi.org/10.1016/j.foodchem.2004.04.030>
- Trifunski, S., Munteanu, M. F., Agotici, V., Pitea, S., Gligor, R. 2015. Determination of Flavonoid and Polyphenol Compounds in *Viscum Album* and *Allium sativum* Extract. *International Current Pharmaceutical Journal*, vol. 4, no. 5, p. 382-385. <http://dx.doi.org/10.3329/icpj.v4i5.22861>
- Tsao, R. 2010. Chemistry and Biochemistry of Dietary Polyphenols. *Nutrients*, vol. 2, no. 12, p. 1231-1246. <http://dx.doi.org/10.3390/nu2121231>
- Vlase, L., Parvu, M., Parvu, E. A., Toiu, A. 2013. Chemical Constituents of Three *Allium* Species from Romania. *Molecules*, vol. 18, no. 1, p. 114-127. <http://dx.doi.org/10.3390/molecules18010114>
- Wangcharoen, W., Morasuk, W. 2007. Antioxidant capacity and phenolic content of some Thai culinary plants. *Maejo International Journal of Science and Technology*, vol. 1, p. 100-106.
- Wangcharoen, W., Morasuk, W. 2009. Effect of heat treatment on the antioxidant capacity of garlic. *Maejo International Journal of Science and Technology*, vol. 3, no. 1, p. 60-70.
- Yang, J., Meyers, K. J., Van Der Heide, J., Liu, R. H. 2004. Varietal differences in phenolic content and antioxidant and antiproliferative activities of onions. *Journal of Agricultural and Food Chemistry*, vol. 52, no. 22, p. 6787-6793. <http://dx.doi.org/10.1021/JF0307144>
- Young, I. S., Woodside, J. V. 2001. Antioxidants in health and disease. *Journal of Clinical Pathology*, vol. 54, no. 3, p. 176-186. <http://dx.doi.org/10.1136/jcp.54.3.176>

Acknowledgement:

This work was supported by scientific grant VEGA 1/0290/14.

Contact address:

Marianna Lenková, Slovak University of Agriculture in Nitra, Faculty of Biotechnology and Food Sciences, Department of Chemistry, Tr. A. Hlinku 2, 949 76 Nitra, Slovakia, E-mail: mariannalenkova@gmail.com

Judita Bystrická, Slovak University of Agriculture in Nitra, Faculty of Biotechnology and Food Sciences, Department of Chemistry, Tr. A. Hlinku 2, 949 76 Nitra, Slovakia, E-mail: judita.bystricka@centrum.sk

Alena Vollmannová, Slovak University of Agriculture in Nitra, Faculty of Biotechnology and Food Sciences, Department of Chemistry, Tr. A. Hlinku 2, 949 76 Nitra, Slovakia, E-mail: alena.vollmannova@gmail.com

Tomáš Tóth, Slovak University of Agriculture in Nitra, Faculty of Biotechnology and Food Sciences, Department of Chemistry, Tr. A. Hlinku 2, 949 76 Nitra, Slovakia, E-mail: toth.tomas11@gmail.com

Ján Kovarovič, Slovak University of Agriculture in Nitra, Faculty of Biotechnology and Food Sciences, Department of Chemistry, Tr. A. Hlinku 2, 949 76 Nitra, Slovakia, E-mail: kovarovic.j@gmail.com



ASSESSMENT OF THE ANTIOXIDANT ACTIVITY AND CONTENT OF POLYPHENOLIC COMPOUNDS IN GRAPEVINE SEEDS

Lenka Tomášková, Jiří Sochor, Mojmír Baroň

ABSTRACT

Our work was focused on the study of the antioxidant properties of grapevine seeds. We monitored the grapevine seeds of 6 cultivars of *Vitis vinifera*, L. (Nativa, Kofranka, Blaufränkisch, Marlen, Cabernet Moravia and Italian Riesling). Antioxidant activity was determined by three principally different methods (DPPH, ABTS and FRAP), the content of the total polyphenolic compounds was determined by the Folin ciocalteu method, and the content of the total flavanols was determined by DMACA reagent (p-dimethylaminocinnamaldehyde). Results are presented as an equivalent of gallic acid in $\text{g}\cdot\text{L}^{-1}$, respectively were expressed as $\text{g}\cdot\text{L}^{-1}$ of catechin equivalents (DMACA method). The highest values of antioxidant activity were measured in the cultivar Nativa (DPPH – $7.75 \text{ g}\cdot\text{L}^{-1}$, ABTS – $4.888 \text{ g}\cdot\text{L}^{-1}$, FRAP – $4.25 \text{ g}\cdot\text{L}^{-1}$). Conversely, the lowest values of antioxidant activity were detected in the cultivar Kofranka (DPPH – $7.08 \text{ g}\cdot\text{L}^{-1}$, ABTS – $4.17 \text{ g}\cdot\text{L}^{-1}$, FRAP – $4.55 \text{ g}\cdot\text{L}^{-1}$). Cultivar Nativa also reached the highest content of flavonols ($3.77 \text{ g}\cdot\text{L}^{-1}$). The highest measured values of the content of total polyphenolic compounds were identified in the cultivar Cabernet Moravia ($15.2 \text{ g}\cdot\text{L}^{-1}$ of GAE). Conversely, the lowest values of the content of total polyphenolic compounds were detected in the cultivar Nativa ($8.04 \text{ g}\cdot\text{L}^{-1}$). Pearson correlation coefficients were calculated for the existing values between antioxidant activity (DPPH, ABTS, FRAP), contents of flavonols, and contents of total polyphenols. The highest correlation coefficient was found between the DPPH and ABTS methods; specifically, it was 0.857.

Keywords: antioxidant activity; flavonols; grapevine seeds; total polyphenolic compounds

INTRODUCTION

Worldwide, the grapevine (*Vitis vinifera*, L.) is one of the most frequently cultivated fruit species (Vršíč et al., 2011). In Europe, the total acreage of vineyards is approximately 4.5 million hectares (45,000 sq. km.), and the total volume of pomace produced is about 8 million tons. Recently, the attention of many researchers has been focused on the development of new technologies to enable a purposeful and efficient utilisation of this waste product. At present, the potential spectrum of grapevine pomace use is relatively wide. So, for example, this waste may be used as a feedstuff for farm animals (Besharati & Taghizadeh, 2009), to produce dietetic, top-quality grape seed oil (Shinagawa et al., 2015), and for the production of energy (Valente et al., 2015). The pomace may be also composted for application in horticulture (Dominguez et al., 2014), for grappa production (Da Porto, 2012), and for other purposes.

The aim of this study was to determine the antioxidant activity, the content of polyphenolic compounds, and the content of flavanols in grapevine seeds of 6 cultivars of *Vitis vinifera*, L. and discover connections among the values obtained.

MATERIAL AND METHODOLOGY

Biological samples

This experimental study was performed with the seeds of six grapevine (*Vitis vinifera* L.) cultivars, specifically Nativa, Kofranka, Blaufränkisch, Marlen, Cabernet Moravia, and Italian Riesling.

Chemicals

Chemicals used in this study were supplied by the firm Sigma Aldrich (Germany). The chemicals were: Deionised water, stable free radical DPPH•, cation radical ABTS•, methanol, acetic acid (0.2%), liquid nitrogen, TPTZ (2,4,6-tripyridyl-s-triazin), hydrochloric acid, FeCl₃, acetate buffer, sodium acetate, Folin-Ciocalteu reagent, sodium carbonate decahydrate (NaCO₃·10 H₂O), and p-dimethylaminocinnamaldehyde reagent (DMACA).

Method of sample preparation

The experimental material originated from grape pomace. To eliminate undesirable water residues, the grapevine seeds were screened and purified. Thereafter the seeds were crushed with liquid nitrogen in a mortar.

Subsequently, 10 g of the homogenate were quantitatively transferred into a volumetric flask. The extraction was performed in a dark and cool environment with 100 mL of 75% methanol using the shaker IKA KS 260 Basic (manufacturer: Merci, France) for a period of 5 days. Final extracts were centrifuged and transferred into vials and micro test tubes (manufacturer: Eppendorf, Germany). All of the following measurements were executed 3 times successively.

Estimation of antioxidant activity

Spectrophotometric measurements of antioxidant activity were carried out using the BS-400 automated chemical analyser (manufacturer: Mindray, Shenzhen City, China). Transfer of samples and reagents was provided by a robotic arm equipped with a dosing needle (error of dosage did not exceed $\pm 5\%$ m/v). Immediately after the addition of reagents or samples, cuvette contents were mixed in an automatic mixer with a stirrer.

Determination of Antioxidant Activity by the DPPH Method

This procedure was performed according to Sochor et al. (2010a). A 150 μL volume of reagent (0.095 mM 2,2-diphenyl-1-picrylhydrazyl \square DPPH \bullet) was incubated with 15 μL of the sample. Absorbance was measured at 505 nm for a period of 10 min.

Determination of Antioxidant Activity by the ABTS Test

The procedure for the determination of the antioxidant activity was performed according to Pohanka et al. (2012). A 150 μL volume of the ABTS reagent (7 mM 2,2'-azinobis-3-ethylbenzothiazoline-6-sulfonic acid) and 4.95 mM potassium peroxodisulphate were mixed with 3 μL of the sample. Absorbance was measured at 660 nm for a period of 10 min.

Determination of Antioxidant Activity by the FRAP Method

The procedure for this determination was performed according to (Sochor et al., 2010b). A 150 μL volume of reagent was injected into a plastic cuvette together with the subsequent addition of a 3 μL sample. Absorbance was also measured at 605 nm for a period of 10 min.

Estimation of the contents of total polyphenols

The Folin-Ciocalteu method, based on the reduction of a phosphotungsten-phosphomolybdate complex by phenols to blue reaction products, was used for the determination of phenolic compounds. A sample of 0.5 mL was pipetted into a cuvette and diluted with ACS water (1.5 mL). Subsequently, the Folin-Ciocalteu reagent (50 μL) was added, and the solution was incubated at 22 $^{\circ}\text{C}$ for 30 min. Absorbance was measured using a HELIOS Gama spectrometer at the wavelength $\lambda = 670$ nm against a blank sample. The absorbance was measured three times. Results were expressed as equivalents of gallic acid in $\text{g}\cdot 100\text{ g}^{-1}$. The method was calibrated on the known phenolic compound (gallic acid).

Estimation of total flavanols

Total flavanols were estimated using the p-dimethylaminocinnamaldehyde (DMACA) method (Li et al., 1996, McMurrough et al., 1996, Vivas, 1994). Compared to the widely-used vanillin method, a great advantage of this method is that there is no interference by anthocyanins. Furthermore, the method used provided higher sensitivity and better specificity. Wine (20 μL) was poured into a 1.5 mL Eppendorf tube, and 980 μL of DMACA solution (0.1% in 1 M HCl in MeOH) was added. The mixture was vortexed and allowed to react at room temperature for 12 min. The absorbance at 640 nm was then read against a blank sample prepared in a similar way but without DMACA. The concentration of total flavanols was then estimated from a calibration curve constructed by plotting known solutions of catechin (1 – 16 $\text{mg}\cdot\text{L}^{-1}$) against A640 ($r = 0.998$). The results were expressed as $\text{g}\cdot\text{L}^{-1}$ of catechin equivalents.

RESULTS

The antioxidant activity and contents of flavanols and total polyphenols were assessed by spectrophotometry. The results of the performed analyses were expressed as arithmetic means and as the standard deviations of three measurements. Correlations existing between the antioxidant parameters were expressed by means of Pearson's correlation coefficients.

Assessment of antioxidant activity

The assessment of antioxidant activity represents one of the possibilities how to determine contents of total antioxidant compounds (Rop et al., 2010, Sochor et al., 2010c). Unfortunately, there is no simple and universal method that can be used for a proper quantitative estimation of this activity (Rop et al., 2011, Sochor et al., 2011). For that reason, three principally different spectrophotometric methods were used to assess this parameter – DPPH, FRAP and ABTS. The results obtained were converted to equivalents of gallic acid that was used as a standard. These values are presented in $\text{g}\cdot\text{L}^{-1}$ of GAE (gallic acid equivalent).

Determination of Antioxidant Activity by the DPPH Method

As shown in Figure 1, the antioxidant activity was fairly uniform in all cultivars under study. The average value of antioxidant activity, as assessed by this method, was 7.75 $\text{g}\cdot\text{L}^{-1}$. The highest and the lowest values were recorded in the cultivars Nativa and Kofranka, respectively. The difference was 18.8%.

Assessment of antioxidant activity by the ABTS method

As shown in Figure 2, the antioxidant potential was also relatively uniform, with the highest value being recorded in the cultivar Nativa. The average value of antioxidant activity, as assessed by this method, was 4.888 $\text{g}\cdot\text{L}^{-1}$. The lowest value was recorded in the cultivar Marlen. In this case, the difference between both values was 20.6%.

Assessment of antioxidant activity by the FRAP method

As shown in Figure 3, the antioxidant activity was again relatively uniform in all cultivars under study. The average

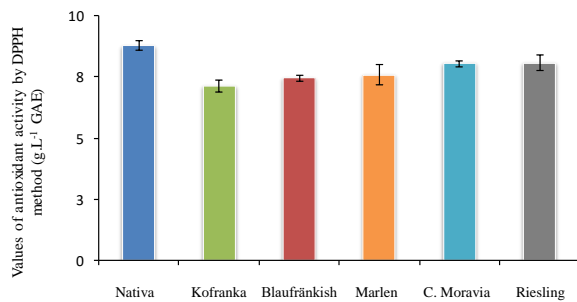

Figure 1 Results of the assessment of the antioxidant activity by the DPPH method in cultivars Nativa, Kofranka, Blaufränkish, Marlen, Cabernet Moravia and Italian Riesling. Results are presented as GAE in g.L⁻¹.

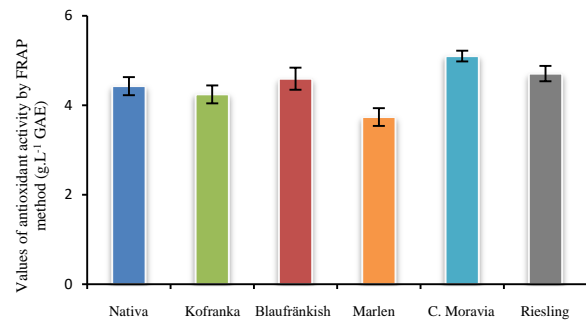

Figure 3 Results of the assessment of the antioxidant activity by the FRAP method in cultivars Nativa, Kofranka, Blaufränkish, Marlen, Cabernet Moravia and Italian Riesling. Results are presented as GAE in g.L⁻¹.

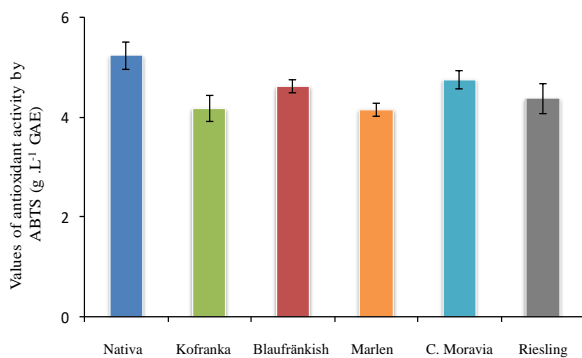

Figure 2 Results of the assessment of the antioxidant activity by the ABTS method in cultivars Nativa, Kofranka, Blaufränkish, Marlen, Cabernet Moravia and Italian Riesling. Results are presented as GAE in g.L⁻¹.

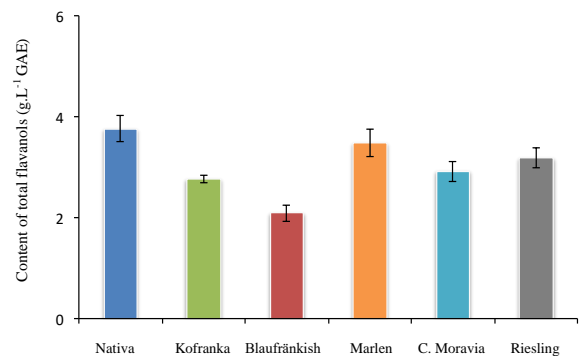

Figure 4 Results of the assessment of total flavanols in cultivars Nativa, Kofranka, Blaufränkish, Marlen, Cabernet Moravia and Italian Riesling. Results are presented as GAE in g.L⁻¹.

value of antioxidant activity, as assessed by this method, was 4.54 g.L⁻¹. The highest and the lowest values were recorded in the cultivars Cabernet Moravia and Marlen, respectively. The difference, 26.6%, was even greater.

Assessment of flavonols

Concentrations of total flavonols were assessed by means of the method based on the reaction of DMACA. In contradistinction to a widely-used method based on the reaction of flavonols with *s* vanillin, there was no interference by anthocyanins. Moreover, this method provided higher sensitivity and also better selectivity. Quercetin, myricetin, rutin and kaempferol are considered to be the most important flavonols that usually occur in wine.

The average content of the flavonols was 3.04 g.L⁻¹. The lowest and the highest contents of these compounds were found in the cultivars Blaufränkish (2.09 g.L⁻¹) and Nativa, (3.77 g.L⁻¹), respectively. In Blaufränkish, the content of flavonols was lower than in Nativa (by 44.6%).

Assessment of total polyphenols

Polyphenolic compounds represent one of the most abundant groups of antioxidants occurring in fruit (Paixao et al., 2007). Red wine is rich in polyphenols; their total contents range from 1,000 to 4,000 g.L⁻¹ (Li et al., 2009). As usual, the content of polyphenolic compounds can be quantified by colorimetric assays based on using the Folin-

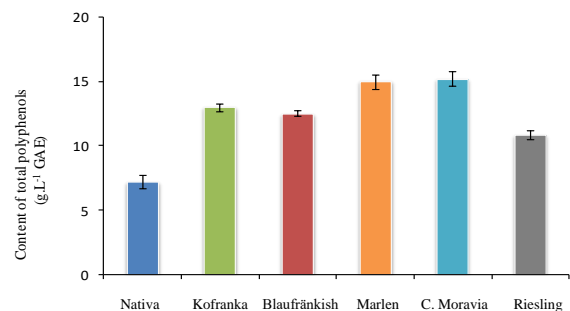

Figure 5 Results of the assessment of total polyphenols in cultivars Nativa, Kofranka, Blaufränkish, Marlen, Cabernet Moravia and Italian Riesling. Results are presented as GAE in mg.L⁻¹.

Ciocalteu reagent. This method is simple and is well reproducible, so it is widely used in biochemistry (Huang et al., 2005, Singleton et al., 1999).

In the cultivars under study, the average content of the total polyphenolic compounds was as follows: Nativa, 7.2 g.L⁻¹ of GAE; Kofranka, 12.9 g.L⁻¹ of GAE; Blaufränkish, 12.5 g.L⁻¹ of GAE; Marlen, 14.9 g.L⁻¹ of GAE, Cabernet Moravia, 15.2 g.L⁻¹ of GAE, and Italian Riesling, 10.8 g.L⁻¹ of GAE. The contents of the polyphenols were markedly different, and the highest and the lowest ones were found in Cabernet Moravia and in Nativa, respectively. The difference was 52.5%.

Table 1 Correlation coefficients among the values of antioxidant activity (DPPH, ABTS, FRAP), the contents of the flavonols, and the contents of total polyphenols.

	DPPH	ABTS	Flavanols	Polyphenols
FRAP	0.177	0.077	0.393	0.108
DPPH	x	0.857	0.311	0.724
ABTS	x	x	0.579	0.649
Flavanols	x	x	x	0.695

Note: The highest correlation coefficient was found between the DPPH and ABTS methods (0.857).

Correlations existing between antioxidant activity, the content of total polyphenols, and the contents of flavonols are presented in Table 1. For this determination was used Pearson correlation coefficient.

DISCUSSION

Songsermsakul et al. (2013) used the DPPH test in their study of antioxidant activities of extracts from grapevine seeds and from other fruits containing high amounts of caroten and vitamins C and E. The results obtained indicated that the antioxidant activity of a capsule containing 20 mg of grapevine extract was approximately 10 to 20 times higher than that of antioxidants contained in 1 g of tomato fruit, custard apple, banana, or the common mango. In spite of this, the consumption of fruit and vegetables seems to be the cheapest and most efficient way to supply antioxidants within the framework of healthy nutrition, primarily because the prices of dietary supplements are relatively high.

Using the DPPH method, **Soto et al. (2012)** estimated the antioxidant activity in flour from grapevine seeds (cereal sticks, pancakes, and noodles) of the cultivars Merlot and Cabernet Sauvignon. The highest value of antioxidant activity was determined in pancakes that contained flour made of Cabernet Sauvignon seeds. The second place was occupied by cereal sticks also containing Cabernet Sauvignon flour, and the third place by noodles made from Merlot seeds. During sensory evaluation, however, consumers preferred cereal sticks containing Merlot flour. From the general point of view, it is possible to conclude that in these cereal sticks, the ratio between high antioxidant activity and their acceptability for consumers was well balanced (**Soto et al., 2012**).

Values of antioxidant activity were assessed by DPPH and FRAP with Trolox as a standard antioxidant (**Rockenbach et al., 2011**). In 100 g of seeds, the cultivar Pinot Noir contained 16,925 mmol of Trolox equivalent (DPPH) and 21,492 mmol Fe²⁺ (FRAP), while the skins of the cultivar Isabel contained only 3,640 μmol TE·100 g⁻¹ and 4,362 μmol Fe²⁺·100 g⁻¹. In the skins of the cultivars Cabernet Sauvignon and Primitivo, the highest contents of anthocyanins were 935 and 832 mg·100 g⁻¹, respectively. The grapevine seed extract was rich both in oligomeric and polymeric flavanols.

Jakubcová et al. (2015) studied effect of phytochemical additives. Three additives (grapevine seeds, grape and rosehip pressings) were selected to be monitored. The extracts about concentrations of 1: 3 and 1: 5 were prepared from them. The monitoring of antimicrobial properties was focused on the pathogenic bacteria *Clostridium perfringens* and *Escherichia coli* causing a serious disease in avian species. Within the antioxidant analysis, the highest antioxidant activity was found out in

grapevine seeds (7.021 g.L⁻¹ GAE), which also contained the highest content of flavanols (3000 times higher than the rosehip pressings and 300 times higher than grapevine seeds pressings), hydroxycinnamic acids (1000 times higher than in grape pressings and 7600 times higher than in rosehip pressings) and the total content of polyphenolic compounds (580 times higher than grape pressings and 2000 times higher than the rosehip pressings) of the monitored additives.

Antioxidant activity, phenolic content and colour of the Slovak cabernet sauvignon wines were measured by **Bajcan et al. (2016)**. Twenty-eight Cabernet Sauvignon wine samples, originated from different Slovak vineyard regions, were analyzed using spectrophotometry for the content of total polyphenols, content of total anthocyanins, antioxidant activity and wine colour density. Determined values of antioxidant activity in observed wines were within the interval 69.0 – 84.2% inhibition of DPPH (average value was 78.8% inhibition of DPPH) and total polyphenol content ranged from 1,218 to 3,444 mg gallic acid per liter (average content was 2,424 mg gallic acid.L⁻¹). Determined total anthocyanin contents were from 68.6 to 430.7 mg.L⁻¹ (average content was 220.6 mg.L⁻¹) and values of wine colour density ranged from 0.756 to 2.782 (average value was 1.399).

Liang et al. (2016) studied beneficial effects of grape seed proanthocyanidin extract on arterial remodeling in spontaneously hypertensive rats via protecting against oxidative stress. Grape seed proanthocyanidin extract (GSPE) has been reported to exhibit a protective effect on cardiovascular disease. In the present study, the effects of GSPE on arterial remodeling were analyzed by treating spontaneously hypertensive rats (SHRs) with GSPE (250 mg.kg⁻¹.day⁻¹). Arterial remodeling was quantified through morphological methods; thoracic aortas were stained with hematoxylin-eosin or sirius red-victoria blue. The arterial ultrastructure was imaged using transmission electron microscopy. The content of nitric oxide (NO) and endothelin-1 (ET-1) were examined to determine endothelial function. Oxidative stress was assessed by malondialdehyde (MDA) levels and the activities of the antioxidant enzymes superoxide dismutase (SOD) and catalase (CAT). Administration of GSPE markedly alleviated hypertension-induced arterial remodeling, which was not associated with blood pressure control. ET-1 production was reduced, while NO production was increased in the GSPE group, which exhibited improved endothelial function. In addition, treatment with GSPE significantly ameliorated oxidative stress by improving SOD and CAT activities and reducing MDA formation.

Glyphosate impacts on polyphenolic composition in grapevine (*Vitis vinifera* L.) berries and wine studied **Donnini et al. (2016)**. In this study they tested, under field

conditions, the effects of glyphosate applications on the quality of berry and wine, from cv. Ancellotta (*Vitis vinifera* L.), with particular regard to anthocyanin concentration and composition. Datas suggest that treatment with glyphosate did not change the concentration of anthocyanins, other flavonoids and phenolic acids in the wine.

Identification of *Vitis vinifera* L. grape berry skin color mutants and polyphenolic profile was examined by Ferreira et al. (Ferreira et al., 2016). A germplasm set of twenty-five grapevine accessions, forming eleven groups of possible berry skin color mutants, were genotyped with twelve microsatellite loci, being eleven of them identified as true color mutants. Results showed differences in the contribution of malvidin-3-O-glucoside to the characteristic Pinot Noir anthocyanins profile. Regarding the two Pique-Poul colored variants, the lighter variant was richer than the darker one in all classes of compounds, excepting anthocyanins. In Moscatel Galego Roxo the F3'H pathway seems to be more active than F3'5'H, resulting in higher amounts of cyanidin, precursor of the cyanidin derivatives.

CONCLUSION

Seeds and their products are recommended for the prevention of many diseases. The issue of dealing with the analysis and comparison of antioxidant components in the seeds of interspecific varieties of *Vitis vinifera*, L. has not yet been sufficiently studied. Grape seeds have shown potential for the prevention and treatment of many diseases. This study showed a high antioxidant potential for grapevine seeds. The results presented corroborate that the content of antioxidant components in grapevine seeds was very high. Differences among the values of antioxidant activity in specific cultivars were not significant. Significant differences were found for the content of flavanols (Blaufränkish was lower than in Nativa by 44.6%) and polyphenolic compounds (Nativa was lower than Cabernet by 52.5%).

REFERENCES

Bajčan, D., Vollmannová, A., Šimanský, V., Bystrická, J., Trebichalský, P., Árvay, J., Czako, P. 2016. Antioxidant activity, phenolic content and colour of the slovak cabernet sauvignon wines. *Potravinárstvo*, vol. 10, no. 1, p. 89-84. <https://doi.org/10.5219/534>

Besharati, M., Taghizadeh, A. 2009. Evaluation of dried grape by-product as a tanniniferous tropical feedstuff. *Animal Feed Science and Technology*, vol. 152, no. 3-4, p. 198-203. <https://doi.org/10.1016/j.anifeedsci.2009.04.011>

Da Porto, C. 2012. Grappa: Production, sensory properties and market development. *Alcoholic Beverages: Sensory Evaluation and Consumer Research*, p. 299-314.

Domínguez, J., Martínez-Cordeiro, H., Álvarez-Casas, M., Lores, M. 2014. Vermicomposting grape marc yields high quality organic biofertiliser and bioactive polyphenols. *Waste Management & Research*, vol. 32, no. 12, p. 1235-1240. <https://doi.org/10.1177/0734242X14555805>
PMid:25349068

Donnini, S., Tessarin, P., Ribera-Fonseca, A., Di Foggia, M., Parpinello, G. P., Rombolá, A. D. 2016. Glyphosate impacts on polyphenolic composition in grapevine (*Vitis vinifera* L.) berries and wine. *Food Chemistry*, vol. 213, p. 26-30. <https://doi.org/10.1016/j.foodchem.2016.06.040>
PMid:27451151

Ferreira, V., Fernandes, F., Pinto-Carnide, O., Valentão, P., Falco, V., Martín, J. P., Ortiz, J. M., Arroyo-García, R., Andrade, P. B., Castro, I. 2016. Identification of vitis vinifera l. Grape berry skin color mutants and polyphenolic profile. *Food Chemistry*, vol. 194, p. 117-127. <https://doi.org/10.1016/j.foodchem.2015.07.142>
PMid:26471534

Huang, D. J., Ou, B. X., Prior, R. L. 2005. The chemistry behind antioxidant capacity assays. *Journal of Agricultural and Food Chemistry*, vol. 53, no. 6, p. 1841-1856. <https://doi.org/10.1021/jf030723c>
PMid:15769103

Jakubcová, Z., Horky, P., Dostalová, L., Sochor, J., Tomášková, L., Baroň, M., Kalhotka, L., Zeman, L. 2015. Study of antioxidant and antimicrobial properties of grapevine seeds, grape and rosehip pressing. *Potravinárstvo*, vol. 9, no. 1, p. 382-387. <https://doi.org/10.5219/503>

Li, H., Wang, X. Y., Li, Y., Li, P. H., Wang, H. 2009. Polyphenolic compounds and antioxidant properties of selected china wines. *Food Chemistry*, vol. 112, no. 2, p. 454-460. <https://doi.org/10.1016/j.foodchem.2008.05.111>

Li, Y. G., Tanner, G., Larkin, P. 1996. The dmaca-hcl protocol and the threshold proanthocyanidin content for bloat safety in forage legumes. *Journal of the Science of Food and Agriculture*, vol. 70, no. 1, p. 89-101. [https://doi.org/10.1002/\(SICI\)1097-0010\(199601\)70:1<89::AID-JSFA470>3.0.CO;2-N](https://doi.org/10.1002/(SICI)1097-0010(199601)70:1<89::AID-JSFA470>3.0.CO;2-N)

Liang, Y., Wang, J., Gao, H. Q., Wang, Q. Z., Zhang, J., Qiu, J. 2016. Beneficial effects of grape seed proanthocyanidin extract on arterial remodeling in spontaneously hypertensive rats via protecting against oxidative stress. *Molecular Medicine Reports*, vol. 14, no. 4, p. 3711-3718. <https://doi.org/10.3892/mmr.2016.5699>

McMurrough, I., Madigan, D., Smyth, M. R. 1996. Semipreparative chromatographic procedure for the isolation of dimeric and trimeric proanthocyanidins from barley. *Journal of Agricultural and Food Chemistry*, vol. 44, no. 7, p. 1731-1735. <https://doi.org/10.1021/jf960139m>

Paixão, N., Perestrelo, R., Marques, J. C., Câmara, J. S. 2007. Relationship between antioxidant capacity and total phenolic content of red, rose and white wines. *Food Chemistry*, vol. 105, no. 1, p. 204-214. <https://doi.org/10.1016/j.foodchem.2007.04.017>

Pohanka, M., Sochor, J., Ruttkay-Nedecký, B., Cernei, N., Adam, V., Hubálek, J., Stiborová, M., Eckschlager, T., Kizek, R. 2012. Automated assay of the potency of natural antioxidants using pipetting robot and spectrophotometry. *Journal of Applied Biomedicine*, vol. 10, no. 3, p. 155-167. <https://doi.org/10.2478/v10136-012-0006-y>

Rockenbach, I. I., Gonzaga, L. V., Rizelio, V. M., Gonçalves, A., Genovese, M. I., Fett, R. 2011. Phenolic compounds and antioxidant activity of seed and skin extracts of red grape (*Vitis vinifera* and *Vitis labrusca*) pomace from Brazilian winemaking. *Food Research International*, vol. 44, no. 4, p. 897-901. <https://doi.org/10.1016/j.foodres.2011.01.049>

Rop, O., Jurikova, T., Sochor, J., Mlcek, J., Kramarova, D. 2011. Antioxidant capacity, scavenging radical activity and selected chemical composition of native apple cultivars from central Europe. *Journal of Food Quality*, vol. 34, no. 3, p. 187-194. <https://doi.org/10.1111/j.1745-4557.2011.00387.x>

Rop, O., Mlcek, J., Jurikova, T., Valsikova, M., Sochor, J., Reznicek, V., Kramarova, D. 2010. Phenolic content, antioxidant capacity, radical oxygen species scavenging and lipid peroxidation inhibiting activities of extracts of five black chokeberry (*Aronia melanocarpa* (Michx.) Elliot) cultivars.

Journal of Medicinal Plants Research, vol. 4, no. 22, p. 2431-2437.

Shinagawa, F. B., De Santana, F. C., Mancini, J. 2015. Effect of cold pressed grape seed oil on rats' biochemical markers and inflammatory profile. *Revista De Nutricao-Brazilian Journal of Nutrition*, vol. 28, no. 1, p. 65-76. <https://doi.org/10.1590/1415-52732015000100006>

Singleton, V. L., Orthofer, R., Lamuela-Raventós, R. M. 1999. Analysis of total phenols and other oxidation substrates and antioxidants by means of folin-ciocalteu reagent. *Methods in Enzymology*, vol. 299, p. 152-178. [https://doi.org/10.1016/S0076-6879\(99\)99017-1](https://doi.org/10.1016/S0076-6879(99)99017-1)

Sochor, J., Ryvolova, M., Krystofova, O., Salas, P., Hubalek, J., Adam, V., Trnkova, L., Havel, L., Beklova, M., Zehnalek, J., Provaznik, I., Kizek, R. 2010a. Fully automated spectrometric protocols for determination of antioxidant activity: Advantages and disadvantages. *Molecules*, vol. 15, no. 12, p. 8618-8640. <https://doi.org/10.3390/molecules15128618> PMID:21116230

Sochor, J., Salas, P., Zehnálek, J., Krska, B., Adam, V., Havel, L., Kizek, R. 2010b. An assay for spectrometric determination of antioxidant activity of a biological extract. *Listy Cukrovarnické a Reparské*, vol. 126, p. 416-417.

Sochor, J., Skutkova, H., Babula, P., Zitka, O., Cernei, N., Rop, O., Krska, B., Adam, V., Provaznik, I., Kizek, R. 2011. Mathematical evaluation of the amino acid and polyphenol content and antioxidant activities of fruits from different apricot cultivars. *Molecules*, vol. 16, no. 9, p. 7428-7457. <https://doi.org/10.3390/molecules16097428> PMID:21886093

Sochor, J., Zitka, O., Skutkova, H., Pavlik, D., Babula, P., Krska, B., Horna, A., Adam, V., Provaznik, I., Kizek, R. 2010c. Content of phenolic compounds and antioxidant capacity in fruits of apricot genotypes. *Molecules*, vol. 15, no. 9, p. 6285-6305. <https://doi.org/10.3390/molecules15096285> PMID:20877223

Songsermsakul, P., Pornphairin, E., Porasuphatana, S. 2013. Comparison of antioxidant activity of grape seed extract and fruits containing high beta-carotene, vitamin C, and E.

International Journal of Food Properties, vol. 16, no. 3, p. 643-648. <https://doi.org/10.1080/10942912.2011.561462>

Soto, M. U. R., Brown, K., Ross, C. F. 2012. Antioxidant activity and consumer acceptance of grape seed flour-containing food products. *International Journal of Food Science and Technology*, vol. 47, no. 3, p. 592-602. <https://doi.org/10.1111/j.1365-2621.2011.02882.x>

Valente, M., Brillard, A., Schönnenbeck, C., Brilhac, J. F. 2015. Investigation of grape marc combustion using thermogravimetric analysis. Kinetic modeling using an extended independent parallel reaction (eipr). *Fuel Processing Technology*, vol. 131, p. 297-303. <https://doi.org/10.1016/j.fuproc.2014.10.034>

Vivas, N. G. Y., Lagune, L., Saucier, C., Augustin, M. 1994. Estimation du degré de polymerization des procyanidins du raisin et du vin par la méthode au p-diméthylaminocinnamaldéhyde. *Journal International des Sciences de la Vigne et du Vin*, vol. 28, p. 319-336.

Vršíč, S., Ivančič, A., Šušek, A., Zagradišnik, B., Valdhuber, J., Šiško, M. 2011. The world's oldest living grapevine specimen and its genetic relationships. *Vitis*, vol. 50, no. 4, p. 167-171.

Acknowledgments:

The financial support from sources of the project IGA 10/2015/595 ZF MENDELU is gratefully acknowledged.

Contact address:

Lenka Tomášková, Mendel University in Brno, Faculty of Horticulture, Department of Viticulture and Enology, Valtická 337, CZ-691 44 Lednice, Czech Republic, E-mail: tomaskova.l9@gmail.com

Jiří Sochor, Mendel University in Brno, Faculty of Horticulture, Department of Viticulture and Enology, Valtická 337, CZ-691 44 Lednice, Czech Republic, E-mail: sochor.jirik@seznam.cz

Mojmír Baroň, Mendel University in Brno, Faculty of Horticulture, Department of Viticulture and Enology, Valtická 337, CZ-691 44 Lednice, Czech Republic, E-mail: mojmir.baron@mendelu.cz

THE CONTENT OF TOTAL POLYPHENOLS, ASCORBIC ACID AND ANTIOXIDANT ACTIVITY IN SELECTED VARIETIES OF QUINCE (*CYDONIA OBLONGA* MILL.)

Judita Bystrická, Janette Musilová, Helena Lichtnerová, Marianna Lenková, Ján Kovarovič, Marek Chalas

ABSTRACT

Quince fruit (*Cydonia oblonga* Miller) is an important source of bioactive compounds, especially of polyphenolic compounds, phenolic acids, flavonoids also of minerals and vitamins. These compounds exhibit health promoting properties including antibacterial, anti-inflammatory, anticancer, antidiabetic and cardioprotective properties. Quince fruit has a high therapeutic value, can be used as good sources of antioxidants. This study provides some knowledge about content of total polyphenols, ascorbic acid and antioxidant activity in selected varieties of quince fruit samples. Four quince fruit cultivars (Semenáč, Konstantinoplér Apfelquitte, Cydora Robusta, Mammut) were analysed. The content of the total polyphenols (TPC) was determined by the Folin-Ciocalteu reagent (FCR) at 765 nm using spectrophotometer. Ascorbic acid (AsA) content was determined using standard HPLC gradient method. Antioxidant activity (AA) was measured using a compound DPPH[•] (2,2-diphenyl-1-picrylhydrazyl). The content of (TPC) in fresh samples of quince fruit ranged from 661 ±11.60 mg.kg⁻¹ to 1044 ±11.03 mg.kg⁻¹ and content of AsA were in interval from 151 ±0.58 mg.kg⁻¹ to 215 ±0.75 mg.kg⁻¹. The values of antioxidant activity in quince fruit samples were in range from 26.90 ±0.61% to 49.14 ±0.38%. Statistically significant highest content TPC, AsA and AA was recorded in cultivar Konstantinoplér Apfelquitte and statistically lowest content was recorded in cultivar Semenáč. The content of TPC, AsA and AA beside the variety may be affected by many factors also climatic conditions and the agrochemical composition of the soil.

Keywords: quince fruit; total polyphenol; ascorbic acid; variety

INTRODUCTION

Quince fruit (*Cydonia oblonga* Miller) is a fruit of the *Rosaceae* family. It is one of the oldest crops, originates in the warmer areas of South-west Asia and has spread to Europe. It was a popular fruit species in Ancient Roma as well. The main production areas are Iraq, France and Portugal.

Quince fruit (*Cydonia oblonga* Miller) is mostly consumed in processed form. Because of its astringency, bitterness and firmness, it belongs to less popular species of the core fruit. However, when ripe, it is very demanded fruit for processing of marmalades, cakes and aromatic distillates as well.

The scientific investigations showed that quince fruit contains high quantities of bioactive substances, which are effective in prevention of different types of cancer and heart diseases and has beneficial effects on the human health (Trigueros et al., 2011; Pacifico et al., 2012; Benzarti et al., 2015). Quince fruit is rich in useful secondary metabolites such as phenolics, steroids, flavonoids, terpenoids, tannins, sugars, organic acids, and

glycosides (Ashraf et al., 2016). Quince healthy properties have been attributed to the high level of phenolic compounds which provide interesting antioxidant properties in quince fruits. Polyphenols are able to act as antioxidants in a number of ways. Quince polyphenols include mainly flavonoids (flavonols, flavanols), quercetin and kaempferol derivatives and proanthocyanidins (Wojdylo et al., 2013; Benzarti et al., 2015). Fattouch et al. (2007) and Costa et al. (2009) concluded that chlorogenic acid (*5-O-caffeoylquinic acid*) is the major phenolic compound in quince. Organic acids, identified in quince fruit, are citric, ascorbic, malic, shikimic and fumaric (Silva et al., 2002). Monosaccharides, situated in quince fruit, include: rhamnose, mannose, glucose and galactose (Hopur et al., 2011). The nutritional value of quince fruit is high. It is also considered as a good source of vitamins and minerals such as K, Ca, Mg, Fe, Cu, Zn, and Mn (Al-Snafi, 2016).

Wani et al. (2013) also considers quince to be a good source of bioactive substances like vitamin (A, C, E, riboflavin, folic acid), carotenoids, and flavonoids

(isorhamnetin, quercetin, myricetin) and their glucoside compounds.

The aim of the present study was to determine the content of polyphenols, ascorbic acid and antioxidant activity in selected varieties of quince fruit.

MATERIAL AND METHODOLOGY

Characteristic of varieties

Semenáč – the oldest and unbred cultivar. The fruits are similar to apples or pears, golden-yellow in colour.

Konstantinopler Apfelquitte – bred cultivar, is among the best tasting and oldest cultivars. Fruits are very aromatic.

Cydora Robusta – is among the most recent bred cultivars. The fruits are big, similar to the pears, bright yellow in colour.

Mammut – It is very profitable cultivar. Fruits are big and pear shaped, bright yellow in colour.

Chemical and instruments

Total polyphenol content (TPC) and antioxidant activity (AA) were analysed by colorimetric methods (Shimadzu UV/VIS-1240 spectrophotometer; Shimadzu, Kyoto, Japan).

The chemicals used for all analyses were as follows: Monohydrate of gallic acid, p. a., Folin-Ciocalteu reagent, anhydrous sodium carbonate, p. a., methanol, p. a., ethanol, p. a., 1,1-diphenyl-1-picrylhydrazyl (DPPH) radical, p.a., Trolox (97%).

Plant samples

Four quince fruit cultivars (Semenáč, Konstantinopler Apfelquitte, Cydora Robusta, Mammut) were obtained from a local producer in area Banka, Slovak Republic. All cultivars were cultivated conventionally under the same condition.

Samples of quince fruit were homogenized (50 g) in 100 mL 80% ethanol 12 h at 250 rpm. Extracts were then filtered through filter paper (130 g.m⁻²; Filtrak Brandt GmbH, Thermalbad Wiesenbad, Germany) and kept at 8 °C for further analysis. The experiment was based on four replications.

Total polyphenol content (TPC) determination

Total polyphenol content was determined by the method of Lachman et al. (2003) and expressed as mg of gallic acid equivalent per kg fresh mater. Gallic acid is usually used as a standard unit for phenolic content because a wide spectrum of phenolic compounds. The Folin-Ciocalteu phenol reagent was added to a volumetric flask containing 100 mL of extracts. The content was mixed and 5 mL of

a sodium carbonate solution (20%) was added after 3 min. The volume was adjusted to 50 mL by adding of distilled water. After 2 hours, the samples were centrifuged for 10 min. and the absorbance was measured at 765 nm of wave length against blank. The concentration of polyphenols was calculated from a standard curve plotted with known concentration of gallic acid.

Antioxidant activity (AA) determination

Antioxidant activity was measured by the Brand-Williams et al. (1995) method-using a compound DPPH[·] (2,2-diphenyl-1-picrylhydrazyl).

The compound 2,2-diphenyl-1-picrylhydrazyl (DPPH[·]) was pipetted to cuvette (3.9 mL) then the value of absorbance which corresponded to the initial concentration of DPPH[·] solution in time A₀ was written. Then 0.1 mL of the followed solution was added and then the dependence A = f (t) was immediately started to measure. The absorbance of 1, 5 and 10 minutes at 515.6 nm in the spectrophotometer Shimadzu UV/VIS – 1240 was mixed and measured. The percentage of inhibition reflects how antioxidant compound are able to remove DPPH[·] radical at the given time.

$$\text{Inhibition (\%)} = (A_0 - A_t/A_0) \times 100$$

Ascorbic acid (AsA) determination

Determination of ascorbic acid (AsA) using standard HPLC gradient method (Waters Separation module 2696 with DAD detector Waters 2996). The aliquots of the extract (extraction of samples using meta-Phosphoric acid, homogenization, filtration) were taken for HPLC analysis using syringe filter (PTFE 0.45 μm, Teknokroma). Chromatographic conditions: HPLC column NovaPak C18 (4 μm), 150 x 3.4 mm (Waters, USA), column temperature 25 °C, flow rate 1.0 mL.min⁻¹, DAD detector set to wavelength λ = 251 nm, mobile phase MetOH:water – 5:95 (v/v), injection aliquot 5 μL, retention time R_t = 1.4 min.

Statistical analysis

Results were statistically evaluated by the Analysis of Variance (ANOVA – Multiple Range Tests, Method: 95.0 percent LSD) using statistical software STATGRAPHICS (Centurion XVI.I, USA).

RESULTS AND DISCUSSION

Quince (*Cydonia oblonga* Miller) is regarded as an important source of beneficial effective bioactive compounds, which have a positive effect on human health.

Table 1 Total polyphenol content (TPC) in mg GAE.kg⁻¹, ascorbic acid content (AsA) in mg.kg⁻¹ and antioxidant activity (AA) in % inhibition.

Cultivars	Quince (<i>Cydonia oblonga</i> Miller)		
	TPC	AsA	AA
Semenáč	661 ±11.60 ^a	187 ±0.75 ^c	26.90 ±0.61 ^a
Konstantinopler Apfelquitte	1044 ±11.03 ^d	215 ±0.75 ^d	49.14 ±0.38 ^d
Cydoria Robusta	799 ±13.55 ^b	183 ±0.65 ^b	30.17 ±0.64 ^b
Mammut	819 ±7.14 ^c	151 ±0.58 ^a	38.03 ±0.52 ^c

Note: ^{a-d} values with different letters mean significant differences (*p* <0.05) among selected varieties, values TPC, AsA and AA are expressed as arithmetic mean.

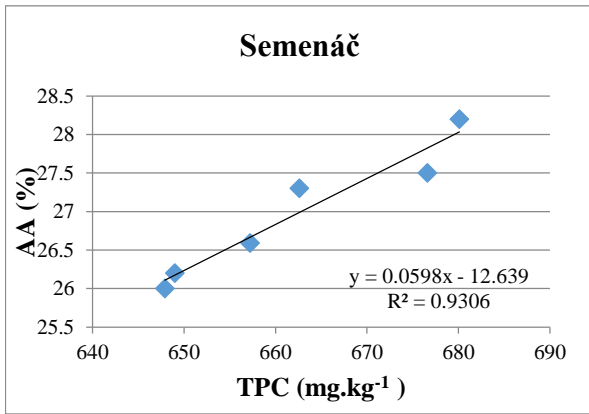

Figure 1 Relationship between TPC (mg.kg⁻¹) and AA (%) cultivar Semenáč.

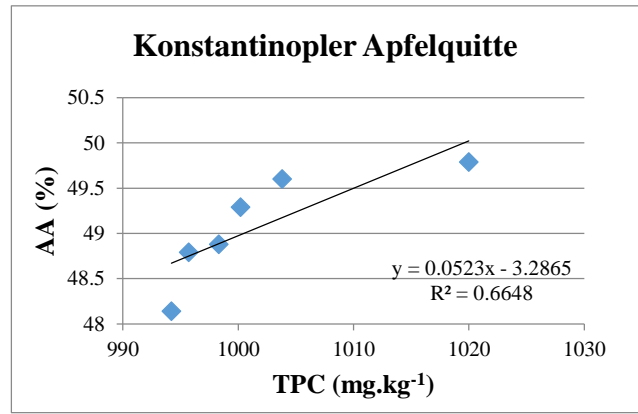

Figure 3 Relationship between TPC (mg.kg⁻¹) and AA (%) cultivar Apfelquitte.

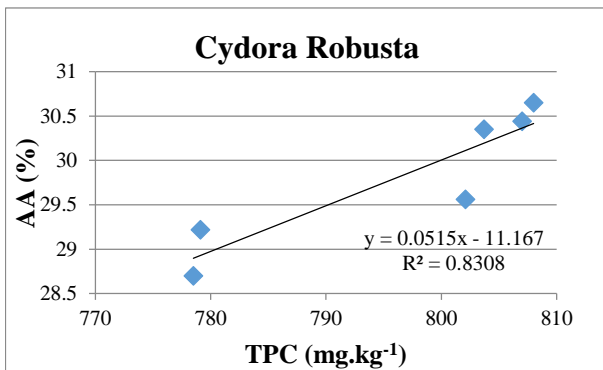

Figure 2 Relationship between TPC (mg.kg⁻¹) and AA (%) cultivar Cydora Robusta.

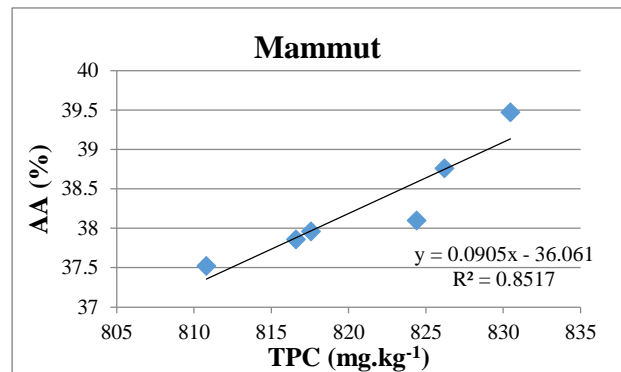

Figure 4 Relationship between TPC (mg.kg⁻¹) and AA (%) cultivar Mammut.



Figure 5 Cultivar Semenáč (URL 1).



Figure 6 Cultivar Konstantinopler Apfelquitte (URL 2).



Figure 7 Cultivar Mammut (URL 3).



Figure 8 Cultivar Cydora Robusta (URL 4).

These health-promoting substances have antimicrobial, antioxidant, anticancer, cardiovascular and anti-inflammatory effects (Al-Snafi, 2016; Sadeghpour et al., 2016). The results of the phytochemical analysis of the individual cultivars are presented in Table 1.

The content of total polyphenols in quince fruit samples ranged from $661 \pm 11.60 \text{ mg.kg}^{-1}$ to $1044 \pm 11.03 \text{ mg.kg}^{-1}$. The highest level of total polyphenols content was found in cv. Konstantinopler Apfelquitte and the statistically significant lowest content of total polyphenols was recorded in cv. Semenáč. Based on the measured values of total polyphenols content, cultivars of quince can be classified as follows: Konstantinopler Apfelquitte (1044 mg.kg^{-1}) >Mammut (819 mg.kg^{-1}) >Cydoria Robusta (799 mg.kg^{-1}) >Semenáč (661 mg.kg^{-1}). Many studies have dealt with the content of polyphenols in the parts of quince. The research results vary depending on the cultivars and also climatic and agrochemical conditions. Our results are in correspondence with the results of Silva et al. (2005), who indicated the content of polyphenols within the range of 200 mg.kg^{-1} – 1700 mg.kg^{-1} . Fattouch et al. (2007) determined a lower content of polyphenols in quince fruit, in comparison with our results. Their value ranged from 370 to 470 mg.kg^{-1} . Mir et al. (2015) referred, that total polyphenol content in fresh quince was in interval from 412.3 to $975.10 \text{ mg.kg}^{-1}$. It follows from the above, that the quince ranks among the significant and easily available sources of the polyphenols substances.

Another significant parameter, that was monitored, was the content of ascorbic acid in selected varieties of quince. The highest level of ascorbic acid content was found in cv. Konstantinopler Apfelquitte, ($215 \pm 0.75 \text{ mg.kg}^{-1}$) and the statistically significant lowest content of ascorbic acid was recorded in cv. Mammut ($151 \pm 0.58 \text{ mg.kg}^{-1}$). Sharma et al. (2011) determine similar results; their average value presents 168 mg.kg^{-1} . Souci et al. (2008) determines slightly lower value; it presents 130 mg.kg^{-1} . On the other hand, Rop et al. (2011) determined in Czech cultivars several times higher values, in comparison with our results. Their value ranged from 500 to 800 mg.kg^{-1} and cultivar Muškatová contained the highest amount, $793.1 \pm 2.01 \text{ mg.kg}^{-1}$. This determination proves that the cultivars of the quince show great genetic variability. In this study, we evaluated the value of antioxidant activity in selected cultivars of quince fruit. Our values were in interval from $26.90 \pm 0.61\%$ to 49.14 ± 0.38 (Table 1). Based on the measured values of antioxidant activity in quince fruit, cultivars can be classified as follows: Konstantinopler Apfelquitte (49.14%) >Mammut (38.03%) >Cydoria Robusta (30.17%) >Semenáč (26.90%). Mir et al. (2015) determines in his study slightly higher values, in comparison with our results. Their values were in interval from 43.20 to 69.40%. Gheisari and Abhari (2014) compared antioxidant activity in peel, flesh extracts and oven-dried fruits and determine following values: 87%, 23.20% and 83.35%, respectively. In this study we have found positive correlation between the content of total polyphenols and antioxidant activity ($r = 0.967$, $r = 0.815$, $r = 0.911$, $r = 0.922$). Results are shown in Figure 1, Figure 2, Figure 3 and Figure 4. These results are in good accordance with Drogoudi et al. (2008), who reported a positive correlation between total antioxidant activity and total phenolic content in apple flesh and peel

($r = 0.914$ and $r = 0.977$, respectively). Silva et al. (2008) also observed a positive relationship between the content of polyphenolic compounds and antioxidant activity.

CONCLUSION

Despite the fact, that Quince is among the less popular fruit, this study indicates, that it is a rich source of compounds with interesting biological effects. The Quince is mainly valued for its high content of polyphenols (flavonols, flavanols, proanthocyanidins and many more), which protect the body against many diseases of civilization. The highest content of polyphenols was determined in breeding cultivar Konstantinopler Apfelquitte. The content of bioactive compounds may be affected by many factors, e.g. cultivars, agrochemical composition of the soil and climatic conditions. In the future, the information determined in this study, should be used for development of new functional foods with the addition of quince.

REFERENCES

- Al-Snafi, A. E. 2016. The medical importance of *Cydonia oblonga* – A review. *Journal of Pharmacy*, vol. 6, no. 6, p. 87-99.
- Ashraf, M. U., Muhammad, G., Hussain, M. A., Bukhari, S. A. A. 2016. *Cydonia oblonga* M., A Medicinal plant rich in phytonutrients for pharmaceuticals. *Frontiers in Pharmacology*, vol. 7, p. 163.
- Benzarti, S., Hamdi, H., Lahmayer, I., Toumi, W., Kerkeni, A., Belkadhi, K., Sebei, H. 2015. Total phenolic compounds and antioxidant potential of quince (*Cydonia oblonga* Miller) leaf methanol extract. *International Journal of Innovation and Applied Studies*, vol. 13, no. 3, p. 518-526.
- Brand-Williams, W., Cuvelier, M. E., Berset, C. 1995. Use of a free radical method to evaluate antioxidant activity. *Lebensmittel-Wissenschaft und Technologie*, vol. 28, no. 1, p. 25-30. [https://doi.org/10.1016/S0023-6438\(95\)80008-5](https://doi.org/10.1016/S0023-6438(95)80008-5)
- Costa, R. M., Magalhães, A. S., Pereira, J. A., Andrade, P. B., Valentão, P., Carvalho, M., Silva, B. M. 2009. Evaluation of free radical-scavenging and antihemolytic activities of quince (*Cydonia oblonga*) leaf : A comparative study with green tea (*Camellia sinensis*). *Food and Chemical Toxicology*, vol. 47, no. 4, p. 860-865. <https://doi.org/10.1016/j.fct.2009.01.019>
- Drogoudi, P. D., Michailidis, Z., Pantelidis, G. 2008. Peel and flesh antioxidant content and harvest quality characteristics of seven apple cultivars. *Scientia Horticulturae*, vol. 115, no. 2, p. 149-153. <https://doi.org/10.1016/j.scienta.2007.08.010>
- Fattouch, S., Caboni, P., Coroneo, V., Tuberoso, C. I. G., Angioni, A., Dessi, S., Marzouki, N., Cabras, P. 2007. Antimicrobial activity of Tunisian quince (*Cydonia oblonga* Miller) pulp and peel polyphenolic extracts. *Journal of Agricultural and Food Chemistry*, vol. 55, no. 3, p. 963-969. <https://doi.org/10.1021/jf062614e>
- Gheisari, H. R., Abhari, K. H. 2014. Drying method effects on the antioxidant activity of quince (*Cydonia oblonga* Miller) tea. *Acta Scientiarum Polonorum Technologia Alimentaria*, vol. 13, no. 2, p. 129-134. <https://doi.org/10.17306/J.AFS.2014.2.2>

- Hopur, H., Asrorov, A. M., Qingling, M., Yili, A., Ayupbek, A., Nannan, P., Aisa, H. A. 2011. HPLC analysis of polysaccharides in quince (*Cydonia oblonga* Mill. var. *maliformis*) fruit and PTP1B inhibitory activity. *The Natural Product Journal*, vol. 1, no. 2, p. 146-150. <https://doi.org/10.2174/2210315511101020146>
- Lachman, J., Proněk, D., Hejtmánková, A., Dudjak, J., Pivec, V., Faitová, K. 2003. Total polyphenol and main flavonoid antioxidants in different onion (*Allium cepa* L.) varieties. *Horticultural Science*, vol. 30, p. 142-147.
- Mir, S. A., Masoodi, F. A., Gani, A., Ganaie, S. A., Reyaz, U., Wani, S. M. 2015. Evaluation of antioxidant properties of methanolic extracts from different fractions of quince (*Cydonia oblonga* Miller). *Advances in Biomedicine and Pharmacy*, vol. 2, no. 1, p. 1-6. <https://doi.org/10.19046/abp.v02i01.01>
- Pacifico, S., Gallicchio, M., Fiorentino, A., Fischer, A., Meyer, U., Stintzing, 2012. Antioxidant properties and cytotoxic effects on human cancer cell lines of aqueous fermented and lipophilic quince (*Cydonia oblonga* Mill.) preparations. *Food and Chemical Toxicology*, vol. 50, no. 11, p. 4130-4135. <https://doi.org/10.1016/j.fct.2012.07.061>
- Rop, O., Balik, J., Řezníček, V., Jurikova, T., Škardova, P., Salaš, P., Sochor, J., Mlček, J., Kramařova, D. 2011. Chemical characteristic of fruits of some selected quince (*Cydonia oblonga* Mill.) cultivars. *Czech Journal of Food Sciences*, vol. 29, no. 1, p. 65-73.
- Sadeghpour, O., Alias, F., Toliyat, T., Mohammadi, A., Minaee, B., Samadi, N., Aliasl, J. 2016. Medicinal properties of *Cydonia oblonga* Mill fruit (Pulp and Peel) in Iranian traditional medicine and modern phytotherapy. *Traditional and Integrative Medicine*, vol. 1, no. 3, p. 122-128.
- Sharma, R., Joshi, V. K., Rana, J. C. 2011. Nutritional composition and processed products of quince (*Cydonia oblonga* Mill.). *Indian Journal of Natural Products and Resources*, vol. 2, no. 3, p. 354-357.
- Silva, B. M., Andrade, P. B., Mendes, G. C., Seabra, R. M., Ferreira, M. A. 2002. Study of the organic acids composition of quince (*Cydonia oblonga* Miller) fruit and Jam. *Journal of Agricultural and Food Chemistry*, vol. 50, no. 8, p. 2313-2317. <https://doi.org/10.1021/jf011286>
- Silva, B. M., Andrade, P. M., Ferreres, F., Seabra, R. M., Oliveira, M. B., Ferreira, M. A. 2005. Composition of quince (*Cydonia oblonga* Miller) seeds: Phenolic, organic acids and free amino acids. *Natural Product Research*, vol. 19, no. 3, p. 275-281. <https://doi.org/10.1080/14786410410001714678>
- Silva, B. M., Valentão, P., Seabra, R. M., Andrade, P. B. 2008. Quince (*Cydonia oblonga* Miller): an interesting dietary source of bioactive compounds. In Papadopoulos, K. N. *Food Chemistry research developments*. Ed. K. N. Papadopoulos. New York : Nova Science Publishers, p. 243-266. ISBN 978-1-60456-262-0.
- Souci, S. W., Fachmann, W., Kraut, H. 2008. Food composition and nutrition tables. 7th ed. Stuttgart, Germany : CRC Press, MedPharm, Scientific Publishers. 1400 p. ISBN-978-3-8047-5038-8.
- Trigueros, L., Pérez-Alvarez, J. A., Viuda-Martos, M., Sendra, E. 2011. Production of low-fat yogurt with quince (*Cydonia oblonga* Mill.) scalding water. *LWT – Food Science and Technology*, vol. 44, no. 6, p. 1388-1395. <https://doi.org/10.1016/j.lwt.2011.01.012>
- Wani, T. A., Wani, S. M., Shah, A. G., Masoodi, F. A. 2013. Optimizing conditions for antioxidant extraction from Sea Buckthorn leaf (*Hippophae rhamnoides* L.) as herbal tea using response surface methodology (RSM). *International Food Research Journal*, vol. 20, no. 1 p. 1677-1681. <https://doi.org/10.1080/23311932.2015.1128519>
- Wojdylo, A., Oszmiański, J., Bielicki, P. 2013. Polyphenolic composition, antioxidant activity, and polyphenol oxidase (PPO) activity of quince (*Cydonia oblonga* Miller) varieties. *Journal of Agricultural and Food Chemistry*, vol. 61, no. 11, p. 2762-2772. <https://doi.org/10.1021/jf304969b>
- URL 1 Available at:
<http://www.prodejstromku.cz/produkt/amanliska>
- URL 2 Available at:
<http://web03.brunns.de/bruns/en/EUR//Pflanzen/QUITTE-%27Konstantinopler-Apfelquitte%27/p/4605>
- URL 3 Available at:
<http://ovocnedreviny.sk/produkt/jadroviny/dula/dula-mammut/>
- URL 4 Available at:
<http://gyumolcspedia.hu/cydora-robusta-birs>

Acknowledgments:

This work was supported by grant VEGA 1/0290/14.

Contact address:

Judita Bystrická, Slovak University of Agriculture in Nitra, Faculty of Biotechnology and Food Sciences, Department of Chemistry, Tr. A. Hlinku 2, 949 76 Nitra, Slovakia, E-mail: Judita.Bystricka@centrum.sk

Janette Musilová, Slovak University of Agriculture in Nitra, Faculty of Biotechnology and Food Sciences, Department of Chemistry, Tr. A. Hlinku 2, 949 76 Nitra, Slovakia, E-mail: Janette.Musilova@uniag.sk

Helena Lichtnerová, Slovak University of Agriculture in Nitra, Horticulture and Landscape Engineering Faculty, Department of Planting Design and Maintenance, Tulipánová 7, 949 76 Nitra, Slovakia, E-mail: Helena.Lichtnerova@uniag.sk

Marianna Lenková, Slovak University of Agriculture in Nitra, Faculty of Biotechnology and Food Sciences, Department of Chemistry, Tr. A. Hlinku 2, 949 76 Nitra, Slovakia, E-mail: mariannalenkova@gmail.com

Ján Kovarovič, Slovak University of Agriculture in Nitra, Faculty of Biotechnology and Food Sciences, Department of Chemistry, Tr. A. Hlinku 2, 949 76 Nitra, Slovakia, E-mail: xkovarovic@uniag.sk

Marek Chalas, Slovak University of Agriculture in Nitra, Faculty of Biotechnology and Food Sciences, Department of Chemistry, Tr. A. Hlinku 2, 949 76 Nitra, Slovakia, E-mail: xchalas@uniag.sk

POLYPHENOLS AND PHENOLIC ACIDS IN SWEET POTATO (*IPOMOEA BATATAS* L.) ROOTS

Janette Musilová, Judita Bystrická, Július Árvay, Euboš Harangozo

ABSTRACT

Sweet potato (*Ipomoea batatas* L.) is one of the most important food crops in the world. They are rich in polyphenols, proteins, vitamins, minerals and some functional microcomponents. Polyphenols are bioactive compounds, which can protect the human body from the oxidative stress which may cause many diseases including cancer, aging and cardiovascular problems. The polyphenol content is two to three times higher than in some common vegetables. Total polyphenols (determined spectrophotometrically) and phenolic acids (i.e. caffeic acid, chlorogenic acid and isomers – using high performance liquid chromatography) contents were determined in three varieties of sweet potatoes (O'Henry – white, Beauregard-orange and 414-purple). Phenolic compounds contents were determined in raw peeled roots, jackets of raw roots and water steamed sweet potato roots. For all analysis lyophilised samples were used. Total polyphenol content ranged from 1161 (O'Henry, flesh-raw) to 13998 (414, peel-raw) mg.kg⁻¹ dry matter, caffeic acid content from the non-detected values (414, flesh-raw) to 320.7 (Beauregard, peel-raw) mg.kg⁻¹ dry matter and 3-caffeoylquinic acid content from 57.57 (O'Henry, flesh-raw) to 2392 (414, peel-raw) mg.kg⁻¹ dry matter. Statistically significant differences ($p \leq 0.05$) existed between varieties, morphological parts of the root, or raw and heat-treated sweet potato in phenolic compounds contents.

Keywords: sweet potato; polyphenols; caffeic acid; chlorogenic acid

INTRODUCTION

The sweet potato, *Ipomoea batatas* L. (Lam.), is a dicotyledonous plant belonging to *Convolvulaceae* family. Originally it was domesticated at least 5000 years ago in tropical America (Woolfe, 1992). At present sweet potato is grown mainly in China, the other major producers are Sub-Saharan Africa, Indonesia, Asia and South America. It is classified as the seventh most important food crop after rice, wheat, potatoes, maize and cassava (Pandi et al., 2016). In 2014 sweet potato world production exceeded 100 million tonnes (Esatbeyoglu et al., 2017).

Sweet potato is a crop with easy adaptability to a wide range of agro-ecological conditions (e.g. high temperature, drought, low soil fertility). It is suitable and attractive crop for agriculture with limited resources (Anbuselvi et al., 2012; Laurie et al., 2013), which leads to its increased production (Maquia et al., 2013).

The main components of sweet potato are carbohydrates representing from 80 to 90% dry weight (Pandi et al., 2016). Starch share constitutes up to 65 – 70% of dry weight (Padmaja, 2009), (amylose content ranges from 200 to 330 g per kg solids). Glucose (6.0 – 72), fructose (3.0 – 66), sucrose (21 – 77) and maltose (11 – 43 g per kg solids) are included in it as single sugars (Waramboi et

al., 2011). Non-starch polysaccharides consist of cellulose, hemicellulose and pectins. The roots of sweet potatoes are rich in minerals (P, K, Ca, Mg, Fe, Zn, Na, Cu), vitamins (B₁, B₂, B₃, B₅, B₆, H, C, E), carotenoids and conversely, have low protein content. Sulfur amino acids (Met, Cys) and Lysine are limited, (Ishida et al., 2000; Maquia et al., 2013) and simultaneously, sweet potato is a source of polyphenols. It contains phenolic compounds such as caffeoylquinic acid (CQA) derivatives, a family of esters formed from certain cinnamic acids and quinic acid, including mono-CQA (chlorogenic acid derivatives): 3-CQA (Figure 1); 4-CQA (Figure 2) and 5-CQA (Figure 3) (Clifford et al., 2003), such as three dicaffeoylquinic acids: 3,5-di CQA, 3,4-diCQA and 4,5-diCQA (isochlorogenic acid A, B, and C, respectively, Figures 4, 5, 6) (Ishiguro et al., 2007; Taira et al., 2013).

Anthocyanins are another compounds with chemoprotective effects. Their presence is manifested by purple colouring of the flesh and jacket of the sweet potato. Cyanidin and peonidin are predominant aglycones. Authors of numerous studies refer to their antioxidant, anticarcinogenic, anti-hyperglycemic and chemoprotective properties (Esatbeyoglu et al., 2017; Nozue et al., 1998; Rumbaoa et al., 2009).

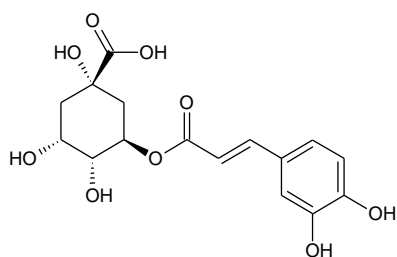

Figure 1 3-caffeoylquinic acid (3-CQA)

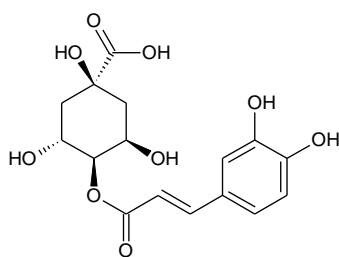

Figure 2 4-caffeoylquinic acid (4-CQA)

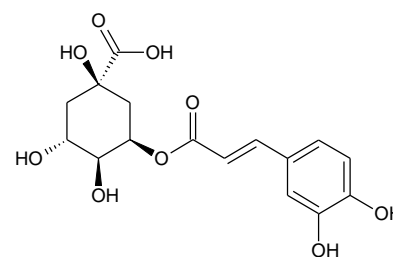

Figure 3 5-caffeoylquinic acid (5-CQA)

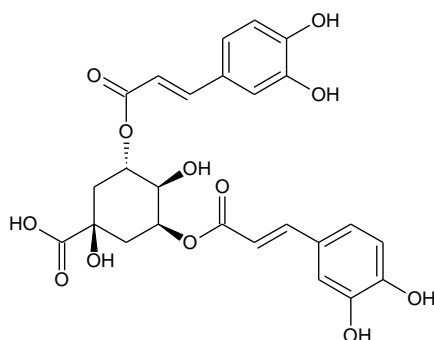

Figure 4 3,5-dicaffeoylquinic acid (3,5-diCQA)

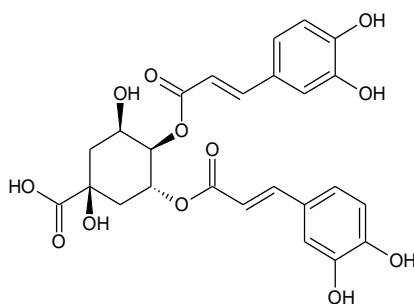

Figure 5 3,4-dicaffeoylquinic acid (3,4-diCQA)

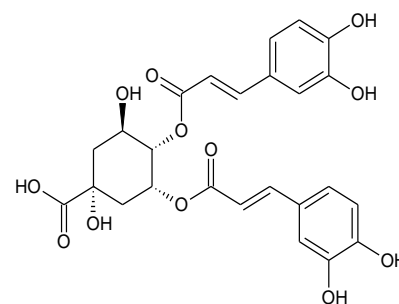

Figure 6 4,5-dicaffeoylquinic acid (4,5-diCQA)

Figures 1-6 Chemical structures of caffeoylquinic acid derivate from sweet potato (*Ipomoea batatas* L.).

Not only tubers but also other parts of sweet potatoes have nutritionally and functionally valuable components. Young leaves can also be used for consumption (Slosar et al., 2016). Many authors refer to the leaves of the sweet potato as important sources of polyphenols, chlorogenic acid and its derivatives. Sun et al. (2014) determined polyphenols in 40 varieties from China (TPC: $2.73 \pm 0.02 - 12.46 \pm 0.62$ g.100 g⁻¹ DM. Fu et al. (2016) determined TPC in different solvents (MeOH, EtOH, acetone, water) ranged from 23.3 ± 0.9 (in water) to 43.8 ± 0.7 (in 50% acetone) mg TPC.g⁻¹ DM. Yoshimoto et al. (2002) determined contents of caffeic acid (2 mg.100 g⁻¹) and caffeoyl derivatives (chlorogenic acid: 31; 3,4-diCQA: 9; 3,5-diCQA: 91; 4,5-diCQA: 49; 3,4,5-triCQA: 4 mg.100 g⁻¹) of lyophilized powder. Xu et al. (2010) determined TPC in the leaves of 116 varieties ranged from 8.943 to 27.333 mg CHA.g⁻¹ DM.

The aim of this study was to determine and evaluate total polyphenol and phenolic acids contents (i.e. caffeic acid and its esters with quinic acid) depending on the variety, morphological part of root morphology (flesh vs. jacket), and thermal treatment.

MATERIAL AND METHODOLOGY

Three varieties of potatoes were used for the analyses as follows: O'Henry (white), Beauregard (orange) and 414 (purple), which were grown in the cadastral area of Šoporňa (N: 48.243421; E: 17.813596) in the Slovak Republic. About 2 kg of plant material was taken from two sampling sites for each variety.

The roots were peeled after washing and average samples were prepared for each variety from the jackets, or fleshes.

About 150 g of sweet potato were cut up, mixed and lyophilised and all jackets were mixed and lyophilised. About 30 g of the homogenized sample was used for the determination of dry matter.

Another portion of prepared average samples of flesh was used for the steam cooking as follows: about 200 g of sweet potatoes were cut into slices the thickness of which was 3 mm and cooked 20 minutes in steam at a temperature of 98 ± 2 °C. The samples were lyophilised and mixed after cooling.

Chemicals

Authentic standards of chlorogenic acid (purity $\geq 95.0\%$) and *trans*-caffeic acid (purity $\geq 95.0\%$), acetonitrile (gradient HPLC grade), phosphoric acid (ACS grade), 80% EtOH and Folin-Ciocalteu agents were purchased from Sigma-Aldrich (Sigma Aldrich Chemie GmbH, Steiheim, Germany); gallic acid (p.a.) was provided by Merck (Germany); double deionized water (ddH₂O) was treated ($0.054 \mu\text{S}\cdot\text{cm}^{-1}$) in a Simplicity 185 purification system (Millipore, UK).

Preparation of extracts

The lyophilized samples (1 g) were after homogenization in a mortar extracted with 20 mL of 80% EtOH at laboratory temperature for 8 h by horizontal shaker (Unimax 2010; Heidolph Instrument GmbH, Germany). Extract was filtered through Munktell No 390 paper (Munktell & Filtrac, Germany) and stored in closed 20 mL vial tubes. Prior to injection the standard solutions and

extracts were filtered through syringe filter Q-Max (0.22 mm, 25 mm; Frisette ApS, Knebel, Denmark).

Determination of total polyphenols content (TPC)

TPC was determined spectrophotometrically (Spectrophotometer UV-VIS 1601, Shimadzu) in ethanol extract using Folin-Ciocalteu reagents. Measurement of absorbance (against blank) was at wavelength $\lambda = 765$ nm and total polyphenols content was expressed as mg gallic acid eqv. (Lachman et al., 2006).

Determination of phenolic acids

Chlorogenic acids (CA) and *trans*-caffeic acid were determined by Lukšič et al. (2016), using an Agilent 1260 Infinity high performance liquid chromatograph (Agilent Technologies, Waldbronn, Germany) with quaternary solvent manager coupled with degasser (G1311B), sample manager (G1329B), column manager (G1316A) and DAD detector (G1315C). All HPLC analyses were performed on a Purosphere reverse phase C18 column (4 mm x 250 mm x 5 mm) (Merck, KGaA, Darmstadt, Germany).

The detection wavelengths were conducted at 327 nm (chlorogenic acids) and 325 nm (*trans*-caffeic acid). The data were collected and processed using Agilent OpenLab ChemStation software for LC 3D Systems. Limit of detection for chlorogenic acids and *trans*-caffeic acid were 0.98 and 1.09 $\mu\text{g}\cdot\text{mL}^{-1}$, respectively. Limit of quantification for chlorogenic acids and *trans*-caffeic acid were 3.27 and 3.63 $\mu\text{g}\cdot\text{mL}^{-1}$, respectively.

Statistical analysis

Results were statistically evaluated by Analysis of Variance (ANOVA – Multiple Range Tests, Method: 95.0 percent LSD) using statistical software STATGRAPHICS (Centurion XVII, USA) and a regression and correlation analysis (Microsoft Excel) was used.

RESULTS AND DISCUSSION

Content of mineral and trace elements

Mineral and trace elements content was determined in the lyophilised samples of raw sweet potatoes (in the peeled roots and jackets) and in the peeled roots cooked in steam. The results shown in Table 1 are comparable to the values determined by Suárez et al. (2016) in 30 varieties of sweet potatoes from Tenerife Island and La Palma Island. The other two varieties from Japan show lower mineral contents in roots of sweet potatoes (Ishida et al., 2000) compared to our varieties. Waramboi et al. (2011) published comparable contents of K and Mg, lower

contents of Ca and P, and higher content of Na in the variety Beaugard from Papua (New Guinea). The differences in mineral contents in sweet potato may be due to their different content in the soil.

Total polyphenol content (TPC)

TPC was determined by the Folin–Ciocalteu spectrophotometrically. The content of polyphenols, which was the highest in the purple cultivar 414, was more than 8.4 times higher than in the O'Henry variety. The average levels of TPC ranged from 1161 to 9800 $\text{mg}\cdot\text{kg}^{-1}$ DM, which was similar to the findings reported by Rumbaoa et al. (2009) (192.7 – 1159.08 $\text{mg GAE}\cdot 100\text{ g}^{-1}$ dry sample). The results shown by Padda, Picha (2008) indicate that sweet potato genotypes differ greatly in total phenolic content. The TPC in all of the 14 genotypes ranged from 1.4 to 4.7 $\text{mg}\cdot\text{g}^{-1}$ DW. Polyphenol content determined by Teow et al. (2007) was 9.646 in the white sweet potato, ranged from 440.8 to 742.9 in orange cultivars and from 1523.9 to 2955.2 $\text{mg CA equiv}\cdot\text{kg}^{-1}$ DM in purple cultivars. Shin et al. (2009) compared the orange and yellow varieties of sweet potatoes. Total phenolic compounds of freeze-dried samples of orange sweet potato (Tainong 66) were higher than those of yellow sweet potatoes (Tainong 57) (10.9 and 6.38 $\text{mg catechin equiv}\cdot\text{g}^{-1}$ DM respectively).

There are statistically significant differences in TPC between varieties Niele, but also between flesh and peel in a single variety. The most significant difference is evident in the Beaugard variety: $\text{TPC}_{\text{peel}}/\text{TPC}_{\text{flesh}} = 4.27$. The differences in TPC are statistically significant in all varieties ($p \leq 0.05$), which corresponds with the results published by Steed and Truong (2008), showing that the TPC in the jackets of purple-fleshed sweet potatoes was more than 3.5 times higher than in their flesh.

Phenolic acids content

Trans-caffeic acid (CfA) and 3-CQA were identified by HPLC method (Figures 7 – 9). Other phenolic acids (5-CQA, 4-CQA and dicaffeoylquinic acids) are defined as a sum of the CQA isomers. CfA and 3-CQA were significantly higher ($p \leq 0.05$) in the jackets of all the three varieties of sweet potatoes. Purple variety 414 is an exception with the statistically significant difference between the content of 3-CQA in the jacket and flesh (CfA was not detected in the jackets of this variety) (Table 2). The content of total phenolic acids (CfA, 3-CQA, sum CQA-isomers) determined in raw sweet potatoes ranged from 169.5 (O'Henry – flesh) to 7952.5 (414 – flesh)

Table 1 Content of mineral and trace elements in sweet potato ($\text{mg}\cdot\text{kg}^{-1}$ DM).

		K	Na	Ca	Mg	P	Cu	Zn	Mn
O'Henry	flesh (raw)	13353	598.2	3364	751.6	2159	9.051	9.503	7.605
	peel (raw)	21807	706.9	20561	1104	2572	13.35	13.61	29.80
	flesh (steaming)	10241	534.7	3231	646.9	2173	8.904	9.401	8.151
Beaugard	flesh (raw)	15342	370.5	4241	554.5	1686	7.452	8.853	9.057
	peel (raw)	21294	568.2	24885	1022	2391	14.30	13.32	20.751
	flesh (steaming)	10521	355.0	5198	581.4	1796	7.110	7.851	6.956
414	flesh (raw)	7418	932.4	6445	950.4	2626	7.904	9.202	9.804
	peel (raw)	12421	2260	26649	2030	3118	12.25	12.12	32.35
	flesh (steaming)	6385	957.2	7713	960.8	2561	7.252	8.754	9.302

mg.kg⁻¹ DM. **Esatbeyoglu et al. (2016)** determined 1070±8.7 mg.kg⁻¹ DM chlorogenic acid and 430.4±2.3 mg.kg⁻¹ DM isomers 3,4-, 3,5- and 4,5-diCQA in Chinese purple sweet potato. **Jung et al. (2011)** determined six phenolic acids (3-CQA, 5-CQA, 4-CQA,

3,5-diCQA, 4,5-diCQA and 3,4-di CQA) in eight Korean sweet potatoes. The sums of acids ranged from 19.77 mg.100 g⁻¹ FM in the middle part of potato roots to 300.3 mg.100 g⁻¹ FM in the stem end of potato roots. In two varieties of sweet potatoes, Koganesengan and

Table 2 Total polyhenols content (TPC, mg gallic acid equiv.kg⁻¹ DM), phenolic acids (mg chlorogenic acid equiv.kg⁻¹ DM) contents of three cultivar sweet potatoes roots.

		TPC	Caffeic acid	3-CQA	Sum CQA-isomers
O'Henry	flesh (raw)	1161±81.01 ^a ; A	1.276±0.005 ^a ; A,B	57.57±8.333 ^a ;A	110.6 ^a ;A
	peel (raw)	4263±123.16 ^b	317.3±23.41 ^b	584.1±96.69 ^{b,c}	1734 ^b
	flesh (steaming)	1543±72.45 ^B	ND ^A	108.7±8.312 ^A	126.0 ^A
Beauregard	flesh (raw)	1186±60.41 ^a ; A	12.41±3.281 ^a	193.3±28.59 ^{a,b} ;A	387.0 ^a ;A
	peel (raw)	5062±75.06 ^c	320.7±6.328 ^b ; D	715.8±92.72 ^c	2,790 ^c
	flesh (steaming)	2904±67.64 ^C	6.297±1.336 ^{B,C}	615.7±61.97 ^B	1423 ^B
414	flesh (raw)	9800±145.0 ^d ; E	ND ^a ; A	2163±280.5 ^d ;C	5790 ^e ;D
	peel (raw)	13998±386.8 ^e	272.3±142.7 ^b	2392642.9 ^d	4350 ^d
	flesh (steaming)	7644±561.9 ^D	6.895±0.146 ^C	2282±304.9 ^C	3424 ^C

Note: ^{a,b,c,d,e} – statistically significant differences between content of caffeic acid (3-CQA and sum CQA isomers, resp.) in raw flesh (raw peel) of sweet potatoes from different cultivar (Multiple Range Tests; Method: 95.0 percent LSD).

^{A,B,C,D} – statistically significant differences between content of caffeic acid (3-CQA and sum CQA-isomers, resp.) in raw flesh (steaming flash) of sweet potatoes from different cultivar (Multiple Range Tests; Method: 95.0 percent LSD).

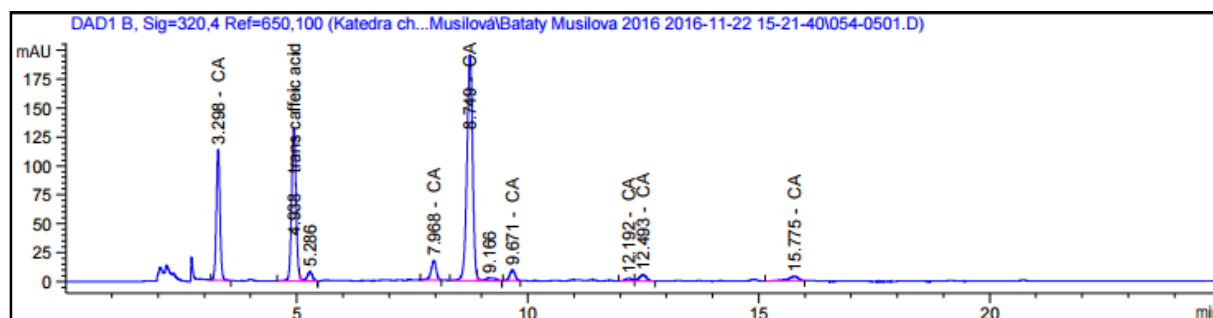

Figure 7 Chromatogram of trans-caffeic acid and chlorogenic acid isomers in peel of sweet potato (cv. O'Hara).

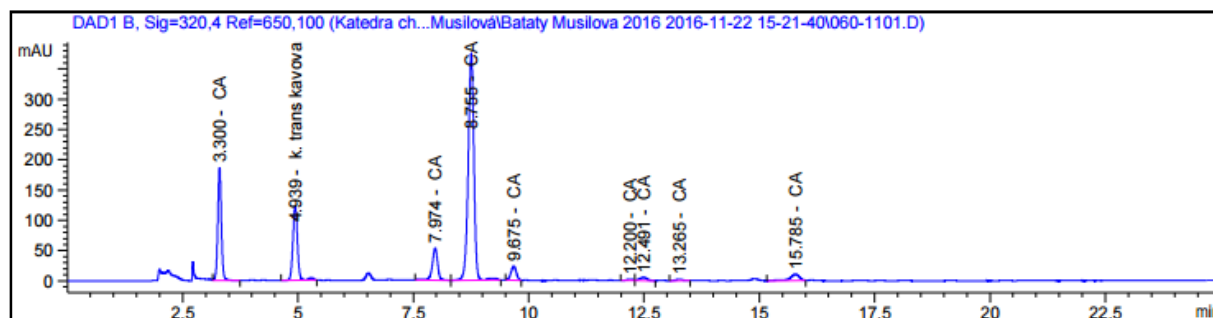

Figure 8 Chromatogram of trans-caffeic acid and chlorogenic acid isomers in peel of sweet potato (Beauregard – peel).

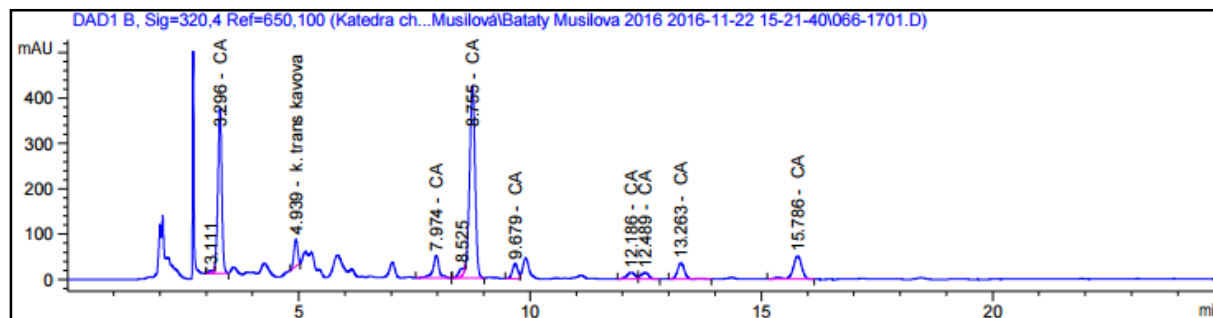

Figure 9 Chromatogram of trans-caffeic acid and chlorogenic acid isomers in peel of sweet potato (414 – peel).

Beniazuma (Japan) determined **Ishuida et al. (2000)** 21.2 and 18.8 mg chlorogenic acid in 100 g DM.

Statistically significant differences were found out in the content of polyphenols, caffeic acid and the sums of CQA-isomers between the raw sweet potato and those boiled in water. With the exception of cv. Beauregard (CfA) and 414 (sum CQA-isomers) phenolic compounds contents are higher in the steamed potatoes compared to the raw ones. TPC in O'Henry variety was 1.33 times and in Beauregard 2.45-times higher. TPC was 1.2 times lower in the steamed sweet potatoes compared to the raw potatoes in purple variety 414. **Bellail et al. (2012)** compared the effect of different processing methods (raw – boiled – baked – microwaved – deep fried) on total phenolics in four cultivars of sweet potato. For each cultivar of sweet potato, the TPC of the processed samples were higher than that of raw sample, and the result indicates that all home processing methods resulted in a significant increase ($p \leq 0.05$) in phenolic content of the flesh tissues. The increasing rate was in the following order: deep-frying > baking > boiling > microwaving. Boiling and microwaving showed the highest total phenolics with Beauregard cultivar (2.8 and 2.6 times, respectively), as compared to the raw samples.

The influence of steaming reduced the CFA content in the varieties O'Henry and Beauregard and increased it in the purple variety 414. 3-CQA content was increased in all the three varieties.

Rautenbach et al. (2010) observed an increase in the chlorogenic acid content in all the varieties of sweet potato after heat treatment. The increase was between 21.1% and 79.1%. **Bellail et al. (2012)** presents a significant increase ($p \leq 0.05$) in phenolic acids in the processed sweet potatoes. The caffeic acid and 3,4-diCQA content was more than 7 times higher in the cooked sweet potatoes cv. Beauregard in comparison with their content in the raw roots.

The increase in the efficiency of extraction of phenolic compounds can be explained by the damage to cellular structures caused by the peeling, or by the heat treatment of the plant material (**Bellail et al., 2012; Huang et al., 2006**).

CONCLUSION

The sweet potato is a crop which is relatively undemanding in respect of the plant growing conditions. It is the source of many nutritional and bioactive substances. Its cultivation is widespread mainly in African and Asian countries and often is concentrated in the poorest growing areas and among farmers with limited-resources. Sweet potatoes are grown by the small growers in the Slovak Republic. They reach our consumers in particular as imported goods. It would be appropriate to increase consumer interest in this kind of crops consumed less frequently, because it has a high content of mineral substances, vitamins and antioxidants as well as dietary fibre, carotenoids and anthocyanins.

REFERENCES

Anbuselvi, S., Kumar, M. S., Selvakumar, S., Rao, M. R. K., Dash A. 2012. A comparative study on biochemical constituents of sweet potatoes from Orissa and Tamilnadu and

its curd formation. *Journal of Chemical and Pharmaceutical Research*, vol. 4, no 11, p. 4879-4882.

Bellail, A. A., Shaltout, O. E., Youssef, M. M., El Gamal, A. M. A. 2012. Effect of Home-Cooking Methods on Phenolic Composition and Antioxidant Activity of Sweetpotato (*Ipomoea batatas* (L.) Lam.) Cultivars Grown in Egypt. *Food and Nutrition Sciences*, vol. 3, p. 490-499. <http://dx.doi.org/10.4236/fns.2012.34069>

Clifford, M. N., Johnston, K. L., Knight, S., Kuhnert, N. 2003. Hierarchical scheme for LC-MSn identification of chlorogenic acids. *Journal of Agricultural and Food Chemistry*, vol. 51, no. 10, p. 2900-2911. <https://doi.org/10.1021/jf026187q> PMID:12720369

Esatbeyoglu, T., Rodríguez-Werner, M., Schlösser, A., Winterhalter, P., Rimbach, G. 2017. Fractionation, enzyme inhibitory and cellular antioxidant activity of bioactives from purple sweet potato (*Ipomoea batatas*). *Food Chemistry*, vol. 221, p. 447-456. <https://doi.org/10.1016/j.foodchem.2016.10.077> PMID:27979226

Fu, Z., Tu, Z., Zhang, L., Wang, H., Wen Q., Huang T. 2016. Antioxidant activities and polyphenols of sweet potato (*Ipomoea batatas* L.) leaves extracted with solvents of various polarities. *Food Bioscience*, vol. 15, p. 11-18. <http://dx.doi.org/10.1016/j.fbio.2016.04.004>

Huang, Y. C., Chang, Y. H., Shao, Y. Y. 2006. Effects of Genotype and Treatment on the Antioxidant Activity of Sweet Potato in Taiwan. *Food Chemistry*, vol. 98, no. 3, p. 529-538. <https://doi.org/10.1016/j.foodchem.2005.05.083>

Ishida, H., Suzuno, H., Sugiyama, N., Innami S., Tadokoro, T., Maekawa, A. 2000. Nutritive evaluation on chemical components of leaves, stalks and stems of sweet potatoes (*Ipomoea batatas* Poir). *Food Chemistry*, vol. 68, no. 3, p. 359-367. [https://doi.org/10.1016/S0308-8146\(99\)00206-X](https://doi.org/10.1016/S0308-8146(99)00206-X)

Ishiguro, K., Yahara, S., Yoshimoto, M. 2007. Changes in polyphenols content and radical-scavenging activity of sweetpotato (*Ipomoea batatas* L.) during storage at optimal and low temperatures. *Journal of Agricultural and Food Chemistry*, vol. 55, no. 26, p. 10773-10778. <https://doi.org/10.1021/jf072256v> PMID:18038989

Jung, J. K., Lee, S. U., Kozukue, N., Levin, C. E., Friedman, M. 2011. Distribution of phenolic compounds and antioxidative activities in parts of sweet potato (*Ipomoea batata* L.) plants and in home processed roots. *Journal of Food Composition and Analysis*, vol. 24, no. 1, p. 29-37. <https://doi.org/10.1016/j.jfca.2010.03.025>

Lachman, J., Hamouz, K., Čepel, J., Pivec, V., Šulc, M., Dvořák, P. 2006. Influence of selected factors on polyphenol content and antioxidant activity of potato tubers (Article in Czech: Vliv vybraných faktorů na obsah polyfenolů a antioxidační aktivitu hlíz brambor). *Chemické listy*, vol. 100, no. 7, p. 522-527.

Laurie, S. M., Calitz, F. J., Adebola, P. O., Lezar, A. 2013. Characterization and evaluation of South African sweet potato (*Ipomoea batatas* (L.) LAM) land races. *South African Journal of Botany*, vol. 85, p. 10-16. <http://dx.doi.org/10.1016/j.sajb.2012.11.004>

Lukšič, L., Árvay, J., Vollmannová, A., Tóth, T., Škrabanja, V., Trček, J., Germ, M., Kreft, I. 2016. Hydrothermal treatment of Tartary buckwheat grain hinders the transformation of rutin to quercetin. *Journal of Cereal Science*, vol. 72, p. 131-134. <http://dx.doi.org/10.1016/j.jcs.2016.10.009>

- Maquia, I., Muocha, I., Naico, A., Martins, N., Gouveia, M., Andrade, I., Goulao, L. F., Ribeiro, A. I. 2013. Molecular, morphological and agronomic characterization of the sweet potato (*Ipomoea batatas* L.) germplasm collection from Mozambique: Genotype selection for drought prone regions. *South African Journal of Botany*, vol. 88, p. 142-151. <https://doi.org/10.1016/j.sajb.2013.07.008>
- Nozue, M., Souri, M., Arakawa, D., Kojima, M. 1998. Purification and characterization of two isoforms of chlorogenic acid oxidase from sweet potato cells in suspension culture. *Journal of Plant Physiology*, vol. 153, no. 5-6, p. 552-557. [https://doi.org/10.1016/S0176-1617\(98\)80203-4](https://doi.org/10.1016/S0176-1617(98)80203-4)
- Padda, M. S., Picha, D. H. 2008. Quantification of phenolic acids and antioxidant activity in sweetpotato Genotypes. *Scientia Horticulturae*, vol. 119, no. 1, p. 17-20. <https://doi.org/10.1016/j.scienta.2008.07.008>
- Padmaja, G. 2009. Uses and Nutritional Data of Sweetpotato. In Loedenstein, G., Thottappilly, G. *The Sweetpotato*. Netherlands : Springer, p. 189-234. ISBN 978-1-4020-9175-0. https://doi.org/10.1007/978-1-4020-9475-0_11
- Pandi, J., Glatz, P., Forder, R., Ayalew, W., Waramboi, J., Chousalkar, K. 2016. The use of sweet potato (*Ipomoea batatas* (L.) Lam) root as feed ingredient for broiler finisher rations in Papua New Guinea. *Animal Feed Science and Technology*, vol. 214, p. 1-11. <https://doi.org/10.1016/j.anifeeds.2016.01.011>
- Rautenbach, F., Faber, M., Laurie, S., Laurie, R. 2010. Antioxidant Capacity and Antioxidant Content in Roots of 4 Sweetpotato Varieties. *Journal of Food Science*, vol. 75, no. 5, p. C400-C405. <https://doi.org/10.1111/j.1750-3841.2010.01631.x> PMID:20629859
- Rumbaoa, R. G. O., Cornago, D. F., Geronimo, I. M. 2009. Phenolic content and antioxidant capacity of Philippine sweet potato (*Ipomoea batatas*) varieties. *Food Chemistry*, vol. 113, no. 4, p. 1133-1138. <https://doi.org/10.1016/j.foodchem.2008.08.088>
- Shih, M. C., Kuo, C. C., Chiang, W. 2009. Effects of drying and extrusion on colour, chemical composition, antioxidant activities and mitogenic response of spleen lymphocytes of sweet potatoes. *Food Chemistry*, vol. 117, no. 1, p. 114-121. <https://doi.org/10.1016/j.foodchem.2009.03.084>
- Steed, L. E., Truong, V. D. 2008. Anthocyanin Content, Antioxidant Activity, and Selected Physical Properties of Flowable Purple-Fleshed Sweetpotato Purees. *Journal of Food Science*, vol. 73, no. 5, p. S215-S221. <https://doi.org/10.1111/j.1750-3841.2008.00774.x> PMID:18577013
- Suárez, M. H., Hernández, A. I. M., Galdón, B. R., Rodríguez, L. H., Cabrera, C. E. M., Mesa, D. R., Rodríguez-Rodríguez, E. M., Romero, C. D. 2016. Application of multidimensional scaling technique to differentiate sweet potato (*Ipomoea batatas* (L.) Lam) cultivars according to their chemical composition. *Journal of Food Composition and Analysis*, vol. 46, p. 43-49. <http://dx.doi.org/10.1016/j.jfca.2015.10.008>
- Sun, H., Mu, T., Xi, L., Zhang, M., Chen, J. 2014. Sweet potato (*Ipomoea batatas* L.) leaves as nutritional and functional foods. *Food Chemistry*, vol. 156, p. 380-389. <http://dx.doi.org/10.1016/j.foodchem.2014.01.079>
- Šlosár, M., Mezeyová, I., Hegedúšová, A., Golian, M. 2016. Sweet potato (*Ipomoea batatas* L.) growing in conditions of southern Slovak republic. *Potravinarstvo*, vol. 10, no. 1, p. 384-392.
- Taira, J., Taira, K., Ohmine, W., Nagata, J. 2013. Mineral determination and anti-LDL oxidation activity of sweet potato (*Ipomoea batatas* L.) leaves. *Journal of Food Composition and Analysis*, vol. 29, no. 2, p. 117-125. <http://dx.doi.org/10.1016/j.jfca.2012.10.007>
- Teow, Ch. C., Truong, V. D., McFeeters, R. F., Thompson, R. L., Pecota, K. V., Yencho, G. C. 2007. Antioxidant activities. phenolic and β -carotene contents of sweet potato genotypes with varying flesh colours. *Food Chemistry*, vol. 103, no. 3, p. 829-838. <https://doi.org/10.1016/j.foodchem.2006.09.033>
- Waramboi, J. G., Dennien, S., Gidley, M. J., Sopade, P. A. 2011. Characterisation of sweetpotato from Papua New Guinea and Australia: Physicochemical, pasting and gelatinisation properties. *Food Chemistry*, vol. 126, no. 4, p. 1759-1770. <https://doi.org/10.1016/j.foodchem.2010.12.077> PMID:25213955
- Woolfe, J. A. 1992. *Sweet potato: An untapped food resource*. Great Britain : University Press, Cambridge. 643 p. ISBN 0-521-40295-6.
- Xu, W., Liu, L., Hu, B., Sun, Y., Ye, H., Ma, D., Zeng, X. 2014. TPC in the leaves of 116 sweet potato (*Ipomoea batatas* L.) varieties and Pushu 53 leaf extracts. *Journal of Food Composition and Analysis*, vol. 23, no. 6, p. 599-604. <https://doi.org/10.1016/j.jfca.2009.12.008>
- Yoshimoto, M., Yahara, S., Okuno, S., Shahidul, I. M., Ishiguro, K., Yamakawa, O. 2002. Antimutagenicity of Mono- Di-, and Tricaffeoylquinic Acid Derivatives Isolated from Sweetpotato (*Ipomoea batatas* L.) Leaf. *Bioscience, Biotechnology, and Biochemistry*, vol. 66, no. 11, p. 2336-2341. <https://doi.org/10.1271/bbb.66.2336> PMID:12506969

Acknowledgments:

This work was supported by grant VEGA No. 1/0290/14 and by Research Center AgroBioTech built in accordance with the project Building Research Center „AgroBioTech” ITMS 26220220180.

Contact address:

Janette Musilová, Slovak University of Agriculture, Faculty of Biotechnology and Food Sciences, Department of Chemistry, Tr. A. Hlinku 2, 949 76 Nitra, Slovakia, E-mail: janette.musilova@uniag.sk

Judita Bystrická, Slovak University of Agriculture, Faculty of Biotechnology and Food Sciences, Department of Chemistry, Tr. A. Hlinku 2, 949 76 Nitra, Slovakia, E-mail: judita.bystricka@centrum.sk

Július Árvay, Slovak University of Agriculture, Faculty of Biotechnology and Food Sciences, Department of Chemistry, Tr. A. Hlinku 2, 949 76 Nitra, Slovakia, E-mail: julius.arvay@gmail.com

Luboš Hrangozo, Slovak University of Agriculture, Faculty of Biotechnology and Food Sciences, Department of Chemistry, Tr. A. Hlinku 2, 949 76 Nitra, Slovakia, E-mail: lubos.harangozo@uniag.sk



EFFECT OF PROTEIN CONCENTRATE SUPPLEMENTATION ON THE COMPOSITION OF AMINO ACIDS IN MILK FROM DAIRY COWS IN AN ORGANIC FARMING SYSTEM

Pavel Horký, Jiří Skládanka, Pavel Nevrkla, Daniel Falta, Iva Čáslavová, Pavel Knot

ABSTRACT

Our experiment examined the effect of feeding a protein concentrate supplement on the composition of amino acids in milk from dairy cows managed in an organic farming system. The experiment included two groups of cows. Animals in both groups received an identical basic feed ration composed of maize silage, clover-grass haylage from the first cutting, grass haylage from the first cutting, winter wheat and spring barley. The first group of dairy cows ($n = 10$) served as a control without the addition of protein concentrate to the feed ration. The second experimental group ($n = 10$) received in addition to the basic feed ration a protein concentrate composed of soybean, sunflower and linseed cakes at rate 1 kg per head per day. The experiment lasted 30 days. Milk analysed for amino acid content was sampled at 10-day intervals. Addition of the protein concentrate significantly increased milk contents of aspartic acid, proline, threonine, glycine, alanine and glutamic acid. A significant decrease of valine also was recorded in milk from the experimental group. The results of our experiment show that a protein concentrate supplement can affect concentrations of some amino acids in milk from dairy cows.

Keywords: cow; protein concentrate; milk; amino acid; organic farming

INTRODUCTION

Organic farming currently creates a significant part of livestock and is receiving more and more attention in all its sectors (Horký et al., 2012; Jančíková et al., 2012; Herbut, 2013; Horký et al., 2013).

Milk is classified as a basic raw material in the nutrition of animals and humans. Dairy cow nutrition can affect its composition: the amount of protein, fat, fatty acids, spectrum of amino acids (Nevrkla et al., 2013; Gustavsson et al., 2014; Horký, 2014). The use of a protein concentrate based on sunflower and soybean cakes affects the composition of unsaturated amino acids in milk (Maxin et al., 2013; Křížová et al., 2013). Linseed cake contains alpha-linolenic acid, which may pass into the meat and milk of farm animals (Matthaus, 2004). Vegetable oil industry by-products can increase not only the content of unsaturated fatty acids in milk but also some milk components, particularly protein and fat content (Vargas-Bello-Perez et al., 2013). Feeding a protein concentrate composed of faba bean and sunflower cakes can also boost milk production (Avondo et al., 2013; Lipinski et al., 2013). Individual protein feeds are characterized by different degradation rates in the rumens of ruminants. Due to these differences in degradation, various protein feeds can influence milk composition in different ways (Maxin et al., 2013; Svoboda et al., 2016).

When feeding soybean protein concentrate to dairy cows, it should be taken into account that this feedstuff is digested in particular by the enzymes chymotrypsin, trypsin, pepsin and cysteine protease (Banach et al., 2013). A range of inhibitors can cause problems in the digestion of these protein concentrates (Espejo-Carpio et al., 2013; Belakova et al., 2015). Methionine is limiting essential amino acid in the milk. Lower content is in alanine (57.8%), arginine (52%), aspartic acid (87%), cysteine (59.4%), glycine (35.3%), histidine (96.8%), and serine (83.8%) after the conversion (to the amount of methionine) from non-essential amino acids. Other amino acids are in excess of the required amount (Čermáková et al., 2012). The amount of protein can be increased by-pass protein and in this way to rise the amount of histidine, lysine, and methionine. Glucose plays a central role (Maxin et al., 2013). The additive of abductive amino acids in the diet of dairy cows (methionine, phenylalanine, histidine) may also increase the concentration of these amino acids in milk (Sizova and Zelenina, 2010). Mammary gland itself can regulate the synthesis of certain amino acids as needed (Choi et al., 2002). Amino acids in cow's milk are distinguished by high lysine content and, in contrast, the lowest level of tryptophan (Siciliano et al., 2013). Degradable and undegradable nitrogen is separated in the rumen. Microbial protein is formed from the

degradable protein and then continues on to the duodenum. In the duodenum, microbial protein is broken down into individual amino acids which pass into the blood (Masoero et al., 2011).

The objective of our experiment was to ascertain the effect of a protein concentrate composed of soybean, sunflower and linseed cakes on amino acid content in milk. The partial aim of the study was to assess the relationship between individual amino acids in milk of dairy cows. The impact of the protein concentrate on milk yield in dairy cows managed in an organic farming system was also measured. Protein concentrate can be expected to increase both protein content in milk generally and the concentrations of specific amino acids.

MATERIAL AND METHODOLOGY

The experiment was conducted on an organic farm (the farm was registered in accordance with the Czech Republic's Act No. 242/2000 Coll. under registration number 42318335) keeping dairy cattle at Lesoňovice, Czech Republic. It included 20 Holstein dairy cows divided into two equal groups by weight (the experimental group had an average weight of 622 ±15 kg; the average weight of the control group was 630 ±11 kg) and at the same stage of lactation. Dairy cows in the experimental group had completed an average of 3.4 ±0.1 lactations prior to the experiment while cows in the control group had completed an average of 3.6 ±0.1 lactations. Average milk yield of the animals was 7,600 ±50 kg/lactation. All animals were fed a basic feed ration in the form of a total mixed ration (Table 1) and were allowed ad libitum access to water. The quantity of feed provided was recorded by the mixer-wagon (Luclar, Czech Republic). Uneaten amounts were estimated and not in any way analysed. The first experimental group of dairy cows (n = 10) had its basic feed ration supplemented with a protein concentrate (soybean cake 60%, sunflower cake 20%, linseed cake 20%) at the rate of 1 kg of dry matter per head per day. The crude protein content of the supplement was 36.6%. Individual amino acid contents in the basic feed ration and protein concentrate are shown in Table 2. The components of the protein concentrate all had originated from organically grown materials.

The second group of cows (n = 10) served as a control and received no supplemental protein concentrate in the feed ration. The nutrient contents of the feed rations for the two groups are presented in Table 3. At the start of the experiment, the experimental group of dairy cows was on

average at day 52 of lactation (ranging from day 41 to 65). The average stage of lactation period in the control group of cows at the beginning of the experiment was 56 days (ranging from day 38 to 60). The cows were kept in loose housing and fed twice daily (morning and evening). The experimental period was 30 days. Milk samples were taken before the experiment and then every tenth day (10th, 20th and 30th days). Milk samples were collected prior to the early feeding and then analysed (Figure 1).

Analysis of feed mixture

Standard AOAC International procedures (2005) were used to determine the contents of crude protein, crude fat and starch in the ration. Crude protein content ($6.25 \times N$) was determined using a Kjeltec 1030 Auto Analyser, and crude fat content was determined with a Soxtec 1043 (FOSS Tecator AB, Höganäs, Sweden). Neutral detergent fibre (NDF) was measured following a protocol described elsewhere (Mertens et al., 2002), and acid detergent fibre (ADF) was determined according to procedure 973.18 of the AOAC (2000). Determination of PDIN (protein digested in the small intestine when rumen-fermentable nitrogen is limiting), PDIE (protein digested in the small intestine when rumen-fermentable energy is limiting) and NEL (net energy for lactation) was made in accordance with procedures described elsewhere (Zeman et al., 2006).

Determination of amino acids

Amino acids were determined by ion-exchange liquid chromatography (Model AAA-400 amino acid analyser, Ingos, Czech Republic) using post-column derivatization with ninhydrin and a VIS detector. A glass column (inner diameter 3.7 mm, length 350 mm) was filled manually with a strong cation exchanger in the LG ANB sodium cycle (Laboratory of Spolchemie) with average particles size 12 µm and 8% porosity. The column was tempered within the range 35 to 95 °C. Elution of the studied amino acids took place at a column temperature set to 74 °C. A double-channel VIS detector with inner cell volume of 5 µL was set to two wavelengths: 440 and 570 nm. A solution of ninhydrin (Ingos, Czech Republic) was prepared in 75% v/v methyl cellosolve (Ingos, Czech Republic) and in 2% v/v 4 M acetic buffer (pH 5.5). Tin chloride (SnCl₂) was used as a reducing agent. The prepared solution of ninhydrin was stored in an inert atmosphere (N₂) in darkness at 4 °C. The flow rate was 0.25 mL.min⁻¹, and the reactor temperature was 120 °C.

Table 1 Composition of the feed ration and dairy cows' average daily intake per head (Dry matter.kg⁻¹)

Feedstuff	Control group	Experimental group
Maize silage	6.38	6.38
Clover-grass haylage	5.95	5.95
Grass haylage	4.00	4.00
Winter wheat	2.64	2.64
Spring barley	1.76	1.76
Protein concentrate ^a	-	1.00
Detamin GA Spezial ^b	0.13	0.13
Total intake	20.86	21.86

Note: ^bDetamin GA Spezial is a mineral supplement for ruminants intended to be used in organic farming systems (H. Wilhelm Schaumann GmbH, Pinneberg, Germany).

Table 2 Intake of amino acids by control and experimental groups of dairy cows (g.day dry matter⁻¹).

Amino acid	Control group	Experimental group
Lysine	105.6	130.7
Methionine	44.2	52.0
Threonine	104.2	122.5
Tryptophan	24.0	30.5
Arginine	123.4	160.5
Histidine	48.2	60.1
Isoleucine	115.3	137.5
Leucine	200.2	234.2
Phenylalanine	115.0	137.8
Valine	123.4	146.7
Tyrosine	79.4	95.0

Note: ^bDetamin GA Spezial is a mineral supplement for ruminants intended to be used in organic farming systems (H. Wilhelm Schaumann GmbH, Pinneberg, Germany).

Table 3 Nutrient content of feed rations for experimental and control groups of dairy cows (per kg of dry matter).

Component	Control group	Experimental group
Starch (g)	79.6	78.7
Crude protein (g)	132.0	145.9
Fat (g)	27.0	28.9
PDIN (g)	80.1	90.2
PDIE (g)	79.5	84.2
NEL (MJ)	6.4	6.5
ADF (g)	263.9	269.8
NDF (g)	403.2	411.2

Note: PDIN = protein digested in the small intestine when rumen-fermentable nitrogen is limiting, PDIE = protein digested in the small intestine when rumen-fermentable energy is limiting, NEL = net energy for lactation, ADF = acid detergent fibre, NDF = neutral detergent fibre.

Sample preparation for determination of amino acids in feed ration

Before the amino acids analysis, acid and oxidative hydrolyses were performed on the samples. For the acid hydrolysis, 150 mg of the sample was weighed directly into the hydrolysis container. Then, 15 mL hydrochloric acid (6 mol.L⁻¹) was added to the weighed sample. To remove air, argon was subsequently bubbled through the content of the hydrolysis container for 30 seconds. After the completion of hydrolysis, the content of the container was quantitatively transferred by hydrochloric acid (0.1 mol.L⁻¹) through filtration paper into an evaporation flask. The filtrate was evaporated three times in a vacuum evaporator in a water bath set at 50 °C until it had a syrupy consistency. It was rinsed three times with 0.1 mol.L⁻¹ hydrochloric acid. The remainder after evaporation was quantitatively transferred by buffer solution (pH 2.2) into a 25 mL volumetric flask. The remaining sample solution was then filtered through a microfilter into an Eppendorf microcentrifuge tube and used for amino acid analysis. For oxidation of the sample for oxidative hydrolysis, 1 g of the freeze-dried sample was weighed out into an Erlenmeyer flask. An oxidation mixture of 90 mL formic acid and 10 mL hydrogen peroxide was prepared. This mixture was left for 2 hours at 22 °C, then cooled for 15 minutes at 10 °C. Next, 15 mL of the oxidation mixture was added to the sample. After careful blending of the mixture with the sample, the flask was left for 24 hours at 10 °C. Then, 1 mL of concentrated hydrochloric acid was added to the oxidized sample followed by 50 mL of hydrochloric acid (6 mol.L⁻¹). A reflux condenser was

placed on the Erlenmeyer flask, and the flask was placed in an oil bath where it underwent oxygen hydrolysis for 24 hours at 118 °C. After hydrolysis, the contents of the flask were quantitatively transferred through filtration paper into a 250 mL volumetric flask, which was filled with 0.1 mol.L⁻¹ hydrochloric acid. Then, 25 mL of the sample was pipetted into an evaporation flask. The subsequent filtration process was identical as in the case of the acid hydrolysis. Samples prepared in microcentrifuge tubes were analysed using the AAA 400 amino acid analyser. Amino acid separation proceeded in an ion-exchange column through increasing pH, regulated using sodium citrate buffers (buffer range: pH 2.6 – 7.9). After leaving the column, individual amino acids entered into a reaction with ninhydrin.

The subsequent process was the same as for determination of the milk samples.

Assessment of milk components

The milk was preserved using 2-bromo-2-nitropropane-1,3-diol and cooled to 4 – 6 °C until analysed. The analysis was carried out within hours of the sampling. Milk components were analysed in a commercial laboratory using a MilkoScan FT2 (Foss Electric, Hillerød, Denmark). Fat was established acidobutyrometrically according to standard CSN ISO 2446. Crude protein was established by the Kjeldahl method according to CSN 57 0530. Urea in milk was determined enzymatically using a commercially available urea/ammonia assay kit (Megazyme, Wicklow, Ireland) according to CSN 57 0533.

Statistics

The data were processed statistically using STATISTICA.CZ, version 10.0 (Czech Republic). Results are expressed as mean ± standard deviation (SD). Statistical significance was determined by examining the basic differences between among individual samples using ANOVA and Scheffé's test (two-way analysis, level of protein concentrates, day of sampling) for the parameters aspartic acid, proline, valine, tyrosine, arginine, threonine, glycine, methionine, phenylalanine, serine, alanine, isoleucine, histidine, glutamic acid, leucine and lysine. Differences with $p < 0.05$ were considered significant. Dependence between individual amino acids was expressed by means of a linear equation and correlation coefficient R.

RESULTS AND DISCUSSION

The study focused on evaluating the influence of this protein mixture on changes in the composition of amino acids in milk from the experimental animals. The values obtained for amino acid content were averaged within each of the two groups (control and experimental) and subsequently converted to percentages with average values at the beginning of the experiment representing 100%. The results are illustrated in continuous charts (at all times for four samplings).

In dairy cows, being fed with the protein concentrate, milk content of aspartic acid and proline increased with 22.3% ($p < 0.001$) and 9.5% ($p < 0.05$), respectively, while no changes were observed in milk from cows fed the control diet (Figure 2A and B). The cows receiving the protein supplement exhibited a decreasing trend for valine level in milk from the beginning of the experiment. At the end of the experiment, the overall decrease of this amino acid was 22.1% ($p < 0.05$), (Figure 2C). No significant changes were observed in amino acids such as tyrosine and

arginine in the experimental and control groups of dairy cows (Figure 2D and E). The amount of threonine and glycine (Figure 2F and G) increased by 49.1% ($p < 0.001$) respectively by 34.9% ($p < 0.001$) in the experimental group. There were no significant differences found in the evaluation of methionine, phenylalanine and serine in the experimental and control groups of cows (Figure 2H, I and J). Alanine (Figure 2K) showed no significant differences in the control group. The experimental group exhibited increasing amounts of this amino acid from the beginning of the experiment, and the amount of alanine at the fourth sampling was higher by 30% ($p < 0.01$). In milk of dairy cows, no significant changes of histidine and isoleucine amount were reported in the experimental and control groups (Figure 2L and M). The increase of glutamic acid (Figure 2N) was observed of 16.5% ($p < 0.001$) in the test group of dairy cows with the addition of protein concentrate. Amino acids such as leucine and lysine were not significantly changed in the experimental and control group of cows (Figure 2O and P).

Inter-relationships among the individual amino acids were ascertained by calculating Pearson correlation coefficients. As shown in Table 4, the highest correlation coefficients were found between histidine and phenylalanine ($R^2 = 0.951$), phenylalanine and leucine ($R = 0.925$), and histidine and leucine ($R = 0.921$).

In evaluating milk yield and the amounts of protein and fat, no significant difference was found between cows of the control and experimental groups. Urea concentration in the milk of the experimental group was significantly different starting from the second sampling. By the end of the experiment, the urea in the milk had increased by 83.2% for the experimental group ($p < 0.001$) in comparison with the first sampling, as can be seen in Table 5.



Figure 1 The sampling of milk.

In our experiment, increases in the content of the amino acids aspartic acid, threonine, glycine, serine, and alanine were observed following protein concentrate supplementation. The protein supplement was also associated with increased urea level in milk while milk yield as well as fat and protein content were not affected.

The direct addition of amino acids (methionine, histidine, phenylalanine) in the diet of dairy cows increased the concentrations of these amino acids not only in the blood and in milk as well. Protein concentrate has not brought this effect in our monitoring (Sizova and Zelenina, 2010). It proves to be more effective to add abductive methionine and lysine directly into the diet of dairy cows in

comparison with protein concentrate. Abductive methionine and lysine increase directly the content of these amino acids in milk. Soya, linen and sunflower cake did not prove to be so effective. In an experiment conducted in Poland, a basic feed ration (maize silage, alfalfa silage and sugar beet pulp) was supplemented with linseed cake at 10% of the total ration. In that case, cows fed the supplemental linseed cake had higher milk production. The milk produced had lower fat and protein content compared to a control group of dairy cows without linseed cake supplementation (Osiegowski et al., 2007). In contrast, no significant differences were found out in performance of dairy cows in our monitoring. The significant increase of

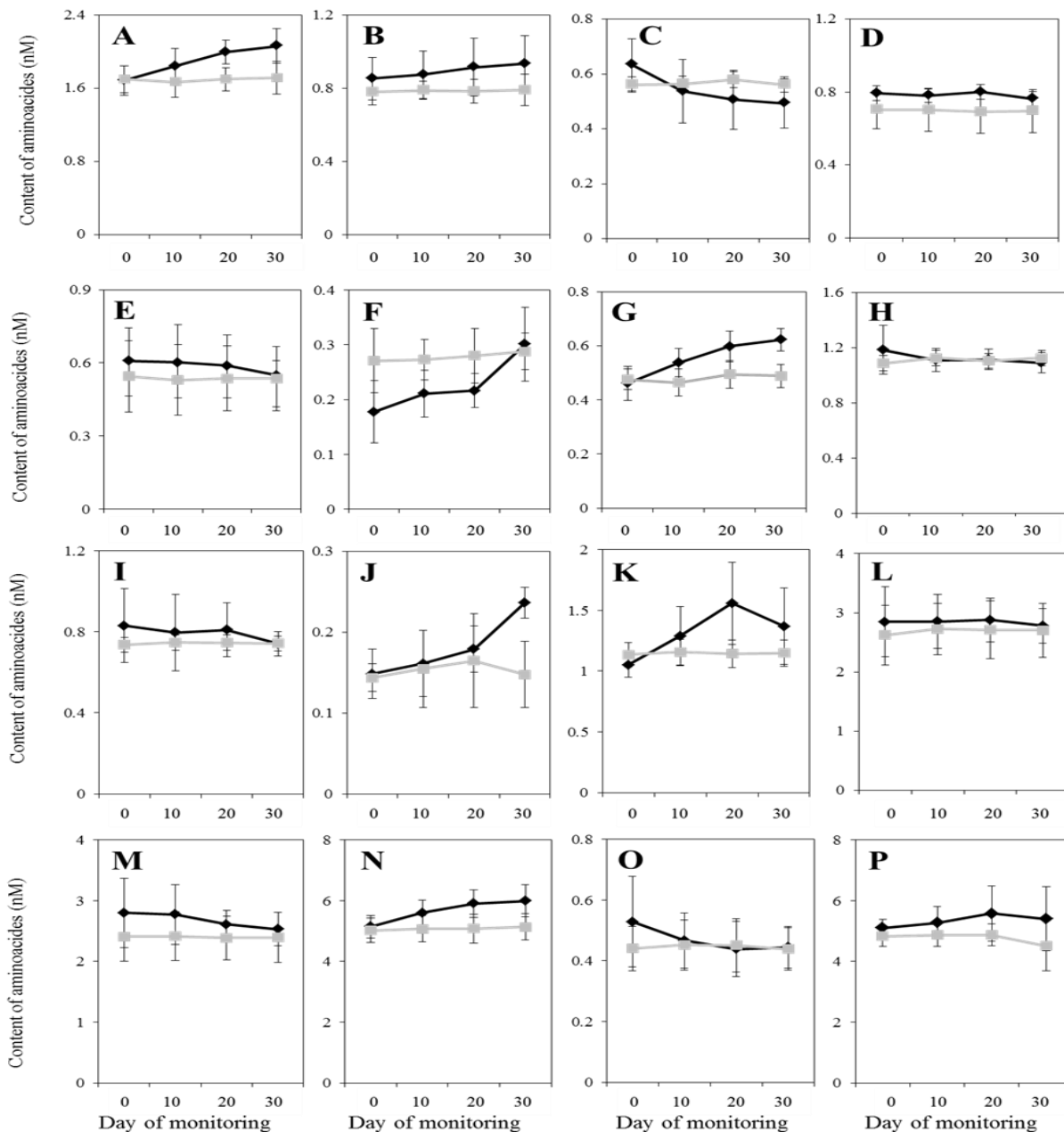

Figure 2 Effect of protein concentrate on amino acid contents in milk during 30 days of experimentation. Note: A = aspartic acid, B = proline, C = valine, D = tyrosine, E = arginine, F = threonine, G = glycine, H = methionine, I = phenylalanine, J = serine, K = alanine, L = isoleucine, M = histidine, N = glutamic acid, O = leucine, P = lysine. Black connecting line illustrates development in the control group of cows (n=10). Grey connecting line illustrates development in the experimental group of cows (n = 10).

Table 4 Correlations among the studied amino acids occurring in milk of experimental group of cows.

	Asp	Pro	Val	Tyr	Arg	Thr	Gly	Met	Phe	Ser	Ala	Ile	His	Glu	Cys	Leu	Lys
Asp		0.7	-0.1	-0.2	0.0	-0.3	-0.2	-0.1	-0.5	-0.6	0.7	-0.5	-0.3	0.5	0.1	-0.4	0.5
Pro	0.7		-0.3	-0.2	-0.4	-0.4	-0.3	-0.2	-0.5	-0.3	0.6	-0.4	-0.4	0.5	0.0	-0.4	0.3
Val	-0.1	-0.3		0.8	0.9	0.1	-0.4	0.9	0.7	0.8	-0.7	0.6	0.8	-0.7	0.7	0.9	-0.8
Tyr	-0.2	-0.2	0.8		0.7	-0.1	-0.4	0.7	0.6	0.8	-0.6	0.9	0.6	-0.5	0.4	0.8	-0.8
Arg	0.0	-0.4	0.9	0.7		0.1	-0.1	0.9	0.8	0.5	-0.6	0.7	0.9	-0.7	0.8	0.9	-0.6
Thr	-0.3	-0.3	0.1	-0.1	0.1		0.3	-0.1	0.2	0.1	-0.2	0.0	0.3	0.0	0.1	0.1	-0.2
Gly	-0.2	-0.3	-0.4	-0.4	-0.1	0.3		-0.3	0.0	-0.3	0.2	0.0	0.1	0.1	0.0	-0.2	0.3
Met	-0.1	-0.2	0.9	0.7	0.9	-0.1	-0.3		0.8	0.7	-0.7	0.6	0.8	-0.9	0.9	0.9	-0.8
Phe	-0.5	-0.5	0.7	0.6	0.8	0.2	0.0	0.8		0.6	-0.9	0.8	0.9	-0.9	0.7	0.9	-0.8
Ser	-0.6	-0.3	-0.7	0.8	0.5	0.1	-0.3	0.7	0.6		-0.8	0.7	0.6	-0.7	0.5	0.8	-0.9
Ala	0.7	0.6	0.6	-0.6	-0.6	-0.2	0.2	-0.7	-0.9	-0.8		-0.8	-0.8	0.9	-0.4	-0.9	0.9
Ile	-0.5	-0.4	0.8	0.9	0.7	0.0	0.0	0.6	0.8	0.7	-0.8		0.7	-0.6	0.4	0.8	-0.8
His	-0.3	-0.4	0.8	0.6	0.9	0.3	0.1	0.8	0.9	0.6	-0.8	0.7		-0.8	0.8	0.9	-0.8
Glu	0.5	0.5	-0.7	-0.5	-0.7	0.0	0.1	-0.9	-0.9	-0.7	0.9	-0.6	-0.8		-0.7	-0.9	0.8
Cys	0.1	0.0	0.7	0.4	0.8	0.1	0.0	0.9	0.7	0.5	-0.4	0.4	0.8	-0.7		0.8	-0.9
Leu	-0.4	-0.4	0.9	0.8	0.9	0.1	-0.2	0.9	0.9	0.8	-0.9	0.8	0.9	-0.9	0.8		0.9
Lys	0.5	0.3	-0.8	-0.8	-0.6	-0.2	0.3	-0.8	-0.8	-0.9	0.9	-0.8	-0.8	0.8	-0.6	-0.9	

Note: lys = lysine, leu = leucine, cys = cysteine, glu = glutamic acid, his = histidine, ile = isoleucine, ala = alanine, ser = serine, phe = phenylalanine, met = methionine, gly = glycine, thr = threonine, arg = arginine, tyr = tyrosine, val = valine, pro = proline, asp = aspartic acid.

urea was observed in milk. At the same time, another group of authors confirm that supplementation by protein feed increases milk yield and milk protein (Choi et al., 2002). None of these effects were observed in our case. In another reported experiment, cottonseed cake was fed at 0% (control group), 5%, 10% and 15% of the total ration (Madzimore et al., 2011). In that case, the control group showed the highest daily milk yield (12.1 kg.day⁻¹) while the lowest milk yield was recorded in dairy cows fed with the ration containing 15% cottonseed cake (7.5 kg.day⁻¹). In comparison with cows in the experimental groups, those in the control group had the highest amount of fat in their milk ($p < 0.05$). The experimental group of cows receiving 15% cottonseed cake exhibited a significantly higher percentage of milk protein ($p < 0.05$) as compared with the control group. It was not possible to confirm an increase in milk's protein content in our case. In our view, the dose of the protein concentrate would be necessary to increase to investigate the effect on milk production. In another experiment with Holstein cows, a protein concentrate with rumen-protected methionine was added to the cows' diet. The milk of cows receiving the methionine-enriched diet exhibited increased protein ($p < 0.05$) as compared with the milk of cows without the supplement (Třináctý et al., 2009). In an experiment involving goats, those receiving rumen-protected soybean protein showed a significantly higher percentage (3.54%) of fat in their milk ($p < 0.001$) as compared with the milk fat percentage for the control group of animals without the supplement (3.14%). That

experimental group had exhibited a similar increase in the concentration of urea ($p < 0.05$), (Chowdhury et al., 2002).

The influence of additions of protein concentrates and additions of mineral compounds were tested on dairy cow yield in the ecological farming. Although, mineral compounds (selenium) did not increase the yield of dairy cow, the animal health was increased. From this reason, the combination of protein concentrates is recommended in combination with antioxidants leads to improve the quality of milk and health state of animals (Horký 2015). According to several authors, the mycotoxins could decrease the protein bioavailability in the dairy cow diets (Horký and Cerkal, 2014). Not only mycotoxins have an impact on protein digestibility, but the content of phytoestrogens could decrease the utilization of nitrogenous compounds. For further monitoring, it would be beneficial to study these factors (Hloucalová et al., 2016). According to these results, it can be suggested that the addition of abductive methionine and soya protein has a higher efficiency to increase proteins in milk than protein concentrate used in our monitoring. The abduction of cake could be the part of further research with the aim to rise up by-pass protein. When feeding soybeans to dairy cows, researchers have used two different treatments. In the first method, feeding roasted soybeans yielded no significant differences in the concentrations of fat and protein in milk.

It also did not affect organic matter digestibility. In our experiment, the experimental group of dairy cows

Table 5 Effect of supplemental protein concentrate on the components of milk as measured by both quantitative and qualitative indicators.

Days of experiment	Control group				Experimental group			
	Milk yield (kg)	Protein (g.100mL ⁻¹)	Fat (g.100mL ⁻¹)	Urea (g.100mL ⁻¹)	Milk yield (kg)	Protein (g.100mL ⁻¹)	Fat (g.100mL ⁻¹)	Urea (mg.100mL ⁻¹)
0	26.9 ±1.9	3.4 ±0.2	4.2 ±0.3	26.2 ±4.5	27.1 ±2.9	3.2 ±0.2	4.2 ±0.1	21.4 ±3.2
10	28.2 ±2.3	3.5 ±0.3	4.3 ±0.6	25.1 ±3.2	28.9 ±1.6	3.3 ±0.3	4.3 ±0.3	37.4 ±3.1***
20	27.8 ±1.8	3.3 ±0.1	4.1 ±0.5	22.2 ±3.2	28.3 ±1.6	3.3 ±0.2	4.1 ±0.3	37.9 ±5.2***
30	27.6 ±2.0	3.4 ±0.2	4.4 ±0.4	25.3 ±3.6	27.5 ±4.2	3.4 ±0.2	4.5 ±0.4	39.2 ±4.0***

Note: ***Statistically significant difference in comparison with the first sampling ($p < 0.001$).

exhibited a significant decrease of valine in their milk, which could point to a decreased rate of catabolism in these animals.

CONCLUSION

In our experiment, organically managed dairy cows were fed a protein concentrate based on linseed, sunflower and soybean cakes. The protein concentrate supplementation significantly increased the amounts in milk of aspartic acid (+22.3%; $p < 0.001$), proline (+9.5%; $p < 0.05$), threonine (+49.1%; $p < 0.001$), glycine (+34.9%; $p < 0.001$), alanine (+30.0%; $p < 0.01$) and glutamic acid (+16.5%; $p < 0.001$). The control group of cows exhibited stable amino acids content in their milk throughout the experiment. The results demonstrate a favourable influence of feeding the protein concentrate on the contents of selected amino acids in the milk of cows. Differences in the aforementioned amino acids can increase the nutritive value of the milk produced, and such product therefore becomes more valuable for final consumers.

REFERENCES

Avondo, M., Pagano, R. I., De Angelis, A., Pennisi, P. 2013. Diet choice by goats as effect of milk production level during late lactation. *Animal*, vol. 7, no. 7, p. 1113-1118. <http://dx.doi.org/10.1017/S1751731113000244>

Banach, J. C., Lin, Z., Lamsal, B. P. 2013. Enzymatic modification of milk protein concentrate and characterization of resulting functional properties. *Lwt-Food Science and Technology*, vol. 54, no. 2, p. 397-403. <http://dx.doi.org/10.1016/j.lwt.2013.06.023>

Běláková, S., Benešová, K., Mikulíková, H., Svoboda, M., The occurrence of ochratoxin A in beers, *Kvasný průmysl*, 2015, vol. 61, p. 34-37.

Čermáková, J., Kudrna, V., Illek, J., Blažková, K., Haman, J. 2012. Effects of a rumen-protected form of methionine and a methionine analogue on the lactation performance of dairy cows. *Czech Journal of Animal Science*, vol. 57, no. 9, p. 410-419.

Espejo-Carpio, F. J., De Gobba, C., Guadix, A., Guadix, E. M., Otte J. 2013. Angiotensin I-converting enzyme inhibitory activity of enzymatic hydrolysates of goat milk protein fractions. *International Dairy Journal*, vol. 32, no. 2, p. 175-183. <http://dx.doi.org/10.1016/j.idairyj.2013.04.002>

Gustavsson, F., Buitenhuis, A. J., Johansson, M., Bertelsen, H. P., Glantz, M., Poulsen, N. A., Mansson, H. L., Stalhammar, H., Larsen, L. B., Bendixen, C., Paulsson, M., Andren, A. 2014. Effects of breed and casein genetic variants on protein profile in milk from Swedish Red, Danish Holstein, and Danish Jersey cows. *Journal of Dairy Science*,

vol. 97, no. 6, p. 3866-3877. <http://dx.doi.org/10.3168/jds.2013-7312>

Herbut, P. 2013. Temperature, humidity and air movement variations inside a free-stall barn during heavy frost. *Annals of Animal Science*, vol. 13, no. 3, p. 587-596. <http://dx.doi.org/10.2478/aoas-2013-0025>

Hloucalová, P., Skládanka, J., Horký, P., Klejdus, B., Pelikán, J., Knotová, D. 2016. Determination of phytoestrogen content in fresh-cut legume forage. *Animals*, vol. 46, no. 6, p. 1-15. <https://doi.org/10.3390/ani6070043>

Horký, P. 2014. Effect of protein concentrate supplement on the qualitative and quantitative parameters of milk from dairy cows in organic farming. *Annals of Animal Science*, vol. 14, no. 2, p. 341-352. <http://dx.doi.org/10.2478/aoas-2014-0008>

Horký, P. 2015. Effect of selenium on its content in milk and performance of dairy cows in ecological farming. *Potravinárstvo*, vol. 9, no. 1, p. 219-224. <https://doi.org/10.5219/492>

Horký, P., Cerkal, R. 2014. Effect of Fungicidal Treatment on Digestibility of Mycotoxins In Vitro. *Potravinárstvo*, vol. 8, no. 1, p. 328-332. <https://doi.org/10.5219/409>

Horký, P., Jančíková, P., Sochor, J., Hynek, D., Chavis, G.J., Ruttkey-Nedecký, B., Cernei, N., Zítka, O., Zeman, L., Adam, V., Kizek, R. 2012. Effect of Organic and Inorganic Form of Selenium on Antioxidant Status of Breeding Boars Ejaculate Revealed by Electrochemistry. *International Journal of Electrochemical Science*, vol. 7, no. 10, p. 9643-9657.

Horký, P., Ruttkey-Nedecký, B., Kremplová, M., Kryštofová, O., Kensová, R., Hynek, D., Babula, P., Zítka, O., Zeman, L., Adam, V., Kizek, R. 2013. Effect of Different Doses of Organically Bound Selenium on Antioxidant Status and Levels of Metal Ions in Postpartum Sows. *International Journal of Electrochemical Science*, vol. 8, no. 5, p. 6162-6179.

Choi, C. W., Vanhatalo, A., Ahvenjarvi, S., Huhtanen, P. 2002. Effects of several protein supplements on flow of soluble non-ammonia nitrogen from the forestomach and milk production in dairy cows. *Animal Feed Science and Technology*, vol. 102, no. 1-4, p. 15-33. [http://dx.doi.org/10.1016/S0377-8401\(02\)00251-1](http://dx.doi.org/10.1016/S0377-8401(02)00251-1)

Chowdhury, S. A., Rexroth, H., Kijora, C., Peters, K. J. 2002. Lactation performance of German Fawn goat in relation to feeding level and dietary protein protection. *Asian-Australasian Journal of Animal Sciences*, vol. 15, no. 2, p. 222-237. <https://doi.org/10.5713/ajas.2002.222>

Jančíková, P., Horký, P., Zeman, L. 2012. The effect of feed additive containing vitamins and trace elements on the elements profile and growth of skin derivatives in horses. *Annals of Animal Science*, vol. 12, no. 3, p. 381-391.

- Křížová, L., Hanuš, O., Roubal, P., Kučera, J., Hadrová, S. 2013. The effect of cattle breed, season and type of diet on nitrogen fractions and amino acid profile of raw milk. *Archiv Tierzucht*, vol. 56, no. 71, p. 709-718.
- Lipinski, K., Skorko-Sajko, H., Purwin, C., Antoszkiewicz, Z., Werpachowski, M. 2013. Effect of xylanase supplementation to cereal-based diets on apparent fecal digestibility and growth performance of pigs. *Annals of Animal Science*, vol. 13, no. 2, p. 303-311. <http://dx.doi.org/10.2478/aoas-2013-0011>
- Madzimure, J., Musimurimwa, C., Chivandi, E., Gwiriri, L., Mamhare, E. 2011. Milk yield and quality in Guernsey cows fed cottonseed cake-based diets partially substituted with baobab (*Adansonia digitata* L.) seed cake. *Tropical Animal Health and Production*, vol. 43, no. 1, p. 77-82. <http://dx.doi.org/10.1007/s11250-010-9656-5>
- Masoero, F., Gallo, A., Zanfi, C., Giuberti, G., Spanghero, M. 2011. Effect of nitrogen fertilization on chemical composition and rumen fermentation of different parts of plants of three corn hybrids. *Animal Feed Science and Technology*, vol. 164, no. 3-4, p. 207-216. <http://dx.doi.org/10.1016/j.anifeedsci.2011.02.001>
- Matthaus, B. 2004. Camelina sativa - revival of an old vegetable oil? *Ernährungs-Umschau*, vol. 51, no. 1, p. 12-16.
- Maxin, G., Ouellet, D. R., Lapierre, H. 2013. Effect of substitution of soybean meal by canola meal or distillers grains in dairy rations on amino acid and glucose availability. *Journal of Dairy Science*, vol. 96, no. 12, p. 7806-7817. <http://dx.doi.org/10.3168/jds.2013-6976>
- Mertens, D. R., Allen, M., Carmany, J., Clegg, J., Davidowicz, A., Drouches, M., Frank, K., Gambin, D., Garkie, M., Gildemeister, B., Jeffress, D., Jeon, C.S., Jones, D., Kaplan, D., Kim, G. N., Kobata, S., Main, D., Moua, X., Paul, B., Robertson, J., Taysom, D., Thiex, N., Williams, J., Wolf, M. 2002. Gravimetric determination of amylase-treated neutral detergent fiber in feeds with refluxing in beakers or crucibles: Collaborative study. *Journal of AOAC International*, vol. 85, no. 6, p. 1217-1240. [PMid:12477183](https://pubmed.ncbi.nlm.nih.gov/12477183/)
- Nevrkla, P., Čechová, M., Hadaš, Z. 2013. Evaluation of selected reproductive parameters in gilts and loss of piglets after repopulation. *Acta Universitatis Agriculturae et Silviculturae Mendelianae Brunensis*, vol. 61, no. 5, p. 1357-1364. <http://dx.doi.org/10.11118/actaun201361051357>
- Osieglowski, S., Strzetelski, J. A., Zymon, M., Kowalczyk, J. 2007. Effect of fish oil and high or low linolenic acid linseed or rapeseed on fatty acid composition of cow's milk. *Annals of Animal Science*, vol. 7, no. 1, p. 63-74.
- Siciliano, R. A., Mazzeo, M. F., Arena, S., Renzone, G., Scaloni, A. 2013. Mass spectrometry for the analysis of protein lactosylation in milk products. *Food Research International*, vol. 54, no. 1, p. 988-1000. <http://dx.doi.org/10.1016/j.foodres.2012.10.044>
- Sizova, Y. V., Zelenina, A. S. 2010. Productivity and technological properties of cow milk at various aminoacid composition of metabolic protein ration. *Sel'skokhozyaistvennaya Biologiya*, no. 6, p. 50-53.
- Svoboda, Z., Mikulíková, H., Pluháčková, H., Běláková, S., Benešová, K. 2016. Analysis of Essential Oils Usable for Fortification of Food Products, *Kvasný průmysl*, no. 62, p. 157-160.
- Třináctý, J., Křížová, L., Richter, M., Černý, V., Říha, J. 2009. Effect of rumen-protected methionine, lysine or both on milk production and plasma amino acids of high-yielding dairy cows. *Czech Journal of Animal Science*, vol. 54, no. 6, p. 239-248.
- Vargas-Bello-Perez, E., Vera, R. R., Aguilar, C., Lira, R., Pena, I., Fernandez, J. 2013. Feeding olive cake to ewes improves fatty acid profile of milk and cheese. *Animal Feed Science and Technology*, vol. 184, no. 1-4, p. 94-99. <http://dx.doi.org/10.1016/j.anifeedsci.2013.05.016>
- Zeman, L., Doležal, P., Mrkvicová, E., Prochazková, J., Ryant, P., Skládanka, J., Straková, E., Suchý, P., Veselý, P., Zelenka, J. 2006. *Výživa a krmení hospodářských zvířat*. 1st ed. PRAHA, Czech Republic : Profi Press. 360 p. ISBN 80-86726-17-7.

Acknowledgments:

This project was funded from grants IGA TP1/2016 New trend in the cultivation and use of milk thistle (*Silybum Marianum* L.) in agriculture.

Contact address:

Pavel Horky, Mendel University in Brno, Faculty of Agronomy, Department of Animal Nutrition and Forage Production, Zemedelska 1, 613 00 Brno, Czech Republic, E-mail: pavel.horky@mendelu.cz

Jiří Skládanka, Mendel University in Brno, Faculty of Agronomy, Department of Animal Nutrition and Forage Production, Zemedelska 1, 613 00 Brno, Czech Republic, E-mail: jiri.skladanka@mendelu.cz

Pavel Nevrkla, Mendel University in Brno, Faculty of Agronomy, Department of Animal Breeding, Zemedelska1, 613 00 Brno, Czech Republic, E-mail: pavel.nevrkla@mendelu.cz

Daniel Falta, Mendel University in Brno, Faculty of Agronomy, Department of Animal Breeding, Zemedelska1, 613 00 Brno, Czech Republic, E-mail: daniel.falta@mendelu.cz

Iva Časlavová, Mendel University in Brno, Faculty of Agronomy, Department of Animal Nutrition and Forage Production, Zemedelska 1, 613 00 Brno, Czech Republic, E-mail: iva.caslavova@mendelu.cz

Pavel Knot, Mendel University in Brno, Faculty of Agronomy, Department of Animal Nutrition and Forage Production, Zemedelska 1, 613 00 Brno, Czech Republic, E-mail: pavel.knot@mendelu.cz

COMPARISON OF ADSORPTIVE WITH EXTRACTIVE STRIPPING VOLTAMMETRY IN ELECTROCHEMICAL DETERMINATION OF RETINOL

Milan Sýs, Simona Žabčíková, Libor Červenka, Karel Vytřas

ABSTRACT

Adsorptive stripping voltammetry (AdSV) of retinol at solid glassy carbon electrode (GCE), carbon paste electrode (CPE) covered by thin layer of multi-wall carbon nanotubes (CPE/MWCNTs) and carbon paste electrode covered by thin layer of single layer graphene (CPE/Graphene) was compared with an extractive stripping voltammetry (ExSV) into silicone oil (SO) as lipophilic binder of glassy carbon paste electrode (GCPE). All types of selected working electrodes were characterized by a scanning electron microscopy to determine overall morphology of electrode surfaces together with spatial arrangement of used carbon particles. The retinol, also known as vitamin A₁, was chosen as a model analyte because it is the most biologically active representative of retinoids which are classified as a significant group of lipophilic vitamins. Based on this comparison, it was observed that electrochemical method with high sensitivity (ExSV at GCPE) is generally characterized by shorter linear range of the calibration curve than in case of AdSV at CPE/MWCNTs or CPE/Graphene. Unlike AdSV at solid GCE, all other tested electrochemical methods could represent suitable analytical tools for monitoring of retinoids in different types of foodstuffs. Especially, content of retinol up to tenths milligrams can be easily determined using ExSV. Additionally, negative interference of chemical species present in real samples is minimal in comparison with direct voltammetric methods performed in supporting electrolytes based on organic solvents due to application of accumulation step in “ex-situ” mode.

Keywords: adsorptive voltammetry; carbon nanotubes; extractive voltammetry; glassy carbon; graphene; retinol

INTRODUCTION

In food analysis, stripping voltammetry in combination with some pulse electrochemical techniques may offer up ultratrace electroanalytical method comparable to the inductively coupled plasma mass spectrometry (ICP-MS) (Abdel-Galeil et al., 2014), especially in determination of heavy metals (Švancara et al., 2010).

According to different variants of deposition steps, analytical methods based on stripping voltammetry can be divided to several variants such as conventional stripping voltammetry with an electroplating step when the accumulation of an analyte on electrode surface is controlled by electrolysis (Hočevar et al., 2007) (i), adsorptive stripping voltammetry (AdSV) when the mentioned accumulation is realized by an adsorption of an analyte on electrode surface (Kalvoda and Kopanica, 1989) (ii), extractive stripping voltammetry (ExSV) where the analyte is extracted from a sample matrix into a paste liquid of a heterogeneous electrode (Wang and Freiha, 1984) (iii) stripping voltammetry based on specific reaction at chemically modified electrodes (Murray et al., 1987) (iv). From an electroanalytical point of view, it can be assumed that all these variants of stripping voltammetry

exist in two opposite modes; anodic (ASV) or cathodic stripping voltammetry (CSV).

But it is important to note that the above adsorption on the electrode surface is always preceded by extraction into the interior of the electrode material (adsorptive/extractive accumulation process). It is major reason why you can meet a term adsorptive/extractive stripping voltammetry in the scientific literature (Wang et al., 1985; Tuzhi et al., 1990; Cookeas et al., 1992).

As a further example of using the ExSV can be considered voltammetric determination of iodide where corresponding authors called the extraction of the iodide into a carbon paste electrode (CPE) based on tricresyl phosphate (TCP) as synergistic type of accumulation (Švancara et al., 1998).

In this case, it is very difficult to determine where an electrochemical reaction of extracted analyte takes place, mostly at the interface between selected paste liquid and an aqueous supporting electrolyte. The discipline dealing with this issue is known as so-called liquid/liquid interfaces electrochemistry (Samec, 2004).

In this contribution, comparison of AdSV at solid GCE, CPE covered by thin layer of multi-wall carbon nanotubes

(CPE/MWNTs) and CPE covered by thin layer of single layer graphene (CPE/Graphene) with ExSV at glassy carbon paste electrode (GCPE) containing silicone oil (SO) as paste binder in determination of retinol is presented.

The retinol has the highest biological activity of a series of carotenoids which belong to lipophilic vitamins (Goodman, 1984). They can be classified as fat-soluble chemical compounds essential for human health (Webster, 2012). Due to insolubility in aqueous solutions, their electrochemical determination by voltammetric techniques is rather complicated.

Direct voltammetric determination of selected lipophilic vitamins at solid glassy carbon electrode (GCE) in 0.05 mol.L⁻¹ lithium perchlorate in a methanol/benzene (2:1) mixture (Atuma et al., 1975), at a rotating GCE in methanolic solution using lithium perchlorate (Hernández Méndez et al, 1988), at CPE in aqueous-organic mixtures with presence of detergent Triton X-100 (Jaiswal et al., 2001), at GCE modified MWCNTs in 0.1 mol.L⁻¹ HClO₄ with acetonitrile (ACN) (Ziyatdinova et al, 2012) etc. has two main disadvantages, namely high consumption of organic solvents and relatively low sensitivity.

The first our contribution published in this scientific journal was focused on explanation of anodic AdSV application in simultaneous electrochemical detection of lipophilic vitamins in the margarine within one analysis. In this paper, it was unfortunately reported that the AdSV at bare GCE is not sensitive analytical method for determination of all lipophilic vitamins (Sýs et al., 2016), especially retinol (vitamin A₁) and cholecalciferol (vitamin D₃).

Based on this finding, the retinol as a model analyte was chosen to investigate whether the sensitivity in the electrochemical determination of lipophilic vitamins can be significantly increased by adsorption of selected carbon nanomaterials (CNs) characterized by high specific surface area, conductivity and lipophilic properties (Komarov and Mironov, 2004; Lu, et al., 2012) or by extraction into paste binder.

A reaction mechanism of retinol electrochemical oxidation has not been completely elucidated yet. The electrochemical oxidation of retinol with formation of retinal with participation of 2 e⁻ and 2 H⁺ was proposed based on observation only one oxidation peak at 0.85 V during cyclic voltammetry at GCE in 0.1 mol.L⁻¹ LiClO₄ in acetonitrile-ethanol media (Ziyatdinova et al., 2010).

However, this statement is incorrect because similar electrochemical behaviour was found for the esters of retinol which devoid a free hydroxyl group (Tan et al., 2014). According to electron density of retinyl propionate, it was predicted that electrochemical oxidation probably takes place on C3-position of cyclohexene ring with participation of 2 e⁻ and H⁺ (Masek et al., 2014).

MATERIAL AND METHODOLOGY

Chemicals and reagents

Synthetic retinol (crystalline) of purity ≥95%, *N,N*-dimethylformamide (DMF) and 99.8% acetonitrile (ACN) were purchased from Sigma Aldrich (Praha, Czech Republic). A stock solution of 0.01 mol.L⁻¹ retinol was prepared by dissolving the appropriate amount of this

substance in pure ACN. Due to chemical instability of the retinol, this solution had to be stored in a freezer at -5 °C. Glacial acetic acid and sodium acetate from Merck (Darmstadt, Germany) together with ultrapure water ($\rho = 18.3 \text{ M}\Omega \text{ cm}$; Milli-Q system, Millipore) were used for preparing 0.1 mol.L⁻¹ acetate (pH 4.5) buffer.

Sodium hydroxide, potassium hydroxide, potassium chloride, 65% nitric acid, 35% hydrochloric acid, 96% sulfuric acid from Lach Ner (Neratovice, Czech Republic) and sodium phosphate, potassium phosphate from PENTA (Prague, Czech Republic) were necessary for preparation of other supporting electrolytes which were tested in pH study.

Apparatus

All electrochemical measurements were carried out in a 50 mL glass cell at 25 °C. Conventional three-electrode system consisting always one of tested working electrodes, Ag/AgCl and 3.0 mol.L⁻¹ KCl as salt bridge (reference) and platinum wire (auxiliary) electrode which were together connected to potentiostat Autolab PGSTAT101 from Metrohm (Prague, Czech Republic) which is also compatible with software Nova version 1.11. Scanning electron microscopy (SEM) used for characterization of all tested working electrodes was performed at VEGA3 SB (TESCAN, Czech Republic).

Preparation of working electrodes

Pretreatment of glassy carbon electrode

Surface of solid GCE (diameter 2 mm) from already mentioned Metrohm (Prague, Czech Republic) was renovated on polishing pad with presence of wet Al₂O₃ powder (particle size 1.0 μm) for 30 s and subsequently placed in an ultrasonic bath for 5 minutes. After subsequent rinsing of the surface by distilled water, the GCE was ready for new electrochemical experiment.

Preparation of glassy carbon paste electrode

The GCPE was prepared by mixing of 0.3 g glassy carbon powder Sigradur-G (distribution of particle size 5 – 20 μm) from HTW Hochtemperatur-Werkstoffe GmbH (Maintingen, Germany) and 0.052 g silicone oil MV 8000 (SO) from Lučební závody (Kolín, Czech Republic) in ceramic mortar for 20 min. Resulting homogenous paste was pressed into the cavity (diameter 3 mm) of Teflon piston-like electrode holder. It is very important to note that the height of column in the cavity must be less than 2 cm due to difficult extrusion of glassy carbon paste.

Freshly made paste electrodes should not be employed generally in any experiments due to their rather unstable electrochemical behavior caused by an incomplete homogenization. Thus, it is recommended to leave both used types of paste electrodes (GCPE and conventional CPE) at the laboratory conditions for one day. Only after this self-homogenization process, paste electrodes are really suitable for following voltametric measurements (Mikysek et al., 2009).

Preparation of conventional carbon paste electrode

Conventional CPE was prepared by the same way like previously mentioned GCPE; only different carbon powder (graphite) CR-2 type (particle size <2 μm) from Maziva

Týn nad Vltavou (Týn nad Vltavou, Czech Republic) was used. Unlike GCPE, resulting carbon paste based on graphite powder may occupy the entire cavity of the electrode holder. Extrusion of carbon paste can be carried out without problems due to shape of graphite particles resembling sheets.

Immobilization of selected carbon nanomaterials

Conventional CPE was covered by thin layer of graphene (resistivity $\leq 0.30 \Omega \text{ cm}$; specific surface area $400 - 1000 \text{ m}^2 \cdot \text{g}^{-1}$) from ACS Material, LLC (Medford, USA) or MWCNTs (diameter $10 - 30 \text{ nm}$; length $5 - 15 \mu\text{m}$; specific surface area $40 - 300 \text{ m}^2 \cdot \text{g}^{-1}$) from Shenzhen Nanotech Port Co., Ltd. (Shenzhen, China) by simple immobilization which is consisted by applying of $20 \mu\text{L}$ corresponding dispersion of the carbon nanomaterial (CN) in DMF ($2 \text{ mg} \cdot \text{mL}^{-1}$) on the surface of the CPE at laboratory temperature for 24 hours.

It should be noted that before the immobilization of CNs, these two dispersions of MWCNTs without any pre-treatment and single layer graphene with high surface area had to be homogenised by ultrasound at laboratory temperature for 60 min (Sýs et al., 2015).

Procedure

AdSV or ExSV of retinol were performed in two separate steps. In the first step, the adsorption of analyte on GCE, CPE/MWCNTs and CPE/Graphene surfaces or its extraction into SO of GCPE were realized by immersing of selected working electrode in an aqueous-acetonitrile solutions (25% content of ACN) containing $100 \mu\text{mol} \cdot \text{L}^{-1}$ of the retinol at 400 rpm for 10 min. In second one, differential pulse voltammetry (DPV) of accumulated retinol was performed in $0.01 \text{ mol} \cdot \text{L}^{-1}$ acetate (pH 4.5) buffer from 0 to +1.4 V at potential step (E_{step}) 5 mV, potential of amplitude (E_{amp}) 25 mV, interval time (t) 0.1 s and scan rate (v) $50 \text{ mV} \cdot \text{s}^{-1}$. Otherwise, all changes in the experimental conditions described above are specified below, in the legends of the corresponding figures.

Statistical analysis

Evidently, one of the most important criterion of an analytical method is its sensitivity (Hallett, 1960). Generally, the sensitivity of every analytical method is given by a slope of corresponding calibration curve. From analytical point of view, each analytical method is characterized by other parameters such as linearity of calibration curve, limit of quantification (LOQ) and limit of detection (LOD).

This LOD is usually defined by the lowest value of an analyte concentration which can be reliably detected. It is usually assessed by linear regression of the calibration curve applying the following equation 1 (MacDougall and Crummett, 1980),

$$\text{LOD} = \frac{3\sigma}{S} \quad (1)$$

where: the σ presents the standard deviation of the response and S is slope of the calibration curve. In a narrower sense, the standard deviation is usually calculated from the lowest signal responses obtained for five repetitions (n) minimally. This procedure is used

especially in voltammetric methods where the theoretical value of the LOD calculated from a baseline of background current response would not probably corresponded to reality.

RESULTS AND DISCUSSION

Characterisation of working electrode surfaces

Nowadays, scanning electron microscopy (SEM) is already routine tools for characterisation of electrode surfaces morphology. Due to particle size of glassy carbon powder around $5 \mu\text{m}$, scale of magnification $50 \mu\text{m}$ was used. In Figure 1, SEM images of working electrode surfaces (CPE/MWCNTs; A, CPE/Graphene; B and GCPE; C) are shown (magnification scale bar of $50 \mu\text{m}$). At the first glance, it is evident that the structures of these electrode surfaces are significantly different.

Unlike the smooth surface of solid GCE (not shown SEM) and other working electrodes, the surface of CPE/MWCNTs is the least homogeneous. It can be assumed that the homogeneity of each surface structure depends on the arrangement of used carbon particles (nanotubes). For example, immobilized MWCNTs create irregular skeins of various sizes and multifaceted range of interconnection. Moreover, no functionalized MWCNTs by a pretreatment in mixture of strong inorganic acids (Sun et al., 2002; Kuzmany et al., 2004) are characterized by high lipophilicity which can cause significant increasing of retinol adsorption. On the other hand, it has to be clear unfortunately that mentioned weak homogeneity can have dominant effect on adsorption reproducibility, therefore significantly reduce sensitivity.

CPE/Graphene electrode

Surface of the CPE covered by thin layer of graphene reminds a structure of a coarse cloth probably due to mutual impaction of the graphene nanosheets having a typical planar configuration (Zhu et al., 2010). Overall, it can be stated that the surface is characterized by higher homogeneity than in the previous case of MWCNTs. It is thus not surprising that more satisfactory reproducibility of adsorption will be assumed.

Glassy carbon paste electrode

From the physical point of view, glassy carbon paste can be defined as a dispersion of conductive glassy carbon beads in lipophilic paste binder which is moreover non-conductive and viscous (Švancara et al., 1996).

Generally, an electric contact between graphite sheets of graphite powder in a CPE (not shown SEM) is better than between beads of glassy carbon in a GCPE because significant part of each particle of glassy carbon is covered by thin layer of the paste binder. For this reason, glassy carbon pastes are suitable (stable) electrode materials for electrochemical measurements in aqueous organic mixtures (Dejmkova et al., 2012; Sýs et al., 2016).

In fact, glassy carbon paste inside cavity of electrode holder is a column full of small beads where free spaces between glassy carbon particles are filled by sticky lipophilic binder. Consequently, there are not any changes in structure after each restoration and polishing of electrode surface which results in satisfactory reproducibility.

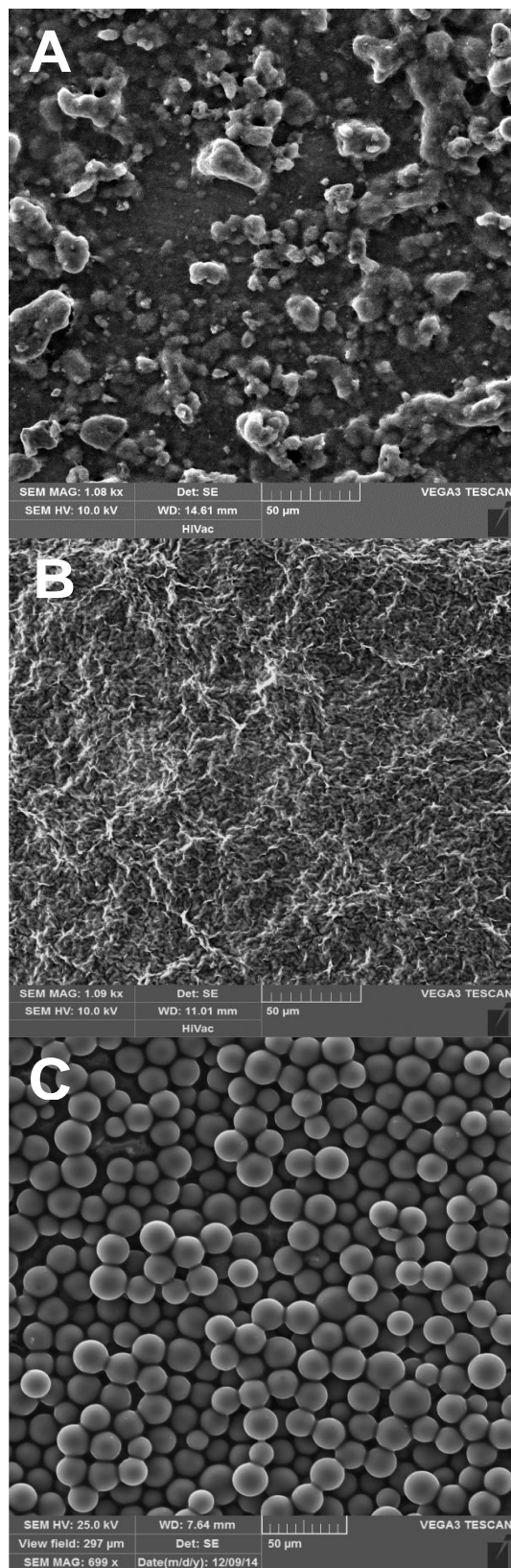

Figure 1 SEM images of CPE/MWCNTs (A), CPE/Graphene (B) and GCPE (C) surface structures. CPE/MWCNTs electrode.

Electrochemical behaviour of retinol

Retinol adsorbed on GCE surface in 0.1 mol.L⁻¹ acetate (pH 4.5) buffer provides two peaks at anodic potential (E_p^a) 0.680 and 1.075 V similarly like at the GCE in

methanolic (95%) 0.05 mol.L⁻¹ acetate (pH 5) buffer solution (Wring et al., 1988).

Surprisingly at other tested electrodes, the retinol provides three oxidation peaks as following: $E_{p1}^a = 0.750$ V; $E_{p2}^a = 0.970$ V; $E_{p3}^a = 1.330$ V at CPE/MWCNTs, $E_{p1}^a = 0.725$ V; $E_{p2}^a = 1.090$ V; $E_{p3}^a = 1.240$ V at CPE/Graphene and $E_{p1}^a = 0.670$ V; $E_{p2}^a = 1.080$ V; $E_{p3}^a = 1.230$ V at GCPE. In comparison with literature (Atuma et al., 1975), this phenomenon was also obtained by voltammetric measurements of a retinyl palmitate at GCE in a mixture of two organic solvents.

In all these cases, it was found that the most sensitive peak current response (I_p) was always observed for the first anodic peak (Figure 2). In this paper, values of I_p are expressed as current density (j) due to different surface area of working electrodes.

Optimization of the working conditions

From physical point of view, adsorption efficiency is predominantly determined by specific surface area of used nanomaterials. In contrast with the previous case, extraction efficiency is determined by an extraction equilibrium constant (K) affected by many factors such as selection of paste binder, selection of organic solvent miscible with water, their volumetric ratio (ϕ), their polarity represented by appropriate dielectric constants (ϵ_r), time of accumulation, speed of stirring, temperature, presence of salts etc.

From the previous paragraph it is evident that the overall optimization depends on finding optimal working conditions. In contrast with conventional stripping voltammetry where an analyte accumulation is controlled by electrolysis, AdSV together with ExSV represent to optimize time-consuming analytical methods.

Effect of carbon nanomaterials amount

In contrast with CNs functionalized by different kinds of functional groups (McAllister, et al, 2007), unmodified

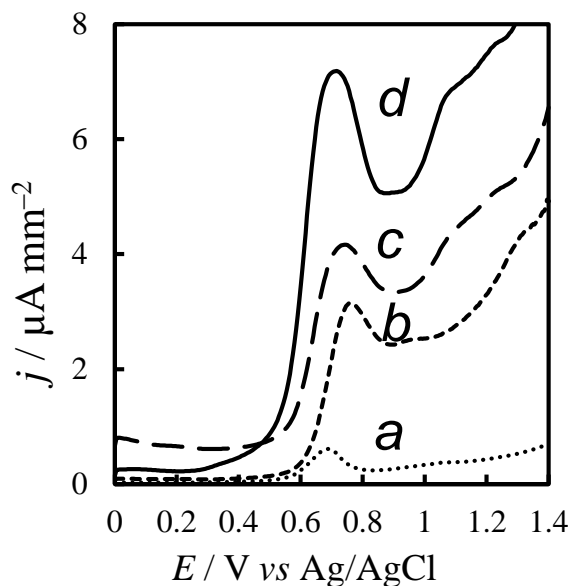

Figure 2 Voltammetric responses of 100 μmol.L⁻¹ retinol adsorbed on surfaces of GCE (a), CPE/MWCNTs (b), CPE/Graphene (c) and extracted into GCPE with 15% SO (d).

MWCNTs and single layer graphene can be classified as suitable electrode materials for accumulation of fat-soluble vitamins by the adsorption due to their high lipophilicity.

During optimization of appropriate amount of MWCNTs and graphene immobilized on CPE surface, it was found that a presence of these CNs did not have any effect on shifting of E_{p1}^a which could be theoretically caused by their catalytic actions.

Oddly enough, it was observed that any presence of tested CNs caused statistically significant increasing of retinol current density due their high specific surface area. The highest value of the current density was observed at electrodes having $\sim 5.7 \mu\text{g}$ CNs immobilized on 1.0 mm^2 electrode surface. It is reason why $20 \mu\text{L}$ dispersion of these CNs ($2 \text{ mg}\cdot\text{mL}^{-1}$) onto electrode surface with diameter 3 mm was used.

Effect of paste binder amount

Fundamentally, it is considered that selection of the optimum paste binder depends on an analyte polarity. One rule to remember is “like dissolves like”, which means that ionic or polar solutes (which have a charge or slight charge) will dissolve in similarly polar solvents.

Based on comparison of dielectric constants of common paste binders (paraffin oil (PO); 4.6 – 4.8; paraffin wax (PW); 2.1 – 2.5; polypropylene (PP); 1.5; silicone oil (SO); 2.2 – 2.9 and vaseline (VA); 2.2 – 2.9), it seems that GCPE prepared from mentioned PP should be the best choice but it is not, unfortunately. An explanation can be found in different electrochemical properties of unmodified carbon pastes (Švancara and Schachl, 1999).

According to previous experience (Sýs et al., 2016), silicone oil (SO) known as a traditional paste binder in preparation of GCPE was selected although more detailed study should be done. From Figure 3, it is clear that current density does not increase generally with the increasing of SO content in the GCPE. But, the highest values were obtained at GCPEs with 10% and 15% content of present paste binder.

Experimentally, it was found that the highest tolerated content of some paste binder is about 30% (Mikysek et al., 2009). Thus, it should be clear that any increasing of this content by extraction of retinol can cause significant deterioration of electrochemical characteristics, especially a substantial increase of ohmic resistance (R).

Effect of organic solvent amount

Selection of suitable organic solvent soluble in water and its content can dramatically affect the final efficiency of an accumulation step. An explanation why an ACN was chosen is relatively simple. In comparison with other eventual organic solvents, the ACN is totally miscible with water and it has high boiling point $82 \text{ }^\circ\text{C}$. Basically, it is necessary to prevent the evaporation of used organic solvent and thus to have constant working conditions during accumulation. During searching of optimum content of the ACN to determine retinol at GCE and GCPE it was found that 25% ACN content should be used to achieve optimum working conditions (Figure 4).

In this part of contribution, it is necessary to mentioned that always the the highest current response was obtained at 25% ACN, whether any content of silicone oil in GCPE and any amount of MWCNTs or single layer graphene

onto CPE surfaces was used. Theoretically, optimum amount of any organic solvent is defined by equilibrium distribution of certain analyte between two immiscible phases; working electrode and aqueous-organic mixture (Sýs and Vytřas, 2016).

Moreover, it was observed that any content of this organic solvent does not have any significant effect on negative increasing of background current response for solid electrode materials such as GCE and CPE covered by thin layer of carbon nanomaterials (not shown). However, it is necessary to remind that previous statement does not valid for carbon paste electrodes due to solubility of paste binders in organic solvents. The background current at GCPE with 15% SO increased with increasing of acetonitrile content.

Speed of stirring influence

The speed of stirring significantly affects the rate of retinol transport to an electrode surface where this analyte is adsorbed or can be further extracted into interior of the

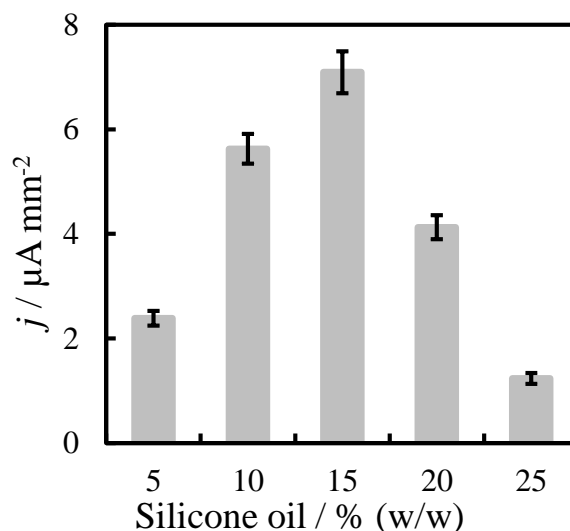

Figure 3 Dependence of retinol current density on content of paste binder.

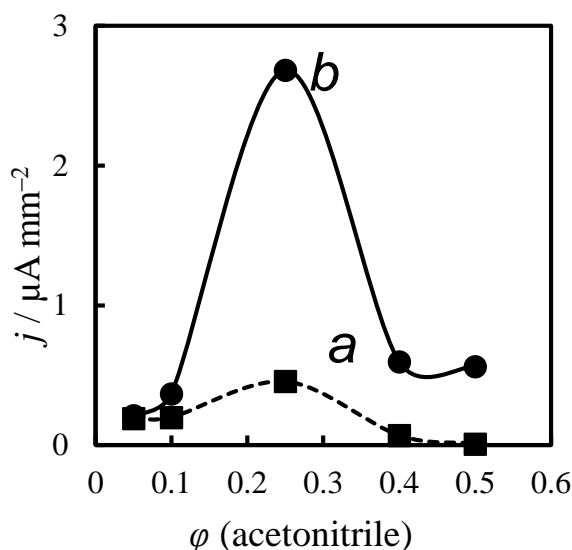

Figure 4 Dependency of current density obtained at solid GCE (a) and GCPE with 20% SO (b) on different ACN content used during accumulation step.

electrode material. In addition, the current density of voltammetric oxidation of the retinol is a linear function of its accumulated amount during adsorption or extraction. In this study, it was observed that values of speed of stirring higher than 400 rpm did not have any significant effect on the increasing of final current density. The value 400 rpm therefore was chosen as optimum.

Effect of accumulation time

The optimum time is defined as the time required to reach an equilibrium of retinol distributed between nonpolar electrode surface and used aqueous-organic mixture (“adsorption”) or also between nonpolar paste binder and previously mentioned mixture (“extraction”). Accumulation time is therefore the parameter which has fundamental effect on the sensitivity of studied variants of stripping voltammetry.

In both cases, it is possible to say with certainty that any significant increasing of the current density was not visible at values of the accumulation time higher than 15 min. However, it is important to state that 10 min is sufficient time to achieve the equilibrium for ExSV at GCPE with 15% SO content due to high relative standard deviation (RSD) about 8% which was calculated for 5 repetitions. In this case, values of retinol current density were statistically the same for 10 and 15 min of accumulation due to relatively high value of RSD. Thus, value 10 min was selected as optimum accumulation time.

Selection of suitable supporting electrolyte

Various supporting electrolytes such as 0.1 mol.L⁻¹ phosphate (pH 7.05) buffer, 0.1 mol.L⁻¹ acetate (pH 4.5) buffer, 0.1 mol.L⁻¹ KCl solution (pH 6.2), solutions of diluted inorganic acids like 0.05 mol.L⁻¹ H₂SO₄ (pH 1.13), 0.1 mol.L⁻¹ HCl (pH 1.02), 0.1 mol.L⁻¹ HNO₃ (pH 1.05) and alkaline solutions of 0.2 mol.L⁻¹ KOH (pH 13.4) or 0.1 mol.L⁻¹ NaOH (pH 12.3) were tested to achieve the

high sensitivity of final electrochemical methods. It was found that the best recognition of individual anodic peaks at potentials 0.395, 0.635 and 0.850 V was obtained at solid GCE using NaOH solution. Almost identical peak oxidation current responses of retinol were observed at 0.690 V (solid GCE) in solutions of strong inorganic acids. Corresponding peak potentials differed minimally (± 50 mV) according to types of used electrodes.

From analytical point of view, the highest current response of the first anodic peak was observed for 0.1 mol.L⁻¹ acetate (pH 4.5) buffer, and because of this, it was chosen as the optimum. By the way, direct voltammetric determination of retinol was previously performed in this acetate buffer (Wring et al., 1988; Filik et al., 2006). For demonstration, voltammograms of retinol obtained at solid GCE recorded in different selected supporting electrolytes are shown in Figure 5.

Comparison of AdSV with ExSV in retinol determination

Sensitivity of non-conventional voltammetric methods

Almost three times lower values of detection limits (LOD) were obtained at CPEs covered by thin layer of CNs than at solid GCE (see Table 1). Moreover, it is necessary to state that also linear range was three times prolonged at these modified working electrodes. Based on this finding, it can be concluded that an insignificant progress in the sensitivity of the AdSV was achieved using carbon nanomaterials.

Unlike solid GCE, relatively high values of background current were observed at GCPE, CPE/MWCNTs and CPE/Graphene. It is caused probably by presence of ACN at accumulation step. This phenomenon resulted in significantly high intercept values of calibration curves and therefore corresponding LODs cannot have lower values, unfortunately.

From all tested non-conventional electrochemical methods, the highest sensitivity in retinol determination was observed using ExSV at GCPE. However, it was determined that linearity of calibration curve was ranged only from 1.0 to 40 $\mu\text{mol.L}^{-1}$ retinol. In comparison with the ExSV, linear ranges of appropriate calibration curves obtained at CPE/MWCNTs and CPE/Graphene were found from 10 to 100 $\mu\text{mol.L}^{-1}$ retinol. For demonstration, calibration curve together with corresponding anodic voltammograms of retinol measured at the GCPE is shown in Figure 6.

Table 1 also shows interesting comparison of non-conventional voltammetric methods based on ex-situ accumulation step with other already developed voltammetric methods in retinol determination. Surprisingly, AdSV at different working electrodes and ExSV at GCPE presented in this contribution have significantly better analytical parameters than others.

Due to satisfactory sensitivity of ExSV, it can be predicted that electrochemical methods based on stripping voltammetry with synergistic type of accumulation could be alternative analytical method to reverse high-performance liquid chromatography (Hite, 2003) in determination of retinoids which are commonly used as food additives.

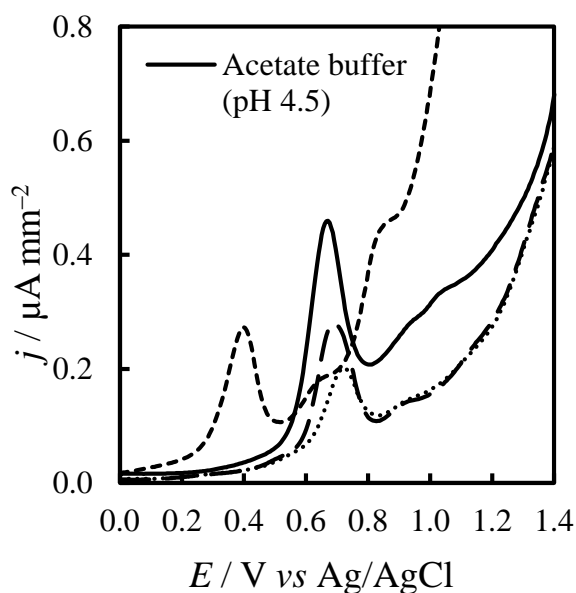

Figure 5 Voltammograms of 100 $\mu\text{mol.L}^{-1}$ retinol adsorbed from 25% ACN on solid GCE surface at 400 rpm for 10 min and subsequently electrochemically oxidized in different strictly aqueous electrolytes.

Table 1 Comparison of non-conventional voltammetric methods.

Sensor	Method	Linear range (mol.L ⁻¹)	LOD (mol.L ⁻¹)	References
GCE	DPV	–	4.7 × 10 ⁻⁵	(Wang, 2000)
TFME	DPV	–	8.8 × 10 ⁻⁶	(Wang, 2000)
TFLE	DPV	–	4.7 × 10 ⁻⁶	(Wang, 2000)
PtE	LSV	8.2 × 10 ⁻⁵ to 1.1 × 10 ⁻³	–	(Budnikov et al., 2004)
GCE	LSV	9.7 × 10 ⁻⁵ to 2.3 × 10 ⁻³	4.8 × 10 ⁻⁵	(Budnikov et al., 2005)
GCE	CV	2.9 × 10 ⁻⁵ to 9.8 × 10 ⁻⁴	1.5 × 10 ⁻⁷	(Ziyatdinova et al., 2010)
GE/MWCNTs	CV	5.0 × 10 ⁻⁵ to 1.5 × 10 ⁻³	4.0 × 10 ⁻⁵	(Ziyatdinova et al., 2012)
GCE/MWCNTs	SWV	5.0 × 10 ⁻⁶ to 2.0 × 10 ⁻⁴	8.0 × 10 ⁻⁷	(Filik et al., 2016)
GCE	AdSV	1.0 × 10 ⁻⁵ to 4.0 × 10 ⁻⁵	3.5 × 10 ⁻⁶	This paper
GCPE	ExSV	1.3 × 10 ⁻⁶ to 5.0 × 10 ⁻⁵	4.5 × 10 ⁻⁷	This paper
CPE/MWCNTs	AdSV	5.0 × 10 ⁻⁶ to 1.0 × 10 ⁻⁴	1.3 × 10 ⁻⁶	This paper
CPE/Graphene	AdSV	4.0 × 10 ⁻⁶ to 1.2 × 10 ⁻⁴	1.0 × 10 ⁻⁶	This paper

Note: CV; cyclic voltammetry, DPV; differential pulse voltammetry, GE/MWCNTs; multi-walled carbon nanotubes modified graphite electrode, LOD; limit of detection, LSV; linear sweep voltammetry, PtE; platinum disk electrode, SWV; square wave voltammetry, TFLE; thin-film lead deposited GCE, TFME and thin-film mercury deposited GCE.

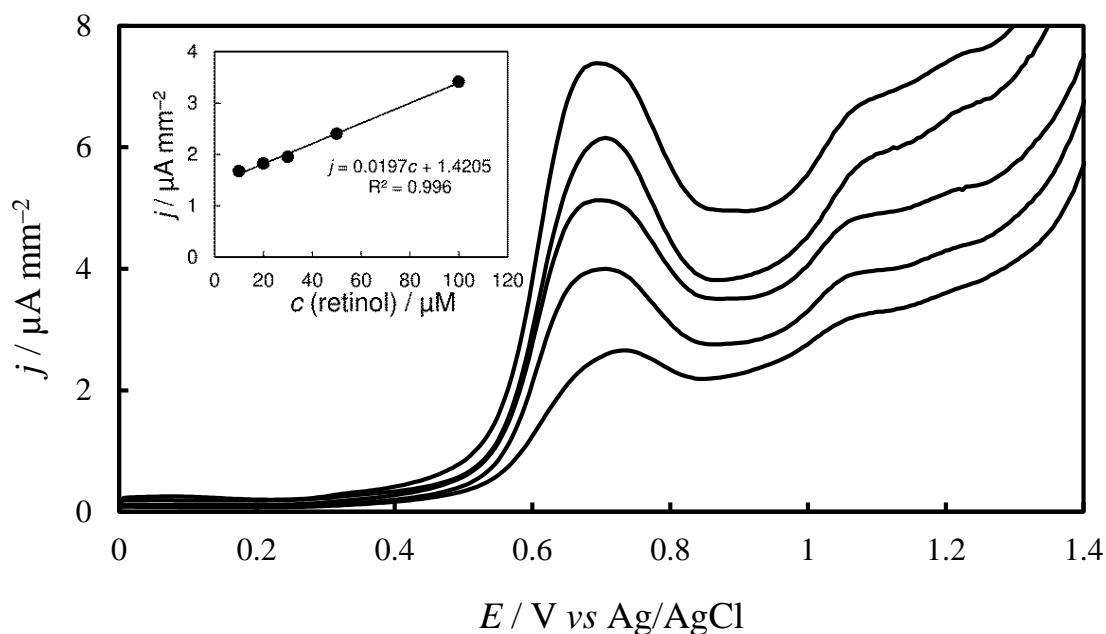

Figure 6 Voltammograms with corresponding calibration curve of retinol obtained at GCPE with 15% content of silicone oil.

Table 2 Reproducibility of accumulation steps for sensors applied in the AdSV and ExSV.

Sensor	E_p^a (V)	j (μA.mm ⁻²)	j_{RSD} (%)
solid GCE	0.680	0.379	7.5
GCPE	0.670	4.516	8.2
CPE/MWCNTs	0.750	3.085	6.3
CPE/Graphene	0.725	3.447	4.9

Note: E_p^a ; anodic peak potential, j ; current density and RSD; relative standard deviation.

Especially, retinyl palmitate, known as synthetic vitamin A, is usually added to fortified a low fat milk more nutritious than they would be without the addition of vitamins that were removed.

The seasonal variation of retinol in cow's farm milk can be also monitored by ExSV (LOD = 0.128 mg.L⁻¹) because retinol content is about 1.0 mg per 1 L milk (Hodulová et al., 2015). Moreover, it seems that retinoids such as retinyl acetate and already mentioned retinyl palmitate could be also determined in cosmetic products (Ziyatdinova et al., 2010).

Reproducibility of retinol accumulation

Reproducibility of retinol accumulation by adsorption on GCE, CPE/MWCNTs and CPE/Graphene surfaces or extraction into the SO of GCPE was calculated for 5 repetitions. These experiments were performed always using freshly polished GCE, newly prepared CPEs covered by thin layer of CNs, renewed GCPE, standard solution of retinol as well. At laboratory conditions, the accumulation was performed by immersing of selected working electrode (open circuit) into 10 mL of 100 µmol.L⁻¹ retinol solution containing 25% ACN stirred at 400 rpm for 10 min.

From values shown in Table 2, it is evident that satisfactory reproducibility (RSD ≤5%) was obtained only at the GCE/Graphene. This finding can be explained by a homogeneous structure of graphene layer. Fortunately, values of RSD for other electrodes were not calculated higher than 9%.

CONCLUSION

Nowadays, all lipophilic vitamins and their synthetic analogs are determined dominantly by HPLC in foodstuffs. The reason is a possibility of their separation in within one analysis. However, it is necessary to state that this kind of analysis includes a lot of time consuming steps such as hydrolysis of lipophilic sample matrix, extraction of vitamins into an organic solvent and own separation.

In comparison to HPLC, ExSV at GCPE represents a simple analytical tool applicable in determination of lipophilic vitamins because these analytes can be directly extracted from sample matrixes or simple sample preparation is assumed. This non-conventional stripping voltammetry usually is not able to detect each form of certain vitamins (individual retinoids, tocopherols, cholecalciferols and phylloquinones) due to their close peak potentials and significant width of peaks. Anyway, individual groups of these vitamins could be easily determined as weight equivalents of their most biologically active forms.

Despite high specific surface area of MWCNTs or single layer graphene, it should be concluded that any used variant of AdSV is not such sensitive as ExSV at GCPE. Additionally, restoration of electrode surfaces with the immobilized carbon nanomaterials is practically impossible after each accumulation step. An improvement in the sensitivity and reproducibility of ExSV could be found in using GCPE containing the optimal portion of graphene which has higher specific surface area than MWCNTs. It is necessary to state that from scientific point of view, this possibility has not been tested yet.

REFERENCES

- Abdel-Galeil, M. M., Ghoneim, M. M., El-Desoky, H. S., Hattori, T., Matsuda, A. 2014. Anodic stripping voltammetry determination of lead ions using highly sensitive modified electrodes based on multi-walled carbon nanotube. *Journal of Chemistry and Biochemistry*, vol. 2, no. 2, p. 25-43. <http://dx.doi.org/doi:10.15640/jcb.v2n2a2>
- Atuma, S. S., Lundström, K., Lindquist, J. 1975. The electrochemical determination of vitamin A. Part II. Further voltammetric determination of vitamin A and initial work on the determination of vitamin D in the presence of vitamin A. *Analyst*, vol. 100, no. 1196, p. 827-834. <http://dx.doi.org/doi:10.1039/AN9750000827>
- Budnikov, G. K., Ziyatdinova, G. K., Gil'metdinova, D. M. 2004. Determination of some liposoluble antioxidants by coulometry and voltammetry. *Journal of Analytical Chemistry*, vol. 59, no. 7, p. 654-658. <http://dx.doi.org/doi:10.1023/B:JANC.0000035278.20459.9e>
- Budnikov, G. K., Ziyatdinova, G. K., Gil'metdinova, D. M. 2005. Reactions of superoxide anion radical with antioxidants and their use in voltammetry. *Journal of Analytical Chemistry*, vol. 60, no. 1, p. 49-52. <http://dx.doi.org/doi:10.1007/s10809-005-0012-2>
- Cookeas, E. G., Efstathiou, C. E. 1992. Preconcentration of organic compounds at a diphenyl ether graphite paste electrode and determination of vanillin by adsorptive-extractive stripping voltammetry. *Analyst*, vol. 117, no. 8, p. 1329-1334. <http://dx.doi.org/doi:10.1039/AN9921701329>
- Filik, H., Avan, A. A., Aydar S. 2016. Simultaneous electrochemical determination of α-tocopherol and retinol in micellar media by a poly(2,2'-(1,4 phenylenedivinylene)-bis-8-hydroxyquinaldine)-multiwalled carbon nanotube modified electrode. *Analytical Letters*, vol. 49, no. 8, p. 1240-1257. <http://dx.doi.org/10.1080/00032719.2015.1094665>
- Dejmkova, H., Zima, J., Míka, J. 2012. Behavior of glassy carbon paste electrode in flowing methanolic solutions. *Electroanalysis*, vol. 24, no. 8, p. 1766-1770. <http://dx.doi.org/doi:10.1002/elan.201100598>
- Goodman, D. S. 1984. Vitamin A and retinoids in health and disease. *The New England Journal of Medicine*, vol. 310, no. 16, p. 1023-1031. <http://dx.doi.org/doi:10.1056/NEJM198404193101605>
- Hallett, L. T. Editorial. 1960. Sensitivity of analytical methods. *Analytical Chemistry*, vol. 32, no. 9, 1057-1057. <http://dx.doi.org/doi:10.1021/ac60165a605>
- Hernández Méndez, J., Sánchez Pérez, A., Delgado Zamarreño, M., Hernández García, M. L. 1988. Voltammetric determination of vitamin D₃ with a rotating glassy carbon electrode. *Journal of Pharmaceutical and Biomedical Analysis*, vol. 6, no. 6-8, p. 737-741. [http://dx.doi.org/doi:10.1016/0731-7085\(88\)80085-2](http://dx.doi.org/doi:10.1016/0731-7085(88)80085-2)
- Hite, D. A. 2003. Determination of retinyl palmitate (vitamin A) in fortified fluid milk by liquid chromatography: collaborative study. *Journal of AOAC International*, vol. 86, no. 2, p. 375-385. [PMid:12723921](https://pubmed.ncbi.nlm.nih.gov/12723921/)
- Hočevar, S. B., Švancara, I., Ogorevc, B., Vyřas, K. 2007. Antimony film electrode for electrochemical stripping analysis. *Analytical Chemistry*, vol. 79, no. 22, p. 8639-8643. <http://dx.doi.org/doi:10.1021/ac070478m>
- Hodulová, L., Vorlová, L., Kostrhounová, R., Klimešová-Vyleťelová, M., Kuchčík, J. 2015. Interspecies and seasonal differences of retinol in dairy ruminant's milk. *Potravinárstvo*, vol. 9, no. 1, p. 201-205. <http://dx.doi.org/doi:10.5219/436>

- Jaiswal, P. V., Ijeri, V. S., Srivastava, A. K. 2001. Voltammetric behavior of α -tocopherol and its determination using surfactant + ethanol + water and surfactant + acetonitrile + water mixed solvent systems. *Analytica Chimica Acta*, vol. 441, no. 2, p. 201-206. [http://dx.doi.org/doi:10.1016/S0003-2670\(01\)01119-9](http://dx.doi.org/doi:10.1016/S0003-2670(01)01119-9)
- Kalvoda, R., Kopanica, M. 1989. Adsorptive stripping voltammetry in trace analysis. *Pure and Applied Chemistry*, vol. 61, no. 1, p. 97-112. <http://dx.doi.org/doi:10.1351/pac198961010097>
- Komarov, F. F., Mironov, A. M. 2004. Carbon nanotubes: Present and future. *Physics and Chemistry of Solid State*, vol. 5, no. 3, p. 411-429.
- Kuzmany, H., Kukovec, A., Simon, F., Holzweber, M., Kramberger, Ch., Pichler, T. 2004. Functionalization of carbon nanotubes. *Synthetic Metals*, vol. 141, no. 1-2, p.113-122. <http://dx.doi.org/doi:10.1016/j.synthmet.2003.08.018>
- Lu, W., Soukiassian, P., Boeckl, J. 2012. Graphene: Fundamentals and functionalities. *MRS Bulletin*, vol. 37, no. 12, p. 1119-1124. <https://doi.org/10.1557/mrs.2012.279>
- Masek, A., Chrzescijanska, E., Zaborski, M. 2014. Voltammetric and FTIR spectroscopic studies of the oxidation of retinyl propionate at Pt electrode in non-aqueous media. *International Journal of Electrochemical Science*, vol. 9, no. 12, p. 6809-6820.
- MacDougall, D., Crummett, W. B. 1980. Guidelines for data acquisition and data quality evaluation in environmental chemistry. *Analytical Chemistry*, vol. 52, no. 14, p. 2242-2249. <http://dx.doi.org/doi:10.1021/ac50064a004>
- McAllister, M. J., Li, J. L., Adamson, D. H., Schniepp, H. C., Abdala, A. A., Liu, J., Herrera-Alonso, M., Milius, D. L., Car, R., Prud'homme, R. K., Aksay, I. A. 2007. Single sheet functionalized graphene by oxidation and thermal expansion of graphite. *Chemistry of Materials*, vol. 19, no. 18, p. 4396-4404. <http://dx.doi.org/doi:10.1021/cm0630800>
- Mikysek, T., Švancara, I., Kalcher, K., Bartoš, M., Vytřas, K., Ludvík, J. 2009. New approaches to the characterization of carbon paste electrodes using the ohmic resistance effect and qualitative carbon paste indexes. *Analytical Chemistry*, vol. 81, no. 15, p. 6327-6333. <http://dx.doi.org/doi:10.1021/ac9004937>
- Murray, R. W., Ewing, A. G., Durst, R. A. 1987. Chemically modified electrodes. Molecular design for electroanalysis. *Analytical Chemistry*, vol. 59, no. 5, p. 379A-390A. <http://dx.doi.org/doi:10.1021/ac00132a001>
- Samec, Z. 2004. Electrochemistry at the interface between two immiscible electrolyte solutions. *Pure and Applied Chemistry*, vol. 76, no. 12, p. 2147-2180. <http://dx.doi.org/doi:10.1351/pac200476122147>
- Sun, Y. P., Fu, K., Lin, Y., Huang, W. 2002. Functionalized carbon nanotubes: Properties and applications. *Accounts of Chemical Research*, vol. 35, no. 12, p. 1096-1104. <http://dx.doi.org/doi:10.1021/ar010160v>
- Sýs, M., Metelka, R., Mikysek, T., Vytřas, K. 2015. Improvement of enzyme carbon paste-based biosensor using carbon nanotubes for determination of water-soluble analogue of vitamin E. *Chemical Papers*, vol. 69, no. 1, p. 150-157. <http://dx.doi.org/doi:10.2478/s11696-014-0608-9>
- Sýs, M., Stočes, M., Metelka, R., Vytřas, K. 2016. Electrochemical properties of α -tocopherol in aqueous electrolytes after its previous extraction into the glassy carbon paste from aqueous-acetonic mixture. *Monatshefte für Chemie*, vol. 147, p. 31-38. <http://dx.doi.org/doi:10.1007/s00706-015-1620-7>
- Sýs, M., Vytřas, K. 2016. Characterization of α -tocopherol extraction into a selected carbon paste binder. *Scientific Paper of the University of Pardubice Series A*, vol. 22, p. 35-44.
- Sýs, M., Žabčiková, S., Červenka, L., Vytřas, K. 2016. Adsorptive stripping voltammetry in lipophilic vitamins determination. *Potravinárstvo*, vol. 10, no. 1, p. 260-264. <http://dx.doi.org/doi:10.5219/587>
- Švancara, I., Hvízdalová, M., Vytřas, K., Kalcher, K., Novotný, R. 1996. A microscopic study of carbon paste electrodes. *Electroanalysis*, vol. 8, no. 1, p. 61-65. <http://dx.doi.org/doi:10.1002/elan.1140080113>
- Švancara, I., Konvalina, J., Schachl, K., Kalcher, K., Vytřas, K. 1988. Stripping voltammetric determination of iodide with synergistic accumulation at a carbon paste electrode. *Electroanalysis*, vol. 10, no. 6, p. 435-441.
- Švancara, I., Prior, Ch., Hočevar, S. B., Wang, J. 2010. A decade with bismuth-based electrodes in electroanalysis. *Electroanalysis*, vol. 22, no. 13, p. 1405-1420. <http://dx.doi.org/doi:10.1002/elan.200970017>
- Švancara, I., Schachl, K. 1999. The testing of unmodified carbon paste electrodes. *Chemické Listy*, vol. 93, p. 490-499.
- Tan, Y. D., Urbančok, D., Webster, R. D. 2014. Contrasting voltammetric behavior of different forms of vitamin A in aprotic organic solvents. *The Journal of Physical Chemistry B*, vol. 118, no. 29, p. 8591-600. <http://dx.doi.org/10.1021/jp505456q>
- Tuzhi, P., Zhongping, Y., Rongshan, L. 1990. Adsorptive/extractive voltammetry for determining clozapine at carbon paste electrodes. *Chemical Journal of Chinese Universities*, vol. 11, no. 10, p. 1067-1071.
- Wang, J., Freiha, B. A. 1984. Extractive preconcentration of organic compounds at carbon paste electrodes. *Analytical Chemistry*, vol. 56, no. 4, p. 849-852. <http://dx.doi.org/doi:10.1021/ac00268a069>
- Wang, J., Freiha, B. A., Deshmukh, B. K. 1985. Adsorptive/extractive stripping voltammetry of phenothiazine compounds at carbon paste electrodes. *Bioelectrochemistry and Bioenergetics*, vol. 14, no. 4-6, p. 457-467. [http://dx.doi.org/doi:10.1016/0302-4598\(85\)80018-0](http://dx.doi.org/doi:10.1016/0302-4598(85)80018-0)
- Wang, L. H. 2000. Simultaneous determination of retinal, retinol and retinoic acid (all-trans and 13-cis) in cosmetics and pharmaceuticals at electrodeposited metal electrodes. *Analytica Chimica Acta*, vol. 415, no 1-2, p. 193-200. [http://dx.doi.org/10.1016/S0003-2670\(00\)00870-9](http://dx.doi.org/10.1016/S0003-2670(00)00870-9)
- Webster, R. D. 2012. Voltammetry of the liposoluble vitamins (A, D, E and K) in organic solvents. *The Chemical Record*, vol. 12, no. 1, p. 188-200. <http://dx.doi.org/doi:10.1002/ocr.201100005>
- Wring, S. A., Hart, J. P., Knight, D. W. 1988. Voltammetric behaviour of all-trans-retinol (vitamin A1) at a glassy carbon electrode and its determination in human serum using high-performance liquid chromatography with electrochemical detection. *Analyst*, vol. 113, no. 12, p. 1785-1789. <http://dx.doi.org/doi:10.1039/AN9881301785>
- Zhu, Y., Murali, S., Cai, W., Li, X., Suk, J. W., Potts, J. R., Ruoff, R. S. 2010. Graphene and graphene oxide: Synthesis, properties, and applications. *Advanced Materials*, vol. 22, no. 35, p. 3906-3924. <http://dx.doi.org/doi:10.1002/adma.201001068>
- Ziyatdinova, G., Giniyatova, E., Budnikov, H. 2010. Cyclic voltammetry of retinol in surfactant media and its application for the analysis of real samples. *Electroanalysis*, vol. 22, no. 22, p. 2708-2713. <http://dx.doi.org/doi:10.1002/elan.201000358>
- Ziyatdinova, G., Morozov, M., Budnikov, H. 2012. MWNT-modified electrodes for voltammetric determination

of lipophilic vitamins. *Journal of Solid State Electrochemistry*, vol. 16, no. 7, p. 2441-2447. <http://dx.doi.org/doi:10.1007/s10008-011-1581-7>

Acknowledgments:

Financial support from Faculty of Chemical Technology, University of Pardubice (project No. SGS-2016-001) is gratefully acknowledged.

Contact address:

Milan Sýs, University of Pardubice, Faculty of Chemical Technology, Department of Analytical Chemistry, Studentská 573, 532 10 Pardubice, Czech Republic, E-mail: milan.sys@upce.cz

Simona Žabčíková, University of Pardubice, Faculty of Chemical Technology, Department of Analytical Chemistry, Studentská 573, 532 10 Pardubice, Czech Republic, E-mail: simona.zabcikova@student.upce.cz

Libor Červenka, University of Pardubice, Faculty of Chemical Technology, Department of Analytical Chemistry, Studentská 573, 532 10 Pardubice, Czech Republic, E-mail: libor.cervenka@upce.cz

Karel Vytřas, University of Pardubice, Faculty of Chemical Technology, Department of Analytical Chemistry, Studentská 573, 532 10 Pardubice, Czech Republic, E-mail: karel.vytras@upce.cz

THE INFLUENCE OF VARIETY ON THE CONTENT OF BIOACTIVE COMPOUNDS IN BEETROOT (*BETA VULGARIS* L.)

Ján Kovarovič, Judita Bystrická, Ján Tomáš, Marianna Lenková

ABSTRACT

Vegetable are widespread throughout the world and is a major part of the human diet. From the perspective of agricultural crops that belong to the group of *Beta vulgaris* (beetroot, mangold, sugar beets, fodder beet) are first-rate vegetables. Especially popular is used in the food industry for the production of sugar, various vegetable juices, coloring agents, and many other products. Beetroot (*Beta vulgaris* L.) is considered one of the ten most important vegetable in the world, thanks to the content of rare natural pigments (betalains), polyphenols, flavonoids, antioxidants, vitamins, minerals and fiber. In this work we evaluated content of bioactive substances, especially the content of total polyphenols, anthocyanins and antioxidant activity in several varieties (*Cylindra*, *Kahira*, *Chioggia*, *Crosby Egyptian*) of beetroot (*Beta vulgaris* L.). Samples of plant material were collected at full maturity stages from areas of Zeleneč (Czech Republic). Zeleneč is area without negative influences and emission sources. Samples of fresh beetroot (*Beta vulgaris* L.) were homogenized and were prepared as an extract: 50 g cut beetroot (*Beta vulgaris* L.) extracted by 100 mL 80% ethanol for sixteen hours. These extracts were used for analyses. The content of the total polyphenols was determined by using the Folin-Ciocalteu reagent (FCR). The absorbance was measured at 765 nm of wavelength against blank. The content of total anthocyanins was measured at 520 nm wavelength of the blank. Antioxidant activity was measured using a compound DPPH[•] (2,2-diphenyl-1-picrylhydrazyl) at 515.6 nm in the spectrophotometer. In the present experiment it was detected, that total polyphenols content in samples ranges from 218.00 mg.kg⁻¹ to 887.75 mg.kg⁻¹, total anthocyanins content in samples ranges from 14.48 ±0.40 mg.kg⁻¹ to 84.50 ±4.71 mg.kg⁻¹ and values of antioxidant activity were in interval from 8.37 ±0.29% to 21.83 ±0.35%.

Keywords: beetroot; polyphenols; anthocyanins; antioxidant activity; variety

INTRODUCTION

Plant foods are endowed with micronutrients such as vitamin C, B vitamins, folate, provitamin A and D and E vitamins, antioxidants, phytochemicals, fiber, bioavailable minerals, iron, zinc and calcium (Nair and Augustíne, 2016). Fruits and vegetables are an important part of the human diet over the world (Cherfi et al., 2015). Optimal fruit and vegetable consumption has been recognized as one of the cornerstones of a healthy diet for decades. Fruit and vegetable provide key nutrients essential to promoting and maintaining health. An abundance of evidence shows that diets rich in fruit and vegetable reduce chronic disease risk, including coronary heart disease, stroke, and asthma (Hromi-Fiedler et al., 2016).

Beetroot (*Beta vulgaris* L.) is a commonly consumed vegetable for cooking in daily life and also fresh as well as cooked, pickled, or canned (Tran et al., 2016). Beetroot (*Beta vulgaris* L.) is a member of the *Chenopodiaceae* family, cultivated for its large roots, although leaves are also utilizable. Seeds, roots and leaves of the plant are rich

of polyphenols and a water soluble nitrogen pigments group named betalains (Paciulli et al., 2016).

Betalains are water-soluble nitrogen-containing pigments, which comprise the red-violet betacyanins and the yellow betaxanthins. The basic structure of betalains is betalamic acid linked to the molecule of *cyclo*-3,4-dihydroxyphenylalanine (*cyclo*-DOPA) for betacyanins, and to the molecule of amino acid or amine for betaxanthins (Sawicki et al., 2016). Betalaine color from beetroot (*Beta vulgaris* L.) are used in the food industry and are well known under the name of E162 in Europe and the USA (Nestora et al., 2016).

Beetroot (*Beta vulgaris* L.) is a rich source of polyphenols and antioxidants. It contains also other valuable bioactive compounds, making its consumption highly beneficial to a human body (Sawicki et al., 2016). Beetroot (*Beta vulgaris* L.) juice contains a high level of biologically accessible antioxidants as well as many other health promoting compounds such as potassium, magnesium, folic acid, iron, zinc, calcium, phosphorus,

sodium, niacin, biotin, B₆ and soluble fibre (Wootton-Beard and Ryan, 2011).

The roots of beetroot (*Beta vulgaris* L.) has a positive effect in the treatment of intestinal and genital tumors, while the juice from fresh leaves and roots were considered effective in the treatment of tumors of the digestive tract and the lung, liver, breast, prostate, and uterus (Ninfali and Angelino, 2013).

Polyphenols are secondary metabolites produced by plants in response to environmental stress or injury, and are important constituents of human diet, since they are present in many plant-derived foods and beverages including fruits, vegetables, cereals, olive, legumes, chocolate, tea, coffee, and wine (Vacca et al., 2016).

By Georgiev et al. (2010) in beetroot (*Beta vulgaris* L.) contains polyphenols such as 4-hydroxybenzoic acid, caffeic acid and chlorogenic acid.

In terms of human nutrition is important to find a variety of beetroot (*Beta vulgaris* L.), which are rich in bioactive substances (polyphenols, antioxidants). The aim of our study was to evaluate total content polyphenols, anthocyanins and antioxidant activity in beetroot.

MATERIAL AND METHODOLOGY

Samples of plant material were collected at full maturity stages from area of Zeleneč (Czech Republic). The sample of soil (Table 1) and plant material were analyzed individually by selected methods, and were used in fresh material on analysis. The analysed varieties (*Cylindra*, *Kahira*, *Chioggia*, *Crosby Egyptian*) of beetroot are shown in Figure 4, Figure 5, Figure 6 and Figure 7.

Zeleneč is located northwest of Prague (Czech Republic). Village Zeleneč is located in a slightly hilly terrain. The altitude of the village is 255 m.n.m. Average an annual air temperature 8 °C to 9 °C, annual rainfall is 550 mm to 650 mm.

We determined the soil sample from Zeleneč as sandy-loam, loam. The soil sample had a value of active soil reaction pH (H₂O) = 7.80. The soil was alkaline. Cox-oxidizable carbon content was determined 2.00 and the humus content was 3.45%. The total content of heavy metals (aqua regia) in soil sample was determined according to the current legislation of the Law. 220/2004.

lead exceeded the limit value of 1.1 times and Cadmium exceeded the limit value of 4.6 times.

From beetroot samples 50 g were homogenised and extracted by 100 mL 80% ethanol (Sigma – Aldrich Co, USA) during twelve hours. In obtained extracts of beetroot (*Beta vulgaris* L.) total polyphenols and anthocyanins contents and antioxidant capacity were spectrophotometrically determined (Spektrofotometer Shimadzu UV-1800; Shimadzu, Japan).

Spectrophotometric determination of total polyphenols

Total polyphenols were determined by the method of Lachman et al. (2003) and expressed as mg of gallic acid equivalent per kg fresh mater. Gallic acid is usually used as a standard unit for phenolics content determination because a wide spectrum of phenolic compounds. The total polyphenol content was estimated using Folin-Ciocalteau assay. The Folin-Ciocalteau (Merck group, Germany) phenol reagent was added to a volumetric flask containing 100 mL of extract of beetroot.

The content was mixed and 5 mL of a sodium carbonate solution by Merck group, Germany (20%) was added after 3 min. The volume was adjusted to 50 mL by adding of distilled water. After two hours, the samples were centrifuged for 10 min. and the absorbance was measured at 765 nm (Spektrofotometer Shimadzu UV-1800; Shimadzu, Japan) of wavelength against blank. The concentration of polyphenols was calculated from a standard curve plotted with known concentration of gallic acid.

Spectrophotometric determination of total anthocyanins

Total anthocyanins content was determined by modified method Lapornik et al. (2005). Extract of beetroot 1 cm³ was pipetted and 1 cm³ HCl by Merck group, Germany (0.01%) in 80% ethanol (Sigma – Aldrich Co, USA) was added. Then 10 cm³ 14 % HCl into the first tube and 10 cm³ McIlvain agents (pH 3.5) into another tube were added. Absorbance was measured at 520 nm against blank sample.

Table 1 Agrochemical characteristic of soil substrate in mg.kg⁻¹ (Zeleneč).

Agrochemical characteristic	pH	pH	Cox	Humus (%)				
	7.8	7.25	2	3.45				
Nutrients	K	Ca	Mg	P				
	284	4329.6	75.4	208.5				
Heavy metals	Fe	Mn	Zn	Cu	Co	Cr	Pb	Cd
Content in aqua regia (mg.kg ⁻¹)	13760.6	356.6	39.4	16.9	9.1	20.1	26.8	1.82
Limit value (mg.kg ⁻¹)	-	-	100	30	15	50	25	0.4

Spectrophotometric determination of antioxidant activity

Antioxidant activity was measured by the (Brand-Williams et al., 1995) method-using a compound DPPH[·] (2,2-diphenyl-1-picrylhydrazyl). 2,2-diphenyl-1-picrylhydrazyl (DPPH[·]) by Sigma – Aldrich Co, USA was pipetted to cuvette (3.9 cm³) then the value of absorbance, which corresponded to the initial concentration of DPPH[·] solution in time A₀ was written. Then 0.1 cm³ of the followed solution was added and then the dependence A = f (t) was immediately started to measure. The absorbance of 1, 5 and 10 minutes at 515.6 nm in the spectrophotometer (Shimadzu UV – 1800; Shimadzu, Japan) was mixed and measured. The percentage of inhibition reflects how antioxidant compound are able to remove DPPH[·] radical at the given time.

$$\% \text{ inhibition DPPH}^{\cdot} = \frac{A_0 - A_t}{A_0} \times 100 (\%)$$

Statistical analysis

The results were statistically evaluated by analysis of Variance (ANOVA - multiple range test method: 95.0 percent LSD) using statistical software Statgraphics (Centurion XVI.I, USA).

RESULTS AND DISCUSSION

Beetroots contain 65.7% of water, 1.4% protein, 4 – 8% sugar (the main sugar in beetroot is sucrose with only small amounts of glucose and fructose), 0.3% fat, 1% fibre and mineral salts of calcium, phosphorus, magnesium and iron (Janiszewska and Włodarczyk, 2013).

In this work the content of polyphenols in red beetroot was tested and evaluated. In the present experiment it was detected, that total polyphenols content in samples ranges from 368.75 ±5.14 mg.kg⁻¹ (Chioggia) to 887.75 ±7.73 mg.kg⁻¹ (Cylindra) in variety of beetroot (Table 2). Kavalcová et al. (2015) published that the content of total polyphenols was recorded in beetroot in

Table 2 The average content of total polyphenols (mg.kg⁻¹) in beetroot (*Beta vulgaris* L.).

Locality	Variety	TPC (mg.kg ⁻¹)
Zeleneč	<i>Cylindra</i>	887.75 ±7.73 b
	<i>Kahira</i>	373.8 ±11.38 a
	<i>Chioggia</i>	368.75 ±5.14 a
	<i>Crosby Egyptian</i>	882.4 ±11.90 b
HD 95 %		14.5589
HD 99 %		20.4105

Note: LSD Test on the significance: α: <0.05.

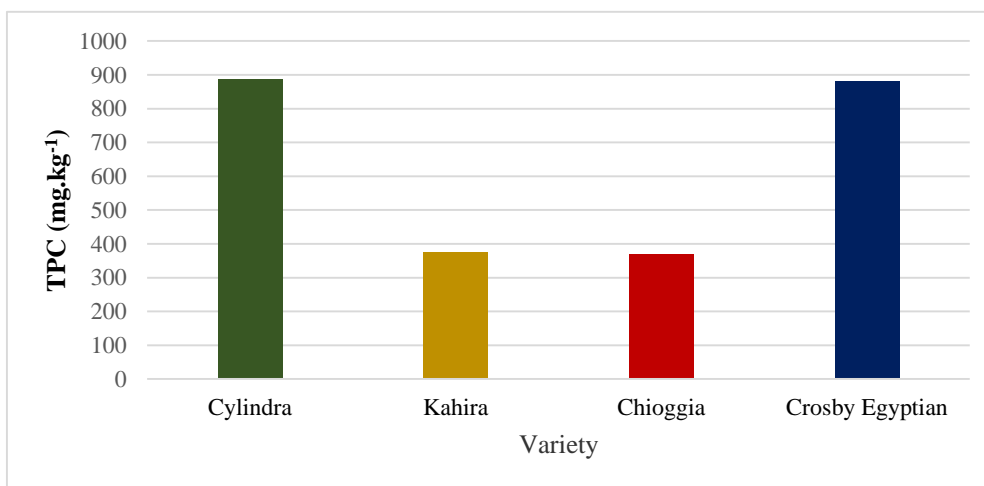

Figure 1 The content of total polyphenols (mg.kg⁻¹) in beetroot (*Beta vulgaris* L.).

Table 3 The average content of total anthocyanins (mg.kg⁻¹) in beetroot (*Beta vulgaris* L.).

Locality	Variety	TA (mg.kg ⁻¹)
Zeleneč	<i>Cylindra</i>	84.50 ±4.71 d
	<i>Kahira</i>	50.36 ±4.02 b
	<i>Chioggia</i>	14.48 ±0.40 a
	<i>Crosby Egyptian</i>	73.50 ±5.19 c
HD 95%		6.22734
HD 99%		8.73028

Note: LSD Test on the significance: α: <0.05.

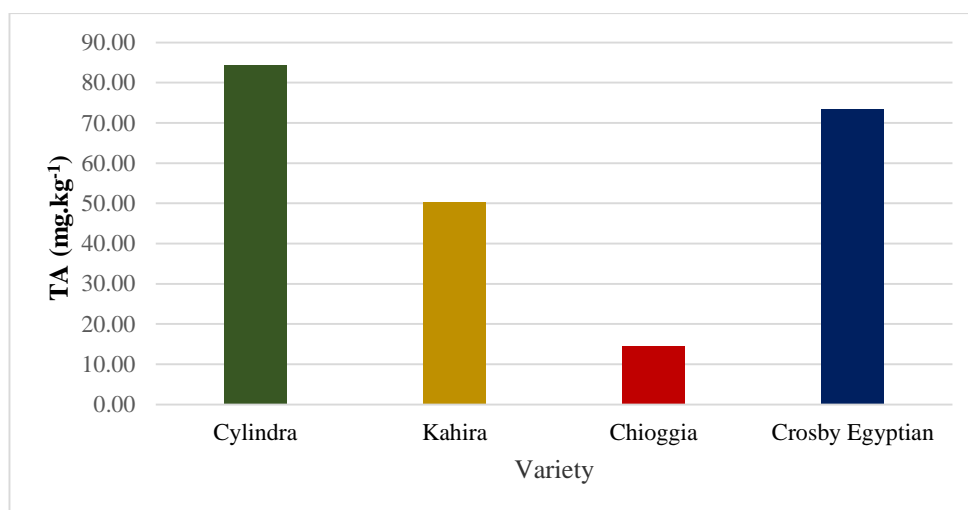

Figure 2 The content of total anthocyanins (mg.kg⁻¹) in beetroot (*Beta vulgaris* L.).

Table 4 The average values of antioxidant activity (% inhibition) in beetroot (*Beta vulgaris* L.).

Locality	Variety	AOA (% inhibition)
Zeleneč	<i>Cylindra</i>	21.83 ± 0.35 c
	<i>Kahira</i>	20.70 ± 0.18 b
	<i>Chioggia</i>	8.37 ± 0.29 a
	<i>Crosby Egyptian</i>	21.52 ± 0.42 c
HD 95%		0.494582
HD 99%		0.693369

Note: LSD Test on the significance: α : <0.05.

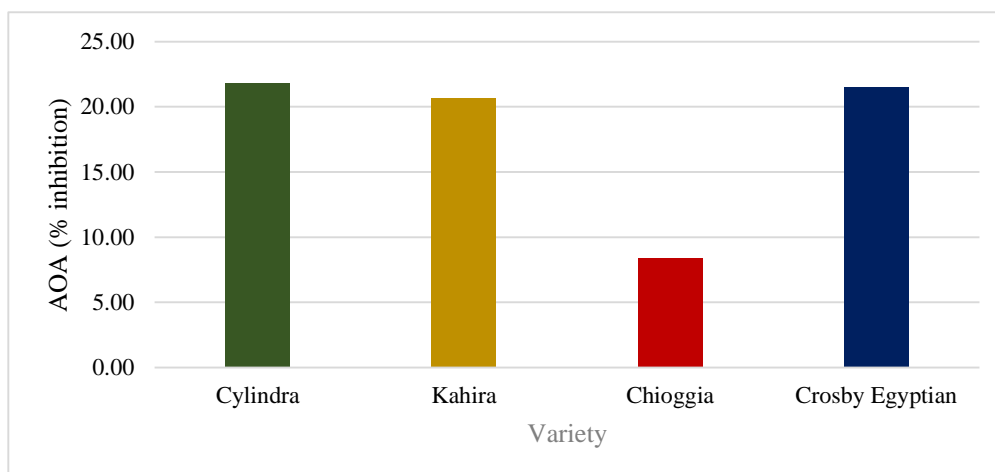

Figure 3 Values of antioxidant activity AOA (% inhibition) in beetroot (*Beta vulgaris* L.).

the interval from 820.10 mg.kg⁻¹ to 1280.56 mg.kg⁻¹. In comparison to our determined values of polyphenols their results were in similar interval. By **Ninfali and Angelino (2013)**, the total polyphenol content ranging from 720 mg.kg⁻¹ to 1276 mg.kg⁻¹. Our results are in a similar range. **Wootton-Beard et al. (2011)** reported that the polyphenols in red beetroot was in amounts from 617.8 mg.kg⁻¹ to 1450.3 mg.kg⁻¹. Our results are in a similar range. Our results are significantly lower compared to **Čanadanovič-Brunet et al. (2011)**, who has published

the content of total polyphenols in beetroot is 3764 mg.kg⁻¹. Statistically significant highest value of total polyphenols ($p < 0.05$) was recorded in beetroot in variety of *Cylindra* (887.75 ± 7.73 mg.kg⁻¹). Statistically significant the lowest content of total polyphenols ($p < 0.05$) was recorded in beetroot in variety of *Chioggia* (368.75 ± 5.14 mg.kg⁻¹). The total content of polyphenolic compounds of beetroot is quite variable, may be affected by postharvest climatic conditions and varieties.

Another indicator that has been evaluated and compared was the content of total anthocyanins of beetroot. Anthocyanins are found in various fruit and vegetables with a broad color scheme from bright red to purple and dark blue, and present in the glycoside forms of anthocyanidin (aglycone) with high antioxidant capacity (Wang et al., 2016).

In this work the content of anthocyanins in beetroot was tested and evaluated. In the present work it was detected, that total anthocyanins in samples of beetroot ranges from $84.50 \pm 4.71 \text{ mg.kg}^{-1}$ to $14.48 \pm 0.40 \text{ mg.kg}^{-1}$ (Table 3). The content of anthocyanins in beetroot is very low compared with betalaines.

Statistically significant highest value of total anthocyanins ($p < 0.05$) was recorded in beetroot in variety of *Cylindra* ($84.50 \pm 4.71 \text{ mg.kg}^{-1}$). Statistically significant the lowest content of total anthocyanins ($p < 0.05$) was recorded in beetroot in variety of *Chioggia* ($14.48 \pm 0.40 \text{ mg.kg}^{-1}$).

The last indicator that has been evaluated and compared was the antioxidant activity of beetroot. The antioxidant is any substance that when present at low concentrations compared to that of an oxidizable substrate significantly delays or inhibits oxidation of that substrate. The antioxidants reduce the risk of various degenerative diseases (cancer, inflammatory diseases, cardiovascular diseases, diseases of the liver) (Oldham and Bowen, 1998).

Among the major antioxidants in beetroot belong mainly betalains (betanin). In the present work it was detected, that antioxidant activity in samples of beetroot ranges from $8.37 \pm 0.29\%$ to $21.83 \pm 0.35\%$ (Table 4). Kavalcová et al. (2015) reported that the value of antioxidant activity was recorded in beetroot (*Beta vulgaris* L.) in the interval from $19.63 \pm 0.90\%$ to $29.82 \pm 0.55\%$. In comparison to our determined values of antioxidant activity their results were in similar interval. Our results are significantly lower compared to Holásová et al. (2011), who reported that the value of the antioxidant activity of red beet is 36%. Statistically significant highest value of antioxidant activity ($p < 0.05$) was recorded in beetroot in variety of *Cylindra* ($21.83 \pm 0.35\%$). Statistically significant the lowest content of antioxidant activity ($p < 0.05$) was recorded in beetroot in variety of *Chioggia* ($8.37 \pm 0.29\%$). The highest content of total polyphenols ($887.75 \pm 7.73 \text{ mg.kg}^{-1}$), content of total anthocyanins ($84.50 \pm 4.71 \text{ mg.kg}^{-1}$) as well as the value of antioxidant activity ($21.83 \pm 0.35\%$) was found in the variety *Cylindra*. Whereas the lowest content of total polyphenols ($368.75 \pm 5.14 \text{ mg.kg}^{-1}$), total anthocyanins ($14.48 \pm 0.40 \text{ mg.kg}^{-1}$) as well as the value of antioxidant activity ($8.37 \pm 0.29\%$) was found in the variety *Chioggia*. Our results show that the variety beetroot affecting the content of bioactive substances. We assume that the intensity of the color eyeballs affects the content of bioactive substances. Presumably, that *Chioggia* less bioactive substances contained in pink stripes as dark red varieties, resulting in a smaller value of antioxidant capacity. Natural determinants such as soil composition, total annual precipitation, local climate, and hours of sunshine affect the accumulation of nutrients and phytochemicals in plant parts (Wruss et al., 2015).



Figure 4 The variety of beetroot – *Cylindra* (URL 1)



Figure 5 The variety of beetroot – *Kahira* (URL 2)



Figure 6 The variety of beetroot – *Chioggia* (URL 3)



Figure 7 The variety of beetroot – *Chioggia* (URL 4)

CONCLUSION

The present paper was focused on the content of total polyphenols, anthocyanins and antioxidant activity in beetroot (*Beta vulgaris* L.). The results suggest that beetroot contains higher amount of polyphenolic substances. The four beetroot varieties cultivated for this study represent the majority of the varieties currently grown in Slovakia. Beetroot is among the ten major vegetables in the world. Beetroot contains betalains, anthocyanins, polyphenols, vitamins, organic acids and minerals. All these substances we can include the bioactive components beetroot. Values of polyphenolic compounds contained in beetroot are quite variable. The content of total polyphenols, anthocyanins and antioxidant activity in beetroot may be influenced by variety, growing and postharvest conditions. The content of chemoprotective compounds may be affected also by agrochemical composition of the soil for example content of humus, climatic condition and nutrients. The results obtained in this work provide further information about of the content of total polyphenols, anthocyanins and antioxidant activity in beetroot

REFERENCES

Act No. 220/2004 Coll. Of Laws of Slovak Republic. On the conservation and use of agricultural land, amending the Act No. 245/2003 Coll. on integrated pollution prevention and control, amending and supplementing of certain acts, as amended.

Brand-Williams, W., Cuvelier, M. E., Berset, C. 1995. Use of a free radical method to evaluate antioxidant activity. *Lebensmittel-Wissenschaft und Technologie*, vol. 28, no. 1, p. 25-30. [http://dx.doi.org/10.1016/S0023-6438\(95\)80008-5](http://dx.doi.org/10.1016/S0023-6438(95)80008-5)

Čanadanović-Brunet, J. M., Savatović, S., Četković, G., Vulić, J. J., Markov, M., Cvetković, D. 2011. Antioxidant and Antimicrobial Activities of Beet Root Pomace Extracts. *Journal of Food Science*, vol. 29, no. 6, p. 575-585.

Cherfi, A., Achour, M., Cherfi, M., Otmani, S., Morsli, A. 2015. Health risk assessment of heavy metals through consumption of vegetables irrigated with reclaimed urban wastewater in Algeria. *Process Safety and Environmental Protection*, vol. 98, p. 245-252. <http://dx.doi.org/10.1016/j.psep.2015.08.004>

Georgiev, V., Weber, J., Kneschke, E., Denev, P., Bley, T., Pavlov, A. 2010. Antioxidant Activity and Phenolic Content of Betalain Extracts from Intact Plants and Hairy Root Cultures of the Red Beetroot *Beta vulgaris* cv. Detroit Dark Red. *Plant Foods Human Nutrition*, vol. 65, no. 2, p. 105-111. <http://dx.doi.org/10.1007/s11130-010-0156-6>

Holasová, M., Fiedlerová, V. 2011. Comparison of methods antioxidant activity determination in the fruit and vegetable juice (In Czech: Porovnání metod stanovení antioxidační aktivity v ovocných a zeleninových šťavách). *Chemické listy*, vol. 105, p. 766-772.

Hromi-Fiedler, A., Chapman, D., Segura-Pérez, S., Damio, G., Clark, P., Martinez, J., Pérez-Escamilla, R. 2016. Barriers and Facilitators to Improve Fruit and Vegetable Intake Among WIC-Eligible Pregnant Latinas: An Application of the Health Action Process Approach Framework. *Journal of Nutrition Education and Behavior*, vol. 48, no. 7, p. 468-477. <http://dx.doi.org/10.1016/j.jneb.2016.04.398>

Janiszewska, E., Włodarczyk, J. 2013. Influence of spray drying conditions on beetroot pigments retention after microencapsulation process. *Acta Agrophysica*, vol. 20, no. 2, p. 343-356.

Kavalcová, P., Bystrická, J., Tomáš, J., Karovičová, J., Kovarovič, J., Lenková, M. 2015. The content of total polyphenols and antioxidant activity in red beetroot. *Potravinárstvo*, vol. 9, no. 1, p. 77-83. <https://doi.org/10.5219/441>

Lachman, J., Proněk, D., Hejtmánková, A., Pivec, V., Faitová, K. 2003. Total polyphenol and main flavonoid antioxidants in different onion (*Allium cepa* L.) varieties. *Scientia Horticulturae*, vol. 30, no. 4, p. 142-147.

Lapornik, B., Prošek, M., Wondra, A. G. 2005. Comparison of extracts prepared from plant by-products using different solvents and extraction time. *Journal of Food Engineering*, vol. 71, no 2, p. 214-222.

Nair, K. M., Augustíne, L. F. 2016. Food synergies for improving bioavailability of micronutrients from plant foods. *Food Chemistry*, in press, p. 1-6. <http://dx.doi.org/10.1016/j.foodchem.2016.09.115>

Nestora, S., Merlier, F., Prost, E., Haupt, K., Rossi, C., Bui, B. T. S. 2016. Solid-phase extraction of betanin and isobetanin from beetroot extracts using a dipicolinic acid molecularly imprinted polymer. *Journal of Chromatography A*, vol. 1465, p. 47-54. <http://dx.doi.org/10.1016/j.chroma.2016.08.069>

Ninfali, P., Angelino, D. 2013. Nutritional and functional potential of *Beta vulgaris* cicla and rubra. *Fitoterapia*, vol. 89, p. 188-199. <http://dx.doi.org/10.1016/j.fitote.2013.06.004>

Oldham, K. M., Bowen, P. E. 1998. Oxidative Stress in Critical Care: Is Antioxidant Supplementation Beneficial? *Journal of the American Dietetic Association*, vol. 98, no. 9, p. 1001-1008. [http://dx.doi.org/10.1016/S0002-8223\(98\)00230-2](http://dx.doi.org/10.1016/S0002-8223(98)00230-2)

Paciulli, M., Medina-Meza, I. G., Chiavaro, E., Barbosa-Cánovas, G. V. 2016. Impact of thermal and high pressure processing on quality parameters of beetroot (*Beta vulgaris* L.). *LWT - Food Science and Technology*, vol. 68, p. 98-104. <http://dx.doi.org/10.1016/j.lwt.2015.12.029>

Sawicki, T., Baczek, N., Wiczowski, W. 2016. Betalain profile, content and antioxidant capacity of red beetroot dependent on the genotype and root part. *Journal of Functional Foods*, vol. 27, p. 249-261. <http://dx.doi.org/10.1016/j.jff.2016.09.004>

Tran, T. N., Athanassiou, A., Basit, A., Bayer, I. S. 2016. Starch-based bio-elastomers functionalized with red beetroot natural antioxidant. *Food Chemistry*, vol. 216, p. 324-333. <http://dx.doi.org/10.1016/j.foodchem.2016.08.055>

URL 1 Available at: <http://www.rareseeds.com/cylindra-or-formanova-beet/>

URL 2 Available at: <https://sk.pinterest.com/pin/564427765769556330/>

URL 3 Available at: <https://parade.com/232768/linzlowe/what-the-heck-is-a-chioggia-beet/>

URL 4 Available at: <https://www.planetnatural.com/product/beet-crosby-egyptian/>

Vacca, R. A., Valenti, D., Caccamese, S., Daglia, M., Braidy, N., Nabavi, S. M. 2016. Plant polyphenols as natural drugs for the management of Down syndrome and related disorders. *Neuroscience & Biobehavioral Reviews*, vol. 71, p. 865-877. <http://dx.doi.org/10.1016/j.neubiorev.2016.10.023>

Wang, W., Jung, J., Zhao, Y. 2016. Chitosan-cellulose nanocrystal microencapsulation to improve encapsulation efficiency and stability of entrapped fruit anthocyanins. *Carbohydrate Polymers*, vol. 157, p. 1246-1253. <http://dx.doi.org/10.1016/j.carbpol.2016.11.005>

Wootton-Beard, P. C., Ryan, L. 2011. A beetroot juice shot is a significant and convenient source of bioaccessible antioxidants. *Journal of Functional Foods*, vol. 3, no. 4, p. 329-334. <http://dx.doi.org/10.1016/j.jff.2011.05.007>

Wruss, J., Waldenberger, G., Huemer, S., Uygun, P., Lanzerstorfer, P., Müller, U., Höglinger, O., Weghuber, J. 2015. Compositional characteristics of commercial beetroot products and beetroot juice prepared from seven beetroot varieties grown in Upper Austria. *Journal of Food Composition and Analysis*, vol. 42, p. 46-55. <http://dx.doi.org/10.1016/j.jfca.2015.03.005>

Acknowledgments:

This work was supported by grant VEGA 1/0290/14.

Contact address:

Ján Kovarovič, Slovak University of Agriculture in Nitra, Faculty of Biotechnology and Food Sciences, Department of Chemistry, Tr. A. Hlinku 2, 949 76 Nitra, Slovakia, E-mail: xkovarovic@is.uniag.sk

Judita Bystrická, Slovak University of Agriculture in Nitra, Faculty of Biotechnology and Food Sciences, Department of Chemistry, Tr. A. Hlinku 2, 949 76 Nitra, Slovakia, E-mail: Judita.bystricka@centrum.sk

Ján Tomáš, Slovak University of Agriculture in Nitra, Faculty of Biotechnology and Food Sciences, Department of Chemistry, Tr. A. Hlinku 2, 949 76 Nitra, Slovakia, E-mail: jan.tomas@uniag.sk

Marianna Lenková, Slovak University of Agriculture in Nitra, Faculty of Biotechnology and Food Sciences, Tr. A. Hlinku 2, 949 76 Nitra, Slovakia, E-mail: mariannalenkova@gmail.com

IMPACT OF NUTRITION ON THE QUALITY AND QUANTITY OF CAULIFLOWER FLORETS

Anton Uher, Ivana Mezeyová, Alžbeta Hegedúsová, Miroslav Šlosár

ABSTRACT

Cauliflower (*Brassica oleracea* var *botrytis*) as a member of the family Brassicaceae belongs to worldwide popular vegetable with using in all kinds of cuisine. The aim of the work was to find out the effects of nutrition and fertilization (in dependence on the amount of nitrogen) on the yield of florets as well as on selected qualitative characteristics - vitamin C, nitrate and sulforaphane content. Analyses were done by the help of liquid chromatograph (HPLC) with UV detector for separation. The trial was led in Nitra, Slovakia, in 2014 – 2015. Cauliflower variety CHARLOT F1 was selected for testing. Four variants have been examined in the trial: control (without application of fertilizers), N₁₅₀S₈₀ (application of nitrogen and sulphur at the supply level N: S = 150:80 kg.ha⁻¹), N₂₀₀S₈₀ and N₂₅₀S₈₀. Application of nitrogen led to significant increasing of the yields of primary cauliflower florets in case of the dose 200 and 250 kg N.ha⁻¹ (increasing about 87% and 134% compared to control). Applied nitrogen nutrition caused significant nitrates increasing in monitored cauliflower florets in order of the variants: 1 (control) <2 (N = 150 kg.ha⁻¹) <3 (N = 200 kg.ha⁻¹) <4 (N = 250 kg.ha⁻¹), but the highest dosage of nitrates is still under the permissible standard according to Food codex of Slovak republic (700 mg.kg⁻¹ of FM). The influence of differentiated nutrition on sulforaphane content was statistically confirmed in case of the 4th variant in comparison to control, where the decrease about 40% was noticed. Influence of nitrogen fertilizing according to used methodology on vitamin C (AA) content was not statistically confirmed. The nutrient concentration in the curds and stalks of cauliflower varied insignificantly with levels of nitrogen applied.

Keywords: cauliflowers; nitrogen fertilizers; vitamin C; nutrition

INTRODUCTION

Cauliflower (*Brassica oleracea* var *botrytis*) as a member of the family Brassicaceae belongs to worldwide popular vegetable with using in all kinds of cuisine. In the nutritional composition it has a high proportion of water, up to 91%, sugar in an amount of 4.5%, protein 2.5%, crude fibre 1.8%, and low fat, only 0.3%. From the minerals in the cauliflower are significantly represented potassium, phosphorus, calcium, sodium, magnesium, as well as iron and sulphur. Another part are the phytochemicals, vitamins (vitamin C, vitamin B 12, PP, etc.) Uher et al. (2009). The vegetable when consumed confers health benefits to human as well as animals because of its richness in vitamins specially vitamin C, which is known to provide protection against certain types of cancer, help in lowering blood cholesterol, and serving as strong anti-oxidants Batabyala et al. (2016). Sulforaphane (SFN) shows a range of biological activities and health benefits in humans, has been found to be a very promising chemopreventive agent against not only a variety of cancers such as breast, prostate, colon, skin, lung, stomach, and bladder but also against cardiovascular

and neurodegenerative diseases and diabetes Kim et al. (2016). Very important for human health as well as for optimal growth of the plant is nutrition which starts on the field. The scientific researches show that application of optimum dose of boron and nitrogen decrease head rot and hollow stem of broccoli and increase macronutrient and micronutrient concentrations such as nitrogen, phosphorus, potassium, iron and zinc in broccoli head those are useful and necessary for human's health Yoldas et al. (2008).

Nitrogen and sulphur fertilization positively affected on crop yields and bioactive compounds (vitamin C, E1 and β-carotene) content in cauliflower edible heads (Uher et al., 2013) as well as accumulation of sulforaphane in the cauliflower (Čekey et al., 2011). The use of chemical fertilizers is essential in order to achieve the maximum potential of the genetic material and, as well as to succeed the highest possible yield and quality of the final product (Theofanoudis et al., 2015). Nitrogen fertilizers are commonly used to ensure the yields in brassicas productions. Their insufficiency leads to quality and quantity reduction of the cauliflower florets which is not acceptable to growers. However, the application of N

fertilizer will have a minimal effect on increasing yields if other factors are not properly managed (i.e., weather conditions and horticultural practice) (Quiro's et al., 2015). Cauliflower has high nitrogen (N) demand during growing, but due to its low N use efficiency and N-rich residues, it may cause N losses by leaching after harvest (Xie and Kristensen, 2016a). Intake of ascorbic acid, pectin, fibre and certain minerals, which significantly suppress the conversion of nitrate to N-nitrous compounds, is also favourable (Šrot, 2005).

Vegetable nitrate content is of interest to governments and regulators owing to the possible implications for health and to check that controls on the content are effective (Santamaria, 2006). The key to reduce soil nitrate N without jeopardizing crop yields may be to identify suitable growing periods, sometimes combined with root pruning, for each LM (living mulches) species and system design (Xie et al., 2016b). Nitrate per se is relatively non-toxic but approximately 5% of all ingested nitrate is converted in saliva and the gastrointestinal tract to the more toxic nitrite (Santamaria, 2006). Nitrate metabolites may produce a number of health effects, some studies showed that nitrate exposure is correlated with gastric cancer risk due to the endogenous formation of N-nitroso compounds (Nejatzadeh-Barandozi and Gholami-Borujeni, 2013). Approximately 80% of dietary nitrates are derived from vegetable consumption; sources of nitrites include vegetables, fruit, and processed meats (Hord et al., 2009).

The aim of this work was to determine the effect of nutrition and fertilization (the amount of nitrogen) on the yield, the vitamin C (ascorbic acid) and sulforaphane content as well as on the nitrate content in the cauliflower florets.

MATERIAL AND METHODOLOGY

The trial realisation

The sowing of the cauliflower seeds was realised on May 15th 2014 and May 14th 2015 on free land (field

conditions) at the Department of Vegetable FZKI in Nitra. Planting of the seedlings took place on June 16th 2014 and June 22nd 2015. The area of experimental plots of 1 repeat was 2.25 m²; in case of quadruplicate repetition the area of one experimental variant measured 9 m². In one repeat 9 seedlings of cauliflower were planted in spacing of 0.5 x 0.5 meters. The harvest of florets in physiological maturity was realised gradually starting from October 1st to October 28th in the frame of both observed years, whereby the 5 partial harvests were done. Analyses of qualitative parameters were made from the last harvest on case of both tested years. For sample preparation, cauliflower florets were harvested from different points of each treatment replication. The average sample from each treatment replication was prepared from 6 – 7 florets of cauliflower and it was taken from several points of floret and stalk. Samples prepared for sulforaphane determination were sequentially lyophilized at -58°C. The results were counted in fresh mass. The analyses of ascorbic acid and nitrate content were done at fresh samples of cauliflower.

In the experiment the cauliflower variety CHARLOT F1 was selected for testing. It is an excellent hybrid for early spring as well as for summer cultivation for direct consumption. It has solid white, good coverage rosette with very strong healthy foliage. It maintains its quality even in warm weather. This hybrid is resistant to yellowing of the florets. Vegetation period is 78 days.

Fertilisation

The variants with fertilization treatments were following:

0 – control (without application of fertilizers),

N₁₅₀S₈₀ – application of nitrogen and sulphur at the supply level N: S = 150:80 kg.ha⁻¹,

N₂₀₀S₈₀ – application of nitrogen and sulphur at the supply level N: S = 200:80 kg.ha⁻¹,

N₂₅₀S₈₀ – application of nitrogen and sulphur at the supply level N: S = 250:80 kg.ha⁻¹



Figure 1 Cauliflower planting, Nitra 2015.

Table 1 Climate characteristics in experiment area, in 2014, 2015, Nitra.

	2014		2015	
	Temperature (°C)	Rainfall (mm)	Temperature (°C)	Rainfall (mm)
VI.	19.3 <i>H</i>	52.5 <i>N</i>	19.9 <i>H</i>	10.2 <i>ED</i>
VII.	21.8 <i>H</i>	64.1 <i>N</i>	23.6 <i>EH</i>	17.2 <i>VD</i>
VIII.	18.9 <i>N</i>	55.9 <i>N</i>	23.5 <i>EH</i>	57.7 <i>N</i>
IX.	16.8 <i>H</i>	122.0 <i>EW</i>	17.5 <i>H</i>	33.2 <i>N</i>
X.	12.1 <i>H</i>	34.6 <i>N</i>	10.5 <i>N</i>	54.8 <i>VW</i>
total	88.9	329.1	95.0	173.1
mean	17.8	65.8	19.0	34.6

Note: *Explanatory notes: evaluation of the months according to climatic normal 1961 – 1990, considering temperature: *N* – normal, *H* – hot, *EH* – extremely hot, considering rainfall: *N* – normal, *EW*- extremely wet, *ED* - extremely dry, *VW* – very wet, *VD* – very dry.

Table 2 Agrochemical characteristics of the soil before the foundation of the experiment in 2014, 2015, Nitra.

	humus %	pH/KCl	Nutrients content in mg.kg ⁻¹ of the soil					
			N	P	K	S	Ca	Mg
2014	3.46 Good	6.47 Sl. A	19.5 M	86.3 G	498 VH	26.25 M	610 H	816 VH
2015	3.25 Good	7.16 N	19.1 M	245 VH	149.5 M	7.5 VL	6340 H	643.5 VH

Note: Explanatory notes: Nutrient content: *VL* – very low content, *L* – low content, *M* – medium content, *G* – good content, *H* – high content, *VH*- very high content, pH: *pH* - *Sl. A* - Slightly acidic, *N* - neutral.

The doses of N and S were calculated on the basis of agrochemical soil analysis at the depth 0 – 0.30 m before experiment establishment (Table 2).

The fertilizer DASA 26/13 was applied three weeks before planting. The calculated dose of LAD 27 was applied in two terms - three (50%) and six weeks (50%) after planting. DASA 26/13 (26% of N and 13% of S; manufacturer: Duslo, a. s., Šaľa, Slovak republic) were used for N and S supply.

Quantity and quality parameters estimation

Yields

Quantitative parameters of the cauliflower were estimated in the frame of five harvests. Florets were harvested in consume maturity. Total reached yield was expressed in t. ha⁻¹ after particular weighting in fresh mass.

Ascorbic acid (AA)

HPLC method of vitamin C content estimation (Stan, et al., 2014) was used by the help of liquid chromatograph with UV detector, for separation was used RP C18 column, mobile phase was methanol : water (5:95, v/v), UV detection was adjusted to 258 nm (HPLC fy. VARIAN).

Sulforaphane content

Sulforaphane content was measured by method of high pressure liquid chromatography (HPLC) at the certified

laboratory. It was done according to the methods previously described by (Sivakumar et al., 2007). The principle of the method is sulforaphane extraction by dichloromethane followed by HPLC analysis and subsequent detection with UV – VIS detector.

Nitrates content NO₃⁻

Determination of nitrate was done according to methods described in Hegedús et al. (2010). It was performed with a Varian Analytical Instrument (Walnut Creek, CA, USA) equipped with a Solvent Delivery System (type 9012), used in isocratic elution mode for nitrate determination and a UV–VIS detector (Varian type 9050) at 215 nm, a Spark Holland Autosampler (Basic-Marathon type 816, Aj Emmen, The Netherlands) and a 20 µL sample loop. Varian Star Workstation software was used.

Statistical analyses

The obtained data were processed into tables in Microsoft Office Excel 2007. Then analysis of variance (ANOVA) were used by the help of the Tukey test (significance level $\alpha = 0.05$) for statistical analyses in the program StatgraphicCenturion XVII (StatPointInc. USA).

RESULTS AND DISCUSSION

Yields

Table 3 Analysis of fertilising influence on yields (t.ha⁻¹) of cauliflower variety CHARLOT F1, Nitra, SR*.

Yields	2014 ^A (t.ha ⁻¹ of FM)	2015 ^B (t.ha ⁻¹ of FM)	2014 – 15 (t.ha ⁻¹ of FM)
Control	15.30 ±2.90	9.20 ±5.50	12.25 ±4.20 ^a
150 N	17.60 ±0.50	23.31 ±8.20	20.45 ±4.35 ^{ab}
200 N	17.40 ±0.10	28.47 ±6.80	22.94 ±3.45 ^b
250 N	18.00 ±0.90	39.32 ±7.36	28.66 ±4.13 ^b

Note: *Means ± standard deviation.

Values with different italics letters are significantly different at $P < 0.05$ by LSD in ANOVA.

Table 4 Analysis of fertilising influence on ascorbic acid (AA) content of cauliflower variety CHARLOT F1, Nitra, SR*.

AA	2014 ^A (mg.kg ⁻¹ of FM)	2015 ^B (mg.kg ⁻¹ of FM)	2014 – 15 (mg.kg ⁻¹ of FM)
Control	477.33 ±17.62	135.50 ±30.50	306.42 ±24.06 ^a
150 N	330.33 ±75.69	218.33 ±80.50	274.33 ±78.10 ^a
200 N	380.33 ±147.55	211.00 ±65.37	295.67 ±106.46 ^a
250 N	380.67 ±23.29	251.00 ±90.57	315.83 ±56.93 ^a

Note: *Means ± standard deviation.

Values with different italics letters are significantly different at $p < 0.05$ by LSD in ANOVA.

The yields of primary cauliflower florets were increased by the influence of applied nutrition in all evaluated variants compared to a control variant without fertilization (Table 3) during the monitored period under the terms of methodology. The lowest yield reached the value of 12.25 t.ha⁻¹ (control variant); the highest yield 28.66 t.h⁻¹ was reached by the highest dose of fertiliser (250 N). Application of nitrogen led to significant yields increasing confirmed by statistical analysis in case of the dose 200 and 250 kg N.ha⁻¹ (increasing about 87% and 134% compared to control). Increasing of the yields after nitrogen fertilizing corresponds with the results of **Nazrul and Shaheb (2016)**, when their results revealed that yields of cabbage and cauliflower responded significantly to fertilizer doses, levels of lime, and their combinations in all the locations.

According to **Bashyal (2011)** application of nitrogen along with the biofertilizer significantly increased yield as compared to application of nitrogen without biofertilizer. Cauliflower curd yield obtained at 120 kg nitrogen ha⁻¹ did not significantly differ with the curd yield recorded at 60 kg nitrogen and 2 kg biofertilizer ha⁻¹. The effect of different levels of organic manures and conventional practices on growth, yield and quality of cauliflower was studied by **Prabhakar et al. (2015)**. The trial included five levels of organic manure nutrient and two inorganic nutrient supplies. The treatment which received recommended dose of farm yard manure along with recommended NPK produced the highest mean curd yield (21.23 t.ha⁻¹) followed by the treatments, which received 100 and 75 percent recommended dosage of nitrogen (RDN) through organics (19.36 and 18.42 t.ha⁻¹).

The influence of climate characteristics was very significant, according to used statistical analyses (Table 3). In 2015 the yields were higher in case of all three fertilised variants. Climate conditions in 2015 as an important external factor influenced the yields because there was higher total sum of temperature during the growing season and according to evaluation of the months according to climatic normal 1961-1990, the July and August was

extremely hot (Table 2). The rainfall hasn't that influence, because the trial was irrigated as needed.

Ascorbic acid (AA)

Average value of AA (vitamin C) ranged in interval from 274.42 mg.kg⁻¹ (in case of the dosage of 150 kg N.ha⁻¹) to 315.83 mg.kg⁻¹ (the highest dosage of 250 kg N.ha⁻¹), while the value of control variant 306.42 mg.kg⁻¹ moved between the limits (Table 4). Influence of nitrogen fertilizing according to used methodology on vitamin C (AA) content was not statistically confirmed. The nutrient concentration in the curds and stalks of cauliflower varied insignificantly with levels of nitrogen applied.

Growing cauliflower without additional sources of nutrients (control) caused significant decrease (9%) in total organic C (TOC) than that in the initial soil according to **Batabyal et al., (2016)** as they evaluated 15 nutrient management (NM) technologies for production of cauliflower taking its yield, quality, profitability, energy balance and environmental sustainability in terms of soil quality as the goal variables. **Bayshal, (2011)** noticed that after application of nitrogen along with the biofertilizer the vitamin C content was significantly increased and the highest vitamin C content of curds and the most attractive curd color were recorded at 60 kg nitrogen and 2 kg biofertilizer.ha⁻¹. Variable results in case of fertilizing effect on vitamin C were found by the **Hrabovska et al. (2012)** in case of potato. The content of C vitamin was increased with the graduated nitrogen doses to the soil only till variant 4 and after that the content of vitamin C was decreased. The average content of C vitamin ranged in interval 3.786 – 6.225 mg.kg⁻¹ of fresh matter. Also in case of potato in research of **Hamouz et al. (2009)** there was noticed, that after soil application of 180 kg N.ha⁻¹ the level of vitamin C decreased about 12.4%, compared with soil application of 100 kg of N.ha⁻¹. When tested members of the family *brassicaceae* by **Lisiewska and Kmiecik 1996**, directly after harvesting, broccoli contained 116.3 – 116.4 mg of vitamin C in 100 g of fresh matter, and cauliflower contained 60.5 – 64.7 mg. Increasing the

Table 5 Analysis of fertilising influence on sulforaphane content of cauliflower variety CHARLOT F1, Nitra, SR*.

Sulforaphane	2014 ^A (mg.kg ⁻¹ of FM)	2015 ^B (mg.kg ⁻¹ of FM)	2014 – 15 (mg.kg ⁻¹ of FM)
Control	3.80 ±0.30	9.02 ±0.40	6.41 ±0.35 ^{bc}
150 N	3.20 ±0.20	10.52 ±0.74	6.86 ±0.47 ^c
200 N	2.80 ±0.20	8.29 ±0.06	5.54 ±0.13 ^b
250 N	2.00 ±0.30	5.66 ±0.44	3.83 ±0.37 ^a

Note: *Means ± standard deviation.

Values with different italic letters are significantly different at $p < 0.05$ by LSD in ANOVA.

Table 6 Analysis of fertilising influence on nitrates content of cauliflower variety CHARLOT F1, Nitra, SR*.

Nitrates	2014 ^A (mg.kg ⁻¹ of FM)	2015 ^A (mg.kg ⁻¹ of FM)	2014 – 15 (mg.kg ⁻¹ of FM)
Control	86.80 ±25.20	120.67 ±72.67	103.73 ±33.56 ^a
150 N	268.50 ±5.50	183.67 ±75.74	226.08 ±49.67 ^b
200 N	297.48 ±165.33	172.67 ±45.76	235.07 ±84.54 ^{bc}
250 N	391.00 ±59.01	279.67 ±96.70	335.33 ±26.66 ^c

Note: *Means ± standard deviation.

amount of nitrogen fertilizer from 80 to 120 kg N ha⁻¹ decreased the content of vitamin C only in cauliflower (by 7%). In our two years trial the influence of climate on vitamin C was confirmed (Table 4). **Açıköz (2012)** states that the vitamin C in vegetables was influenced by the seasons. He indicates in his work that the detected level of vitamin C in spring variant of mizuna (*Brassica rapa japonica*) was 702 mg.kg⁻¹ and in autumn variant 576 mg.kg⁻¹.

Sulforaphane content

The lowest average value of sulforaphane content 3.83 mg.100 kg⁻¹ was reached in the variant 4 (the variant with highest dosage N = 250 kg.ha⁻¹) <3 (N = 200 kg.ha⁻¹) <1 (control) <2 (N = 150 kg.ha⁻¹) with the highest average value 6.86 mg.100g⁻¹ (Table 5). The influence of differentiated nutrition on sulforaphane content was statistically confirmed in case of the 4th variant in comparison to control, where the decrease about 40.24% was noticed.

The effect of four different variants of nitrogen on sulforaphane content in cauliflower florets was studied by **Čekey et al. (2011)** in the same conditions of fertilisation as in our trial. Their results varied in range from 2.50 mg.kg⁻¹ to 2.96 mg.kg⁻¹ of fresh matter and it increased in following variants order: 1 (control) <2 <3 <4. The highest sulforaphane content was ascertained at the variant 4 (2.96 mg.kg⁻¹). Similar trial was led by **Šlosár et al. (2013)** where they tested the nutrition influence on broccoli. The control variant (1) was free of any industrial fertilizers. In the nutrition variants 2, 3, 4, fertilizers LAD27 and DASA 26/13 were used to replenish supplies of N and S. The highest sulforaphane content was reached in variant with the highest dosage of both observed fertilisers: 48.43 – 50.93 mg.kg⁻¹ of fresh matter; compared to the control variant, the increase of sulforaphane reached 5.2%. The N, S and Zn fertilization tended to the higher content of sulforaphane (SF) in broccoli florets according to **Šlosár et al. 2016**. The statistically significant increase of SF content was shown at all fertilized treatments in comparison with control treatment.

Nitrates content NO₃⁻

Applied nitrogen nutrition caused significant nitrates increasing in monitored florets of the cauliflower according to our expectations in order of the variants: 1 (control) <2 (N = 150 kg. ha⁻¹) <3 (N = 200 kg. ha⁻¹) <4 (N = 250 kg. ha⁻¹). According to statistical analyses there was found significant difference between the all variants in comparison to control (Table 6). Under the same conditions of fertilisation as in our trial the nutrition on cauliflower was applied in the trial of **Čekey et al. (2011)**. They observed also nitrates content and differentiated nutrition resulted in increased accumulation of nitrates in the cauliflower. The most increase of nitrate content, compared to the control variant, was also ascertained at the variant 4 (about 31.4%). **Lisiewska and Kmiecik (1996)** noticed in their trial with brassica vegetable and nutrition, that increasing the amount of nitrogen fertilizer from 80 to 120 kg N.ha⁻¹ raised the level of nitrates by 44% in broccoli and by 33% in cauliflower. The effect of nitrogen (N), sulphur (S) and zinc (Zn) fertilization on the yield quantity and selected qualitative parameters of broccoli was studied in the experiment of **Šlosár et al. (2016)**. The application of N fertilizers resulted in an increased accumulation of nitrates in broccoli florets. The nitrate content was ranged from 474.4 mg.kg⁻¹ (control) to 632.8 mg.kg⁻¹ of fresh weight (N₂₀₀S₈₀). At the treatment N₂₀₀S₈₀, the nitrate content was higher about 33.4% in comparison with control variant. The maximally highest acceptable amount of nitrates in Brassica vegetable species (700 mg.kg⁻¹ of FW) as it is established by Food codex of Slovak republic (**SVFA SR, 2014**) was kept in case of all variants.

The climate characteristics influence wasn't confirmed in case of nitrates, in time of florets creation there wasn't found any extremes in temperature according to evaluation of the months according to climatic normal 1961 – 1990 (Table 2). The seasons as important nitrates influencing factor was confirmed by **Kudrnáčová and Kouřimská (2015)**. Overall, the nitrate content ranged from 221 to 334 mg.kg⁻¹ in spring varieties and from 249 to 384 mg.kg⁻¹ in autumn varieties of non-traditional vegetables from *brassicaceae*. In the favourable effect of

light and heat on the reduction of nitrate content in plants was interested **Weightman et al. (2006)**. Their research resulted in some connection between observed characteristics: short-term shading (24 – 48 h) had no significant effects on mean tissue nitrate concentration (TNC), unlike the increase in TNC known to occur following dull periods 10 – 14 days before harvest. The effect on TNC of time of day harvested was significant, but there was no obvious pattern of diurnal variation.

CONCLUSION

The effect of fertilization (the amount of nitrogen) on quantity and quality of cauliflower florets was observed by the testing of four different variants of nutrition. From quantitative parameters the yields were evaluated as an important characteristic from economic point of view. There was found the significant, statistically confirmed increasing of the yields after the fertilisers using. The crop yields were depended on the increasing dosage. The highest yield was in variant with the highest dosage of applied nitrogen. Applied nitrogen nutrition caused significant nitrates increasing in monitored florets of the cauliflower, nitrates content increased from 103.73 mg.kg⁻¹ of FM (control) to 335.33 mg.kg⁻¹ of FM (4. variant). The dependence of increasing was statistically confirmed, but the highest dosage of nitrates is under the permissible standard according to Food codex of Slovak republic (700 mg.kg⁻¹ of FM). All the used dosage can be recommended to farmers for using as a possibility of yields increasing. When evaluating quality, the highest dosage N₂₅₀S₈₀ (application of nitrogen and sulphur at the supply level N: S = 250:80 kg.ha⁻¹) caused decreasing of sulforaphane content according to used statistical analyses. The highest average value of sulforaphane content 6.86 mg. 100 kg⁻¹ was reached in second variant (N₁₅₀S₈₀), but the influence of fertilizing wasn't statistically confirmed on tested level. Dependence of vitamin C (AA) content increasing on nitrogen fertilizing according to used methodology was not statistically confirmed.

REFERENCES

Açıkgöz, F. E. 2012. Determination of Yield and Some Plant Characteristics with Vitamin C, Protein and Mineral Material Content in Mibuna (*Brassica rapa* var. *Nipposinica*) and Mizuna (*Brassica rapa* var. *Japonica*) Grown in Fall and Spring Sowing Times. *Journal of Tekirdağ Agricultural Faculty*, vol. 9, no. 1, p. 64-70.

Bashyal, L. N. 2011. Response of cauliflower to nitrogen fixing biofertilizer and graded levels of nitrogen. *The Journal of Agriculture and Environment*, vol. 12, p. 41-50.

Batabyala, K., Mandala, B., Sarkara, D., Murmua S., Tamangb, A., Dasc, A., Hazraa, G. Ch., Chattopadhyaya, P. S. 2016. Comprehensive assessment of nutrient management technologies for cauliflower production under subtropical conditions. *European Journal of Agronomy*, vol. 79, p. 1-13. <https://doi.org/10.1016/j.eja.2016.04.009>

Čekey, N., Šlosar, M., Uher, A., Balogh, Z., Valšikova, M., Lošák, T. 2011. The effect of nitrogen and sulphur fertilization on the yield and content of sulforaphane and nitrates in cauliflower. *Acta Universitatis Agriculturae et Silviculturae Mendelianae Brunensis*, vol. 59, no. 5, p. 17-22. <https://doi.org/10.11118/actaun201159050017>

Hamouz, K., Lachman, J., Dvořák, P., Orsák, M., Hejtmánková, K., Čížek, M. 2009. Effect of selected factors

on the content of ascorbic acid in potatoes with different tuber flesh colour. *Plant, Soil and Environment*, vol. 55, no. 7, p. 281-287.

Hegedűs, O., Hegedűsová, A., Jakabová, S., Vargová, A., Pernyeszi, T., Boros, B. 2010. Evaluation of an HPLC method for determination of nitrates in vegetables. *Chromatographia*, vol.71, suppl. no. 1, p. 93-97. <https://doi.org/10.1365/s10337-010-1595-9>

Hord, N. G. Tang, Y., Bryan, N. S. 2009. Food sources of nitrates and nitrites: the physiologic context for potential health benefits. *The American Journal of Clinical Nutrition*, vol. 90, no. 1, p.1-10. <https://doi.org/10.3945/ajcn.2008.27131> [PMid:19439460](https://pubmed.ncbi.nlm.nih.gov/19439460/)

Hrabovská, D., Musilová, J., Bystrická, J., Tomáš, J., Bajčan, D. 2012. Effect of nitrogen application on selected nutritional components of potato tubers. *Potravinárstvo*, vol. 6, no. 4, p. 24-27. <https://doi.org/10.5219/220>

Islam, M., Hoque, M. A., Reza, M. M., Chakma, S. P. 2015. Effect of boron on yield and quality of broccoli genotypes. *International Journal of Experimental Agriculture*, vol. 5, no. 1, p. 1-7.

Kim, J. K., Park, S. U. 2016. Current potential health benefits of sulforaphane. *EXCLI Journal*, vol. 15, p. 571-577.

Kudrnáčová, E., Kouřimská, L. 2015. Qualitative parameters of non-traditional types of vegetables - determination of nitrates and ascorbic acid content, *Potravinárstvo*, vol. 9, no. 1, p. 237-241. <https://doi.org/10.5219/466>

Lisiewska, Z., Kmiecik, W. 1996. Effects of level of nitrogen fertilizer, processing conditions and period of storage of frozen broccoli and cauliflower on vitamin C retention. *Food Chemistry*, vol. 57, no. 2., p. 267-270. [https://doi.org/10.1016/0308-8146\(95\)00218-9](https://doi.org/10.1016/0308-8146(95)00218-9)

Nazrul, M. I., Shaheb, M. R. 2016. Integrated approach for liming and fertilizer application on yield of cabbage and cauliflower in acidic soil of Sylhet. *Bangladesh Agron. Journal*, vol. 19, no. 1, p. 49-57. <https://doi.org/10.3329/baj.v19i1.29870>

Nejatzadeh-Barandozi, F., Gholami-Borujeni, F. 2013. Nitrate and nitrite in leek and spinach from Urmia district and their changes as affected by boiling. *International Journal of Environmental Health Engineering*, vol. 2, no. 46, p. 1-5. <https://doi.org/10.4103/2277-9183.122442>

Prabhakar, M., Hebbar, S. S., Nair, A. K., Shivashankara, K. S., Chinnu, J. K., Geetha, G. A. 2015, Effect of different organic nutrient levels on growth, yield and quality in cauliflower. *Indian Journal of Horticulture*, vol. 72, no. 2, p. 293-296. <https://doi.org/10.5958/0974-0112.2015.00056.0>

Quiro's, R., Villalba, G., Gabarrell, X., Munoz, P. 2015. Life cycle assessment of organic and mineral fertilizers in a crop sequence of cauliflower and tomato. *International Journal Environmental Science and Technology*, vol. 12, p. 3299-3316. <https://doi.org/10.1007/s13762-015-0756-7>

Santamaria, P. 2006. Review: Nitrate in vegetables: toxicity, content, intake and EC regulation. *Journal of the Science of Food and Agriculture*, vol. 86, no. 1, p. 10-17. <https://doi.org/10.1002/jsfa.2351>

Sivakumar, G., Aliboni, A., Baccheta, L. 2007. HPLC screening of anti-cancer sulforaphane from important European Brassica species. *Food Chemistry*, vol. 104, no. 4, p. 1761-1764. <https://doi.org/10.1016/j.foodchem.2006.11.040>

Šlosár, M., Uher, A., Andrejiová, A., Juríková, T. 2016. Selected yield and qualitative parameters of broccoli in

dependence on nitrogen, sulfur, and zinc fertilization. *Turkish Journal of Agriculture and Forestry*, vol. 40, p. 465-473. <https://doi.org/10.3906/tar-1501-99>

Šlosár, M., Uher, A., Čekey, N. 2013. The effect of nitrogen and sulphur nutrition on the yield and content of antioxidants in broccoli. *Acta Horticulturae et Regiotecturae*. vol. 16, no. 1, p. 14-17. <https://doi.org/10.2478/ahr-2013-0004>

Šrot, R. 2005. *Zelenina – Rady pěstitelům (Vegetables - Counsels for Growers)*. 1st ed. Praha : Aventinum., 197 p., ISBN 80-7151-248-6.

Stan, M., Soran, M. L., Marutoiu, C. 2014. Extraction and HPLC Determination of the Ascorbic Acid Content of Three Indigenous Spice Plants. *Journal of Analytical Chemistry*, vol. 69, no. 10, p. 998-1002. <https://doi.org/10.1134/S106193481410013X>

SVFA SR, 2014. Food codex of the Slovak republic. The State Veterinary and Food Administration of the Slovak Republic, Bratislava, Slovak Republic [online] s.a. [cit.2017-01-20] Available at: http://www.svps.sk/dokumenty/legislativa/14300_2007.pdf

Theofanoudis, S., Petropoulos, S., Antoniadis, A. 2015. The effect of manure, zeolite and mineral fertilizer on the yield and mineral composition of cauliflower. In *Agrosym 2015, Sixth International Scientific Agricultural Symposium*. Jahorina, p. 1058-1062.

Uher, A., Šlosár, M., Valšíková, M. 2013. Fertilisation impact on the content of selected bioactive compounds in cauliflower. *Journal of Central European Agriculture*, vol. 14, no. 1, p. 261-269. <https://doi.org/10.5513/JCEA01/14.1.1193>

Uher, A., Kóňa, J., Valšíková, M., Andrejiová, A. 2009. *Zeleninárstvo - Poľné pestovanie (In Slovak Vegetable Production - field cultivation)*, 1st ed. Nitra : Slovenská poľnohospodárska univerzita v Nitre. 212 p. ISBN 978-80-552-0199-3.

Uher, A., Šlosár, M., Valšíková, M. 2013. Fertilisation impact on the content of selected bioactive compounds in cauliflower. *Journal of Central European Agriculture*, vol. 14, no. 1, p. 261-269. <https://doi.org/10.5513/JCEA01/14.1.1193>

Weightman, R. M., Dyer, C., Buxton, J., Farrington, D. S. 2006. Effects of light level, time of harvest and position within field on the variability of tissue nitrate concentration in commercial crops of lettuce (*Lactuca sativa*) and endive

(*Cichorium endiva*). *Food Additives and Contaminants*, vol. 23, no. 5, p. 462-469. <https://doi.org/10.1080/02652030500522606> PMID:16644593

Xie, Y., Kristensen, H. L. 2016a. Overwintering grass-clover as intercrop and moderately reduced nitrogen fertilization maintain yield and reduce the risk of nitrate leaching in an organic cauliflower (*Brassica oleracea* L. var. *botrytis*) agroecosystem. *Scientia Horticulturae*, vol. 206, p. 71-79. <https://doi.org/10.1016/j.scienta.2016.04.034>

Xie, Y., Tittarelli, F., Fragstein, P., Bavec, M. 2016b. Can living mulches in intercropping systems reduce the potential nitrate leaching? Studies of organic cauliflower (*Brassica Oleracea* L. Var. *Botrytis*) And Leek (*Allium Porrum* L.) Production Accros European Conditions. *Renewable Agriculture and Food Systems*, vol. 1, p.1-16. <https://doi.org/10.1017/S1742170516000211>

Acknowledgments:

The work was supported by small grants program financed by The International Visegrad Fund, Project number: 11530015.

Contact address:

prof. Ing. Anton Uher, PhD., Department of Vegetable Production, Horticulture and Landscape Engineering Faculty, Slovak University of Agriculture in Nitra, Tr. A. Hlinku 2, 949 76 Nitra, Slovak Republic, E-mail: anton.uher@uniag.sk

Ing. Ivana Mezeyová, PhD., Department of Vegetable Production, Horticulture and Landscape Engineering Faculty, Slovak University of Agriculture in Nitra, Tr. A. Hlinku 2, 949 76 Nitra, Slovak Republic, E-mail: ivana.mezeyova@uniag.sk

prof. RNDr. Alžbeta Hegedúsová, PhD., Department of Vegetable Production, Horticulture and Landscape Engineering Faculty, Slovak University of Agriculture in Nitra, Tr. A. Hlinku 2, 949 76 Nitra, Slovak Republic, E-mail: alzbeta.hegedusova@uniag.sk

Ing. Miroslav Šlosár, PhD., Department of Vegetable Production, Horticulture and Landscape Engineering Faculty, Slovak University of Agriculture in Nitra, Tr. A. Hlinku 2, 949 76 Nitra, Slovak Republic, E-mail: miroslav.slosar@uniag.sk



THE EFFECT OF CALCIUM AND MAGNESIUM SUPPLEMENTATION ON PERFORMANCE AND BONE STRENGTH OF BROILER CHICKENS

Filip Karásek, Hana Štenclová, Ondřej Šťastník, Eva Mrkvicová, Leoš Pavlata, Šárka Nedomová, Ladislav Zeman

ABSTRACT

Aim of the experiment was evaluation of the effect of reduced calcium and magnesium content in the broiler chickens diet on its parameters of fattening, bone strength and calcium and magnesium content in liver. The trial was performed with cockerels of Ross 308 hybrid ($n = 160$) which were fattened in cage batteries from day 11th to 36th day of age. Cockerels were divided into 4 groups (differ in various intake levels of calcium and magnesium) in four replications. The maize-wheat-soybean basal diet contained 2.33 g Ca and 1.58 g Mg per kilogram. Calcium was added by CaCO_3 and magnesium by MgSO_4 . Control group (C) received feed mixture with added CaCO_3 in dose of 19.49 g.kg^{-1} and 0.41 g.kg^{-1} of MgSO_4 . Three experimental groups contain added CaCO_3 in dose of 11.83 g.kg^{-1} and 0 g.kg^{-1} MgSO_4 (group Exp1); CaCO_3 11.83 g.kg^{-1} and 0.41 g.kg^{-1} MgSO_4 (group Exp2); CaCO_3 19.49 g.kg^{-1} and 0 g.kg^{-1} MgSO_4 (group Exp3), respectively. The feed consumption was daily monitored and the cockerels were weighed twice a week. At the end of the study the experimental animals were weighted and slaughtered by decapitation. The weight of carcasses, liver and proportion of breast and thigh muscle was determined in the selected chickens ($n = 24$). The atomic absorption spectrometry was used for Ca and Mg evaluation in liver tissues. Bone strength parameter was measured at the femur bone. The statistically significant differences ($p > 0.05$) were not detected between control and experimental groups in the case of studied parameters of fattening, bone strength and calcium and magnesium content in the chicken's liver. Based on the obtained results it could be concluded the reduction of determined elements in the chicken diet did not deteriorate parameters of yield, elements content in liver tissue as well as the bone strength of broiler chickens.

Keywords: poultry nutrition; Ross 308; liver; CaCO_3 ; MgSO_4

INTRODUCTION

Calcium (Ca) has important biological functions and must be provided in adequate amounts (Peters and Mahan 2008). Inadequate calcium intake may affect bone mineral content, muscle function and other functions of minerals in the body (Peters and Mahan 2008; Horky, 2015). Unfortunately, the mineral requirements of broiler chickens, as determined by several organizations 10 – 20 years ago, may not support optimal chicken performance in today's strain (Ruttanavut and Yamauchi 2010). It is known that the genetic makeup of the bird influences the utilization of Ca and thereby its requirement. Therefore, it is presumed that the requirement of Ca may not be the same as reported in earlier studies to meet the demand for highly productive birds (Shafey et al., 1990; Hurwitz et al., 1995). Magnesium (Mg) metabolism is closely associated with Ca and phosphorus (McDonald et al., 2011; Horky et al. 2016). Yang et al. (2012) reported that dietary MgSO_4 supplementation significantly prevented heat stress-induced oxidative damage and improved growth performance in broilers. Some minerals such as zinc (Zn), and Mg are strongly associated with the

antioxidant defense of organism (Sahin et al., 2006). Recommended nutrient content by Zelenka et al. (2007) indicates the delivered amount of calcium and magnesium in feed mixtures for fattening chickens 9 g.kg^{-1} of calcium and 0.5 g.kg^{-1} of magnesium. Magnesium is one of the most abundant divalent cation in living cells and plays a vital role in many cellular processes. Magnesium deficiency or reduction in dietary intake of Mg^{2+} is strongly correlated with numerous metabolic abnormalities and chronic diseases including diabetes, ischemic heart disease and hypertension in which the accumulation of reactive oxygen species (ROS) is commonly observed (Chakraborti et al., 2002; Guerrero-Romero and Rodriguez-Moran, 2002; Song et al., 2005; Valko et al., 2007; Bo and Pisu, 2008; Nevrkla et al., 2014; Nevrkla et al., 2016, Horky, 2014; Horky et al. 2012).

Aim of the experiment was evaluation of the effect of reduced calcium and magnesium content in the diet of broiler chicken on parameters of fattening, bone strength and calcium and magnesium content in the chicken's liver.

MATERIAL AND METHODOLOGY

Experimental birds, diets and treatments

The trial was performed with cockerels of Ross 308 hybrid (n = 160) which were fattened in cage batteries from day 11th to 36th day of age. Cockerels were divided into 4 groups in four replications. Prior to formulating the diets, feed components were analyzed for Ca and Mg contents and the data were used to formulate the experimental diets. The basal diet contained 2.33 g Ca and 1.58 g Mg per kilogram. The composition of the basal diet is shown in Table 1.

Calcium was added by CaCO₃ and magnesium by MgSO₄. Control group (C) received feed mixture with added CaCO₃ in dose of 19.485 g.kg⁻¹ and 0.407 g.kg⁻¹ of MgSO₄. Three experimental groups (Exp1; Exp2; Exp3) contain added CaCO₃ and MgSO₄ in doses reported in Table 2.

The crumbly feed mixture was supplied *ad-libitum* and its consumption was recorded every day. Access to drinking water was also *ad-libitum*. Weighing of chickens was carried two times a week. Microclimate and lighting regime were modified according to the technological instructions for Ross 308. The values of microclimate were recorded every day.

Evaluating of carcass quality

The experimental animals were weighted and slaughtered by decapitation in the age of 36 days. The weight of selected carcasses (n = 24) was determined. The carcass was free of neck, feather, offal and feet. After liver dissection, the livers were weighted and the percentage of the live weight of chicken was calculated. Subsequently, the skin from breast was removed and breast meat was deboned. The skin from legs was also removed and the legs were deboned. After breast and legs dissection, the muscles were weighted and the percentage of the live weight of chicken was calculated.

Determination of calcium and magnesium from liver tissue

Samples were mineralized by nitric acid with addition of hydrogen peroxide. The mineralization was carried out in microwave decomposition closed system Ethos 1 (Milestone S.r.l., Italy). After cooling, the mineralized samples were quantitatively transferred to 25 ml volumetric flask and fill up to the volume by demineralized water. The content of Ca and Mg in the mineralized samples was determined using atomic absorption spectrometry. The protocol was carried out using ContrAA 700 (Analytik Jena AG, Germany).

Table 1 Composition of the basal diet.

Ingredients	%
Maize	34
Wheat	31
Soybean meal	26
Sunflower oil	4
Vitamin-mineral premix*	2
Experimental premix**	2.5
Chromium oxide	0.5
Nutrient composition	
Dry matter	90
N-Substances	20.66
Ether extract	5.89
Crude fiber	3.14
Ash	5.53
Lysine	1.19
Methionine	0.58
Non-phytate P	0.30

*Note: premix content of one kg: lysine 101.65 g.kg⁻¹, methionine 135.63 g.kg⁻¹, threonine 51.22 g.kg⁻¹, calcium 68.31 g.kg⁻¹, phosphorus 98.19 g.kg⁻¹, natrium 62.89 g.kg⁻¹, magnesium 4.7 g.kg⁻¹, sulphur 0.39 g.kg⁻¹, chlorine 119.69 g.kg⁻¹, copper 752.5 mg.kg⁻¹, iron 3768.6 mg.kg⁻¹, zinc 3400 mg.kg⁻¹, manganese 6046.07 mg.kg⁻¹, cobalt 11 mg.kg⁻¹, iodine 47.95 mg.kg⁻¹, selenium 8.96 mg.kg⁻¹, retinol 680000 IU, cholecalciferol 250000 IU, alfatocopherol 2250 mg.kg⁻¹, K3 74.8 mg.kg⁻¹, B1 206.44 mg.kg⁻¹, B2 344 mg.kg⁻¹, B6 300.44 mg.kg⁻¹, B12 1999.2 mg.kg⁻¹, biotin 11 mg.kg⁻¹, niacinamid 1793.4 mg.kg⁻¹, calcium pantothenate 676.2 mg.kg⁻¹, folic acid 82.8 mg.kg⁻¹, choline chloride 9000 mg.kg⁻¹.

**Experimental premix: Content different levels of CaCO₃ and MgSO₄ according to Table 2.

Table 2 Addition of CaCO₃ and MgSO₄ (g.kg⁻¹) and total levels of Ca and Mg (g.kg⁻¹) in the diet.

	C	Exp1	Exp2	Exp3
CaCO ₃	19.485	11.832	11.832	19.485
MgSO ₄	0.407	0	0.407	0
Total Ca	9	6	6	9
Total Mg	2.33	1.58	2.33	1.58

Figure 1 Bone strength measurement.



The N_2O/C_2H_2 flame was used for the Ca and Mg determination. The samples and standard solutions were diluted in 1% HCl, the ionizing buffer KCl was used. For Ca and Mg analysis, the $LaCl_3$ as a displacing agent was used. The wavelength was set on $\lambda = 239.8559$ nm for Ca determination and $\lambda = 202.582$ nm for Mg determination.

Bone strength measurement

For the measurement was used a universal apparatus for measuring physical characteristics - TIRATEST 27025 (Germany). The device allows measurements of different materials in tension, compressive and flexural strength. To test the strength of bone was chosen three-point bending. Loading speed was 100 mm / min until fracture of bone. Bone strength parameter was measured at the femur bone.

Statistical analysis

Data has been processed by Microsoft Excel (USA) and STATISTICA.CZ, version 12.0 (CZ). The results were expressed as mean \pm standard deviation. One-way analysis (ANOVA) was used. Sheffe's test was applied to defined statistical differences and the differences between groups were considered significant at $p < 0.05$.

RESULTS AND DISCUSSION

During the experiment, the highest average feed consumption 4.65 kg per chicken was estimated in the group Exp2 (Table 3). The lowest feed consumption was estimated in the control group (4.47 kg per chicken). The differences of the feed consumption between both groups were not statistically significant ($p > 0.05$). The determined

feed consumption is lower than Akter et al described (Akter et al. 2016). It could be concluded the change of Ca and Mg content in the feed mixture did not affect the feed consumption significantly. This result is in agreement with Akter et al. (2016) who described the influence of low content of Ca in feed mixture which affects the increase intake of feed mixture by broiler chickens.

At the end of trial was observed non-significant ($p > 0.05$) higher average weight of chickens (2 126 g) in Exp2 group (Table 4). Whereas Hoeven-Hangoor et al. (2013) presented the addition of 0.255 g.kg^{-1} $MgSO_4$ was affected the average liveweight of chickens 2355g on 36th day of life. Akter et al. (2016) showed the addition 10 g.kg^{-1} of calcium in comparison with 6 g.kg^{-1} in the feed mixture highly influenced the decrease of liveweight gain. Similar results were published by Rama Rao et al. (2006) and Singh et al. (2013). However, we did not notice the described trend in our experiment. Whereas Liu et al. (2007) found the addition of magnesium to the feed mixture did not influence the average liveweight and feed intake in chickens.

Table 5 present the carcass yield. The highest carcass yield was found in the Exp1 group (73.62%) but differences between groups were not significant ($p > 0.05$). Carcass yield, stated in the technological procedure for Ross 308 (Aviagen Group 2014), is the 71.72% for 2,000 g of live weight. The higher breast and leg meat yield was found in the Exp1 group. According to the manual of hybrid Ross 308 (Aviagen Group 2014) 21.20% of breast muscle at 2,000 g of live weight is stated. The same manual (Aviagen Group 2014) indicates a yield of leg meat 16.01% for 2,000 g live weight. The differences among groups in slaughtering yields were not statistically significant ($p > 0.05$). Our results are in a good agreement with Akter et al. (2016), who found the different amount of calcium in the feed mixture did not affect of the carcass yield and the proportion of breast and thigh muscle in tested chickens. On the contrary of Salmanzadeh et al. (2012) observed in their experiment that glucose and glucose + magnesium administration significantly increased the breast muscle size of broiler chickens.

The highest liver weight was found in the control group compared to experimental groups (Table 5). Values are not statistically significant ($p > 0.05$). Similar results were published by Štenclová et al. (2016). They determined the low amount of zinc in the feed mixture significantly affect

Table 3 Feed consumption per chicken and trial.

Group	n	Mean (g) \pm standard deviation
C	25	4465 \pm 270.5
Exp1	25	4579 \pm 269.6
Exp2	25	4649 \pm 309.4
Exp3	25	4610 \pm 274.8

Note: Differences between groups were not statistically significant ($p > 0.05$).

Table 4 The average weight of broiler chickens at the beginning and end of the experiment.

Group	n	C	Exp1	Exp2	Exp3
		Mean (g) \pm standard deviation			
Start of the trial	40	311 \pm 3.1	315 \pm 3.6	315 \pm 2.7	310 \pm 2.8
End of the trial	40	2029 \pm 37.2	1982 \pm 39.3	2126 \pm 42.0	2057 \pm 42.8

Note: Differences between groups were not statistically significant ($p > 0.05$).

Table 5 Carcass yield.

Group	n	Carcass	Breast meat	Leg meat without bone	Liver
		Mean (%) ±standard deviation			
C	24	72.95 ±0.415	20.83 ±0.367	14.83 ±0.204	2.17 ±0.056
Exp1	24	73.62 ±0.397	21.69 ±0.348	15.23 ±0.172	2.02 ±0.061
Exp2	24	73.37 ±0.289	21.04 ±0.343	14.86 ±0.268	2.04 ±0.040
Exp3	24	73.34 ±0.339	20.76 ±0.415	15.04 ±0.209	2.10 ±0.052

Note: Differences between groups were not statistically significant ($p > 0.05$).

Table 6 Concentration of Ca and Mg in the liver (mg.kg⁻¹ fresh weight).

Group	n	Ca	Mg
		Mean (mg) ±standard deviation	
C	24	100.82 ±3.088	211.19 ±2.859
Exp1	24	97.24 ±2.269	208.91 ±3.724
Exp2	24	99.22 ±2.524	211.21 ±3.297
Exp3	24	99.27 ±2.495	208.82 ±2.802

Note: Differences between groups were not statistically significant ($p > 0.05$).

Table 7 Bone strength.

Group	n	Mean (N) ±standard deviation
C	24	247.90 ±11.308
Exp1	24	271.12 ±11.373
Exp2	24	267.13 ±10.467
Exp3	24	266.90 ±7.722

Note: Differences between groups were not statistically significant ($p > 0.05$).

the higher weight of liver in the control group in comparison with experimental group of chickens.

Table 6 shows average concentration of Ca and Mg in the liver (mg.kg⁻¹ fresh weight). The highest content of calcium in liver was estimated in the control group of chickens. The experimental group Exp2 showed the highest content of magnesium. The differences among analyzed groups were not statistically significant ($p > 0.05$). Our obtained results of Ca and Mg content in the liver tissue of broilers are comparable with results published by **Majewska et al. (2016)**. They observed the low calcium concentration (70.76 mg.kg⁻¹) and higher magnesium concentration (328.62 mg.kg⁻¹) in liver tissue of broiler chickens.

The highest average of leg bone strength was reached in the experimental group Exp2 (Table 7). However, the differences among examined groups were not statistically significant ($p > 0.05$). **Askari et al (2015)** found the average leg bone strength 246 N/m², that responds to our results of control group. The leg bone strength was determined 221.82 N/m² in the case of group with reduced content of Ca-P in the feed mixture. In contrary to results obtained by **Świątkiewicz et al. (2011)** the decreased level of calcium and phosphorus was tended to reduce breaking point of leg bone of broiler chicken.

CONCLUSION

From the obtained results is evident the reduced supplementation of calcium and selenium did not influence the evaluated parameters of fattened chickens. Based on our results could be concluded the reduced content of studied elements did not cause the reduction of feed intake, neither the parameters of fattening and bone strength. Prior to eventual introduction of low calcium and magnesium diet for fattened chicken is essential to carry out further

studies for evaluation of possible interactions with other mineral elements.

REFERENCES

- Akter, M., Graham, H., Iji, P. A. 2016. Response of broiler chickens to different levels of calcium, non-phytate phosphorus and phytase. *British Poultry Science*, vol. 57, no. 6, p. 779-809. <https://doi.org/10.1080/00071668.2016.1216943>
- Askari, M., Khatibjoo, A., Taherpoor, K., Fattahnia, F., Souri, H. 2015. Effects of Calcium, Phosphorus and Zinc in Wheat - Based Diets b on Broiler Chickens' Performance, Immunity and Bone Parameters. *Iranian Journal of Applied Animal Science*, vol. 5, no. 3, p. 723-730.
- Aviagen Group. 2014. Technological procedure for broiler Ross [online]. Aviagen Group [cit. 2016-11-15]. Available at: <http://en.aviagen.com/ross-308>.
- Bo, S., Pisu, E. 2008. Role of dietary magnesium in cardiovascular disease prevention, insulin sensitivity and diabetes. *Current Opinion in Lipidology*, vol. 19, no. 1, p. 50-56. <https://doi.org/10.1097/MOL.0b013e3282f33ccc>
- Guerrero-Romero, F., Rodriguez-Moran, M. 2002. Low serum magnesium levels and metabolic syndrome. *Acta Diabetologica*, vol. 39, no. 4, p. 209-213. <https://doi.org/10.1007/s005920200036>
- Horký, P. 2015. Effect of selenium on its content in milk and performance of dairy cows in ecological farming. *Potravinarstvo*, vol. 9, no. 1, p. 324-329. <https://doi.org/10.5219/492>
- Horký, P. 2014. Influence of increased dietary selenium on glutathione peroxidase activity and glutathione concentration in erythrocytes of lactating sows. *Annals of Animal Science*, vol. 14, no. 4, p. 869-882. <https://doi.org/10.2478/aoas-2014-0056>
- Horký, P., Jančíková, P., Sochor, J., Hynek, D., Chavis, G J., Ruttkay-Nedecký, B., Cernei, N., Zítka, O., Zeman, L.,

- Adam, V., Kizek, R. 2012. Effect of organic and inorganic form of selenium on antioxidant status of breeding boars ejaculate revealed by electrochemistry. *International Journal of Electrochemical Science*, vol. 7, no. 10, p. 9643-9657.
- Horky, P., Sochor, J., Skladanka, J., Klusonova, I., Nevrkla, P. 2016. Effect of Selenium, Vitamin E and C on Antioxidant Potential and Quality of Boar Ejaculate. *Journal of Animal and Feed Sciences*, vol. 25, no. 1, p. 29-36. <https://doi.org/10.22358/jafs/65584/2016>
- Hurwitz, S., Plavnik, I., Shapiro, A., Wax, E., Talpaz, H., Bar, A. 1995. Calcium metabolism and requirements of chickens are affected by growth. *Journal Nutrition*, vol. 125, no. 10, p. 2679-2686. [PMid:7562105](https://pubmed.ncbi.nlm.nih.gov/7562105/)
- Chakraborti, S., Chakraborti, T., Mandal, M., Mandal, A., Das, S., Ghosh, S. 2002. Protective role of magnesium in cardiovascular diseases: a review. *Molecular and Cellular Biochemistry*, vol. 238, no. 1, p. 163-79. <https://doi.org/10.1023/A:1019998702946> [PMid:12349904](https://pubmed.ncbi.nlm.nih.gov/12349904/)
- Liu, Y., Guo, Y., Wang, Z., Nie, W. 2007. Effects of source and level of magnesium on catalase activity and its gene expression in livers of broiler chickens. *Archives of Animal Nutrition*, vol. 61, no. 4, p. 292-300. <https://doi.org/10.1080/17450390701432019>
- Majewska, D., Szczerbińska, D., Ligocki, M., Buclaw, M., Sammel, A., Tarasewicz, Z., Romaniszyn, K., Majewski J. 2016. Comparison of the mineral and fatty acid profiles of ostrich, turkey and broiler chicken livers. *British Poultry Science*, vol. 57, no. 2, p. 193-200. <https://doi.org/10.1080/00071668.2016.1154136>
- Nevrkla, P., Čechová, M., Hadaš, Z. 2014. Use of repopulation for optimizing sow reproductive performance and piglet loss. *Acta Veterinaria Brno*, vol. 83, no. 4, p. 321-325. <https://doi.org/10.2754/avb201483040321>
- Nevrkla, P., Čechová, M., Wasilewski, P. D., Michalska, G., Nowachowicz, J. 2016. Carcass traits and meat quality of pigs fed on fodder supplemented with sunflower oil or conjugated linoleic acid. *Journal of Central European agriculture*, vol. 17, no. 3, p. 598-608. <https://doi.org/10.5513/JCEA01/17.3.1749>
- McDonald, P., Edwards, R. A., Greenhalgh, J. F. D., Morgan, C. A., Sinclair, L. A., Wilkinson, R. G. 2011. Minerals. In McDonald, P. et al. *Animal nutrition*. Wisconsin-Madison : Longman Scientific and Technical, p. 103-137, ISBN-9781408204238.
- Peters, J. C., Mahan, D. C. 2008. Effects of dietary organic and inorganic trace mineral levels on sow productive performance and daily mineral intakes over six parities. *Journal of Animal Science*, vol. 86, no. 9, p. 2247-2260. <https://doi.org/10.2527/jas.2007-0431>
- Ruttanavut, J., Yamauchi, K. 2010. Growth performance and histological alterations of intestinal villi in broilers fed dietary mixed minerals. *Asian Journal of Animal Sciences*, vol. 4, no. 3, p. 96-106. <https://doi.org/10.3923/ajas.2010.96.106>
- Rama Rao, S. V., Raju, M. V. L. N., Reddy, M. R., Pavani, P. 2006. Interaction between dietary calcium and non-phytate phosphorus levels on growth, bone mineralization and mineral excretion in commercial broilers. *Animal Feed Science and Technology*, vol. 131, no. 1, p. 135-150. <https://doi.org/10.1016/j.anifeedsci.2006.02.011>
- Sahin, K., Onderci, M., Sahin, N., Gulcu, F., Yildiz, N., Avci, M., Kucuk, O. 2006. Responses of quail to dietary vitamin E and zinc picolinate at different environmental temperatures. *Animal Feed Science Technology*, vol. 129, no. 1, p. 39-48. <https://doi.org/10.1016/j.anifeedsci.2005.11.009>
- Salmanzadeh, M., Ebrahimnezhad, Y., Shahryar, H. A., Beheshti, R. 2012. The effects of in ovo injection of glucose and magnesium in broiler breeder eggs on hatching traits, performance, carcass characteristics and blood parameters of broiler chickens. *Archiv für Geflügelkunde*, vol. 76, no. 4, p. 277-281.
- Shafey, T. M., McDonald, M. W., Pym, R. A. 1990. Effects of dietary calcium, available phosphorus and Vitamin D on growth rate, food utilization, plasma and bone constituents and calcium and phosphorus retention of commercial broiler strains. *British Poultry Science*, vol. 31, no. 3, p. 587-602. <https://doi.org/10.1080/00071669008417290> [PMid:2245353](https://pubmed.ncbi.nlm.nih.gov/2245353/)
- Singh, A., Walk, C. L., Ghosh, T. K., Bedford, M. R., Haldar, S. 2013. Effect of a novel microbial phytase on production performance and tibia mineral concentration in broiler chickens given low-calcium diets. *British Poultry Science*, vol. 54, no. 2, p. 206-15. <https://doi.org/10.1080/00071668.2013.775403>
- Song, Y., Ridker, P. M., Manson, J. E., Cook, N. R., Bruing, J. E., Liu, S. 2005. Magnesium intake, C-reactive protein, and the prevalence of metabolic syndrome in middle-aged and older U.S. women. *Diabetes Care*, vol. 28, no. 6, p. 1438-1444. <https://doi.org/10.2337/diacare.28.6.1438> [PMid:15920065](https://pubmed.ncbi.nlm.nih.gov/15920065/)
- Swiatkiewicz, S., Koreleski, J., Arczewska-Wloek, A. 2011. Effect of inulin and oligofructose on performance and bone characteristics of broiler chickens fed on diets with different concentrations of calcium and phosphorus. *British Poultry Science*, vol. 52, no. 4, p. 483-491. <https://doi.org/10.1080/00071668.2011.602665>
- Štenclová, H., Karásek, F., Šťastník, O., Zeman, L., Mrkvicová, E., Pavlata, L. 2016. The effect of reduced zinc levels on performance parameters of broiler chickens. *Potravinarstvo*, vol. 10, no. 1, p. 272-275. <https://doi.org/10.5219/580>
- Valko, M., Leibfritz, D., Moncol, J., Cronin, M. T., Mazur, M., Telser, J. 2007. Free radicals and antioxidants in normal physiological functions and human disease. *The International Journal of Biochemistry and Cell Biology*, vol. 39, no. 1, p. 44-84. <https://doi.org/10.1016/j.biocel.2006.07.001>
- Van der Hoeven-Hangoor, E., Van de Linde, I. B., Paton, N. D., Verstegen, M. W. A., Hendriks, W. H. 2013. Effect of different magnesium sources on digesta and excreta moisture content and production performance in broiler chickens. *Poultry Science*, vol. 92, no. 2, p. 382-391. <https://doi.org/10.3382/ps.2012-02404>
- Yang, Y., Gao, M., Nie, W., Yuan, J., Zhang, B., Wang, Z., Wu, Z. 2012. Dietary magnesium sulfate supplementation protects heat stress-induced oxidative damage by restoring the activities of antioxidative enzymes in broilers. *Biological Trace Element Research*, vol. 146, no. 1, p. 53-58. <https://doi.org/10.1007/s12011-011-9210-y>
- Zelenka J., Heger J., Zeman L. 2007. Recommended nutrient content in poultry diets and nutritive value of feeds for poultry (in Czech). Brno : MZLU. 77 p. ISBN 978-80-7375-091-6.

Acknowledgments:

The experiment was supported by the IP IGA MENDELU 24/2016.

Contact address:

Filip Karásek, Mendel University in Brno, Faculty of Agronomy, Department of Animal Nutrition and Forage

Production, Zemědělská 1, 61300 Brno, Czech Republic,
E-mail: filip.karasek@mendelu.cz

Hana Štenclová, Mendel University in Brno, Faculty of
Agronomy, Department of Animal Nutrition and Forage
Production, Zemědělská 1, 61300 Brno, Czech Republic,
E-mail: xstenclo@mendelu.cz

Ondřej Šťastník, Mendel University in Brno, Faculty of
Agronomy, Department of Animal Nutrition and Forage
Production, Zemědělská 1, 61300 Brno, Czech Republic,
E-mail: ondrej.stastnik@mendelu.cz

Eva Mrkvicová, Mendel University in Brno, Faculty of
Agronomy, Department of Animal Nutrition and Forage
Production, Zemědělská 1, 61300 Brno, Czech Republic,
E-mail: eva.mrkvicova@mendelu.cz

Leoš Pavlata, Mendel University in Brno, Faculty of
Agronomy, Department of Animal Nutrition and Forage
Production, Zemědělská 1, 61300 Brno, Czech Republic,
E-mail: leos.pavlata@mendelu.cz

Šárka Nedomová, Mendel University in Brno, Faculty of
Agronomy, Department of Food Technology, Zemedelska
1, 613 00 Brno, Czech Republic, E-mail:
sarka.nedomova@mendelu.cz

Ladislav Zeman, Mendel University in Brno, Faculty of
Agronomy, Department of Animal Nutrition and Forage
Production, Zemědělská 1, 61300 Brno, Czech Republic,
E-mail: ladislav.zeman@mendelu.cz



GENETIC VARIATION OF EUROPEAN MAIZE GENOTYPES (*ZEA MAYS* L.) DETECTED USING SSR MARKERS

Martin Vivodík, Zdenka Gálová, Želmíra Balážová, Lenka Petrovičová

ABSTRACT

The SSR molecular markers were used to assess genetic diversity in 40 old European maize genotypes. Ten SSR primers revealed a total of 65 alleles ranging from 4 (UMC1060) to 8 (UMC2002 and UMC1155) alleles per locus with a mean value of 6.50 alleles per locus. The PIC values ranged from 0.713 (UMC1060) to 0.842 (UMC2002) with an average value of 0.810 and the DI value ranged from 0.734 (UMC1060) to 0.848 (UMC2002) with an average value of 0.819. 100% of used SSR markers had PIC and DI values higher than 0.7 that means high polymorphism of chosen markers used for analysis. Probability of identity (PI) was low ranged from 0.004 (UMC1072) to 0.022 (UMC1060) with an average of 0.008. A dendrogram was constructed from a genetic distance matrix based on profiles of the 10 maize SSR loci using the unweighted pair-group method with the arithmetic average (UPGMA). According to analysis, the collection of 40 diverse accessions of maize was clustered into four clusters. The first cluster contained nine genotypes of maize, while the second cluster contained the four genotypes of maize. The third cluster contained 5 maize genotypes. Cluster 4 contained five genotypes from Hungary (22.73%), two genotypes from Poland (9.10%), seven genotypes of maize from Union of Soviet Socialist Republics (31.81%), six genotypes from Czechoslovakia (27.27%), one genotype from Slovak Republic (4.55%) and one genotype of maize is from Yugoslavia (4.55%). We could not distinguish 4 maize genotypes grouped in cluster 4, (Voroneskaja and Kocovska Skora) and 2 Hungarian maize genotypes - Feheres Sarga Filleres and Mindszentpusztai Feher, which are genetically the closest.

Keywords: old maize; dendrogram; SSR markers; genetic diversity; PIC

INTRODUCTION

With the advent of the first maize hybrids, in 1933 in the US and around 1950 in Europe, maize cultivation has undergone a complete change. Numerous open-pollinated landraces adapted to specific regions were substituted by a limited number of hybrids bred from a large genetic basis (Gay, 1984). Today, the main maize hybrids cultivated in the world involve a restricted number of key inbred lines. Therefore, genetic diversity of those cultivars is almost certainly limited, in comparison to the large genetic diversity available in genebanks (Gay, 1984). A few years ago, the threat of genetic erosion led to a significant interest in the assessment of genetic diversity in germplasm collections and a huge number of studies on various crops (Dubreuil and Charcosset, 1998).

Molecular markers based on polymerase chain reaction (PCR) methods, such as simple sequence repeats (SSRs) or microsatellites, have become important genetic markers in a wide range of crop species, including maize (Elçi and Hancı, 2015). SSRs markers have many advantages over other types of molecular markers, such as co-dominance, abundant in genomes, highly polymorphisms, locus

specificity, good reproducibility and random distribution throughout the genome (Sun et al., 2011). These features, coupled with their ease of detection, make them ideal for identifying and distinguishing between accessions that are genetically very similar (Saker et al., 2005).

For the analysis of genetic diversity of maize genotypes were used several dominant molecular markers: amplified fragment length polymorphism (AFLP) (Roy and Kim, 2016), random amplified polymorphic DNA (RAPD) (Balážová et al., 2016), start codon targeted (SCoT) (Vivodík et al., 2016), inter-simple sequence repeat (ISSR) (Idris et al., 2012; Žiarovská et al., 2013) and sequence-related amplified polymorphism (SRAP) (Abd El-Azeem et al., 2015). And codominant molecular markers were also used for the analysis of maize genotypes: simple sequence repeat (SSR) (Shiri et al., 2014), expressed sequence tag (EST)-SSR (Galvão et al., 2015), single nucleotide polymorphism (SNP) (Sa et al., 2012) and using protein markers (SDS-PAGE) (Vivodík et al., 2016). Suitability of SSR markers for the construction of genetic maps, fingerprinting and phylogenetic studies has been proved by many authors in many crops, such as

castor (Gálová et al., 2015), rye (Balážová et al., 2015), wheat (Han et al., 2015), barley (Maniruzzaman et al., 2014), triticale (Vyhnánek et al., 2009), maize (Salami et al., 2016), hemp (Vyhnánek et al., 2015) and many other crops.

The present study aimed to examine the genetic variability within and among old maize genotypes cultivated in the Europe, using SSR markers. The data collected will contribute to identification, rational exploitation and conservation of germplasms of maize genotypes.

MATERIAL AND METHODOLOGY

Maize genotypes (40) were obtained from the Gene Bank VURV Praha-Ruzine (Czech Republic) and from the Gene Bank in Piest'any, the Slovak Republic (Table 1). DNA of 40 genotypes of maize was extracted from leaves of 10 day old seedlings using the Gene JET Plant Genomic DNA Purification Mini Kit.

SSR analysis: Amplification of SSR fragments was

performed according to (Elçi and Hançer, 2015) (Table 2). Polymerase chain reaction (PCR) were performed in 20 µL of a mixture containing 7.5 µL H₂O, 10.0 µL Master Mix (Genex, Bangalore, India), 0.75 µL of each primer (10 pmol) and 1 µL DNA (100 ng). Amplification was performed in a programmed thermocycler (Biometra, Germany) and amplification program consisted of an initial denaturing step at 94 °C for 2 min, followed by 35 cycles of amplification [95 °C (30 s), 1 min at the 55 °C, 72 °C (30 s)] and a final elongation step at 72 °C for 10 min. Amplification products were confirmed by electrophoresis in 7% denaturing polyacrylamide gels and silver stained and documented using gel documentation system Grab-It 1D for Windows.

Data analysis: For the assessment of the polymorphism between castor genotypes and usability of SSR markers in their differentiation diversity index (DI) (Weir, 1990), the probability of identity (PI) (Paetkau et al., 1995) and polymorphic information content (PIC) (Weber, 1990) were used.

Table 1 List of 40 analyzed genotypes of maize.

Genotypes	Country of origin	Year of registration
1. Feheres Sarga Filleres	Hungary	1965
2. Mindszentpusztai Feher	Hungary	1964
3. Zakarpatskaja	Union of Soviet Socialist Republics	1964
4. Przebedowska Burskynowa	Poland	1964
5. Krasnodarskaja	Union of Soviet Socialist Republics	1964
6. Mesterhazy Sarga Simaszemu	Hungary	1964
7. Slovenska biela perlova	Czechoslovakia	1964
8. Zuta Brzica	Yugoslavia	1975
9. Zloty Zar	Poland	1964
10. Slovenska Florentinka	Czechoslovakia	1964
11. Juhoslavka	Yugoslavia	1964
12. Kostycevska	Union of Soviet Socialist Republics	1964
13. Mindszentpusztai Sarga Lofogu	Hungary	1964
14. Stodnova	Czechoslovakia	1964
15. Slovenska žltá	Slovak Republic	1964
16. Slovenska krajová veľkozrná	Slovak Republic	1964
17. Partizanka	Union of Soviet Socialist Republics	1964
18. Voroneskaja	Union of Soviet Socialist Republics	1964
19. Kocovska Skora	Slovak Republic	1964
20. Milada	Czechoslovakia	1964
21. Moldavskaja	Union of Soviet Socialist Republics	1964
22. Bučiansky Kónský Zub	Slovak Republic	1964
23. Hodoninský kónský zub žltý	Czechoslovakia	1964
24. M Silokukurica	Hungary	1964
25. Valticka	Czechoslovakia	1964
26. Przebedowska Biala	Poland	1964
27. Toschevska	Slovak Republic	1964
28. Šamorinsky kónský zub	Hungary	1964
29. Wielkopolanka	Poland	1964
30. Czechnicka	Poland	1964
31. Manalta	Czechoslovakia	1964
32. Zlota gorecka	Poland	1964
33. Celchovicka ADQ	Czechoslovakia	1964
34. Belaja mestnaja	Union of Soviet Socialist Republics	1964
35. Bučanská žltá	Slovak Republic	1964
36. Iregszemeseil 2 hetes	Hungary	1964
37. Dnepropetrovskaja	Union of Soviet Socialist Republics	1964
38. Bezuncuvska	Union of Soviet Socialist Republics	1964
39. Mikulická	Czechoslovakia	1964
40. Aranyozon sarga lofogu	Hungary	1964

Table 2 List of SSR primers of maize (Elçi and Hançer, 2015).

SSR markers	F primer	R primer
UMC1363	AAAGGCATTATGCTCACGTTGATT	TCTCCCTCCCCTGTACATGAATTA
UMC1004	CTGGGCATACAAAGCTCACA	TGCATAAACCGTTTCCACAA
UMC2002	TGACCTCAACTCAGAATGCTGTTG	CACAAAATCCTCGAGTTCTTGATTG
UMC1117	AATTCTAGTCCTGGGTCGGAACCTC	CGTGGCCGTGGAGTCTACTACT
UMC1587	ATGCGTCTTTCACAAAGCATTACA	AGGTGCAGTTCATAGACTTCCTGG
UMC1060	ACAGGATTTGAGCTTCTGGACATT	GGCCTCTCCTTCATCCTATTCAA
UMC1155	TCTTTTATTGTGCCCGTTGAGATT	CCTGAGGGTGATTTGTCTGTCTCT
UMC1072	GAGGAGACCGCCTCTGGTTC	CTTCGGGTTCTGGACCTTCT
UMC1133	ATTTCGATCTAGGGTTTGGGTTTCAG	GATGCAGTAGCATGCTGGATGTAG
UMC1413	CATACACCAAGAGTGCAGCAAGAG	GGAGGTCTGGAATTCTCCTCTGTT

Table 3 List of SSR primers, total number of bands and the statistical characteristics of the SSR markers used in maize.

Marker name	Number of alleles	DI	PIC	PI
UMC1363	7	0.808	0.799	0.011
UMC1004	6	0.830	0.823	0.005
UMC2002	8	0.848	0.842	0.005
UMC1117	5	0.794	0.780	0.010
UMC1587	7	0.835	0.827	0.006
UMC1060	4	0.734	0.713	0.022
UMC1155	8	0.835	0.830	0.007
UMC1072	7	0.845	0.839	0.004
UMC1133	6	0.818	0.808	0.007
UMC1413	7	0.846	0.841	0.005
Average	6.50	0.819	0.810	0.008

Note: DI- diversity index, PIC- polymorphic information content, PI- probability of identity.

RESULTS AND DISCUSSION

Ten maize SSR primers were used for identification and estimation of the genetic relations among 40 old European maize genotypes. All 10 SSR primers generated clear banding patterns with high polymorphism (Figure 1). Ten SSR primers revealed a total of 65 alleles ranging from 4 (UMC1060) to 8 (UMC2002 and UMC1155) alleles per locus with a mean value of 6.50 alleles per locus (Table 3). Variations in DNA sequences lead to polymorphism. Greater polymorphism is indicative of greater genetic diversity. The PIC values ranged from 0.713 (UMC1060) to 0.842 (UMC2002) with an average value of 0.810 and the DI value ranged from 0.734 (UMC1060) to 0.848 (UMC2002) with an average value of 0.819 (Table 3). 100% of used SSR markers had PIC and DI values higher than 0.7 that means high polymorphism of chosen markers used for analysis. Probability of identity (PI) was low ranged from 0.004 (UMC1072) to 0.022 (UMC1060) with an average of 0.008 (Table 3).

A dendrogram was constructed from a genetic distance matrix based on profiles of the 10 maize SSR loci using the unweighted pair-group method with the arithmetic average (UPGMA). According to analysis, the collection of 40 diverse accessions of maize was clustered into four clusters (Figure 2). The first cluster contained nine genotypes of maize, while the second cluster contained the four genotypes (Šamorinsky kónský zub, Wielkopolanka, Manalta and Toschevska) of maize. The third cluster

contained 5 maize genotypes (Moldavskaja, Bučiansky Kónský Zub, Milada, Bučanská žltá and Iregszemeseil 2 hetes) (Figure 2). Cluster 4 contained five genotypes from Hungary (22.73%), two genotypes from Poland (9.10%), seven genotypes of maize from Union of Soviet Socialist Republics (31.81%), six genotypes from Czechoslovakia (27.27%), one genotype from Slovak Republic (4.55%) and one genotype of maize is from Yugoslavia (4.55%) (Figure 2). We could not distinguish 4 maize genotypes grouped in cluster 4, (Voroneskaja and Kocovska Skora) and 2 Hungarian maize genotypes – Feheres Sarga Filleres and Mindszentpusztai Feher, which are genetically the closest.

Similar results were detected by other authors (Krishna et al., 2012; Kanagarasu et al., 2013; Molin et al., 2013; Qu and Liu, 2013; Al-Badeiry et al., 2014; Shiri, et al., 2014; Efendi et al., 2015; Ignjatovic-Micic et al., 2015; Salami et al., 2016) and these results presented a high level of polymorphism of old maize genotypes detected by SSR markers. In the present investigation (Krishna et al., 2012), 48 microsatellite markers were used for analyzing genetic diversity among the sixty three quality protein maize lines. Polymorphic profiles for 37 simple sequence repeat (SSR) loci aided in differentiating the QPM inbred lines. Using SSR procedures, the number of alleles per locus ranged from two to six, giving a total of 151 alleles for the 37 SSR loci.

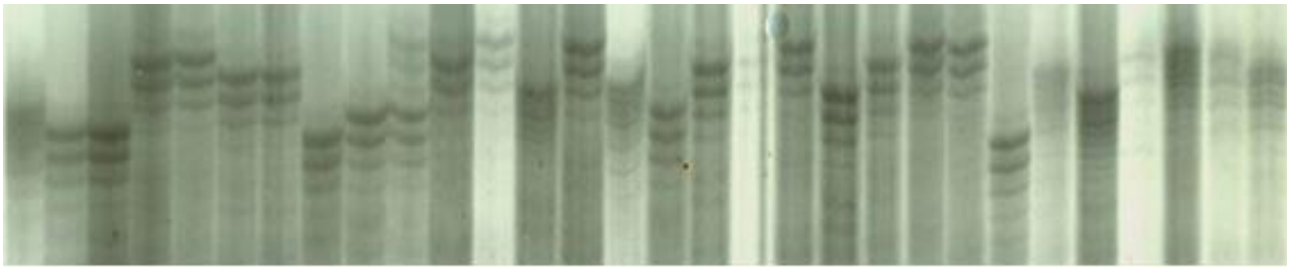

1 2 3 4 5 6 7 8 9 10 11 12 13 14 15 16 17 18 19 20 21 22 23 24 25 26 27 28 29 30
Figure 1 PCR amplification products of 30 genotypes of maize produced with SSR marker UMC1060. Lanes 1- 30 are maize genotypes (Table 1).

Genotypes

Voroneskaja	SUN	-+	-----+						
Kocovska Skora	SK	-+		-----+					
Partizanka	SUN	----	-----+						
Feheres S. Fi.	HUN	-+	-----+						+-+
Mindszen.Feher	HUN	-+		-----+					
Zakarpatskaja	SUN	----	-----+					+-----+	
Zlota gorecka	POL	----	-----+						
CelchovickaADQ	CZE	----	-----+					+-----+	
Bela. mestnaja	SUN	----	-----+						
S. Florentinka	CZE	----	-----+						++4
Juhoslavska	YUG	----	-----+					+-----+	
Kostycevskaja	SUN	----	-----+						
Minds. S. Lof.	HUN	----	-----+					+-----+	
Stodnova	CZE	----	-----+					+-----+	
Mikulická	CZE	----	-----+					+-----+	
Aranyo. s. lo.	HUN	----	-----+						
Bezuncuvska	SUN	----	-----+						
M Silokukurica	HUN	----	-----+					+-----+	
Valticka	CZE	----	-----+					+-----+	
Zloty Zar	POL	----	-----+					+-----+	++
Dnepropetrov.	SUN	----	-----+					+-----+	++
Hodo. K. z. žl.	CZE	----	-----+						
Moldavskaja	SUN	----	-----+						
Bučiansky K. Z.	SK	----	-----+					+-----+	
Milada	CZE	----	-----+					+-----+	+3
Bučanská žltá	SK	----	-----+						
Iregs. 2 hetes	HUN	----	-----+						
Šam. Kons. Zub	HUN	----	-----+						
Wielkopolanka	POL	----	-----+					+-----+	
Manalta	CZE	----	-----+					+-----+	+2
Toschevska	SK	----	-----+						
Slovenska žltá	SK	----	-----+					+-----+	
Przebed. Biala	POL	----	-----+					+-----+	
Slov. kr. velk.	SK	----	-----+						
Slov. b. perlo.	SK	----	-----+					+-----+	++1
Zuta Brzica	YUG	----	-----+					+-----+	
Krasnodarskaja	SUN	----	-----+					+-----+	
Mes. S. Simasz.	HUN	----	-----+					+-----+	+-+
Prz. Burskynow.	POL	----	-----+						
Czechnicka	POL	----	-----+						

Figure 2 Dendrogram of 40 maize genotypes prepared based on SSR markers.

Kanagarasu et al. (2013) used 10 SSR molecular markers to analysis of 27 maize inbred lines. Ten SSR markers produced 23 polymorphic alleles with an average of 2.3 alleles per locus and mean polymorphic information content (PIC) of 0.45. The dendrogram generated with hierarchical unweighted pair group method with arithmetic mean (UPGMA) cluster analysis revealed five major clusters at 0.62 similarity coefficient.

The aim of **Molin et al. (2013)** was study the genetic diversity across 48 varieties of maize landraces cultivated at different locations in the States of Rio Grande do Sul and Paraná by 47 simple sequence repeat (SSR) markers. SSR analysis resulted in amplification of 105 polymorphic fragments and a polymorphic index of 78.3%. **Qu and Liu (2013)** selected SSRs with unique flanking sequences and then applied to analyze the polymorphism of next-generation sequencing data from 345 maize inbred. There were 58,946 SSRs with length information results in ten or more than ten genomes, accounting for 71.28% of SSRs with unique flanking sequences, while 55,621 SSRs had polymorphism, with an average PIC value of 0.498. **Al-Badeiry et al. (2014)** detected 41 alleles among the tested maize varieties using 10 Simple Sequence Repeat (SSR). The molecular size of bands obtained from amplification of SSR products ranged from 91 to 288 bp. Alleles ranged from one in umc1653 to ten in bnlg1189 loci. The polymorphic information content (PIC) values for the SSR loci ranged from 0.17 to 0.85, with an average of 0.44. The highest PIC values were observed in primers bnlg1017 (0.85) and umc1038 (0.79) and the lowest PIC values was observed in primer umc1946 (0.17). **Shiri, et al. (2014)** study genetic diversity of 38 maize hybrids using 12 SSR primers. The total number of PCR-amplified products was 40 bands, all of them polymorphic. Primer Phi031 generated the highest number of bands (6). Among the studied primers, UMC2359, PHI031 and UMC1862 showed the maximum polymorphism information content (PIC) and the greatest diversity. Maize hybrids were divided into three main groups based on SSR markers. The aim of **Efendi et al. (2015)** was to select homozygosity and analyze genetic diversity of 51 maize inbreds using 36 SSRs markers. The research was aimed to select among 51 maize inbreds with high homozygosity and to investigate the genetic diversity using 36 SSRs markers. The result shows that there were 30 inbreds indicating homozygosity level of more than 80%. The diversity of those inbreds was moderately high, with genetic similarity of between 0.22 and 0.87 distributed within six heterotic groups. The farthest genetic distance of 0.87 was detected on inbred pair 1044-3 vs Nei9008. **Ignjatovic-Micic et al. (2015)** analyzed nine flint and nine dent accessions from six agro-ecological groups, chosen on the basis of diverse pedigrees. Ten SSR primers revealed a total of 63 alleles. High average PIC value (0.822) also supports informativeness and utility of the markers used in this study. The aim of study **Salami et al. (2016)** was to evaluate the genetic diversity of Benin's maize accessions by SSR marker. Thus, 187 maize accessions from three areas were analyzed using three SSR markers. A total of 227 polymorphic bands were produced and showed high genetic diversity. The polymorphic information content (PIC) values for the SSR loci ranged from 0.58 to 0.81, with an average of 0.71.

CONCLUSION

In conclusion, a high level of genetic diversity exists among the old maize accessions analyzed. According to analysis, the collection of 40 diverse accessions of maize was clustered into four clusters. The first cluster contained nine genotypes of maize, while the second cluster contained the four genotypes (Šamorinsky kónský zub, Wielkopolanka, Manalta and Toschevska) of maize. The third cluster contained 5 maize genotypes (Moldavskaja, Bučiansky Kónský Zub, Milada, Bučanská žltá and Iregszemeseil 2 hetes). Cluster 4 contained 22 genotypes of maize. We could not distinguish 4 maize genotypes grouped in cluster 4, (Voroneskaja and Kocovska Skora) and 2 Hungarian maize genotypes - Feheres Sarga Filleres and Mindszentpusztai Feher, which are genetically the closest. A SSR marker system is a rapid and reliable method for cultivar identification that might also be used in quality control in certified seed production programs, to identify sources of seed contamination, and to maintain pure germplasm collections.

REFERENCES

- Abd El-Azeem, R. M., Hashem, M. H. Abd-El-Haleem, S. H. M. 2015. Detection of genetic variability in *Zea mays* inbred lines using SSRs and SRAP markers. *Egyptian Journal of Genetics and Cytology*, vol. 44, no. 2, p. 291-307.
- Al-Badeiry, N. A. H., Al-Saadi, A. H., Merza, T. K. 2014. Analysis of Genetic Diversity in Maize (*Zea mays* L.) Varieties Using Simple Sequence Repeat (SSR) Markers. *Journal of Babylon University*. vol. 22, no. 6, p. 1768-1774.
- Balážová, Ž., Petrovičová, L., Gálová, Z., Vivodík, M. 2015. Molecular characterization of rye cultivars. *Potravinarstvo*, vol. 9, no. 1, p. 54-58. <http://dx.doi.org/10.5219/522>
- Balážová, Ž., Vivodík, M., Gálová, Z. 2016. Evaluation of molecular diversity of central European maize cultivars. *Emirates Journal of Food and Agriculture*. vol. 28, no. 2, p. 93-98. <http://dx.doi.org/10.9755/ejfa.2015-05-204>
- Dubreuil, P. and Charcosset, A. 1998. Genetic diversity within and among maize populations: a comparison between isozyme and nuclear RFLP loci. *Theoretical and Applied Genetic*, vol. 96, no. 5, p. 577-587. <https://doi.org/10.1007/s001220050776>
- Efendi, R., Sunarti, S., Musa, Y., Farid Bdr, M., Danial Rahim, M., Azrai, M. 2015. Selection of Homozygosity and Genetic Diversity of Maize Inbred using Simple Sequence Repeats (SSRs) Marker. *International Journal of Current Research in Biosciences and Plant Biology*, vol. 2, no. 3, p. 19-28.
- Elçi, E., Hançer, T. 2015. Genetic Analysis of Maize (*Zea mays* L.) Hybrids Using Microsatellite Markers. *Tarim Bilimleri Dergisi – Journal of Agricultural Sciences*, vol. 21, no. 2, p. 192-198.
- Galvão, K. S., Ramos, H. C., Santos, P. H., Entringer, G. C., Vettorazzi, J. C., Pereira, M. G. 2015. Functional molecular markers (EST-SSR) in the full-sib reciprocal recurrent selection program of maize (*Zea mays* L.). *Genetics and Molecular Research*, vol. 14, no. 3, p. 7344-7355. <http://dx.doi.org/10.4238/2015.july.3.10>
- Gay J. P. 1984. Fabuleux maïs – Histoire et avenir d'une plante. *AGPM, Pau*, p. 295.
- Gálová, Z., Vivodík, M., Balážová, Ž., Kuřka Hložáková, T. 2015. Identification and differentiation of *Ricinus communis* L. using SSR markers. *Potravinarstvo*, vol. 9, no. 1, p. 556-561. <http://dx.doi.org/10.5219/516>

- Han, B., Wang, C., Tang, Z., Ren, Y., Li, Y., Zhang, D., Dong, Y., Zhao, X. 2015. Genome-Wide Analysis of Microsatellite Markers Based on Sequenced Database in Chinese Spring Wheat (*Triticum aestivum* L.). *PLoS ONE*, vol. 10, no. 11, e0141540. <http://dx.doi.org/10.1371/journal.pone.0141540>
- Idris, A. E., Hamza, N. B., Yagoub, S. O., Ibrahim, A. I. A., El-Amin, H. K. A. 2012. Maize (*Zea mays* L.) Genotypes Diversity Study by Utilization of Inter-Simple Sequence Repeat (ISSR) Markers. *Australian Journal of Basic and Applied Sciences*, vol. 6, no. 10, p. 42-47.
- Ignjatovic-Micic D., Ristic, D., Babic, V., Andjelkovic, V., Vancetovic, J. 2015. A simple SSR analysis for genetic diversity estimation of maize landraces. *Genetika*, vol 47, no. 1, p. 53-62. <https://doi.org/10.2298/GENSR1602801E>
- Kanagarasu, S., Nallathambi, G., Ganesan, K. N., Kannan, S., Shobhana, V. G., Senthil, N. 2013. Determination of genetic polymorphism among indigenous and exotic maize inbreds using microsatellite markers. *African Journal of Biotechnology*, vol. 12, no. 39, p. 5723-5728.
- Krishna, M. S. R., Reddy, S. S., Chinna Babu Naik, V. 2012. Assessment of genetic diversity in quality protein maize (QPM) lines using simple sequence repeat (SSR) markers. *African Journal of Biotechnology*, vol. 11, no. 98, p. 16427-16433.
- Maniruzzaman, A., Talukder, Z. A., Rohman, S., Begum, F., Amiruzzaman, M. 2014. Polymorphism study in barley (*Hordeum vulgare*) genotypes using microsatellite (SSR) markers. *Bangladesh Journal of Agricultural Research*, vol. 39, no. 1, p. 33-45.
- Molin, D., Coelho, C. J., Máximo, D. S., Ferreira, F. S., Gardingo, J. R., Matiello, R. R. 2013. Genetic diversity in the germplasm of tropical maize landraces determined using molecular markers. *Genetics and Molecular Research*. vol. 12, no. 1, p. 99-114. <http://dx.doi.org/10.4238/2013.January.22.8>
- Paetkau, D., Calvert, W., Stirling, I., Strobeck, C. 1995. Microsatellite analysis of population structure in Canadian polar bears. *Molecular Ecology*, vol. 4, no. 3, p. 347-354. <https://doi.org/10.1111/j.1365-294X.1995.tb00227.x> PMID:7663752
- Roy, N. S., Kim, N. S. 2016. Genetic diversity analysis of maize lines using AFLP and TE-based molecular marker systems. *Genes and Genomics*, vol. 38, no. 10, p. 1005-1010. <http://dx.doi.org/10.1007/s13258-016-0461-z>
- Sa, K. J., Park, J. Y., Park, K. C. Lee, J. K. 2012. Analysis of genetic mapping in a waxy/dent maize RIL population using SSR and SNP markers. *Genes and Genomics*, vol. 34, no. 2, p. 157-164. <http://dx.doi.org/10.1007/s13258-011-0208-9>
- Saker, M., Naghtigall, M., Kuehne, T. A. 2005. Comparative assessment of DNA fingerprinting by RAPD, SSR and AFLP in genetic analysis of some barley genotypes. *Egyptian Journal of Genetics and Cytology*, vol. 34, p. 81-97.
- Salami, H. A., Sika, K. C., Padonou, W., Aly, D., Yallou, C., Adjanohoun, A., Kotchoni, S., Baba-Moussa, L. 2016. Genetic Diversity of Maize Accessions (*Zea mays* L.) Cultivated from Benin Using Microsatellites Markers. *American Journal of Molecular Biology*, vol. 6, no. 1, p. 12-24. <http://dx.doi.org/10.4236/ajmb.2016.61002>
- Shiri, M. R., Choukan, R., Aliyev, R. T. 2014. Study of genetic diversity among maize hybrids using SSR markers and morphological traits under two different irrigation conditions. *Crop Breeding Journal*, vol. 4, no. 1, p. 65-72.
- Sun, D. F., Ren, W. B., Sun, G., Peng, J. H. 2011. Molecular diversity and association mapping of quantitative traits in Tibetan wild and worldwide originated barley. *Euphytica*, vol. 178, no. 1, p. 31-43. <http://dx.doi.org/10.1007/s10681-010-0260-6>
- Qu, J., Liu, J. 2013. A genome-wide analysis of simple sequence repeats in maize and the development of polymorphism markers from next-generation sequence data. *BMC Research Notes*, vol. 6, p. 403-410. <http://dx.doi.org/10.1186/1756-0500-6-403>
- Vivodík, M., Gálová, Z., Balážová, Ž., Petrovičová, L. 2016. Start codon targeted (SCoT) polymorphism reveals genetic diversity in European old maize (*Zea mays* L.) genotypes. *Potravinárstvo*, vol. 10, no. 1, p. 563-569. <http://dx.doi.org/10.5219/660>
- Vivodík, M., Gálová, Z., Balážová, Ž., Petrovičová, L., Kuřka-Hložáková, T. 2016. Genetic variation and relationships of old maize genotypes (*Zea mays* L.) detected using SDS-PAGE. *Potravinárstvo*, vol. 10, no. 1, p. 532-536. <http://dx.doi.org/10.5219/661>
- Vyhnánek, T., Nevrtalová, E., Slezáková, K. 2009. Detection of the Genetic Variability of Triticale Using Wheat and Rye SSR Markers. *Cereal Research Communications*. vol. 37, no. 1, p. 23-29. <https://doi.org/10.1556/CRC.37.2009.1.3>
- Vyhnánek, T., Trojan, V., Štiásna, K., Presinszká, M., Hřivná, L., Mrkvicová, E., Havel, L. 2015. Testing of DNA isolation for the identification of Hemp. *Potravinárstvo*, vol. 9, no. 1, p. 393-397. <http://dx.doi.org/10.5219/509>
- Weber, J. L. 1990. Informativeveness of human (dC-dA)n x (dG-dT)n polymorphism. *Genomics*, vol. 7, no. 4, p. 524-530. [https://doi.org/10.1016/0888-7543\(90\)90195-Z](https://doi.org/10.1016/0888-7543(90)90195-Z)
- Weir, B. S. 1990. *Genetic data analysis. Methods for discrete population genetic data.* 2nd ed. Michigan : Sinauer Associates. 445 p. ISBN 9780878939022.
- Žiarovská, J., Senková, S., Bežo, M., Ražná, K., Masnica, M., Labajová, M. 2013. ISSR markers as a tool to distinguish Idt and SSS populations of *Zea mays* L. *Journal of Central European Agriculture*, vol. 14, no. 2, p. 489-499. <http://dx.doi.org/10.5513/jcea01/14.2.1227>

Acknowledgments:

This work was funded by European Community under project ITMS 26220220180: Building Research Centre "AgroBioTech" (50%) and KEGA project No 021SPU-4/2015 (50%).

Contact address:

Martin Vivodík, Slovak University of Agriculture, Faculty of Biotechnology and Food Sciences, Department of Biochemistry and Biotechnology, Tr. A. Hlinku 2, 949 76 Nitra, Slovakia, E-mail: martin.vivodik@uniag.sk.

Zdenka Gálová, Slovak University of Agriculture, Faculty of Biotechnology and Food Sciences, Department of Biochemistry and Biotechnology, Tr. A. Hlinku 2, 949 76 Nitra, Slovakia, E-mail: zdenka.galova@uniag.sk.

Želmíra Balážová, Slovak University of Agriculture, Faculty of Biotechnology and Food Sciences, Department of Biochemistry and Biotechnology, Tr. A. Hlinku 2, 949 76 Nitra, Slovakia, E-mail: zelmira.balazova@uniag.sk.

Lenka Petrovičová, Slovak University of Agriculture, Faculty of Biotechnology and Food Sciences, Department of Biochemistry and Biotechnology, Tr. A. Hlinku 2, 949 76 Nitra, Slovakia, E-mail: lenka.petrovicova@uniag.sk.

THE STUDY OF ANTIOXIDANTS IN GRAPEVINE SEEDS

Lenka Tomášková, Jiří Sochor, Mojmír Baroň

ABSTRACT

Grapevine seeds contain a large amount of antioxidant components, and are therefore recommended in the prevention and treatment of many diseases. For this research, we studied the antioxidant properties of grapevine seeds from the Marlen variety, as evidence suggests that these types have higher resistance against fungal diseases. Through high-performance liquid chromatography with UV/VIS detection, a total of 10 antioxidant components were selected for further investigation, specifically: catechin, epicatechin, rutin, quercitrin, quercetin, caftaric acid, caffeic acid, p-coumaric acid, ferulic acid, and gallic acid. The antioxidant activity was determined spectrophotometrically through the adoption of three fundamentally different methods (the DPPH assay, the ABTS method, and the FRAP method). Using the Folin-Ciocalteu method, it was possible to determine the content of all the polyphenolic compounds. The results of the assessment antioxidant activity and the content of polyphenolic compounds were recalculated to gallic acid equivalents (GAE). The values of the antioxidant activity as determined by the DPPH test were 6643 (± 154) mg of GAE; 1984 (± 88) mg of GAE when using the FRAP method; and 812 (± 31) mg of GAE when the ABTS method was utilised. The content of the total polyphenolic compounds came to 6982 (± 221) mg of GAE. The most abundant antioxidant was catechin, with a content of 115 mg.L⁻¹, whilst the least represented compound was ferulic acid (0.139 mg.L⁻¹). Overall, this study showed a high antioxidant potential of grapevine seeds.

Keywords: grapevine seeds; antioxidants; HPLC-UV/VIS

INTRODUCTION

Antioxidants are potent scavengers of free radicals and serve as inhibitors of neoplastic processes (Bagchi et al., 2000). *Vitis vinifera*, L. is one of the world's largest fruit crops, with approximately 38 million tonnes of grapes produced every year in Europe (Vrsic et al., 2011). Grape seeds are rich sources of polyphenolic compounds, which are characterised by a variety of properties, such as antibacterial and antioxidant activities (Berradre et al., 2013). Results of many studies indicate that grapevine seeds are a source of biologically active substances usable for pharmaceutical and other purposes (Ali et al., 2010). Various research has indicated that the phenolics in grapes can be used to prevent atherosclerosis (Pekić et al., 1998). Recognition of the health benefits of catechins and procyanidins has led to the use of grape seed extract as a dietary supplement (Fuleki & Ricardo da Silva, 1997). In addition, the naturally occurring antioxidant of oligomeric proanthocyanidins has been reported to possess a broad spectrum of therapeutic benefits (Bagchi et al., 2000). Furthermore, phenolics are largely responsible for a dietary anomaly known as the French paradox (Catalgol et al., 2012). The antioxidant activity in grapevine seeds has been studied across a number of popular and hybrid varieties; however, further studies should start focusing

more on interspecific varieties, such as Marlen, to determine their antioxidant activity and phenolic content (Yilmaz et al., 2015).

The aim of this study is to determine the antioxidant activity, the content of polyphenolic compounds, and the content of concrete antioxidants in cultivar Marlen (*Vitis vinifera*, L.) Grapevine seeds contain great amounts of biologically active components (Pascoa et al., 2015). This fact has been proven by many scientific studies dealing with the antioxidant potential of this waste material. It has also been suggested on numerous occasions that using grapevine seeds and derived products can protect humans against many diseases. Grape seed extract, in particular, has been reported to possess a broad spectrum of pharmacological and therapeutic effects, such as antioxidative, anti-inflammatory, and antimicrobial activities, as well as cardioprotective, hepatoprotective, and neuroprotective benefits (Nassiri-Asl and Hosseinzadeh, 2009). Due to the influence of synergism, natural extracts from these seeds are more efficient than isolated material obtained from other identical substances.

Our work focuses on the study of antioxidant activity and polyphenolic compounds in grapevine seeds, with the main target being to determine 10 antioxidant components through high performance liquid chromatography.

MATERIAL AND METHODOLOGY

Biological samples

This experimental study was performed with grapevine seeds (*Vitis vinifera* L.) of the interspecific cultivar Marlen. The experimental material originated from the Department of Viticulture and Enology, Faculty of Horticulture, of Mendel University in Brno.

Chemicals

The chemicals used in this study were supplied by the firm Sigma Aldrich (Germany). Antioxidant standards were products of the company Extrasynthese (France).

Chemicals: Deionised water, stable free radical DPPH[•], cation radical ABTS^{•+}, methanol, acetic acid (0.2%), liquid nitrogen, TPTZ (2,4,6-tripyridyl-s-triazin), hydrochloric acid, FeCl₃, acetate buffer, sodium acetate, Folin-Ciocalteu reagent, sodium carbonate decahydrate (NaCO₃·10 H₂O standard antioxidants: catechin, epicatechin, cis-resveratrol, rutin, quercitrin, quercetin, tyrosol, vanillic acid, syringic acid, caftaric acid, caffeic acid, p-coumaric acid, ferulic acid, and gallic acid.

Method of sample preparation

The experimental material originated from grape pomace. Seeds were cleaned, and dried for 24 hours (55 °C). The seeds were then crushed using a laboratory mill (MF 10 basic, IKA, Germany). The mixture was extracted with ethanol (75%), 1:10 (seeds: EtOH). The extraction was performed under dark conditions for 72 hours and at 15 °C using the shaker (IKA KS 260 Basic, Germany). The samples were subsequently centrifuged (CompactStar CS4, Company Manek, Czech Republic) and transferred into

vials, ready for spectrometric and chromatographic analysis.

Assessment of antioxidant activity

Antioxidant activity was determined by three fundamentally different methods. Spectrophotometric measurements of antioxidant activity were carried out using the UV-Vis Spekol 1300 (Analytikjena, Germany). All samples were measured three times. The result value was obtained as an average of these measurements, with the results of these analyses expressed as gallic acid equivalents.

Determination of Antioxidant Activity by the ABTS Test

Preparation of the solution

The solution for the determination of the antioxidant activity was prepared by mixing two solutions. Solution 1: 7 mmol.L⁻¹ solution ABTS (2,2'-azinobis 3 ethylbenzothiazoline-6-sulfonic acid) was prepared by weighing $m = 9.60$ mg per 5 ml of distilled water. Solution 2: 4.95 mmol.L⁻¹ solution of potassium peroxodisulfate used $m = 1.67$ mg per 5 ml of distilled water. These two solutions were then mixed. The resulting solution was diluted with distilled water at the ratio 1:10. The solution was left for 12 hours in a dark and cold environment.

Spectrometric analysis

A 1500 μ L volume of the ABTS reagent (7 mM 2,2'-azinobis-3-ethylbenzothiazoline-6-sulfonic acid) and 30 μ L of the sample (extract from the grapevine seeds) was pipetted into the cuvette (3 mL). The mixture was incubated at ambient room temperature for 30 minutes. After this time, the absorbance was measured at 734 nm.



Figure 1 Grape seeds (*Vitis vinifera* L., cultivar Marlen).

Determination of Antioxidant Activity by the DPPH Method

Preparation of the solution

9.35 mg of DPPH[•] radical was weighed. This amount was transferred to a 250 mL volumetric flask and filled with methanol.

Spectrometric analysis

A 2000 µL volume of the DPPH[•] solution was pipetted into the cuvette (3 mL). 40 µL of the sample (extract from the grapevine seeds) was then pipetted into the same cuvette. The mixture was incubated at ambient room temperature for 25 minutes. After the incubation, the absorbance was measured at 505 nm.

Determination of Antioxidant Activity by the FRAP Method

Preparation of the solution

Three solutions were used to determine the antioxidant activity using the FRAP method. 1. The solution TPTZ: 10 mM TPTZ (m = 78.02 mg) was dissolved in 25 mL of 40 mM hydrochloric acid (HCl); 2. The solution of 20 mM FeCl₃: m = 135.13 mg of FeCl₃ was dissolved in 25 mL of distilled water; 3. The solution of acetate buffer: 0.02 M acetate buffer pH 3.6 (m = 775 mg of sodium acetate) was dissolved in 250 mL of distilled water, upon which the pH was adjusted with acetic acid. These three solutions were mixed at a ratio TPTZ: FeCl₃: acetate buffer – 1: 1: 10.

Spectrometric analysis

A 980 µL volume of reagent (a mixture of TPTZ: FeCl₃: acetate buffer) together with 20 µL of the sample was injected into a plastic cuvette and incubated at 37 °C in a thermoblock. 1000 µL of 100 mM of Na₂SO₄ in 50 mM HCl was the added and agitated; after 10 minutes, the absorbance was measured at 620 nm against a blank. The reducing power was calculated from a calibration curve using gallic acid as a standard. Results are expressed as mg.L⁻¹ equivalents of gallic acid.

Assessment of content of total polyphenols

A 40 µL volume of the sample was pipetted into the cuvette (3 mL) and diluted with 1960 µL of distilled water. 50 µL of Folin-Ciocalteu reagent was added into the

cuvette and the mixture was shaken. After 3 minutes, 300 µL of 20% solution of NaCO₃ decahydrate was added. The mixture was shaken and incubated at 22 °C for 120 minutes. After this time, absorbance was measured at λ = 750 nm against a blank.

Assessment of antioxidant components by HPLC-UV-VIS

To determine the HPLC profiles of the individual cultivars, high performance liquid chromatography (HPLC) with UV-VIS detection was used. The system consisted of two Model 582 ESA chromatographic pumps (ESA Inc., Chelmsford, MA, USA) with a working range from 0.001 to 9.999 mL.min⁻¹ and a Zorbax SB C18 (150 × 4.6; size of particles 5 µm, Agilent Technologies, USA) reverse phase chromatographic column. For UV detection, a Model 528 ESA UV detector was used.

RESULTS

To determine the antioxidant characteristics, chromatographic and spectrometric techniques were used. Spectrophotometric methods (determination of the total polyphenolic compounds and antioxidant activity) was assessed by monitoring the number of antioxidants in the sample. Through chromatography, the 10 determined antioxidant components were particularly interesting due to their content in grapes of *Vitis Vinifera*, L.

Assessment of antioxidant activity and polyphenolic compounds

The Folin-Ciocalteu method was used spectrometrically, with the content of the total polyphenolic compounds being determined in the grape seed extract. Such an approach was used because it is a good, simple, and inexpensive way to determine the polyphenols in various fruits and vegetables. A wide range of methods to determine antioxidant activity can be found in existing literature, highlighting how low molecular weight antioxidants act differently depending on the mechanism used. Consequently, antioxidant activity was explored through three fundamentally different methods (ABTS, FRAP, and DPPH). The results are shown in Figure 2. Results are present as a mg.L⁻¹ of gallic acid equivalents.

6,643 (± 154) mg of gallic acid equivalents (GAE) of antioxidant activity was determined using the DPPH test,

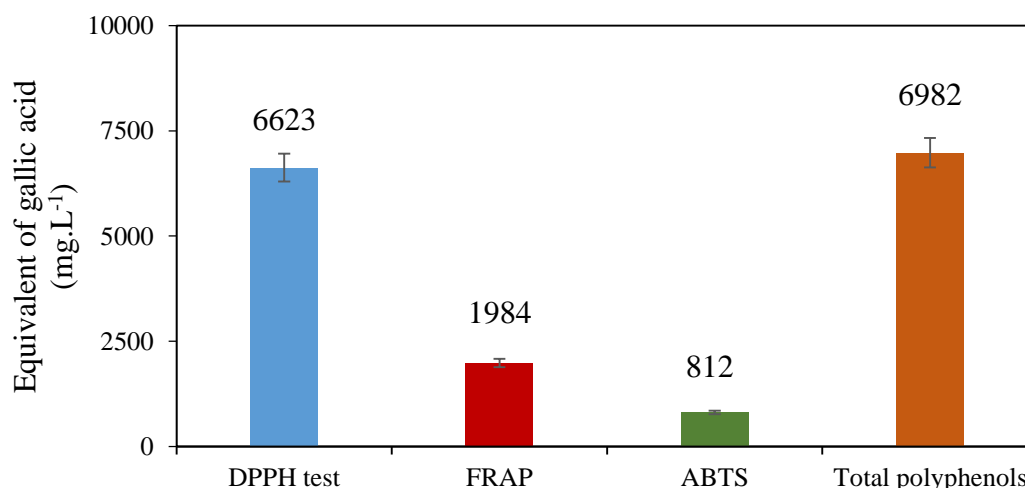

Figure 2 Antioxidant activity of the grape seeds (*Vitis vinifera* L., cultivar Marlen).

Table 1 The content of antioxidant components in grape seeds (*Vitis vinifera* L., cultivar Marlen) determined by HPLC-UV/VIS. Results are expressed in the mg.L⁻¹ of extract.

compounds	content (mg.L ⁻¹)
catechin	114.51 (±7.1)
epicatechin	79.81 (±4.1)
rutin	1.98 (±0.19)
quercitrin	1.09 (±0.14)
quercetin	1.15 (±0.17)
caftaric acid	2.87 (±0.20)
caffeic acid	2.09 (±0.22)
p-coumaric acid	0.687 (±0.11)
ferulic acid	0.139 (±0.05)
gallic acid	27.54 (±1.9)

1,984 (± 88) mg of GAE was obtained using the FRAP method, and 812 (± 31) mg of GAE was found using the ABTS method. Overall, the content of the total number of polyphenolic compounds was 6,982 (± 221) mg of GAE.

Determination of individual antioxidant components

HPLC with UV/VIS detection was used to determine the content of 10 interesting antioxidant components (Table 1). Although the experiment focused on both flavonoids and non-flavonoids, we deliberately devoted more time to analysing hydroxycinnamic acids, as these are an important part of grapes and grapevine seeds. Large quantities of caftaric acid and caffeic acid substances are also contained within the grapes.

The most abundant antioxidant was catechin, with a content of 115 mg.L⁻¹, whilst the least represented compound was ferulic acid (0.139 mg.L⁻¹). This study showed a high antioxidant potential of grapevine seeds.

DISCUSSION

Berradre et al. (2013) analysed the varieties of Malvasia and Tempranillo. They determined the total polyphenol content using the Folin-Ciocalteu method, and the antioxidant activity with the ABTS method, using Trolox as standard. Antioxidant activity was TEAC 54.5 mmol.100 g⁻¹ of the Malvasia sample, and TEAC 48.5 mmol.100 g⁻¹ with the Tempranillo variety (**Berradre et al., 2013**).

Brazilian researchers (**Rockenbach et al. 2011**) studied the antioxidant activity and the content of phenolic compounds from the seeds and skin of *Vitis vinifera* and *Vitis labrusca*. The concentration of phenolic compounds in the seeds ranged from 2,128 to 16,518 mg catechin per 100 g, and from 660 to 1,839 mg catechin per 100 g in the skin. The antioxidant activities were determined using DPPH and FRAP, with Trolox as a standard. Seeds of Pinot Noir contained 16,925 mmol Trolox equivalent per 100 g (DPPH), and 21,492 mmol Fe²⁺.100 g⁻¹ (FRAP). The skin of the Isabel varieties had 3,640 umol TE.100 g⁻¹ and 4,362 umol Fe²⁺.100 g⁻¹, whilst Cabernet Sauvignon and Primitivo had the highest content of anthocyanins (935 and 832 mg.100 g⁻¹) (**Rockenbach et al., 2011**).

Polish scientists (**Samoticha et al., 2017**) used the ABTS, FRAP and ORAC methods to study fruit quality parameters and chemical properties (soluble solids, pH, total acidity and total sugar content, phenolic compounds,

and antioxidant activity) of 30 white, red and pink grapes; 28 interspecific hybrids, and 2 *Vitis vinifera* L. commonly grown in Poland. A total of 49 polyphenolic compounds were identified through LC-PDA-QTOF/MS, and 26 anthocyanins, 9 flavonols and flavones, 7 phenolic acids, 6 flavan-3-ols, and 1 stilbene were quantified using UPLC-PDA-FL. The content of all the polyphenols ranged from 1037.0 (Cascade cv.) to 5759.1 mg.100 g⁻¹ dm (Roesler cv.). Red grape cultivars such as Roesler, Rothay and Swenson Red were characterised as having the highest content of bioactive compounds and antioxidant activity (significantly more than 24, 12 and 53 mmol TE.100 g⁻¹ dm, by ABTS, FRAP and ORAC, respectively).

Burg et al. (2017) studied the physical properties and level of oil extraction from grape seeds from three white (Welschriesling, Green Veltliner, Hiberna) and two red (Zweigelt and Saint Laurent) must varieties of grapevine, using cold screw pressing as the appropriate extraction process. The results show that the density ranged from 602.7 to 606.3 kg.m⁻³, the weight of 1,000 seeds was between 21.9 – 26.6 g, the humidity of dry matter and seed oil content was between 5.6 – 7.1%, depending on the variety and the extracting; it reached 15.3 – 17.5% in dry conditions.

Weidner et al. (2013) studied the phenolic compound obtained from the seeds of European and Japanese species of grapevine (*Vitis vinifera* and *Vitis coignetiae*) using 80% methanol and 80% acetone. The total content of phenolic compounds was determined using the Folin-Ciocalteu reagent, which also monitored the content of tannins. The methods of DPPH and ABTS were used to determine their antiradical activities. The HPLC method was used to determine the phenolic compounds, such as phenolic acids and catechins. The seeds contained large quantities of tannins and an observable quantity of catechins, p-coumaric, ferulic, and caffeic acid. The content of total phenolic compounds was higher in European grapes than in those from Japan.

Iraqi scientist **Dalaram (2017)** determined the total polyphenol content and antioxidant activity in four varieties of lupin. The content for all the polyphenols was determined using the Folin-Ciocalteu reagent (FCR). Antioxidant activity was measured using a compound DPPH' (2,2-diphenyl-1-picrylhydrazyl). Based on the measured values of total antioxidant capacity (TAC), the lupin samples can be classified as follows: L. Albus (white) lupin (43.44%) >L. Angustifolius (blue) lupin

(38.27%) >L. Luteus (yellow) lupin (22.29%) >L. Mutabilis (Pearl) lupin (20.80%).

Li et al. (2008) studied the content of phenolic substances and the antioxidant activity of a powder made of grapevine seeds. The antioxidant potential of the seed extract was assessed by the following tests: CUPRAC, DPPH, ABTS, and OH quenching of electronically excited radicals. A physiological *in vitro* method enabled higher levels of phenolic compounds to be reached, and a greater antioxidant capacity than would have been possible using chemical methods. A mixture of acetone:water (70: 30) was used as a solvent to maximise the yield of phenols and to enhance the antioxidant capacity. Our results indicate that biological properties of natural antioxidants treated physiologically under *in vitro* conditions may be useful in the field of healthy nutrition (Li et al., 2008).

Farhadi et al. (2016) determined the content of phenolic compounds and antioxidant activity in the skin, pulp, seed, cane and leaf of one international (Muscat) and five native (Hosseini, Ghara Shira, Agh Shani, Ghara Shani and Ghara Ghandome) grapes cultivated in West Azerbaijan, Iran. The skin of the Ghara Shani grape was found to contain the highest total content of phenolics and anthocyanin, and its cane contained the highest amount of flavonoid. Due to a remarkable DPPH, where radical scavenging activity rose to 95%, the lowest IC₅₀ was found in the skin of the Ghara Shani.

Scientists from China (Wen et al., 2016) explored the potential of the large amount of grape pomace in wineries of China; the oils of three Eurasian grape cultivars (Chardonnay, Merlot and Carbernet Sauvignon), and two traditional Chinese grape cultivars (*Vitis amurensis* and *Vitis davidii*). Grape seed oils proved to be good sources of polyunsaturated fatty acid (PUFA) (63.88 – 77.12%), sterols (227.99 – 338.83 mg.100 g⁻¹ oil) and tocotrienols (320.08 – 679.24 mg.kg⁻¹ oil). Seed oil of *V. amurensis* exhibited the highest values for polyunsaturated fatty acid, total tocotrienols, and total tocopherols, as well as for the DPPH centre dot scavenging capacity. Seed oil of the Carbernet Sauvignon had the highest content of squalene, total sterols, total tocopherols, and total phenolics.

CONCLUSION

Studying the antioxidant components in grape seeds and their potential benefit to human health is the greatest contribution in this field of research. From the obtained results, we can say that grapevine seeds display a very high content of antioxidative components, which provide a lot of benefits for human health. Exploring the functional components of grapes is interesting from several aspects. In addition to being an important factor in the organoleptic properties of wine (as well as other products such as oil and flour), what is more interesting is how they benefit human health, as demonstrated by countless studies. As they come from agro-industrial waste, grapes do not represent a significant economic burden in the production of final products. Therefore, they have the potential to be used in the production of natural supplements and products for people directly.

REFERENCES

- Ali, K., Maltese, F., Choi, Y. H., Verpoorte, R. 2010. Metabolic constituents of grapevine and grape-derived products. *Phytochemistry Reviews*, vol. 9, no. 3, p. 357-378. <https://doi.org/10.1007/s11101-009-9158-0> PMID:20835385
- Bagchi, D., Bagchi, M., Stohs, S. J., Das, D. K., Ray, S. D., Kuszynski, C. A., Joshi, S. S., Pruess, H. G. 2000. Free radicals and grape seed proanthocyanidin extract: Importance in human health and disease prevention. *Toxicology*, vol. 148, no. 2-3, p. 187-197. [https://doi.org/10.1016/S0300-483X\(00\)00210-9](https://doi.org/10.1016/S0300-483X(00)00210-9)
- Berradre, M., Gonzalez, C., Sulbaran, B., Fernandez, V. 2013. Polyphenols content and antioxidant activity of grape seed extract (*Vitis vinifera*) Malvasia and Tempranillo variety. *Revista De La Facultad De Agronomia De La Universidad Del Zulia*, vol. 30, p. 619-631.
- Burg, P., Mašán, V., Rutkowski, K. 2017. Evaluation of the pressing process during oil extraction from grape seeds. *Potravinárstvo Slovak Journal of Food Sciences*, vol. 11, no. 1, p. 1-6. <https://doi.org/10.5219/690>
- Catalgol, B., Batirel, S., Taga, Y., Ozer, N. K. 2012. Resveratrol: French paradox revisited. *Frontiers in Pharmacology*, vol. 3, p. 141. <https://doi.org/10.3389/fphar.2012.00141> PMID:22822401
- Dalaram, I. S. 2017. Evaluation of total polyphenol content and antioxidant capacity of different variety lupin seeds. *Potravinárstvo Slovak Journal of Food Sciences*, vol. 11, no. 1, p. 26-34. <https://doi.org/10.5219/678>
- Farhadi, K., Esmailzadeh, F., Hatami, M., Forough, M., Molaie, R. 2016. Determination of phenolic compounds content and antioxidant activity in skin, pulp, seed, cane and leaf of five native grape cultivars in west azerbaijan province, iran. *Food Chemistry*, vol. 199, p. 847-855. <https://doi.org/10.1016/j.foodchem.2015.12.083> PMID:26776043
- Fuleki, T., Ricardo Da Silva, J. M. 1997. Catechin and procyanidin composition of seeds from grape cultivars grown in ontario. *Journal of Agricultural and Food Chemistry*, vol. 45, no. 4, p. 1156-1160. <https://doi.org/10.1021/jf960493k>
- Li, H., Wang, X. Y., Li, P. H., Li, Y., Wang, H. 2008. Comparative study of antioxidant activity of grape (*Vitis vinifera*) seed powder based on the assessment by different methods. *Journal of Food and Drug Analysis*, vol. 6, no. 6, p. 67-73.
- Nassiri-Asl, M., Hosseinzadeh, H. 2009. Review of the pharmacological effects of *vitis vinifera* (grape) and its bioactive compounds. *Phytotherapy Research*, vol. 23, no. 9, p. 1197-1204. <https://doi.org/10.1002/ptr.2761> PMID:19140172
- Pascoa, R., Machado, S., Magalhaes, L. M., Lopes, J. A. 2015. Value adding to red grape pomace exploiting eco-friendly ft-nir spectroscopy technique. *Food and Bioprocess Technology*, vol. 8, no. 4, p. 865-874. <https://doi.org/10.1007/s11947-014-1454-z>
- Pekić, B., Kovač, V., Alonso, E., Revilla, E. 1998. Study of the extraction of proanthocyanidins from grape seeds. *Food Chemistry*, vol. 61, no. 1-2, p. 201-206. [https://doi.org/10.1016/S0308-8146\(97\)00128-3](https://doi.org/10.1016/S0308-8146(97)00128-3)
- Samoticha, J., Wojdylo, A., Golis, T. 2017. Phenolic composition, physicochemical properties and antioxidant activity of interspecific hybrids of grapes growing in poland. *Food Chemistry*, vol. 215, p. 263-273. <https://doi.org/10.1016/j.foodchem.2016.07.147> PMID:27542475

Vrsic, S., Ivancic, A., Susek, A., Zagradisnik, B., Valdhuber, J., Sisko, M. 2011. The world's oldest living grapevine specimen and its genetic relationships. *Vitis*, vol. 50, no. 4, p. 167-171.

Wen, X., Zhu, M. H., Hu, R., Zhao, J. H., Chen, Z. Y., Li, J. M., Ni, Y. Y. 2016. Characterisation of seed oils from different grape cultivars grown in china. *Journal of Food Science and Technology-Mysore*, vol. 53, no. 7, p. 3129-3136. <https://doi.org/10.1007/s13197-016-2286-9>
[PMid:27765984](https://pubmed.ncbi.nlm.nih.gov/27765984/)

Yilmaz, Y., Göksel, Z., Erdođan, S. S., Öztürk, A., Atak, A., Özer, C. 2015. Antioxidant activity and phenolic content of seed, skin and pulp parts of 22 grape (*Vitis vinifera* L.) cultivars (4 common and 18 registered or candidate for registration). *Journal of Food Processing and Preservation*, vol. 39, no. 6, p. 1682-1691. <https://doi.org/10.1111/jfpp.12399>

Acknowledgments:

The financial support from sources of the project IGA 11/2016/591 ZF MENDELU is highly acknowledged.

Contact address:

Lenka Tomášková, Mendel University in Brno, Faculty of Horticulture, Department of Viticulture and Enology, Valtická 337, CZ-691 44 Lednice, Czech Republic, E-mail: tomaskova.l9@gmail.com

Jiří Sochor, Mendel University in Brno, Faculty of Horticulture, Department of Viticulture and Enology, Valtická 337, CZ-691 44 Lednice, Czech Republic, E-mail: sochor.jirik@seznam.cz

Mojmír Baroň, Mendel University in Brno, Faculty of Horticulture, Department of Viticulture and Enology, Valtická 337, CZ-691 44 Lednice, Czech Republic, E-mail: mojmir.baron@mendelu.cz



PRINCIPAL COMPONENT ANALYSIS OF SENSORY PROPERTIES OF CHICKEN BREAST MUSCLE SUPPLEMENTED WITH DIFFERENT FEED ADDITIVES

Peter Haščík, Lenka Trembecká, Tomáš Fekete, Juraj Čuboň, Marek Bobko, Miroslav Kročko

ABSTRACT

The objective of the present study was to examine the effect of different dietary supplements (bee pollen, propolis, and probiotic) on sensory quality of chicken breast muscle. The experiment was performed with 180 one day-old Ross 308 broiler chicks of mixed sex. The dietary treatments were as follows: 1. basal diet with no supplementation as control (C); 2. basal diet plus 400 mg bee pollen extract per 1 kg of feed mixture (E1); 3. basal diet plus 400 mg propolis extract per 1 kg of feed mixture (E2); 4. basal diet plus 3.3 g probiotic preparation based on *Lactobacillus fermentum* added to drinking water (E3). Sensory properties of chicken breast muscle were assessed by a five-member panel that rated the meat for aroma, taste, juiciness, tenderness and overall acceptability. The ANOVA results for each attribute showed that at least one mean score for any group differs significantly ($p \leq 0.05$). Subsequent Tukey's HSD revealed that only C group had significantly higher mean score ($p \leq 0.05$) for each attribute compared with E2 group. As regards the E1 and E3 groups, there were not significant differences ($p > 0.05$) in aroma, taste and tenderness when compared to C group, with the significantly lowest juiciness value ($p \leq 0.05$) found in E3 group and significantly lower values of overall acceptability in both groups ($p \leq 0.05$). In addition, it is noteworthy that control group received the highest raking scores for each sensory attribute, i.e. the supplements did not influence positively the sensory quality of chicken breast meat. Principal component analysis (PCA) of the sensory data showed that the first 3 principal components (PCs) explained 69.82% of the total variation in 5 variables. Visualisation of extracted PCs has shown that groups were very well represented, with E2 group clearly distinguished from the others.

Keywords: chicken meat; sensory attribute; dietary supplement; PCA

INTRODUCTION

The high consumption of poultry, leads to concern that the products marketed should be safe, have a low spoilage rate and high quality, and show the right composition, packaging, colour, taste and appearance (Ntzimani et al., 2010). Meat quality is a generic term used to describe properties and perceptions of meat such as colour, freshness, and texture (Maltin et al., 2003; De Lourdes Pérez-Chabela and Totosaus, 2012; Ramachandraiah et al., 2015).

Consumer evaluation of eating quality is the major determinant of meat quality and is primarily associated with tenderness, juiciness and flavour (Markus et al., 2011; Font-i-Furnols and Guerrero, 2014; Choe et al., 2016). Options for measuring meat quality included consumer or trained taste panels and objective measurements. Whilst objective measurements (such as shear force and compression) have the advantage of being relatively cheap, they are rather simplistic, one-

dimensional measures of a complex set of interactions which occur when cooked meat is chewed and masticated in the mouth (Watson et al., 2008).

Human subjects can go beyond the physical components to describe a wide range of factors involved in mastication and afterfeel/aftertaste sensations, such as appearance, flavour, juiciness, and texture. Sensory panels provide complementary information to instrumental method, and neither can be replaced (Liu et al., 2004).

Previous studies have showed that sensory analysis allows producers to identify, understand, and respond to consumer preferences more efficiently (Liu et al., 2004; Fanatico et al., 2007; Saha et al., 2009; Sow and Grongnet, 2010; Chumngoen and Tan, 2015). Instruments do not account for the juiciness and other moisture-related characteristics that panelists may perceive while chewing, and panels may identify and quantify more specific texture attributes that are not measured instrumentally (Liu et al., 2004). Sensory attributes detectable by human senses may also serve as references

during the selection of foods (Chumngoen and Tan, 2015) and may consequently help the manufacturers to increase competition in the market for other producers (Adeyemo and Sani, 2013).

Poultry meat has very complex composition and besides its natural compounds, animal species, age, and sex, nutritional and sensory quality may be affected by diet of birds (Ivanović et al., 2008; Listrat et al., 2016).

There is a variety of feed additives that could be added to the feed or drinking water of a poultry flock to improve production and meat quality. Most of the feed additives as alternatives to antibiotics need to be thoroughly tested in live birds. The possibility of using the alternative compounds including bee products and probiotics in the diet of broiler chickens is being researched. According to that the sensory properties are important factor that influence meat quality, the objective of present study was to determine the effect of bee pollen, propolis and probiotic supplementation on sensory quality of chicken breast meat. Another objective was to highlight and visualise the sensory attributes that determine the differences among the groups of chicken meat using principal component analysis (PCA).

MATERIAL AND METHODOLOGY

Animals and experimental design

The experiment was carried out in test poultry station of Slovak University of Agriculture in Nitra. A total of 180 one day-old broiler chicks of mixed sex (Ross 308) were randomly divided into 4 groups, namely, control (C) and experimental (E1, E2, E3). Each group consisted of 3 replicated pens with 15 broiler chickens per pen.

The experiment employed a randomized design, and dietary treatments were as follows: 1. basal diet as control (group C), 2. basal diet plus 400 mg bee pollen ethanol extract per 1 kg of feed mixture (group E1), 3. basal diet plus 400 mg propolis ethanol extract per 1 kg of feed mixture (group E2), 4. basal diet plus 3.3 g probiotic preparation added to drinking water (group E3). Besides, the groups were kept under the same conditions.

The chickens were fed *ad libitum* over the entire experimental period (42 days) with a diet formulated to meet nutrient requirements for broiler chickens (Bulletin of the Ministry of Agriculture and Rural Development of the Slovak Republic, 2005). Drinking water was also supplied *ad libitum*. Ingredients and nutrient content of the basal diets is presented in Table 1. The chickens received two phases feeding program, starter HYD-01 (1 – 21 d) and grower HYD-02 (22 – 42 d) diets. The feed mixtures both starter and grower were produced without any antibiotics and coccidiostats.

The chickens were submitted to a continuous lighting program and were reared on the floor covered with dry wood shavings, in a temperature-controlled room; room temperature in test poultry station was adjusted at 33 °C in the first week and gradually decreased by 2 °C, and finally fixed at 23 °C thereafter.

Bee pollen and propolis had origin in the Slovak Republic. The extracts were prepared from minced bee pollen and propolis in the conditions of the 80% ethanol in the 500 cm³ flasks, according to Krell (1996). The commercial probiotic preparation used in the experiment was based on *Lactobacillus fermentum* (1 × 10⁹ CFU per 1 g of bearing medium).

At the end of experiment, 10 broiler chickens from each

Table 1 Composition of feed mixtures.

Ingredients (%)	Starter HYD-01 (1 st – 21 st day of age)	Grower HYD-02 (22 nd – 42 nd day of age)
Wheat	34.00	37.00
Maize	33.92	37.52
Soybean meal (48% N)	23.00	18.00
Fish meal (71% N)	5.00	3.00
Dried blood	-	1.00
Fodder lime	1.00	0.95
Monocalcium phosphate	0.80	0.70
Fodder salt	0.10	0.10
Sodium bicarbonate	0.15	0.20
Lysine	0.15	0.12
Methionine	0.18	0.21
Bergafat (palm kernel oil)	1.20	0.70
Euromix BR 0.5% ¹	0.50	0.50
Nutrient composition (g.kg⁻¹)		
Linoleic acid	13.53	14.05
ME _N (MJ.kg ⁻¹)	12.07	12.16
Fibre	30.50	29.67
Crude protein	212.40	191.61
Ash	27.00	20.90
Ca	8.22	7.18
P	6.55	5.86
Na	1.77	1.70

Note: ¹Active substances per kilogram of premix: vitamin A 2 500 000 IU; vitamin E 20 000 mg; vitamin D3 800 000 IU; niacin 12 000 mg; D-pantothenic acid 3 000 mg; riboflavin 1 800 mg; pyridoxine 1 200 mg; thiamine 600 mg; menadione 800 mg; ascorbic acid 20 000 mg; folic acid 400 mg; biotin 40 mg; kobalamin 8.0 mg; choline 100 000 mg; betaine 50 000 mg; Mn 20 000 mg; Zn 16 000 mg; Fe 14 000 mg; Cu 2 400 mg; Co 80 mg; I 200 mg; Se 50 mg.

group were selected and slaughtered at the slaughterhouse of Slovak University of Agriculture in Nitra. After evisceration, the carcasses were kept at approximately 18 °C for 1 h post mortem and thereafter longitudinally divided into two parts. Afterwards, the half-carcasses were stored at 4 °C until 24 h post mortem.

Breast meat samples (*pectoralis major*) from the left half-carcasses were then collected for evaluation of sensory attributes, whereas the right half-carcasses were assigned to different analysis. The samples (boneless breast without skin) were individually packaged in labeled bags and stored at -18 °C for 1 month prior to sensory analysis.

Sensory evaluation

The sensory attributes of the roasted chicken meat (breast muscle) were analyzed. Before the roasting, breast meat samples were removed from the freezer and allowed to thaw in the refrigerator overnight.

Roasting was done in the electric oven (Gorenje B 3300 E), without added fat or oil, at 200 °C with regular turning of the samples until the meat was done. The meat samples were subsequently removed from the oven and left to cool at room temperature.

After that, they were trimmed of subcutaneous fat and connective tissue, sliced into uniform sizes (about 2 cm), and immediately presented to each panelist on plain white porcelain plates. Sensory evaluation was carried out in a climate-controlled sensory analysis laboratory equipped with individual booths.

Sensory profiles were determined by a 5-member semi-trained panel. Panelists were staff and PhD. students in Department of Animal Products Evaluation and Processing, Slovak University of Agriculture in Nitra; three were women and two were men, ranging from 27 to 57 years of age. They had more than 3 years of food sensory panel experience and poultry meat experience.

Panelists were provided with water for mouth-cleansing before and between samples. The samples were presented to the panelists monadically. Sensory evaluation was conducted over an 8-wk period (n = 10).

Sensory attributes of breast meat samples including aroma, taste, juiciness, tenderness, and overall acceptability on a five-point hedonic scale. The scale for each attribute ranged from 0 to 5 as follows: aroma (1 = very poor, 5 = very good), taste (1 = very poor, 5 = very good), juiciness (1 = extremely dry, 5 = extremely juicy), tenderness (1 = extremely tough, 5 = extremely tender),

and overall acceptability (1 = not acceptable, 5 = extremely acceptable).

Statistical analysis

The statistical analysis, including graphical presentations, was performed using the XLSTAT (Addinsoft, 2016) package program. Rating scores mean for each sensory attribute and standard deviation were calculated. The data were analyzed by analysis of variance (ANOVA). A Tukey's honestly significant difference (HSD) post hoc test was then carried out to determine sensory attributes means, which significantly differ for the chicken meat samples. The level of significance was established at $p \leq 0.05$. A principal component analysis (PCA) was performed to distinguish the groups of chicken breast muscle, and to visualise the data on a 2-dimensional map that allows depicting the differences between the groups as much as possible.

RESULTS AND DISCUSSION

The mean scores of sensory characteristics (aroma, taste, juiciness, tenderness, and overall acceptability) of chicken breast meat samples are shown in Table 2. There was significant difference between control and group E2 with respect to aroma attribute ($p \leq 0.05$), with the lowest value found in that group (4.03 ± 0.170) and the highest one found in control (4.22 ± 0.122). Statistically significant differences ($p \leq 0.05$) were detected among values in E2 and C, E1, and that in E3 group in terms of taste attribute, with the lowest value found in the E2 group (4.00 ± 0.244) and the highest one found in control (4.18 ± 0.225). Values for juiciness were significantly different ($p \leq 0.05$) between control and E2, E3 groups, with the lowest value observed in E3 (3.51 ± 0.338).

Of all five attributes, tenderness was the most sensitive parameter since there was significantly lower tenderness values in breast muscle of chickens after the supplementation of all the feed additives investigated in present study. Similar results ($p \leq 0.05$) were also detected in overall acceptability of these groups as E2 group (3.74 ± 0.304) was considered as the least acceptable for panelists whereas C group (4.07 ± 0.221) was considered as the most acceptable.

The results of present study are consistent with those of Haščík et al. (2012, 2013) who found positive effect of bee pollen and propolis on some sensory attributes of chicken meat.

Similar findings were reported by Mellen et al. (2014)

Table 2 Mean scores of chicken breast samples' sensory characteristics with corresponding results of one-way ANOVA and Tukey's (HSD) test (mean \pm SD).

Group	Sensory attribute				
	Aroma	Taste	Juiciness	Tenderness	Overall acceptability
C	4.22 \pm 0.122 ^b	4.18 \pm 0.225 ^b	3.81 \pm 0.360 ^b	4.06 \pm 0.365 ^d	4.07 \pm 0.221 ^b
E1	4.16 \pm 0.259 ^b	4.11 \pm 0.251 ^b	3.72 \pm 0.342 ^{bc}	3.80 \pm 0.368 ^{bc}	3.95 \pm 0.272 ^{bc}
E2	4.03 \pm 0.170 ^a	4.00 \pm 0.244 ^a	3.58 \pm 0.269 ^{ac}	3.65 \pm 0.422 ^{ac}	3.74 \pm 0.304 ^a
E3	4.20 \pm 0.249 ^b	4.13 \pm 0.228 ^b	3.51 \pm 0.338 ^a	3.74 \pm 0.350 ^{bc}	3.89 \pm 0.252 ^c
F-value	8.43	5.16	8.44	10.85	13.53
P-value	<0.0001	0.0019	<0.0001	<0.0001	<0.0001

Note: C – control group; E1, E2, E3 – experimental groups; mean – average; SD – standard deviation; ^{a-d} means within a column with the same superscript are not significantly different ($p > 0.05$) depending on the results of Tukey's test.

who investigated effect of different feed additives on sensory quality of chicken meat.

The results of study **Teye et al. (2015)** indicated that palm kernel oil residue inclusion up to 17.5% in broilers has no significant ($p > 0.05$) effects on sensory characteristics of the meat.

In another study, **Ntchimani et al. (2010)** investigated sensory attributes of chicken breast fillets treated with natural antimicrobials, namely EDTA, lysozyme, rosemary and oregano oil and their combinations. In the study, there was well acceptance to the panelists in all the treatments except for oregano oil that was not as pleasant when compared to others.

The findings of **Dinçer et al. (2014)** demonstrated that juiciness and flavour scores of breast meat in chickens after feed restriction did not show any significant differences.

Chulayo et al. (2011) found tender, juicier and a good flavour in chicken meat supplemented with *Aloe ferox* and *Agave sisalana* compared to the other supplement (*Gunera perpersa*).

In the study of **Adeyemo and Sani (2013)**, there was a significant difference ($p \leq 0.05$) in tenderness and juiciness in meat of chickens fed hydrolyzed cassava peel meal as compared to control. However, there was no significant difference in overall acceptability and flavour of chicken meat among the groups.

Liu et al. (2004) investigated the effects of various postchill deboning times on sensory attributes of broiler breast meat. The results indicated differences due to the deboning times. There was a significant reduction in the values of two flavour attributes, seven texture attributes, and one afterfeel-aftertaste attribute for muscles deboned from 2 to 24 h *post mortem*.

Fanatico et al. (2007) reported no significant differences in overall acceptance, appearance, texture, or flavour of

the breast meat among a slow-growing genotype and a fast-growing genotype of broilers.

Bartlett and Beckford (2015) determined effect of sweet potato root meal as partial replacement for corn in the diet on consumers' sensory perception. The results revealed that an inclusion level of sweet potato root meal up to 30% in the diet of broilers was more acceptable to consumers, despite no significant differences in sensory attributes.

Horsted et al. (2011) demonstrated that sensory profiles differed between conventional standard broilers and organic niche broilers.

On the contrary, **Miezeliene et al. (2011)** found no significant effect ($p > 0.05$) on most sensory attributes of chicken breast meat after addition of selenium in broilers diet.

Principal component analysis (PCA)

PCA enables to distinguish the observations (samples) and to identify the most important variables in a multivariate data matrix.

The data matrix (200 observations and 5 variables, i.e. attributes) was used to perform PCA. First three components (PCs), which explained 69.82% of the total variation in 5 variables (PC1 = 28.55%, PC2 = 21.89%, PC3 = 19.39%), have been used.

The correlation coefficients among variables of sensory quality of chicken breast meat are shown in Table 3. There were several significant correlations among sensory attributes of chicken breast meat observed. Positive and weak correlation was observed between aroma and tenderness. Overall acceptability correlated positively and very weakly with taste and tenderness. Regarding the other relationships, there were not found any significant correlations. In addition, it has been shown that taste was the only attribute correlated negatively with juiciness.

Table 3 Pearson correlation coefficients among sensory attributes.

Variables	Aroma	Taste	Juiciness	Tenderness	Acceptability
Aroma	1				
Taste	0.083	1			
Juiciness	0.102	-0.081	1		
Tenderness	0.221*	0.066	0.062	1	
Acceptability	0.076	0.19*	0.12	0.151*	1

Note: *significant correlation ($p \leq 0.05$).

Table 4 Loadings (coefficients of correlation between variable and PCs).

Variables	PC1	PC2	PC3	PC4	PC5
Aroma	0.60	-0.23	-0.49	-0.48	0.34
Taste	0.42	0.72	0.09	-0.36	-0.40
Juiciness	0.33	-0.68	0.51	-0.25	-0.33
Tenderness	0.64	-0.13	-0.39	0.57	-0.32
Acceptability	0.61	0.21	0.55	0.26	0.46

Table 5 Squared cosines of the attributes.

	PC1	PC2	PC3	PC4	PC5
Aroma	0.36*	0.05	0.24	0.23	0.12
Taste	0.18	0.52*	0.01	0.13	0.16
Juiciness	0.11	0.46*	0.26*	0.06	0.11
Tenderness	0.41*	0.02	0.15	0.32	0.10
Acceptability	0.37*	0.05	0.30	0.07	0.21

Note: Values with asterisk correspond for each variable to the factor for which the squared cosine is the largest.

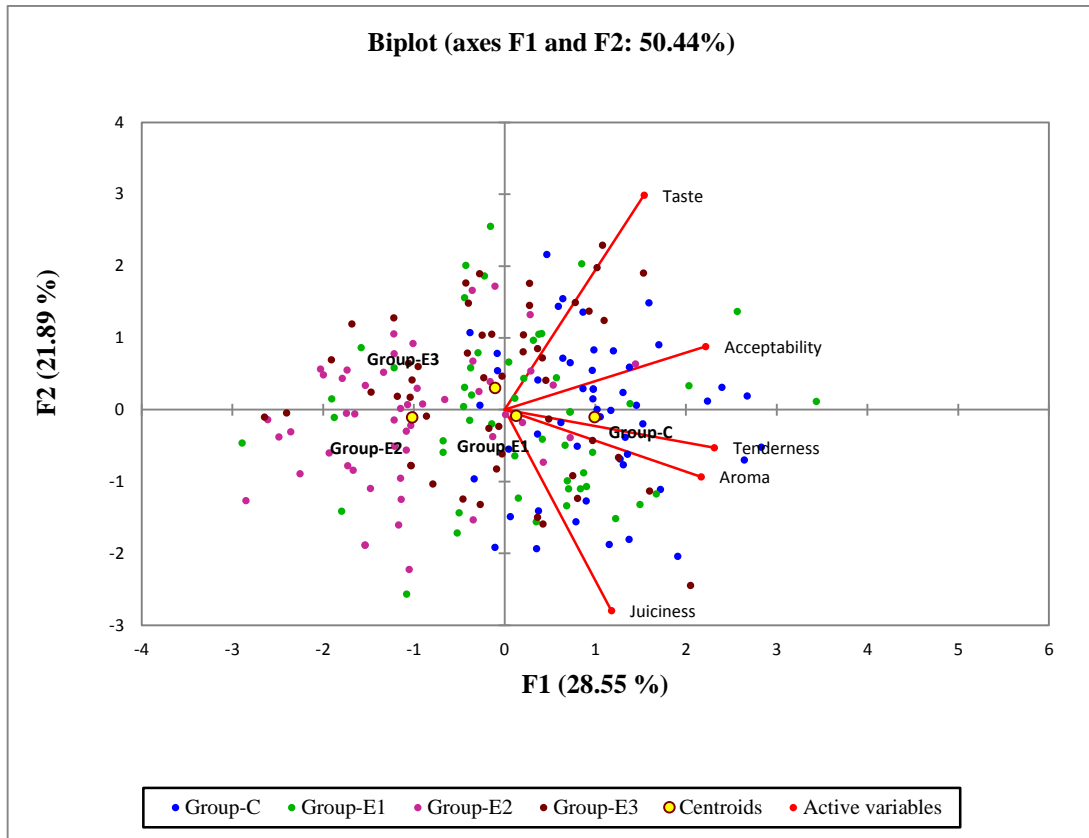

Figure 1 Plot of PC1 and PC2 showing observations (groups) of breast chicken meat and positions in terms of vectors of variables.

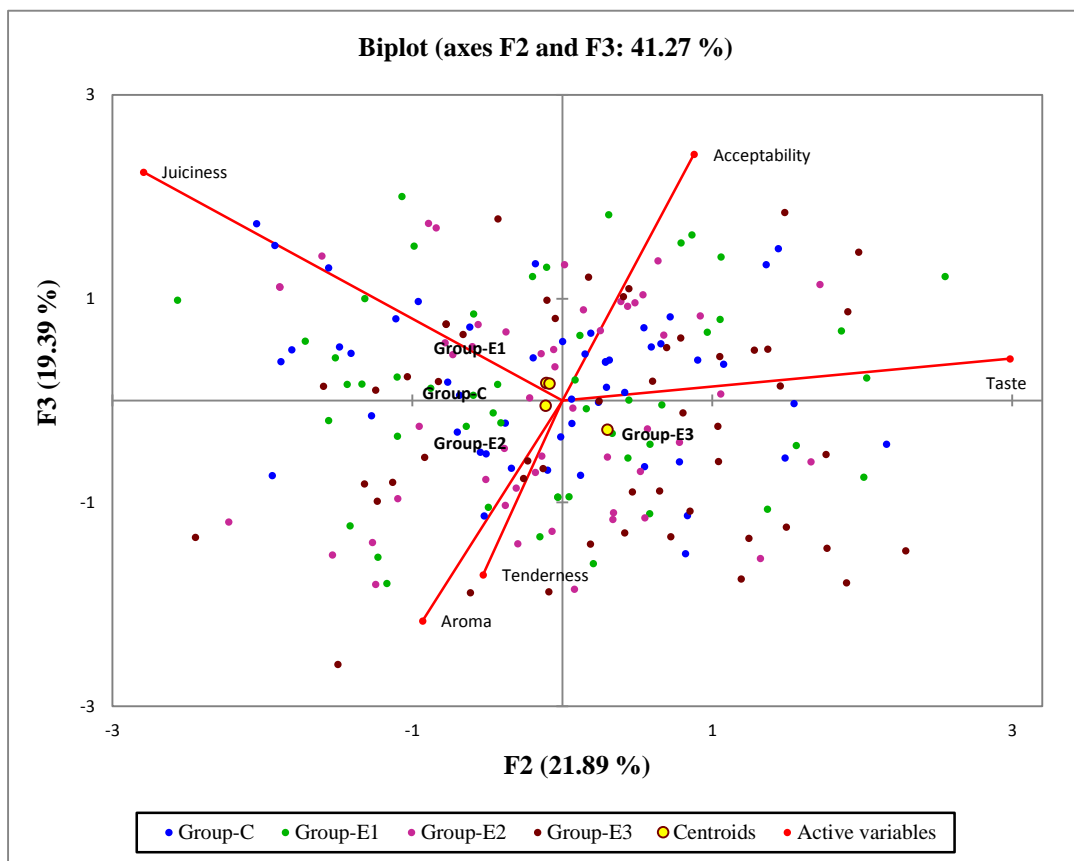

Figure 2 Plot of PC2 and PC3 showing observations (groups) of breast chicken meat and positions in terms of vectors of variables.

Regarding the factor loadings (Table 4) and squared cosines (Table 5), the PC1 was the most defined by tenderness, acceptability, and aroma. The most important for PC2 was taste and juiciness. In addition to juiciness attribute, it seemed to be the most characterised by PC2 and PC3, since there were the the highest values of squared cosines.

The first 3 significant PC were chosen for result plotting and interpretation (Figures 1 and 2). There is noticeable from PC1 and PC2 plot that C group is the most separated from E2 group, suggesting that groups E1 and E3 are entirely similar in terms of aroma, tenderness, and overall acceptability attributes.

As shown on PC2 and PC3 plot, evolution of breast muscle juiciness in control group resembled to those in E1 and E2 groups, but, on the contrary, evidently differed from that in E3 group. The finding is also in accordance with data obtained by ANOVA. As far as the differences in taste attribute are concerned, the positions of the groups coincided with the ANOVA results.

CONCLUSION

The results obtained in the present study demonstrated that supplements investigated in experiment (bee pollen, propolis, and probiotic) had rather undesirable impact on sensory quality of chicken breast muscle. Propolis-supplemented group of chickens has been shown as the least acceptable in sensory evaluation, whereas the control group received the highest raking scores for each sensory attribute. Sensory panel was not able to distinguish clearly between the samples supplemented with bee pollen and probiotic according to their sensory attributes. Furthermore, PCA results indicated clear separation of the groups in the most of sensory attributes. Further studies on supplementation of these additives regarding the sensory quality of chicken meat may be, however, recommended.

REFERENCES

Addinsoft. 2016. XLSTAT, Analyse de données et statistique avec MS Excel. Addinsoft, NY, USA.

Adeyemo, I. A., Sani, A. 2013. Physical appearance and organoleptic properties of poultry meat fed *Aspergillus niger* hydrolyzed cassava peel meal based diet. *International Journal of Agricultural Policy and Research*, vol. 1, no. 6, p. 166-171.

Bartlett, J. R., Beckford, R. C. 2015. Sensory Characteristics and Skin Color Evaluation of Meat from Broiler Chickens Fed Sweet Potato Root Meal. *Journal of Biology, Agriculture and Healthcare*, vol. 5, no. 8, p. 47-58.

Bulletin of the Ministry of Agriculture and Rural Development of the Slovak Republic. 2004. Decree of Ministry of Agriculture and Rural Development of the Slovak Republic No. 2145/2004-100 of 23 August 2004 changing and amending Decree of Ministry of Agriculture and Rural Development of the Slovak Republic No. 1497/1/1997-100 of 7 October 1997 regulating laboratory testing and feed assessment as amended by Decree of Ministry of Agriculture and Rural Development of the Slovak Republic No. 149/2/2003-100 of 12 February 2003.

Choe, J., Choi, M., Rhee, M., Kim, B. 2016. Estimation of Sensory Pork Loin Tenderness Using Warner-Bratzler Shear Force and Texture Profile Analysis Measurements. *Asian-Australasian Journal of Animal Sciences*, vol. 27, no. 7, p. 1029-1036. <https://doi.org/10.5713/ajas.15.0482>

Chulayo, A. Y., Muchenje, V., Mwale, M., Masika, P. J. 2011. Effects of some medicinal plants on consumer sensory characteristics of village chicken meat. *African Journal of Biotechnology*, vol. 10, no. 5, p. 815-820.

Chumngoen, W., Tan, F. 2015. Relationships between Descriptive Sensory Attributes and Physicochemical Analysis of Broiler and Taiwan Native Chicken Breast Meat. *Asian-Australasian Journal of Animal Sciences*, vol. 28, no. 7, p. 1028-1037. <https://doi.org/10.5713/ajas.14.0275>
[PMid:26104409](https://pubmed.ncbi.nlm.nih.gov/26104409/)

De Lourdes Pérez-Chabela, M., Totosaus, A. 2012. Poultry Quality and Tainting. In Nolle, L. M. L. *Handbook of Meat, Poultry and Seafood Quality*. Blackwell : John Wiley & Sons. p. 360-372. ISBN 978-0-470-95832-2. <https://doi.org/10.1002/9781118352434.ch24>

Diñçer, E., Parlak, S. U., Engin, B., Yüceer, Y. K., Mendeş, M. 2014. Effect of Feed Restriction on Some Chemical and Sensory Properties of Chicken Meat. *Journal of Agricultural Sciences*, vol. 20, no. 1, p. 48-56.

Fanatico, A. C., Pillai, P. B., Emmert, J. L., Gbur, E. E., Meullenet, J. F., Owens, C. M. 2007. Sensory attributes of slow- and fast-growing chicken genotypes raised indoors or with outdoor access. *Poultry Science*, vol. 86, no. 11, 2441-2449. <https://doi.org/10.3382/ps.2007-00092>
[PMid:17954596](https://pubmed.ncbi.nlm.nih.gov/17954596/)

Font-i-Furnols, M., Guerrero, L. 2014. Consumer preference, behavior and perception about meat and meat products: An overview. *Meat Science*, vol. 98, no. 3, p. 361-371. <https://doi.org/10.1016/j.meatsci.2014.06.025>
[PMid:25017317](https://pubmed.ncbi.nlm.nih.gov/25017317/)

Haščík, P., Garlík ml., J., Kačániová, M., Čuboň, J., Mellen, M., Mihok, M., Eliman, I. 2012. Sensory evaluation of meat chickens ROSS 308 after application of propolis in their nutrition. *Potravinárstvo*, vol. 6, no. 1. <https://doi.org/10.5219/158>

Haščík, P., Eliman, I., Garlík, J., Bobko, M., Kročko, M. 2013. Sensory evaluation for broiler meat after addition Slovak bee pollen in their feed mixture. *Potravinárstvo*, vol. 7, no. 1. p. 107-110. <https://doi.org/10.5219/280>

Horsted, K., Allesen-Holm, B. H., Hermansen, J. E., Kongsted, A. G. 2011. Sensory profiles of breast meat from broilers reared in an organic niche production system and conventional standard broilers. *Journal of the Science of Food and Agriculture*, vol. 92, no. 2, p. 258-265. <https://doi.org/10.1002/jsfa.4569>
[PMid:21800323](https://pubmed.ncbi.nlm.nih.gov/21800323/)

Ivanović, S., Savić, S., Baltić, M., Teodorović, V., Žujović, M. 2008. Dependence of lamb sensory properties on meat ripening level. *Biotechnology in Animal Husbandry*, vol. 24, no. 3-4, p. 93-100.

Krell, R. 1996. *Value-added products from bee keeping*. Rome : Food and Agriculture Organization of the United Nations. 395 p. ISBN 92-5-103819-8.

Listrat, A., Leuret, B., Louveau, I., Astruc, T., Bonnet, M., Lefaucheur, L., Picard, B., Bugeon, J. 2016. How Muscle Structure and Composition Influence Meat and Flesh Quality. *The Scientific World Journal*, vol. 2016, 14 p. <https://www.hindawi.com/journals/tswj/2016/3182746/>
[PMid:27022618](https://pubmed.ncbi.nlm.nih.gov/27022618/)

Liu, Y., Lyon, B. G., Windham, W. R., Lyon, C. E., Savage, E. M. 2004. Principal Component Analysis of Physical, Color, and Sensory Characteristics of Chicken Breasts Deboned at Two, Four, Six, and Twenty-Four Hours Postmortem. *Poultry Science*, vol. 83, no. 1, p. 101-108. <https://doi.org/10.1093/ps/83.1.101>
[PMid:14761091](https://pubmed.ncbi.nlm.nih.gov/14761091/)

- Maltin, C., Balcerzak, D., Tilley, R., Delday, M. 2003. Determinants of meat quality: tenderness. *Proceedings of the Nutrition Society*, vol. 62, no. 2, p. 337-347. <https://doi.org/10.1079/PNS2003248> PMID:14506881
- Markus, S. B., Aalhus, J. L., Janz, J. A. M., Larsen, I. L. 2011. A survey comparing meat quality attributes of beef from credence attribute-based production systems. *Canadian Journal of Animal Science*, vol. 91, no. 2, p. 283-294. <https://doi.org/10.4141/cjas10082>
- Mellen, M., Pavelková, A., Haščík, P., Bobko, M., Čuboň, J. 2014. Sensory evaluation of coob 500 chicken meat after application of different additives in their nutrition. *Potravinárstvo*, vol. 8, no. 1, p. 184-189. <https://doi.org/10.5219/373>
- Miezeliene, A., Alencikiene, G., Gruzauskas, R., Barstys, T. 2011. The effect of dietary selenium supplementation on meat quality of broiler chickens. *Biotechnology, Agronomy, Society and Environment*, vol. 15, no. S1, 61-69.
- Ntzimani, A. G., Giatrakou, V. I., Savvaidis, I. N. 2010. Combined natural antimicrobial treatments (EDTA, lysozyme, rosemary and oregano oil) on semi cooked coated chicken meat stored in vacuum packages at 4 °C: Microbiological and sensory evaluation. *Innovative Food Science and Emerging Technologies*, vol. 11, no. 1, p. 187-196. <https://doi.org/10.1016/j.ifset.2009.09.004>
- Ramachandriah, K., Han, S. G., Chin, K. B. 2015. Nanotechnology in Meat Processing and Packaging: Potential Applications – A Review. *Asian-Australasian Journal of Animal Sciences*, vol. 28, no. 2, p. 290-302. <https://doi.org/10.5713/ajas.14.0607> PMID:25557827
- Saha, A., Perumalla, A. V., Lee, Y., Meullenet, J. F., Owens, C. M. 2009. Tenderness, moistness, and flavor of pre- and postrigor marinated broiler breast fillets evaluated by consumer sensory panel. *Poultry Science*, vol. 88, no. 6, p. 1250-1256. <https://doi.org/10.3382/ps.2008-00236> PMID:19439637
- Sow, T. M. A., Grongnet, J. F. 2010. Sensory characteristics and consumer preference for chicken meat in Guinea. *Poultry Science*, vol. 89, no. 10, p. 2281-2292. <https://doi.org/10.3382/ps.2010-00679> PMID:20852120
- Teye, M., Apori, S. O., Ayeida, A. A. 2015. Carcass Parameters and Sensory Characteristics of Broiler Chicken Fed Diets Containing Palm (*Elaeis guineensis*) Kernel Oil Residue. *International Journal of Current Microbiology and Applied Sciences*, vol. 4, no. 6, p. 1030-1038.
- Watson, R., Gee, A., Polkinghorne, R., Porter, M. 2008. Consumer assessment of eating quality – development of protocols for Meat Standards Australia (MSA) testing. *Australian Journal of Experimental Agriculture*, vol. 48, no. 11, p. 1360-1367. <https://doi.org/10.1071/EA07176>

Contact address:

doc. Ing. Peter Haščík, PhD., Slovak University of Agriculture in Nitra, Faculty of Biotechnology and Food Sciences, Department of Animal Products Evaluation and Processing, Tr. A. Hlinku 2, 949 76 Nitra, Slovakia, E-mail: peter.hascik@uniag.sk

Ing. Lenka Trembecká, Slovak University of Agriculture in Nitra, Faculty of Biotechnology and Food Sciences, Department of Animal Products Evaluation and Processing, Tr. A. Hlinku 2, 949 76 Nitra, Slovakia, E-mail: xtrembecka@uniag.sk

Ing. Tomáš Fekete, Slovak University of Agriculture in Nitra, Faculty of Biotechnology and Food Sciences, Department of Food Hygiene and Safety, Tr. A. Hlinku 2, 949 76 Nitra, Slovakia, E-mail: xfeketet@uniag.sk

prof. Ing. Juraj Čuboň, CSc., Slovak University of Agriculture in Nitra, Faculty of Biotechnology and Food Sciences, Department of Animal Products Evaluation and Processing, Tr. A. Hlinku 2, 949 76 Nitra, Slovakia, E-mail: juraj.cubon@uniag.sk

Ing. Marek Bobko, PhD., Slovak University of Agriculture in Nitra, Faculty of Biotechnology and Food Sciences, Department of Animal Products Evaluation and Processing, Tr. A. Hlinku 2, 949 76 Nitra, Slovakia, E-mail: marek.bobko@uniag.sk

Ing. Miroslav Kročko, PhD., Slovak University of Agriculture in Nitra, Faculty of Biotechnology and Food Sciences, Department of Animal Products Evaluation and Processing, Tr. A. Hlinku 2, 949 76 Nitra, Slovakia, E-mail: mirokrocko@yahoo.com



THE EFFECT OF FEEDING WHEAT VARIETIES WITH DIFFERENT GRAIN PIGMENTATION ON GROWTH PERFORMANCE, TEXTURE, COLOUR AND MEAT SENSORY TRAITS OF BROILER CHICKENS

Ondřej Štastník, Filip Karásek, Miroslav Jůzl, Eva Mrkvicová, Leoš Pavlata, Šárka Nedomová, Václav Trojan, Tomáš Vyhnánek, Petr Doležal, Petr Martinek

ABSTRACT

The feeding effect of three spring wheat genotypes (Vánek, Konini and UC66049) with different grain colour on growth performance, body composition and meat quality parameters of broiler chickens was tested. Ninety chickens were divided into three groups (control, Konini and UC) with 30 chickens in each. The tested genotypes were compared with standard variety Vánek (control) with common (red) grain colour. The two experimental groups received feed mixtures containing 38.2% of wheats with different grain colour: groups Konini (n = 30) and UC (n = 30) with. The third group (n = 30) had 38.2% of common wheat Vánek cultivar (Control group). The live weight of chickens between the experimental groups and control group was not significantly different, as well as body composition and chemical analysis of breast and thigh meat of chickens. The feeding of wheat with different grain colour had no effect on performance parameters of broiler chickens. Breast meat tenderness according to the Razor Blade Shear Force was higher in control group against experimental groups. The colour change was not significantly different in all coordinates. pH values (measured after 1-hour *post mortem*) were found significantly higher in the group fattening with Konini wheat than control and UC groups. Chickens meat from the experimental group was characterised by steady overall quality. The effect of various feeding had no effect on meat quality in terms of relevance to consumers.

Keywords: blue aleurone; purple pericarp; poultry nutrition; growth; meat quality

INTRODUCTION

The large scale of phenolic compounds in wheat grain contains simple molecules such as phenolic acids to highly polymerised compounds such as tannins and proanthocyanidins (Yang et al., 2009). The polyphenols possess a number of beneficial properties and its antioxidant effect is very important. The antioxidant compounds have already been identified as phenolic acids, derivatives of stilbene, flavan-3-ols (catechin and epicatechin), flavonols and anthocyanidins (Caillet et al., 2006). Positive effects of phenolic compounds used in small doses in animal diet observed which can act as health promoters rather than inhibitors (Starčević et al., 2015).

The purple colour of wheat grains is caused by anthocyanins accumulated in the pericarp, while the blue colour is generated by anthocyanins in the aleurone layer of the endosperm (Zeven, 1991). Anthocyanins are the largest group of water soluble natural pigments that give red, violet, and blue colour to many fruits, vegetables and also in cereal grains. Anthocyanins have some beneficial

health effects concerning oxidative damage, detoxification enzymes, and the immune system (Choia et al., 2007; Prior and Wu, 2006).

The broiler chickens are the most popular among poultry species in the world, because of the simplicity of cooking. The chicken meat is considered to be a healthy food due to its relatively low fat, saturated fatty acid and cholesterol content (Haščík et al., 2016; Starčević et al., 2015). The nutritional properties of poultry meat are highly valued (Starčević et al., 2015).

The development of the food industry leads to the search for new raw materials with improved nutritional properties. The coloured grains of some cereals have potential in production of functional food with added health benefits (Li et al., 2004; Garg et al., 2016). Testing of influence of different grain colour has been going for several years and the results have been published continuously (Karasek et al., 2014; Stastnik et al., 2014; Mareš et al., 2015; Mrkvicová et al., 2016).

The effect of feeding wheat varieties with different grain colour on growth performance, texture, colour, and sensory traits of broiler chicken's meat was evaluated.

MATERIAL AND METHODOLOGY

Animals, nutrition and growth performance

The animal procedures were reviewed and approved by the Animal Care Committee of the Mendel University in Brno. The experiment was performed with 90 cockerels of Ross 308 hybrid. The conventional deep litter system with wood shavings was used. The trial was performed from day 12 to day 37 of chickens age. Room temperature and humidity were controlled according to requirement for actual age of chickens in **Aviagen Group (2014)**. Lighting system was 16 hours light and 8 hours dark. Cockerels were divided into three equal groups. The two experimental groups received feed mixtures containing 38.2% of wheats with different grain colour: groups Konini (n = 30) with Konini wheat cultivar and UC (n = 30) with UC66049 cultivar, respectively. The third group (n = 30) had 38.2% of common wheat Vánek cultivar (C). The rations were calculated according to the "Recommended nutrient content in poultry diets and nutritive value of feeds for poultry" (**Zelenka et al., 2007**).

The basic chemical composition of used experimental wheats is presented in Table 1.

The total content of anthocyanins was measured according to **Varga et al. (2013)** and expressed as the

cyanidin-3-glucoside. The experimental wheats Vánek, Konini and UC66049 contained 5.09, 7.90 and 47.63 mg.kg⁻¹ cyanidin-3-glucoside, respectively.

The composition and nutrient content of diets are shown in Table 2 and Table 3, respectively.

The chickens were fed *ad-libitum*. Health status was evaluated daily and live weight measured every week during the trial.

At the end of the experiment fifteen birds were selected randomly from each group, weighed and slaughtered by decapitation. Feathers were removed and chickens were eviscerated. Carcass yield was calculated. Breast and thigh meats without skin were separated from carcasses after cooling. All visible external fat was removed from sample meats. The breast and thigh meat was weighed and their percentage of live body weight was calculated.

One half of breast (fillets) and muscles from one thigh were pack up in aluminium foil, marked and stored at -20 °C until sensory analyses. Another half of breast and deboned thigh meat were milled (Moulinex Moulinette; France). Dry matter content of meat was determined by a method with sea sand and the total nitrogen according to Kjeldahl using OPSIS Liquid Line (KjelROC Analyser; KD 310-A-1015; Sweden). The crude protein content was calculated using the factor 6.0 (N*6) pertinent to meat. The content of ether extract was determined gravimetrically after extraction with diethylether under reflux for 6 hours.

Table 1 Chemical composition of used experimental wheats in dry matter.

	Vánek (C)	Konini	UC66049
Gross energy (MJ.kg ⁻¹)	17.61	17.85	17.72
Crude protein (%)	13.43	15.64	18.54
Ether extract (%)	1.52	1.37	1.41
Crude fibre (%)	2.72	2.67	2.58
Ash (%)	1.39	2.07	2.19

Table 2 Composition of diets (g.kg⁻¹).

Component	C	Konini	UC
Wheat	382	382	382
Maize	247	255.5	272.5
Soybean extruded	190	190	190
Soybean meal	105	102	94.5
Premix*	30	30	30
Rapeseed oil	20	20	20
Wheat gluten	15	9.5	0.0
Monocalciumphosphate	7	7	7
CaCO ₃	4	4	4

Note: * Premix contains (per kg): lysine 60 g; methionine 75 g; threonine 34 g; calcium 200 g; phosphorus 65 g; sodium 42 g; copper 500 mg; iron 2,500 mg; zinc 3,400 mg; manganese 4,000 mg; cobalt 7 mg; iodine 30 mg; selenium 6 mg; tocopherol 450,000 mg; calciferol 166,700 international unit (IU); phylloquinone 50 mg; thiamine 140 mg; riboflavin 230 mg; cobalamin 1,000 mg; biotin 7 mg; niaciamid 1,200 mg; folic acid 57 mg, calcium pantothenate 450 mg; choline chloride 6,000 mg; salinomycin sodium 2,333 mg.

Table 3 Nutrients content of diets in dry matter.

	C	Konini	UC
AME (MJ.kg ⁻¹) *	12.81	12.83	12.87
Crude protein (%)	21.29	21.46	21.63
Ether extract (%)	8.09	8.25	8.15
Crude fibre (%)	3.27	3.14	3.03
Ash (%)	5.89	6.20	6.33

Note: * Apparent Metabolisable Energy, calculated value.

Texture, colour and pH of meat

The tenderness of the fillets was determined through the application of the Meullenet-Owens razor shear (MORS) test, using a texture analyser (Model TA-XT2Plus, Texture Technologies, Scarsdale, N.Y., U.S.A.) as described by **Meullenet et al. (2004)** and **Cavitt et al. (2005)** during which Razor Blade Shear Force (N) and Razor Shear Energy (N.mm⁻¹) were recorded. Tests using the MORS blade are conducted on whole intact right fillets with 5 replicates. The sharp blade was replaced every 80 measurements for optimum shearing performance. Test Settings: test speed 10 mm.s⁻¹ and distance 20 mm.

Colour measurement was performed by CIE L*a*b* colour space. L* (lightness), a* (redness) and b* (yellowness) values from the breast meat sample surface on the dorsal side were measured using a Spectrophotometer CM-3500d (Konica Minolta Sensing Inc., Japan) in SCE mode (specular component excluded), angle 8 °, 8 mm slot. Each sample was measured at three places 1-hour *post-mortem*. Average value was taken as the final result. ΔE*ab (CIE, 2007) was calculated according next formulas (**Valous et al., 2009**):

$$\Delta L^* = L^*_{control} - L^*_{group}$$

$$\Delta a^* = a^*_{control} - a^*_{group}$$

$$\Delta b^* = b^*_{control} - b^*_{group}$$

The samples were measured using pH meter Portavo 907 Multi (Knick Elektronische Messgeräte GmbH & Co. KG, Berlin, Germany) with a needle-type electrode (SE104N; Knick Elektronische Messgeräte GmbH & Co. KG, Berlin, Germany) immediately (initial pH, abbreviation pH₁) after chicken's slaughter and 1-hour *post-mortem* (abbreviation pH₂).

Sensory analysis

Sensory analyses of breast and thigh meat samples were evaluated by 10 panellists in special sensory laboratory (Department of Food Technology, Mendel University) according ISO 8589. Each sample (breast and thigh) was packed into plastic case and frozen (-18 °C). These samples were thawed (cold storage room, 4 °C) and boiled in convection oven (200 °C, 60% humidity, 1 hour). Professional evaluation group was represented by a panel of trained panellists under ISO 8586-1. We used a graphic non-structured scale (100 mm) to compare experimental group of descriptors (odour, colour, fibriness, chewiness, juiciness, flavour, fatty taste) with control group.

Statistical analysis

Data were processed by Microsoft Excel (USA) and Statistica version 12.0 (CZ). One-way analysis (ANOVA) was used. To ensure evidential differences Scheffe's test was applied and *p* <0.05 was regarded as statistically significant difference.

Experiments and analyses were performed in new Biotechnology Pavilion M at Mendel University which was built in the frame of OP VaVPI CZ.1.05/4.1.00/04.0135 project.

RESULTS AND DISCUSSION

Grow performance and body composition

The mean live weight of chickens was not different among groups at the end of experiment (Table 4). The differences between the experimental groups and control group was not significant (*p* >0.05). Also, it was found feed conversion ratio (FCR) in amount 1.68 kg.kg⁻¹, 2.00 kg.kg⁻¹ and 1.76 kg.kg⁻¹ per group for Vánek, Konini and UC, respectively. Our findings confirm studies of **Pop et al. (2015)** and **Lichovnikova et al. (2015)** who fed grape

Table 4 Live weight (g) of broilers at 37th day of age.

Group	n	Mean ±standard error
C	30	2,255 ±20.55
Konini	30	2,193 ±44.14
UC	30	2,232 ±47.49

Note: Differences between the groups are not significant (*p* >0.05).

Table 5 Body composition (%) of chickens.

Group	n	Carcass %	Breast meat %	Thigh meat %
			Mean ±standard error	
C	15	71.42 ±0.963	21.38 ±0.628	14.84 ±0.325
Konini	15	70.64 ±0.456	21.30 ±0.296	15.11 ±0.279
UC	15	71.49 ±0.991	21.35 ±0.507	14.90 ±0.398

Note: Differences between the groups are not significant (*p* >0.05).

Table 6 Chemical analysis of breast and thigh meat (%) of broilers chickens.

	n		C	Konini	UC
			Mean ±standard error		
Dry matter	6	Breast meat	23.97 ±0.624	24.04 ±0.383	24.15 ±0.297
		Thigh meat	24.62 ±0.373	23.62 ±0.257	23.64 ±0.265
Crude protein (N*6)	6	Breast meat	20.94 ±0.765	21.80 ±0.189	21.77 ±0.184
		Thigh meat	18.68 ±0.194	18.51 ±0.317	18.57 ±0.180
Ether extract	6	Breast meat	1.24 ±0.190	1.34 ±0.078	1.24 ±0.133
		Thigh meat	4.17 ±0.255	4.18 ±0.385	3.70 ±0.255

Note: Differences between the groups are not significant (*p* >0.05).

Table 7 Effect of feeding wheat varieties with different grain pigmentation on texture, pH and colour of breast meat (means \pm standard error).

Parameter	n	C	Konini	UC
Razor Shear Force (N)	30	11.23 \pm 0.470 ^b	9.91 \pm 0.274 ^a	8.80 \pm 0.335 ^a
Razor Shear Energy (N.mm ⁻¹)	30	104.46 \pm 3.898 ^b	96.94 \pm 2.626 ^{ab}	87.69 \pm 2.553 ^a
L*	12	60.89 \pm 1.406 ^a	61.47 \pm 0.772 ^a	63.46 \pm 0.715 ^a
a*	12	3.52 \pm 0.646 ^a	2.63 \pm 0.519 ^a	3.37 \pm 0.332 ^a
b*	12	9.70 \pm 1.388 ^a	9.39 \pm 0.913 ^a	10.42 \pm 0.343 ^a
C*	12	10.40 \pm 1.478 ^a	9.82 \pm 0.985 ^a	10.98 \pm 0.404 ^a
h ⁰	12	74.31 \pm 4.345 ^a	77.45 \pm 2.938 ^a	72.36 \pm 1.320 ^a
ΔE^*_{ab}		0.00	1.11	2.67
pH ₁	6	6.40 \pm 0.072 ^a	6.52 \pm 0.121 ^a	6.44 \pm 0.054 ^a
pH ₂	6	6.15 \pm 0.073 ^a	6.40 \pm 0.053 ^b	6.11 \pm 0.045 ^a

Note: pH₁ values were measured just after slaughter in breast, likewise pH₂ values were measured after 1-hour post mortem. ΔE^*_{ab} is compared with control group. ^{a,b} Means in a row within effect with no common superscript differ significantly ($p < 0.05$).

pomace containing polyphenols. These diets had no effect on the growth of broiler chickens. On the other hand, **Ruckschloss et al. (2010)** observed in their experiment with wheat with purple colour of grain higher average live weight of laying hens for experimental group. Hens in the experimental group laid larger eggs in comparison with control group and the colour of yolk was not influenced by purple wheat feeding.

The Table 5 showed percentage of body composition of chickens. There were non-significant ($p > 0.05$) differences in carcass yield.

The chemical analyses of breast and thigh meats are shown in Table 6. Differences between groups are not significant ($p > 0.05$).

Texture, colour and pH of meat

The Razor Blade Shear Force results (n = 30) are

presented in Table 7. There were significantly ($p < 0.05$) higher breast meat tenderness in control group against Konini and UC group.

The colour change is not significant in all parameters (lightness L*, a* and b*) as it is shown in Table 7. There were found no significant differences ($p > 0.05$) among all three groups. The total colour change (ΔE^*_{ab} from 1.11 to 2.67) is clearly perceptible but not yet discordant and it is acceptable for consumers (**Saláková, 2012**).

The pH values from control and both experimental groups are shown in Table 7. Initial pH₁ was not significant ($p > 0.05$) in all three group. pH₂ values were measured after 1-hour *post mortem*. The significantly higher ($p < 0.05$) pH₂ value was in the Konini group in comparison with Vánek and UC groups. Differences were not observed between Vánek and UC groups.

There are no published studies on the effect of feeding wheat varieties with different grain pigmentation on

Table 8 Sensory analysis of breast meat of chickens (mm in 100 mm scale).

Group	C			Konini			UC		
	Mean \pm standard error			Mean \pm standard error			Mean \pm standard error		
Sensory trait	n	60	60	n	60	60	n	60	60
Odour		63.97 \pm 2.746 ^a	73.77 \pm 1.527 ^b		69.50 \pm 1.224 ^{ab}				
Colour		73.18 \pm 1.450 ^a	76.02 \pm 1.427 ^a		72.82 \pm 1.758 ^a				
Fibriness		55.18 \pm 2.615 ^a	52.15 \pm 1.970 ^a		52.95 \pm 1.760 ^a				
Chewiness		62.75 \pm 2.513 ^b	48.43 \pm 2.501 ^a		52.67 \pm 2.213 ^{ab}				
Juiciness		51.22 \pm 2.766 ^a	45.23 \pm 2.340 ^a		48.95 \pm 2.546 ^a				
Flavour		74.00 \pm 1.499 ^a	71.53 \pm 2.218 ^a		71.37 \pm 1.700 ^a				
Fatty taste		78.77 \pm 2.091 ^a	83.70 \pm 0.920 ^a		82.63 \pm 1.453 ^a				

Note: ^{a,b} – different letters on one line – statistically significant differences ($p < 0.05$).

Table 9 Sensory analysis of broilers thigh meat (mm in 100 mm scale).

Group	C			Konini			UC		
	Mean \pm standard error			Mean \pm standard error			Mean \pm standard error		
Sensory trait	n	60	60	n	60	60	n	60	60
Odour		70.98 \pm 1.941 ^a	73.55 \pm 1.763 ^a		72.10 \pm 1.678 ^a				
Colour		50.08 \pm 1.190 ^b	57.03 \pm 2.148 ^a		63.28 \pm 2.101 ^a				
Fibriness		56.67 \pm 1.393 ^a	61.92 \pm 1.721 ^b		61.43 \pm 1.194 ^{ab}				
Chewiness		64.83 \pm 1.588 ^b	57.88 \pm 1.528 ^a		59.65 \pm 1.968 ^{ab}				
Juiciness		66.90 \pm 1.965 ^a	64.62 \pm 1.744 ^a		60.82 \pm 2.058 ^a				
Flavour		74.25 \pm 1.871 ^a	69.77 \pm 2.240 ^a		67.65 \pm 2.297 ^a				
Fatty taste		76.35 \pm 2.560 ^a	79.37 \pm 1.870 ^a		77.35 \pm 2.532 ^a				

Note: ^{a,b} – different letters on one line – statistically significant differences ($p < 0.05$).

texture, colour and pH of meat or sensory analysis to compare to these findings. However, it has been reported that grape seed pomace or extracts, milk thistle seed cakes or extracts (contained, inter alia, polyphenols) added to ground poultry feed mixture have caused variable alterations in colour parameters and sensory evaluation (Kasapidou et al., 2016; Šťastník et al., 2016). In Kasapidou et al., (2016) study differences in meat colour lightness and yellowness or sensory attributes in broilers breast meat were not observed.

Although, there was no significant difference in the results, it is positive tendency to consumer perception. Consumers have a clear preference for lighter coloured, poultry breast meat compared to darker thigh/thigh meat (Wideman et al., 2016).

Sensory analysis

The significantly ($p < 0.05$) more intense odour of breast meat was found in the Konini group against control group. Significantly better chewiness of breast meat was in Konini than control group confirms the results of the Razor Shear Force and Razor Shear Energy.

According to sensory analysis thigh meat had significantly ($p < 0.05$) more intense colour in experimental groups. The control group had significantly lowest rating for this parameter. The Konini group was significantly ($p < 0.05$) more evaluated for thigh meat fibriness parameter compared to control. The thigh meat was significantly ($p < 0.05$) better for chewiness parameter in Konini group versus control group, like as the breast meat.

CONCLUSION

The feeding of wheat with different grain colour had no effect on performance parameters of broiler chickens. The chemical composition of breast and thigh meat was balanced among all three groups. The higher breast meat tenderness was found in control group than in experimental groups according to the Razor Blade Shear Force results. The color change did not significantly differ in all coordinates. In the pH₂ (measured after 1-hour post mortem) there was found significantly higher ($p < 0.05$) value in the Konini group than C and UC groups. The effect of various feeding had no effect on meat quality in terms of relevance to consumers.

REFERENCES

Aviagen Group, 2014. Technological procedure for broiler Ross [online] Aviagen Group 2014 [cit. 2017-01-02] Available at: <http://en.aviagen.com/ross-308>.

Caillet, S., Salmieri, S., Lacroix M. 2006. Evaluation of free radical scavenging properties of commercial grape phenol extracts by a fast colorimetric method. *Food Chemistry*, vol. 95, no. 1, p. 1-8. <https://doi.org/10.1016/j.foodchem.2004.12.011>

Cavitt, L. C., Meullenet, J. F., Xiong, R., Owens, C. M. 2005. The relationship of razor blade shear, Allo-Kramer shear, Warner-Bratzler shear and sensory tests to changes in tenderness of broiler breast fillets. *Journal of Meat Foods*, vol. 16, no. 3, p. 223-242. <https://doi.org/10.1111/j.1745-4573.2005.00001.x>

CIE. 2007. *Colorimetry, part 4: CIE 1976 L*a*b* Colour space*. CIE Central Bureau, Vienna, CIE DS 014-4.3/E:2007.

Garg, M., Chawla, M., Chunduri, V., Kumar, R., Sharma, S., Sharma, N. K., Kaur, N., Kumar, A., Munday, J. K., Saini, M. K., Singh, S. P. 2016. Transfer of grain colors to elite wheat cultivars and their characterization. *Journal of Cereal Science*, vol. 71, no. 1, p. 138-144. <https://doi.org/10.1016/j.jcs.2016.08.004>

Haščík, P., Trembecká, L., Bobko, M., Kačániová, M., Čuboň, J., Kunová, S., Bučko, O. 2016. Effect of diet supplemented with propolis extract and probiotic additives on performance, carcass characteristics and meat composition of broiler chickens. *Potravinarstvo*, vol. 10, no. 1, p. 223-231. <https://doi.org/10.5219/581>

Choia, Y., Jeonga, H., Lee, J. 2007. Antioxidant activity of methanolic extracts from some grains consumed in Korea. *Food Chemistry*, vol. 103, no. 1, p. 130-138. <https://doi.org/10.1016/j.foodchem.2006.08.004>

ISO 8586-1. 2015. *Sensory analysis – General guidelines for the selection, training and monitoring of selected assessors and expert sensory assessors (in Czech)*.

Karasek, F., Mrkvicova, E., Stastnik, O., Trojan, V., Hrivna, L., Mrazkova, E. 2014. The influence of colored wheat Konini feeding on antioxidant activity parameters in rats. In *Proceeding of the International PhD Student Conference MendelNet 2014*. Brno : Mendel University in Brno, pp. 160-162.

Kasapidou, E., Sossidou, E. N., Zdragas, A., Papadaki, C., Vafeas, G., Mitlianga, P. 2016. Effect of grape pomace supplementation on broiler meat quality characteristics. *European Poultry Science*, vol. 80, no. 135, p. 1-12.

Li, W. D., Sun, S. C., Ren, G. X. 2004. Study on characteristic of black wheat and its exploitation and utilization. *China Condiment*, vol. 1, p. 9-11.

Lichovnikova, M., Kalhotka, L., Adam, V., Klejdus, B., Anderle, V. 2015. The effects of red grape pomace inclusion in grower diet on amino acid digestibility, intestinal microflora, and sera and liver antioxidant activity in broilers. *Turkish Journal of Veterinary and Animal Sciences*, vol. 39, no. 4, p. 406-412. <https://doi.org/10.3906/vet-1403-64>

Mareš, J., Brabec, T., Vyhnánek, T., Trojan, V., Šťasna, K., Presinszká, M., Mrkvicová, E., Hřivna, L., Havel, L. 2015. The effect of feeding wheat with purple pericarp on the growth of carp. *Potravinarstvo*, vol. 9, no. 1, p. 262-267.

Mrkvicová, E., Pavlata, L., Karásek, F., Šťastník, O., Doležalová, E., Trojan, V., Vyhnánek, T., Hřivna, L., Holeksová, V., Mareš, J., Brabec, T., Horký, P., Ruttkay-Nedecký, B., Adam, V., Kizek, R. 2016. The influence of feeding purple wheat with higher content of anthocyanins on antioxidant status and selected enzyme activity of animals. *Acta Veterinaria Brno*, vol. 85, no. 4, p. 371-376. <https://doi.org/10.2754/avb201685040371>

Meullenet, J. F., Jonville, E., Grezes, D., Owens, C. M. 2004. Prediction of the texture of cooked poultry pectoralis major meats by near-infrared reflectance analysis of raw meat. *Journal of Texture Studies*, vol. 35, no. 6, p. 573-585. <https://doi.org/10.1111/j.1745-4603.2004.35510.x>

Pop, I. M., Pascariu, S. M., Simeanu, D. 2015. The grape pomace influence on the broiler chickens growing rate. *Lucrări Științifice-Universitatea de Științe Agricole și Medicină Veterinară, Seria Zootehnie*, vol. 64, no. 1, p. 34-39.

Prior, R. L., Wu, X. 2006. Anthocyanins: Structural characteristics that result in unique metabolic patterns and biological activities. *Free Radical Research*, vol. 40, no.10, p. 1014-1028. <https://doi.org/10.1080/10715760600758522> PMID:17015246

Ruckschloss, E., Matúšková, K., Hanková, A., Jančík, D. 2010. Influence of winter wheat with purple colour of the corn on laying hens' efficiency and eggs quality. *Potravinarstvo*, vol. 4, Special issue, February 2010, p. 231-235. Available at:

http://www.potravinarstvo.com/dokumenty/mc_februar_2010/pdf/2/Ruckschloss.pdf

Saláková, A. 2012. Instrumental measurement of texture and color of meat and meat products. *Maso International Brno*, vol. 2, no. 2, p. 107-114.

Starčević, K., Krstulović, L., Brozić, D., Maurić, M., Stojević, Z., Mikulec, Ž., Bajić, M., Mašek, T. 2015. Production performance, meat composition and oxidative susceptibility in broiler chicken fed with different phenolic compounds. *Journal of the Science of Food and Agriculture*, vol. 95, no. 6, p. 1172-1178. <https://doi.org/10.1002/jsfa.6805> PMID:24995966

Stastnik, O., Mrkvicova, E., Karasek, F., Trojan, V., Vyhnanek, T., Hrivna, L., Jakubcova, Z. 2014. The influence of colored wheat feeding on broiler chickens performance parameters. In *Proceeding of the International PhD Student Conference MendelNet 2014*. Brno: Mendel University in Brno, pp. 196-198.

Šťastník, O., Jůzl, M., Karásek, F., Štenclová, H., Nedomová, Š., Pavlata, L., Mrkvicová, E., Doležal, P., Jarošová, A. 2016. The effect of feeding milk thistle seed cakes on quality indicators of broiler chickens meat. *Potravinarstvo*, vol. 10, no. 1, p. 248-254. <https://doi.org/10.5219/579>

Valous, N. A., Mendoza, F., Sun, D. W., Allen, P. 2009. Colour calibration of a laboratory computer vision system for quality evaluation of pre-sliced hams. *Meat Science*, vol. 81, no. 1, p. 132-141. <https://doi.org/10.1016/j.meatsci.2008.07.009> PMID:22063973

Varga, M., Bánhidý, J., Cseuz, L., Matuz, J. 2013. The anthocyanin content of blue and purple coloured wheat cultivars and their hybrid generations. *Cereal Research Communications*, vol. 41, no. 2, p. 284-292. <https://doi.org/10.1556/CRC.41.2013.2.10>

Wideman, N., O'Bryan, C. A., Crandall, P. G. 2016. Factors affecting poultry meat colour and consumer preferences - A review. *Worlds Poultry Science Journal*, vol. 72, no. 2, p. 353-366. <https://doi.org/10.1017/S0043933916000015>

Yang, M. Y., Peng, C. H., Chan, K. C., Yang, Y. S., Huang, C. N., Wang, C. J. 2009. The hypolipidemic effect of Hibiscus sabdariffa polyphenols via inhibiting lipogenesis and promoting hepatic lipid clearance. *Journal of agricultural and food chemistry*, vol. 58, no. 2, p. 850-859. <https://doi.org/10.1021/jf903209w> PMID:20017484

Zelenka, J., Heger, J., Zeman, L. 2007. *Recommended nutrient content in poultry diets and nutritive value of feeds*

for poultry (in Czech). Brno: MZLU. 77 p. ISBN 978-80-7375-091-6.

Zeven, A. C. 1991. Wheats with purple and blue grains: a review. *Euphytica*, vol. 56, no. 3, p. 243-258. <https://doi.org/10.1007/BF00042371>

Acknowledgments:

The research was financially supported by the project NAZV QJ1510206.

Contact address:

Ondřej Šťastník, Mendel University in Brno, Faculty of AgriSciences, Department of Animal Nutrition and Forage Production, Zemědělská 1, 613 00 Brno, Czech Republic, E-mail: ondrej.stastnik@mendelu.cz

Filip Karásek, Mendel University in Brno, Faculty of AgriSciences, Department of Animal Nutrition and Forage Production, Zemědělská 1, 613 00 Brno, Czech Republic, E-mail: karasek89@seznam.cz

Miroslav Jůzl, Mendel University in Brno, Faculty of AgriSciences, Department of Food Technology, Zemědělská 1, 613 00 Brno, Czech Republic, E-mail: miroslav.juzl@mendelu.cz

Eva Mrkvicová, Mendel University in Brno, Faculty of AgriSciences, Department of Animal Nutrition and Forage Production, Zemědělská 1, 613 00 Brno, Czech Republic, E-mail: eva.mrkvicova@mendelu.cz

Leoš Pavlata, Mendel University in Brno, Faculty of AgriSciences, Department of Animal Nutrition and Forage Production, Zemědělská 1, 613 00 Brno, Czech Republic, E-mail: leos.pavlata@mendelu.cz

Šárka Nedomová, Mendel University in Brno, Faculty of AgriSciences, Department of Food Technology, Zemědělská 1, 613 00 Brno, Czech Republic, E-mail: sarka.nedomova@mendelu.cz

Václav Trojan, Mendel University in Brno, Faculty of AgriSciences, Department of Plant Biology, Zemědělská 1, 613 00 Brno, Czech Republic, E-mail: vaclav.trojan@mendelu.cz

Tomáš Vyhnanek, Mendel University in Brno, Faculty of AgriSciences, Department of Plant Biology, Zemědělská 1, 613 00 Brno, Czech Republic, E-mail: tomas.vyhnanek@mendelu.cz

Petr Doležal, Mendel University in Brno, Faculty of AgriSciences, Department of Animal Nutrition and Forage Production, Zemědělská 1, 613 00 Brno, Czech Republic, E-mail: petr.dolezal@mendelu.cz

Petr Martinek, Agrotest fyto, s.r.o., Havlíčková 2787/121, 767 01 Kroměříž, Czech Republic, E-mail: martinek@vukrom.cz



EFFECT OF SHORT-TERM CONSUMPTION BITTER APRICOT SEEDS ON THE BODY COMPOSITION IN HEALTHY POPULATION

Jana Kopčeková, Anna Kolesárová, Martina Gažarová, Petra Lenártová, Jana Mrázová, Adriana Kolesárová

ABSTRACT

The distribution of fat in different areas of the body is important since accumulation of fat within the abdominal cavity represents a much more severe cardiovascular risk than accumulation in subcutaneous adipose tissues. Apricot seeds contain a wide variety of bioactive compounds and that consumption can decrease blood pressure and total blood cholesterol levels, fight oxidative stress and maintain body weight. The aim of the study was to analyse body composition: body fat mass (BFM), fat free mass (FFM), skeletal muscle mass (SMM), body fat percentage (%BFM), visceral fat area (VFA), total body water (TBW) – intracellular water (ICW) and extracellular water (ECW) and to evaluate the changes that occur after 6-weeks consumption of bitter apricot seeds. The study group finally consisted of 34 healthy adults volunteers (21 females and 13 males). Volunteers were recruited from the general population of Slovakia. Respondents were 23 – 65 years old, where the average age of women was 40.65 ± 11.31 years and the average age of men was 36.91 ± 9.98 years. All participants were asked to consume $60 \text{ mg} \cdot \text{kg}^{-1}$ of body weight of bitter apricot seeds daily during 6 weeks. Body composition was diagnosed by multi-frequency bioelectrical impedance analysis (MFBIA) by InBody 720 (Biospace Co., Korea), which measures the total impedance at frequencies of 1, 5, 50, 100, 500, 1000 kHz. At baseline mean body weight was 85.78 ± 14.66 and 62.84 ± 12.19 kg in the male and female participants, respectively. After 6 weeks of consumption we observed non-significant decreasing of mean body weight. The mean BFM was 19.25 ± 8.81 kg in the male group and 19.47 ± 7.21 kg in the female group. After six weeks, BFM decreased non-significantly (on average 0.5 kg) in both groups. The mean FFM at baseline was 43.37 ± 5.98 and 66.54 ± 7.98 kg in the female and male participants, respectively. The statistical analysis confirmed that the increase of FFM (43.37 ± 5.98 kg to 43.56 ± 5.80 kg) in the female were statistically significant ($p < 0.05$). VFA was greater in the men ($82.04 \pm 39.82 \text{ cm}^2$ at baseline and $78.65 \pm 39.79 \text{ cm}^2$ after 6 weeks) comparison to women ($79.82 \pm 29.03 \text{ cm}^2$ at baseline and $78.29 \pm 29.90 \text{ cm}^2$ after 6 weeks). The mean of TBW in males before the start of study was 48.78 ± 5.77 kg and 47.88 ± 5.57 kg after 6 weeks of consumption. The results of study show the small weight loss in the both group. Therefore, the results from this study indicate that daily consumption of bitter apricot seeds produce measurable health benefits, but further studies are also required.

Keywords: cardiovascular diseases; bitter apricot seeds; body fat; visceral adipose tissue; bioelectrical impedance

INTRODUCTION

The incidence of cardiovascular diseases (CVD) is rapidly increasing worldwide and is currently considered to be the leading cause of death in both developing and developed countries (Gaziano et al., 2010; Mittal et al., 2010). In Europe, cardiovascular diseases are responsible for 43% of deaths in men and 55% in women and for 30% of all deaths before the age of 65 years. Eighty percent of cardiovascular accidents could probably be avoided by lifestyle adjustment (weight control, smoking abstinence, physical activity, and a healthy diet), together with proper management of clinical and biological risk factors (Carpentier and Komsa-Penkova, 2011). There is a growing interest of natural products in human diet, both due to the possible negative effects of synthetic food additives on human health and to the increased consumer

perception of this problem in recent years (Yurt and Celik, 2011). In addition, a great number of spices and aromatic herbs contain chemical compounds exhibiting antioxidant properties. These properties are attributed to a variety of active phytochemicals including vitamins, carotenoids, terpenoids, alkaloids, flavonoids, lignans, simple phenols and phenolic acids, and so on (Liu and Ng, 2000). Apricot seeds contain a wide variety of bioactive compounds and that consumption of apricot seeds has been associated with a reduced risk of chronic diseases (Zhang et al., 2011). Diet rich in these compounds can decrease blood pressure and total blood cholesterol levels, fight oxidative stress and maintain body weight (Turan et al., 2007). Subhashinee et al. (2006) evaluated the antioxidant properties of apricot seeds by several chemical and biochemical assays. The apricot fruit is a member of

the *Rosaceae* family and planted commercially throughout Eurasia and America (Lim, 2012). The fruit seeds of apricot trees are classified according to their taste into sweet apricot, semi-bitter apricot and bitter apricot (Lee et al., 2013). Bitter apricot seeds have long been used in Chinese traditional medicine for the treatment of asthma, bronchitis, emphysema, constipation, nausea, leprosy, leucoderma and pain (Bensky et al., 2004). In addition, bitter apricot seeds have been used for treating several skin diseases, and these include furuncle, acne vulgaris, dandruff and several others (Lee et al., 2014). The use of apricot seeds for human nutrition is limited because of their content of the toxic, cyanogenic glycoside amygdalin, accompanied by minor amounts of prunasin (Gomez et al., 1998). Bitter apricot seeds have high contents of amygdalin (equivalent total cyanide content up to 4000 mg.kg⁻¹ (Zöllner and Giebelmann, 2007). Obesity has been increasing in epidemic proportions in both adults and children over many decades, and recently, the proportion of the population with more severe, or morbid obesity has increased to a greater extent than has overweight and mild obesity (Sturm, 2007). Obesity and obesity-related disorders are a major health problem worldwide (Charakida et al., 2012). Each of these disorders, in addition to established vascular risk factors (dyslipidaemia, smoking and hypertension) increases the risk of cardiovascular and other metabolic diseases (Brunzell et al., 2008). The distribution of fat in different areas of the body is important since accumulation of fat within the abdominal cavity represents a much more severe cardiovascular risk than accumulation in subcutaneous adipose tissues (Poirier et al., 2006). The Body Mass Index (BMI) is a basic indicator enabling us to classify obesity and associated risks. When the BMI value exceeds 30 kg.m⁻², the person is regarded to be obese. The evaluation of obesity by means of BMI as inadequate because this index does not allow for involving the variability and changes in the proportions of fat free mass (FFM) and body fat mass (BFM) (Gába et al., 2009; Koycu et al., 2016). Therefore, the purpose of the study was to analyse body composition: body fat mass (BFM), fat free mass (FFM), skeletal muscle mass (SMM), body fat percentage (% BFM), visceral fat area (VFA), total body water (TBW) – intracellular water (ICW) and extracellular water (ECW) and to evaluate the changes that occur after 6-weeks consumption of bitter apricot seeds.

MATERIAL AND METHODOLOGY

Participants and study design

The study group finally consisted of 34 healthy adult volunteers (21 females and 13 males). Volunteers were recruited from the general population of Slovakia. Respondents were 23 – 65 years old, where the average age of women was 40.65 ± 11.31 years and the average age of men was 36.91 ± 9.98 years. A written informed consent to participate in the study was provided to all subjects involved in the study after they were informed of all risks, discomforts and benefits. The study was performed from September to December 2015. The trial was approved by the Ethic Committee at the Specialized Hospital St. Zorardus Zobor, n. o., protocol number 030809/2015.

Intervention

All participants were asked to consume 60 mg.kg⁻¹ of body weight of bitter apricot seeds (TRASCO, Žiar nad Hronom, Slovakia) daily during 6 week period. Volunteers were instructed as follows: not to change their usual diet, to consume approximately one seed each hour, seeds had to be chewed as thoroughly as possible, after each consumption drink a lot of water. Subject were measured in the morning after 12-h fasting at baseline, week 3 and 6. Hence, each individual was a sample unit for a paired study before and after the intervention. There was no overall separate control group because as a paired study, the baseline values of the participants served as their own control.

Anthropometric measurement

Body composition was diagnosed by multi-frequency bioelectrical impedance analysis (MFBIA) by InBody 720 (Biospace Co., Korea), which measures the total impedance at frequencies of 1, 5, 50, 100, 500, 1000 kHz and device that differentiates body weight into 3 components – total body water (intracellular and extracellular), dry mass (proteins and minerals) and body fat.

Total body impedance values were calculated by summing the segmental impedance values that were analysed separately with a tetrapolar eight-point tactile electrode system. Body height was measured on the outpatient electronic medical scales Tanita WB-300 in the standing upright position, without shoes. The measurement was performed under laboratory conditions according to user manual instructions (Biospace, 2008). The procedure took approximately 2 minutes (research mode was activated) and it required no specific skills. Before the measurements were taken, the participant's identification number, name and surname, body height, age and sex were entered into the manufacturer's software, Lookin' Body, version 3.0 (Biospace Co., Ltd.; Seoul, Korea). If possible, the subjects were asked to fast for 2 h, to avoid any vigorous physical activity for at least 48 h before the procedure. Visceral adipose tissue was represented by the visceral fat area (VFA; cm²), which was defined as a cross-sectional area of visceral fat in the abdomen at the umbilical level. Visceral fat is defined by the cross sectional area of the abdomen at the level of L4-L5. The correlation between the Computer Tomography and InBody 720 is set at r = 0.92. The obtained data were adequately processed by Lookin' Body 3.0, ActiPA 2006 software.

Statistical analyses

The results were evaluated with appropriate standard mathematical-statistical methods and were listed in the tables. We used the program STATISTICA Cz version 10 belonging to the available statistical programs and MS Excel 2007.

All data were expressed as the mean ± standard deviation (SD), and differences between control were determined using Pared Student *t*-test. Differences from control at *p* < 0.05 were considered as significant.

RESULTS AND DISCUSSION

The mean age of the study sample was 40.65 ±11.31 years of women and the mean age of men was 36.91 ±9.98 years. Body weight and height are the simplest, most accessible measurements of body size and are generally reliable with small technical errors of measurements. Thus, they have become important and extensively used epidemiological research tools. However, it is clear they cannot provide information on body composition (Williams et al., 1997). The mean body height of the women was 164.81 ±5.62 cm and 177.00 ±5.82 cm of men. At baseline mean body weight was 85.78 ±14.66 and 62.84 ±12.19 kg in the male and female participants, respectively. At week 6 we observed non-significant decreasing of mean body weight (Table 1, 2).

Although the amount of BFM is caused by genetic factors (Böttcher et al., 2012), it is influenced by non-genetic factors, such as physical inactivity (Pelclová et al., 2012) combined with an increased intake of energy-dense foods that are high in lipids or carbohydrates. The amount of BFM usually increases throughout the lifespan. The standard BFM is 15% for males and 23% for females, which are the respective midpoints of the standard ranges of body fat mass in relation to standard weight: 10 – 20% of the standard weight for males and 18 – 28% for females.

The mean BFM was 19.25 ±8.81 kg in the male group and 19.47 ±7.21 kg in the female group. After six weeks, BFM decreased non-significantly (on average 0.5 kg) in both groups. Fifty percent of men had % BFM greater than 20.00% (range 10.00 – 20.00%). More than 70% of women had % BFM greater than 28.00% (range 18.00 – 28.00) and we found statistically significant

decrease in % BFM (30.26 ±5.92 to 29.36 ±6.09) ($p < 0.05$). According to Heyward and Wagner (2004) the optimal percentage of body fat in the male population older than 55 is 10 – 16%, respectively 25 – 35% in women.

FFM usually increases as humans grow, remains relatively stable throughout maturity and declines during senescence. Generally, FFM peaks between the fourth and fifth decades of life (Borrud et al., 2010), occasionally earlier, and then declines slightly. The decrease in FFM primarily occurs as a result of losses in muscle mass, component of FFM, and is considered the most constant marker of aging. Moreover, the decline in muscle strength caused by the loss of muscle mass contributes to the decline in physical function, as well as increasing disability, frailty and loss of independence (Taaffe, 2006).

The mean FFM at baseline was 43.37 ±5.98 and 66.54 ±7.98 kg in the female and male participants, respectively. The statistical analysis confirmed that the increase in FFM (43.37 ±5.98 kg to 43.56 ±5.80 kg) in the female were statistically significant ($p < 0.05$).

Visceral adipose tissue (VAT) has been cross-sectionally associated with cardiovascular disease and cancer (Mahabadi et al., 2009) and is correlated with smaller ectopic fat depots, including pericardial and periaortic fat, which surround the cardiovascular system and may exert local toxic effects (Greenstein et al., 2009). In contrast to prior studies of BMI and waist circumference, visceral adiposity modestly improved CVD risk prediction (Britton et al., 2013). We observed non-significantly reduction of total visceral fat, expressed by VFA (cm²) in both groups. VFA was higher in the men (82.04 ±39.82 cm² at baseline and 78.65 ±39.79 cm² at

Table 1 Changes in body composition of women after consumption of bitter apricot seeds.

Parameter	week 0			week 6			P
	mean ±SD	min	max	mean ±SD	min	max	
BW (kg)	62.84 ±12.19	45.80	104.10	62.38 ±12.23	45.40	105.90	0.9223
BFM (kg)	19.47 ±7.21	9.50	42.10	18.82 ±7.40	9.60	43.30	0.1575
BFM (%)	30.26 ±5.92	20.43	40.63	29.36 ±6.09	18.75	40.88	0.0546
FFM (kg)	43.37 ±5.98	36.30	62.00	43.56 ±5.80	35.80	62.60	0.0391
VFA (cm ²)	79.82 ±29.03	42.89	170.25	78.29 ±29.90	42.91	176.56	0.6374
SMM (kg)	23.66 ±3.55	19.41	34.60	23.77 ±3.46	19.19	35.01	0.0318
TBW (kg)	31.77 ±4.36	26.80	45.40	31.94 ±4.23	26.40	45.90	0.0309
ICW (kg)	19.68 ±2.73	16.40	28.10	19.76 ±2.65	16.20	28.40	0.0350
ECW (kg)	12.09 ±1.64	10.40	17.30	12.18 ±1.59	10.20	17.50	0.0515

Note: Each value represents the Mean ±SD.

Pared Student *t*-test between 0 week and after the 6-week.

Table 2 Changes in body composition of men after consumption of bitter apricot seeds.

Parameter	week 0			week 6			P
	mean ±SD	min	max	mean ±SD	min	max	
BW (kg)	85.78 ±14.66	64.30	109.8	83.88 ±13.78	64.4	110.70	0.7303
BFM (kg)	19.25 ±8.81	6.30	33.10	18.60 ±8.95	6.5	35.30	0.2495
BFM (%)	21.60 ±7.25	9.79	36.21	21.33 ±7.66	10.05	38.05	0.2539
FFM (kg)	66.54 ±7.98	53.20	79.60	65.28 ±7.66	52.4	77.90	0.1830
VFA (cm ²)	82.04 ±39.82	22.03	144.13	78.65 ±39.79	23.49	154.42	0.2803
SMM (kg)	37.40 ±4.88	29.29	46.17	37.22 ±4.70	29.4	45.09	0.1417
TBW (kg)	48.78 ±5.77	39.10	58.10	47.88 ±5.57	38.5	57.10	0.2051
ICW (kg)	30.70 ±3.74	24.50	36.90	30.08 ±3.59	24.1	36.10	0.1298
ECW (kg)	18.10 ±2.05	14.60	21.20	17.80 ±2.01	14.4	21.30	0.3759

Note: Each value represents the Mean ±SD.

Pared Student *t*-test between 0 week and after the 6-week.

after 6 weeks) comparison to women (79.82 ±29.03 cm² at baseline and 78.29 ±29.90 cm² at the end). Regardless of general obesity, abdominal obesity and excess visceral fat have been identified as independent risk factors for cardiovascular diseases (DeLorenzo et al., 2007; Hamdy, 2005; Wisse, 2004).

Intracellular water (ICW) indicates the amount of water within the cellular membrane. Extracellular water (ECW) indicates the total amount of water in the interstitial fluid and blood.

The mean of TBW in males before the start of study was 48.78 ±5.77 kg and 47.88 ±5.57 kg after 6 weeks of consumption. ECW and ICW decreased non-significantly (extracellular: 18.10 ±2.05 kg vs. 17.80 ±2.01 kg; intracellular: 30.70 ±3.74 kg vs. 30.08 ±3.59 kg). In the group of women, we found significant increase in all parameters: TBW (31.77 ±4.36 vs. 31.94 ±4.23), ECW (12.09 ±1.64 vs. 12.18 ±1.59), ICW (19.68 ±2.73 vs. 19.76 ±2.65) (*p* <0.05). The benefits and importance of an appropriate hydration for health and performance are well known with total body water (TBW) being comprised of both intracellular (ICW) and extracellular (ECW) with a flux existing between the two (Matias et al., 2016).

CONCLUSION

The current study was limited in a number of ways that deserve careful attention: for example, the study population was relatively small, and this could be the main reason why significant differences for many of the parameters assessed in this study were not detected. The results of study show the small weight loss in the both group. Therefore, the results from this study indicate that daily consumption of bitter apricot seeds produce measurable health benefits, but further studies are also required.

REFERENCES

Bensky, D., Clavey, E., Stöger, E. 2004. *Chinese Herbal Medicine: Materia Medica*. 3rd ed. Seattle : Eastland Press. p. 437-440. ISBN-13: 978-0939616824.

Borud, L. G., Flegal, K. M., Looker, A. C., Everhart, J. E., Harris, T. B., Shepherd, J. A. 2010. Body composition data for individuals 8 years of age and older: U.S. population, 1999 – 2004. *Vital and Health Statistics Series*, vol. 250, no. 11, p. 1-87.

Böttcher, Y., Körner, A., Kovacs, P., Kiess, W. 2012. Obesity genes: implication in childhood obesity. *Paediatrics and Child Health*, vol. 22, no. 1, p. 31-36. <https://doi.org/10.1016/j.paed.2011.08.009>

Britton, K. A., Massaro, J. M., Murabito, J. M., Kreger, B. E., Hoffmann, U., Fox, C. S. 2013. Body fat distribution, incident cardiovascular disease, cancer, and all-cause mortality. *Journal of the American College of Cardiology*, vol. 62, no. 10, p. 921-925. <https://doi.org/10.1016/j.jacc.2013.06.027> PMID:23850922

Brunzell, J. D., Davidson, M., Furberg, C. D., Goldberg, R. B., Howard, B. V., Stein, J. H., Witztum, J. L. 2008. Lipoprotein management in patients with cardiometabolic risk: Consensus conference report from the American Diabetes Association and the American College of Cardiology Foundation. *Journal of the American College of Cardiology*, vol. 51, no. 15, p. 1512-1524.

<https://doi.org/10.1016/j.jacc.2008.02.034>
PMid:18402913

Charakida, M., Finer, N. 2012. Drug treatment of obesity in cardiovascular disease. *American Journal of Cardiovascular Drugs*, vol. 12, no. 2, p. 93-104. <https://doi.org/10.2165/11599000-000000000-00000> PMID:22292446

Carpentier, Y. A., Komsa-Penkova, R. S. 2011. Clinical Nutrition University. The place of nutrition in the prevention of cardiovascular diseases (CVDs). *European e-Journal of Clinical Nutrition and Metabolism*, vol. 6, no. 6, p. 272-282. <https://doi.org/10.1016/j.eclnm.2011.10.002>

DeLorenzo, A., DelGobbo, V., Bigioni, M., Galvano, F., DiRenzo, L. 2007. Normal-weight obese syndrome: early inflammation? *American Journal of Clinical Nutrition*, vol. 85, no. 1, p. 40-45.

Gaziano, T. A., Bitton, A., Anand, S., Abrahams-Gessel, S., Murphy, A. 2010. Growing epidemic of coronary heart disease in low- and middle-income countries. *Current Problems in Cardiology*, vol. 35, no. 2, p. 72-115. <https://doi.org/10.1016/j.cpcardiol.2009.10.002>

Gába, A., Pelclová, J., Přidalová, M., Riegerová, J., Dostálová, I., Engelová, E. 2009. The evaluation of body composition in relation to physical activity in 56-73 y. old women: A Pilot study. *Acta Universitatis Palackianae Olomucensis. Gymnica*, vol. 39, no. 3, p. 21-30.

Gomez, E., Burgos, L., Soriano, C. 1998. Amygdalin content in the seeds of several apricot cultivars. *Journal of the Science of Food and Agriculture*, vol. 77, no. 2, p. 184-186. [https://doi.org/10.1002/\(SICI\)1097-0010\(199806\)77:2<184::AID-JSFA22>3.0.CO;2-H](https://doi.org/10.1002/(SICI)1097-0010(199806)77:2<184::AID-JSFA22>3.0.CO;2-H)

Greenstein, A. S., Khavandi, K., Withers, S. B., Sonoyama, K., Clancy, O., Jeziorska, M., Laing, I., Yates, A. P., Pemberton, P. W., Malik, R. A. Heagerty, A. M. 2009. Local inflammation and hypoxia abolish the protective anticontractile properties of perivascular fat in obese patients. *Circulation*, vol. 119, no. 12, p. 1661-1670. <https://doi.org/10.1161/CIRCULATIONAHA.108.821181>

Hamdy, O. 2005. The role of adipose tissue as an endocrine gland. *Current Diabetes Reports*, vol. 5, no. 5, p. 317-319. <https://doi.org/10.1007/s11892-005-0086-0>

Heyward, V. H., Wagner, D. R. 2004. *Applied body composition assessment*. 2nd ed. Champaign, IL : Human Kinetics. 280 p. ISBN-13: 9780736046305.

Koycu, A., Aydin, E., Kinik, S. T. 2016. Changes in body composition and growth pattern after adenotonsillectomy in prepubertal children. *International Journal of Pediatric Otorhinolaryngology*, vol. 81, p. 46-50. <https://doi.org/10.1016/j.ijporl.2015.12.005> PMID:26810289

Lee, H. H., Ahn, J. H., Kwon, E. S., Lee, J. H., Min, Y. H. 2014. Chemical composition and antimicrobial activity of the essential oil of apricot seeds. *Phytotherapy Research*, vol. 28, no. 12, p. 1867-1872. <https://doi.org/10.1002/ptr.5219> PMID:25219371

Lee, J., Zhang, G., Wood, E., Castillo, C., Mitchell, A. E. 2013. Quantification of amygdalin in nonbitter, semibitter, and bitter almonds (*Prunus dulcis*) by UHPLC-(ESI)QqQ MS/MS. *Journal of Agricultural and Food Chemistry*, vol. 61, no. 32, p. 7754-7759. <https://doi.org/10.1021/jf402295u> PMID:23862656

Lim, T. 2012. *Prunus armeniaca, Edible Medicinal and Non-medicinal Plants (Volume 4, Fruits)*. Netherlands : Springer. p. 442-450. ISBN 978-94-007-4052-5.

Liu, F., Ng, T. B. 2000. Antioxidative and free radical scavenging activities of selected medicinal herbs. *Life*

Sciences, vol. 66, no. 8, p. 725-735.

[https://doi.org/10.1016/S0024-3205\(99\)00643-8](https://doi.org/10.1016/S0024-3205(99)00643-8)

Mahabadi, A. A., Massaro, J. M., Rosito, G. A., Levy, D., Murabito, J. M., Wolf, P. A., O'Donnell, C. J., Fox, C. S., Hoffmann, U. 2009. Association of pericardial fat, intrathoracic fat, and visceral abdominal fat with cardiovascular disease burden: the Framingham Heart Study. *European Heart Journal*, vol. 30, no. 7, p. 850-856. <https://doi.org/10.1093/eurheartj/ehn573>

Matias, C. N., Santos, D. A., Júdice, P. B., Magalhães, J. P., Minderico, C. S., Fields, D. A., Lukaski, H. C., Sardinha, L. B., Silva, A. M. 2016. Estimation of total body water and extracellular water with bioimpedance in athletes: A need for athlete-specific prediction models. *Clinical Nutrition*, vol. 35, no. 2, p. 468-474. <https://doi.org/10.1016/j.clnu.2015.03.013> PMID:25886709

Mittal, B. V., Singh, A. K. 2010. Hypertension in the developing world: challenges and opportunities. *American Journal of Kidney Diseases*, vol. 55, no. 3, p. 590-598. <https://doi.org/10.1053/j.ajkd.2009.06.044> PMID:19962803

Pelclová, J., Gába, A., Tlučáková, L., Pospiech, D. 2012. Association between physical activity (PA) guidelines and body composition variables in middle-aged and older women. *Archives of Gerontology and Geriatrics*, vol. 55, no. 2, p. 14-20. <https://doi.org/10.1016/j.archger.2012.06.014> PMID:22819080

Poirier, P., Giles, T. D., Bray, G. A., Hong, Y., Stern, J. S., Pi-Sunyer, F. X., Eckel, R. H. 2006. Obesity and cardiovascular disease: pathophysiology, evaluation, and effect of weight loss. *Arteriosclerosis Thrombosis and Vascular Biology*, vol. 26, no. 5, p. 968-976. <https://doi.org/10.1161/01.ATV.0000216787.85457.f3> PMID:16627822

Sturm, R. 2007. Increases in morbid obesity in the USA: 2000-05. *Public Health*, vol. 121, no. 7, p. 492-496. <https://doi.org/10.1016/j.puhe.2007.01.006> PMID:17399752

Subhashinee, S. K. Wijeratne, Mamdouh, M. Abou-Zaid, Fereidoon, S. 2006. Antioxidant Polyphenols in Almond and Its Coproducts. *Journal of Agricultural and Food Chemistry*, vol. 54, no. 2, p. 312-318. <https://doi.org/10.1021/jf051692j> PMID:16417285

Taaffe, D. R. 2006. Sarcopenia – exercise as a treatment strategy. *Australian Family Physician*, vol. 35, no. 3, p. 130-134. PMID:16525526

Turan, S., Topcu, A., Karabulut, I., Vural, H. Hayaloglu, A. 2007. Fatty acids, triacylglycerol, phytosterol, and tocopherol variations in kernel oil of Malatya apricots from Turkey. *Journal of Agricultural and Food Chemistry*, vol. 55, no. 26, p. 10787-10794. <https://doi.org/10.1021/jf071801p> PMID:18038980

Williams, S. R. P., Jones, E., Bell, W., Davies, B., Bourne, M. W. 1997. Body habitus and coronary heart disease in men. *European Heart Journal*, vol. 18, p. 376-393. <https://doi.org/10.1093/oxfordjournals.eurheartj.a015258> PMID:9076375

Wisse, B. E. 2004. The inflammatory syndrome: the role of adipose tissue cytokines in metabolic disorders linked to obesity. *Journal of the American Society of Nephrology*, vol. 15, no. 11, p. 2792-2800. <https://doi.org/10.1097/01.ASN.0000141966.69934.21> PMID:15504932

Yurt, B., Celik, I. 2011. Hepatoprotective effects and antioxidant role of sun, sulphited-dried apricot (*Prunus armeniaca* L.) and its kernel against ethanol-induced oxidative stress in rats. *Food and Chemical Toxicology*, vol. 49, no. 2, p. 508-513. <https://doi.org/10.1016/j.fct.2010.11.035> PMID:21115094

Zhang, J., Gu, H. D., Zhang, L., Tian, Z. J., Zhang, Z. Q., Shi, X. C., Ma, W. H. 2011. Protective effects of apricot kernel oil on myocardium against ischemia-reperfusion injury in rats. *Food and Chemical Toxicology*, vol. 49, no. 12, p. 3136-3141. <https://doi.org/10.1016/j.fct.2011.08.015> PMID:21896302

Zöllner, H., Giebelmann, R. 2007. Cyanogenic glycosides in food-Cultural historical remarks. *Deutsche Lebensmittel-Rundschau*, vol. 103, no. 2, p. 71-77.

Acknowledgments:

This paper was supported by the research project APVV-0304-12, VEGA 1/0039/16, ITEBIO (ITMS 26220220115).

Contact address:

Ing. Jana Kopčeková, PhD., Slovak University of Agriculture in Nitra, Department of Human Nutrition, Faculty of Agrobiological and Food Resources, Tr. A. Hlinku 2, 949 76 Nitra, E-mail: Jana.Kopcekkova@uniag.sk

Ing. Anna Kolesárová, PhD., Slovak University of Agriculture in Nitra, Department of Storing and Processing of Plant Products, Faculty of Biotechnology and Food Sciences, Tr. A. Hlinku 2, 949 76 Nitra, E-mail: Anna.Kolesarova@uniag.sk

Ing. Martina Gažarová, PhD., Slovak University of Agriculture in Nitra, Department of Human Nutrition, Faculty of Agrobiological and Food Resources, Tr. A. Hlinku 2, 949 76 Nitra, E-mail: Martina.Gazarova@uniag.sk

Ing. Petra Lenártová, PhD., Slovak University of Agriculture in Nitra, Department of Human Nutrition, Faculty of Agrobiological and Food Resources, Tr. A. Hlinku 2, 949 76 Nitra, E-mail: Petra.Lenartova@uniag.sk

RNDr. Jana Mrázová, PhD., Slovak University of Agriculture in Nitra, Department of Human Nutrition, Faculty of Agrobiological and Food Resources, Tr. A. Hlinku 2, 949 76 Nitra, E-mail: Jana.Mrazova@uniag.sk

doc. Ing. Adriana Kolesárová, PhD., Slovak University of Agriculture in Nitra, Department of Animal Physiology, Faculty of Biotechnology and Food Sciences, Tr. A. Hlinku 2, 949 76 Nitra, E-mail: Adriana.Kolesarova@uniag.sk



HORMONAL CHANGES IN SPRING BARLEY AFTER TRIAZINE HERBICIDE TREATMENT AND ITS MIXTURES OF REGULATORS OF POLYAMINE BIOSYNTHESIS

Pavol Trebichalský, Tomáš Tóth, Daniel Bajčan, Ľuboš Harangozo, Alena Vollmannová

ABSTRACT

Plants adapt to abiotic stress by undergoing diverse biochemical and physiological changes that involve hormone-dependent signalling pathways. The effects of regulators of polyamine biosynthesis can be mimicked by exogenous chemical regulators such as herbicide safeners, which not only enhance stress tolerance but also confer hormetic benefits such as increased vigor and yield. The phytohormones, abscisic acid (ABA) and auxin (IAA) play key roles in regulating stress responses in plants. Two years pot trials at Slovak University of agriculture Nitra were carried out with analyses of contents of plant hormones in spring barley grain of variety *Kompakt*: indolyl-acetic acid (IAA) and abscisic acid (ABA), after exposing of tested plants to herbicide stress, as well as the possible decrease of these stress factors with application of regulators of polyamine synthesis was evaluated. At 1st year in spring barley grain after application of solo triazine herbicide treatment in dose 0,5 L.ha⁻¹ an increase of all analyzed plant hormones was observed and contrary, at 2nd year there was the decrease of their contents. From our work there is an obvious influence of herbicide stress induced by application of certain dose of triazine herbicide at 1st year. Expect of the variant with mixture of triazine herbicide (in amount of 0,5 L.ha⁻¹) and 29,6 g.ha⁻¹ DAB, at this year all by us applied regulators of polyamine synthesis reduced the level of both plant hormones. Higher affect of stress caused by enhanced content of soluble macronutrients in soil where the plants of barley were grown was observed next year. Soil with increased contents of macronutrients (mg.kg⁻¹): N_{30.7} + P_{108.3} + K_{261.5} + Mg_{604.2} had reducing effect on contents of plant hormones in barley grain at variant treated with solo triazine herbicide (in dose at 0,5 L.ha⁻¹) in comparison to control variant. The mixtures of regulators of polyamine synthesis reduced the contents of IAA only in comparison to control variant. Decline in amount of ABA in barley grain was observed only after treatment with GABA, also in comparison to variant treated with water. Other mixtures of morphoregulators in combination with herbicide had not strong influence on contents of tested plant hormones in barley grain of variety *Kompakt*.

Keywords: barley; phytohormones; polyamines; herbicide

INTRODUCTION

Herbicides are chemicals used to manage unwanted plants in agriculture and horticulture which are usually referred to as „weeds“ (Piñol, 2011). Most herbicides are compounds that inhibit plant metabolic pathways or physiological processes by interacting with specific proteins (Veliny et al., 2010). The herbicides selectivity is based on the plant's ability to rapidly metabolize the herbicide, forming non-phytotoxic compounds. However, there is a differential selectivity between species, and the genetic makeup of the species or cultivar may determine varying degrees of tolerance or susceptibility to herbicides (Oliveira, et al., 2011). Weed management is an important practice in production systems that seek high productivity

and quality of agricultural products (Fehér et al., 2016). The most widely used weed management method is currently the chemical control because of its convenience and efficiency when compared to other methods (Agostinetto et al., 2016).

The major hormones produced by plants are auxins, gibberellins (GA), cytokinins (CK), abscisic acid (ABA), ethylene (ET), salicylic acid (SA), jasmonates (JA), brassinosteroids (BR) and strigolactones. Among these, ABA, SA, JA and ET are known to play major roles in mediating plant defense response against pathogens and abiotic stresses (Bari and Jones, 2009; Nakashima et al., 2013). Typically, ABA is responsible for plant defense against abiotic stresses because environmental conditions such as drought, salinity, cold, heat stress and wounding

are known to trigger increase in ABA levels (Lata et al., 2011, Verma et al., 2016). Contrastingly, salicylic acid, jasmonates and ethylene play major roles in response to biotic stress conditions as their levels increase with pathogen infection (Bari and Jones, 2009). However, the mechanism of stress-response is not solely restricted to these hormones. Recent studies have provided substantial evidence for the cross-talk of abscisic acid, salicylic acid, jasmonates and ethylene with auxins, gibberellins and cytokinins in regulating plant defense response (Bari and Jones, 2009; Navarro et al., 2008; Nishiyama et al., 2013). The key role of abscisic acid, salicylic acid and jasmonates as primary signals in the regulation of plant defense has been well established (Bari and Jones 2009; Pieterse et al., 2009). These hormones generate a signal transduction network that leads to a cascade of events responsible for the physiological adaptation of the plant to stress (Gaur and Sharma, 2014). The phytohormone ABA modulates many important plant development processes, such as the inhibition of germination, maintenance of seed dormancy, regulation of growth, fruit abscission and stomatal closure (Qin, 2011, Finkelstein et al., 2002, Parent et al., 2009, Raghavendra et al., 2010). In addition, ABA serves as an endogenous messenger in abiotic stress responses in plants; therefore, it is called a 'stress hormone'. Physiological experiments have shown that under abiotic stress, especially drought and salinity, plants accumulate high levels of ABA accompanied by major gene expression changes. The perception, signaling and transportation of ABA are some of the most central issues in plant science (Fujii et al., 2009, Ma et al., 2009, Park et al., 2009, Umezawa et al. 2009, Kang et al., 2010, Kuromori et al., 2010). The sites of ABA perception have intrigued plant biologists for many years, and the issue has reached some resolution with the recent identification of several ABA receptors.

Endogenous stimuli, such as plant hormones, coordinate and modulate the molecular and biochemical mechanisms that provide increased stress tolerance and adjust overall plant growth and development for greater survival (Peleg and Blumwald, 2011; Choudhary et al., 2012; Ha et al., 2012; Osakabe et al., 2013). Auxins regulate a wide variety of growth and developmental processes in higher plants, including cell elongation and thus the stimulation of shoot growth. However, roots are very sensitive to auxins and even low concentrations can inhibit root growth. Auxins also regulate differentiation of vascular tissue (phloem and xylem), and induce adventitious root initiation on shoot and root cuttings used for propagation. (Kurepin et al., 2013).

In plants, polyamines are involved in various physiological events such as development, senescence and stress responses (Gill and Tuteja, 2010; Ramakrishna and Ravishankar, 2011). Endogenous polyamines could contribute to plant stress tolerance as part of defense mechanisms or adaptation programs that help plant organism to cope with the negative stress consequences (Todorova et al., 2015).

γ -Aminobutyric acid (GABA) accumulates rapidly when plants are exposed to stress. Whether GABA accumulation represents the regulation of metabolism in response to stress or an adaptive response to mitigate stress is unknown. Genetic manipulation of GABA levels has

revealed that GABA accumulation functions in defense against drought and insect herbivory (Bown and Shelp, 2016).

Recent combined genetics and physiological studies of the GABA shunt indicate that its function is required for proper growth in response to abiotic stresses such as low light (Michaeli et al., 2011) and salt (Renault et al., 2013; Michaeli et al., 2015).

In addition, other polyamines, such as 1,3-diaminopropane (DAP), cadaverine (CAD), thermospermine (Ther-SPM), norspermidine (Nor-SPD) and norspermine (Nor-SPM) are found in many organisms as minor components of the cellular polyamine pool and are referred to as uncommon polyamines (Tavliadoraki et al., 2011). 1,3-Diaminopropane, an oxidation product of the naturally occurring polyamines, occurs in many cereal plants. Endogenous 1,3-diaminopropane level has been reported to decrease in attached oat leaves with increasing age of seedlings and in excised leaves with increasing time of dark incubation, suggesting that 1,3-diaminopropane, like polyamines, may be involved in the control of senescence (Kaur-Sawhney et al., 1982).

The theme of the research work was to analyze the contents of two plant hormones (auxin and abscisic acid) in barley grain after triazine herbicide treatment and its mixtures of regulators of polyamine biosynthesis.

MATERIAL AND METHODOLOGY

Two years pot trials were carried out in vegetation cage at Slovak University of agriculture in Nitra (coordinates of GPS: 48°18'13.38''S, 18°06'03.05''V, at height above sea level of 135 meters). To each pot 6 kg of substrate was weighed (soil: sand – 4: 2). Analyses done in soil used in experiment are shown in Table 1. It was sown 30 plants which were thinned into 20 pieces after post-emergence. At the phase of early tillering plants were foliar treated (after 25 days) in the control treatment with the water (Table 2), in 2. variant with triazine herbicide alone (the active ingredient is cyanazine with chemical formula 2-(4-chloro-6-ethylamino-1,3,5-triazin-2-ylamino)-2-methylpropiono-nitrile), or its mixture with γ -aminobutyric acid (GABA) with dose 500 g.ha⁻¹ (3. variant), in 4. variant with 1,3-propylenediamine (DAP) with dose of 59.2 g.ha⁻¹, and in 6. variant with the DAP in the amount of 29,6 g.ha⁻¹, in 7. variant was mixture triazine herbicide with GABA with dose of 100 g.ha⁻¹. In 5. variant we treated the plants with mixture herbicide with growth regulator Avit A +B. The plants were watered with constant volume in all pots. Crops were harvested in full ripeness.

Analysis of plant hormones

The concentrations of indole acetic acid (IAA) and abscisic acid (ABA) were determined using an HPLC (Waters 2695 Separations Module with 2487 Detector, Manufacturer: 34 Maple Street Milford, MA, USA) system following the method of Xu et al. (1998). The whole liquid chromatographic system was controlled by evaluating software HPLC System Manager. Quantitative determination was done by the setting of absorbance by wavelength 222 nm. Each sample (2 g of average sample of grain after milling) was homogenized in liquid nitrogen

with 15 mL 80% methanol, and the homogenate was stirred overnight at 4°C. After centrifugation the samples were filtrated through the filtration paper (company Niederschlad Germany – marked by violet ring (identification number 393)). The sample was adjusted to pH 2.5 with 1 M HCl and 0.5 M NaOH. Afterwards the solution was evaporated to dryness on rotating vacuum vaporiser RVO 400. The residue was dissolved in a solution (3 mL of 3% methanol and 97% acetic acid), and after filtration was applied onto a column (Agilent TC-C₁₈, 250 mm × 4.6 mm, 5 µm). The flow of mobile phase was 0.6 ml.min⁻¹, sensitivity 64, and temperature of the column was 25°C. Four replicated experiments were performed.

Standards were prepared as followed: 4 mg ABA was dissolved in 25 ml solution of 3% methanol and 97% acetic acid and 18 mg IAA was dissolved in 25 mL solution of 3% methanol and 97% acetic acid.

Results were evaluated by statistical program Statgraphics 4.0 (Statpoint Technologies, Inc., Czech Republic), the data were analyzed by means of one-way analysis of variance (ANOVA).

RESULTS AND DISCUSSION

Plants adjust growth in response to internal and external stimuli through the activities of different hormones and simultaneous analysis of different hormones in the same plant provide a comprehensive picture of the stress induced rearrangement in plant metabolism (Shakirova et al., 2016). The phytohormones, abscisic acid (ABA), auxin, and ethylene play key roles in regulating stress responses in plants (Vanstraelen and Benkova, 2012). The effects of plant hormones can be mimicked by exogenous chemical regulators such as herbicide safeners, which not only enhance stress tolerance but also confer

hormetic benefits such as increased vigor and yield (Dashevskaya, 2013).

The contents of plant hormones of indolyl acetic acid (IAA) and abscisic acid (ABA) in spring barley grain of variety *Kompakt* were analyzed in pot trials at SUA Nitra. Solo application of herbicide induced mild extreme reactions in levels of phytohormones. In first year (table 3) of our experiment there was an increase of content of both tested organic compounds at 6th variant (statistically non-significant in comparison to control variant) after application of mixture triazine herbicide with regulators of polyamine biosynthesis DAP_{29,6} and the second highest value was found at 2nd variant where the stress situation was reached after application of solo triazine herbicide – statistically significant in comparison to 1st variant. Contrary to second experimental year (table 3), the second lowest level was found in contents of mentioned compounds, statistically non-significant at variant where the solo application of herbicide was applied. At the same year the highest content of IAA at control first variant and the highest content of ABA at variant with the mixture of triazine herbicide with morphoregulator DAP_{59,2} (4th variant) were found. It is substantial that in first year there was an increase of all analyzed phytohormones in spring barley grain and contrary, in second year there was their decrease at 2nd variant (after solo application of triazine herbicide). These extremes indicate mild stress effect of applied triazine herbicide with the consequence of arising condition called “hormonal chaos”. ABA concentrations synthesized in roots and shoots, and in particular in veins, seeds, and guard cells increase under stress conditions as a result of increased biosynthesis, decreased degradation, or release from conjugated forms (Boursiac et al., 2013; Song et al., 2014). These events could occur within the

Table 1 Agrochemical characteristics of soil (horizons 0 – 0.2 m).

Year	Soil reaction (pH/KCl)	Humus content (%)	N _{an} (mg.kg ⁻¹)	Content of nutrients		
				P (mg.kg ⁻¹)	K (mg.kg ⁻¹)	Mg (mg.kg ⁻¹)
1	7.08	3.36	10.8	46.3	198.4	502.7
2	7.49	2.79	30.7	108.3	261.5	604.2

Table 2 Variants of the pot experiment.

Variant number	Foliar treatment
1	Control: 9.0 mL water
2	Triazine herbicide 0.5 l.ha ⁻¹ : 1.0 mL water solution of triazine herbicide +8.0 mL water
3	Triazine herbicide 0.5 l.ha ⁻¹ +GABA 500 g.ha ⁻¹ : 1.0 mL water solution of triazine herbicide +4.7 mL 20 mM solution GABA +3.3 mL water
4	Triazine herbicide 0.5 l.ha ⁻¹ +DAP 59.2 g.ha ⁻¹ : 1.0 mL water solution of triazine herbicide +3.8 mL 2 mM solution DAP +4.2 mL water
5	Triazine herbicide 0.5 l.ha ⁻¹ +Avit (A) 5.0 l.ha ⁻¹ +Avit (B) 0.5 l.ha ⁻¹ : 1.0 mL water solution of triazine herbicide +93 µL Avit A +7 µL Avit B +7.9 mL water
6	Triazine herbicide 0.5 l.ha ⁻¹ +DAP 29.6 g.ha ⁻¹ : 1.0 mL water solution of triazine herbicide +1.9 mL 2 mM solution DAP +6.1 mL water
7	Triazine herbicide 0.5 l.ha ⁻¹ +GABA 100 g.ha ⁻¹ : 1.0 mL water solution of triazine herbicide +1.0 mL 20 mM solution GABA +7.0 mL water

NOTE: DAP – 1,3-propylenediamine, GABA – γ-aminobutyric acid.

affected cell or in neighboring or remote cells resulting in ABA uptake by nonstressed cells (Mittler and Blumwald, 2015).

There were obvious mitigation stress effects of herbicide after application of regulators of polyamine biosynthesis. We presume that higher content of ABA (antagonist of IAA) in first year is the reaction on stress and this increased level reduced the negative influences of stress factors. All by us applied morphoregulators reduced the level of both phytohormones only in first experimental year (except of 6th variant where the mixture of herbicide with DAP_{29,6} was applied) only in comparison to variant with solo applied triazine herbicide – statistically significant only with mixture Avit A and B (5th variant) and GABA100 (7th variant) with triazine herbicide (Table 3). Not only the applied regulators of polyamine biosynthesis at optimal amounts eliminate the herbicide effect of triazine herbicide but they also act stimulating. Contrary, at second year the solo applied triazine herbicide statistically non-significant reduced the contents of both analyzed organic compounds in comparison to non-treated 1st variant. The mixtures of regulators of polyamine synthesis in this year reduced the contents of IAA only in comparison to control (just by water treated) variant. Statistically non-significant reduction of ABA in second year was found only after application of GABA but also only when compared to control variant. The mixtures of regulators at other variants in combination with herbicide do not show any dependence on amounts of plant hormones in grain of spring barley variety *Kompakt*. At this point we could consider the stronger influence of stress as the consequence of higher salinity of soil where the plants of barley were grown; where it could be seen from Table 1 even three-times higher content values of nitrogen in soil in second experimental year when compared to first year.

The same conclusions were published also by Islam et al. (2016) who found that saline stress differently affect the synthesis of endogenous hormones. Higher saline stress significantly enhanced the contents of IAA in two cultivars of rice *ZJ 88* and *XS 134*. The solo application of herbicide 2,4-dichlorophenoxyacetic acid without presence of saline stress also impacted higher values of IAA in cultivars of rice in comparison to control variant, the plants of sensitive cultivar of rice (*ZJ 88*) which were exposed to both stresses at the same time, had the values of IAA higher at 63% and 113% in comparison to variants without stress sources.

Saline stress also causes the enhanced content of phytohormone ABA. The similar results were found also by Fernando and Schroeder, 2016, who studied environmental stimuli and referred that salinity or drought stress cause dramatically increased cellular ABA levels. The plant cuticle has been shown to mediate stress signalling as well as ABA biosynthesis and signalling. In addition to its primary function, providing mechanical support to the cell wall and plasma membrane, the cuticle has been implicated in osmotic stress regulation. CED1 (9-cis epoxy-carotenoid deoxygenase defective 1) is an essential protein in cuticle biogenesis. CED1 mutants are sensitive to osmotic stress, as they are unable to induce ABA biosynthesis in response to osmotic stress (Wang et al., 2011).

Salinity stress causes osmotic stress and water deficit, increasing the production of ABA in shoots and roots (Cabot et al., 2009). The accumulation of ABA can mitigate the inhibitory effect of salinity on photosynthesis, growth, and translocation of assimilates (Jeschke et al., 1997). The positive relationship between ABA accumulation and salinity tolerance has been at least partially attributed to the accumulation of K⁺, Ca²⁺ and compatible solutes, such as proline and sugars, in vacuoles of roots, which counteract with the uptake of Na⁺ and Cl⁻ (Gurmani et al., 2011). ABA is a vital cellular signal that modulates the expression of a number of salt and water deficit-responsive genes. Abscisic acid mediates stomatal closure to prevent water loss caused by osmotic stress under high salt stress (Shinozaki and Yamaguchi-Shinozaki, 2007).

CONCLUSION

During two experimental years at Slovak University of agriculture in Nitra the contents of plant phytohormones (ABA and IAA) in barley grain of variety *Kompakt* after application of triazine herbicide (applied solo, or in combination with regulators of polyamine biosynthesis) were assessed. At 1st year the stress effect of herbicide on plants of barley and an increase of contents of both tested plant hormones were noticeable. Morphoregulators in mentioned year had reducing effect of stress influences of present herbicide (except of variant where the mixture of 0.5 L·ha⁻¹ herbicide with 29.6 g·ha⁻¹ DAB was applied).

At 2nd experimental year the solo treatment of triazine herbicide reduced the amounts of both organic substances in barley grain. The mixtures of regulators of polyamine synthesis at mentioned year reduced the contents of IAA only in comparison to control variant. Slight decline of ABA content in this year was evaluated only at variants treated with herbicide GABA. From the experiment it could be seen that for barley plants more stressful is the higher content of soluble salts in soil than herbicide stress induced by our treatment.

REFERENCES

- Agostinetto, D., Perboni, L. T., Langaro, A. C., Gomes, J., Fraga, D. S., Franco, J. J. 2016. Changes in photosynthesis and oxidative stress in wheat plants submitted to herbicides application. *Planta Daninha, Viçosa-MG*, vol. 34, no. 1, p. 1-9. <https://doi.org/10.1590/S0100-83582016340100001>
- Bari, R., Jones, J. D. 2009. Role of plant hormones in plant defence responses. *Plant Molecular Biology*, vol. 69, no.4, p. 473-488. <https://doi.org/10.1007/s11103-008-9435-0>
- Boursiac, Y., Lérans, S., Corratgé-Faillie, C., Gojon, A., Krouk, G., Lacombe, B. 2013. ABA transport and transporters. *Trends in Plant Science*, vol.18, no. 6, p. 325-333. <https://doi.org/10.1016/j.tplants.2013.01.007>
- Bown, A. W., Shelp, B. J. 2016. Plant GABA: Not Just a Metabolite. *Trends in plant science*, vol. 21, no. 10, p. 811-813. <https://doi.org/10.1016/j.tplants.2016.08.001>
- Cabot, C. J. V., Barceló, S. J., Poschenrieder, C. 2009. Abscisic acid decreases leaf Na⁺ exclusion in salt-treated *Phaseolus vulgaris* L. *Journal of Plant Growth Regulation*, vol. 28, no. 2, p. 187-192. <https://doi.org/10.1007/s00344-009-9088-5>
- Choudhary, S. P., Oral, H. V., Bhardwaj, R., Yu, J. Q., Tran, L. S. 2012. Interaction of brassinosteroids and polyamines enhances copper stress tolerance in *Raphanus*

- sativus. *Journal of Experimental Botany*, vol. 63, no. 15, p. 5659-5675. <https://doi.org/10.1093/jxb/ers219>
 PMid:22915739
- Dashevskaya, S., Horn, R., Chudobova, I., Schillberg, S., Vélez, S., Capell, T., Christou, P. 2013. Abscisic acid and the herbicide safener cyprosulfamide cooperatively enhance abiotic stress tolerance in rice. *Molecular Breeding*, vol. 32, no. 2, p. 463-484. <https://doi.org/10.1007/s11032-013-9884-2>
- Fehér, A., Halmová, D., Pindešová, I. F., Zajác, P., Čapla, J. Distribution of invasive plants in the Nitra river basin: threats and benefits for food production. *Potravinárstvo*, vol. 10, no. 1, p. 605-611. <https://doi.org/10.5219/651>
- Fernando, V. C. D., and Schroeder, D. F. 2016. Role of ABA in Arabidopsis Salt, Drought, and Desiccation Tolerance. In Arun K. Shanker et al. *Abiotic and Biotic Stress in Plants - Recent Advances and Future Perspectives*. Rijeka, Croatia : InTech, 768 p. ISBN 978-953-51-2250-0.
- Finkelstein, R. R., Gampala, S. S. L., Rock, C. D. 2002. Abscisic acid signaling in seeds and seedlings. *Plant Cell*, vol. 14, p.15-45.
- Fujii, H., Chinnusamy, V., Rodrigues, A., Rubio, S., Antoni, R., Park, S. Y., Cutler, S. R., Sheen, J., Rodriguez, P. L., Zhu, J. K. 2009. In vitro reconstitution of an abscisic acid signalling pathway. *Nature*, vol. 462, no. 7273, p. 660-664. <https://doi.org/10.1038/nature08599>
 PMid:19924127
- Gaur, R. K., Sharma, P. 2014. *Approaches to Plant Stress and their Management*. India : Springer India. 396 p. ISBN 978-81-322-1619-3.
- Gill, S. S., Tuteja, N. 2010. Polyamines and abiotic stress tolerance in plants. *Plant Signaling and Behavior*, vol. 5, no. 1, p. 26-33. <https://doi.org/10.4161/psb.5.1.10291>
- Gurmani, A. R., Bano, A., Khan, S. U., Din, J., Zhang, J. L. 2011. Alleviation of salt stress by seed treatment with abscisic acid (ABA), 6-benzylaminopurine (BA) and chlormequat chloride (CCC) optimizes ion and organic matter accumulation and increases yield of rice (*Oryza sativa* L.). *Australian Journal of Crop Science*, vol. 5, no. 10, p. 1278-1285.
- Ha, S., Vankova, R., Yamaguchi-Shinozaki, K., Shinozaki, K., Tran, L. S. 2012. Cytokinins: metabolism and function in plant adaptation to environmental stresses. *Trends in Plant Science*, vol. 17, no. 3, p. 172-179. <https://doi.org/10.1016/j.tplants.2011.12.005>
- Islam, F., Ali, B., Wang, J., Farooq, M. A., Gill, R. A., Ali, S., Wang, D., Zhou, W. 2016. Combined herbicide and saline stress differentially modulates hormonal regulation and antioxidant defense system in *Oryza sativa* cultivars. *Plant Physiology and Biochemistry*, vol. 107, p. 82-95. <https://doi.org/10.1016/j.plaphy.2016.05.027>
- Jeschke, W. D., Peuke, A. D., Pate, J. S., Hartung, W. 1997. Transport, synthesis and catabolism of abscisic acid (ABA) in intact plants of castor bean (*Ricinus communis* L.) under phosphate deficiency and moderate salinity. *Journal of Experimental Botany*, vol. 48, no. 314, p. 1737-1747. <https://doi.org/10.1093/jexbot/48.314.1737>
- Kang, J., Hwang, J. U., Lee, M., Kim, Y. Y., Assmann, S. M., Martinoia, E., Lee, Y. 2010. PDR-type ABC transporter mediates cellular uptake of the phytohormone abscisic acid. *Proceedings of the National Academy Science of the United States of America*, vol. 107, no. 5, p. 2355-2360. <https://doi.org/10.1073/pnas.0909222107>
 PMid:20133880
- Kaur-Sawhney, R., Shih, L. M., Flores, H. E., Galston, A. W. 1982. Relation of polyamine synthesis and titer to aging and senescence in oat leaves. *Plant Physiology*, vol. 69, no. 2, p. 405-410. <https://doi.org/10.1104/pp.69.2.405>
 PMid:16662218
- Kurepin, L. V., Ozga, J. A., Zaman, M., Pharis, R. P. 2013. The Physiology of Plant Hormones in Cereal, Oilseed and Pulse Crops. *Prairie Soils & Crops Journal*, vol. 6, p. 7-23.
- Kurumori, T., Miyaji, T., Yabuuchi, H., Shimizu, H., Sugimoto, E., Kamiya, A., Moriyama, Y., Shinozaki, K. 2010. ABC transporter AtABCG25 is involved in abscisic acid transport and responses. *Proceedings of the National Academy Science of the United States of America*, vol. 107, no. 5, p. 2361-2366. <https://doi.org/10.1073/pnas.0912516107>
 PMid:20133881
- Lata, C., Prasad, M. 2011. Role of DREBs in regulation of abiotic stress responses in plants. *Journal of Experimental Botany*, vol. 62, no. 14, p. 4731-4748. <https://doi.org/10.1093/jxb/err210>
 PMid:21737415
- Ma, Y., Szostkiewicz, I., Korte, A., Moes, D., Yang, Y., Christmann, A., Grill, E. 2009. Regulators of PP2C phosphatase activity function as abscisic acid sensors. *Science*, vol. 324, no. 5930, p. 1064-1068. <https://doi.org/10.1126/science.1172408>
- Michaeli, S., Fait, A., Lagor, K., Nunes-Nesi, A., Grillich, N., Yellin, A., Bar, D., Khan, M., Fernie, A. R., Turano, F. J., Fromm, H. 2011. A mitochondrial GABA permease connects the GABA shunt and the TCA cycle, and is essential for normal carbon metabolism. *Plant Journal*, vol. 67, no. 3, p. 485-498.
- Michaeli, S., Fromm, H. 2015. Closing the loop on the GABA shunt in plants: are GABA metabolism and signaling entwined? *Frontiers in Plant Science*, vol. 6, p. 419. <https://doi.org/10.3389/fpls.2015.00419>
 PMid:26106401
- Mittler, R., Blumwald, E. 2015. The Roles of ROS and ABA in Systemic Acquired Acclimation. *The Plant Cell January*, vol. 27, no. 1, p. 64-70.
- Nakashima, K., Yamaguchi-Shinozaki, K. 2013. ABA signaling in stress-response and seed development. *Plant Cell Reports*, vol. 32, no. 7, p. 959-70. <https://doi.org/10.1007/s00299-013-1418-1>
 PMid:23535869
- Navarro, L., Bari, R., Achard, P., Lison, P., Nemri, A., Harberd, N. P., Jones, J. D. 2008. DELLAs control plant immune responses by modulating the balance of jasmonic acid and salicylic acid signaling. *Current Biology*, vol. 18, no. 9, p. 650-655. <https://doi.org/10.1016/j.cub.2008.03.060>
 PMid:18450451
- Nishiyama, R., Watanabe, Y., Leyva-Gonzalez, M. A., Van, H. C., Fujita, Y., Tanaka, M., Seki, M., Yamaguchi-Shinozaki, K., Shinozaki, K., Herrera-Estrella, L., Tran, L. S. 2013. Arabidopsis AHP2, AHP3, and AHP5 histidine phosphotransfer proteins function as redundant negative regulators of drought stress response. *Proceedings of the National Academy Science of the USA*, vol. 110, no. 12, p. 4840-4845. <https://doi.org/10.1073/pnas.1302265110>
- Oliveira, R. S., Constantin, J., Inoue, M. H. 2011. Mecanismo de ação de herbicidas. In de Oliveira R. S. et al. *Biologia e manejo de plantas daninhas*. Curitiba : Omnipax, p. 141-192. ISBN: 978-85-64619-02-9.
- Osakabe, Y., Yamaguchi-Shinozaki, K., Shinozaki, K., Tran, L. S. P. 2013. Sensing the environment: key roles of membrane-localized kinases in plant perception and response to abiotic stress. *Journal of Experimental Botany*, vol. 64, no. 2, p. 445-458. <https://doi.org/10.1093/jxb/ers354>
 PMid:23307915

- Parent, B., Hachez, C., Redondo, E., Simonneau, T., Chaumont, F., Tardieu, F. 2009. Drought and abscisic acid effects on aquaporin content translate into changes in hydraulic conductivity and leaf growth rate: a trans-scale approach. *Plant Physiology*, vol. 149, no. 4, p. 2000-2012. <https://doi.org/10.1104/pp.108.130682>
PMid:19211703
- Park, S. Y., Fung, P., Nishimura, N., Jensen, D. R., Fujii, H., Zhao, Y., Lumba, S., Santiago, J., Rodrigues, A., Chow, T. F., Alfred, S. E., Bonetta, D., Finkelstein, R., Provart, N. J., Desveaux, D., Rodriguez, P. L., McCourt, P., Zhu, J. K., Schroeder, J. I., Volkman, B. F., Cutler, S. R. 2009. Abscisic acid inhibits type 2C protein phosphatases via the PYR/PYL family of START proteins. *Science*, vol. 324, p. 1068-1071. <https://doi.org/10.1126/science.1173041>
- Peleg, Z., Blumwald, E. 2011. Hormone balance and abiotic stress tolerance in crop plants. *Current Opinion in Plant Biology*, vol. 14, no. 3, p. 290-295. <https://doi.org/10.1016/j.pbi.2011.02.001>
- Pieterse, C. M., Leon-Reyes, A., Van der Ent, S., Van Wees, S. C. 2009. Networking by small-molecule hormones in plant immunity. *Nature Chemical Biology*, vol. 5, p. 308-316. <https://doi.org/10.1038/nchembio.164>
- Piñol, R., Simón, E. 2011. Protective effects of brassinosteroids against herbicides. In Hayat, S. et al. *Brassinosteroids: A class of plant hormone*. Netherlands : Springer Science+Business Media B.V., p. 309-344. ISBN: 978-94-007-0188-5.
- Qin, F., Shinozaki, K., Yamaguchi-Shinozaki, K. 2011. Plant abiotic stress responses and tolerance. *Plant & Cell Physiology*, vol. 52, no. 9, p. 1569-1582. <https://doi.org/10.1093/pcp/pcr106>
PMid:21828105
- Raghavendra, A. S., Gonugunta, V. K., Christmann, A., Grill, E. 2010. ABA perception and signalling. *Trends in Plant Science*, vol. 15, no. 7, p. 395-401. <https://doi.org/10.1016/j.tplants.2010.04.006>
- Ramakrishna, A., Ravishankar, G. A. 2011. Influence of abiotic stress signals on secondary metabolites in plants. *Plant Signaling and Behavior*, vol. 6, no. 11, p. 1720-1731. <https://doi.org/10.4161/psb.6.11.17613>
- Renault, H. 2013. Fiat lux! Phylogeny and bioinformatics shed light on GABA functions in plants. *Plant Signaling and Behavior*, vol. 8, no. 6, p. e24274. <https://doi.org/10.4161/psb.24274>
PMid:23518583
- Shakirova, F. M., Allagulova, C. R., Maslennikova, D. R., Klyuchnikova, E. O., Avalbaev, A. M., Bezrukova, M. V. 2016. Salicylic acid-induced protection against cadmium toxicity in wheat plants. *Environmental and Experimental Botany*, vol. 122, p. 19-28. <https://doi.org/10.1016/j.envexpbot.2015.08.002>
- Shinozaki, K., Yamaguchi-Shinozaki, K. 2007. Gene networks involved in drought stress response and tolerance. *Journal of Experimental Botany*, vol. 58, no. 2, p. 221-227. <https://doi.org/10.1093/jxb/erl164>
- Song, Y., Miao, Y., Song, C. P. 2014. Behind the scenes: the roles of reactive oxygen species in guard cells. *New Phytologist*, vol. 201, no. 4, p. 1121-1140. <https://doi.org/10.1111/nph.12565>
- Tavladoraki, P., Cervelli, M., Antonangeli, F., Minervini, G., Stano, P., Federico, R., Mariottini, P. Polticelli, F. 2011. Probing mammalian spermine oxidase enzyme-substrate complex through molecular modeling, site-directed mutagenesis and biochemical characterization. *Amino acids*, vol. 40, no. 4, p. 1115-1126. <https://doi.org/10.1007/s00726-010-0735-8>
- Todorova, D., Katerova, Z., Alexieva, V., Sergiev, I. 2015. Polyamines – possibilities for application to increase plant tolerance and adaptation capacity to stress. *Genetics and Plant Physiology*, vol. 5, no. 2, p. 123-144. <https://doi.org/10.1079/9781780642734.0194>
- Umezawa, T., Sugiyama, N., Mizoguchi, M., Hayashi, S., Myouga, F., Yamaguchi-Shinozaki, K., Ishihama, Y., Hirayama, T., Shinozaki, K. 2009. Type 2C protein phosphatases directly regulate abscisic acid-activated protein kinases in Arabidopsis. *Proceedings of the National Academy Science of the United States of America*, vol. 106, no. 41, p. 17588-17593. <https://doi.org/10.1073/pnas.0907095106>
- Vanstraelen, M., Benkova, E. 2012. Hormonal interactions in the regulation of plant development. *Annual Review of Cell and Developmental Biology*, vol. 28, p. 463-487. <https://doi.org/10.1146/annurev-cellbio-101011-155741>
- Velini, E. D., Trindade, M. L., Barberis, R. M., Duke, S. O. 2010. Growth regulation and other secondary effects of herbicides. *Weed Science*, vol. 58, no. 3, p. 351-354. <https://doi.org/10.1614/WS-D-09-00028.1>
- Verma, V., Ravindran, P., Kumar, P. 2016. Plant hormone-mediated regulation of stress responses. *Plant Biology BMC series – open, inclusive and trusted*, vol. 16, p. 86. <https://doi.org/10.1186/s12870-016-0771-y>
- Wang, Z. Y., Xiong, L., Li, W., Zhu, J. K., Zhu, J. 2011. The Plant Cuticle Is Required for Osmotic Stress Regulation of Abscisic Acid Biosynthesis and Osmotic Stress Tolerance in Arabidopsis. *Plant Cell*, vol. 23, no. 5, p.1971-1984. <https://doi.org/10.1105/tpc.110.081943>
- Xu, X., van Lammeren, A. A., Vermeer, E., Vreugdenhil, D. 1998. The role of gibberellin, abscisic acid, and sucrose in the regulation of potato tuber formation *in vitro*. *Plant Physiology*, vol. 117, no. 2, p. 575-584. <https://doi.org/10.1104/pp.117.2.575>

Acknowledgments:

The work was supported by grants KEGA č. 015SPU-4/2016 a VEGA 1/0147/17.

Contact address:

Pavol Trebichalský, Slovak University of Agriculture in Nitra, Faculty of Biotechnology and Food Sciences, Department of Chemistry, Tr. A. Hlinku 2, 949 76 Nitra, Slovak Republic, E-mail: pavol.trebichalsky@uniag.sk

Tomáš Tóth, Slovak University of Agriculture in Nitra, Faculty of Biotechnology and Food Sciences, Department of Chemistry, Tr. A. Hlinku 2, 949 76 Nitra, Slovak Republic, E-mail: tomas.toth@uniag.sk

Daniel Bajčan, Slovak University of Agriculture in Nitra, Faculty of Biotechnology and Food Sciences, Department of Chemistry, Tr. A. Hlinku 2, 949 76 Nitra, Slovak Republic, E-mail: daniel.bajcan@uniag.sk

Luboš Harangozo, Slovak University of Agriculture in Nitra, Faculty of Biotechnology and Food Sciences, Department of Chemistry, Tr. A. Hlinku 2, 949 76 Nitra, Slovak Republic, E-mail: lubos.harangozo@uniag.sk

Alena Vollmannová, Slovak University of Agriculture in Nitra, Faculty of Biotechnology and Food Sciences, Department of Chemistry, Tr. A. Hlinku 2, 949 76 Nitra, Slovak Republic, E-mail: alena.vollmannova@uniag.sk



CHARACTERISTICS OF STARCH BREADS ENRICHED WITH RED POTATOES

*Dorota Gumul, Wiktor Berski, Eva Ivanišová, Halina Gambuś, Miroslava Kačániová,
Luboš Harangózo, Marián Tokár*

ABSTRACT

Starch breads may often be low in nutritional value, in comparison to traditional products, as they contain less dietary fibre, protein and micro and macro elements. As an effect a risk of mineral deficiencies and digestive problems caused by lack of dietary fibre could be expected in persons adhering to gluten free diet. To eliminate such problems, a continuous research on gluten-free bread nutritional enrichment, has been done in recent years. Raw material used to enrich gluten free products should include: inulin, lupine, radish, soy, lucerne sprouts, oilseeds, different type of dried fruits. Among the most commonly used raw materials, there are flours from gluten free cereals and pseudocereals such as buckwheat, amaranth and maize are very popular. It seem that valuable alternative could be considered a red, purple or pink potatoes as starch breads additives. The aim of this work was to investigate the effect addition of freeze-dried color potatoes on crude fiber, polyphenols, anthocyanins and flavonoids and nutritional value of gluten free breads. It could be concluded, that freeze-dried color (red, purple, pink) potatoes enriched the gluten free breads (starch breads) with health promoting bioactive components, like polyphenols, and highly valuable protein. The most promising additive was Magenta Love red potato variety lyophilisates, because gluten free breads enriched with this component were characterized by high protein content and the highest content of free and bound polyphenols, flavonoids, anthocyanins. The presence of all these components increased the nutritional and pro-health value of gluten free product as starch bread.

Keywords: starch bread; color potatoes; pro-health components; nutritive components; crude fibre

INTRODUCTION

Starch breads are also called gluten free breads. Such breads are the backbone of gluten free diet, i.e. the only effective way of celiac disease treatment, quite often diagnosed among children, youth adult and elderly people. Celiac disease is gluten dependant body malfunction, lasting a whole life period intolerance of alcohol soluble gluten fraction. This protein is present in cereal grains: wheat (gliadin), rye (secalin), barley (hordein) and oat (avenin). It is congenial, autoimmune disease (**McGough and Cummings, 2005; Brouns et al., 2013**). It occurs in people with congenital predisposition, and reveals in different ages, at the time of consumption of gluten containing food products. About 1% of population is affected by this disease. This disease is the most often diagnosed in persons at 30 to 50 years old, and women are affected twice as often as men (**McGough and Cummings, 2005; Brouns et al., 2013; Capriles et al., 2015**).

Celiac disease forced a total removal of wheat, rye, barley and oat gluten containing food product from diet. Due to recipe composition, gluten free products such as starch bread are prepared using starch and hydrocolloids,

and for that reason their nutritional value is lower than their traditional equivalents. Such type of products can create deficiency of protein, mineral compounds and dietary fiber among people with celiac disease. For such reason people with gluten intolerance could suffer from physic and mental retardation, poor resistance, anemia, osteoporosis etc. (**Hamer, 2005**). For those reasons the role of dietetics is to enrich gluten free breads with gluten free components having a high nutritional value. Enrichment of gluten free products is important both for producers, as well as for consumers, aware of nutritional and dietetic value of consumed food. Raw material used to enrich gluten free products should include pseudocereals flours, inulin, lupine, radish, soy, lucerne sprouts, oilseeds, dried fruits. One of the additives increasing nutritional value of gluten free breads are soy proteins, which are characterized by high nutritional value, due to the presence of completely protein, but on the other hand soy can be a potent allergen (**Diowksz and Pawłowska, 2010**). It seems that as a good alternative could be considered a red, purple or pink potatoes as gluten free breads additives. Their presence can increase nutritional value of starch breads, due to the occurrence of completely protein (with high lysine content) (**Desborough, 1985**), and the bioactive

components such as polyphenols (Lachman et al., 2009). Such reasons decided to make a research on gluten-free breads with addition of freeze-dried red, purple and pink potatoes.

The aim of this work was to investigate the effect addition of above mentioned freeze-dried color potatoes on crude fiber, polyphenols, anthocyanins and flavonoids and nutritional value of gluten free breads.

MATERIAL AND METHODOLOGY

Material

Material of the study was starch breads with 5% addition of freeze-dried red, purple and pink potatoes (lyophilisates). Additionally material in the first stage of this work was freeze-dried red, purple and pink, yellow potatoes.

Methodology

The following chemical analyses were performed on 10 samples:

1. Content of basic nutritional components was performed by the method of **AOAC (1995)**.
2. Content of crude fibre according to Ankom²²⁰ Fiber Analyzer manufacturer methodologies (ANKOM technology, New York, USA).
3. Content of vitamin C, by methods PN-78/A-74702 (1978).
4. Total phenolic content (TPC) (free; free and bound phenolic compounds) by spectrophotometric method (spectrophotometer type helios gamma100-240, England), according to **Swan and Hillis (1959)**, expressed in mg catechin.g⁻¹ d.m. sample.
5. Content of anthocyanins using spectrophotometrically method (spectrophotometer type helios gamma100-240, England), according to **Fuleki and Francis, (1968)** and **Lee et al. (2005)**.
6. The content of flavonoids using spectrophotometrically method (spectrophotometer type helios gamma100-240, England), according to **Quettier -Deleu et al. (2000)**.
7. Antioxidant activity by Reducing power methods, by spectrophotometric method (spectrophotometer type helios gamma100-240, England), according to **Oyaizu (1986)** expressed in Trolox Equivalent Antioxidant Capacity - TEAC (mg Tx.g⁻¹ d.m. sample).

In this publication the following abbreviations were used: BS; ML; V; S; Ro – freeze-dried potatoes (lyophilisates) varieties: Blue Star, Magenta Love, Violeta, Saturna, Rosalind, respectively; Control – control bread; SB +5BS; SB +5ML; SB +5V; SB+5Ro – starch bread with share of freeze-dried potatoes (varieties: Blue Star, Magenta Love, Violeta, Rosalind, respectively).

Statistical analysis

The results were statistically compared basing on the Duncan's test, at the significance level 0.05, with the use of computer programme Statistica 8.0PL. All the measurements were done at least induplicate. Correlation coefficient was measured with the use of computer programme Statistica 8.0PL.

RESULTS AND DISCUSSION

In the first stage of this work freeze-died of red potatoes variety Magenta Love, purple potatoes (Violeta and Blue Star varieties), pink (Rosalind variety) and yellow (Saturna variety) were characterized to indicate those with the highest nutritional and pro-health value, in order to apply them as enrichment of gluten free breads.

The content of selected nutritional components, including vitamin C, in the freeze-dried potatoes was summarized in Table 1.

It was observed, that the highest level of protein was in freeze-dried pink potatoes variety Rosalind, and the lowest in Blue Star variety. The freeze-dried red potatoes variety Magenta Love had about 11.4% higher protein content than in Violeta variety (purple potatoes), and 6% higher than in freeze-dried yellow potatoes variety Saturna.

Lipid content in potatoes lyophilisates was relatively constant, regardless of variety, about 1.2 g.100 g⁻¹ d.m. Starch, a storage material in the plant, content was at constant level in red (Magenta Love variety), purple (Violeta and Blue Star varieties) and yellow (Saturna variety) potatoes lyophilisates, but in case of pink variety (Rosalind) was about 4.4% lower as compared to other samples (Table 1).

Crude fiber content was the highest in freeze-dried purple potatoes variety Violeta, and the lowest in freeze-dried samples prepared from Saturna and Rosalind varieties (Table 1). In other freeze-dried samples it was at constant level – about 0.54 g.100 g⁻¹ (Table 1).

It was discovered, that vitamin C content was constant in freeze-dried samples, regardless of variety, with exception for freeze-dried pink potatoes (variety Rosalind), where content of vitamin C was about 35% lower (Table 1).

Although, in the available literature there is no data concerning nutrition composition and vitamin C content in freeze-dried potato samples, but observed values are consistent with findings related to raw potatoes (**Leszczyński, 2000; Wroniak, 2006; Burlingame et al., 2009; Rady and Guyer, 2015**).

Bioactive compounds from polyphenols groups are health promoting, due to anticancerogenic, antimutagenic, antiphlogistic and antiallergic action (**Scalbert, 2005**), and they were present in the investigated potatoes lyophilisates (Table 2).

It was observed, that the highest content of free polyphenols was discovered in freeze-dried red potatoes (variety Magenta Love), and the lowest in freeze-dried yellow potatoes (variety Saturna). The free polyphenols content in remaining freeze-dried samples was in the following order: Violeta >Blue Star >Rosalind. Analogical tendency was observed for free and bound polyphenols content in all investigated freeze-dried samples. Content of polyphenols was in agreement with other authors findings. According to **Kita et al. (2015)** the amount of polyphenols in red and purple potatoes was 250 – 526 mg gallic acid.100 g⁻¹, and **Lachman et al. (2009)** results indicated on 455 – 481 mg gallic acid.100 g⁻¹ d.m.

In case of flavonoids, the highest content of these compounds was observed in freeze-dried red potatoes Magenta Love variety, and the lowest in Blue Star (purple potatoes) (Table 2). The remaining freeze-dried samples were characterized by constant flavonoids content – about 0.145 mg quercetin .g⁻¹ d.m. In case of anthocyanins, their

Table 1 Content of nutritive compounds, crude fibre, vitamin C in freeze-dried potatoes.

Samples	Content of protein (g.100g ⁻¹ ±SD)	Content of fat (g.100g ⁻¹ ±SD)	Content of starch (g.100g ⁻¹ ±SD)	Content of crude fibre (g.100g ⁻¹ ±SD)	Content of vitamin C (g.100g ⁻¹ ±SD)
BS	6.23 ±0.15 ^{a*}	1.19 ±0.11 ^a	74.21 ±2.13 ^b	0.53 ±0.02 ^b	0.087 ±0.02 ^b
ML	9.07 ±0.1 ^d	1.30 ±0.10 ^a	71.37 ±1.80 ^b	0.55 ±0.01 ^b	0.073 ±0 ^b
V	8.14 ±0.13 ^b	0.99 ±0.17 ^a	75.2 ±1.90 ^b	0.57 ±0 ^c	0.076 ±0.011 ^b
S	8.59 ±0.2 ^c	1.09 ±0 ^a	73.93 ±1.2 ^b	0.48 ±0.02 ^a	0.081 ±0.017 ^b
Ro	9.57 ±0.32 ^e	1.24 ±0 ^a	70.43 ±0 ^{ab}	0.49 ±0 ^a	0.051 ±0.010 ^a

Note: *Different letters in column denote mean values that statistically differ one from another (Duncan test, at $\alpha = 0.05$).

Table 2 Content of phenolic compounds in freeze-dried potatoes.

Samples	Content of free phenolic compounds (mg catechin.g ⁻¹ dm ±SD)	Content of free and bound phenolic compounds (mg catechin.g ⁻¹ dm ±SD)	Content of flavonoids (mg quercetin.g ⁻¹ dm ±SD)	Content of anthocyanins (mg cyanidin-3-glucoside.g ⁻¹ ±SD)	Reducing power (mg TX.g ⁻¹ ±SD)
BS	3.064 ±0.042 ^{c*}	5.312 ±0.049 ^c	0.05 ±0 ^a	0.985 ±0 ^c	11.47 ±0.51 ^c
ML	7.530 ±0.091 ^e	11.657 ±0.444 ^e	0.373 ±0 ^c	1.853 ±0 ^e	29.14 ±0.63 ^e
V	5.067 ±0 ^d	7.479 ±0.115 ^d	0.137 ±0 ^b	1.788 ±0.003 ^d	16.72 ±0.17 ^d
S	2.081 ±0.031 ^a	3.581 ±0.120 ^a	0.143 ±0.011 ^b	0.009 ±0.002 ^a	8.97 ±0.5 ^a
Ro	2.971 ±0.011 ^b	4.257 ±0.075 ^b	0.152 ±0.018 ^b	0.043 ±0.004 ^b	10.34 ±0.27 ^b

Note: *Different letters in column denote mean values that statistically differ one from another (Duncan test, at $\alpha = 0.05$).

content was the highest in freeze-dried red potatoes Magenta Love variety. Their content was 5% higher as compared to Violet lyophilisate and 47% as compared to Blue Star lyophilisate. Pink potatoes lyophilisate (Rosalind variety) had 43 times lower anthocyanins content than Magenta Love lyophilisate. Among all investigated lyophilisates, the lowest anthocyanins content was observed in yellow potatoes one (Saturna). The amount of previously mentioned compounds was consistent with other author's findings (Leszczyński, 2000; Teow et al., 2007; Lachman et al., 2009).

The antioxidant activity of different colors potatoes lyophilisates could be ordered in the following way: Saturna >Rosalind >Blue Star >Violeta >Magenta Love that was consistent with TPC, flavonoids and anthocyanins content (Table 2). That was confirmed by strong correlations between TPC and FRAP ($r^2 = 0.993$), flavonoids content and FRAP ($r^2 = 0.877$), anthocyanins content and FRAP ($r^2 = 0.810$).

Concluding, among all investigated lyophilisates from different potatoes varieties, the most beneficial from nutritional and pro-health point of view were red and purple ones, especially from Magenta Love variety.

Taking into consideration a growing number of world's celiac disease occurrences, it should be introduced a new products enriched with gluten free raw material with high nutrition and health promoting load. Previously described lyophilisates of red, purple and pink potatoes seems to be a perfect solution, because they are a good source of protein and phenolic compounds. For that reason at second stage of this work the starch breads with addition of aforementioned lyophilisates were investigated. Table 3 summarized the content of nutrients (protein, fat, starch), crude fibre and vitamin C in starch bread with share of freeze-dried potatoes (lyophilisates).

It was discovered, that introduction of freeze-dried potatoes caused an increase in protein content, and the highest increase was observed for two breads supplemented with red potatoes lyophilisate (Magenta Love variety), about 32% more than the control, and pink variety Rosalind – 46%. It should be recognized, that a tuberin biological value is comparable to egg white (Desborough, 1985). Addition of such protein will lead to increase a nutritional value of final product.

Content of lipids and starch in breads decreased, independently of added lyophilisates type, about 28% for lipids and 5% for starch. A decrease of starch content could be explained by its partial replacement by potatoes lyophilisates (Table 3).

The amount of crude fiber was the highest in control sample, and addition of potato lyophilisates caused a small decrease of this component. It was also observed almost a total disappearance of vitamin C after a baking process (thermal treatment), that can be connected with its thermolability (Burgos et al., 2009) (Table 3).

The content of bioactive components in starch breads with addition of potato lyophilisates was summarized in Table 4.

Introduction of lyophilisates led to increase in content of free polyphenols in starch breads as compared to control sample. Analogous tendency was observed for free and bound polyphenols in discussed samples, but the highest increase of free and bound polyphenols (2.3 fold) was observed for bread with addition of red potatoes lyophilisates (Magenta Love variety).

A very important issue in this work was to perform an analysis of high molecular mass polyphenols (flavonoids), because their amount determines the antioxidative activity in the main respect. The amount of aforementioned compounds was summarized in Table 4. It was observed,

Table 3 Content of nutritive compounds, crude fibre, vitamin C in starch breads with freeze-dried potatoes.

Samples	Content of protein (g.100g ⁻¹ ±SD)	Content of fat (g.100g ⁻¹ ±SD)	Content of starch (g.100g ⁻¹ ±SD)	Content of crude fibre (g.100g ⁻¹ ±SD)	Content of vitamin C (g.100g ⁻¹ ±SD)
Control	2.14 ±0.02 ^{a*}	4.29 ±0.20 ^b	93.28 ±0 ^b	0.60 ±0 ^c	-
SB+5BS	2.37 ±0.03 ^b	3.15 ±0.13 ^a	89.04 ±1.5 ^a	0.56 ±0.01 ^a	-
SB+5ML	2.83 ±0.10 ^c	3.02 ±0.11 ^a	88.84 ±1.72 ^a	0.56 ±0.02 ^a	-
SB+5V	2.41 ±0.02 ^b	3.07 ±0.10 ^a	89.17 ±1.29 ^a	0.59 ±0 ^b	-
SB+5Ro	3.13 ±0.04 ^d	3.17 ±0 ^a	88.97 ±1.34 ^a	0.50 ±0.05 ^a	-

Note: *Different letters in column denote mean values that statistically differ one from another (Duncan test, at $\alpha = 0.05$).

Table 4 Content of phenolic compounds in starch breads with freeze-dried potatoes.

Samples	Content of free phenolic compounds (mg catechin.g ⁻¹ dm ±SD)	Content of free and bound phenolic compounds (mg catechin.g ⁻¹ dm ±SD)	Content of flavonoids (mg quercetin.g ⁻¹ dm ±SD)	Content of anthocyanins (mg cyanidin-3-glucoside.g ⁻¹ ±SD)	Reducing power (mg TX.g ⁻¹ ±SD)
Control	nd	0.652 ±0.012 ^a	0.012 ±0 ^a	nd	0.53 ±0.22 ^a
SB+5BS	0.021 ±0.001 ^{a*}	0.693 ±0.007 ^c	0.033 ±0.012 ^b	0.121 ±0.011 ^b	1.92 ±0.17 ^c
SB+5ML	0.167 ±0.009 ^c	1.511 ±0.065 ^e	0.087 ±0.019 ^c	0.187 ±0.023 ^d	3.75 ±0.54 ^e
SB+5V	0.066 ±0.002 ^b	0.900 ±0.071 ^d	0.045 ±0 ^b	0.156 ±0.008 ^c	2.43 ±0.23 ^d
SB+5Ro	0.019 ±0.003 ^a	0.678 ±0.006 ^b	0.049 ±0.01 ^b	0.017 ±0 ^a	1.54 ±0.11 ^b

Note: *Different letters in column denote mean values that statistically differ one from another (Duncan test, at $\alpha=0.05$), nd – not determined.

that all lyophilisates made from red, purple and pink potatoes caused an increase of these compounds in gluten free breads within 175 – 625% range, as compared to control. As for anthocyanins there were absent in control sample. The addition of lyophilisates into investigated breads led to emergence of anthocyanins, although their level was low. Anthocyanins are a group of potent compounds with high health promoting effect (anticarcinogenic, decreasing blood pressure, suppressing chronic diseases) (Teow et al., 2007).

Although baking process decreases the content of polyphenols, flavonoids, and especially anthocyanins (which are particularly thermolabile) (Rein, 2005; Zielinski et al., 2009; Alvarez-Jubete et al., 2010), but addition of lyophilisates of red and purple potatoes, guarantees the increase of bioactive compounds (free and bound polyphenols, flavonoids and anthocyanins) in gluten free breads, which was documented by increased pro-health value of such products.

The elevated level of aforementioned bioactive compounds increased the antioxidant activity of starch breads supplemented with potato lyophilisates as measured by FRAP method in comparison to control sample (Table 4). That was confirmed by strong correlations: TPC between FRAP ($r^2 = 0.897$), flavonoids content and FRAP ($r^2 = 0.930$), anthocyanins content and FRAP ($r^2 = 0.955$). Analogous research (Korus et al., 2012) dealing with gluten free breads supplemented with defatted blackcurrant and strawberry seeds reported an increase in polyphenols content within 92 – 130% range (as observed for blackcurrant seeds) and 5 – 12 fold increase in polyphenols content for strawberry seeds in comparison control. Moreover Korus et al. (2012) observed 60 – 80% increase of protein content after supplementation with fruit components.

CONCLUSION

It could be concluded, that freeze-dried red, purple and pink potatoes enriched the gluten free breads with health promoting bioactive components, like polyphenols, and highly valuable protein. The most promising additive was Magenta Love potato variety lyophilisates, because gluten free breads enriched with this component were characterized by high protein content and the highest content of free and bound polyphenols, flavonoids, anthocyanins. The presence of all these components (bioactive and nutrient) increased the nutritional and pro-health value of gluten free product as starch bread.

REFERENCES

- Alvarez-Jubete, L., Wijngaard, H., Arendt, E., Gallagher, E. 2010. Polyphenol composition and in vitro antioxidant activity of amaranth, quinoa buckwheat and wheat as affected by sprouting and baking. *Food Chemistry*, vol. 119, no. 2, p. 770-778. <https://doi.org/10.1016/j.foodchem.2009.07.032>
- AOAC:1995. *Official methods of analysis*. Arlington (VA).
- Brouns, F., Buul, V., Shewry, P. 2013. Does wheat make us fat and sick. *Journal Cereal Sciences*, vol. 58, no. 2, p. 209-215. <https://doi.org/10.1016/j.jcs.2013.06.002>
- Burgos, G., Auqui, S., Amoros, W., Salas, E., Bonierbale, M. M. 2009. Ascorbic acid concentration of native Andean potato varieties as affected by environment, cooking and storage. *Journal of Food Composition and Analysis*, vol. 22, no. 6, p. 533-538. <https://doi.org/10.1016/j.jfca.2008.05.013>
- Burlingame, B., Mouillé, B., Charrondière, R. 2009. Nutrients, bioactive non-nutrients and anti-nutrients in potatoes. *Journal of Food Composition and Analysis*, vol. 22, no. 6, p. 494-502. <https://doi.org/10.1016/j.jfca.2009.09.001>
- Capriles, V. D., Santos, F. G., Arêas, J. A. 2015. Gluten-free breadmaking: Improving nutritional and bioactive compounds. *Journal Cereal Sciences*, vol. 67, p. 1-9.
- Desborough, S. L. 1985. Potato proteins. In Li, P. H. *Potato physiology*. 1st ed. Massachusetts, USA : Academic Press.

- p.43. ISBN: 978-0-12-447660-8.
<https://doi.org/10.1016/B978-0-12-447660-8.50015-6>
- Diowski, A., Pawłowska, P. 2010. Nowe możliwości wzbogacania diety bezglutenowej. *Przegląd Piekarski i Cukierniczy*, vol.12, p. 24-28.
- Fuleki, T., Francis, F. J. 1968. Determination of total anthocyanin and degradation index for cranberry juice. *Food Science*, vol. 33, no. 1, p. 78-83.
<https://doi.org/10.1111/j.1365-2621.1968.tb00888.x>
- Hamer, R. J. 2005. Coeliac disease: background and biochemical aspects. *Biotechnology Advances*, vol. 23, no. 6, p. 401-408. <https://doi.org/10.1016/j.biotechadv.2005.05.005> PMID:16006084
- Kita, A., Bąkowska-Barczak, A., Lisińska, G., Hamouz, K., Kułakowska, K. 2015. Antioxidant activity and quality of red and purple flesh potato chips. *LWT-Food Science and Technology*, vol. 62, no. 1, p. 525-531.
<https://doi.org/10.1016/j.lwt.2014.03.026>
- Korus, J., Juszczak, L., Ziobro, R., Witczak, M., Grzelak, K., Sójka, M. 2012. Defatted strawberry and blackcurrant seeds as functional ingredients of gluten-free bread. *Journal of Texture Studies*, vol. 43, no. 1, p. 29-39.
<https://doi.org/10.1111/j.1745-4603.2011.00314.x>
- Lachman, J., Hamouz, K., Sulc, M., Orsak, M., Pivec, V., Hejtmankova, A., Dvořák, P., Čepl, J. 2009. Cultivar differences of total anthocyanins and anthocyanidins in red and purple-fleshed potatoes and their relation to antioxidant activity. *Food Chemistry*, vol. 114, no. 3, p. 836-843.
<https://doi.org/10.1016/j.foodchem.2008.10.029>
- Lee, J., Durst, R. W., Wrolstad, R. 2005. Determination of total monomeric anthocyanin pigment content of fruit juices, beverages, natural colorants and wine by pH different method: Collaborative study. *Journal Association of Official Analytical Chemists International*, vol. 88, no. 5, p. 1269-1278.
- Leszczyński, W. 2000. Jakość ziemniaka konsumpcyjnego (Quality of low-starch potato). *Żywność Nauka Technologia Jakość*, vol. 7, no. 4, p. 5-27.
- McGough, N., Cummings, J. H., 2005. Celiac disease: a diverse clinical syndrome caused by intolerance of wheat, barley and rye. *Proceeding Nutrition Society*, vol. 64, no. 4, p. 434-50.
<https://doi.org/10.1079/PNS2005461> PMID:16313685
- Oyaizu, M. 1986. Studies on products of browning reaction-antioxidative activities of products of browning reaction prepared from glucosamine. *Japanese Journal of Nutrition*, vol. 44, p. 307-314.
<https://doi.org/10.5264/eiyogakuzashi.44.307>
- PN-78/A-74702:1978. *Determination of vitamin C. Polska Norma – Oznaczenie witaminy C – Polish Standards.*
- Quettier-Deleu, C., Gressier, B., Vesseur, J., Dine, E., Brune, T. C., Luyckx, M., Cazin, M., Cazin, J. C., Bailleul, F. 2000. Phenolic compounds and antioxidant activities of buckwheat (*Fagopyrum esculentum Moench*) hulls and flour. *Journal of Ethnopharmacology*, vol. 72, no. 1-2, p. 35-42.
[https://doi.org/10.1016/S0378-8741\(00\)00196-3](https://doi.org/10.1016/S0378-8741(00)00196-3)
- Rady, A. M., Guyer, D. E. 2015. Rapid and/or nondestructive quality evaluation methods for potatoes: a review. *Computers and Electronics in Agriculture*, vol. 117, p. 31-48. <https://doi.org/10.1016/j.compag.2015.07.002>
- Scalbert, A., Johnson, I. T., Saltmarsh, M. 2005. Polyphenols: Antioxidants and beyond. *American Journal of Nutrition*, vol. 81, no. 1, p. 215-217.
- Swan T., Hillis, W. E. 1959. The phenolic constituents of *Prunus domestica* L. – The quantitative analysis of phenolic constituents. *Journal of the Science of Food and Agriculture*, vol. 10, no. 1, p. 63-68.
<https://doi.org/10.1002/jsfa.2740100110>
- Teow, C. C., Truong, V., McFeeters, R. F., Thompson, R. L., Pecota, K. V., Yencho, G. C., 2007. Antioxidant activities, phenolic and β -carotene contents of sweet potato genotypes with varying flesh colours. *Food Chemistry*, vol. 103, no. 3, p. 829-838. <https://doi.org/10.1016/j.foodchem.2006.09.033>
- Wroniak, J. 2006. Walory żywieniowe ziemniaka jadalnego (Nutritional benefit of potato). *Ziemniak Polski*, vol. 2, p. 17-20.
- Zielinski, H., Michalska, A., Amigo-Benavent, M., Castillo, M., Piskula, M. 2009. Changes in protein quality and antioxidant properties of buckwheat seeds and groats induced by roasting. *Journal of Agriculture and Food Chemistry*, vol. 57, no. 11, p. 4771-4776. <https://doi.org/10.1021/jf900313e> PMID:19415894

Contact address:

Dorota Gumul, Department of Carbohydrate Technology, Faculty of Food Technology, University of Agriculture in Krakow, Balicka 122 Str., 30-149 Kraków, Poland, E-mail: rrgumul@cyf-kr.edu.pl

Wiktor Berski, Department of Carbohydrate Technology, Faculty of Food Technology, University of Agriculture in Krakow, Balicka 122 Str., 30-149 Kraków, Poland, E-mail: rrberski@cyf-kr.edu.pl

Halina Gambuś, Department of Carbohydrate Technology, Faculty of Food Technology, University of Agriculture in Krakow, Balicka 122 Str., 30-149 Kraków, Poland, E-mail: rrhgambu@cyf-kr.edu.pl

Eva Ivanišová, Department of Plant Storage and Processing, Faculty of Biotechnology and Food Science, Slovak University of Agriculture in Nitra, Tr. A. Hlinku 2, 949 76 Nitra, Slovak Republic, E-mail: eva.ivanisova@uniag.sk

Marián Tokár, Department of Plant Storage and Processing, Faculty of Biotechnology and Food Science, Slovak University of Agriculture in Nitra, Tr. A. Hlinku 2, 949 76 Nitra, Slovak Republic, E-mail: marian.tokar@uniag.sk

Miroslava Kačániová, Department of Microbiology, Faculty of Biotechnology and Food Sciences, Slovak University of Agriculture in Nitra, Nitra 949 76, Slovak Republic, E-mail: miroslava.kacaniova@uniag.sk

Luboš Harangozo, Department of Chemistry, Faculty of Biotechnology and Food Sciences, Slovak University of Agriculture in Nitra, Tr. A. Hlinku 2, 949 76 Nitra, Slovak Republic, E-mail: lubos.harangozo@uniag.sk

MICROBIOLOGICAL QUALITY OF CHICKEN BREAST MEAT AFTER APPLICATION OF THYME AND CARAWAY ESSENTIAL OILS

Simona Kunová, Lucia Zeleňáková, Ľubomír Lopašovský, Martin Mellen, Jozef Čapla, Peter Zajác, Miroslava Kačániová

ABSTRACT

The aim of the present study was to evaluate the effect of selected types of antimicrobial essential oils to the various groups of microorganisms during storage of chicken meat. The samples of chicken breast meat were used in the experiment. The number of lactobacilli, *Pseudomonas* spp., anaerobic plate count and *Enterobacteriaceae* after application of caraway and thyme essential oils (EO) at concentration 1% v/w in a combination with the ethylenediaminetetraacetate (EDTA) solution 1.5% w/w and vacuum packaging were evaluated. The samples were analyzed at 0, 4th, 8th, 12th and 16th day of storage of chicken meat at temperature 4 °C. Another aim was to determine the species of isolated microorganisms from samples of chicken meat by MALDI-TOF MS Biotyper (matrix assisted laser desorption ionization-time of flight mass spectrometry). The number of *Lactobacillus* spp. ranged from 1.35 log CFU.g⁻¹ in all groups to 3.04 log CFU.g⁻¹ on 0th day to 3.04 log CFU.g⁻¹ on 4th day in control group stored in air. The *Pseudomonas* spp. was not found in all tested samples at the start of the experiment, the highest number of *Pseudomonas* spp. was in the control group on 16th day (2.68 log CFU.g⁻¹). Presence of *Pseudomonas* spp. were not found during storage in groups after treatment with caraway and thyme EO. The values of anaerobic plate count ranged from 2.81 log CFU.g⁻¹ on 4th day in control group with vacuum packaging to 5.19 log CFU.g⁻¹ on 16th day in control group in air condition. The *Enterobacteriaceae* was not found in all tested samples on 0th day and ranged to 4.46 log CFU.g⁻¹ on 12th day in control group in air condition. From *Lactobacillus* spp., the most often identified species was *Lactobacillus paracasei*, from genus *Pseudomonas*, there were identified *Pseudomonas fluorescens* in two cases. From anaerobic plate count, there were isolated *Staphylococcus warneri* from control group stored in air condition, *Kocuria rhizophila* from control group with vacuum packaging, *Staphylococcus warneri*, *Aeromonas salmonicida* and *Aeromonas popoffii* from control group treated with EDTA, *Staphylococcus hominis* and *Staphylococcus epidermidis* from group treated with caraway essential oil. From *Enterobacteriaceae*, the most bacteria were isolated from control group in air condition and from control group treated with EDTA.

Keywords: chicken meat; thyme; caraway; essential oils; microorganisms

INTRODUCTION

Meat hygiene is determined by different environmental factors, which could result in meat spoilage and food safety problems. The growth of bacteria is the main cause of the reduction of freshness for chilled meat (Ercolini et al., 2009).

Consumers in the present time are demanding for minimally processed food products without chemical preservatives. Thus, the food industry has focused on the development of active packaging where active compound/s directly or indirectly interact with the packaged food products by avoiding the production of undesired compounds and restricting the growth of pathogens (Jideani and Vogt, 2016).

Meat consumption is an important for human development and health maintenance, which is why safety of meat and meat products is of growing concern in modern society (Cardoso Pereira and Vicente, 2013). A major issue related with meat consumption is the presence of pathogens, which can cause food-borne diseases (Sofos, 2008). Raw meat is an ideal growth medium for many pathogens and spoilage bacteria. *Salmonella* spp., *Campylobacter* spp., *Listeria monocytogenes*, *Escherichia coli*, *Staphylococcus aureus* are most common pathogens which cause a million episodes of illness every year (Boskovic et al., 2013).

Poultry meat is a very popular food commodity due to its low production costs, low content of fat, high nutritional value and distinct flavor (Patsias et al., 2008).

Poultry meat, namely parts containing skin, have a higher initial contamination rate than e. g. beef or pork and it thus is a fast perishable product, which deteriorates after 4 – 10 days post slaughter, even under cold conditions (Meredith et al., 2014).

In recent years, attention has been focused on herbs and spices extracts, which have been used for centuries to improve the sensory characteristics and shelf-life of foods (Fernandez-Gines et al., 2005).

The antimicrobial activities of essential oils are correlated to the presence of their bioactive volatile components (Mahmoud and Croteau, 2002). Chemically the essential oils contain terpene compounds (mono-, sesqui- and diterpenes), alcohols, acids, esters, epoxides, aldehydes, ketones, amines and sulfides. The components of essential oils are divided into two groups: terpene compounds and aroma compounds (Bakkali et al., 2008).

The composition, structure as well as functional groups of the essential oils are very important in determining their antimicrobial activity. Compounds with phenolic groups are most effective against microbial population (Dorman and Deans, 2000).

Carum carvi, which is also known as caraway, is one of the oldest spices cultivated in Europe. The dried ripe fruits (schizocarp) of *C. carvi* L. family *Apiaceae* (*Umbelliferae*) are extensively being used in folk medicine as a carminative, found to be effective against spasmodic gastrointestinal complaints, irritable stomach, indigestion, lack of appetite and dyspepsia in adults, and in relieving flatulent colic of infants (Thippeswamy et al., 2013). Caraway has been used traditionally as a spice due to its pleasant flavor. Caraway seeds and crude extracts are used as a flavoring of bread (e.g., rye bread), cheese, sauerkraut, candies, meat products, pickled fruits, sauces, and chewing gums. Ground caraway seeds are used as a component of teas and herbal mixtures (Johri, 2011). Caraway essential oils are usually volatile, odorous, and may contain up to 100 individual components that are composed mostly from monoterpenes, sesquiterpenes, phenylpropanoids, and isothiocyanates. The oil possesses bactericidal, virucidal, fungicidal, analgesic, sedative, antiinflammatory, spasmolytic, and anesthetic activities (Raal et al., 2003).

Thyme (*Thymus vulgaris* L.), belonging to the *Lamiaceae* family, is a well-known spice plant which possesses very good medicinal properties. The major components of *Thymus vulgaris* oil and extract are thymol, p-cymene, carvacrol, and γ -terpinene. They show very strong antibacterial, antifungal and antioxidant activities. Thyme essential oils retard food spoilage and increase the shelf-life of foods (Mandal and DebMandal, 2016).

The aim of the present study was to monitor the microbiological quality of chicken breast after treatment by selected essential oils (caraway, thyme) soluted in ethylenediaminetetraacetate (EDTA) in combination with vacuum packaging stored at 4 °C.

MATERIAL AND METHODOLOGY

Preparation of samples

The aim of the present study was to monitor the effect of caraway (*Carum carvi*) and thyme (*Thymus vulgaris* L.) essential oils to microbiological quality of chicken meat

during 16 days of storage. Samples of chicken breast muscles were used to experiment.

Microbiological analyzes were performed on 0th, 4th, 8th, 12th and 16th day of storage at 4 ± 0.5 °C.

The chicken breast samples were prepared as follow:

-control group (CG) – chicken breast samples were packaged to polyethylene bags and stored aerobically at 4 ± 0.5°C;

-control group vacuum-packaged (C vacuum) – chicken breast samples were packaged to polyethylene bags and stored anaerobically at 4 ± 0.5°C;

-control group vacuum-packaged with EDTA (C EDTA) – chicken breast samples were treated with EDTA solution, 1.5% w/w for 1 minute and samples were packaged to polyethylene bags and stored anaerobically at 4 ± 0.5°C;

-vacuum-packaged samples with *Carum carvi* 1% v/w – chicken breast samples were treated with caraway essential oil (*Carum carvi*) (Hanus, Nitra, Slovakia) for 1 minute and samples were packaged to polyethylene bags and stored anaerobically at 4 ± 0.5°C;

-vacuum-packaged samples with *Thymus vulgaris* L. 1% v/w – chicken breast samples were treated with thyme essential oil (*Thymus vulgaris* L.) (Hanus, nitra, Slovakia) for 1 minute and samples were packaged to polyethylene bags and stored anaerobically at 4 ± 0.5°C;

Vacuum packing machine VB-6 (RM Gastro, Česká republika) was used to vacuum packaging of samples. Each sample was packed immediately after treatment with the EDTA solution (pH 8.0, 99.5% purity, Invitrogen, USA). The final concentration of EDTA solution used for the treatment of meat samples was 50 mM.

Microbiological analysis

The following groups of microorganisms were determined in samples of chicken breast:

-*Lactobacillus* spp.

-*Pseudomonas* spp.

-Anaerobic plate count

-*Enterobacteriaceae*

Plate dilution method was used for the quantitative determination of the number of colony forming units (CFU) of each group of microorganisms. An amount of 5 g of the chicken breast was took using sterile scalpels and transferred into a sterile stomacher bag containing 45 mL of 0.1% physiological solution (pH 7.0) and homogenized for 60 seconds. Microbiological analyses were conducted with accordance to standard microbiological methods. De Man, Rogosa, Sharpe agar (MRS, Oxoid, UK) was used for isolation of *Lactobacillus* spp. Inoculated agar was incubated in a thermostat (CO₂ incubator ATP.Line CB, Binder GmbH, Tuttlingen, Germany) with 5% CO₂ in atmosphere at 37 °C for 48 – 72 hours. Pseudomonas Isolation Agar (PIA, Oxoid, UK) was used for isolation of *Pseudomonas* spp. Inoculated agar was incubated at 35 °C ± 1 °C during 48 hours. Plate Count Agar (PCA, Oxoid, UK) was used to isolation of Anaerobic plate count. PCA agar was after inoculation incubated at 35 °C for 48 hours in anaerobic conditions. Violet Red Bile Glucose agar (VRBL, Oxoid, UK) was used to isolation of *Enterobacteriaceae*. Inoculated agar was incubated at 37 °C for 24 hours.

Identification of microorganisms by MALDI-TOF MS

MALDI-TOF MS (Bruker Daltonics, Germany) was used to identification of microorganisms from meat samples.

The matrix (HCCA) preparation:

The matrix solution used was a saturated solution of α -cyano-4-hydroxycinnamic acid (HCCA) (Bruker Daltonics, Germany) dissolved in 50% acetonitrile, 47.5% ultra-pure water, 2.5% trifluoroacetic acid. The solution was used as the organic solvent. Then 1 mL of organic solvent was prepared by addition of 500 μ L of 100% acetonitrile, 475 μ L of ultra-pure water and 25 μ L of 100% tri-fluoro acetic acid, the mixture was mixed thoroughly. There were added 250 μ L of organic solvent to HCCA and vortexed.

Isolated colonies were taken and suspended in 300 mL of distilled water and mixed thoroughly. There were added 900 μ L of ethanol (99.8%). The mixture was centrifuged at $13\ 000 \times g$ for 2 minutes. The supernatant was discarded, then the pellet was centrifuged again. Residual ethanol was removed and the pellet was allowed to dry at room temperature. There was added 50 μ L of 70% formic acid and mixed thoroughly. Then, 50 μ L of acetonitrile was added and solution was centrifuged at maximum speed for 2 minutes. Then 1 μ L of the supernatant was spotted on a polished MALDI target plate (Bruker Daltonics, Germany). After drying 1 μ L of the matrix solution was added to each spot and allowed to air dry and samples were processed in the MALDI-TOF MS.

RESULTS AND DISCUSSION

Naturally occurring antimicrobial compounds can be used as food preservatives. Essential oils and other extracts from herbs and spices, have shown antimicrobial activity against many pathogens and spoilage microorganisms (Bakkali et al., 2008).

The number of *Lactobacillus* spp. in chicken breast ranged from 1.35 log CFU.g⁻¹ on 0th day to 3.04 log CFU.g⁻¹ on 4th day of storage in control group stored in air. The number of *Lactobacillus* spp. ranged from od 1.35 log CFU.g⁻¹ on 0th day to 2.69 log CFU.g⁻¹ on 12th day of storage in samples of control group treated with EDTA.

The number of *Lactobacillus* spp. ranged from 1.35 log CFU.g⁻¹ on 0th day to 3.00 log CFU.g⁻¹ on 8th day of storage in the control group with vacuum packaging. In the group after treatment with caraway essential oil, the number of *Lactobacillus* spp. ranged from 1.35 log CFU.g⁻¹ on 0th day to 2.63 log CFU.g⁻¹ on 16th day and in the group after treatment with thyme essential oil, the number of *Lactobacillus* spp. ranged from 1.35 log CFU.g⁻¹ on 0th day to 2.86 log CFU.g⁻¹ on 8th day (figure 1).

Zhang et al. (2016) studied the antimicrobial effect of rosemary (RO) and clove (CL) essential oils in chicken meat during storage against total viable counts (TVC), lactic acid bacteria (LAB) counts, *Enterobacteriaceae* counts and *Pseudomonas* spp. The antimicrobial and effects of two spice extracts and their combination on raw chicken meat during storage for 15 days at 4 °C were studied. Initial lactic acid bacteria (LAB) counts ($p < 0.05$) were found to be 4.26 log CFU.g⁻¹ for all meat samples. The values increased in C and PC samples and reached 6.20 and 5.96 log CFU.g⁻¹ at the end of the storage period. LAB counts were found to be lower ($p < 0.05$) in spice-treated samples relative to those measured for the control samples. During storage, chicken fillet samples treated with RO-CL showed a lower LAB count compared with the counts measured for the control and CL- and RO-treated samples. On day 15 of storage, LAB counts reached 5.47, 5.43 and 5.08 log CFU.g⁻¹ for the RO, CL, and RO-CL samples, respectively.

LAB are the most resistant bacteria among gram-positive bacteria against the antimicrobial action of EOs (Kostaki et al., 2009). Holley and Patel (2005) reported that the high tolerance of LAB toward the action of essential oils is attributed to their ability to generate ATP and to tolerate conditions of osmotic stress.

In the control group stored in air condition, the number of *Pseudomonas* spp. ranged from 0 log KTJ.g⁻¹ 0th day to 2.68 log CFU.g⁻¹ on 16th day. In the control group stored in vacuum packaging, the number of *Pseudomonas* spp. ranged 0 log CFU.g⁻¹ on 0th and 4th day to 2.13 log CFU.g⁻¹ on 12th day. In the control group after treatment with EDTA, the number of *Pseudomonas* spp. ranged from 0 log CFU.g⁻¹ on 0th and 4th day to 2.13 log CFU.g⁻¹ on 12th day of storage. Presence of *Pseudomonas* spp. were not

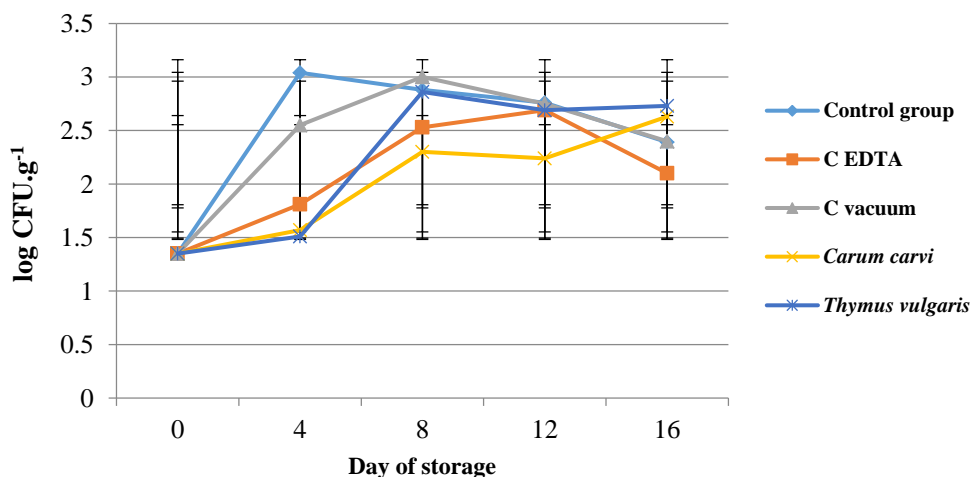

Figure 1 Number of *Lactobacillus* spp. in the chicken breast during storage.

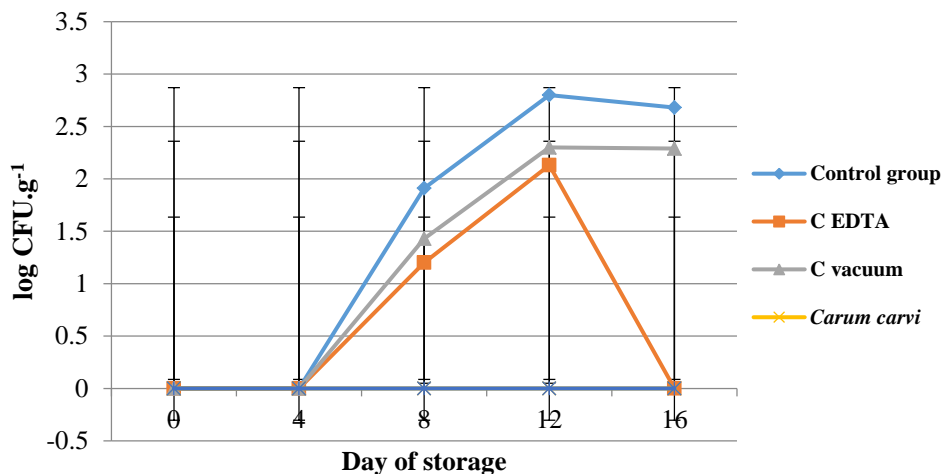

Figure 2 Number of *Pseudomonas* spp. in the chicken breast during storage.

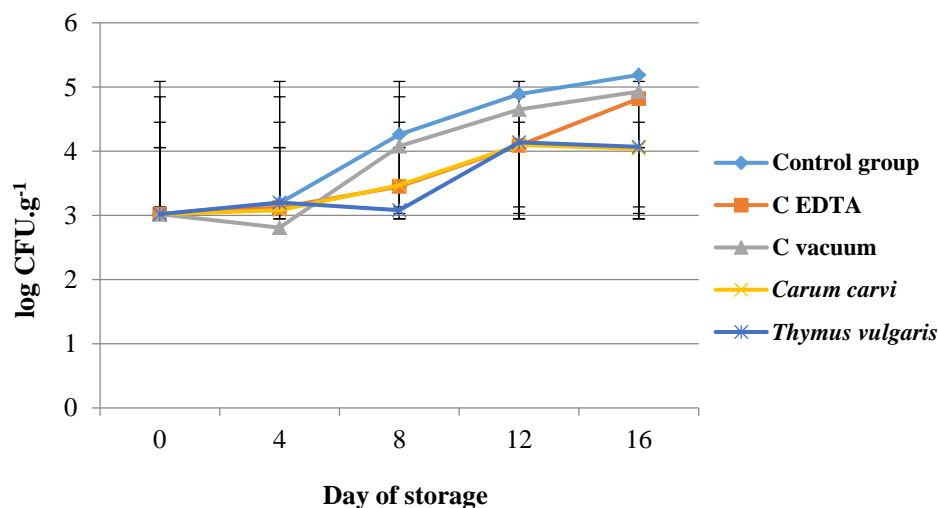

Figure 3 Anaerobic plate count values in the chicken breast during storage.

found during storage in groups after treatment with caraway and thyme essential oils (Figure 2).

Zhang et al. (2016) investigated the antimicrobial activity of rosemary, clove and clove-rosemary essential oils in their study. Rosemary essential oil showed a low inhibition effect. But the clove and clove-rosemary essential oils showed significant inhibition effects on the *Pseudomonas*. The combination of essential oils was the most effective in reducing the population of pseudomonas from 5.6 (control samples) to 4.76 log CFU.g⁻¹ after 15 days of storage ($p < 0.05$).

Lv et al. (2011) evaluated the antimicrobial activity of selected plant essential oil combinations against four food-related microorganisms. Ten essential oils were tested against *Escherichia coli*, *Staphylococcus aureus*, *Bacillus subtilis* and *Saccharomyces cerevisiae* using agar disk diffusion and broth dilution methods. The highest activity against tested bacteria was shown when testing the oregano essential oil. Basil and bergamot essential oils were active against the Gram-positive bacteria (*S. aureus* and *B. subtilis*), while perilla essential oil strongly inhibited the growth of yeast (*S. cerevisiae*).

The values of anaerobic plate count ranged from 3.02 log CFU.g⁻¹ on 0th day to 5.19 log CFU.g⁻¹ on 16th day in the control group stored in air condition. The values anaerobic plate count ranged from 3.02 log CFU.g⁻¹ on 0th day to 4.82 log CFU.g⁻¹ on 16th day in the control group in vacuum packaging and treated with EDTA. The values of anaerobic plate count ranged from 2.81 log CFU.g⁻¹ on 4th day to 4.93 log CFU.g⁻¹ on 16th day in the control group in vacuum packaging. The values of anaerobic plate count ranged from 3.02 log CFU.g⁻¹ on 0th day to 4.04 log CFU.g⁻¹ on 16th day in group after treatment with caraway essential oil. The values of anaerobic plate count ranged from 3.02 log CFU.g⁻¹ on 0th day to 4.14 log CFU.g⁻¹ on 12th day in group treated with thyme essential oil (Figure 3).

Ghabraie et al. (2016) studied the antibacterial activity of 32 essential oils against four pathogenic bacteria (*Escherichia coli*, *Listeria monocytogenes*, *Staphylococcus aureus* and *Salmonella Typhimurium*) and one spoilage bacterium (*Pseudomonas aeruginosa*). In solid phase, red thyme, red bergamot, ajowan, summer savory, chinese cinnamon and cinnamon bark had higher inhibitory zone (20 – 40 mm) against five tested bacteria compared with

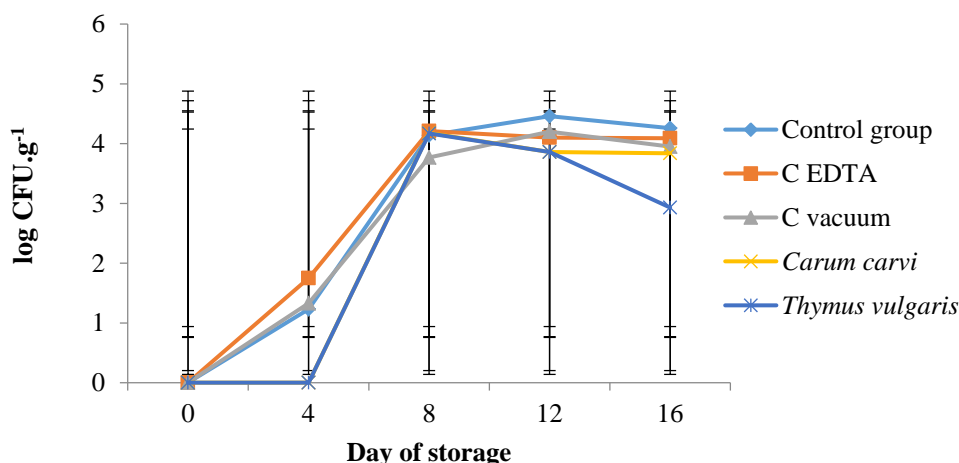

Figure 4 Number of *Enterobacteriaceae* in chicken breast during storage.

other essential oils. Red thyme, red bergamot, ajowan, summer savory inhibited *S. aureus* by more than 60 mm. In vapour phase, at 30 μL of tested essential oils, chinese cinnamon and red bergamot were the only essential oils that inhibited all bacteria with the inhibition zone from 20 to more than 60 mm depending on target bacteria. In liquid phase, chinese cinnamon showed the best antibacterial activity among all essential oils and it inhibited *S. aureus* and *E. coli* at low minimum inhibitory concentration of 470 ppm.

In the control group stored in air condition, the number of *Enterobacteriaceae* genera ranged from 0 log CFU.g⁻¹ on 0th day to 4.46 log CFU.g⁻¹ on 12th day. In the control group treated with EDTA, the number of *Enterobacteriaceae* genera ranged from 0 log CFU.g⁻¹ on 0th day to 4.21 log CFU.g⁻¹ on 8th day. In the control group in vacuum packaging, the number of *Enterobacteriaceae* genera ranged from 0 log CFU.g⁻¹ on 0th day to 4.20 log CFU.g⁻¹ on 12th day. In the group treated with caraway essential oil, the number of *Enterobacteriaceae* genera ranged from 0 log CFU.g⁻¹ on 0th day to 4.18 log CFU.g⁻¹ on 8th day. In the group treated with thyme essential oil, the number of *Enterobacteriaceae* genera ranged from 0 log CFU.g⁻¹ on 0th day to 4.17 log CFU.g⁻¹ on 8th day (figure 4).

Boskovic et al. (2015) investigated the antibacterial activity of thyme and oregano essential oil against food-borne bacteria. They reported antibacterial activity of these essential oils against *Salmonella* Enteritidis, *Salmonella* Thyphimurium, *Staphylococcus aureus*, methicillin resistant *Staphylococcus aureus*, *Escherichia coli* and *Bacillus cereus*.

Essential oils possess the strongest antibacterial properties when contain a high percentage of phenolic compounds. Oregano essential oil contains a high concentration of phenols, which showed a higher antimicrobial activity compared to thyme essential oil (Burt, 2004).

Antimicrobial mechanism of the two major constituents carvacrol and thymol, is based on their ability to disintegrate the outer membrane of Gram-negative bacteria, releasing lipopolysaccharides and increasing the

permeability of the cytoplasmic membrane to ATP (Lambert et al., 2001).

Oregano and thyme essential oils showed great inhibitory activity against observed microorganisms, but higher concentration of these were needed to achieve bactericidal effects. Although oregano and thyme essential oils exhibited strong antibacterial activity, further researches are needed in order to determinate their antibacterial effects on pathogens in meat model media (Ultee et al., 2002).

Kluz et al. (2016) reported, that caraway and anise essential oils exhibited good antimicrobial properties against anaerobic bacteria, lactic acid bacteria and *Enterobacteriaceae* at 0.2% concentration.

Mass spectrometry has been used for bacterial identification since 1975 (Anhalt and Fenselau, 1975), but a significant progress was marked by the introduction of MALDI-TOF MS (Hillenkamp et al., 1991). In the present time, MALDI-TOF MS represents the most frequently used MS technique for a rapid and specific identification of bacteria. The MALDI-TOF technique is a soft ionization method allowing desorption of peptides and proteins from whole cells of cultured microorganisms. Due to the fact that bacterial cells have a high content of proteins and these proteins directly represent genetic information of the organism, the profiles of proteins are useful for identification of bacteria. Over the last years, MALDI-TOF MS technology (matrix-assisted laser desorption/ionization time-of-flight mass spectrometry) has proved to be a rapid method for the accurate identification of different microorganisms (Patel, 2015).

From genus *Lactobacillus*, there were identified *Lactobacillus paracasei* in three cases, *Lactobacillus reuteri* and *Lactobacillus salivarius* in two cases. From genus *Pseudomonas*, there were identified *Pseudomonas fluorescens* in two cases, *Pseudomonas azotoformans*, *Pseudomonas taetrolens*, *Pseudomonas synxantha*, *Pseudomonas orientalis*, *Pseudomonas fragi* and *Pseudomonas veronii* in one case. Species of *Pseudomonas* spp. were isolated from control group stored in air condition, control group treated with EDTA and control group in vacuum packaging (table 1).

Table 1 Isolated microorganisms of *Lactobacillus* spp. And *Pseudomonas* spp. in samples of chicken breast.

Samples	<i>Lactobacillus</i> spp.	<i>Pseudomonas</i> spp.
CG	<i>Lactobacillus reuteri</i> , <i>Lactobacillus paracasei</i>	<i>Pseudomonas fluorescens</i> , <i>Pseudomonas azotoformans</i> ,
CG-V	<i>Lactobacillus reuteri</i> <i>Lactobacillus salivarius</i>	<i>Pseudomonas taetrolens</i> , <i>Pseudomonas fluorescens</i> , <i>Pseudomonas synxantha</i> , <i>Pseudomonas orientalis</i> ,
CG-KEDTA	<i>Lactobacillus salivarius</i>	<i>Pseudomonas fragi</i> , <i>Pseudomonas veronii</i> ,
<i>Carum carvi</i>	<i>Lactobacillus paracasei</i>	
<i>Thymus vulgaris</i> L.	<i>Lactobacillus paracasei</i>	

Note: CG – control group stored in air condition, CG-V - control group with vacuum packaging, CG-KEDTA - control group treated with EDTA, *Carum carvi* - group treated with caraway essential oil, *Thymus vulgaris* L. - group treated with thyme essential oil.

Table 2 Isolated microorganisms of anaerobic plate count and *Enterobacteriaceae* in samples of chicken breast.

Samples	Anaerobic plate count	<i>Enterobacteriaceae</i>
CG	<i>Staphylococcus pasteurii</i>	<i>Serratia fonticola</i> , <i>Yersinia pseudotuberculosis</i> , <i>Buttiauxella noackiae</i> , <i>Buttiauxella agrestis</i> , <i>Hafnia alvei</i> , <i>Citrobacter freundii</i> , <i>Escherichia coli</i>
CG-V	<i>Kocuria rhizophila</i>	
CG-EDTA	<i>Staphylococcus warneri</i> , <i>Aeromonas salmonicida</i> , <i>Aeromonas popoffii</i> ,	<i>Serratia fonticola</i> , <i>Rahnella aquatilis</i> , <i>Serratia liquefaciens</i> , <i>Buttiauxella noackiae</i>
<i>Carum carvi</i>	<i>Staphylococcus hominis</i> , <i>Staphylococcus epidermidis</i> ,	<i>Serratia liquefaciens</i> ,
<i>Thymus vulgaris</i> L.		<i>Citrobacter freundii</i> , <i>Buttiauxella noackiae</i> , <i>Buttiauxella gaviniae</i>

Note: CG – control group stored in air condition, CG-V - control group with vacuum packaging, CG-KEDTA - control group treated with EDTA, *Carum carvi* - group treated with caraway essential oil, *Thymus vulgaris* L. - group treated with thyme essential oil.

Jääskeläinen et al. (2016) investigated the influence of packaging (under vacuum and in high oxygen atmosphere) on the development of microbial communities and metabolic activities at 6 °C. At the beginning of storage, the microbial community mostly consisted of *Carnobacterium* and *Lactobacillus*. After two weeks of storage, *Lactococcus* and *Lactobacillus* were the dominant genera under vacuum and *Leuconostoc* in high oxygen meat packages. This indicates that oxygen favoured the genus *Leuconostoc* comprising only heterofermentative species and hence potential producers of undesirable compounds. *Leuconostoc gelidum*, *Lactococcus piscium*, *Lactobacillus sakei* and *Lactobacillus algidus* were the most common species of bacteria.

Pseudomonas spp., especially *P. fragi*, play a significant role in the spoilage of meat (Lebert et al., 1998). In several previous studies, *P. fragi* has been detected in almost all samples during the storage of beef in modified-atmosphere packaging (MAP) and vacuum packaging (Pennacchia et al., 2011).

In the study of Ercolini et al. (2011), the changes in microbial loads, microbial diversity, and metabolite release in meat during storage in air, modified-atmosphere packaging (MAP), vacuum packaging, and active vacuum packaging were evaluated. Their Results showed that *Brochothrix thermosphacta* dominated during the early stages of storage in air and MAP, while *Pseudomonas* spp. took over during further storage in air. Many different bacteria, several of which are usually associated with soil

rather than meat, were identified in vacuum packaging and active vacuum packaging; however, lactic acid bacteria (LAB) dominated during the late phases of storage, and *Carnobacterium divergens* was the most frequent microorganism in active vacuum packaging.

From anaerobic plate count, there were isolated *Staphylococcus warneri* from control group stored in air condition, *Kocuria rhizophila* from control group with vacuum packaging, *Staphylococcus warneri*, *Aeromonas salmonicida* and *Aeromonas popoffii* from control group treated with EDTA, *Staphylococcus hominis* and *Staphylococcus epidermidis* from group treated with caraway essential oil.

From *Enterobacteriaceae*, there were isolated *Buttiauxella noackiae* from control group stored in air condition, control group treated with EDTA and group treated with thyme essential oil. *Serratia fonticola* was isolated in two cases, from control group stored in air condition and from control group treated with EDTA. *Serratia liquefaciens* was isolated from control group treated with EDTA and group treated with caraway essential oil. *Yersinia pseudotuberculosis* and *Buttiauxella agrestis* were isolated from control group stored in air condition, *Hafnia alvei* and *Escherichia coli* were isolated from control group with vacuum packaging, *Rahnella aquatilis* was isolated from control group treated with EDTA, *Citrobacter freundii* and *Buttiauxella gaviniae* were isolated from group treated with thyme essential oil (Table 2).

Several authors detected many members of the *Enterobacteriaceae* on raw beef, lamb, pork, and poultry products. The genera *Serratia*, *Enterobacter*, *Pantoea*, *Klebsiella*, *Proteus* and *Hafnia*, often contribute to meat spoilage. Considering to their meat spoilage potential, the most important *Enterobacteriaceae* are the species *Serratia liquefaciens*, *Hafnia alvei* and *Enterobacter (Pantoea) agglomerans* (Samelis, 2006). Among the *Enterobacteriaceae*, *Serratia* spp. is the most often found genus in meat. *Serratia grimesii* and *Serratia proteamaculans* occur in meat stored in air, MAP and in meat stored in vacuum packaging; although *S. grimesii* is often found at later stages of storage (Pennacchia et al., 2011).

Doulgeraki et al. (2011) reported, that *Citrobacter freundii* was isolated from minced beef stored aerobically, while *Hafnia alvei* and *Proteus vulgaris* were isolated from meat storage under MAP. Storage conditions affected the *Enterobacteriaceae* community; modified atmosphere packaging increased both species and strain diversity.

CONCLUSION

The results of the present study show, that caraway and thyme essential oils can be use as natural food preservatives and they are also good source of antimicrobial ingredients for meat. Shelf-life of packaged fresh meat is very short in view of the fact, that its composition is the ideal environment for the growth and reproduction of spoilage and pathogenic microorganisms. High protein content and water activity promotes microbial spoilage of meat. The basic prerequisite for maintaining the quality and safety of meat is the prevention of microbial contamination.

Nowadays, the synthetic preservatives are often used to extend the shelf-life of meat. However consumers are interested in the natural substances limiting the growth of microorganisms in food. Essential oils and extracts can be used in meat and meat products as natural conservants.

REFERENCES

Anhalt, J. P., Fenselau, C. 1975. Identification of bacteria using mass spectrometry. *Analytical Chemistry*, vol. 47, no. 2, p. 219-225. <https://dx.doi.org/10.1021/ac60352a007>

Bakkali, F., Averbeck, S., Averbeck, D., Idaomar, M. 2008. Biological effects of essential oils – a review. *Food and Chemical Toxicology*, vol. 46, no. 2, p. 446-475. <https://dx.doi.org/10.1016/j.fct.2007.09.106> PMID:17996351

Boskovic, M., Baltic. Z. M., Ivanovic, J., Djuric, J., Loncina, J., Dokmanovic, M., Markovic, R. 2013. Use of essential oils in order to prevent foodborne illnesses caused by pathogens in meat. *Tehnologija mesa*, vol. 54, no. 1, p. 14-20.

Boskovic, M., Zdravovic, N., Ivanovic, J., Janjic, J., Diordjevic, J., Starcevic, M., Baltic, M. Z. 2015. Antimicrobial Activity of Thyme (*Tymus vulgaris*) and Oregano (*Origanum vulgare*) Essential Oils against Some Food-borne Microorganisms. *Procedia Food Science*, vol. 5, p. 18-21. <https://dx.doi.org/10.1016/j.profoo.2015.09.005>

Burt S. 2004. Essential oils: their antibacterial properties and potential applications in foods – a review. *International Journal of Food Microbiology*, vol. 94, no. 3, p. 223-53. <https://dx.doi.org/10.1016/j.ijfoodmicro.2004.03.022> PMID:15246235

Cardoso Pereira, P. M. C., Vicente, A. F. R. B. 2013. Meat nutritional composition and nutritive role in the human diet. *Meat Science*, vol. 93, no. 3, p. 586-92. <https://dx.doi.org/10.1016/j.meatsci.2012.09.018> PMID:23273468

Dorman, H. J. D., Deans, S. G. 2000. Antimicrobial agents from plants: antibacterial activity of plant volatile oils. *Journal of Applied Microbiology*, vol. 88, no. 2, p. 308-316. <https://dx.doi.org/10.1046/j.1365-2672.2000.00969.x> PMID:10736000

Doulgeraki, A. I., Paramithiotis, S., Nychas, G. J. E. 2011. Characterization of the *Enterobacteriaceae* community that developed during storage of minced beef under aerobic or modified atmosphere packaging conditions. *International Journal of Food Microbiology*, vol. 145, no. 1, p. 77-83. <https://dx.doi.org/10.1016/j.ijfoodmicro.2010.11.030> PMID:21216482

Ercolini, D., Russo, F., Nasi, A., Ferranti, P., Villani, F. 2009. Mesophilic and psychrotrophic bacteria from meat and their spoiling potential in vitro and in beef. *Applied and Environmental Microbiology*, vol. 75, no. 7, p. 1990-2001. <https://dx.doi.org/10.1128/AEM.02762-08> PMID:19201980

Ercolini, D., Ferrocino, I., Nasi, A., Ndagijimana, M., Vernocchi, P., La Stora, A., Laghi, L., Mauriello, G., Guerzoni, M. E., Villani, F. 2011. Monitoring of microbial metabolites and bacterial diversity in beef stored in different packaging conditions. *Applied Environmental Microbiology*, vol. 77, no. 20, p. 7372-7381. <https://dx.doi.org/10.1128/AEM.05521-11> PMID:21803905

Fernandez-Gines, J. M., Fernandez-Lopez, J., Sayas-Barbera, E., Perez-Alvarez, J.A. 2005. Meat products as functional foods: a review. *Journal of Food Science*, vol. 70, no. 2, p. 37-43. <https://dx.doi.org/10.1111/j.1365-2621.2005.tb07110.x>

Ghabraie, M., Vu, K. D., Tata, L., Salmieri, S. 2016. Antimicrobial effect of essential oils in combinations against five bacteria and their effect on sensorial quality of ground meat. *Monique Lacroix LWT – Food Science and Technology*, vol. 66, p. 332-339.

Hillenkamp, F., Karas, M., Beavis, R. C., Chait, B. T. 1991. Matrix-assisted laser desorption/ionization mass spectrometry of biopolymers. *Analytical Chemistry*, vol. 63, no. 24, p. 1193A-1203A. <https://dx.doi.org/10.1021/ac00024a71> 6 PMID:1789447

Holley, R. A., Patel, D. 2005. Improvement in shelf-life and safety of perishable foods by plant essential oils and smoke antimicrobials. *Food Microbiology*, vol. 22, no. 4, p. 273-292. <https://dx.doi.org/10.1016/j.fm.2004.08.006>

Jääskeläinen, E., Hultman, J., Parshintsev, J., Riekkola, M. L., Björkroth, J. 2016. Development of spoilage bacterial community and volatile compounds in chilled beef under vacuum or high oxygen atmospheres. *International Journal of Food Microbiology*, vol. 223, p. 25-32. <https://dx.doi.org/10.1016/j.ijfoodmicro.2016.01.02> 2 PMID:26874863

Jideani, V. A., Vogt, K. 2016. Antimicrobial packaging for extending the shelf life of bread – A review. *Food Science and Nutrition*, vol. 56, no. 8, p. 1313-1324. <https://dx.doi.org/10.1080/10408398.2013.768198>

Johri, R. K. 2011. Cuminum cyminum and Carum carvi: an update. *Pharmacognosy Review*, vol. 5, no. 9, p. 63-72. <https://dx.doi.org/10.4103/0973-7847.79101> PMID:22096320

- Kluz, M., Terentjeva, M., Puchalski, C., Hutková, J., Kántor, A., Petrová, J., Mellen, M., Čuboň, J., Haščík, P., Kordiaka, R., Kunová, S., Kačániová, M. 2016. The extension of shelf-life of chicken meat after application of caraway and anise essential oils and vacuum packaging. *Potravinárstvo*, vol. 10, no. 1, p. 132-138. <https://dx.doi.org/10.5219/557>
- Kostaki, M., Giatrakou, V., Savvaidis, I. N., Kontominas, M. G. 2009. Combined effect of MAP and thyme essential oil on the microbiological, chemical and sensory attributes of organically aquacultured sea bass (*Dicentrarchus labrax*) fillets. *Food Microbiology*, vol. 26, no. 5, p. 475-482. <https://dx.doi.org/10.1016/j.fm.2009.02.008> PMID:19465243
- Lambert, R. J. W., Skandamis, P. N., Coote, P. J., Nychas, G. J. 2001. A study of the minimum inhibitory concentration and mode of action of oregano essential oil, thymol and carvacrol. *Journal of Applied Microbiology*, vol. 91, no. 3, p. 453-462. <https://dx.doi.org/10.1046/j.1365-2672.2001.01428.x> PMID:11556910
- Lebert, I., Begot, C., Lebert, A. 1998. Growth of *Pseudomonas fluorescens* and *Pseudomonas fragi* in a meat medium as affected by pH (5.8 – 7.0), water activity (0.97–1.00) and temperature (7 – 25 °C). *International Journal of Food Microbiology*, vol. 39, no. 1-2, p. 53-60. [https://dx.doi.org/10.1016/S0168-1605\(97\)00116-5](https://dx.doi.org/10.1016/S0168-1605(97)00116-5)
- Lv, F., Liang, H., Yuan, Q., Li, Ch. 2011. In vitro antimicrobial effects and mechanism of action of selected plant essential oil combinations against four food-related microorganisms. *Food Research International*, vol. 44, no. 9, p. 3057-3064. <https://dx.doi.org/10.1016/j.foodres.2011.07.030>
- Mahmoud, S. S., Croteau, R. B. 2002. Strategies for transgenic manipulation of monoterpene biosynthesis in plants. *Trends in Plant Science*, vol. 7, no. 8, p. 366-373. [https://dx.doi.org/10.1016/S1360-1385\(02\)02303-8](https://dx.doi.org/10.1016/S1360-1385(02)02303-8)
- Mandal, S., Debmandal, M. 2016. Thyme (*Thymus vulgaris* L.) Oils. *Essential Oils in Food Preservation, Flavor and Safety*, p. 825-834.
- Meredith, H., Valdramidis, V., Rotabakk, B. T., Sivertsvik, M., McDowell, D., BOLTON, D. J. 2014. Effect of different modified atmospheric packaging (MAP) gaseous combinations on *Campylobacter* and the shelf-life of chilled poultry fillets. *Food Microbiology*, vol. 44, p. 196-203. <https://dx.doi.org/10.1016/j.fm.2014.06.005> PMID:25084663
- Patel, R. 2015. MALDI-TOF MS for the diagnosis of infectious diseases. *Clinical Chemistry*, vol. 61, no. 1, p. 100-111. <https://dx.doi.org/10.1373/clinchem.2014.221770> PMID:25278500
- Patsias, A., Badeka, A. V., Savvaidis, I. N., Kontominas, M. G. 2008. Combined effect of freeze chilling, MAP on quality parameters of raw chicken fillets. *Food Microbiology*, vol. 25, no. 4, p. 575-581. <http://dx.doi.org/10.1016/j.fm.2008.02.008>
- Pennacchia, C., Ercolini, D., Villani, F. 2011. Spoilage-related microbiota associated with chilled beef stored in air or vacuum pack. *Food Microbiology*, vol. 28, no. 1, p. 84-93. <https://dx.doi.org/10.1016/j.fm.2010.08.010> PMID:21056779
- Raal, A., Arak, E., Orav, A., Ivask, K. 2003. Comparison of essential oil content of *Matricaria recutita* L. from different origins. *Ars Pharmaceutica*, vol. 44, no. 2, p. 159-165.
- Samelis, J. 2006. Managing microbial spoilage in meat industry. In Blackburn, C. W. *Food Spoilage Microorganisms*. Cambridge : Woodhead Publishing Limited, p. 213-286. ISBN 9781845691417.
- Sofos, J. N. 2008. Challenges to meat safety in the 21st century. *Meat science*, vol. 78, no. 1-2, p. 3-13. <https://dx.doi.org/10.1016/j.meatsci.2007.07.027> PMID:22062090
- Thippeswamy, N. B., Akhilender Naidu, K., Achur, R. N. 2013. Antioxidant and antibacterial properties of phenolic extract from *Carum carvi* L. *Journal of Pharmacy Research*, vol. 7, no. 4, p. 352-357. <https://dx.doi.org/10.1016/j.jopr.2013.03.028>
- Ultee, A., Bennik, M. H. J., Moezelaar, R. 2002. The phenolic hydroxyl group of carvacrol is essential for action against the food-borne pathogen *Bacillus cereus*. *Applied and Environmental Microbiology*, vol.68, no. 4, p. 1561-1568. <https://dx.doi.org/10.1128/AEM.68.4.1561-1568.2002> PMID:11916669
- Zhang, H., Wu, J., Guo, X. 2016. Effects of antimicrobial and antioxidant activities of spice extracts on raw chicken meat quality. *Food Science and Human Wellnes*, vol. 5, no. 1, p. 39-48. <https://dx.doi.org/10.1016/j.fshw.2015.11.003>

Acknowledgments:

This work was supported by grant VEGA No. 1/0411/17.

Contact address:

Simona Kunová, Slovak University of Agriculture in Nitra, Faculty of Biotechnology and Food Sciences, Department of Food Hygiene and Safety, Tr. A. Hlinku 2, 949 76 Nitra, Slovakia, E-mail: simona.kunova@uniag.sk

Martin Mellen, Hydina Slovakia, s. r. o., Nová Ľubovňa 505, 065 11 Nová Ľubovňa, Slovakia, E-mail: martin.mellen@gmail.com

Lucia Zeleňáková, Slovak University of Agriculture in Nitra, Faculty of Biotechnology and Food Sciences, Department of Food Hygiene and Safety, Tr. A. Hlinku 2, 949 76 Nitra, Slovakia, E-mail: lucia.zelenakova@uniag.sk

Lubomír Lopašovský, Slovak University of Agriculture in Nitra, Faculty of Biotechnology and Food Sciences, Department of Food Hygiene and Safety, Tr. A. Hlinku 2, 949 76 Nitra, Slovakia, E-mail: lubomir.lopasovsky@uniag.sk

Jožef Čapla, Slovak University of Agriculture in Nitra, Faculty of Biotechnology and Food Sciences, Department of Food Hygiene and Safety, Tr. A. Hlinku 2, 949 76 Nitra, Slovakia, E-mail: capla@potravinarstvo.com

Peter Zajác, Slovak University of Agriculture in Nitra, Faculty of Biotechnology and Food Sciences, Department of Food Hygiene and Safety, Tr. A. Hlinku 2, 949 76 Nitra, Slovakia, E-mail: zajac@potravinarstvo.com

Miroslava Kačániová, Slovak University of Agriculture in Nitra, Faculty of Biotechnology and Food Sciences, Department of Microbiology, Tr. A. Hlinku 2, 949 76 Nitra, Slovakia, E-mail: miroslava.kacaniova@uniag.sk



THE REGULATION OF THE FUNCTIONAL STATE OF SUBTROPICAL CROPS WITH MICRONUTRIENTS

Alexej Ryndin, Oksana Belous, Yuliya Abilfazova, Zoya Prytula

ABSTRACT

We studied the chemical composition of tea plants and tangerine at foliar application sulfates Mn, Zn, Cu, Fe, and of boric acid solution. At stopped growing leaves most accurately reflect the degree of security of the tea plant essential micronutrients, the content of which is more stable than in flush, where their concentration is not stable. Concentration of trace elements studied in the semi-finished product prepared from raw experimental batches, does not exceed the allowable state standard values. Our studied that leaf tangerine also revealed the existence of a positive impact on the accumulation of trace elements Mn, Zn, B and Fe as the leaves and fruits at a foliar application of these elements. Was studied that effect of micronutrient foliar application on the functional state of cultures. We showed that effect of trace elements on the adaptability of the plant tea and tangerine, which is reflected in the existence of a clear trend of increasing plant resistance to drought. For example, foliar fertilizing of manganese ($r = -0.69$) and zinc ($r = -0.73$) significantly reduces the concentration of cellular juice flushes of tea; tea processing manganese, zinc, iron contributes to a significant enhancement of the enzymatic activity of the experimental plant; stimulates growth processes, resulting in an increase in leaf area; increases the productivity of plants: the increase in years of research by 11.7 – 25.3 per cent higher than the control (average $65.8 \text{ kg} \cdot \text{ha}^{-1}$). Processing plants copper ($r = 0.68 - 0.72$), manganese ($r = 0.70 - 0.81$) and iron ($r = 0.82 - 0.69$) contribute to the increase in the content of tender fraction ($r = 0.59 - 0.71$) and content (3 – 4%) of tannin in raw materials. manganese and zinc at tangerine plants increased (1.3 – 1.5 times) the water-holding capacity of leaves, decreased water deficit (1.6 times) and promote adaptive responses of plants to stress factors (drought); addition of copper, manganese and boron resulted in the increase of all photosynthetic pigments. It can be concluded that the application of micronutrients is an additional reserve to increase the productivity of the culture of tea and tangerine.

Keywords: tea; tangerine; foliar fertilizing; microelements; sugars; acidity; ascorbic acid; sugar-acid index; market quality

INTRODUCTION

It is known that the adaptive capacity of plants is their resistance to certain stressors associated with providing an optimum fuel ratio (Shakirova, 2001; Abilfazova, 2002; Prytula, 2004; Milenkevich, 2006; Belous, 2006 and other). Therefore, it is appropriate to develop a set of technical measures that would contribute to realize the potential of plants in different agro-climatic conditions. The cultivation of crops should combine farming practices, which include not only fertilizer, but also the means and ways to improve their own plant resistance to the action of unfavorable environmental factors: physical, chemical and biological. This is especially true during prolonged cultivation on one place perennial cultivation.

It is known that as a result of prolonged use of high doses of mineral fertilizers in excess of plant macronutrients found causing micronutrient deficiencies (Milenkevich, 2006; Ryndin et al., 2009; Kourimska et al., 2014. Arvay et al., 2015).

Despite the relatively low doses needed to achieve the effect, minerals are very important part of food crops, including subtropical, since they either are part of enzymes or activate their work, stimulating the biological potential of plants (Belous, 2012; Bozhenko, 1976; Toma, 1983 and others). The researchers in the study of trace elements (in comparison with a variant without incorporation) was shown the inability of the normal development of plants in the absence of minerals, such as manganese, zinc, copper, and for some plants – iron (Abilfazova, 2000; Belous, 2006; Ryndin 2009; Sennovskaya 2006; Musilova et al., 2013 and others).

These elements were found absolutely necessary. The lack of microelements reduces crop productivity, and the complete absence - causes disease and death of plants due to the rapid metabolism disorders (Toma, 1983; Zehtab-Salmasi et al., 2008 and others). Plant nutrition trace elements in which they are deficient stabilizes metabolism. But this does not mean that the minerals can replace

making basic fertilizer. Moreover, the efficiency increases with the introduction of micronutrients against the background of complete fertilizer (Argesanu et al., 2009).

Research carried out by us for a long time that has shown that reducing stress subtropical crops caused by drought conditions, the application of micronutrients, which leads to an increase in the total resistance of plants.

To determine the effect of trace elements on the functionality and Subtropical Crops Production processes were established field trials with foliar feeding tea plants (1997 – 2007) and dwarf tangerine (1997 – 2002).

MATERIAL AND METHODOLOGY

The problem is solved at the level of field and laboratory studies. Laboratory tests carried out on the basis of laboratory biotechnology, plant physiology and biochemistry Institute of Floriculture and Subtropical Crops. Field experiments were located on the basis of Institute's "Experimental field" and tea plantations "Dagomyschay."

Object of research is physiologically homogeneous leaves (for tea and tangerine) and flushes (tea) the following crops:

- Tea plant (*Camellia sinensis* L.) varieties Karatum (landing 1990), dedicated in 1976 by clonal selection of plants of the Georgian population. The variety has macrophylla, has a strong ability for shoot-forming capacity (Tuov, 1998). Tea leaf is characterized by high biochemical parameters. The sort was transferred to a Government grade testing institution in 1991, and passed the regionalization in 1996;

- Plant dwarf tangerine (*Citrus unshiu* Marc.) varieties Miagava-Base grafted on *Pontirus trifoliata* (landing 1986).

Determination of physiological and biochemical characteristics of the condition of the plants was performed by classical methods: the concentration of the cell sap (CCS) flashes using the refractometric method by Filippov (Filippov, 1968); water scarcity (Baslavskaya, Trubetskova, 1964); heat drought factor – by Kouchnirenko (Kouchnirenko, 1986); Activity of catalase enzyme – gasometric technique (Gunnar, 1972); content of photosynthetic pigments by AA Shlyk, using the calculation formulas Ziegler and Egle (Shlyk, 1971).

While conducting research on the influence of trace elements on tea plants and tangerine before laying experience during and after the studies were selected samples of soil in the root zone 0 – 20 and 20 – 40 cm, in the period of relative quiescence of plants (before the vegetation and fertilizer application – March and September). Agrochemical soil analysis was performed by conventional methods (Kuznetsov, Fecun, Camochvalov, 1985).

Preparation of plant samples for chemical analysis, wet and dry ashing batches of the dissolution of ash and determination of macro and trace elements was performed by the procedures CINAO set out in the Guidelines for determination of trace elements in soils and plants (Kuznetsov, Fecun, Camochvalov, 1985), as well as guests on the food plant.

The treatment is carried out in the form of trace elements foliar treatment plant tea and tangerine as follows:

The patterned experience of tea until 2004 included 6 variants in 4 fold repetition: control (spraying water without minerals); solution of copper sulphate at a concentration of 0.06%; manganese sulphate 0.4%; zinc sulphate 0.3%; iron sulfate 0.3%. Since 2004, in connection with the transition of mature plants in the state have changed concentration insertion elements, and the scheme has gained as follows: control (spraying water without minerals); solution of copper sulphate at a concentration of 0.06%; manganese sulphate 0.6%; zinc sulfate 0.3%; iron sulfate 0.5%. Area pilot area 0.4 hectares, the size of plots were 9 linear meters, separated by protective portions 1 m. Row spacing of 1.25 m. Accommodation options – randomization. Foliar treatment is carried out at the beginning of the growing season (the last decade of April – early May) and during the depression years of growth processes (July). When introducing context macro fertilizers (60%) was used NPK with ammonium nitrate (at a dose of N360 P60 K50 kg.ha⁻¹); during the summer feeding (40%) was added ammonium nitrate, according to the Guidelines for the technology of cultivation of tea (Tuov et al, 1977).

The experimental setup for tangerines included 6 variants in 4 fold repetition: control (spraying water without minerals); solution of copper sulphate at a concentration of 0.06%; manganese sulphate 0.4%; zinc sulphate 0.3%; boric acid 0.6 – 1.0%. Tangerine free experience laid by a 4-fold repetition, 5 trees in each. The area of the experimental plot takes 0.25 ha, nutrition area 4 x 1 m. During the growing season spend two foliar feeding: in the first phase of mass flowering and the end of the second – in the beginning phase of fruit filling. Trace elements were added to the context macro fertilizers. Before the vegetation as a main application used NPK dose N160R200K60 kg.ha⁻¹ (Vorontcov et al., 1979). As the summer feeding used ammonium nitrate (40% annual rate).

Processing of experimental data was carried out by methods of correlation, regression and cluster analysis, as well as descriptive statistics using mathematical programs developed VNIIA Pryanishnikov, STATGRAPHICS Centurion XV software and Microsoft Excel.

RESULTS AND DISCUSSION

First of all, we studied the chemical composition of tea plants and tangerine at foliar application sulfates Mn, Zn, Cu, Fe, and of boric acid solution (Ryndin, 2009; Abilfazova, 2006; Belous, 2009; Prytula, 2004).

It is revealed that the minerals have a significant impact on the content of Mn, Zn, Cu and Fe in a physiologically mature tea leaves, and this trend persisted throughout the study period. At the same time, we noted that it stopped growing leaves most accurately reflect the degree of security of the tea plant essential micronutrients, the content of which is more stable than in flush, where their concentration is not stable (Table 1).

Due to the fact that the shoots of the tea used to prepare the finished tea, accumulates significant amounts of trace elements, it was necessary to ascertain the effect of foliar application of nutrients to their content in the final product. Our studies have shown that treatment micro fertilizers significantly increase the total amount of Cu, Mn, Zn and Fe in the case (Table 2).

Table 1 Influence of trace elements on their content in the tea leaves and flushes (mg.kg⁻¹).

Variation	Cu		Mn		Zn		Fe	
	Leaf	Flush	Leaf	Flush	Leaf	Flush	Leaf	Flush
Control	23.24 ±1.19	45 ±10	1034 ±100	406 ±99	30.5 ±1.8	406 ±99	77.3 ±28.5	44 ±18
CuSO4	33.80 ±5.30	45 ±17	961 ±62	362 ±96	31.5 ±1.7	362 ±96	76.5 ±26.5	44 ±14
MnSO4	22.87 ±1.73	42 ±14	1206 ±159	409 ±97	30.8 ±1.2	409 ±97	58.3 ±22.3	45 ±14
ZnSO4	22.59 ±0.86	42 ±14	1014 ±102	471 ±109	40.6 ±2.5	471 ±109	78.6 ±19.4	50 ±14
FeSO4	22.23 ±0.77	42 ±16	855 ±909	445 ±82	29.6 ±1.1	445 ±82	128.4 ±58.3	51 ±14
LSD (<i>p</i> ≤0.05)	8.22		66.3		9.8		19.2	

Table 2 Content of trace elements in tea semi-finished product (mg.kg⁻¹).

Variation	Cu	Mn	Zn	Fe
Control	1.9 ±0.2	329 ±10.0	7.1 ±1.0	37 ±5.0
CuSO4	3.1 ±0.3	322 ±9.5	7.3 ±1.1	34 ±4.8
MnSO4	2.0 ±0.2	339 ±8.2	7.7 ±0.9	39 ±5.6
ZnSO4	2.4 ±0.2	346 ±5.5	8.7 ±0.8	38 ±4.2
FeSO4	2.8 ±0.1	345 ±6.9	6.9 ±0.9	44 ±4.0
LSD (<i>p</i> ≤0.05)	0.8	34	0.5	3.0

Table 3 Content of trace elements in the leaves of tangerine (mg.kg⁻¹).

Variation	Cu	Zn	Mn	B	Fe
	Opt. 5-10	Opt. 25-100	Opt. 25-100	Opt. 50-170	Opt. 60-120
Control	12.12 ±1.6	33.86 ±14.4	27.76 ±3.8	38.70 ±3.04	43.30 ±10.2
H3BO3	11.92 ±1.5	35.12 ±14.6	28.61 ±4.4	51.90 ±9.0	47.04 ±9.6
MnSO4	11.86 ±1.6	35.20 ±14.6	65.42 ±12.6	53.78 ±14.2	46.78 ±10.7
ZnSO4	11.34 ±2.1	57.50 ±13.1	29.04 ±3.7	44.92 ±6.5	47.12 ±11.9
CuSO4	18.02 ±4.1	36.46 ±11.7	27.70 ±2.7	44.57 ±7.5	47.68 ±10.8
LSD (<i>p</i> ≤0.05)	1.94	3.71	4.97	3.78	2.91

Table 4 Content of trace elements in the pulp and rind (mg.kg⁻¹).

Variation	Pulp					Peel				
	B	Mn	Zn	Cu	Fe	B	Mn	Zn	Cu	Fe
Control	14.6	7.2	2.13	1.27	25.3	33.4	6.5	16.1	12.3	17.5
H3BO3	15.2	6.6	2.32	1.29	30.0	35.1	6.1	16.5	9.9	17.3
MnSO4	16.3	10.2	1.93	1.05	23.2	37.8	13.8	16.8	11.2	14.4
ZnSO4	16.2	7.8	2.56	1.24	23.4	38.3	7.0	35.0	9.5	14.8
CuSO4	15.5	6.4	2.51	1.36	18.0	35.0	6.0	19.4	13.8	11.8
LSD (<i>p</i> ≤0.05)	0.7	0.7	0.4	0.2	3.8	1.1	0.5	1.3	1.0	1.4

At the same time, the concentration of trace elements studied in the semi-finished product prepared from raw experimental batches, does not exceed the allowable state standard values. Thus, the copper content in the tea extract ranged 1.9 – 3.3 mg.kg⁻¹, while the ISO for copper in black tea is 100 mg.kg⁻¹ (Ryndin, 2009; Belous, 2009; Pritula, 2004).

Results of analyzes of leaf tangerine also revealed the existence of a positive impact on the accumulation of trace elements Mn, Zn, B and Fe as the leaves and fruits at a foliar application of these elements (Table. 3).

Trace elements have an impact on the content and accumulation of them in the flesh and tangerine peel (Table 4).

Besides the chemical composition of the test plants, we studied the effect of micronutrient foliar application on the functional state of cultures (Ryndin, 2009; Abilfazova, 2006; Belous, 2009; Prytula, 2004). First, set the effect of trace elements on the adaptability of the plant tea and

tangerine, which is reflected in the existence of a clear trend of increasing plant resistance to drought. So, the concentration of the tea plant cell sap (CCS) flush on versions with microelement treatments on average 1.5 – 2.0 times lower than the control (water treatment), indicating a significant improvement of the water regime. Analysis of changes in the data CCS showed that due to changes in climatic parameters (for the years of study at a repetitive dry hot air temperature has increased by an average of 1 – 2 °C), CCS flush in intense periods of water availability are increasingly raised to 20% and higher in some periods exceeding 24%. However, in cases with the introduction of manganese and zinc CCS has always been 2 – 4% lower than in the controls (Belous, 2009).

Regression analysis confirmed the existence of a close correlation between the foliar fertilizer with microelements and CCS flushes: $Y = 21.2 + 0.8 \text{ Cu} - 2.2 \text{ Mn} - 2.2 \text{ Zn} + 1.0 \text{ Fe}$; $R^2 = 0.58 - 0.62$. With the water regime of plants the transpiration process is directly connected. The

Table 5 Parameters of the water regime of tea leaves when making micronutrients.

Variation	Water content of grain leaves, %	The intensity of transpiration, g/cm ² /h	Water retention the ability (6 hours), %	Water deficiency, %	T2/T1
Control	51 ±2.5	211.1 ±37.2	25 ±1.1	19.48	0.62 ±0.20
CuSO ₄	40 ±3.0	206.6 ±52.4	34 ±2.1	22.45	0.79 ±0.20
MnSO ₄	72 ±2.0	314.3 ±40.8	22 ±1.6	14.05	0.75 ±0.18
ZnSO ₄	69 ±1.9	303.4 ±58.2	20 ±1.6	13.02	0.74 ±0.20
FeSO ₄	45 ±2.5	201.1 ±65.7	38 ±1.9	24.40	0.73 ±0.20
LSD (<i>p</i> ≤0.05)	9.0	102.5	8.2	-	-

Table 6 Effect of trace elements on the water status of the plant tangerine.

Variation	Water content of grain %	Water deficiency %	T2/T1
Control	70	25	0.89
H ₃ BO ₃	73	21	0.91
MnSO ₄	67	20	0.86
ZnSO ₄	71	14	0.94
CuSO ₄	74	19	0.89
LSD (<i>p</i> ≤0.05)	3.19	2.60	-

intensity of transpiration, which characterizes the intensity of water exchange and the level of metabolic reactions, largely linked to the agronomic conditions for growing plants. The calculation of the intensity of transpiration tea leaves showed that treatment with manganese and zinc in the hottest time of the day significantly (by an average of 1.4 – 1.7 times) increased the transpiration process, which is a positive fact that in times of drought, as it is a mechanism that protects the leaf overheating (Table 5). Studies on the effect of trace elements on the adaptive processes of plants, conducted on different cultures have revealed a similar trend (Thoma, 1983; Kouchnirenko, 1967; Cruz de Carvalho et al., 2008 and others), which confirms the promising use of nutrients as a mechanism, enhancing adaptive capacity.

Studies of the water regime of tangerine plants in making micronutrients showed the same pattern as in the study of plant water status of tea (Abilfazova, 2006). Thus, in embodiments with treatments Mn and Zn had a significant decrease in transpiration due to increased water retention tangerine leaves (water content of 2 hours was changed to 1.3 – 1.5 times, and after 24 hours on the average 1.3 times relative to control). While the introduction of copper contributed to a significant reduction in water retention leaf (Table 6). Zinc treatment resulted in a decrease in water deficit is almost 1.6 times (at 25% for the control). The established pattern is expressed by the following equation: $Y = 23.5 + 11.3 \text{ Cu} - 10.5 \text{ Mn} - 10.5 \text{ Zn}$, $R^2 = 0.78$.

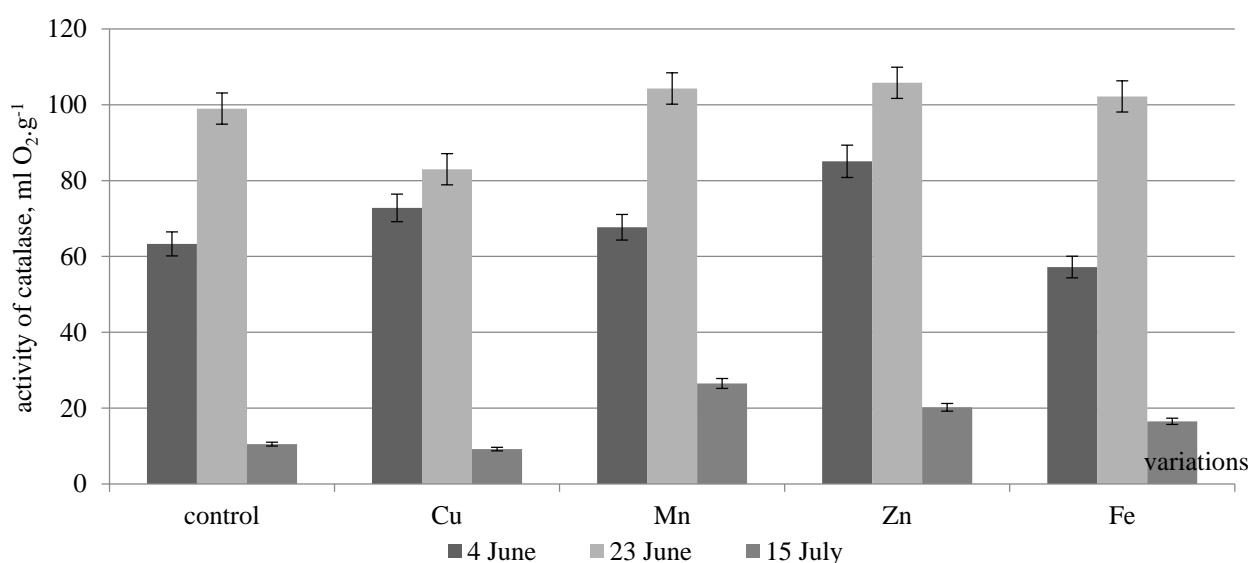

Figure 1 The activity of catalase in tea leaves when foliar feeding micronutrients during stress (June – July), LSD (*p* ≤0.05) = 12.9; 13.3; 13.7.

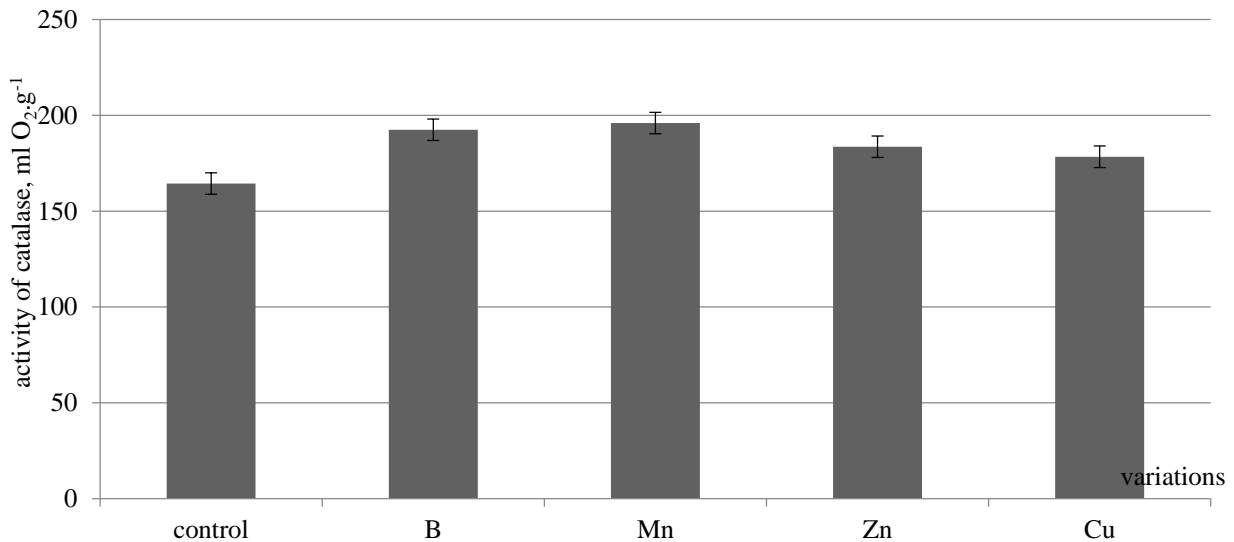

Figure 2 The activity of catalase in leaves tangerine with the foliar fertilizer with microelements, times of stress (June-August), LSD ($p \leq 0.05$) = 10.8.

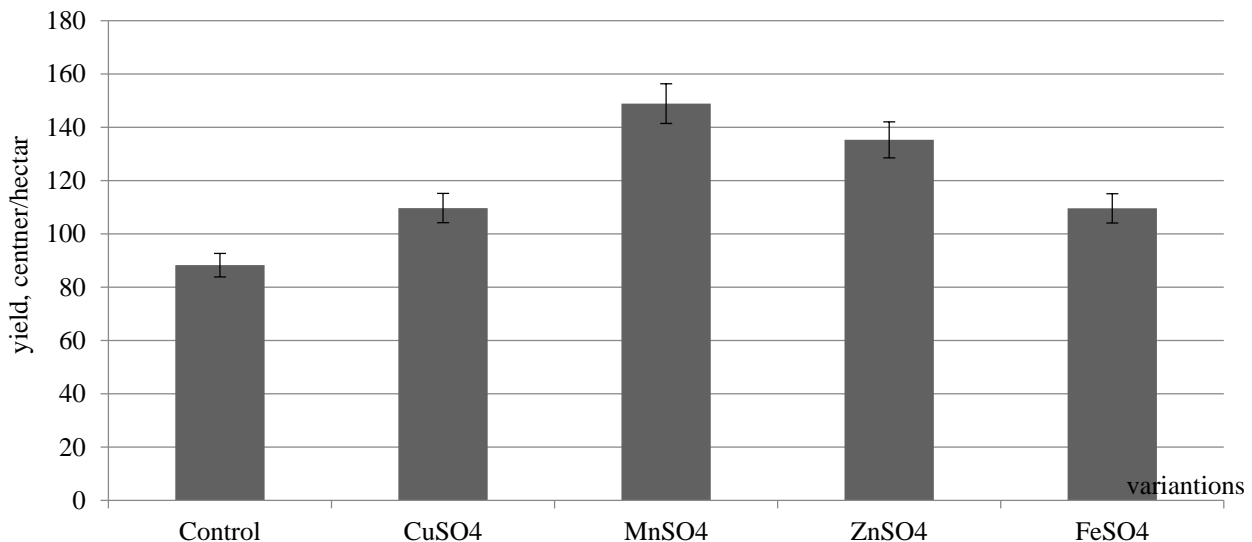

Figure 3 Effect of trace elements on the yield of tea plants, LSD ($p \leq 0.05$) = 8.9

Biogenic minerals made foliar way, may affect the activity of catalase, which is one of non-specific mechanisms of adaptability of plants. Thus, in the most unfavorable for water supply (June – period not only enhance the stress, but also during the biological decay of shoot from tea) catalase tea leaves when making micronutrients (especially, Mn and Zn) significantly (2.5 – 1.9 times) higher than the control (Figure 1).

Analysis of enzymatic activity for the entire study period and have another circumstance: when the tea of mature plants need higher concentrations of trace elements, which was considered by us to adjust doses of micronutrients.

Plants tangerine noted similar patterns of influence of microelements on the enzymatic activity – increased the catalytic activity of the leaves when making Mn and B ($r = 0.8$ and $r = 0.6$) (Figure 2).

Moreover, our data on the influence of microelements on the enzymatic processes of plants tea and tangerine are consistent with the results of other authors in different cultures (Gudkovskiy et al., 2005; Romanova, 2008;

Muhammad Anjum Zia et al., 2011; Kuznetsova et al. 2016).

However, the duration of the stress factor for plants tangerine is more durable and lasts from June to August. The main stressor for this culture is a high temperature, causing the development of non-specific reactions – folding leaf to reduce the transpiration process.

Trace elements may affect the pigment composition of the leaves of the test plants (Table 7 and Table 8), which is consistent with results reported by other researchers (Hochachka et al., 1977; Shakirova, 2001).

It is established that in the processing of nutrients in plants of tea in times of drought significantly changed the content of carotenoids (up to 46 – 50% vs. baseline), leading to higher power pigment system, associated with the quantitative content of all groups of pigments ($r = 0.75 – 0.86$).

In the leaves, tangerine and tea, significant effect of trace elements on the synthesis of chlorophyll and carotenoids.

Table 7 Characteristics of the pigment apparatus of mature tea plants with increasing doses of trace elements (mg.g⁻¹).

Variation	Chlorophyll			Carotenoids	a +b/carotenoids
	a	b	a +b		
Control	1.91 ±0.56	1.27 ±0.45	3.18 ±0.50	0.61 ±0.13	5.21 ±0.32
CuSO ₄	1.94 ±0.52	1.10 ±0.44	3.05 ±0.48	0.60 ±0.13	5.08 ±0.31
MnSO ₄	2.03 ±0.50	1.75 ±0.47	3.78 ±0.49	0.94 ±0.13	4.02 ±0.31
ZnSO ₄	2.13 ±0.50	1.82 ±0.43	3.95 ±0.47	0.91 ±0.11	4.34 ±0.29
FeSO ₄	2.00 ±0.51	1.20 ±0.59	3.20 ±0.55	0.60 ±0.13	5.33 ±0.34
LSD (<i>p</i> ≤0.05)	0.10	0.34	0.36	0.18	-

Table 8 Effect of trace elements on the water status of the plant tangerine.

Variations	Chlorophyll			Carotenoids	a +b/carotenoids
	a	b	a +b		
Control	1.55 ±0.2	0.91 ±0.1	2.46 ±0.3	0.55 ±0.04	4.47 ±0.1
H ₃ BO ₃	1.85 ±0.04	0.96 ±0.05	2.81 ±0.1	0.61 ±0.1	4.61 ±0.5
MnSO ₄	1.82 ±0.1	0.94 ±0.1	2.76 ±0.1	0.61 ±0.1	4.52 ±0.4
ZnSO ₄	1.78 ±0.1	0.91 ±0.03	2.69 ±0.1	0.54 ±0.02	4.98 ±0.1
CuSO ₄	1.92 ±0.1	0.98 ±0.1	2.90 ±0.1	0.57 ±0.01	5.09 ±0.1
LSD (<i>p</i> ≤0.05)	0.06	0.05	0.10	0.03	0.24

Foliar feeding of plants tea micronutrients (Cu, Mn, Zn, Fe) had a significant impact on their ability called shoot-forming capacity (*r* from 0.56 – 0.62 on the version with the introduction of copper and iron to 0.72 to 0.76 when making manganese and zinc) (Figure 3). On versions with the processing of manganese and zinc were observed less variability in yield (*V* = 11.9 per of 12.3%) compared with the control (*V* = 14.8%). We have established the dependence between the productivity of tangerine and submitted by foliar micronutrients, as evidenced by high correlation coefficients: B (*r* = 0.9), Mn and Zn (*r* = 0.7) (Figure 4).

CONCLUSION

Thus, the search of methods to increase adaptive capacity subtropical crops have shown that reducing stress caused by drought conditions, it is possible by the application of fertilizers, resulting in higher overall plant resistance.

It is revealed that treatment of plants of manganese and zinc contribute to greater conservation of water content in the leaves, causing a decrease of water scarcity, increasing adaptive responses of plants to drought. When you make these elements is increased transpiration process, which not only improves circulation, but also stimulates photosynthetic activity

So, foliar fertilizing of manganese (*r* = -0.69) and zinc (*r* = -0.73) significantly reduces the concentration of cellular juice flushes of tea; tea processing manganese, zinc, iron contributes to a significant enhancement of the enzymatic activity of the experimental plant; stimulates growth processes, resulting in an increase in leaf area; increases the productivity of plants: the increase in years of research by 11.7 – 25.3 per cent higher than the control (average 65.8 kg.ha⁻¹). Processing plants copper (*r* = 0.68 – 0.72), manganese (*r* = 0.70 – 0.81) and iron (*r* = 0.82 – 0.69) contribute to the increase in the content of tender fraction (*r* = 0.59 – 0.71) and content (3 – 4%) of tannin in raw materials.

When processing manganese and zinc at tangerine plants increased (1.3 – 1.5 times) the water-holding capacity of

leaves, decreased water deficit (1.6 times) and promote adaptive responses of plants to stress factors (drought); addition of copper, manganese and boron resulted in the increase of all photosynthetic pigments. We observed correlation between the introduction of boron and decrease (1.6 – 2.3 times) of subsidence of the ovary, which increased by 7.0 – 43.6 per cent for the pigments tangerine crop.

It can be concluded that the application of micronutrients is an additional reserve to increase the productivity of the culture of tea and tangerine.

In conclusion, a comprehensive study of the influence of trace elements on plants tea and tangerine became the basis to develop a practical framework for the application of foliar treatments with the aim of increasing the plant resistance to stressors, and how sustainable productivity of agroecosystems.

REFERENCES

- Abilifazova, Y. S., 2002. Effect of microelements on the growth and generative processes, water regime, enzymatic activity. *Material IV International conference "The introduction of unconventional and rare agricultural plants"*. Ulyanovsk : RNL. pp. 127-129. ISBN:5-7572-0084-7.
- Abilifazova, Y. S., 2006. *Effect of trace elements on physiological and biochemical processes of plants tangerine (Citrus unshiu Marc.)* : Thesis of candidate of biological Sciences. Krasnodar : Kuban Government Agrarian University. 148 p.
- Abilifazova, Y. S., Pritula, Z. V., Gorshkov, V. M. 2000. Effect of trace elements (B, Mn, Zn, cu) on some physiological processes of plants of tangerine. *Reports of the III International conference "The introduction of unconventional and rare agricultural plants"*. Penza : Volga House of Knowledge. pp. 60-61. ISBN: 5-8356-0038-0.
- Abilphazova, J., Belous, O. 2015. Adaptability of cultivars and hybrids of tangerine in a subtropical zone of Russia. *Potravinarstvo*, vol. 9, no. 1, p. 299-303. <https://dx.doi.org/10.5219/485>
- Argesanu, D. Madjar, R., Davidescu, V., Moruzi, A. 2009. The influence of the fertilizing system on the microelements

- contents in condor soybean cultivar. *USAMV Bucharest*, vol. 52, p. 190-195.
- Árvay, J., Hauptvogel, M., Tomas, J., Harangozo, L. 2015. Determination of mercury, cadmium and lead contents in different tea and teas infusions (*Camellia sinensis* L.). *Potravinárstvo*, vol. 9, no. 1, 2015, p. 398-402. <https://dx.doi.org/10.5219/510>
- Baslawskaya, S. S., Trubetskova, M. O. 1964. *Workshop on plant physiology*. Moscow : Moscow State University. 328 p.
- Belous, O. G. 2009. *Biological characteristics of tea culture in the humid subtropics of Russia* : Thesis of doctor of biological Sciences. Krasnodar : Kuban Government Agrarian University. 314 p.
- Belous, O. G. 2010. *Trace elements in the tea plantations of subtropical Russia*. Krasnodar : Kuban Government Agrarian University. 164 p.
- Belous, O. G. 2012. *Catalase activity in the leaves of tea in humid subtropics of Russia*. Saarbrücken : LAP LAMBERT Academic Publishing. 59 p. ISBN-13: 978-3-659-28389-5.
- Belous, O. G., 2013. Influence of microelements on biochemical parameters of tea. *Potravinárstvo*, vol. 7, Special no p. 149-152. http://www.potravinarstvo.com/dokumenty/mc_march_2013/bezpecnost_potraviny_rastlinneho_povodu/belous.pdf
- Bozhenko, V. G. 1976. Trace elements and the problem of stability of plants to adverse environmental conditions. In: *Physiological role and practical application of micronutrients*. Riga : Zinatne. p. 110-123.
- Cruz de Carvalho, M. 2008. Drought stress and reactive oxygen species. *Plant Signaling and Behavior*, vol. 3., no. 3, p. 156-165. <https://dx.doi.org/10.4161/psb.3.3.5536>
- Filippov, L. A. 1968. *Refractometric method of diagnosis timing for irrigation of tea plantations*. Sochi : RRIIFSC. 8p.
- Gudowskij, V. A., Kashirsky, N. I., Tsukanova, E. M. 2005. *Stress fruit plants*. Voronezh : Quarta. 127 p. ISBN: 5-89609-070-6.
- Gunnar, I. I. 1972. *Workshop on plant physiology*. Moscow : Kolos. 125 p.
- Hochachka, P. W., Somer, J. N. 1977. *Strategies of biochemical adaptation*. Moscow: Mir. 398 p.
- Kouřimská, L., Kubaschová, K., Sus, J., Nový, P., Dvořáková, B., Koudela, M. 2014. Comparison of the carbohydrate content in apples and carrots grown in organic and integrated farming systems. *Potravinárstvo*, vol. 8, no. 1, p. 178-183. <https://dx.doi.org/10.5219/362>
- Kushnirenko, M. D. 1967. *Water regime and drought resistance of fruit plants*. Kishinev : Stiinta. 330 p.
- Kushnirenko, M. D., Kurchatova, G. P., Stepinca, A. A., 1986. *Rapid methods of diagnosis of heat-, drought- and the timing of watering the plants*. Kishinev : Stiinta. 39 p.
- Kuznetsova, E., Cherepnina, L., Motyleva, S., Brindza, J. 2016. Redistribution of mineral elements in wheat grain when applying the complex enzyme preparations based on phytase. *Potravinárstvo*, vol. 10, no.1, p. 47-53. <https://doi.org/10.5219/413>
- Kuznetsov, A.B., Fecun, A.P., Camochvalov, C.G. 1985. *Methodical instructions on determination of trace elements in soils, forages and plants by the method of atomic absorption spectroscopy*. Moscow: CINAO. 95 p.
- Milenkevich, O. A., Tretyakov, N. N., Toma, S. I., Zubov, V. I. 2006. *Role of micronutrients in plant life*. In: Biodiversity and bioresources of the Urals and adjacent territories. Yekaterinburg : Goshickiy. pp. 63-67. ISBN 978-5-98829-035-3.
- Musilová, J., Lachman, J., Bystrická, J., Poláková, Z., Kováčik, P., Hrabovská, D. 2013. The changes of the polyphenol content and antioxidant activity in potato tubers (*Solanum tuberosum* L.) due to nitrogen fertilization. *Potravinárstvo*, vol. 7, no. 1, p. 164-170. <https://dx.doi.org/10.5219/305>
- Pritula, Z. V., Abilfazova, Y. S., 2004. Micronutrients - an important reserve for increasing tangerine yield in subtropical zone of Russia. *Material conference "Subtropical gardening Russia and the main directions of scientific support for its development up to 2010"*. Sochi : RRIIFSC. p. 41-44. <http://elibrary.ru/item.asp?id=23721033>
- Romanova, E. V., 2008. Enzymes in the antioxidant system of plants: superoxidismutase. *Agro*, vol. 21, no. 7-9, p. 27-30. <http://www.cnsnb.ru/jour>
- Ryndin, A., V. 2009. *Adaptive gardening humid subtropics of Russia* : Thesis of doctor of agricultural Sciences. Krasnodar : Kuban Government. Agrarian University. 380 p.
- Saeid Zehtab-Salmasi, S., Heidari, F., Houshang Alyari, H. 2008. Effects of Microelements and Plant Density on Biomass and Essential Oil Production of Peppermint (*Mentha piperita* L.). *Plant Sciences Research*, vol. 1, p. 24-26.
- Sennowskaya, T. V. 2006. Influence of micronutrients boron, manganese and zinc on the productivity of black currant. *Fruit and berry-culture of Russia*, vol. 17, p. 308-328. <http://vniispk.ru/news/zhurnal/article.php>
- Shakirova, F. M. 2001. *Nonspecific resistance of plants to stress factors and its regulation*. Ufa : Gilem. 160 p. ISBN: 5-75-01-0215-7.
- Shlyk, A. A. 1971. Determination of chlorophyll and carotenoids in extracts of green leaves. In: *Biochemical methods in plant physiology*. Moscow : Nauka. p. 154-170.
- Sokolov, A. V. 1975. *Agrochemical methods studies of soil*. Moscow : ASc USSR. 656 p.
- Toma, S. I. 1983. *Role of fertilizers in increasing the productivity and adaptability of plants in conditions of industrial production technology* : Materials to help the lecturer. Kishinev : Znaniye. 19 p.
- Tuov, M. T., Alekseeva, A. P., Gvasalia, V. P., Trojanskaya A. I. 1977. *Guidelines on the technology of cultivation of tea in the subtropical zone of the Krasnodar region*. Sochi : RRIIFSC. 80 p.
- Tuov, M. T., Prokopenko, I. A. 1998. New promising tea clones in the subtropics of Russia. In *Material conference "Subtropical gardening Russia and the main directions of scientific support for its development up to 2010"*. Sochi : RRIIFSC. vol. 38. p. 153-160.
- Vorontsov, V. V., Lavriyuchuk, I.I., Zagaynyi, S. A., Gorshkov, V. M., Lozhenitsyn I. P., Goletiani, T. G., Ksenofontova, D. V. 1979. *Methodical instructions on cultivation of dwarf Mandarin in subtropical areas of Krasnodar region*. Sochi : RRIIFSC. 60 p.
- Zia, M. A., Kousar, M., Ahmed, I., Hafiz Muhammad Nasir Iqbal, H. M. N., Abbas, R. Z. 2011. Properties of a cationic peroxidase from Citrus jambhiri cv. Adalia. *Biochemistry and Biotechnology*, vol. 10, no. 33, p. 6300-6303.

Contact address:

Alexey Ryndin, Dr. Agric. Sci., Russian Institute of Floriculture and Subtropical Crops, Yana Fabritsiusa st., 2/28, Sochi, Russia, 354002, E-mail: ryndin@vniisubtrop.ru

Oksana Belous, Dr. Biol. Sci., professor, head researcher at Plants Biotechnology, Biochemistry and Physiology Laboratory, Russian Institute of Floriculture and Subtropical Crops, Russian Institute of Floriculture and Subtropical Crops, Yana Fabritsiusa st., 2/28, Sochi, Russia, 354002, E-mail: oksana191962@mail.ru

Yuliya Abilfazova, PhD, senior researcher at Plants Biotechnology, Biochemistry and Physiology Laboratory, Russian Institute of Floriculture and Subtropical Crops, Yana Fabritsiusa st., 2/28, Sochi, Russia, 354002, E-mail: Citrus_Sochi@mail.ru

Zoya Prytula, PhD, leading researcher at Plants Biotechnology, Biochemistry and Physiology Laboratory, Russian Institute of Floriculture and Subtropical Crops, Yana Fabritsiusa st., 2/28, Sochi, Russia, 35400, E-mail: subplod@mail.ru



CHARACTERIZATION OF BIOACTIVE COMPOUNDS FROM *MONASCUS PURPUREUS* FERMENTED DIFFERENT CEREAL SUBSTRATES

Eva Ivanišová, Martin Rajtar, Helena Frančáková, Marián Tokár, Štefan Dráb, Maciej Kluz,
Miroslava Kačániová

ABSTRACT

Solid-state fermenting of cereals by *Monascus* is interesting strategy to produce cereals with more beneficial components. The objective of this study was to determine selected primary and secondary metabolites in cereals (rice, wheat, barley, sorghum, corn, buckwheat) fermented by *Monascus purpureus* and subsequently compare amount of these compounds with control sample (cereals without *Monascus*). In fermented cereals was determined higher protein, fat, reducing sugars, crude fiber and ash content with compare to non-fermented cereals. The antioxidant activity measured by DPPH assay, ABTS assay as well as reducing power assay was also higher in fermented *Monascus* cereals with the best results in rice (3.09 ± 0.02 ; 62.9 ± 2.24 ; 43.19 ± 2.07 mg TEAC per g of dry weight). Sample of fermented rice contained the highest level of total polyphenols (15.31 ± 3.62 mg GAE per g of dry weight), total flavonoids (1.65 mg QE per g of dry weight) and total phenolic acids (9.47 ± 0.56 mg CAE per g of dry weight). In fermented cereals was also determined higher content of reducing sugars (highest value in rice 246.97 ± 7.96 mg GE per g), proteins (highest value in buckwheat $28.47 \pm 1.24\%$), ash (highest value in sorghum $2.74 \pm 0.08\%$) and fat (highest value in corn $4.89 \pm 0.03\%$) with compare to non-fermented samples. Results of crude fiber content of both – fermented and non-fermented cereals were balanced with similar values. Results of this study shown that *Monascus purpureus* fermented cereal substrates might be a potential sources of several bioactive compounds in food products.

Keywords: antioxidant activity; fat content; protein content; dietary fiber; *Monascus*

INTRODUCTION

Monascus purpureus is edible fungus widely used in solid state fermentation for centuries mainly in Asian countries (Srianta et al., 2016). *Monascus* spp. has been used as common food additive and medicinal purposes for more than 1000 years. The genus *Monascus* encloses three main species (*M. pilosus*, *M. purpureus* and *M. ruber*) belonging to the family *Monascaceae* and to the class *Ascomyceta* (Pitt, 1997). Several secondary metabolites such as pigments, monacolins, γ -amino-butyric acid, dimeric acid and citrinin have been identified (Cheng et al., 2011). *Monascus* fermented products have become very common, mainly because of the perception of *Monascus* food products as a “natural” therapy compared with a statin. Moreover, *Monascus* products are associated with a lowered risk of myalgia in comparison to statins and are consequently considered by consumers to be a safe option for the management of hypercholesterolaemia. Due to these cholesterol-lowering effects that have been demonstrated in several well-designed clinical trials, the European Union has accepted a health claim related to monacolin K from *Monascus* fermented products (mainly

rice) and the maintenance of normal blood LDL cholesterol concentration (Childress et al., 2013). Monacolin K has a positive health promotion through inhibition of 3-hydroxy-3-methylglutaryl-coenzyme A reductase, a key enzyme of cholesterol synthesis in human body. γ -amino-butyric acid also play an important role in reducing the blood pressure (Srianta et al., 2014). These substances have a protection effect not only on cholesterol levels, but also on diabetes, cancer, osteoporosis, stroke, Alzheimer's, and other dementias (Yang and Mousa, 2012). *Monascus* products have been used for the treatment of dengue virus infection. On the other side *Monascus* sp. produces metabolites which not only have health positive promotion, but also toxic for human body, mainly mycotoxin monascidin A characterized as citrinin (Blanc et al., 1995).

Monascus-fermented products are products of fermentation process by *Monascus* sp. through solid state fermentation or submerged fermentation methods. Solid-state fermenting process of cereals by *Monascus* can be biotechnological strategy that may produce bioactive compounds during fermentation (Lee et al., 2008; Srianta

et al., 2014). *Monascus*-fermented products are applied for functional food, novel food ingredient to produce dairy products (bakery products, beverages) (Tseng et al., 2011). Currently, more than 50 patents concerning the use of *Monascus* pigments for food have been issued in Japan, the United States, France and Germany (Hajjaj et al., 2012).

The aim of this study was to determine bioactive compounds in selected cereals fermented with *Monascus purpureus* and subsequently compare obtained results with control sample without fermentation.

MATERIAL AND METHODOLOGY

Biological material

Wheat (*Triticum aestivum* L.), barley (*Hordeum vulgare* L.), corn (*Zea mays* L.), rice (*Oryza sativa* L.), sorghum (*Sorghum vulgare* L.) and buckwheat (*Fagopyrum esculentum* L.) were purchased at a local market in Slovakia. *Monascus purpureus* MFTCCX 022/16 (Figure 1) and cereals fermented materials were obtained from private company Mycoforest, Slovakia. The fungi was inoculated onto potato dextrose yeast agar and incubated at 25 °C for 5 days. After a pure culture was obtained. *Monascus purpureus* was re-inoculated into potato dextrose yeast agar and mycelium was incubated at 27 °C for 7 days as the inoculum. Inoculum was then homogenized and inoculated into autoclaved cereals (120 °C, 1 hour) a rate of 7 mL.100 g⁻¹. *Monascus* cereals were produced after the colonization of fungal mycelium for 14 days at 25 °C. *Monascus* cereals as well as uninoculated cereals, which were also autoclaved and used as controls were air-dried in an oven at 50 °C. Before the analyses samples were milling to powder (Perten 3100, Sweden).

Chemicals

All chemicals were analytical grade and were purchased from Rechem (Slovakia) and Sigma Aldrich (USA).

Sample preparation

0.5 g of cereals was extracted with 40 mL of 80% ethanol for 2 hours. After centrifugation at 4000 rpm (Rotofix 32 A, Hettich, Germany) for 10 min, the supernatant was used for measurement (antioxidant activity, polyphenols, flavonoids, phenolic acids). All analyses were realized in triplicate.

Dry mater, ash and protein determination

Dry matter, ash and protein were determined by the following standard AACC method 08-01. Nitrogen content was measured by the semi micro-Kjeldahl method. Nitrogen was converted to protein by using a factor of 5.7 for wheat and using a factor 6.25 for barley, buckwheat, sorghum, rice and corn.

Reducing sugars content

The reducing sugars content was determined by dinitrosalicylic colorimetric method according to the procedures described by Wang (2005). 0.5 g of sample was extracted with 80% of ethanol for 24 hours. After filtration 100 µL of extract was mixed with 800 µL

dinitrosalicylic acid and mixture was heated at 90 °C for 5 minutes to develop the red-brown color. After cooling to room temperature 8 mL of distilled water was added and absorbance at 575 nm was measured (Jenway 6405 UV/Vis, England). Glucose (0.5 – 10 g.L⁻¹; R² = 0.998) was used as the standard, and the results were expressed in mg.g⁻¹ glucose equivalent.

Crude fibre and total fat determination

Crude fibre content was determined using Fiber Anlyzer (Ancom²⁰⁰⁰, USA) and total fat using Fat Extractor (Ancom XT¹⁵, USA) with methodic recommended by producer.

Antioxidant activity

Radical scavenging activity

Radical scavenging activity of samples was measured using 2,2-diphenyl-1-picrylhydrazyl (DPPH) (Sánchez-Moreno et al., 1998) with slight modification. The extracts (1 mL) were mixed with 4 mL of DPPH solution (0.025 g DPPH in 100 mL ethanol). Absorbance of the sample extract was determined using the spectrophotometer Jenway (6405 UV/Vis, England) at 515 nm. Trolox (6-hydroxy-2,5,7,8-tetramethylchroman-2-carboxylic acid) (10 – 100 mg.L⁻¹; R²=0.983) was used as the standard and the results were expressed in mg.g⁻¹ Trolox equivalents.

Reducing power

Reducing power of samples was determined by the method of Oyaizu, (1986). One mililiter of sample extract was mixed with 5 mL PBS (phosphate buffer with pH 6.6) and 5 mL of 1% potassium ferricyanid in the test tube. Mixture was stirred thoroughly and heated in water bath for 20 minutes at 50 °C. After cooling, 5 mL of 10% trichloroacetic acid was added. 5 mL of mixture was pipetted into the test tube and mixed with 5 mL of distilled water and 1 mL of 0.1% ferric chloride solution. Absorbance at 700 nm was measured using the spectrophotometer Jenway (6405 UV/Vis, England). Trolox (10 – 100 mg.L⁻¹; R² = 0.9974) was used as the standard, and the results were expressed in mg.g⁻¹ Trolox equivalents.

ABTS radical cation decolorization assay

ABTS radical cation decolorization assay was determined by the method of Re et al., (1999) with slight modifications. ABTS (2,2'-azinobis[3ethylbenzthiazoline]-6-sulfonic acid) was dissolved in distilled water to 7 mM concentration, and potassium persulphate added to a concentration of 2.45 mM. The reaction mixture was left to stand at room temperature overnight (12~16 h) in the dark before use. The resultant intensely-coloured ABTS^{•+} radical cation was diluted with 0.01 M PBS (phosphate buffered saline), pH 7.00 to give an absorbance value of ~0.70 at 734 nm. Two milliliter of ABTS solution was mixed with 0.98 mL of PBS and 0.02 mL of sample extract. Absorbance was measured spectrophotometrically (Jenway 6405 UV/Vis, England) at time intervals 6 minutes after addition of sample extract. Trolox (100 – 100 mg.L⁻¹; R² = 0.9991) was used as the standard, and the results were expressed in mg.g⁻¹ Trolox equivalents.

Total polyphenol content

Total polyphenol content of extracts was measured by the method of **Singleton and Rossi (1965)** using Folin-Ciocalteu reagent. 0.2 mL of each sample extract was mixed with 0.2 mL of the Folin-Ciocalteu reagent, 2 mL of 20% sodium carbonate. After 30 min. in darkness the absorbance at 700 nm was measured using the spectrophotometer Jenway (6405 UV/Vis, England). Gallic acid ($1 - 150 \text{ mg.L}^{-1}$; $R^2 = 0.998$) was used as the standard and the results were expressed in mg.g^{-1} gallic acid equivalents.

Total flavonoid content

Total flavonoids were determined using the modified method of **Quettier-Deleu et al. (2000)**. 2 mL of sample extract was mixed with 0.4 mL of 5% ethanolic solution of aluminium chloride. After 30 min. in darkness the absorbance at 415 nm was measured using the spectrophotometer Jenway (6405 UV/Vis, England). Quercetin ($0.25 - 20 \text{ mg.L}^{-1}$; $R^2 = 0.999$) was used as the standard and the results were expressed in mg.g^{-1} quercetin equivalents.

Total phenolic acid content

Total phenolic acids content was determined using method of **Farmakopea Polska (1999)**. A 0.5 mL of sample extract was mixed with 0.5 mL of 0.5 M hydrochloric acid, 0.5 mL Arnova reagent (10% $\text{NaNO}_2 + 10\% \text{Na}_2\text{MoO}_4$), 0.5 mL of 1 M sodium hydroxide (w/v) and 0.5 mL of water. Absorbance at 490 nm was measured using the spectrophotometer Jenway (6405 UV/Vis, England). Caffeic acid ($1 - 200 \text{ mg.L}^{-1}$, $R^2 = 0.999$) was used as a standard and the results were expressed in mg.g^{-1} caffeic acid equivalents.

Statistical analysis

The basic statistical analyzes were realized in SAS programming packages (THE SAS SYSTEM V 9.2.). Correlation coefficients were calculated by CORR analysis (SAS, 2009).

RESULTS AND DISCUSSION**Dry matter, ash, reducing sugars, protein, fat and crude fiber content**

Dry matter content (Table 1) ranged from 87.38% to 94.33% in control samples and from 91.52% to 93.59% in fermented samples.

Ash content (Table 1) in control sample ranged from 0.32% (rice) to 1.51% (buckwheat), but in *Monascus* fermented cereals amount of total ash was higher and ranged from 0.62% (rice) to 3.61% (buckwheat). Similarly results found in solid fermented rice **Purvar et al. (2016)**, which determined significantly higher content in total ash with compare to control rice without fermentation. **Vidyalakshmi et al. (2009)** also compare fermented and non-fermented rice, and confirmed that solid state fermentation of cereals with *Monascus* increase total ash content. These authors determined in raw rice 0.66% of total ash, whereas in fermented rice determined amount of total ash 1.65%.

Reducing sugars content (Table 1) were in all control samples near to 20 mg GE.g^{-1} , but in fermented samples

were higher and ranged from 35.39 (sorghum) to $246.97 \text{ mg GE.g}^{-1}$ (in rice). Increase of reducing sugars content is due to the starch utilized during growing of *Monascus*; during this process starch is broken down by amylase which starts to activate due to the increasing temperature during fermentation. **Purvar et al. (2016)** found in *Monascus* rice $113.2 \text{ mg GE.g}^{-1}$ of reducing sugars, while **Vidyalakshmi et al. (2009)** determined $253.9 \text{ mg GE.g}^{-1}$ of reducing sugars in *Monascus* rice, which corresponds with our results in fermented rice. Cereals are very good substrate for fermentation medium due to the high starch content as a carbon source (C) and protein content as nitrogen source (N). Starch is the main carbon source in cereals which were hydrolyzed first prior to be transported into the mold cells (**Srianta and Harinojo, 2015**). Proteins content (Table 1) ranged from 7.12% to 11.09% in control samples, while in fermented samples ranged from 14.18% to 28.49%. **Purvar et al. (2016)** published that in *Monascus* rise protein content increase to value 29.62%. Similar results also confirmed **Vidyalakshmi et al. (2009)**, which detected in red rice 17.16% of protein, which is comparable with our findings – rice 14.18%. The utilization of rice carbohydrate by *Monascus* for its metabolism and production of the secondary metabolite namely the pigment has also resulted in an increased protein and crude fiber. In our study content of crude fiber decrease during fermentation (Table 1) which is with accordance to **Purvar et al. (2016)** findings. In their study amount of crude fiber in fermented rice decreased to amount 0.28%. On the other side **Vidyalakshmi et al. (2009)** observed increase of crude fiber in *Monascus* rice from 0.8 to 6.71%. Very interesting was to observe significant increase of fat content in fermented cereals with compare to control sample (Tab. 1). The highest increasing was determined in corn – from 2.64 (in control sample) to 4.89% (fermented sample) and sorghum – from 2.08 (in control sample) to 4.55% (in control sample). Similarly **Vidyalakshmi et al. (2009)** detected increase of total fat in rice from 1.41% in control sample to 1.98% in fermented rice. Increase of fat content can be explain by **Kennedy et al. (1999)** which reported that *Monascus* on solid state fermentation produces mono unsaturated long-chain fatty acids of wide range from C_{14} to C_{24} . Thirty-nine fatty acids were identified from *Monascus* fermented samples; twenty-two saturated fourteen monoenic, two dienoic and one α -linolenic acid. **Venkateswaran (2010)** determined lauric, myristic, palmitic, stearic, oleic and linoleic acid in *Monascus* rice and sorghum. The same fatty acids determined in fermented corn, which contained also linolenic acid.

Antioxidant activity

Antioxidant activity of *Monascus* fermented cereals was higher by all used methods with compare to control samples. Radical scavenging activity (Table 2) in control sample ranged from 0.79 (sorghum) to 3.01 (rice) $\text{mg TEAC per gram of sample}$. Very high activity was detected in fermented rice, corn and wheat. **Lee et al. (2008)** determined increase of antioxidant activity by DPPH method of *Monascus* fermented soybean (26.4%) with compare to raw material (22.8%). **Rajasekaran and Kalaivan, (2011)** showed that fermented Indian rice had a strong activity by DPPH with the value 13.92 mmol TEAC

per g, and also confirmed, that strong radical scavenging activity *in vitro* motivated the authors to investigate the biological significance of antioxidant activity of *Monascus* fermented cereals.

Reducing power (Table 1) of cereals ranged from 0.09 (barley) to 0.21 (buckwheat) mg TEAC per gram in control samples, while in fermented cereals was higher and ranged from 3.59 (sorghum) to 43.19 (rice) mg TEAC per gram of sample. Results showed that fermentation by *Monascus* increase very strong antioxidant activity. **Rajasekaran and Kalaivan (2011)** determined also strong reducing power in Indian *Monascus* rice, which lead these authors to investigate further *in vivo* by measuring lipid peroxidation and glutathione levels and superoxide dismutase and catalase activities. In their study confirmed that antioxidant activity of *Monascus* rice function through the induction of antioxidant enzymes and reduction hydrogen peroxide, quenching active singlet oxygen and by trapping and quenching radicals. **Lee et al. (2008)** determined increase of antioxidant activity by reducing power in fermented soybean (EC₅₀ value 8.14 mg extract per ml) with compare to control non-fermented soybean (EC₅₀ value 3.59 mg extract per mL). According to **Mostafa and Abbady (2014)** very important role as antioxidants in *Monascus* products play xanthomonascin A and B, glycyrrubropunctatin, glycylymonascorubin, laccaia acid A-C and dimerumic acid.

Antioxidant activity by ABTS radical cation decolorization assay (Table 2) ranged from 8.03 (barley) to 13.31 (rice) mg TEAC per g in control samples, while in fermented variants was higher and ranged from 15.31 (sorghum) to 62.89 mg TEAC per gram. By all used methods was the highest activity determined in fermented rice. Strong activity by ABTS assay in fermented rice bran published **Cheng et al. (2016)**, which also showed possibility fermented rice bran used as a natural antioxidant agent due to its enhanced antioxidant activity.

Total polyphenol, flavonoid and phenolic acid content

Total polyphenol in cereals ranged from 0.14 (rice) to 1.33 (sorghum) mg GAE per gram in control sample, and from 2.34 (sorghum) in fermented cereals. Similarly like antioxidant activity amount of total polyphenols was

strong increased in fermented cereals. Increase of polyphenols is probably due to release of these compounds from cell walls, which are destroy thanking enzymatic hydrolysis during fermentation. **Razak et al. (2015)** published that fermentation of rice bran by *Monascus* significantly increase amount of total polyphenols. In their study they compared control sample of rice bran (3.93 mg GAE per g) without fermentation with fermented rice bran (7.69 mg GAE per g) and also published that these compounds are better extracted with methanol (7.69 mg GAE per g) like with water (1.73 mg GAE per g). **Yang et al. (2006)** determined total phenolic content if *Monascus* dehulled rice in amount 40.39 mg per g which was significantly higher with compare to non-fermented control sample, with value 4.04 mg per g.

Strong correlation ($p \leq 0.05$) was observed in our study between total polyphenol content and DPPH ($\rho = 0.840$), ABTS ($\rho = 0.984$) and reducing power ($\rho = 0.977$).

Total flavonoid content (Table 2) ranged from 0.01 (rice and corn) to 0.02 (sorghum and wheat) mg QE per g in control samples, while in fermented samples amount was higher and ranged from 0.53 (sorghum) to 1.65 mg QE per g (rice). Increase of total flavonoid content was very markedly, which correspond to **Cheng et al. (2016)** findings. In their work amount of flavonoid in rice bran increase four-times during fermentation. **Huynh et al. (2014)** published that during *Monascus* fermentation phenolic compounds are released and are obtained in soluble free form in the fermentation medium. This process contributes to the production of extracts and food products with a higher added value. For example **Handa et al. (2014)** determined that soybean fermentation by *Monascus* significantly increase genistein aglycone with compared to unfermented soybean. Phenolic aglycones have a higher antioxidant activity than their glycosides, which are dominant in non-fermented cereals and legumes. Strong correlation ($p \leq 0.05$) was observed in our study between total flavonoid content and DPPH ($\rho = 0.986$), ABTS ($\rho = 0.871$) and reducing power ($\rho = 0.867$).

Total phenolic acid content (Table 2) in cereals ranged from 0.03 (rice) to 0.83 (sorghum) mg CAE per g in control samples, while in fermented samples amount was higher and ranged from 3.12 (sorghum) to 9.47 mg QE per g (rice). Similarly like antioxidant activity, polyphenols and flavonoids *Monascus* fermentation can increase

Table 1 Content of dry matter, ash, reducing sugars, protein, fat and crude fiber.

Sample	DM (%)	AC (%)	RSC (mg GE.g ⁻¹)	PC (%)	FC (%)	CFC (%)
Barley	94.33 ±0.55	0.58 ±0.01	20.02 ±1.21	8.01 ±0.21	0.34 ±0.01	0.57 ±0.02
MFB	91.99 ±0.58	2.30 ±0.01	166.46 ±1.38	25.21 ±0.24	2.19 ±0.27	0.53 ±0.01
Rice	92.81 ±0.31	0.32 ±0.02	13.15 ±0.71	7.15 ±0.11	0.62 ±0.14	0.54 ±0.03
MFR	93.41 ±0.21	0.62 ±0.02	246.97 ±7.96	14.18 ±0.25	2.67 ±0.78	0.57 ±0.02
Buckwheat	87.38 ±1.21	1.17 ±0.01	15.57 ±0.72	11.09 ±0.74	1.62 ±0.14	0.57 ±0.01
MFBw	92.32 ±0.68	3.48 ±0.31	74.64 ±0.71	28.49 ±0.23	3.34 ±0.44	0.56 ±0.02
Corn	93.27 ±0.55	1.28 ±0.11	13.96 ±2.11	8.81 ±0.17	2.65 ±0.24	0.55 ±0.03
MFC	93.54 ±1.02	2.52 ±0.01	67.35 ±7.58	19.27 ±0.11	4.89 ±0.03	0.53 ±0.01
Wheat	94.17 ±0.47	1.51 ±0.01	13.15 ±1.41	10.92 ±0.74	1.09 ±0.41	0.56 ±0.02
MFW	91.75 ±0.77	3.60 ±0.03	154.33 ±9.11	24.68 ±0.85	2.92 ±0.02	0.55 ±0.03
Sorghum	91.52 ±0.88	1.46 ±0.03	13.15 ±0.73	8.88 ±0.83	2.08 ±0.06	0.55 ±0.04
MFS	93.59 ±0.05	2.74 ±0.11	35.39 ±3.05	17.97 ±0.14	4.55 ±0.22	0.51 ±0.01

Note: DM – dry matter content AC – ash content, RSC – reducing sugar content, PC – protein content, FT – fat content, CFC – crude fiber content; MFB – *Monascus* fermented barley, MFR – *Monascus* fermented rice, MFBw – *Monascus* fermented buckwheat, MFC – *Monascus* fermented corn, MFW – *Monascus* fermented wheat, MFS – *Monascus* fermented sorghum; GE – glucose equivalent.

Table 2 Antioxidant activity, total polyphenol, flavonoid and phenolic acid content.

Sample	DPPH (mg TEAC.g ⁻¹)	RP (mg TEAC.g ⁻¹)	ABTS (mg TEAC.g ⁻¹)	TPC (mg GAE.g ⁻¹)	TFC (mg QE.g ⁻¹)	PAC (mg CAE.g ⁻¹)
Barley	1.06 ±0.02	0.09 ±0.05	8.03 ±0.02	0.75 ±0.01	0.02 ±0.01	0.31 ±0.08
MFB	2.27 ±0.02	14.51 ±0.93	2.27 ±0.02	3.97 ±0.06	1.35 ±0.52	4.79 ±0.09
Rice	0.95 ±0.08	0.14 ±0.01	0.95 ±0.08	0.14 ±0.03	0.01 ±0.00	0.03 ±0.01
MFR	3.01 ±0.02	43.19 ±2.01	3.01 ±0.02	15.31 ±3.61	1.66 ±0.02	9.47 ±0.56
Buckwheat	0.88 ±0.01	0.21 ±0.08	0.88 ±0.01	0.38 ±0.01	0.03 ±0.01	0.54 ±0.03
MFBw	2.27 ±0.02	12.45 ±1.34	2.27 ±0.02	3.66 ±0.34	1.28 ±0.38	4.62 ±0.23
Corn	0.89 ±0.08	0.14 ±0.01	0.89 ±0.08	1.03 ±0.11	0.01 ±0.00	0.43 ±0.06
MFC	2.81 ±0.01	13.54 ±0.41	2.81 ±0.01	4.69 ±0.17	1.43 ±0.22	5.12 ±0.13
Wheat	0.98 ±0.01	0.11 ±0.01	0.98 ±0.01	0.71 ±0.22	0.02 ±0.01	0.41 ±0.13
MFW	2.83 ±0.03	24.51 ±1.02	2.83 ±0.03	11.45 ±0.14	1.64 ±0.12	5.72 ±0.23
Sorghum	0.79 ±0.04	0.17 ±0.01	0.79 ±0.04	1.33 ±0.12	0.02 ±0.01	0.83 ±0.08
MFS	1.74 ±0.01	3.59 ±0.52	1.74 ±0.01	2.34 ±0.06	0.53 ±0.04	3.12 ±0.15

Note: TEAC – Trolox equivalent antioxidant capacity, RP – reducing power, GAE – gallic acid equivalent, QE – quercetin equivalent, CAE – caffeic acid equivalent; TPC – total polyphenol content, TFC – total flavonoid content, PAC – phenolic acid content; MFB – *Monascus* fermented barley, MFR – *Monascus* fermented rice, MFBw – *Monascus* fermented buckwheat, MFC – *Monascus* fermented corn, MFW – *Monascus* fermented wheat, MFS – *Monascus* fermented sorghum.



Figure 1 *Monascus purpureus* MFTCCX 022/16.

phenolic acid content due to their release from plants cell walls during fermentation. Razak et al. (2015) showed that during *Monascus* fermentation increase amount of ferulic, syringic and sinapic acid in rice bran with compare to non-fermented bran. These authors also published, that structural breakdown of cell walls induced by fermentation may occur, leading to the liberation and/or synthesis of various bioactive compounds. For example, the substantial increase in the vanillic acid content with *M. purpureus* rice bran extracts which is attributed to the fact that ferulic and coumaric acids can be biologically transformed into smaller compounds such as vanillic acid. During fermentation, enzymes such as amylases, xylanases, and proteases, derived from the substrate and the fungi, contribute towards the modification of substrate compositions.

Strong correlation ($p \leq 0.05$) was observed in our study between total phenolic acid content and DPPH ($\rho = 0.952$), ABTS ($\rho = 0.943$) and reducing power ($\rho = 0.959$).

CONCLUSION

The *Monascus purpureus* fermented cereals contained higher content of primary (protein, ash, reducing sugars, fat, dietary fiber) and secondary metabolites (polyphenols, flavonoids, phenolic acids as well as antioxidant activity) with compare to control non-fermented cereals. *Monascus* fermented cereals have a good potency as functional

products. But further studies in the process fermentation and content of biologically active compounds are necessary in future and also toxicological properties, if any.

REFERENCES

- AACC methods 8th, E.d., 1996. *Methods 08-01, 44-05A, 46-13, 54-20*. St. Paul, MN: American Association of Cereal Chemists.
- Blanc, P. J., Laussac, J. P., Le Bars, J., Le Bars, P., Loret, M. O., Pareilleux, A., Prome, D., Prome, J. C., Santerre, A. L., Goma, G. 1995. Characterization of monascidin A from *Monascus* as citrinin. *International Journal of Food Microbiology*, vol. 27, no. 2-3, p. 201-213. [https://doi.org/10.1016/0168-1605\(94\)00167-5](https://doi.org/10.1016/0168-1605(94)00167-5)
- Cheng, J., Bong-Keun, Ch., Yang, S., Suh, J. W. 2016. Effect of fermentation on the antioxidant activity of rice bran by *Monascus pilosus* KCCM60084. *Journal of Applied Biological Chemistry*, vol. 59, no. 1, p. 57-62. <https://doi.org/10.3839/jabc.2016.011>
- Cheng, M. J., Wu, M. D., Chen, I. S., Tseng, M., Yuan, G. F. 2011. Chemical constituents from the fungus *Monascus purpureus* and their antifungal activity. *Phytochemistry Letters*, vol. 4, no. 3, p. 372-376. <https://doi.org/10.1016/j.phytol.2011.08.003>
- Childress, L., Gay, A., Zargar, A., Ito, M. K., 2013. Review of red yeast rice content and current Food and Drug Administration oversight. *Journal of Clinical Lipidology*, vol.

Farmakopea Polska, 1999. The Polish Pharmaceutical Society [online] s.a. [cit.2017-01-25] Available at: <http://www.ptfarm.pl/?pid=1&language=en>.

Hajjaj, H., François, J. M., Goma, G., Blanc, P. J. 2012. Effect of amino acids on red pigments and citrinin production in *Monascus ruber*. *Journal of Food Science*, vol. 77, no. 3, p. 156-159. <https://doi.org/10.1111/j.1750-3841.2011.02579.x> PMid:22384962

Handa, C. L., Couto, U. R., Vicensot, A. H., Geogetti, S. R., Ida, E. I. 2014. Optimisation of soy flour fermentation parametrs to produce β -glucosidase for bioconversion into aglycones. *Food Chemistry*, vol. 152, p. 56-65. <https://doi.org/10.1016/j.foodchem.2013.11.101> PMid:24444906

Huynh, N. T., Camp, J. V., Smaghe, G., Raes, K. 2014. Improved release and metabolism of flavonoid by stewed fermentation process: A review. *International Journal of Molecular Science*, vol. 15, no. 1, p. 19369-19388. <https://doi.org/10.3390/ijms151119369> PMid:25347275

Kennedy, J., Auclair, K., Kendrew, S. G., Park, C., Vederas, J. C., Hutchinson, C. R. 1999. Modulation of polyketide synthase activity by accerory proteins during lovastatin biosynthesis. *Science*, vol. 284, no. 54118, p. 1136-1372.

Lee, Y. L., Yang, J. H., Mau, J. L. 2008. Antioxidant properties of water extracts from *Monascus* fermented soybeans. *Food Chemistry*, vol. 106, no. 3, p. 1128-1137. <https://doi.org/10.1016/j.foodchem.2007.07.047>

Mostafa, M. E., Abbady, M. S. 2014. Secondary metabolites and bioactivity of the *Monascus* pigment: Review Article. *Global Journal of Biotechnology and Biochemistry*, vol. 9, no. 1, p. 1-13.

Oyaizu, M. 1986. Studies on products of browning reaction – antioxidative activities of products of browning reaction prepared from glucoseamine. *Japanese Journal of Nutrition*, vol. 44, p. 307-314. <https://doi.org/10.5264/eiyogakuzashi.44.307>

Pitt, J. I., Hocking A. D. 1997. *Fungi and food spoilage*. 2nd ed. London : Chapman and Hall. 519 p. ISBN 9781461563914. <https://doi.org/10.1007/978-1-4615-6391-4>

Purwar, S., Gupta, E., Zaki, S. 2016. Effect of solid fermentation on nutritive values of rice by *Monascus* spp. *Bioved*, vol. 27, p. 185-189.

Quettier-Deleu, Ch., Gressier, B., Vasseur, J., Dine, Claude Brunet, C., Luyckx, M., Cazin, M., Cazin, J. C., Bailleul, F., Troitin, F. 2000. Phenolic compounds and antioxidant activities of buckwheat (*Fagopyrum esculentum* Moench) hulls and flour. *Journal of Ethnopharmacology*, vol. 72, no. 1-2, p. 35-42. [https://doi.org/10.1016/S0378-8741\(00\)00196-3](https://doi.org/10.1016/S0378-8741(00)00196-3)

Rajasekaran, A., Kalaivani, M. 2011. Hypolipidemic and antioxidant activity of aqueous extract of *Monascus purpureus* fermented Indian rice in high cholesterol diet fed rats. *Turk Journal of Medical Sciences*, vol. 41, no. 1, p. 25-32.

Razak, D. L. A., Rashid, N. Y., Jamaluddin, A., Sharifudin, S. A., Long, K. 2015. Enhancement of phenolic acid content and antioxidant activity of rice bran fermented with *Rhizopus oligosporus* and *Monascus purpureus*. *Biocatalysis and Agricultural Biotechnology*, vol. 4, no. 1, p. 33-38. <https://doi.org/10.1016/j.bcab.2014.11.003>

Re, R. N., Pellegrini, A., Proteggente, A., Pannala, M., Yang, R., Rice-Evans, C. 1999. Antioxidant activity applying

an improved ABTS radical cation decolorization assay. *Free Radical Biology and Medicine*, vol. 26, no. 9-10, p. 1231-1237. [https://doi.org/10.1016/S0891-5849\(98\)00315-3](https://doi.org/10.1016/S0891-5849(98)00315-3)

Sánchez-Moreno, C., Larrauri, A., Saura-Calixto, F. 1998. A procedure to measure the antioxidant efficiency of polyphenols. *Journal of the Science of Food and Agriculture*, vol. 76, no. 2, p. 270-276.

SAS, 2009. Users Guide Version 9. 2. SAS/STAT (r) SAS [online] s.a. [cit.2017-01-25] Available at: <https://support.sas.com/documentation/cdl/en/statug/63962/H/TML/default/viewer.htm#titlepage.htm>.

Singleton, V. L., Rossi, J. A. 1965. Colorimetry of total phenolics with phosphomolybdic-phosphotungstic acid reagents. *American Journal of Enology and Agricultural*, vol. 6, p. 144-158.

Srianta, I., Harijono, L. 2015. *Monascus* – fermented sorghum: pigments and monakoli K produced by *Monascus purpureus* on whole grain, dehulled grain and bran substrates. *International Food Research Journal*, vol. 22, no. 1, p. 377-382.

Srianta, I., Ristiarini, S., Nugerhani, I., Sen, S. K., Zhang, B. B., Xu, G. R., Blanc, P. J. 2014. Recent research and development of *Monascus* fermentation products. *Food Research Journal*, vol. 21, no. 1, p. 1-12.

Srianta, I., Zubaidah, E., Estiasih, T., Yamada, M., Harijon, O. 2016. Comparison of *Monascus purpureus* growth pigment production and composition on different cereal substrates with solid state fermentation. *Biocatalysis and Agricultural Biotechnology*, vol. 7, p. 181-186. <https://doi.org/10.1016/j.bcab.2016.05.011>

Tseng, Y. H., Yang, J. H., Chen, C. H. and Mau, J. L. 2011. Quality and antioxidant properties of anka-enriched bread. *Journal of Food Processing and Preservation*, vol. 35, no. 4, p. 518-523. <https://doi.org/10.1111/j.1745-4549.2010.00497.x>

Venkateswaran, V. 2010. *Characterisation of bioactive molecules from Monascus purpureus fermented finger millet (Eleusine ciracana)* : Dissertation theses. Mysore, 181 p.

Vidyalakshmi, R., Paranthaman, R., Muruges, S., Singaravadiel, K. 2009. Microbial bioconversion of rice broken to food grade pigments. *Global Journal of Biotechnology and Biochemistry*, vol. 4, no. 2, p.84-87.

Wan, N. S. 2005. Experiment no. 4A, Glucose assay by dinitrosalicylic colorimetric method. [online] s.a. [cit.2017-01-25] Available at: <https://terpconnect.umd.edu/~nsw/ench485/lab4a.htm>.

Yang, C. W., Mousa, S. A. 2012. The effect of red yeast rice (*Monascus purpureus*) in dyslipidemia and other disorders. *Complementary Therapies in Medicine*, vol. 20, no. 6, p. 466-474. <https://doi.org/10.1016/j.ctim.2012.07.004> PMid:23131380

Yang, J. H., Tseng, Y. H., Lee, Y. L., Mau, J. L. 2006. Antioxidant properties of metabolic extract from monascal rice. *LWT-Food Science and technology*, vol. 39, p. 740-747. <https://doi.org/10.1016/j.lwt.2005.06.002>

Acknowledgments:

This work was co-funded by the European Community project no 26220220180: Building the Research Centre „AgroBioTech“.

Contact address:

Eva Ivanišová, Slovak University of Agriculture, Faculty of Biotechnology and Food Sciences, Department of Plant Storage and Processing, Tr. A. Hlinku 2, 949 76 Nitra Slovakia, E-mail: eva.ivanisova@uniag.sk

Martin Rajtar, Mycoforest, Velčice 133, 95171, Slovakia,
E-mail: rajtar@hotmail.com

Helena Frančáková, Slovak University of Agriculture,
Faculty of Biotechnology and Food Sciences, Department
of Plant Storage and Processing, Tr. A. Hlinku 2, 949 76
Nitra Slovakia, E-mail: helena.francakova@uniag.sk

Marián Tokár, Slovak University of Agriculture, Faculty
of Biotechnology and Food Sciences, Department of Plant
Storage and Processing, Tr. A. Hlinku 2, 949 76 Nitra
Slovakia, E-mail: marian.tokar@uniag.sk

Štefan Dráb, Slovak University of Agriculture, Faculty of
Biotechnology and Food Sciences, Department of Plant

Storage and Processing, Tr. A. Hlinku 2, 949 76 Nitra
Slovakia, E-mail: stefan.drab@uniag.sk

Maciej Kluz, Rzeszów University, Faculty of Biology
and Agriculture, Zelwerowicza St. 4, 35-601 Poland,
E-mail: mkluz@univ.rzeszow.pl

Miroslava Kačániová, Slovak University of Agriculture,
Faculty of Biotechnology and Food Sciences, Department
of Microbiology, Tr. A. Hlinku 2, 949 76 Nitra Slovakia,
E-mail: miroslava.kacaniova@uniag.sk



EFFECT OF DNA EXTRACTION METHOD IN THE *ROSA CANINA* L. IDENTIFICATION UNDER DIFFERENT PROCESSING TEMPERATURE

Jana Žiarovská, Matúš Kysel', Radka Cimermanová, Ludmila Knoteková

ABSTRACT

Rosa canina, L. is widely used for medicinal purposes as well as in food industry where it is a valuable source, bioactive compounds and natural colorants. Actually, no specific method is recommended as suitable one for DNA extraction from rose hips. The aim of the study was to compare three commercial and three non-commercial methods to extract total genomic DNA from rose hips hypanthium. Four methods are based on the precipitation in principle and two methods are based on resin-binding. Extracted DNA was proved for the effectivity in following PCR. In total, six different DNA isolations was performed for differently heat processes rose hips - fresh hypanthium, 2-weeks frozen hypanthium, dried hypanthium (50 °C) and boiled hypanthium (100 °C). The amplification parameters of 500 bp chloroplast gene amplicon were evaluated. Obtained amounts of extracted DNA was very variable not only for every individual method used but for individual treatment of samples, too. In general, non-commercial method provided higher amount of extracted DNA, but the A260/280 ratio was lower. When regarding the processing treatment of the samples, high differences were found among the samples untreated by heat and those that were dried or boiled for three of the used extraction methods. All the samples were positive for amplification, but different amounts of amplified product were obtained. The comparison of data for concentrations of extracted DNA and concentrations of amplified product showed large differences when regarding the achieved purity of DNA in extraction.

Keywords: dog rose; DNA extraction; PCR effectivity

INTRODUCTION

Dog rose – *Rosa canina* L. is a shrub that is a widespread across a whole Europe where for more than 2,000 years it is used in traditional herbal medicinal purposes in many different ways (Winther et al., 2016). The pseudo fruit of dog rose is called a rose hip and comprises from aggregate achenes enclosed in hypanthium (De Cock et al., 2008). Actually, many of the natural rose hip content is explained about the manner of medical active action. Vitamin C is crucial for the physiological functions in human body and is important in cardiovascular and atherosclerosis prevention (Halliwell, 2006). Carotenoids as a significant part of rose hips secondary metabolites are presented by beta-caroten that act as a precursor of vitamin A as well as a lycopene that is used in food production (Hornero-Méndez and Míñquez-Mosquera, 2000; Tozzi et al., 2008). Beside the above mentioned, flavonoids, fatty acids and antioxidant properties are reported for rose hips as well as anti-inflammatory agents (Winther et al., 2016). Regarding this rich chemical composition, dog rose is used widely in food industry where rose hips are a source of bioactive compounds and color (Stānilā et al., 2015).

Raw rose hips are not used to be eaten (or very rare) without previous processing due to the hairs inside the pseudo fruit. Here, the problems arise not only because of destroying of water soluble chemical. Once the DNA is needed to be extracted from heat processed foods or food stuffs, different aspects must be considered. The processing is connected to the mechanical stress, high temperatures, rapid changes of pH or different enzymatic reactions that all has the potential to change the primary structure of DNA due to the hydrolysis, oxidation or deamination. These all results are significant in degradation or removal of DNA from the sample (Kharazmi et al., 2003). External factors that affect the extraction efficiency are the presence of chemicals in the sample and physicochemical changes during processing. Both of them result to binding of DNA to insoluble form (Gryson, 2010). Furthermore, in processed foodstuffs and food, the efficiency of the DNA extraction method affects the results of molecular analysis strongly, too. Food processes such as thermal treatment lead to a decrease of DNA fragment length and change DNA extraction efficiencies (Gryson, 2010). In all these cases, an inappropriate extraction method leads to the impossibility

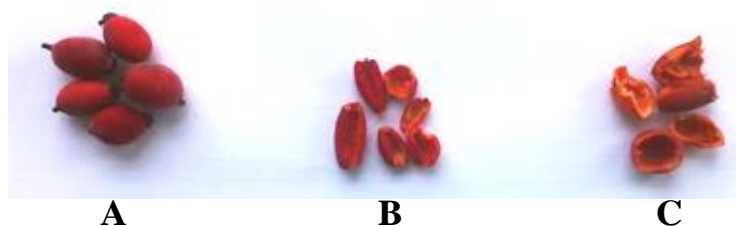

Figure 1 Biological material used in the study. A-2 – weeks frozen hypanthium; B – dried hypanthium; C – boiled hypanthium.

to isolate only clean DNA present in the sample without PCR inhibitors (Cankar et al., 2006).

Actually, no data was found by authors that refer to the method of DNA extraction from rose hips hypanthium. Different molecular studies of *Rosa canina*, L. are reported, but the extraction was performed always from fresh, frozen or silica dried plant material, leaflets, callus or rhizoids (Jürgens et al., 2007; De Cock et al., 2008; Kaul et al., 2009; Kedong et al., 2011; Ritz et al., 2017).

Similarly, no specific information was found about the *Rosa canina* L. PCR based authentication in foodstuffs. Here, different sequence data exist in the public databases that can be used for the purpose of specific molecular identification of this specie. Actually, DNA or RNA sequences are known for cytokinin dehydrogenase 5 mRNA, RcSERK1 gene, HK1 gene, rpoB, rpoC1 or matK1 genes.

In this study, different DNA extraction method was proved for the effectivity in following PCR. In total, six different DNA isolations were performed for differently heat processes rose hips and the amplification parameters of amplification of chloroplast gene were evaluated.

MATERIAL AND METHODOLOGY

Biological material of *Rosa canina* L. was collected in autumn 2016 in the locality of town Skalica. The rose hips were transported in the laboratory and divided into seeds and red fleshy floral cups – hypanthium.

The first part of fresh hypanthium was immediately processed by DNA extraction (Table 1, Figure 1), the second was dried at 50 °C and the third part was boiled at 100 °C. The last part of the hypanthium was stored by – 20 °C for two weeks and was processed by DNA extraction after this storage period.

Table 1 Codes of samples under processing variants.

Code in sample	Processing method
1	Fresh hypanthium
2	2-weeks frozen hypanthium
3	Dried hypanthium (50 °C)
4	Boiled hypanthium (100 °C)

Table 2 Methods of DNA isolation performed in the study

Sample code	Extraction method/kit	Principle of the method
A	Rogers and Bendich, 1994	precipitation
B	Dellaporta et al., 1983	precipitation
C	Padmalatha and Prasad, 2006	precipitation
D	Power Plant Pro DNA Isolation Kit, www.mobio.com	precipitation
E	Illustra DNA Extraction Kit Phytopure, www.gelifesciences.com	resin-binding
F	NucleoSpin® Food, www.mn-net.com	resin-binding

DNA extraction methods

In total, six different methods were tested to extract a total genomic DNA from rose hips (Table 2). Three of them are non-commercial and three of them are commercial extraction kits. For all the extraction methods, a 100 µg of rose hips were used.

A different strategies were a part of the tested method – based on lyses and purification with cetyltrimethylammonium bromide; using a dodecyl sulfate as detergent or commercial kits with membrane system of cleaning the lysate (Rogers and Bendich, 1985; Dellaporta et al., 1983). All the extractions were performed in biological triplicates. Nanodrop Nanophotometer™ was used for quantity and quality setting of the extracted DNA.

PCR reactions

The PCRs were performed by using the primer pair that amplifies the region of plant chloroplast as referred in Thion et al. (2002). A fragment of a length of 500 bp was the obtained product of amplification. Dream Tag DNA maser mix (2x) (Thermo Scientific) was used for the PCR reactions that were performed in 20µL.

Thermal cycling profile was as follows: 95°C 5 min; (95 °C 40 sec; 55 °C 30 sec; 72 °C 40 sec) 45 x with final extension 72 °C 5 min. All the amplifications were performed in technical triplicates in a Bio-Rad C1000™ Thermocycler.

Analyses of PCR products

The amplified product was screen for the right amplification without non specific products on 1% agarose gel electrophoresis in 1xTBE buffer stained by GelRed™. The screening analyses were performed from the first of

technical triplicates of PCR. The second of the technical triplicates of PCR was used for specific amplicons cleaning. This was performed with Agencourt AMPure XP solid-phase paramagnetic bead purification system (Beckman Coulter) following the manufacturer's instructions. Pure amplicons were dissolved in water and measured for the quantity and quality by Nanodrop Nanophotometer™.

RESULTS AND DISCUSSION

In the study, differently processed rose hips hypanthia were subjected to six DNA extraction methods to find the most appropriate for PCR product amplification. Dog roses possess the high levels of different secondary metabolites what in combination with heat processing decreases the quality of extracted DNA. All the extraction methods that are used for plant tissues consists from carbohydrates and

enzymes that ensure lysis of cell wall (Manen et al., 2005), because polysaccharides, polyphenols and other organic compounds very often pose problems in plant DNA isolation process (Cota-Sánchez et al., 2006). That is why mature plant tissues are not the most suitable for DNA extraction (Dabo et al., 1993; Zhang et al., 2000) and juvenile leaves are most often chosen in molecular analyses (Jürgens et al., 2007; De Cock et al., 2008; Kaul et al., 2009; Kedong et al., 2011; Ritz et al., 2017). Until now, to knowledge of authors, no specific extraction protocol was published for the total genomic DNA extraction from rose hips hypanthium as well as in connection to the *Rosa canina* L. authentication in food.

When Rogers and Bendich (1994) and Padmalatha and Prasad (2006) extraction protocols were used for rose hips, the high level of contamination (Figure 2) and viscose pellet formation was observed through the

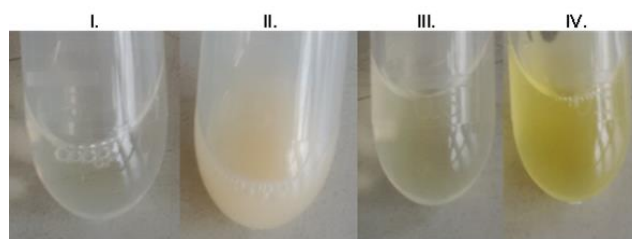

Figure 2 Differences of extraction lysates after the first incubation step when different extraction protocols used. I. – NucleoSpin® Food; II. – Padmalatha and Prasad; III. – Dellaporta; IV. – Rogers and Bendich.

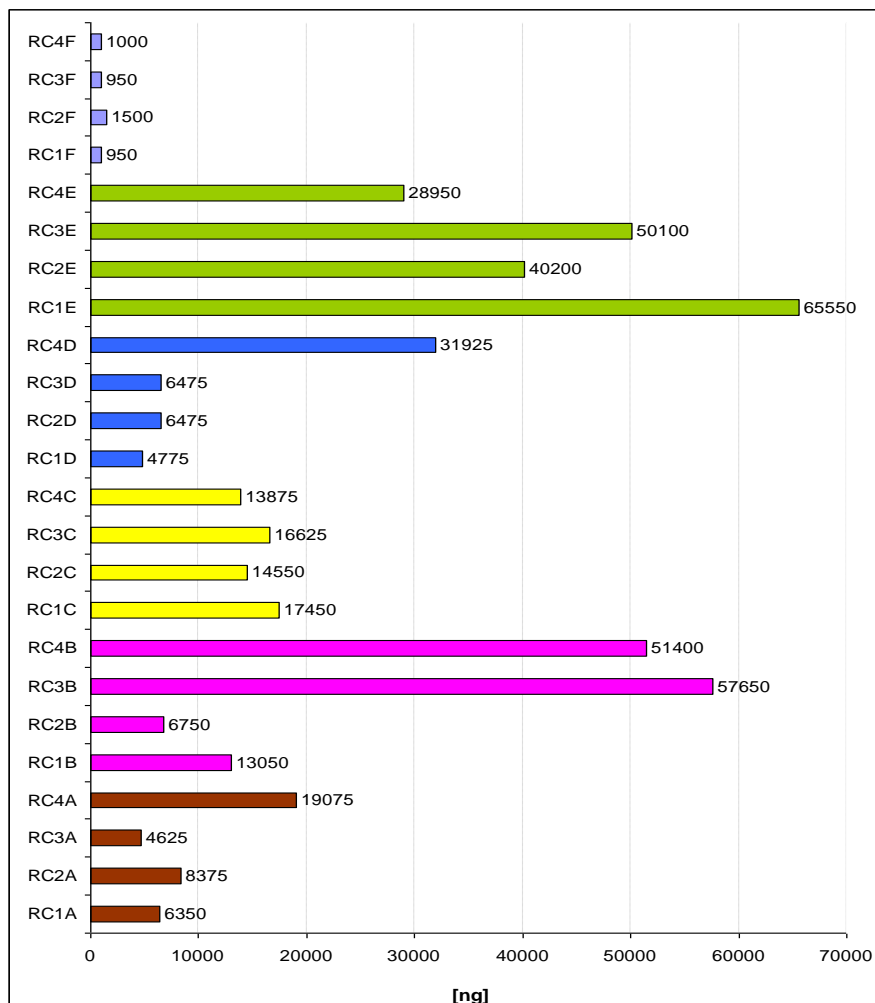

Figure 3 Total genomic DNA concentration in samples obtained by extraction methods.

Table 3 Average A260/A280 ratios in triplicates of extracted DNA from rose hips under tested extraction methods and processing variants.

Sample	A260/A280 ratios	Sample	A260/A280 ratios
RC1A	1.65	RC1D	1.8
RC2A	1.55	RC2D	1.8
RC3A	1.6	RC3D	1.75
RC4A	1.7	RC4D	1.8
RC1B	1.4	RC1E	1.7
RC2B	1.4	RC2E	1.8
RC3B	1.4	RC3E	1.8
RC4B	1.45	RC4E	1.75
RC1C	1.65	RC1F	1.75
RC2C	1.7	RC2F	1.8
RC3C	1.7	RC3F	1.75
RC4C	1.6	RC4F	1.7

extraction. In the case of **Dellaporta et al. (1983)** lysate protocol was comparable to the commercial kits that use membrane microtubes from the first steps of extraction process.

Total amounts of extracted DNA was very variable not only for every individual method used but for individual treatment of samples, too (Figure 3).

Only in the case of NucleoSpin® Food extraction kit and **Padmalatha and Prasad (2005)** extraction protocol, total amount of extracted DNA was comparable for the different treatments of rose hips hyphanthium with the results of the GeneJET™ Plant Genomic DNA Purification Mini Kit where the amount ranged from 10 – 200 ng.µL⁻¹ and no contamination was detected, so both of the protocol gives the DNA suitable for PCR analyses.

When comparing all tested methods, the highest average concentration of DNA was obtained by the Illustra DNA Extraction Kit Phytopure – 46 200 ng.µL⁻¹, followed by extraction method according to **Dellaporta et al. (1983)** – 32 212 ng.µL⁻¹. When regarding the processing treatment of the samples, high differences were found among the samples untreated by heat and those that were dried or boiled for **Dellaporta et al. (1983)** protocol. **Rogers and**

Bendich (1994) protocol and Power Plant Pro DNA Isolation Kit give the higher concentration of extracted DNA for the fresh rose hips and all the other treatments were comparable within themselves. The lowest amount of isolated DNA was obtained by NucleoSpin® Food extraction kit. The average values of DNA purity was in range of 1.45 – 1.8 (Table 3), but the commercial extraction kits provide extracted DNA that was less contaminated by potential PCR inhibitors.

All the samples were diluted for 100 ng.µL⁻¹ and in subsequent PCR, the analyses of the effectivity of extracted DNA in enzymatic amplification was proved. The chloroplast gene target **Thion et al. (2002)** was chosen to be amplified from 50 ng of. All the samples were positive for amplification, but different amounts of amplified product were obtained (figures 4 and 5). Here, a correlation (*p*-value 0.011; correlations at the 95.0% confidence level) can be seen between the amount of extracted DNA and the amount of amplified PCR products. The strongest amplification was obtained for samples where the DNA was extracted by NucleoSpin® Food extraction kit. This kit is specifically designed for the purposes of DNA extraction from food samples, that are

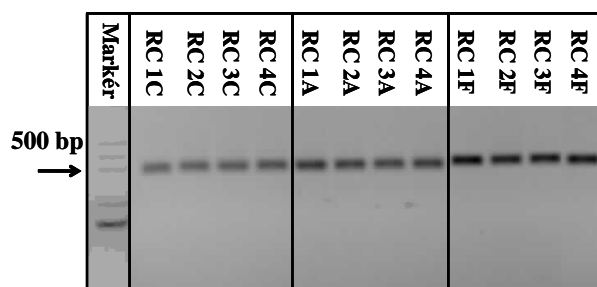

Figure 4 Amplification of target chloroplast sequence for samples extracted by methods of Padmalatha and Prasad, Rogers and Bendich and NucleoSpin® Food extraction kit.

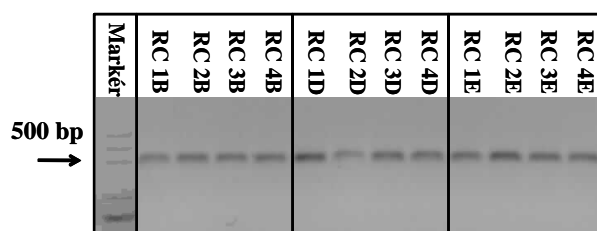

Figure 5 Amplification of target chloroplast sequence for samples extracted by method of Dellaporta et al. and Power Plant Pro DNA Isolation Kit and Illustra DNA Extraction Kit Phytopure.

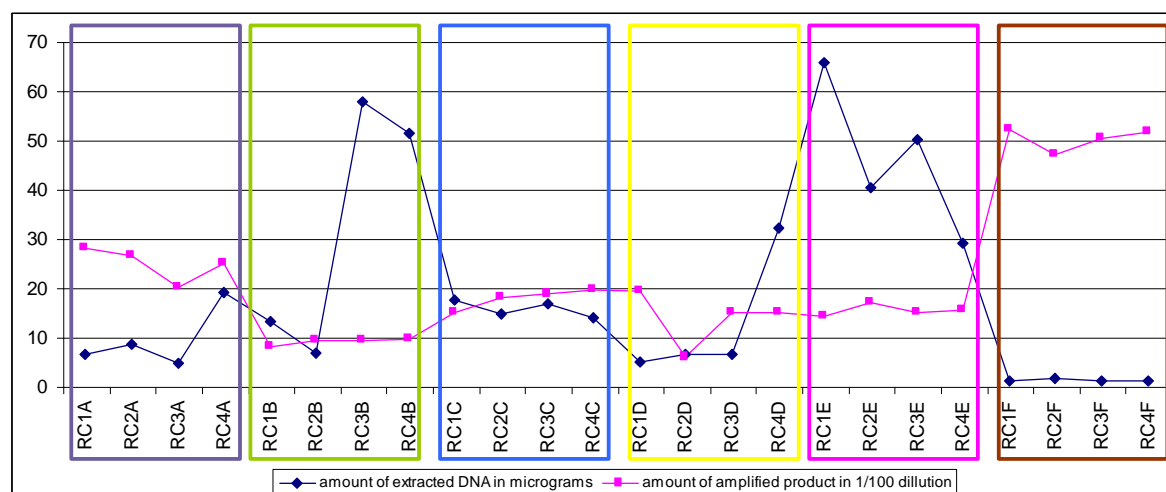

Figure 6 Comparison of tendencies between amount of extracted DNA (blue line) and amount of amplified PCR product (purple line). Different colour boxes corresponds to colours in Figure 2 and differs the extraction methods used in the study.

Table 4 Average amounts of amplified PCR products when 50 ng · µL⁻¹ DNA used as starting point.

Sample	µg of PCR product	Sample	µg of PCR product
RC1A	2.76	RC1D	1.97
RC2A	2.65	RC2D	0.65
RC3A	2.10	RC3D	1.58
RC4A	2.65	RC4D	1.53
RC1B	0.81	RC1E	1.36
RC2B	0.86	RC2E	1.65
RC3B	0.94	RC3E	1.53
RC4B	0.98	RC4E	1.47
RC1C	1.60	RC1F	5.25
RC2C	1.89	RC2F	4.83
RC3C	1.85	RC3F	5.17
RC4C	1.98	RC4F	5.23

very heterogeneous and contain many different compounds that often lead to suboptimal extraction. NucleoSpin® Food guarantees good recovery for small genomic DNA fragments that are shorter than 1 kbp and is recommended for samples where a very low DNA content is present.

A specific situation was found for the amount of extracted DNA and the amount of amplified product for the results of Illustra DNA Extraction Kit Phytopure. Here, the highest concentration of extracted DNA was obtained, but the amount of amplified product ranged from 1.36 to 1,53 µg·µL⁻¹ (Table 4).

The comparison of data for concentrations of extracted DNA and concentrations of amplified product (figure 6) show large differences when regarding the achieved purity of DNA in extraction (Table 3).

When comparing the commercial and non-commercial methods used in the study, no preference can be done for this kind of dividing of them. Residual PCR contaminants were present mostly in samples extracted by non-commercial methods, but the amount of amplified product was not affected by this (*p*-value 0.0692 at the 95.0% confidence level). The phenol based extraction methods are reported to possess the disadvantage that phenol contaminants inhibit and reduce the efficiency of PCR (Hiesinger et al., 2001). Similar results and decreased amount of amplified PCR products as obtained in this study was reported by Drábková et al. (2002). According

to A260/A280 ratio and the repeatability of the extractions, all commercial methods used in the study yielded relatively pure DNA. On the other side, for commercial kits, the largest differences were obtained, when the kit with the highest amount of extracted DNA provided only the average amounts of amplicons and the kit with the lowest amount of extracted DNA provided the highest amounts of generated amplicons. This may be a result of the presence of inhibitors in extracted DNA that originated from the sample (Volk et al., 2014). In the case of non-commercial kits, the reasons with the lower amounts of amplicons achieved in PCR could be connected to EDTA and isopropanol that was used for DNA extraction and those remain as traces in the extracted DNA (Bar et al., 2012; Hedman and Rådström, 2013). The functionality of extracted DNA in PCR is the most important evaluation factor as this determines the suitability of an extraction method. Molecular analyses based on the precisely extracted DNA are a part of many different types of DNA based analyses today (Gálová et al., 2015; Petrovičová et al., 2015; Balážová et al., 2016) For plant tissues, determination of the most suitable method is always a crucial step where a success of the analyses starts. Huaqiang et al. (2013) reported the comparison of 6 DNA extraction methods for *Vigna unguiculata* L – Rogers and Bendich, Dellaporta, Doyle, Saghai-Marroof, Aljanabi and E.Z.N.A. commercial kit. The highest yields were obtained

for Aljanabi and Dellaporta extraction methods and the highest purity was obtained by Doyle method and E.N.Z.A kit. Doosty et al. (2012) compared 4 extraction method in the isolation of total genomic DNA of *Satureja khuyistanica* – Dellaporta (1983); Doyle and Doyle, (1990); Murry and Thompson (1980) and Kang and Yang (2004). A very low quality and quantity was reported in extracted DNA for Dellaporta protocol and the authors referred it to the SDS buffer used in the method that interfered with the secondary metabolites. Abu-Romman, (2011) reported the comparison of 4 plant DNA extraction protocols – Bokszczanin and Prazybyla (2006); Doyle and Doyle (1987); Krizman et al. (2006) and Sarwat et al. (2006) for *Salvia officinalis* L. In this study again – non-commercial CTAB method by Doyle and Doyle provided the lowest DNA yield with insufficient quality.

CONCLUSION

Molecular DNA based methods are routinely applied in many fields of analyses connected to the plant tissues or food today. The precise results are fully dependent on the successful extraction of DNA with an appropriate quantity and quality. In this study, six DNA extraction methods were compared and analysed for the effectivity of PCR amplification. Four types of differently processed rose hips were used as a biological material. The yield of extracted DNA was in range of 0.9 up to 65 µg x µL⁻¹. The purity of extracted DNA is higher for commercial kits that were used. Functionality of the extracted DNA was proved in the PCR analyses and the amounts of amplified products were measured. Based on the results, the most suitable DNA extraction method for *Rosa canina* L. hyphanthium was proved NucleoSpin® Food extraction kit for all the differently processed rose hips.

REFERENCES

- Abu-Romman, S. 2011. Comparison of methods for isolating high quality DNA from sage (*Salvia officinalis*). *Journal of Medicinal Plants Research*, vol. 5, no. 6, p. 938-941.
- Bar, T., Kubista, M., Tichopad, A. 2012. Validation of kinetics similarity in qPCR. *Nucleic Acids Research*, vol. 40, p. 1395-1406. <https://doi.org/10.1093/nar/gkr778>
- Balážová, Ž., Petrovičová, L., Gálová, Z., Vivodík, M. 2016. Molecular characterisation of rye cultivars. *Potravinárstvo*, vol. 10, no. 1, p. 54-58. <https://doi.org/10.5219/522>
- Bokszczanin, K., Prazybyla, A. A. 2006. Copper (II) acetate improves the quality of pear (*Pyrus*) DNA during extraction. *Plant Molecular Biology Reporter Journal*, vol. 24, p. 249a-249d. <https://doi.org/10.1007/BF02914065>
- Cankar, K., Stebih, D., Dreo, T., Zel, J., Gruden, K. 2006. Critical points of DNA quantification by real-time PCR – effects of DNA extraction method and sample matrix on quantification of genetically modified organisms. *BMC Biotech*, vol. 6, p. 37. <https://doi.org/10.1186/1472-6750-6-37>
- Cota-Sánchez, H. J., Remarchuk, K., Ubayasena, K. 2006. Ready-to-Use DNA Extracted with a CTAB Method Adapted for Herbarium Specimens and Mucilaginous Plant Tissue. *Plant Molecular Biology Reporter*, vol. 24, no. 2, p.161-167. <https://doi.org/10.1007/BF02914055>
- Dabo, S. M., Mitchell, E. D. Jr, Melcher, U. 1993. A method for the isolation of nuclear DNA from cotton (*Gossypium*) leaves. *Analytical Biochemistry*, vol. 210, no. 1, p. 34-38. <https://doi.org/10.1006/abio.1993.1146> PMID:8098189
- Dellaporta, S. L., Wood, J., Hicks, J. B. 1983. A Plant DNA Miniprep: Version II. *Plant Molecular Biology Reporter*, vol. 1, no. 4, p. 19-21. <https://doi.org/10.1007/BF02712670>
- De Cock, K., Mijnsbrugge, K. V., Breyne, P., Van Bockstaele, E., Van Slycken, J. 2008. Morphological and AFLP-based differentiation within the taxonomical complex section *Canine* (subgenus *Rosa*). *Annals of Botany*, vol. 102, no. 5, p. 685-697. <https://doi.org/10.1093/aob/mcn151> PMID:18723861
- Doosty, B., Drikvand, R., Salahvarzi, E., Amiri, H., Hadian, J. 2012. Comparative Analysis and Optimization of Different DNA Extraction Protocols in *Satureja khuzistanica*. *International Journal of Biology*, vol. 4, no. 4, p. 112-116. <https://doi.org/10.5539/ijb.v4n4p111>
- Doyle, J. J., Doyle, J. L. 1987. A rapid DNA isolation procedure for small quantities of fresh leaf tissue. *Phytochemical Bulletin*, vol. 19, no. 1, p.11-15.
- Drábková, L., Kirschner, J., Vlček, E. 2002. Comparison of seven DNA extraction and amplification protocols in historical herbarium specimens of *Juncaceae*. *Plant Molecular Biology Reporter*, vol. 20, no. 2, 161-175. <https://doi.org/10.1007/BF02799431>
- Gálová, Z., Vivodík, M., Balážová, Ž., Kuřka-Hložáková, T. 2015. Identification and differentiation of *Ricinus communis* L. using SSR markers. *Potravinárstvo*, vol. 9, no. 1, p. 556-561. <https://dx.doi.org/10.5219/516>
- Gryson, N. 2010. Effect of food processing on plant DNA degradation and PCR-based GMO analysis: a review. *Analytical and Bioanalytical chemistry*, vol. 396, no.6, p. 2003-20022. <https://doi.org/10.1007/s00216-009-3343-2>
- Halliwell, B. 2006 Polyphenols: antioxidant treats for healthy living or covert toxins? *Journal Science Food Agriculture*, vol. 86, no. 13, p. 1992-1995. <https://doi.org/10.1002/jsfa.2612>
- Hedman, J., Rådström, P. 2013. Overcoming inhibition in real-time diagnostic PCR. *Methods in Molecular Biology*, vol. 943, p. 17-48. https://doi.org/10.1007/978-1-60327-353-4_2
- Hiesinger, M., Löffert, D., Ritt, CH., Oelmüller, U. 2001. The effects of phenol on nucleic acid preparation and downstream applications. *Qiagen News*, vol. 5, p. 23-26.
- Huaqiang, T., Haitao, H., Mamman, T., Jianyao, M., Huanxiu, L. 2013. Comparative Analysis of Six DNA Extraction Methods in Cowpea (*Vigna unguiculata* L.Walp). *Journal of Agricultural Science*, vol. 5, no. 7, p. 82-90. <https://doi.org/10.5539/jas.v5n7p82>
- Hornero-Méndez, D., Mínguez-Mosquera, M. I. 2000. Carotenoid pigments in *Rosa mosqueta* hips, an alternative carotenoid source for foods. *Journal of Agricultural Chemistry*, vol. 48, no. 3, p. 825-828. <https://doi.org/10.1021/jf991136n>
- Jürgens, A. H., Seitz, B., Kowarik, I. 2007. Genetic differentiation of *Rosa canina* (L.) at regional and continental scales. *Plant Systematic and Evolution*, vol. 269, no. 1, p.39-53. <https://doi.org/10.1007/s00606-007-0569-3>
- Kang, T. J., Yang, M. S. 2004. Rapid and reliable extraction of genomic DNA from various wild-type and transgenic plants. *BMC Biotechnology*, vol. 4, p. 20. <https://doi.org/10.1186/1472-6750-4-20>
- Kaul, K., Dhyani, D., Sharma, R. K. 2009. Evaluation of DNA Extraction Methods for RAPD, SSR and AFLP Analyses of Wild Rose Species. *Floriculture and Ornamental Biotechnology*. vol. 3, no. 1, p. 25-30.

- Kedong, X., Qinglin, L., Huifang, Y., Li, Z., Lili, D., Fengluan, L., Ling, Bi., Nan, M., Liangjun, Z. 2011. Isolation and molecular characterization of RcSERK1: A *Rosa canina* gene transcriptionally induced during initiation of protocorm-like bodies. *African Journal of Biotechnology*, vol. 10, p. 4011-4017.
- Kharazmi, M., Bauer, T., Hammes, W. P., Hertel, C. 2003. Effect of food processing on the fate of DNA with regard to degradation and transformation capability in *Bacillus subtilis*. *Systematic and Applied Microbiology*, vol. 26, no 4, p. 495-501. <https://doi.org/10.1078/072320203770865774>
PMid:14666975
- Krizman, M., Jakse, J., Baricevic, D., Javornik, B., Prosek, M. 2006. Robust CTAB-activated charcoal protocol for plant DNA extraction. *Acta Agriculturae Slovenica*, vol. 87, no. 2, p. 427-433.
- Manen, J. F., Sinitsyna, O., Aeschbach, L., Markov, A. V., Sinitsyn, A. 2005. A Fully Automatable Enzymatic Method for DNA Extraction from Plant Tissue. *BMC Plant Biology*, vol. 5, no. 23, p. 1-9. <https://doi.org/10.1186/1471-2229-5-23>
- Murry, M. G., Thompson, W. F. 1980. Rapid isolation of high molecular weight plant DNA. *Nucleic Acids Research*, vol. 8, no. 19, 4321-4325. <https://doi.org/10.1093/nar/8.19.4321>
- Padmalatha, K., Prasad, M. N. V. 2006. Optimization of DNA isolation and PCR protocol for RAPD analysis of selected medicinal and aromatic plants of conservation concern from Peninsular India. *African Journal of Biotechnology*, vol. 5, no.3, p. 230-234.
- Petrovičová, L., Gálová, Z., Balážová, Ž., Vivodík, M., Wójcik-Jagla, M., Rapacz, M. 2015. Assessment of RAPD polymorphism in rye (*Secale cereale* L.) genotypes. *Journal of Microbiology, Biotechnology and Food Sciences*, vol. 4, no. 2, p. 94-97. <https://doi.org/10.15414/jmbfs.2015.4.special2.94-97>
- Ritz, Ch. M., Wissemann, V. 2011. Microsatellite analyses of artificial and spontaneous dogrose hybrids reveal the hybridogenic origin of *Rosa micrantha* by the contribution of unreduced gametes. *Journal of Heredity*, vol. 102, no. 2, p. 217-227. <https://doi.org/10.1093/jhered/esq124>
- Sarwat, M., Negi, M. S., Lakshmikumaran, M., Tyagi, A. K., Das, S., Srivastava, P. S. 2006. A standardized protocol for the genomic DNA isolation from *Terminalia arjuna* for genetic diversity analysis. *Electronic Journal of Biotechnology*, vol. 9, no. 1, p. 86-91. <https://doi.org/10.2225/vol9-issue1-fulltext-3>
- Stănilă, A., Diaconeasa, Z., Roman, I., Sima, N., Măniuțiu, D., Roman, A., Sima, R. 2015. Extraction and Characterization of Phenolic Compounds from Rose Hip (*Rosa canina* L.) Using Liquid Chromatography Coupled with Electrospray Ionization – Mass Spectrometry. *Notulae Botanicae Horti Agrobotanici Cluj-Napoca*, vol. 43, no. 2, p. 349-354.
- Rogers, S. O., Bendich, A. J. 1994. Extraction of total cellular DNA from plants, algae and fungi. In: Gelvin, S. B. et al. *Plant Molecular Biology Manual D1*. 2nd ed. Belgium : Kluwer Academic Publishers, pp. 1-8. ISBN 0-7923-2868-2. https://doi.org/10.1007/978-94-011-0511-8_12
- Tozzi, R., Mulinacci, N., Storlikken, K., Pasquali, I., Vincieri, F. F., Bettini, R. 2008. Supercritical extraction of carotenoids from *Rosa canina* L. hips and their formulation with beta-cyclodextrin. *AAPS PharmSciTech*, vol. 9, no. 2, p.693-700. <https://doi.org/10.1208/s12249-008-9100-6>
PMid:18528762
- Volk, H., Piskernik, S., Kurinčič, M., Klančnik, A., Toplak, N., Jeršek, B. 2014. Evaluation of different methods for DNA extraction from milk. *Journal of Food and Nutrition Research*, vol. 2, p. 1-10.
- Winther, K., Vinther Hansen, A. S., Campbell-Tofte, J. 2016. Bioactive ingredients of rose hips (*Rosa canina*, L) with special reference to antioxidative and anti-inflammatory properties: in vitro studies. *Botanics: Targets and Therapy*, vol. 6, p. 11-23. <https://doi.org/10.2147/BTAT.S91385>
- Zhang, J., Stewart, J. M. 2000. Economic and rapid method for extracting cotton genomic DNA. *Journal of Cotton Science*, vol. 4, p. 193-201.

Acknowledgments:

This research was supported by European Community under project no 26220220180: Building Research Centre "AgroBioTech".

Contact address:

doc. Ing. PaedDr. Jana Žiarovská, PhD., Slovak University of Agriculture, Faculty of Agrobiology and Food Resources, Department of Genetic and Plant Breeding, Tr. A. Hlinku 2, 949 76 Nitra Slovakia, E-mail: jana.ziarovska@uniag.sk

Ing. Matúš Kysel', Slovak University of Agriculture, Faculty of Agrobiology and Food Resources, Department of Genetic and Plant Breeding, Tr. A. Hlinku 2, 949 76 Nitra Slovakia, E-mail: xkysel@is.uniag.sk

Bc. Radka Cimermanová, Slovak University of Agriculture, Faculty of Biotechnology and Food Sciences, Tr. A. Hlinku 2, 949 76 Nitra Slovakia, undergraduate student, E-mail: radka.cimermanova@gmail.com

Bc. Ludmila Knoteková, Slovak University of Agriculture, Faculty of Agrobiology and Food Resources, Tr. A. Hlinku 2, 949 76 Nitra Slovakia, undergraduate student, E-mail: ludmilaknotekova@gmail.com



DETECTION GENETIC VARIABILITY OF *SECALE CEREALE* L. BY SCOT MARKERS

Lenka Petrovičová, Želmíra Balážová, Martin Vivodík, Zdenka Gálová

ABSTRACT

Rye (*Secale cereale* L.) is our traditional cereal used for baking. The genetic variability of grown rye has been reduced by modern agronomic practices, which subsequently prompted the importance of search for species that could be useful as a gene pool for the improving of flour quality for human consumption or for other industrial uses. Therefore, the aim of this study was to detect genetic variability among the set of 45 rye genotypes using 8 SCoT markers. Amplification of genomic DNA of 45 genotypes, using SCoT analysis, yielded 114 fragments, with an average of 14.25 polymorphic fragments per primer. The most polymorphic primer was SCoT 36, where 21 polymorphic amplification products were detected. In contrast the lowest polymorphic primer was SCoT 45 with 5 polymorphic products. Genetic polymorphism was characterized based on diversity index (DI), probability of identity (PI) and polymorphic information content (PIC). The hierarchical cluster analysis showed that the rye genotypes were divided into 2 main clusters. One rye genotype Motto, origin from Poland formed a separate subcluster (1b). Subcluster 2a included only genotype Valtické (CSK). In this experiment, SCoT proved to be a rapid, reliable and practicable method for revealing of polymorphism in the rye cultivars.

Keywords: *Secale cereale*; SCoT markers; genetic diversity

INTRODUCTION

Rye (*Secale cereale* L.) is a member of the *Triticeae* tribe of the grass family *Poaceae* and related to bread wheat (*Triticum aestivum* L.) and barley (*Hordeum vulgare* L.). It has the largest genome ~7.9 Gbp (Bartoš et al., 2008) among all diploid *Triticeae* with more than 90% repetitive sequences (Bauer et al., 2016).

Secale cereale L. has been studied by morphological (Persson et al., 2006), cytological (Schlegel et al., 1987; Alkimova et al., 2004), isozymes (Vence et al., 1987), ribosomal DNA spacer lengths (Reddy et al., 1990), restriction fragment length polymorphisms (RFLPs) (Saal and Wricke, 1999), amplified fragment length polymorphisms (AFLPs) (Chikmawati et al., 2005) and microsatellite (Bolibok et al., 2005; Shang et al., 2006) analyses (Akhavan et al., 2010). In recent years, a number of molecular markers have been employed for genetic diversity evaluation, genetic mapping, and quantitative trait locus analysis (Vivodík et al., 2016). Molecular markers are useful for cultivar identification, biodiversity analyses, for phylogenetic studies and other applications (Semagn et al., 2006). The choice of the marker system to use for a particular application depends on its ease of use and the particular objectives of the investigation. It has been suggested that the measure of genetic diversity by molecular markers for breeding purposes should be based on functionally characterized genes, or targeted genes, as

these may reflect functional polymorphisms (Andersen and Lübberstedt, 2003; Guo et al., 2012).

SCoT is a simple, novel and gene-targeted DNA marker based on the short conserved region in plant genes (Collard and Mackill, 2009). Primers for SCoT marker analysis were designed from the conserved region surrounding the translation initiation codon, ATG (Joshi et al., 1997; Sawant et al., 1999). A single 18-mer oligonucleotides is used as both forward and reverse primer for PCR, and the annealing temperature is set at 50 °C (Gao et al., 2014).

SCoT markers are more reproducible than RAPD and ISSR, and it is suggested that primer length and annealing temperature are not the sole factors determining reproducibility (Gorji et al., 2011). The utility of this primer in genetic diversity analysis has been reported in a number of plant species (Collard and Mackill, 2009; Gorji et al., 2011; Xiong et al., 2009; Amirmoradi et al., 2012; Guo et al., 2012; Luo et al., 2012; Sujatha et al., 2013; Rathore et al., 2014).

The present study is focused on estimation of genetic distance between 45 rye genotypes, based on 8 SCoT markers. Although the information gathered here would be helpful in future for genomic mapping studies leading to development of rye cultivars with broader genetic background to obtain improved crop productivity.

MATERIAL AND METHODOLOGY

Forty-five rye (*Secale cereale* L.) genotypes were used in the present study. Seeds of rye were obtained from the Gene Bank of the Slovak Republic of the Plant Production Research Center in Piešťany and Gene Bank of the Czech Republic of the Crop Research Institute in Prague (Table 1).

Genomic DNA of rye cultivars was extracted from leaves of 14-day old plantlets with GeneJET Plant Genomic DNA Purification Mini Kit (Thermo Scientific, Gdańsk, Poland) according to the manufacturer's instructions. DNA concentrations were estimated by UV-Vis spectrophotometer Q5000, Quawell.

A total of 8 SCoT primers developed by Collard and Mackill (2009) were selected for the present study

(Table 2). Each 15 µL amplification reaction consisted of 1.5 µL (100 ng) template DNA, 7.5 µL Master Mix (Genei, Bangalore, India), 1.5 µL 10 pmol primer, and 4.5 µL distilled water. Amplification was performed in a programmed thermocycler (Biometra, Germany) using the following program: 94 °C for 3 min; 35 cycles of 94 °C for 1 min, 50 °C for 1 min, and 72 °C for 2 min; a final extension at 72 °C for 5 min. Amplified products were separated in 1.5% agarose in 1× TBE buffer. The gels were stained with ethidium bromide and documented using gel documentation system UVP PhotoDoc-t[®] camera system. A dendrogram was constructed based on hierarchical cluster analysis using the unweighted pair group method with arithmetic average (UPGMA).

Table 1 List of *Secale cereale* cultivars, their country of origin and taxa used in this study.

	Genotype	Country of origin	Taxa
1	Valtické	CSK	<i>S. cereale</i> L. subsp. <i>cereale</i> var. <i>cereale</i>
2	Tešovské	CSK	<i>S. cereale</i> L. subsp. <i>cereale</i> var. <i>cereale</i>
3	Keřkovské	CSK	<i>S. cereale</i> L. subsp. <i>cereale</i> var. <i>cereale</i>
4	Zenit	CSK	<i>S. cereale</i> L. subsp. <i>cereale</i> var. <i>cereale</i>
5	Chlumecké	CSK	<i>S. cereale</i> L. subsp. <i>cereale</i> var. <i>cereale</i>
6	České	CSK	<i>S. cereale</i> L. subsp. <i>cereale</i> var. <i>cereale</i>
7	Albedo	CSK	<i>S. cereale</i> L. subsp. <i>cereale</i> var. <i>cereale</i>
8	Židlochovický Panis	CSK	<i>S. cereale</i> L. subsp. <i>cereale</i> var. <i>cereale</i>
9	Nalžovské	CSK	<i>S. cereale</i> L. subsp. <i>cereale</i> var. <i>cereale</i>
10	Dobrovické	CSK	<i>S. cereale</i> L. subsp. <i>cereale</i> var. <i>cereale</i>
11	Vigl'ašské	CSK	<i>S. cereale</i> L. subsp. <i>cereale</i> var. <i>cereale</i>
12	Ratbořské	CSK	<i>S. cereale</i> L. subsp. <i>cereale</i> var. <i>cereale</i>
13	Laznické	CSK	<i>S. cereale</i> L. subsp. <i>cereale</i> var. <i>cereale</i>
14	Breno	CSK	<i>S. cereale</i> L. subsp. <i>cereale</i> var. <i>cereale</i>
15	Dobřensické krmné	CSK	<i>S. cereale</i> L. var. <i>multicaule</i>
16	Aventino	CZE	<i>S. cereale</i> L.
17	Selgo	CZE	<i>S. cereale</i> L. subsp. <i>tetraploidum</i> KOBYL
18	Radomske	CZE	<i>S. cereale</i> L.
19	České normální	CZE	<i>S. cereale</i> L.
20	Křmne žito	CZE	<i>S. cereale</i> L.
21	Warko	POL	<i>S. cereale</i>
22	Dankowskie Zlote	POL	<i>S. cereale</i> L. subsp. <i>cereale</i> var. <i>cereale</i>
23	Zduno	POL	<i>S. cereale</i> L. subsp. <i>cereale</i> var. <i>cereale</i>
24	Motto	POL	<i>S. cereale</i> L. subsp. <i>cereale</i> var. <i>cereale</i>
25	Pancerne	POL	<i>S. cereale</i> L. subsp. <i>cereale</i> var. <i>cereale</i>
26	Wojcieszycie	POL	<i>S. cereale</i> L. subsp. <i>cereale</i> var. <i>cereale</i>
27	Universalne	POL	<i>S. cereale</i> L. subsp. <i>cereale</i> var. <i>cereale</i>
28	Dankowskie Nowe	POL	<i>S. cereale</i> L. subsp. <i>cereale</i> var. <i>cereale</i>
29	Amilo	POL	<i>S. cereale</i> L. subsp. <i>cereale</i> var. <i>cereale</i>
30	Wibro	POL	<i>S. cereale</i> L. subsp. <i>cereale</i>
31	Bosmo	POL	<i>S. cereale</i> L.
32	Rostockie	POL	<i>S. cereale</i> L.
33	Hegro	POL	<i>S. cereale</i> L.
34	Walet	POL	<i>S. cereale</i> L.
35	Kier	POL	<i>S. cereale</i> L.
36	Tetra Start	SUN	<i>S. cereale</i> L. subsp. <i>tetraploidum</i> KOBYL
37	Čerkascanka tetra	SUN	<i>S. cereale</i> L. subsp. <i>tetraploidum</i> KOBYL
38	Voschod 1	SUN	<i>S. cereale</i> L. subsp. <i>cereale</i> var. <i>cereale</i>
39	Golubka	SUN	<i>S. cereale</i> L. subsp. <i>cereale</i> var. <i>cereale</i>
40	Mnogokoloskaja	SUN	<i>S. cereale</i> L. subsp. <i>cereale</i> var. <i>cereale</i>
41	Lovaszpatonai	HUN	<i>S. cereale</i> L. subsp. <i>cereale</i> var. <i>cereale</i>
42	Ovari	HUN	<i>S. cereale</i> L. subsp. <i>cereale</i> var. <i>cereale</i>
43	Kecskemeti	HUN	<i>S. cereale</i> L. subsp. <i>cereale</i> var. <i>cereale</i>
44	Tetra Sopronhorpacsi	HUN	<i>S. cereale</i> L. subsp. <i>tetraploidum</i> KOBYL
45	Varda	HUN	<i>S. cereale</i> L.

Note: CSK - Czechoslovakia, CZ - Czech Republic, HUN - Hungary, PL - Poland, SUN - Union of former Soviet Socialist Republic.

For the assessment of the polymorphism between rye genotypes and usability SCoT markers in their differentiation we used polymorphic information content (PIC) (Weber, 1990), diversity index (DI) (Weir, 1990) and the probability of identity (PI), (Paetkau et al., 1995).

$$PIC = 1 - \left(\sum_{i=1}^n p_i^2 \right) - \sum_{i=1}^{n-1} \sum_{j=i+1}^n 2p_i^2 \cdot p_j^2$$

$$PI = \sum p_i^4 + \sum_{i=1}^{i=n-1} \sum_{j=i+1}^n (2p_i p_j)^2$$

$$DI = 1 - \sum p_i^2$$

where p^i and p^j are frequencies of i^{th} and j^{th} fragment of given genotype.

RESULTS AND DISCUSSION

The development of molecular markers has opened up numerous possibilities for their application in plant breeding. PCR-based markers, including Start Codon Targeted (SCoT) polymorphism, have been developed to analyse genetic polymorphism effectively.

In the present study, the representatives of the genus *Secale cereale* collected from different parts of central Europe and from the Union of Soviet Socialist Republics were differentiated by the DNA fingerprinting patterns using 8 SCoT primers. The efficacy of the SCoT technique in this study is further supported by the obtained PIC and DI and PI values of the primers used in the analysis. The PIC value of the SCoT marker system was found to be 0.78 which are at par with the optimal PIC.

PCR amplification of DNA using 8 primers (Table 2) for SCoT analysis produced 123 DNA fragments that could be scored in all 45 genotypes of rye. The number of amplified fragments varied from 5 (SCoT 45) to 21 (SCoT 36), and the amplicon size ranged from 400 to 3000 bp. Of the 123 amplified bands 114 were polymorphic, with an average of 14.25 polymorphic bands per primer. Results indicated the presence of wide genetic variability among different genotypes of rye. From these eight primers, primer SCoT 36 was the most polymorphic, where 21 polymorphic amplification products were detected. The lowest number of amplified polymorphic fragments (5) was detected by primer SCoT 45. The percentage of polymorphism ranged from 73.7% to 100%.

To determine the level of polymorphism in the analysed group of rye genotypes, diversity index DI, probability of identity PI and polymorphic information content PIC were calculated. All three indicators were applied for all eight SCoT primers and for their calculation, the individual frequencies of fragments of each marker were used. The diversity index (DI) of SCoT markers ranged from 0.433 (SCoT 45) to 0.36 (SCoT 26) with an average of 0.834. The lowest values of polymorphic information content were recorded for SCoT 45 (0.418) and the the highest PIC values were detected for SCoT 26 (0.936) with an average of 0.835. Probability of identity was low ranged from 0.0003 to 0.032 with an average of 0.007 that indicates the possibility to differentiate genetically close genotypes.

Bhattacharyya et al. (2013) detected genetic variability in the wild genotypes of *Dendrobium nobile* Lindl. collected from different parts of Northeast India and they using a Start Codon Targeted (SCoT) marker system. A total of sixty individuals comprising of six natural populations were investigated for the existing natural genetic diversity. One hundred and thirty two (132) amplicons were produced by SCoT marker generating 96.21% polymorphism. The PIC value of the SCoT marker system was 0.78 which is lower than in our study. In study Luo et al. (2012), start codon targeted (SCoT) markers were employed to investigate the genetic diversity of 73 mango accessions obtained from Guangxi province, China. A total of 275 bands were amplified by thirty-four SCoT primers, of which 203 (73.82%) were polymorphic. Luo et al. (2012) detected lower percentage of polymorphism in comparison to our study.

Start codon-targeted markers were utilized by Gajera et al. (2014) who used 19 SCoT markers for characterization and genetic comparison among 20 mango cultivars. These primers produced total 117 loci across 20 cultivars, of which 96 (79.57%) were polymorphic.

A set of 18 primers SCoT primers were used to fingerprint 20 peanut accessions. 18 primers generated a total of 157 fragments with a mean of 8.72, ranging from 4 (SCoT 25) to 17 (SCoT 6) per primer. Of 157 bands, 97 (61.78%) fragments were present in all the 20 accessions and 60 bands (38.22%) were polymorphic. Polymorphic index (PI) per primer ranged from 0.09 (SCoT 19) to 1.65 (SCoT 15), with an average of 0.82 (Xiong et al., 2011). Lower PIC using SCoT analysis was detected, Arya et al. (2014) in *Morinda tomentosa* and that 0.189 ± 0.103.

Table 2 Statistical characteristics of the SCoT markers used in rye.

SCoT primer	Primer sequence (5' - 3')	TNoB	NoPB	PIC	DI	PI
SCoT 6	CAACAATGGCTACCACGC	18	18	0.93	0.93	0.0004
SCoT 9	CAACAATGGCTACCAGCA	12	10	0.905	0.907	0.0009
SCoT 26	ACCATGGCTACCACCGTC	19	19	0.936	0.936	0.0003
SCoT 28	CCATGGCTACCACCGCC	18	17	0.934	0.934	0.0003
SCoT 36	GCAACAATGGCTACCACC	21	21	0.934	0.934	0.0003
SCoT 45	ACAATGGCTACCACTGAC	5	4	0.418	0.433	0.032
SCoT 54	ACAATGGCTACCACCAGC	11	11	0.883	0.886	0.001
SCoT 59	ACAATGGCTACCACCATC	19	14	0.741	0.712	0.022
Average		15.37	14.25	0.35	0.834	0.007
Total		123	114	-	-	-

Note: TNoB – Total number of bands, NoPB – Number of polymorphic bands, PIC- polymorphic information content, DI - diversity index, PI - probability of identity.

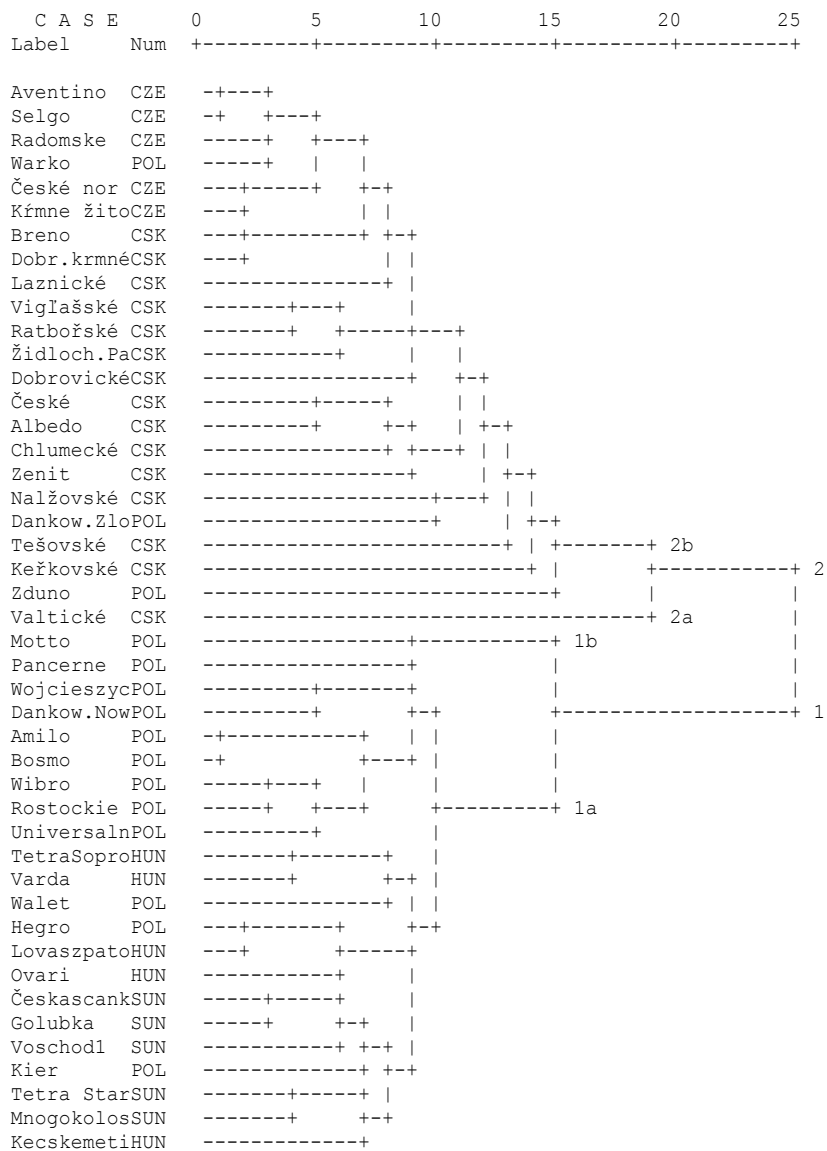

Figure 1 Dendrogram of 45 rye genotypes prepared based on 8 SCoT markers.

Note: CSK - Czechoslovakia, CZ - Czech Republic, HUN - Hungary, PL - Poland, SUN - Union of former Soviet Socialist Republic.

Luo et al. (2010) evaluated genetic variation and relationships among 47 mango germplasm and 3 relative species from Guangxi province in China, using Start Codon Targeted (SCoT) markers. 33 SCoT primers yielded a total of 273 clear and bright bands and their sizes ranged between 250 bp and 4000 bp. The number of bands varied from 3 (SCoT 9) to 15 (SCoT 70) with an average of 8.27 bands per primer. Of 273 bands, 208 bands (76.19%) were found to be polymorphic, the number of polymorphic bands varied from 2 (SCoT 9 and SCoT 54) to 14 (SCoT 70) with an average of 6.3 bands per primer. The detected polymorphism per primer among the tested accessions ranged from 40% (SCoT54) to 100% (SCoT3 and SCoT61).

The SCoT polymorphism marker technique has been successfully applied in rice (Collard and Mackill, 2009) peanut (Xiong et al., 2011), cicer (Pakseresht et al., 2013), oak (Alikhani et al., 2014) and potato (Gorji et al., 2011).

For determination of the genetic relationships among rye genotypes a dendrogram was used. The dendrogram was constructed based on principle of hierarchical cluster analysis using UPGMA algorithm in statistical program SPSS. Analyzed rye genotypes were divided into two major clusters (1 and 2). The first cluster was divided in two subclustres (1A and 1B). Subcluster 1A contains 11 genotypes which were bred in Poland (52.4%), and group of genotypes coming from Union of Soviet Socialist Republics (23.8%) and Hungary (23.8%). Subcluster 1B included only Polish genotype Motto. The second cluster was divided into two groups (2A and 2B). In cluster 2A one rye genotype was separated – Valtické (CSK). Three varieties of rye coming from Poland, fourteen genotypes from Czechoslovakia and five genotypes from Czech Republic formed subcluster 2B. We could not distinguish 2 genotypes, Aventino and Selgo grouped in 2B subcluster, which can be caused due the same genetic background (Figure 1).

CONCLUSION

Overall, the 8 SCoT markers were fairly successful at specifically fingerprinting the *Secale* accessions. The primer sets scored amplified clear, well-resolved fragments with little stutter. The SCoT markers could distinguish between the various *Secale* species. The SCoT marker technique may be most correlated to the functional gene and their corresponding traits because its primers were designed according to the short conserved region surrounding the ATG translation start codon, where the ATG context is a part of the functional gene.

REFERENCES

Akhavan, A., Saeidi, H., Rahiminejad, M. R. 2010. Genetic diversity of *Secale cereale* L. in Iran as measured using microsatellites. *Genetic resources and crop evolution*, vol. 57, no. 3, p. 415-422. <https://doi.org/10.1007/s10722-009-9480-9>

Alikhani, L., Rahmani, M. S., Shabaniyan, N., Badakhshan, H., Khadivi-Khub, A. 2014. Genetic variability and structure of *Quercus brantii* assessed by ISSR, IRAP and SCoT markers. *Gene*, vol. 552, no. 1, p. 176-183.. <https://doi.org/10.1016/j.gene.2014.09.034> PMID:25241382

Alkimova, O. G., Mazurok, N. A., Potapova, T. A., Zakian, S. M., Heslop-Harrison, J. S., Vershinin, A. V. 2004. Diverse patterns of the tandem repeats organization in rye chromosomes. *Chromosoma*, vol. 113, no. 4, p. 42-52. <https://doi.org/10.1007/s00412-004-0294-4>

Amirmoradi, B., Talebi, R., Karami, E. 2012. Comparison of genetic variation and differentiation among annual *Cicer* species using start codon targeted (SCoT) polymorphism, DAMD-PCR, and ISSR markers. *Plant systematics and evolution*, vol. 298, no. 9, p. 1679-1688. <https://doi.org/10.1007/s00606-012-0669-6>

Andersen, J. R., Lübberstedt, T. 2003. Functional markers in plants. *Trends in Plant Science*, vol. 8, no. 11, p. 554-560. <https://doi.org/10.1016/j.tplants.2003.09.010> PMID:14607101

Arya, L., Narayanan, R. K., Verma, M., Singh, A. K., Gupta, V. 2014. Genetic diversity and population structure analyses of *Morinda tomentosa* Heyne, with neutral and gene based markers. *Genetic resources and crop evolution*, vol. 61, no. 8, 1469-1479. <https://doi.org/10.1007/s10722-014-0168-4>

Bartoš, J., Paux, E., Kofler, R., Havránková, M., Kopecký, D. 2008. A first survey of the rye (*Secale cereale*) genome composition through BAC end sequencing of the short arm of chromosome 1R. *BMC Plant Biology*, vol. 8, p. 1-12. <https://doi.org/10.1186/1471-2229-8-95> PMID:18803819

Bauer, E., Schmutzer, T., Barilar, I., Mascher, M., Gundlach, H., Martis, M. M., Schmidt, M. 2016. Towards a whole-genome sequence for rye (*Secale cereale* L.). *The Plant Journal*, vol. 89, no. 5, p. 853-869. <https://doi.org/10.1111/tpj.13436> PMID:27888547

Bhattacharyya, P., Kumaria, S., Kumar, S., Tandon, P. 2013. Start Codon Targeted (SCoT) marker reveals genetic diversity of *Dendrobium nobile* Lindl., an endangered medicinal orchid species. *Gene*, vol. 529, no. 1, p. 21-26. <https://doi.org/10.1016/j.gene.2013.07.096> PMID:23939470

Bolibok, H., Rakoczy-Trojanowska, M., Hromada, A., Pietrzykowski, R. 2005. Efficiency of different PCR- based marker systems in assessing genetic diversity among winter

rye (*Secale cereale* L.) inbred lines. *Euphytica*, vol. 146, no. 1, p. 109-116. <https://doi.org/10.1007/s10681-005-0548-0>

Collard, B. C.Y., Mackill, D. J. 2009. Start codon targeted (SCoT) polymorphism: a simple, novel DNA marker technique for generating gene-targeted markers in plants. *Plant Molecular Biology Reproduction*, vol. 27, no. 1, p. 86-93. <https://doi.org/10.1007/s11105-008-0060-5>

Gajera, H. P., Bambharolia, R. P., Domadiya, R. K., Patel, S. V., Golakiya, B.A. 2014. Molecular characterization and genetic variability studies associated with fruit quality of indigenous mango (*Mangifera indica* L.) cultivars. *Plant Systematics and Evolution*, vol. 300, no. 5, p. 1011-1020. <https://doi.org/10.1007/s00606-013-0939-y>

Gao, Y. H., Zhu, Y. Q., Tong, Z. K., Xu, Z. Y., Jiang, X. F., Huang, C. H. 2014. Analysis of genetic diversity and relationships among genus *Lycoris* based on start codon targeted (SCoT) marker. *Biochemical Systematics and Ecology*, vol. 57, 221-226. <https://doi.org/10.1007/s11033-011-1329-6> PMID:22170600

Gorji, A. M., Poczai, P., Polgar, Z., Taller, J. 2011. Efficiency of arbitrarily amplified dominant markers (SCoT, ISSR and RAPD) for diagnostic fingerprinting in tetraploid potato. *American journal of potato research*, vol. 88, no. 3, p. 226-237. <https://doi.org/10.1007/s12230-011-9187-2>

Guo, D. L., Zhang, J. Y., Liu, C. H. 2012. Genetic diversity in some grape varieties revealed by SCoT analyses. *Molecular biology reports*, vol. 39, no. 5, p. 5307-5313. <https://doi.org/10.1007/s11033-011-1329-6>

Chikmawati, T., Skovmand, B., Gustafson, J. P. 2005. Phylogenetic relationships among *Secale* species revealed by amplified fragment length polymorphisms. *Genome*, vol. 48, no. 1, p. 792-801. <https://doi.org/10.1139/g05-043> PMID:16391685

Joshi, C. P., Zhou, H., Huang, X., Chiang, V. L. 1997. Context sequences of translation initiation codon in plants. *Plant Molecular Biology*, vol. 35, no. 6, p. 993-1001. <https://doi.org/10.1023/A:1005816823636> PMID:9426620

Luo, C., He, X. H., Chen, H., Hu, Y., Ou, S. J. 2012. Genetic relationship and diversity of *Mangifera indica* L.: revealed through SCoT analysis. *Genetic resources and crop evolution*, vol. 59, no. 7, p. 1505-1515. <https://doi.org/10.1007/s10722-011-9779-1>

Luo, C., He, X. H., Chen, H., Hu, Y., Ou, S. J. 2012. Genetic relationship and diversity of *Mangifera indica* L.: revealed through SCoT analysis. *Genetic Resources of Crop Evolution*, vol. 59, no. 1, p. 1505-1515. <https://doi.org/10.1007/s10722-011-9779-1>

Luo, C., He, X. H., Chen, H., Ou, S. J., Gao, M. P. 2010. Analysis of diversity and relationships among mango cultivars using Start Codon Targeted (SCoT) markers. *Biochemical Systematics and Ecology*, vol. 38, no. 6, p. 1176-1184. <https://doi.org/10.1016/j.bse.2010.11.004>

Paetkau, D., Calvert, W., Stirling, I., Strobeck, C. 1995. Microsatellite analysis of population structure in Canadian polar bears. *Molecular Ecology*, vol. 4, no. 3, p. 347-354. <http://dx.doi.org/10.1111/j.1365-294x.1995.tb00227.x>

Pakseresht, F., Talebi, R., Karami, E. 2013. Comparative assessment of ISSR, DAMD and SCoT markers for evaluation of genetic diversity and conservation of landrace chickpea (*Cicer arietinum* L.) genotypes collected from north-west of Iran. *Physiology and Molecular Biology of Plants*, vol. 19, no. 4, p. 563-574. <https://doi.org/10.1007/s12298-013-0181-7> PMID:24431526

- Persson, K., von Bothmer, R., Gullord, M., Gunnarsson, E. 2006. Phenotypic variation and relationships in landraces and improved varieties of rye (*Secale cereale* L.) from northern Europe. *Genetic Resources Crop Evolution*, vol. 53, no. 1, p. 857-866. <https://doi.org/10.1007/s10722-004-6694-8>
- Rathore, N. S., Rai, M. K., Phulwaria, M., Rathore, N., Shekhawat, N. S. 2014. Genetic stability in micropropagated Cleome gynandra revealed by SCoT analysis. *Acta physiologiae plantarum*, vol. 36, no. 2, p. 555-559. <https://doi.org/10.1007/s11738-013-1429-0>
- Reddy, P., Appel, R., Baum, B. R. 1990. Ribosomal DNA spacer-length variation in *Secale* ssp. (*Poaceae*). *Plant Systematic Evolution*, vol. 171, no. 4, p. 205-220. <https://doi.org/10.1007/bf00940606>
- Saal, B., Wricke, G. 1999. Development of simple sequence repeat markers in rye (*Secale cereale* L.). *Genome*, vol. 42, no. 2, p. 964-972. <https://doi.org/10.1139/gen-42-5-964> PMID:10584314
- Sawant, S. V., Singh, P. K., Gupta, S. K., Madnala, R., Tuli, R. 1999. Conserved nucleotide sequences in highly expressed genes in plants. *Journal of Genetics*, vol. 78, no. 1, p. 123-131. <https://doi.org/10.1007/bf02924562>
- Semagn, K., Bjornstad, A., Ndjiondjop, M. 2006. An overview of molecular marker methods for plants. *African Journal of Biotechnology*, vol. 5, no. 25, p. 2540-2568. https://doi.org/10.1007/7089_002
- Shang, H., Wei, Y., Wang, X., Zheng, Y. 2006. Genetic diversity and phylogenetic relationships in the rye genus *Secale* L. (rye) based on *Secale cereale* microsatellite markers. *Genetic Molecular Biology*, vol. 29, no. 4, p. 685-691. <https://doi.org/10.1590/s1415-47572006000400018>
- Schlegel, R., Meiz, G., Nestrowicz, R. 1987. A universal reference karyotype in rye, *Secale cereale* L. *Theoretical Applied Genetic*, vol. 74, no. 4, p. 820-826. <https://doi.org/10.1007/bf00247563>
- Sujatha, M., Tarakeswari, M., Francis, G. 2013. Start codon targeted (SCoT) polymorphism in toxic and non-toxic accessions of *Jatropha curcas* L. and development of a codominant SCAR marker. *Plant Science*, vol. 207, no. 1, p. 117-127. <https://doi.org/10.1016/j.plantsci.2013.02.013>
- Vences, F. J., Vaquero, F., Perez, de la Vega M. 1987. Phylogenetic relationship in *Secale* (*Poaceae*): an isozymatic study. *Plant Systematic Evolution*, vol. 157, no. 1, p. 33-47. <https://doi.org/10.1007/bf00939179>
- Vivodík, M., Gálová, Z., Balážová, Ž. Petrovičová, L. 2016. Start codon targeted (scot) polymorphism reveals genetic diversity in European old maize (*Zea mays* L.) Genotypes. *Potravinárstvo Slovak Journal of Food Sciences*, vol. 10, no. 1, p. 563-569. <https://doi.org/10.5219/660>
- Weber, J. L. 1990. Informativeness of human (dC-dA)_n x (dG-dT)_n polymorphism. *Genomics*, vol. 7, no. 4, p. 524-530. [https://doi.org/10.1016/0888-7543\(90\)90195-z](https://doi.org/10.1016/0888-7543(90)90195-z)
- Weir, B. S. 1990. *Genetic data analysis*. Sunderland, Massachusetts : Sinauer Associated, 1990, p. 445. ISBN 0878938710.
- Xiong, F. Q., Zhong, R. C., Han, Z. Q., Jiang, J., He, L. Q., Zhuang, W. J., Tang, R. H. 2011. Start codon targeted polymorphism for evaluation of functional genetic variation and relationships in cultivated peanut (*Arachis hypogaea* L.) genotypes. *Molecular Biology of Reproduction*, vol. 38, no. 1, p. 3487-3494. <https://doi.org/10.1007/s11033-010-0459-6>
- Xiong, F. Q., Tang, R. H., Chen, Z. L., Pan, L. H., Zhuang, W. J. 2009. SCoT: a novel gene targeted marker technique based on the translation start codon. *Molecular Plant Breeding*, vol. 7, no. 3, p. 635-638.

Acknowledgments:

This work was funded by European Community under project ITMS 26220220180: Building Research Centre “AgroBioTech” (50%) and KEGA project No 021SPU-4/2015 (50%).

Contact address:

Lenka Petrovičová, Slovak University of Agriculture, Faculty of Biotechnology and Food Sciences, Department of Biochemistry and Biotechnology, Tr. A. Hlinku 2, 949 76 Nitra, Slovakia, E-mail: lenka.petrovicova@uniag.sk
 Želmíra Balážová, Slovak University of Agriculture, Faculty of Biotechnology and Food Sciences, Department of Biochemistry and Biotechnology, Tr. A. Hlinku 2, 949 76 Nitra, Slovakia, E-mail: zelmira.balazova@uniag.sk
 Zdenka Gálová, Slovak University of Agriculture, Faculty of Biotechnology and Food Sciences, Department of Biochemistry and Biotechnology, Tr. A. Hlinku 2, 949 76, Nitra, Slovakia, E-mail: zdenka.galova@uniag.sk
 Martin Vivodík, Slovak University of Agriculture, Faculty of Biotechnology and Food Sciences, Department of Biochemistry and Biotechnology, Tr. A. Hlinku 2, 949 76 Nitra, Slovakia, E-mail: martin.vivodik@uniag.sk



STUDY OF RHEOLOGY AND FRICTION FACTOR OF NATURAL FOOD HYDROCOLLOID GELS

Vojtěch Kumbár, Šárka Nedomová, Roman Pytel, Libor Kilián, Jaroslav Buchar

ABSTRACT

Differences in the rheology and friction factor of natural food hydrocolloid gels were studied in this paper. The practical importance of the knowledge of the rheological parameters is quite evident. The experimental data were carried out using a concentric cylinder rotary viscometer. It was prepared 1% hydrocolloid solutions (hydrogels). Hydrogels of the natural gums extracted from the seeds of the plants and plant tubers have been used – carob gum (from the seeds of *Ceratonia siliqua*), guar gum (from the seeds of *Cyamopsis tetragonoloba*) and tara gum (from the seeds of *Caesalpinia spinosa*). Rheological behaviour has non-Newtonian pseudoplastic character and the flow curves were fitted using the Otswald – de Waele (power law) model and Herschel – Bulkley model. The hydrogels exhibit shear thinning behaviour. The meaning of the rheological parameters on the friction factors during flow of hydrocolloid gels in the tube has been shown. Information on time dependent behaviour of tested liquids has been also obtained. Time dependent curves were fitted by the Gaussian model. Preliminary results obtained for a constant shear rate showed the thixotropic and time-dependent behaviour of the hydrogels. These parameters can be especially used in much software dealing with a numerical simulation of the flow problems.

Keywords: viscosity; shear thinning; non-Newtonian fluid; velocity profile; Reynolds number

INTRODUCTION

The knowledge of the rheological properties of food products is essential for the product development, quality control, sensory evaluation and design and evaluation of the process equipment. The flow behaviour of a fluid can be varied from Newtonian to time dependent non-Newtonian in nature depending on its origin, composition and structure behaviour and previous history (Rao, 2005). The knowledge of this behaviour is also very important for natural hydrocolloids owing to an increasing demand on the processed hydrocolloids products. These products can be classified as the refrigerated liquid and especially as the dried products. Hydrogels are polymer networks formed from polymers that absorb water to a significant extent (Wientjes et al., 2000; Mandala et al., 2004; Abd Alla et al., 2012). Their porous structure and elastic properties make them useful for applications such as tissue engineering, drug delivery systems and functional coatings (Kono et al., 2014; Jamshidian et al., 2014). Hydrogels can be formed by proteins, peptides, or other biopolymers such as alginates, or chitosan (Sittikijyothin et al., 2007, Amundarain et al., 2009). In recent years, the hydrocolloids consumption in the form of food products has increased (Hayakawa et al., 2014; Tárrega et al., 2014). Several researchers (Alves et al., 1999; Sandolo et al., 2009; Karaman et al. 2014) studied the rheological

characteristics of natural hydrocolloids and reported Newtonian as well as time-dependent non-Newtonian flow behaviour of hydrogels (hydrocolloids solutions) (Sandolo et al., 2010).

A non-Newtonian fluid is a fluid with properties that are different in any way from those of Newtonian fluids. Most commonly, the viscosity (the measure of a fluid's ability to resist gradual deformation by shear or tensile stresses) of non-Newtonian fluids is dependent on shear rate or shear rate history. Some non-Newtonian fluids with shear-independent viscosity, however, still exhibit normal stress-differences or other non-Newtonian behaviour (Bourriot et al., 1999). In a Newtonian fluid, the relation between the shear stress and the shear rate is linear, passing through the origin, the constant of proportionality being the coefficient of viscosity. In a non-Newtonian fluid, the relation between the shear stress and the shear rate is different and can even be time-dependent (Time Dependent Viscosity). Therefore, a constant coefficient of viscosity cannot be defined (Kumbár et al., 2015a). There are underlying differences in flow behaviour which can cause problems in transport, processing, manufacturing, and/or storage.

Rheological properties are depended of concentration of hydrogels. With increasing concentration of hydrocolloid

the solution (gel) exhibits non-Newtonian behaviour (Zhu et al., 2012; Torres et al., 2013).

Considering this lack of published information on fluid dynamics of the natural hydrogels, the main purpose of this work was to determine rheological behaviour of these products for three hydrogels of the natural gums extracted from the plants and plant tubers. The carob gum is extracted from the seeds of *Ceratonia siliqua*, the guar gum is extracted from the seeds of *Cyamopsis tetragonoloba*, and the tara gum is extracted from the seeds of *Caesalpinia spinosa* (Wientjes et al., 2000; Sittikijyothin et al., 2007; Sandolo et al., 2010). In the Europe Union are these natural hydrocolloids labelled. The carob gum is labelled as E410, guar gum as E412 and the tara gum as E417.

The meaning of the reological data for the calculation of friction factors for the tube flow is discussed in details. Information on time dependent behaviour of the tested solutions has been obtained.

MATERIAL AND METHODOLOGY

Natural hydrocolloids carob gum, guar gum and tara gum were purchased from specialized manufacturer.

The carob gum (also know as locust bean gum) is a galactomannan vegetable gum extracted from the seeds of the carob tree, mostly found in the Mediterranean region. The long pods that grow on the tree are used to make this gum. The pods are kibbled to separate the seed from the pulp. The seeds have their skins removed by an acid treatment. The deskinned seed is then split and gently milled. This causes the brittle germ to break up while not affecting the more robust endosperm. The two are separated by sieving. The separated endosperm can then be milled by a roller operation to produce the final locust bean gum powder (Mandala et al., 2004).

The guar gum, also called guaran, is a galactomannan. It is primarily the ground endosperm of guar beans. The guar seeds are dehusked, milled and screened to obtain the guar

gum. It is typically produced as a free-flowing, off-white powder (Sandolo et al., 2009).

The tara gum is a white or beige, nearly odorless powder that is produced by separating and grinding the endosperm of *C. spinosa* seeds. Tara gum consists of a linear main chain of (1-4)-β-D-mannopyranose units attached by (1-6) linkages with α-D-galactopyranose units. The major component of the gum is a galactomannan polymer similar to the main components of guar and locust bean gums that are used widely in the food industry. The ratio of mannose to galactose in the tara gum is 3:1 (Sittikijyothin et al., 2007).

It was prepared 1% solutions from the dried gum and the distilled water. Exactly 500 mL of samples for each hydrogel were prepared and stored (couple of minutes) at 20 °C before measurement. From the physical parameters which have been measured only the densities of the tested liquids are presented in the Table 1.

The rheological measurements were carried out using the DV3-P viscometer (Anton Paar, Austria), equipped with a coaxial cylinder sensor system. Rotational speeds ranged between 0.3 rpm and 12 rpm, which is corresponds with shear strain rate from 0.102 s⁻¹ to 4.08 s⁻¹, because standard spindle TR 9 (1 rpm = 0.34 s⁻¹) was used. Viscosity η [Pa·s] is the ratio of shear stress σ [Pa] and shear strain rate γ̇ [s⁻¹] as is described in publication (Kumbár et al., 2015b):

$$\eta = \frac{\sigma}{\dot{\gamma}} \tag{1}$$

All measurements were performed at the constant temperature 20 °C.

RESULTS AND DISCUSSION

Shear stress and apparent viscosity

In the Figure 1 the flow curves, i.e. shear stress vs. shear strain rate, are shown. These curves can be fitted by using

Table 1 Density of hydrogels.

Product	Concentration	Density ρ (kgm ⁻³)
carob gum	1%	1005
guar gum	1%	1022
tara gum	1%	1041

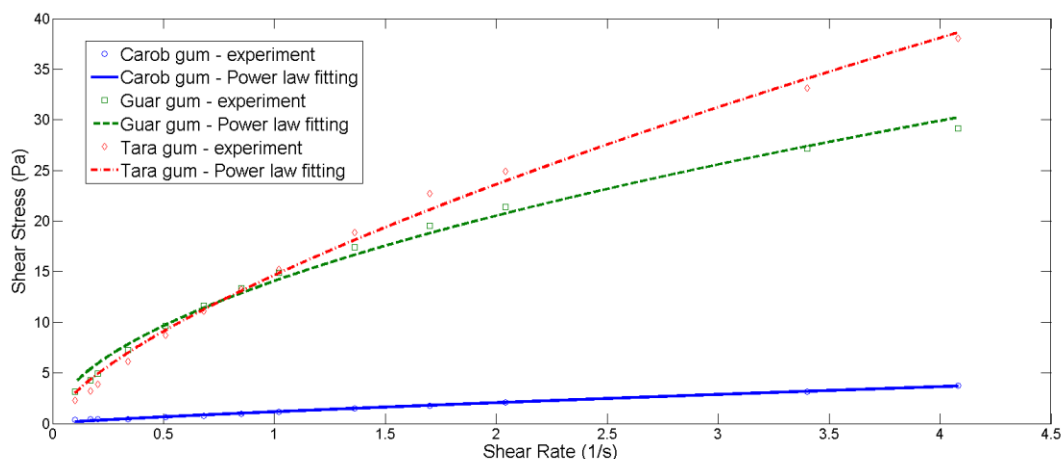

Figure 1 Effect of shear strain rate on the shear stress.

Table 2 Parameters of the Ostwald – De Waele model for hydrogels (R^2 is the coefficient of determination).

Hydrogel	K (Pas ⁿ)	n (-)	R^2
carob gum	1.158	0.8253	0.9934
guar gum	14.07	0.5441	0.9919
tara gum	14.65	0.6887	0.9943

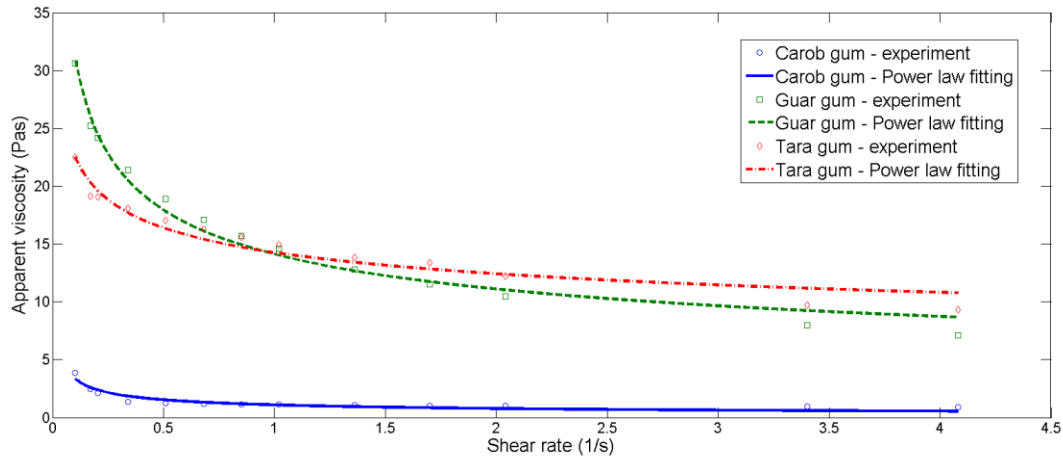

Figure 2 Apparent viscosity of the hydrogels.

of Herschel-Bulkley model (Saravacos and Kostaropoulos, 1995):

$$\sigma = \sigma_0 + K\dot{\gamma}^n. \quad (2)$$

In Eq. (2), K is the consistency index [Pa·sⁿ], n is the flow behaviour index [-] and σ_0 is the yield stress [Pa].

For all three hydrogels this model reduces to the Ostwald – De Waele model, given by Eq. (3), also known as the power-law model (Rao, 1982):

$$\sigma = K\dot{\gamma}^n. \quad (3)$$

Eqs. (2) and (3) can be used for both Newtonian and power law fluids, since for Newtonian fluids n equals 1, and K equals η and/or $(\eta + \sigma_0)$, respectively.

The Eq. (3) can be used for all three hydrogels. Parameters of Eq. (3) are given in the Table 2.

The apparent viscosity is than given by the Eq. (1). The apparent viscosity of tested liquids is shown in the Figure 2.

Time dependence of the apparent viscosity

In order to study of the time on the hydrogels these liquids were sheared at constant shear rates (3.4 s⁻¹) for about 4000 and 5000 s and changes of apparent viscosity with time was considered as time dependence.

Results of time–dependences of the apparent viscosity for the hydrogels are shown in the Figures 3 – 5.

It is obvious that be apparent viscosity decreases with the time. The experimental data were fitted by Gaussian model with different coefficient k .

$$\eta = \sum_{k=1}^{k=4} a_k \exp \left[- \left(\frac{t-b_k}{c_k} \right)^2 \right] \quad (\text{carob gum solution}), \quad (4)$$

$$\eta = \sum_{k=1}^{k=2} a_k \exp \left[- \left(\frac{t-b_k}{c_k} \right)^2 \right] \quad (\text{guar gum and tara gum solution}). \quad (5)$$

Parameters of the Eq. (4) for Carob gum solution are given in the Table 3. Parameters of the Eq. (5) for Guar and Tara gum solution are given in the Table 4.

Friction factor and flow velocity

The hydrogels exhibit shear thinning behaviour. There are occurred differences between solutions of different gums. The highest values of the apparent viscosity were achieved for the guar gum, following by the tara gum and the minimum values exhibited carob gum.

The obtained rheological parameters have great meaning in many problems of industry. For example the design of piping and pumping systems requires knowledge of the pressure drop due to flow in straight pipe segments and through valves and fittings. Friction losses caused by the presence of valves and fittings usually result from disturbances of the flow, which is forced to change direction abruptly to overcome path obstructions and to adapt itself to sudden or gradual changes in the cross section or shape of the duct. This problem is described e.g. in (Cabral et al., 2011). The pressure drop is calculated using of the friction factor, f . The friction factor is defined as (Garcia and Steffe, 1987):

$$f = \frac{2\sigma_w}{\rho v^2}, \quad (6)$$

where ρ is the fluid density, v is the average flow velocity, and σ_w is the stress in the wall, given by

$$\sigma_w = \frac{D\Delta P}{4L}. \quad (7)$$

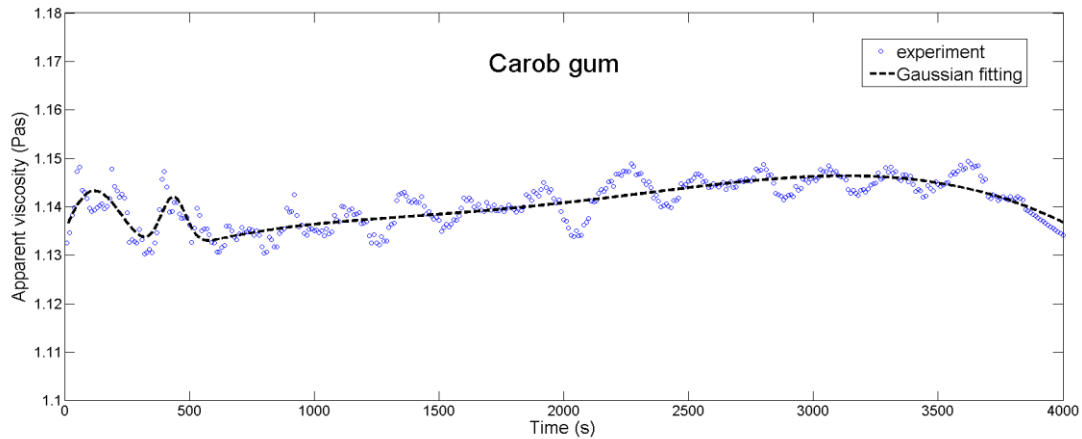

Figure 3 Time-dependence of the apparent viscosity (carob gum solution).

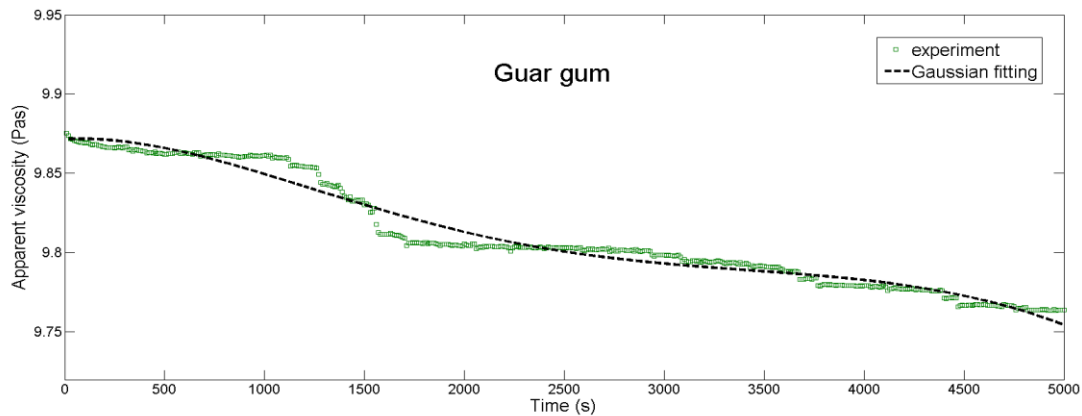

Figure 4 Time-dependence of the apparent viscosity (guar gum solution).

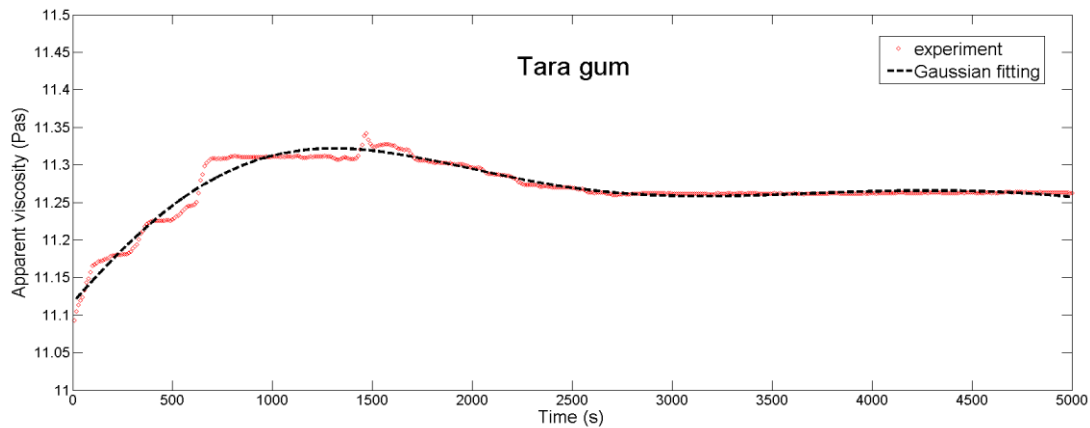

Figure 5 Time-dependence of the apparent viscosity (tara gum solution).

In Eq. (7) D is the tube diameter and ΔP is the pressure drop observed in a length L of the tube. For laminar flow, the friction factor can be obtained from a simple function of the generalized Reynolds number, which is identical to the dimensionless form of the Hagen-Poiseuille equation (Darby, 1996):

$$f = \frac{16}{Re}, \quad (8)$$

in which

$$Re = \frac{D^n v^{2-n} \rho}{8^{n-1} K} \left(\frac{4n}{1+3n} \right)^n. \quad (9)$$

Eqs. (8) and (9) can be used for both Newtonian and power law fluids, since for Newtonian fluids n equals 1, and K equals η , so that the generalized Reynolds number (Eq. (7)) reduces to well-known number:

$$Re = \frac{Dv\rho}{\eta}. \quad (10)$$

The values of generalized Reynolds number for hydrogels tested in this paper are given in the Table 5. These numbers have been calculated for values of $D = 0.1$ m and $v = 1$ m.s⁻¹.

Under turbulent flow conditions, the existing correlations to estimate the friction factor are semi-empirical. For

Table 3 Parameters of fitting for Eq. (4) (*SSE* is sum squared error, *RMSE* is root-mean-square error and R^2 is the coefficient of determination).

carob gum	a_1 (Pas)	b_1 (s ⁻¹)	c_1 (s ⁻¹)	a_2 (Pas)	b_2 (s ⁻¹)
	10.47	4430	1.553E4	0.02026	96
	c_2 (s ⁻¹)	a_3 (Pas)	b_3 (s ⁻¹)	c_3 (s ⁻¹)	a_4 (Pas)
	180.4	0.01093	431.4	69.48	1.462
	b_4 (s ⁻¹)	c_4 (s ⁻¹)	<i>SSE</i>	<i>RMSE</i>	R^2
	-2863	3949	0.00283	0.002702	0.6809

power law fluids, probably the best-known correlation is that presented by (Dodge and Metzner, 1959):

$$\frac{1}{\sqrt{f}} = \frac{4}{n^{0.75}} \ln \left(Re f^{1-\frac{n}{2}} \right) - \frac{0.4}{n^{1.2}} \quad (11)$$

Let us consider a cylindrical tube of diameter $D = 0.1$ m and an average flow velocity $v = 1$ m.s⁻¹. The values of generalized Reynolds numbers (Eq. 9) are given in the Table 5.

The Reynolds number describes namely the transitive from laminar to turbulent flow. The behaviour of hydrogels is different. The maximum value exhibits the carob gum solution. Laminar flow of a power law fluid exists in the tube (Kumbár et al., 2015c) when:

$$Re \leq (Re)_{critical} \quad (12)$$

The critical value of the power law Reynolds number depends on the value of the flow index behaviour n

Table 4 Parameters of fitting for Eq. (5) (*SSE* is sum squared error, *RMSE* is root-mean-square error and R^2 is the coefficient of determination).

guar gum	a_1 (Pas)	b_1 (s ⁻¹)	c_1 (s ⁻¹)	a_2 (Pas)	b_2 (s ⁻¹)
	2.139	-3.661	2.948	9.68	1.853
	c_2	<i>SSE</i>	<i>RMSE</i>	R^2	
	9.844	0.0196	0.00629	0.9667	
tara gum	a_1 (Pas)	b_1 (s ⁻¹)	c_1 (s ⁻¹)	a_2 (Pas)	b_2 (s ⁻¹)
	0.2941	691.9	1579	11.26	4403
	c_2 (s ⁻¹)	<i>SSE</i>	<i>RMSE</i>	R^2	
	2.34E4	0.0289	0.00765	0.9587	

Table 5 Reynolds numbers given by the Eq. (9).

Hydrogel	<i>Re</i>
carob gum	179
guar gum	48
tara gum	26

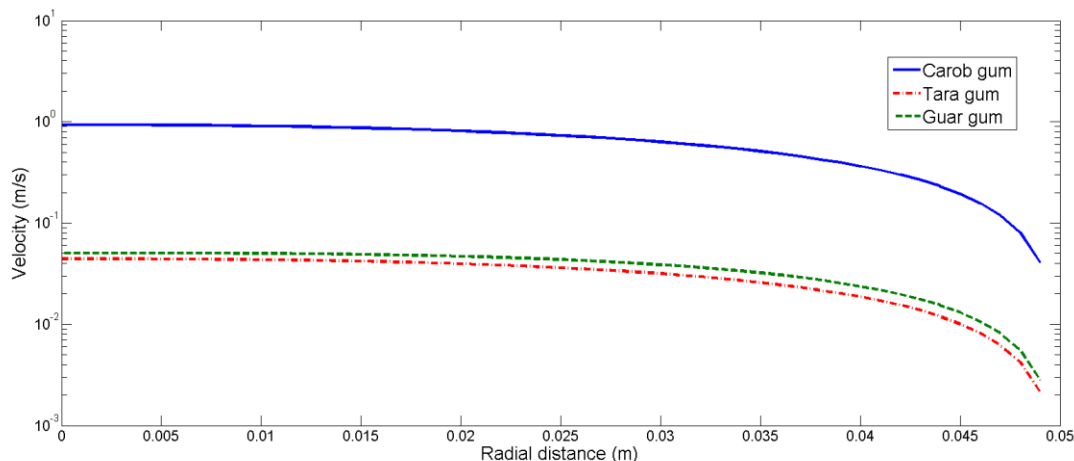

Figure 6 Velocity profiles of hydrogels flow.

$$v(x) = \left(\frac{\Delta P}{2KL}\right)^{\frac{1}{n}} \left(\frac{n}{n+1}\right) \left(R^{\frac{n+1}{n}} - x^{\frac{n+1}{n}}\right), \quad (14)$$

where ΔP denotes the driving over pressure, L is the tube length and R is its radius. For the illustration the values of $R = 0.05$ m, $L = 1$ m and $\Delta P = 1000$ Pa were chosen. Results are displayed in the Figure 6.

The highest values of flow velocities are observed for the flow of carob gum solution. The lowest one was achieved for the flow of the tara gum solution. Velocities are different for different hydrogels but velocity of the tara gum and guar gum solutions are very close.

The velocity equation given above is valid for fully developed undisturbed flow in straight, horizontal tubes. Reals processing systems contain many elements like valves, tees, elbows, etc. that cause fluid mixing during flow (Das et al., 1991; Telis-Romero et al., 2005).

In addition pipe vibration caused by energy inputs from pumps may contribute to mixing. It means that the equation given above represents only general guidelines in examining velocity profiles during tube flow.

CONCLUSION

Rheological properties of natural hydrocolloids solutions (carob gum – from the seeds of *Ceratonia siliqua*, guar gum – from the seeds of *Cyamopsis tetragonoloba* and the tara gum – from the seeds of *Caesalpinia spinosa*) were studied using rotary viscometer with coaxial cylinder sensor system. Prepared were 1% solutions of hydrocolloids (hydrogels). Experimental data were successfully fitted with the Ostwald-De Waele model and Herschel-Bulkeley model. The hydrogels exhibit shear thinning behaviour.

The highest values of the apparent viscosity were achieved for the guar gum solution, following by the tara gum solution and the minimum values exhibited carob gum solution.

The differences between the guar gum and tara gum solutions are not too significant. In order to study of the time on the hydrogels these liquids were sheared at constant shear strain rates for about 4000 and 5000 s and changes of apparent viscosity with the time was considered as time dependence. Preliminary results obtained for a constant shear strain rate showed the thixotropic and time-dependent behaviour of the hydrogels. The behaviour of the hydrogels was complicated – Gaussian model it was used. The practical importance of the knowledge of the rheological parameters was outlined. These parameters can be used in much software dealing with a numerical simulation of the flow problems.

REFERENCES

Abd Alla, S. G., Sen, M., El-Naggar, A. W. M. 2012. Swelling and mechanical properties of superabsorbent hydrogels based on tara gum/acrylic acid synthesized by gamma radiation. *Carbohydrate Polymers*, vol. 89, no. 2, p. 478-485. <https://doi.org/10.1016/j.carbpol.2012.03.031>

Alves, M. M., Antonov, Y. A., Gonçalves, M. P. 1999. The effect of phase viscosity ratio on the rheology of liquid two phase gelatin-locust bean gum systems. *International Journal of Biological Macromolecules*, vol. 26, no. 5, p. 333-336. [http://dx.doi.org/10.1016/S0141-8130\(99\)00103-8](http://dx.doi.org/10.1016/S0141-8130(99)00103-8)

Amundarain, J. L., Castro, L. J., Rojas, M. R., Siquier, S., Ramirez, N., Müller, A. J., Sáez, A. E. 2009. Solutions of xanthan gum/guar gum mixtures: Shear rheology, porous media flow, and solids transport in annular flow. *Rheologica Acta*, vol. 48, no. 5, p. 491-498. <http://dx.doi.org/10.1007/s00397-008-0337-5>

Bourriot, S., Garnier, C., Doublier, J. 1999. Phase separation, rheology and microstructure of micellar casein-guar gum mixtures. *Food Hydrocolloids*, vol. 13, no. 1, p. 43-49. [http://dx.doi.org/10.1016/S0268-005X\(98\)00068-X](http://dx.doi.org/10.1016/S0268-005X(98)00068-X)

Cabral, R. A. F., Telis V. R. N., Parkb K. J., Telis-Romero, J. 2011. Friction losses in valves and fittings for liquid food products. *Food and bioproducts processing*, vol. 89, no. 4, p. 375-382. <http://dx.doi.org/10.1016/j.fbp.2010.08.002>

Darby, R. 1996. *Chemical engineering fluid mechanics*. 2nd ed. NEW YORK, USA : Marcel Dekker. 576 p. ISBN: 0-8247-0444-4.

Das, S. K., Biswas, M. N., Mitra, A. K. 1991. Non-Newtonian liquid flow in bends. *Chemical Engineering Journal*, vol. 45, no. 3, p. 165-171. [http://dx.doi.org/10.1016/0300-9467\(91\)80016-P](http://dx.doi.org/10.1016/0300-9467(91)80016-P)

Dodge, D. W., Metzner, A. B. 1959. Turbulent flow of non-Newtonian systems. *AIChE Journal*, vol. 5, p. 189-204. <http://dx.doi.org/10.1002/aic.690050214>

Garcia, E. J., Steffe, J. F. 1987. Comparison of friction factor equations for non-Newtonian fluids in pipe flow. *Journal of Food Process and Engineering*, vol. 9, no. 2, p. 93-120. <http://dx.doi.org/10.1111/j.1745-4530.1986.tb00120.x>

Hayakawa, F., Kazami, Y., Ishihara, S., Nakao, S., Nakauma, M., Funami, T., Nishinari, K., Kohyama, K. 2014. Characterization of eating difficulty by sensory evaluation of hydrocolloid gels. *Food Hydrocolloids*, vol. 38, p. 95-103. <http://dx.doi.org/10.1016/j.foodhyd.2013.11.007>

Jamshidian, M., Savary, G., Grisel, M., Picard, C. 2014. Stretching properties of xanthan and hydroxypropyl guar in aqueous solutions and in cosmetic emulsions. *Carbohydrate Polymers*, vol. 112, p. 334-341. <http://dx.doi.org/10.1016/j.carbpol.2014.05.094>

Karaman, S., Kesler, Y., Goksel, M., Dogan, M., Kayacier, A. 2014. Rheological and some physicochemical properties of selected hydrocolloids and their interactions with guar gum: Characterization using principal component analysis and viscous synergism index. *International Journal of Food Properties*, vol. 17, no. 8, p. 1655-1667. <http://dx.doi.org/10.1080/10942912.2012.675612>

Kono, H., Otaka, F., Ozaki, M. 2014. Preparation and characterization of guar gum hydrogels as carrier materials for controlled protein drug delivery. *Carbohydrate Polymers*, vol. 111, p. 830-840. <http://dx.doi.org/10.1016/j.carbpol.2014.05.050>

Kumbár, V., Nedomová, Š., Strnková, J., Buchar, J. 2015a. Effect of egg storage duration on the rheology of liquid egg products. *Journal of Food Engineering*, vol. 156, p. 45-54. <http://dx.doi.org/10.1016/j.jfoodeng.2015.02.011>

Kumbár, V., Polcar A., Votava, J. 2015b. Physical and Mechanical Properties of Bioethanol and Gasoline Blends. *Sugar and Sugar Beet Journal*, vol. 131, no. 3, p. 112-116.

Kumbár, V., Strnková, J., Nedomová, Š., Buchar, J. 2015c. Fluid dynamics of liquid egg products. *Journal of Biological Physics*, vol. 41, no. 1, p. 303-311. <http://dx.doi.org/10.1007/s10867-015-9380-5>

Mandala, I. G., Savvas, T. P., Kostaropoulos, A. E. 2004. Xanthan and locust bean gum influence on the rheology and structure of a white model-sauce. *Journal of Food Engineering*, vol. 64, no. 3, p. 335-342. <http://dx.doi.org/10.1016/j.jfoodeng.2003.10.018>

- Rao, M. A. 1982. *Flow properties of fluid foods and their measurement*, Paper presented at the AIChE Symposium Series, p. 144-153.
- Rao, M. A. 2005. Rheological properties of fluid foods. In Rao, M. A., Rizvi, S. S. H., Datta A. K. *Engineering properties of foods*. New York : Marcel Dekker, p. 41-100. ISBN [0-8247-5328-3](https://doi.org/10.1201/9781420028805.ch2). <https://doi.org/10.1201/9781420028805.ch2>
- Sandolo, C., Bulone, D., Mangione, M. R., Margheritelli, S., Di Meo, C., Alhaique, F., Matricardi, P., Coviello, T. 2010. Synergistic interaction of locust bean gum and xanthan investigated by rheology and light scattering. *Carbohydrate Polymers*, vol. 82, no. 3, p. 733-741. <http://dx.doi.org/10.1016/j.carbpol.2010.05.044>
- Sandolo, C., Matricardi, P., Alhaique, F., Coviello, T. 2009. Effect of temperature and cross-linking density on rheology of chemical cross-linked guar gum at the gel point. *Food Hydrocolloids*, vol. 23, no. 1, p. 210-220. <http://dx.doi.org/10.1016/j.foodhyd.2008.01.001>
- Saravacos, G. D., Kostaropoulos A. E. 1995. Transport properties in processing of fruits and vegetables. *Food Technology*, vol. 49, p. 1-6.
- Sittikijyothin, W., Sampaio, P., Gonçalves, M. P. 2007. Heat-induced gelation of β -lactoglobulin at varying pH: Effect of tara gum on the rheological and structural properties of the gels. *Food Hydrocolloids*, vol. 21, no. 7, p. 1046-1055. <http://dx.doi.org/10.1016/j.foodhyd.2006.07.019>
- Steffe, J. F., Daubert C. R. 2006. *Bioprocessing Pipelines: Rheology and Analysis*. MICHIGAN, USA : Freeman Press, 159 p. ISBN-10:0-9632036-2-2.
- Tárrega, A., Martínez, M., Vélez-Ruiz, J. F., Fiszman, S. 2014. Hydrocolloids as a tool for modulating the expected satiety of milk-based snacks. *Food Hydrocolloids*, vol. 39, p. 51-57. <http://dx.doi.org/10.1016/j.foodhyd.2013.12.025>
- Telis-Romero, J., Polizzelli, M. A., Gabas, A. L., Telis, V. R. N. 2005. Friction losses in valves and fittings for viscoplastic fluids. *Canadian Journal of Chemical Engineering*, vol. 83, no. 2, p. 181-187. <http://dx.doi.org/10.1002/cjce.5450830205>
- Torres, M. D., Gadala-Maria, F., Wilson, D. I. 2013. Comparison of the rheology of bubbly liquids prepared by whisking air into a viscous liquid (honey) and a shear-thinning liquid (guar gum solutions). *Journal of Food Engineering*, vol. 118, no. 2, p. 213-228. <https://doi.org/10.1002/cjce.5450830205>
- Torres, M. D., Hallmark, B., Wilson, D. I. 2014. Effect of concentration on shear and extensional rheology of guar gum solutions. *Food Hydrocolloids*, vol. 40, p. 85-95. <http://dx.doi.org/10.1016/j.foodhyd.2014.02.011>
- Wang, Q., Zhang, Z., Qian, J., Xie, Y., Yang, H. 2013. Rheology of anionic carboxymethyl guar solution in the presence of the opposite charged surfactant. *Gaofenzi Cailiao Kexue Yu Gongcheng/Polymeric Materials Science and Engineering*, vol. 29, no. 1, p. 71-74.
- Wientjes, R. H. W., Duits, M. H. G., Jongschaap, R. J. J., Mellema, J. 2000. Linear rheology of guar gum solutions. *Macromolecules*, vol. 33, no. 26, p. 9594-9605. <http://dx.doi.org/10.1021/ma001065p>
- Zhu, G., Fang, B. 2012. The preparation and rheological properties of regeneratable borax/degraded hydroxypropyl tara gum gel systems. *Gao Xiao Hua Xue Gong Cheng Xue Bao/Journal of Chemical Engineering of Chinese Universities*, vol. 26, no. 5, p. 901-904.

Acknowledgments:

This work was supported by TP 2/2017 "Effect of additives on the rheological behaviour of foodstuffs and product and raw materials for their production" financed by IGA AF MENDELU.

Contact address:

Vojtěch Kumbár, Mendel University in Brno, Faculty of AgriSciences, Department of Technology and Automobile Transport (section Physics), Zemedelska 1, 613 00 Brno, Czech Republic, E-mail: vojtech.kumbar@mendelu.cz

Šárka Nedomová, Mendel University in Brno, Faculty of AgriSciences, Department of Food Technology, Zemedelska 1, 613 00 Brno, Czech Republic, E-mail: snedomov@mendelu.cz

Roman Pytel, Mendel University in Brno, Faculty of AgriSciences, Department of Food Technology, Zemedelska 1, 613 00 Brno, Czech Republic, E-mail: roman.pytel@mendelu.cz

Libor Kilián, Mendel University in Brno, Faculty of AgriSciences, Department of Food Technology, Zemedelska 1, 613 00 Brno, Czech Republic, E-mail: libor.kilian@mendelu.cz

Jaroslav Buchar, Mendel University in Brno, Faculty of AgriSciences, Department of Technology and Automobile Transport (section Physics), Zemedelska 1, 613 00 Brno, Czech Republic, E-mail: buchar@node.mendelu.cz

THE IMPACT OF VARIETIES, RIPENESS, AND HEAT TREATMENT ON THE RETENTION OF VITAMIN C AND CONTENT OF SOLUBLE SOLIDS IN SWEET PEPPER

Magdaléna Valšíková, Marián Rehuš, Patrik Komár, Oleg Paulen

ABSTRACT

In the three-year field trial we have grown six varieties of sweet peppers and we observed a change in the content of soluble solids and vitamin C during aging and after heat treatment with the sterilization. The highest content of soluble solids was found in peppers collected in botanical maturity, where the average was 5.82% in 2012, 6.52 in 2013 and 6.13 in 2014. Lower average, we measured in the intermediate maturity, 4.25 in 2012, 5.2% in 2013 and 4.73% in 2014. The lowest soluble solids content was recorded for fruit harvested in technical ripeness, only 3.57% in 2012, 4.25% in 2013 and 4.10% in 2014. In the technical maturity we determined the average value of vitamin C by the years between 90.98 mg.100 g⁻¹ and 103.86 mg.100 g⁻¹. The average in vitamin C content in fresh pepper fruits of intermediate maturity was ranging from 108.81 to 124.65 mg.100 g⁻¹. The highest average values of vitamin C were at the botanical maturity from 171.42 to 188.30 mg.100 g⁻¹. In the average of years and times of harvest it was found that the variety 'PCR' and 'Slovakia' had the first and second place in content of vitamin C (146.10 mg.100 g⁻¹ – 'PCR' and 143.72 mg.100⁻¹ – 'Slovakia'). The least vitamin C was observed in a variety 'Katrena' (120.80 mg.100 g⁻¹). For six varieties we have found that in technical maturity retained after sterilization on average 34.0% of vitamin C, in an intermediate maturity 47.16% and 42.10% of botanical maturity. Vitamin C was the highest in sterilized pepper variety of 'Slovakia' and 'PCR' in all three stage of maturity. The results show that the pepper is an excellent reservoir of vitamin C, not only in c fresh state, but also after heat treatment.

Keywords: sweet pepper; vitamin C; retention; soluble solids

INTRODUCTION

Paprika belongs to a large group of vegetables and crop plants that are for centuries purposefully selected, cultivated by man for its benefit (Andrejiová and Kóňa 2010). In human nutrition vegetables are important sources of vitamins and minerals. Also contains bioactive substances, such as carotenoids, bioflavonoids and phenolic acids, which have beneficial effects on our health. Also suppress harmful bacteria protect against infections, they may prevent cardiovascular diseases and strengthens the immune system (Jedlička 2012; Juriková and Balla 2012).

Paprika is one of the most valuable vegetables in terms of the high vitamin C content. Considerable amounts are found in Capsicum peppers at any stage of ripening, particularly when fully ripe (Bosland and Votava 2000; Rodriguez-Burruezo and Nuez 2006). Vitamin C is involved in the antioxidant capacity of peppers (Hegedúsová et al. 2016). Similar context observed authors Mlček et al. (2015) on the onions.

Kopec (1998) indicates that the average vitamin C content of red pepper is 161.5 mg.100 g⁻¹ and of the green fruit of pepper is 120.0 mg.100 g⁻¹. Tilahun et al. (2013) found in seven varieties of peppers fresh range from 55.3 to 189.4 mg.100 g⁻¹.

The vitamin C content of fresh edible vegetable parts is variable depending on many factors, e.g. species, variety, maturity, weather conditions, production conditions, the method of post-harvest treatment, duration of storage, storage temperature, a heat treatment process and others (Škrovánková et al. 2015).

In the results the authors Guiamba et al. (2016) was preserved in the dried fruit Mango 37.2 to 76.4% of vitamin C when was dried at 50 °C. At a drying temperature of 70 °C, the retention of vitamin C ranged from 51.3 to 60.1%.

A similar experiment was made with their foliage of parsley and celery. Vitamin C was analyzed in fresh, dried and frozen state (Valšíková et al. 2016).

Durability of vegetables may be extended by canning. Pepper is also an important raw material for the processing industry. Sterilization is the most widely used method of preserving peppers.

The goal was to identify differences in the content of vitamin C in fruits of six fresh pepper varieties of different maturity and compared with fruits in a sterilized condition. The stored amount of vitamin C is expressed in % of retention.

MATERIAL AND METHODOLOGY

Field experiment was established in the premises of the complex in the Botanical Garden of Agriculture in Nitra in 2012, 2013 and 2014. In the trials were included six varieties of sweet peppers named: 'Amy', 'Slovakia', 'PCR', 'Semaroh', 'Katrena' and 'Alma'. Determination of refractive solids and vitamin C was carried out at the Department of vegetable production at Slovak University of Agriculture in Nitra.

Sweet pepper seedlings were grown from sowing, which was held on 24.2.2012, 25.2.2013 and 27.2.2014. Seedlings were planted 5.24.2012, 5.21.2013 and 22.5.2014 in pre-aligned land plot. We planted to spacing of 0.6 x 0.3 m in three repeats (Valšíková 2014). The doses of fertilizers were based on agrochemical soil analysis and according to the normative for pepper (Uher et al. 2009).

Basic information about the field trial:

- Total area of the plots: 32.4 m²
- Number of varieties: 6
- Spacing: 0.3 x 0.6 m
- Repetitions: 3
- Number of plants in the repetition: 10
- Total number of all plants: 180

During vegetation we collected fruits in three terms - stages of maturity:

1. Technical maturity (green)
2. Transitional maturity (between technical and botanical)
3. Botanical maturity (red)

Growing conditions were identical for all varieties. The pepper fruits were collected for analyzes and sterilization in terms which are in Table 1. At each maturity stage were measured by varieties the refractometric solids and analyzed to determine the content of vitamin C. Part of the collection was preserved by sterilization in the form of pepper slices in glass jars in a volume of 0.7 liters.

Composition of the brine for preservation: water – 68,8%, 8% strength vinegar – 23.6%, table salt – 1.9%, sugar – 5.7%. Sterilization lasted 15 minutes at 80 °C. The canning variants were analyzed for vitamin C after 3 months of storage. The vitamin C content was determined by HPLC method and the soluble solids content was measured by a digital refractometer of mark KRÜSS DR201 – 95 in the laboratory of Slovak University of Agriculture in Nitra.

For statistical evaluation were used standard methods using statistical software Statgraphics Centurion XVII (StatPoint Inc. USA) - Multi-factor analysis of variance (MANOVA), LSD test.

RESULTS AND DISCUSSION

Soluble solids

Average soluble solids content in% of fresh paprika fruit reached in all stages of maturity the highest value of a variety 'Semaroh' and the lowest at variety 'Katrena'. With respect to evaluation years, the highest refractive solids were achieved in 2013 and the lowest in 2012 in all maturity. Green fruits contain the least soluble solids and

Table 1 Table 1 Harvest date in the experimental years.

Year 2012	Year 2013	Year 2014
30.07.2012	31.07.2013	28.07.2014
13.08.2012	19.08.2013	14.08.2014
06.09.2012	10.09.2013	11.09.2014

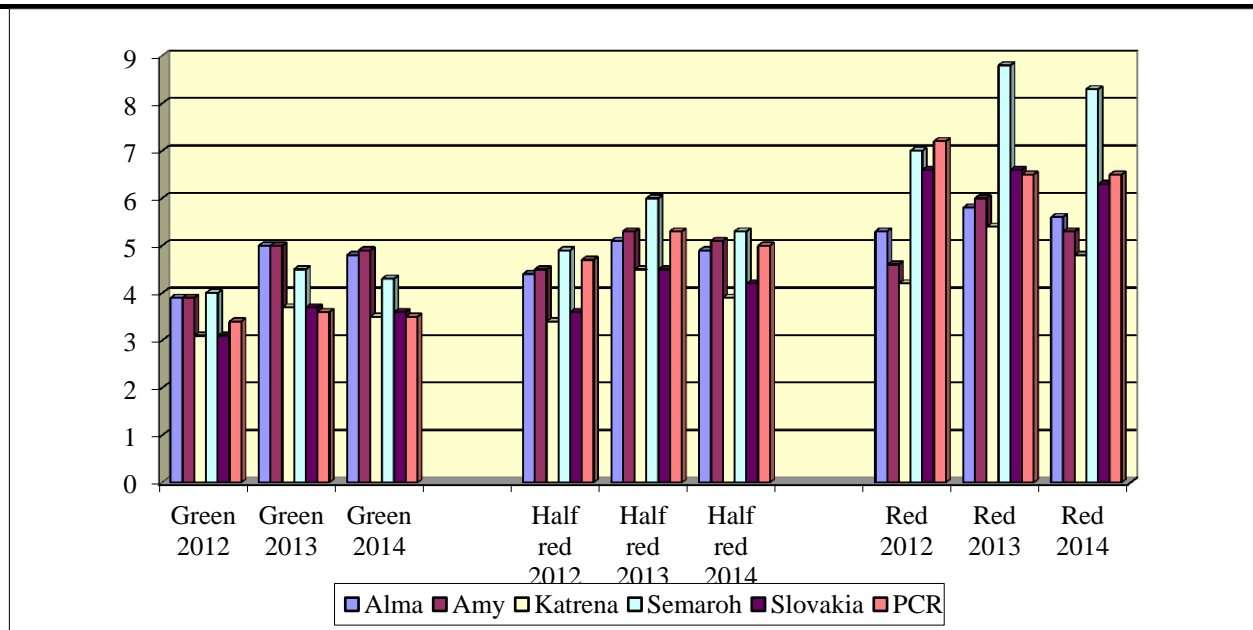

Figure 1 Soluble solids content in fresh peppers by varieties, years and maturity (%).

the most the red fruits in the botanical maturity.

Soluble solids content of all pepper varieties in the experiment tended to increase during the course of vegetation. In the technical maturity has been achieved average of six studied varieties and average of three years 3.97% of soluble solids. In the transitional maturity it was 4.83% and 6.16% in the botanical maturity (Figure 1).

The results show that the soluble solids content in the pepper fruits depend on maturity. Clearly the peppers reached the highest soluble solids content when harvested in botanical maturity. Soluble solids content in the pepper cultivars is consistent with the results of authors **Tomašová and Valšíková (2012)**, they measured the average value in the range from 1.72 to 6.43%. In soluble solids content in fresh peppers by variants, varieties and years was found significant differences by LSD test, 95%.

Vitamin C in fresh pepper fruits

The average level of vitamin C in fresh pepper fruits at different maturity, varieties and years is documented in the Figure 2. In Table 2 is evaluated significance of differences in the content of vitamin C in fresh fruit,

depending on the variants, varieties and years.

In the average of years and times of harvest it was found that the variety 'PCR' and 'Slovakia' had the first and second place in content of vitamin C (146.10 mg.100 g⁻¹ – 'PCR' and 143.72 mg.100⁻¹ – 'Slovakia'). The least vitamin C was observed in a variety 'Katrena' (120.80 mg.100 g⁻¹).

In the monitored experiment was found the lowest vitamin C content of fresh peppers in variety of 'Semaroh' in technical maturity (75.88 mg.100 g⁻¹), closely followed by variety 'Katrena' where we found 83.13 mg.100 g⁻¹. The results show that vitamin C in fresh pepper fruits grow during the whole vegetation period. The highest value reached in botanical ripeness.

In technical maturity we determined the average value of vitamin C by the years between 90.98 mg.100 g⁻¹ and 103.86 mg.100 g⁻¹. The average of vitamin C content in intermediate maturity was ranging from 108.81 to 124.65 mg.100 g⁻¹. The highest average was at the botanical maturity (171.42 to 188.30 mg.100 g⁻¹).

The author **Michalik (2010)** was found the three-year average range in the dry matter content in four sweet

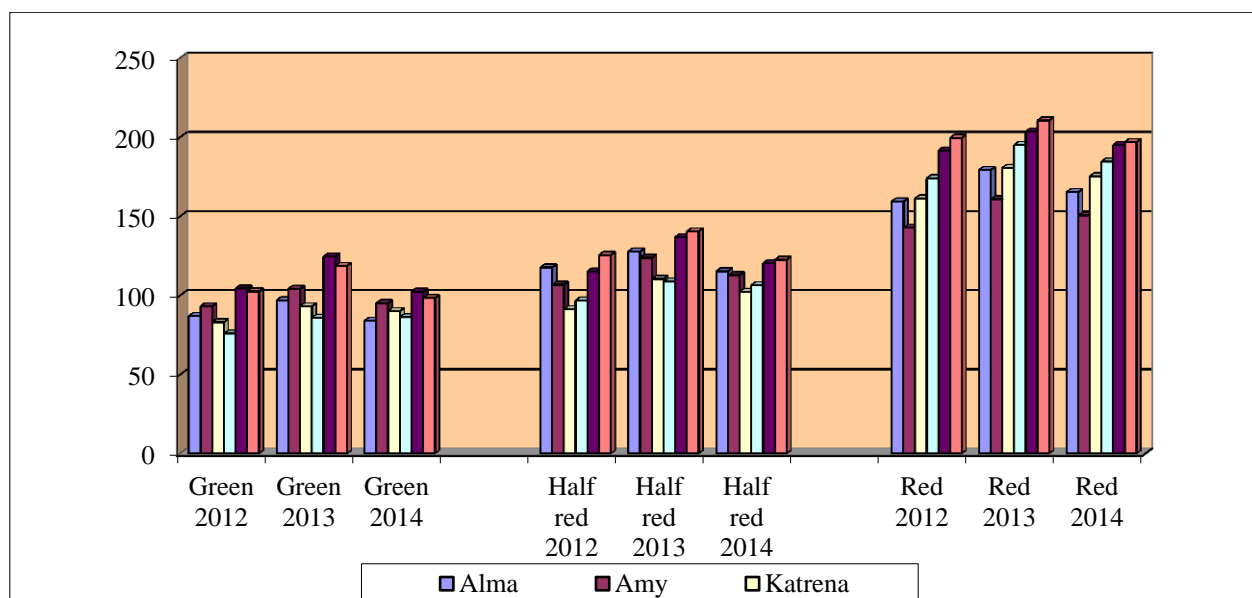

Figure 2 Vitamin C content in fresh pepper fruits by varieties, years and the maturity level.

Table 2 Differences in vitamin C of fresh peppers (Method: 95.0 percent LSD).

Variants	Count	LS Mean	LS Sigma	Homogen. groups
GM	54	95.8469	1.43644	a
TM	54	115.578	1.43644	b
BM	54	179.222	1.43644	c
Varieties	Count	LS Mean	LS Sigma	Homogen. groups
Katrena	27	120.804	2.03143	a
Amy	27	121.094	2.03143	a
Semaroh	27	123.749	2.03143	a
Alma	27	125.82	2.03143	a
Slovakia	27	143.721	2.03143	b
PCR	27	146.105	2.03143	b
Years	Count	LS Mean	LS Sigma	Homogen. groups
2012	54	123.739	1.43644	a
2014	54	127.967	1.43644	b
2013	54	138.94	1.43644	c

Note: GM = technical maturity, TM = Transitional maturity. BM = botanical maturity.

pepper varieties between 5.24 to 7.48%. The average content of ascorbic acid in these pepper fruits ranged from 110.46 to 148.72 mg.100g⁻¹.

Petříková, Hlušek et al. (2012) reported an average level of vitamin C in green pepper 80.4 mg.100 g⁻¹ and 127.7 mg.100 g⁻¹ of red fresh peppers. Our average values ranged from 75.88 mg.100 g⁻¹ in technical ripening of variety 'Semaroh' up to 203.44 mg.100 g⁻¹ in variety 'Slovakia' of botanical ripeness. Kopec (1998) shows the average value of vitamin C in red peppers 161.5 mg.100 g⁻¹ and 120 mg.100 g⁻¹ in green peppers.

Vitamin C in sterilized pepper fruits

At the time of harvest at different times and maturity we conserved pepper slices. Three 3 months after sterilization pepper slices were analyzed for vitamin C. In 2012, the average vitamin C content of all varieties conserved in the technical maturity was 30.55 mg.100 mg⁻¹. In intermediate maturity it was 53.67 mg.100 g⁻¹ and in botanical ripeness 69.06 mg.100 g⁻¹. In 2013, these values were the highest, 33.94 mg.100 g⁻¹, 57.62 mg.100 g⁻¹ and 76.23 mg.100 g⁻¹. In 2014, the average measured amount of vitamin C in sterilized pepper slices (32.59, 62.23 and 81.06 mg.100 g⁻¹) was larger than in 2012 but lower than in 2013.

The highest content of Vitamin C was in sterilized variety 'Slovakia' and 'PCR' in all three stages of maturity. The highest measured value of vitamin C in the sterilized samples linked to the maximum level in the fresh state and vice versa. The table 3 shows the percentages of retention (preservation) of vitamin C.

The lowest percentage of vitamin C retention in

sterilized pepper slices were recorded by technical ripening in variety 'Alma'. In intermediate ripening it was variety 'Katrena' and in botanical ripening variety 'Amy'. In the green maturity, the average retention value of vitamin C in all varieties was 34%. In the intermediate maturity, the average retention was 47.16% and 42.10% in slices of red ripeness. Comparison of vitamin C in fresh fruits and sterilized in different varieties, variants and years is shown in Figure 3.

According to the results of authors Bernhardt and Schlich (2006), the cooking pepper retains about 76% of vitamin C and cooking with steam can be kept to 94% of vitamin C of the initial volume of fresh weight. A similar conclusion was reached by the authors Valšíková and Chrenko (1983), who point out the relationship between the original content of ascorbic acid and its retention after sterilization. They found an average level of vitamin C in fresh fruit of nine pepper varieties of 115.1 mg.100 g⁻¹. Vitamin C decreased after sterilization to 76.4 mg.100 g⁻¹. Retention in nine varieties was in the range 49 – 85%.

Valšíková and Paulen (2013) point out that after sterilization and storage of pepper slices retained on average 48.6% ascorbic acid content of the original. This finding corresponds with our results where we have reached average retention of vitamin C from 34% to 47.16%. Valšíková, Minárová and Paukova (1984) found that on average, the eleven varieties of peppers was retained 49.24% of vitamin C after sterilization and 53.96% after freezing of pepper fruits.

Castro et al. (2008) studied the effect of pressure treatments of 100 and 200 MPa (10 and 20 min.) and of

Table 3 Three-year averages retention of vitamin C in sterilized pepper fruits.

Varieties	Technical maturity (green)	Transitional maturity (half red)	Botanical maturity (red)
	Retention (%)	Retention (%)	Retention (%)
Alma	30.03	48.82	41.70
Amy	33.38	45.97	43.42
Katrena	32.80	44.21	43.87
Semaroh	37.33	46.12	41.53
Slovakia	35.44	50.69	40.80
PCR	34.77	46.47	41.75
Average of varieties	34.00	47.16	42.10

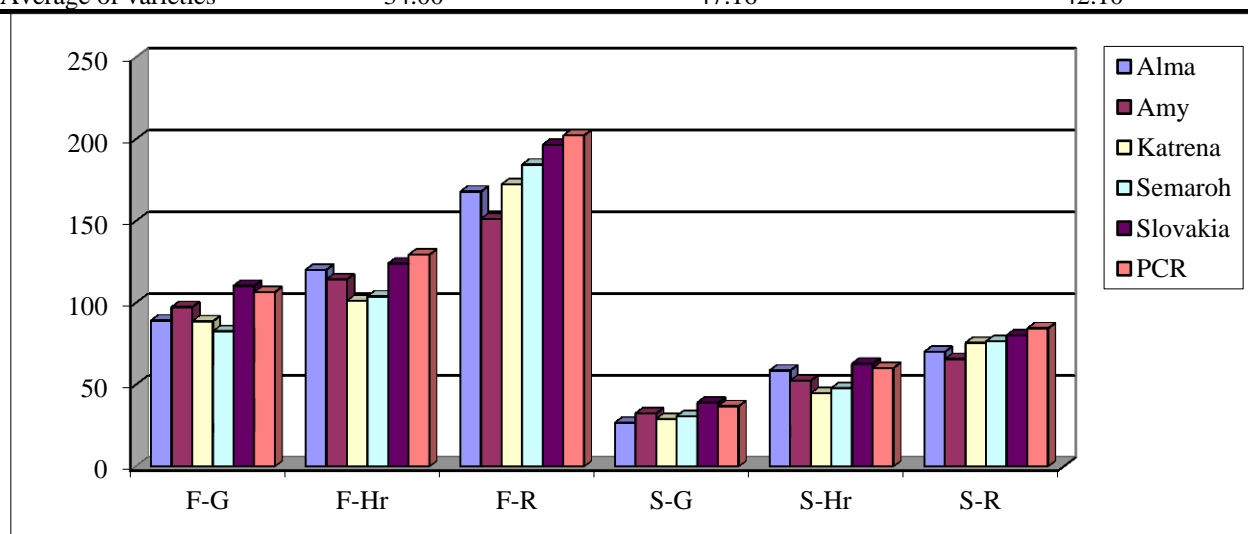

Figure 3 Content of vitamin C in fresh and sterilized pepper according to the degree of maturity and varieties (Note: F = fresh pepper, S = sterilized pepper slices, G = technical maturity, Tr = transitional maturity. R = botanical maturity).

thermal blanching at 70 °C, 80 °C and 98 °C (1 and 2.5 min.), on sweet green and red bell peppers. Pressure treated peppers showed a lower reduction on soluble protein and ascorbic acid contents. Red peppers presented even an increased content of ascorbic acid (15 – 20%), compared to the untreated peppers.

Valšíková, Čurda and Kopec (1986) investigated the loss of vitamin C in varieties of peppers in botanical and technological maturity. The green fruit has retained from 43.6 to 55% of vitamin C and red peppers from 46.5 to 69.3%. **Authors Oruna-Concha et al. (1998)** found that unblanched beans and peppers lost 97% of their vitamin C within 1 month of freezing, whether or not were contained in bags sealed under vacuum. The beans vitamin C content was reduced after blanching by 28%, but limited further decreases to between 3 (vacuum sealed) and 10% (no vacuum) in 12 months.

Vitamin C and carotenoids are the antioxidant components of vegetable species. According to the authors **Andrejiová et al. (2016)** no significant correlation was obtained with monitored antioxidant constituents.

Vitamin C may also be included among the substances with antioxidant properties. The highest content of vitamin C in our experiments had pungent pepper varieties PCR in temporarily and botanical maturity. According to the results **Škrovánková et al. (2017)** was the highest in antioxidant activity chilli pepper compared with sweet varieties.

CONCLUSION

Soluble solids content in our experiments was influenced by the maturity of pepper fruits. The highest content was found in peppers collected in botanical maturity, where the average was 5.82% in 2012, 6.52 in 2013 and 6.13 in 2014. Lower average, we measured by the intermediate maturity, 4.25 in 2012, 5.2% in 2013 and 4.73% in 2014. The lowest soluble solids content was recorded for fruit harvested in technical ripeness, only 3.57% in 2012, 4.25% in 2013 and 4.10% in 2014.

It can be concluded that the variety 'Semaroh' showed higher values than other varieties, especially in half red and red pepper fruits. If we evaluate the years, most refractive solids had fresh fruit in 2013, and the least in the year 2012.

The average level of vitamin C in all years was highest in fresh red peppers. The richest in this vitamin were varieties 'PCR' and 'Slovakia' Last vitamin C was in varieties 'Amy' and 'Alma'. The lowest average content of vitamin C was recorded in varieties harvested in the technical maturity. In 2012 it was variety 'Semaroh' (75.88 mg.100 g⁻¹). In 2013 the least vitamin C content (85.90 mg.100 g⁻¹) had also 'Semaroh' variety and in 2014 it was 'Alma' variety with among of vitamin C 84.00 mg.100 g⁻¹ only. When evaluating the years in terms of average vitamin C level in peppers fresh fruit, the best year was 2013 and the weakest year 2012.

The highest content of vitamin C in sterilized fruits of the pepper was measured in varieties harvested in botanical ripeness in all years. Average in vitamin C of all sterilized varieties in 2012 was 69.06 mg.100 g⁻¹. In 2013 the average value was 76.55 mg.100g⁻¹ and in 2014 it was 81.06 mg.100 g⁻¹. The three-year averages of vitamin C in

all maturity were highest in varieties 'Slovakia' and 'PCR'.

Retention of vitamin C in sterilized fruits of the pepper we expressed in% as retention. For six varieties we have found that in technical maturity retained after sterilization on average 34.0% of vitamin C, in an intermediate maturity 47.16% and 42.10% of botanical maturity. In percentage terms, the retention of vitamin C between varieties is not statistically significant but significant difference is between the retention of vitamin C in various stages of maturity.

REFERENCES

- Andrejiová, A., Hegedúsová, A., Mezeyová, I., Marták, M., Šlosár, M. 2015. Quantitative and qualitative characteristics of Serbian tomato varieties grown in conditions of Slovak Republic. *Potravinárstvo*, vol. 9, 2015, no. 1, p. 119-123. <https://doi.org/10.5219/449>
- Andrejiová, A., Kóňa, J. 2010. *Návody na cvičenia zo zeleninárstva*. (Instructions for the exercise of Vegetable Production). Nitra : SPU, 108 p. ISBN 978-80-552-0334-8.
- Bernhardt, S., Schlich, E. 2006. Impact of different cooking methods on food quality: Retention of lipophilic vitamins in fresh and frozen vegetables. *Journal of Food Engineering*, vol. 77, no. 2, p. 327-333. <https://doi.org/10.1016/j.jfoodeng.2005.06.040>
- Bosland, P. W., Votava, E. 2012. *Peppers: vegetable and spice capsicum*. New York. USA : CABI Publishing, 230 p. ISBN 9781845938253. <https://doi.org/10.1079/9781845938253.0000>
- Castro, M., Saraiva, J., Lopez, I., Loey, A., Delgado, I., Smout, Ch., Hendrickx, M. 2008. Effect of thermal blanching and of high pressure treatments. *Food Chemistry*, vol. 107, no. 4, p. 1436-1449. <https://doi.org/10.1016/j.foodchem.2007.09.074>
- Guiamba, I., Ahrné, L., Khan, M. A., Svanberg, U. 2016. Retention of β-carotene and vitamin C in dried mango osmotically pretreated with osmotic solutions containing calcium or ascorbic acid. *Food and Bioprocess Processing*, Elsevier, vol. 98, p. 320-326. <https://doi.org/10.1016/j.fbp.2016.02.010>
- Hegedúsová, A., Juríková, T., Andrejiová, A., Šlosár, M., Mezeyová, I., Valšíková, M. 2016. Bioactive substances as phytonutrients in horticultural products. University textbook. (In Slovak: *Bioaktívne látky ako fytonutrienty v záhradníckych produktoch. Vysokoškolská učebnica*). Nitra : SPU, 120 p. ISBN 978-80-552-1546-4.
- Jedlička, J. 2012. *Ovocie a zelenina pri prevencii a liečbe ochorení ľudí*. (In Slovak: *Fruit and vegetables in the prevention and treatment of human disease*). Nitra : SPU, 190 p. ISBN 978-80-552-0859-6.
- Juríková, T., Balla, Š. 2012. *Zdraviu prospešné účinky potravín pri bezlepkovej diéte*. (In Slovak: *Health benefits of foods with gluten-free diet*). Bratislava : ŠEFT Bratislava. 166 p. ISBN 978-80-558-0940-0.
- Kopec, K. 1998. *Tabulky nutričních hodnot ovoce a zeleniny*. (In Slovak: *Tables of fruits and vegetables nutritional values*). Praha : ÚZPI. 72 p. ISBN 80-86153-64-9.
- Michalik, L. 2010. The effect of non-woven PP fabric covers on the yielding and the fruit quality of field-grown sweet peppers. *Acta Scientiarum Polonorum, Hortorum Cultus*, vol. 9, no. 4, p. 25-32.
- Mlček, J., Valšíková, M., Družbiková, H., Ryant, P., Juríková, T., Sochor, J., Borkovcová, M. 2015. The antioxidant capacity and macroelement content of several

onion cultivars. *Turkish Journal of Agriculture and Forestry*, vol. 39, no. 6, p. 999-1004. <https://doi.org/10.3906/tar-1501-71>

Oruna-Concha, M. J., Gonzalez-Castro M. J., Lopez-Hernandez, J., Simal-Lozano, J. 1998. Monitoring of the Vitamin C Content of Frozen Green Beans and Padron Peppers by HPLC. *Journal of the Science of Food and Agriculture*, vol. 76, no. 3, p. 477-480. [https://doi.org/10.1002/\(SICI\)1097-0010\(199803\)76:3<477::AID-JSFA975>3.0.CO;2-U](https://doi.org/10.1002/(SICI)1097-0010(199803)76:3<477::AID-JSFA975>3.0.CO;2-U)

Petříková, K., Hlušek, J., et al. 2012. *Zelenina – Pěstování, výživa, ochrana a ekonomika*. (In Czech. *Vegetables - growing, nutrition, protection and economy*). Praha : Profi Press, s.r.o. 191 p. ISBN 80-86726-50-2.

Rodríguez-Burruezo, A., Nuez, F. 2006. Mejora de la calidad en pimiento. In: Llácer, G. et al. *Mejora genética de la calidad en plantas*. Spain : Universidad Politécnica de Valencia. p. 361-392. ISBN 978-84-9705-693-9.

Škrovánková, S., Mlček, J., Sochor, J., Baron, M., Kynický, J., Juríková, T. 2015. Determination of ascorbic acid by electrochemical techniques and other methods. *International Journal of Electrochemical Science*, vol. 10, no. 3, p. 2421-2431.

Škrovánková, S., Mlček, J., Orsavová, J., Juríková, T., Dřimalová, P. 2017. Polyphenols content and antioxidant activity of paprika and pepper spices. *Potravinárstvo*, vol. 11, no. 1, p. 52-57. <https://doi.org/10.5219/695>

Tomašová, D., Valšíková, M., 2012. Effect of varieties and cultivation methods on the pepper (*Capsicum annuum*) yield quantity and quality. In: *Zborník príspevkov a prezentácií zo študentskej vedeckej konferencie* (Proceeding from the students scientific conference). Nitra. p. 52-57. ISBN 978-80-552-0888-6.

Tilahun, S., Paramaguru, P., Rajamani, K. 2013. Capsaicin and ascorbic acid variability in Chilli and paprika cultivars as revealed by HPLC analysis. *Journal of Plant Breeding and Genetics*, vol. 1, no. 2, p. 85-89.

Uher, A., Kóňa, J., Valšíková, M., Andrejiová, A. 2009. *Zeleninárstvo (Poľné pestovanie)*, (In Slovak: *Production of vegetables (field cultivation)*). Nitra : SPU, 212 p. ISBN 978-80-552-0199-3.

Valšíková, M., Chrenko, J. 1983. Obsah kyseliny askorbovej a β -karoténu v rôznych odrodách zeleninovej papriky konzervovanej sterilizovaním, (Ascorbic acid and β -

carotene content in different sweet peppers varieties, canned by sterilization). *Buletin PV*, Bratislava, XII., p. 185-190.

Valšíková, M., Paulen, O. 2013. *Study of Capsicum diversity and quality*. Praha : Profi Press, 169 p. ISBN 978-80-86726-56-4.

Valšíková, M., Minárová, E., Pauková, B. 1984. The Content of vitamin C in the assortment of sweet garden pepper after the post-harvest treatment. *Sborník ÚVTIZ*, p. 53-59.

Valšíková M., Čurda K., Kopec K., 1986. Changes in the nutritive value of sweet garden pepper after preservation, *Sborník ÚVTIZ – Potravinárske Vědy*, vol. 4, p. 285-288.

Valšíková, M. 2014. *Rok v zeleninovej záhrade*. (In Slovak: *Year in the vegetable garden*). Bratislava : Plat4M Books, 164 p. ISBN 978-80-89642-11-2.

Valšíková, M., Mezeyová, I., Rehuš, M., Šlosár, M. 2016. Changes of vitamin C content in celery and parsley herb after processing. *Potravinárstvo*, vol. 10, no. 1, p. 637-642. <https://doi.org/10.5219/687>

Acknowledgments:

This work was supported by grant KEGA 023 SPU-4/2016.

Contact address:

Magdaléna Valšíková, Slovak University of Agriculture, Faculty of Horticulture and landscape Engineering, Department of Vegetables Production, Tr. A. Hlinku 2, 949 76 Nitra Slovakia, E-mail: magdalena.valsikova@uniag.sk

Marián Rehuš, Slovak University of Agriculture, Faculty of Horticulture and landscape Engineering, Department of Vegetables Production, Tr. A. Hlinku 2, 949 76 Nitra Slovakia, E-mail: rehus.marian@gmail.com

Patrik Komár, Slovak University of Agriculture, Slovak University of Agriculture, Faculty of Horticulture and landscape Engineering, Department of Vegetables Production, Tr. A. Hlinku 2, 949 76 Nitra Slovakia, E-mail: patrik.kom@gmail.com

Oleg Paulen, Slovak University of Agriculture, Faculty of Horticulture and landscape Engineering, Department of Fruit Production, Viticulture, and Enology, Tr. A. Hlinku 2, 949 76 Nitra Slovakia, E-mail: oleg.paulen@uniag.sk



PHYSICO-CHEMICAL CHARACTERISATION OF SLOVAK WINES

Barbora Lapčíková, Lubomír Lapčík, Jana Hupková

ABSTRACT

The aim of the present study was characterisation of selected varieties of still wines produced in Slovak Republic in vintage year 2013 and one 2012. There were tested ten samples of nine varieties of wines originated from Malokarpatská “Lesser Carpathian” and Južnoslovenská “Southern Slovakia” wine regions of Slovak Republic, Dornfelder, Frankovka modrá, Svätovarinecké, Zweigeltrebe, Müller Thurgau, Veltlínské zelené, Rizling rýnsky, Rizling vlašský and Sauvignon wines. There were studied selected physico-chemical properties of tested wines as a total contents of anthocyanins and polyphenols by means of spectrophotometry, titratable acidity, density and chromatic characteristics. The highest content of anthocyanins (TAC) was found in red wine Frankovka modrá, 183 mg.L⁻¹ and the lowest for sample rose wine St. Laurent 19 mg.L⁻¹. The content of total phenolic compounds as a gallic acid was in range 2833 to 1961 mg.L⁻¹ for red wines, 1016 and 1013 mg.L⁻¹ for rose wines, 1085 to 549 mg.L⁻¹ for white wines. Total acidity was average 6.3 ±0.3 g.L⁻¹ only for Ryzling rýnský, 8.2 g.L⁻¹ and Sauvignon rose 8.0 g.L⁻¹ and was expressed as the amount of tartaric acid. Quality of wines can be expressed by colour intensity too. Was evaluated and compared intensity of colour in wines by CIE Lab method and the total differences between red, rose and white wine ΔE^* was calculated. The most differences was found for Svätovarinecké a Frankovka modrá (2.5) – red wines (“clearly perceptible”) and 4.9 for Veltlínské zelené and Müller Thurgau – white wine (“moderating effect”).

Keywords: wine; analysis of wine; polyphenols; anthocyanins; spectrometry; CIELab

INTRODUCTION

Wine is one of the most drinking alcoholic beverages in the world with a beneficial influence both to the human health as well as to the countryside landscape architecture of the places of its production.

There are recognised six wine growing regions in Slovak Republic with about forty turfs regions, which are further divided into individual winery villages. According to the criteria of the European legislation Slovak vineyards are classified in Zone B, within which individual municipality's areas ascribed to the B1, B2 and B3 categories. Category B1 represents the areas with the best lodges and microclimate conditions of the cultivation of grapes. To B2 category includes vineyards lying in a climate less warm regions. In both categories turfs are lying mostly on the mountines slopes. B3 type wine yards lie in areas of less appropriate sun exposure and microclimate. These vineyards are located mainly in the plains areas, where they are harmed by cold winters and spring frosts. Within main six winery regions of Slovakia which include the winery regions of Limbach, Južnoslovenská, Stredoslovenská, Nitrianska, and Východoslovenská and region Tokaj (Hronský, 2001; Stevenson, 2011).

The antioxidation activity is one of the most valuable properties of wine. It is assumed, that the phenolic content in wines is the most probably responsible for its antioxidant activity (Staško et al., 2008).

The polyphenolic composition of the wine depends on the grape variety, vineyard location, cultivation system, climate, soil types, vine cultivation practices, harvesting time, production process (pressing, winemaking method, skin-contact maceration period, etc.) and aging. These compounds are grouped into several families according to their chemical structure: hydroxycinnamic acids, hydroxybenzoic acids, flavanols, flavonols, etc. (Rodríguez-Delgado, González-Hernández, Conde-González, & Pérez-Trujillo, 2002). Phenolic compounds, which are responsible for the colour of wines are transferred from the skin and seeds of grapes and diffused into the must and wine during the maceration stage. The bright red colour of young wines is mainly due to free anthocyanins, self-association, and the copigmentation of anthocyanins with other phenols present in these wines such as flavanols, flavonols and hydroxycinnamic acids. Colour is one of the main parameters of the quality of wines, especially for red ones. The colour provides information about defects, the type, and the conservation of wines during storage. It has an important influence also

on the overall acceptability by consumers. In majority of wineries, the routine analysis of the colour of wines is routinely performed to control and evaluate the wine quality. The CIELab method is one of the most widely used and has been applied by several authors to determine the chromatic characteristics of different wines and to study their evolution (OIV, 1990; (Pérez-Magariño & González-Sanjosé, 2003a). Tristimulus colorimetry, through calculation of the ΔE^*_{ab} parameter (difference in colour), among others, allows the interpretation of copigmentation at the visual level (García-Marino, Escudero-Gilete, Heredia, Escribano-Bailón, & Rivas-Gonzalo, 2013; Trouillas, 2016).

The aim of this study is to evaluate variety of wines from different Slovak regions by selected physico-chemical and analytical methods.

MATERIAL AND METHODS

Sites characteristics

Malokarpatská (Lesser Carpathian) winery region

Lesser Carpathian vineyards are extended in the fields in coherent tracts on the slopes of the Little Carpathians from Bratislava towards Pezinok and further to the Horné Orešany. A region with the largest area of vineyards made from 12 wine-growing areas with land of 120 wine-growing villages. Altitude vineyard is ranging between 145 to 260 meters above sea level. Atmospheric rainfall for the year reaches 670 millimeters, and the average air temperature in the vegetation period is approximately about 16.8 °C. Soils are framed, soft and weaker retain water.

Južnoslovenská (Southern Slovak) winery region

South Slovak area represents a predominantly lowland plains with an average altitude of 140 m above sea level. The area is divided into 8-growing sub-regions and 114 winery villages. This region is the hottest winery region of Slovakia. Rainfall do not exceed 325 mm and the highest average air temperatures reaches 16.9 °C, thereby enabling to produce fine wines with the expression.

Nitranská winery region

This region is stretches over the southern, south-west and south-eastern slopes of the mountains of Trábeč. The zone consists of nine winery sub-regions (159 winery villages) that start at the watershed scale. Mean rainfall is 333 mm and the average altitude 150 m above sea level, soils are medium-heavy and well-dependent.

Stredoslovenská winery region

In this area, the 7-growing sub-regions and 107 winery villages are located. Region is not coherent, it forms a rather different winery tracts, which extends on the southern slopes of Krupinska hills. The average air temperature is an about 16.2°C, and the precipitation of approximately 362 mm. Soils are nutritious and moderately heavy.

Východoslovenská winery region

Eastern Slovak winery areas are formed from four winery sub-regions and 89 winery villages, which are located on moderate slopes of mountains Vihorlat edge in Eastern

Slovak lowland. The area is geologically diverse, and the climate is warm and moderately humid, with dry sites with colder winters. Average rainfall in this area is 373 mm. The temperature is on average around 16.6 °C.

Winery region Tokaj

Tokaj region is the smallest winery area of Slovakia, with an area of about 900 hectares. The area lies at the southern and often steep slopes in the southeastern part of Zemplín hills. For this area there are typical warm and slightly dry summers, having an average air temperature through vegetation about 16.8 °C and 336 mm rainfall. The soil is rocky gravel up and sandy with a higher content skeleton (Hronský, 2001).

Experimental wine varieties characteristic

Ryzlík rýnský (Riesling)

It is originally a German variety, grown mainly in the northern winery regions. These include the highest-quality varieties of wine, characterized by a linden bouquet. Riesling cloth collecting reaches ripeness in the second decade of October, when favorable weather and a later harvest achieves outstanding quality. Wine of this variety is high quality of aromatic acids with harmony and with typical varieties characters. Synonym: Riesling, Hocheimer, White Riesling.

Ryzlík vlašský (Riesling Italico)

Tassel of this variety is smaller with a characteristic side-tagged shape. It requires a longer growing season and is resistant to winter and the spring frost. A harvest ripeness achieved also in the second decade of October. It is a most reliable variety, which has musts with a sugar content of 15° NM can be prepared in very high quality wines, which are characterized by slightly increased acidity, often with subtle varieties bouquet and odor resembling bitter almonds. Synonyms: Vlasak, Riesling Italico, Welschriesling, Graševina and other.

Sauvignon

Sauvignon ripening in early October. The wine is characterized by a spicy flavor and an intense aroma of black blackcurrant, stinging nettle or peaches, which is influenced by soil conditions and year. Synonyms: Sauvignon Blanc, Fumé Blanc, Punechon and other.

Müller Thurgau

Müller Thurgau is more fertile than Riesling and was created by crossing Riesling and Silvaner varieties in Switzerland. Wines of this variety are finely aromatic with low acid content and exhibit flowery bouquet with quality fruity character. Harvest ripeness is reached at the end of September. It requires a soil rich in nutrients and humidity with higher calcium content. For these wines, it is recommended its earlier consumption, because the longer maturing bouquet with expressiveness and quality decreases. Synonyms: Mueller Thurgau, Rivaner, Riesling Sylvaner.

Veltlínské zelené (Green veltliener)

Green Veltliener is the second most widely produced variety in Slovakia. Matures in mid-October at a sufficient ripeness it gives a very gentle, pleasant wine with an

intense bouquet. The taste is depending on the soil and position. It shall enter character linden honey, bitter almonds or spices. Synonyms: Gruner Veltliner, Muskateller.

Frankovka modrá (Lemberger)

Lemberger ripening in the second decade of October. Well it's doing on moderate slopes with a south exposure. It is characterized by ruby red color, delicate flavor and cinnamon typical astringents taste, with fullness and balanced acidity. It is recommended to be picked up at the latest available time, because of a higher bouquet character of the wine. Synonyms: Limberger, Lemberger, Blaufränkisch, Starosvetské.

Svätovavrinské (St. Laurent)

This is a variety typical for northern winery regions. A harvest ripeness is reached at the end of September, it is easy to land at any location and it prefers colder climate. It belongs to varieties which give a typical red wine with intense color, pleasant bitterness and a high content of tannins. By maturation and aging their character is softening and wines ecome softer and harmonic. Synonyms: Saint Laurent, Laurenztraube.

Zweigeltrebe

It is widely grown variety that cloth collecting ripeness is reached in early October, provides wines rich of dyes having a violet shade and often is this variety applied in the production of rose wines of fine fruity taste. Synonyms: Zweigelt, Rotburger.

Dornfelder

Dornfelder is one of the major German red varieties. This variety is resistant to diseases and rot, matures relatively early and achieves a greater production of wines with rich color, better taste and tannins. Variety Dornfelder is registered in Czech Republic since 2004. However, it is not yet registered in Slovak Republic.

Chemicals

Gallic acid, Folin-Ciocalteu reagent, Tartaric acid were purchased from Sigma Aldrich (USA).

Methods

UV-VIS spectrophotometric measurements were realized on UV/VIS - SERIE CE 1000 CECIL (Germany) and Chroma characteristic on HunterLab UltraScan PRO (USA). For potenciomtric titration there was used pH meter Mettler Toledo (Switzerland).

Analytical methods

Analytical methods are essential tools for wine quality control and authentication. The "chromatic characteristics" of a wine are its luminosity and chromaticity. Luminosity depends on transmittance and varies inversely with the intensity of colour of the wine. Chromaticity depends on dominant wavelength (distinguishing the shade) and purity.

Conventionally, for the sake of convenience, the chromatic characteristics of red and rosé wines are described by the intensity of colour and shade, in keeping with the procedure adopted as the working method. Clarity (L^* – lightness), red/green colour component (a^*), and blue/yellow colour component (b^*); and by its derived magnitudes: chroma, saturation (C^*), hue angle (h_{ab}^*) and chromacity [(a^*, b^*) or (C^*, h_{ab}^*)]. In other words, this CIELab colour or space system is based on a sequential or continuous Cartesian representation of 3 orthogonal axes: L^* , a^* and b^* Coordinate L^* represents clarity ($L^* = 0$ black and $L^* = 100$ colourless), a^* green/red colour component ($a^* >0$ red, $a^* <0$ green) and b^* blue/yellow colour component ($b^* >0$ yellow, $b^* <0$ blue) (OIV, 1990; Zmeškal et. al., 2002).

$$C^*_{ab} = \sqrt{(a^*)^2 + (b^*)^2} \tag{1}$$

$$h_{ab}^* = \tan^{-1}(b^*/a^*) \tag{2}$$

Color differences between two wines (ΔE_{ab}^*) can be calculated by equation (3):

Table 1 Studied samples of red wine.

Wine	Labelling	Production year	Type	Locality
Dornfelder	DR	2013	quality	Južnoslovenská
Frankovka modrá	FR	2013	late harvest	Malokarpatská
Svätovavrinské	SV	2013	late harvest	Malokarpatská

Table 2 Studied samples of rose wine.

Wine	Labelling	Production year	Type	Locality
Svätovavrinské	SVR	2013	late harvest	Malokarpatská
Zweigeltrebe	ZW	2013	late harvest	Južnoslovenská

Table 3 Studied samples of white wine.

Wine	Labelling	Production year	Type	locality
Müller Thurgau	MT	2013	late harvest	Malokarpatská
Veltlínske zelené	VZ	2013	grape selection	Malokarpatská
Rizling Rýnsky	RR	2013	late harvest	Malokarpatská
Rizling Vlašský	RV	2013	grape selection	Malokarpatská
Sauvignon	SG	2012	berries selection	Malokarpatská

$$\Delta E_{ab}^* = [(\Delta L^*)^2 + (\Delta a^*)^2 + (\Delta b^*)^2]^{1/2} \quad (3)$$

The Chroma and hue values were determined by the procedure reported by (Wang et al., 2015). After adjusted the pH of the tested samples to 3.6, the samples were filtered through a 0.45 mm membrane, and then, used deionized water as the blank control, the absorbance values at wavelengths of 420 nm, 520 nm and 620 nm were measured in triplicate by a UV-VIS Cecil spectrophotometer.

The Chroma value was the sum of the absorbance values at 620 nm, 520 nm and 420 nm, and the hue value was the ratio of the absorbance values at 420 nm and 520 nm.

$$I_{10\text{ mm}} = A_{420} + A_{520} + A_{620} \quad (4)$$

The shade O is conventionally given by eq. (5):

$$O = A_{420}/A_{520} \quad (5)$$

The total anthocyanins content (TAC) was estimated by spectrophotometric measurements (Hosu, Cristea and Cimpoi, 2014).

One sample 1 mL wine and 49 mL 1 mol.L⁻¹ HCl was stirred and after 60 min was measured in 10 mm cuvette at wavelength 520 nm, second sample 1.3 mL wine and fresh 20% bisulfide potassium (K₂S₂O₅) aqueous solution was measured after 1 minute at 520 nm. Sample absorbance was determined at 520 nm by a blank solution. The differences between the absorbance values of sample prepared without potassium bisulfide and the absorbance value of sample prepared with potassium bisulfide were calculated. The anthocyanin content was express in mg.L⁻¹ of wine and was calculated by eq. (6):

$$x = 20 * [50 * A_{520} (HCl) - 5/3 * A_{520} (SO_2)] \quad (6)$$

where x is content of anthocyanin in mg.L⁻¹ and A_{520} is absorbance at 520 nm (Balík 2010).

The total phenolic content (TPC) was determined according to the Folin-Ciocalteu colorimetric method (Folin & Ciocalteu, 1927; Staško et al., 2008; Bajčan et al. 2016). Absorbance was measured at 760 nm. Results were expressed as mg.L⁻¹ Gallic acid equivalents (GAE).

Gallic acid standard solutions were prepared at a concentration ranging from 0 to 1000 mg.L⁻¹ (Sun et al., 2017). For this assay, 1.0 mL of Folin–Ciocalteu reagent (0.2 mol.L⁻¹) was added to 1.0 mL of wine appropriately diluted with distilled water to ensure the absorbance was in the range of 0.20 – 0.80. The reaction was allowed to react for 5 minutes and then, 5 mL of 20% solution of Na₂CO₃ was added. Samples were incubated at the room temperature in dark place for 120 min, and the absorbance was measured at 760 nm. All measurements were performed in triplicate. A standard curve was obtained using 0 – 1000 mg Gallic acid.L⁻¹ and was used to calculate the total phenolic content of wines. Gallic acid (mg GAE.L⁻¹) was used because it is a more stable and pharmacologically active antioxidant, quantitatively equivalent to most phenolic and gives consistent and reproducible results (Wu et al., 2016).

The total acidity of the wine is the sum of its titratable acidities when it is titrated to pH 7 against a standard alkaline solution 0.1 M NaOH with the potentiometric detection of the end point. Carbon dioxide is not included in the total acidity. The total acidity expressed in grams of tartaric acid per liter and is given by eq. (7):

$$x = a * f * 0,75 \quad (7)$$

where x is total tartaric acid in g.L⁻¹, a is assumption of 0.1 M NaOH to pH 7, f is a factor of 0.1 M NaOH (OIV, 1990).

All measurements were done at least in two replicates, each measurement was repeated at least 5×. Data were analysed using one way analysis of variance (ANOVA) method (Microsoft Excel, USA). These analysis allowed to detect the significance of the effect of fat content addition as well as of type of the fat used on contact angles of wetting results. For all tested samples combinations the observed differences were of high statistical significance ($p \leq 0.05$).

RESULTS AND DISCUSSION

The highest content of total polyphenolic compounds as gallic acid was determined for Saint Laurent red wine, vintage 2013 Late Harvest, where the concentration of polyphenols was 2832.78 mg.L⁻¹. The somewhat lower concentration was determined for wine Lemberger blue

Table 4 Results of tested wines analytical measurements.

Labelling	TPC (GAE) (mg.L ⁻¹)	TAC (mg.L ⁻¹)	Total acidity (g.L ⁻¹)	Density (g.cm ⁻³)	I _{10 mm}	O
DR	1960.56 ±22.23	176 ±5	6.5 ±0.1	0.9915	8.291	0.74
FR	2557.78 ±38.25	183 ±8	6.0 ±0.2	0.9907	8.323	0.73
SV	2832.78 ±35.33	114 ±4	6.2 ±0.1	0.9934	8.003	0.80
SVR	1013.33 ±15.28	19 ±1	8.0 ±0.2	0.9928	0.544	1.13
ZW	1016.11 ±24.56	43 ±2	6.7 ±0.1	0.9929	0.801	1.06
MT	549.44 ±10.96		6.0 ±0.1	0.9887		
VZ	732.78 ±13.54		6.0 ±0.1	0.9898		
RR	1085.56 ±16.73		8.2 ±0.2	0.9994		
RV	577.22 ±8.15		7.0 ±0.2	0.9882		
SG	952.22 ±10.57		6.3 ±0.1	1.0111		

Note: Results expressed as the mean value ±standard deviation (n = 3). Significant differences (Anova, $p < 0.05$) between samples.

(2013, late harvest) and 2557.78 mg.L⁻¹. Conversely, the lowest concentration, 549.44 mg.L⁻¹ showed a sample of white wine Müller Thurgau (2013) in the Table 4. However, even this amount is still higher than reported (Jackson, 2008), where the concentration of total polyphenols in red wines were ranging between 955 – 1300 mg.L⁻¹ and in white wines were ranging from 190 to 290 mg.L⁻¹. This concentration is similar to that of found by us for set rosé (SVR and ZW), but significantly lower than that of red wines monitored within this study (DR, FR and SV). Obtained results are comparable with data reported by (Balík 2010), where the ranges of polyphenols content in Moravian wines were ranged between 1580 – 1912 mg.L⁻¹ for wine Dornfelder, 1334 – 1756 mg.L⁻¹ in Lemberger blue (Frankovka) and 1455 to 2512 mg.L⁻¹ at St. Laurent. These results were similar, as observed in another study, of red wines originating from different regions of Macedonia. In this study, the authors disclosed the resulting value in the range of 1394 to 3097 mg.L⁻¹ (Ivanova-Petropulos et al., 2015) and the contents of polyphenols ranging between 1585 – 4203 mg.L⁻¹ for red wines was reported in another study originating from the city of Mendoza in western Argentina (Fanzone et al., 2012) for Cabernet Sauvignon from Slovak was values 1838 to 2636 mg.L⁻¹ (Bajčan et al. 2016).

The total content of anthocyanins (TAC) in red and rosé wines were obtained by fitting the measured absorbance

values of wine with the addition K₂S₂O₅ and wines with the addition of HCl into the equation (6). Measured values of the content of anthocyanins given in mg.L⁻¹, are shown in Table 4. The highest content of anthocyanins, was found in samples of red wine Lemberger blue, where the total content of 183 mg.L⁻¹ antocyanins was found. The lowest content found was 19 mg.L⁻¹ for the sample rose wine St. Laurent. Similar values were measured by (Fanzone et al., 2012), which together with colleagues measured for red wines originated from the city of Mendoza (Argentina), ranged from 177.6 to 587.2 mg.L⁻¹ of total anthocyanins. Measured values of anthocyanins were significantly lower, because the content of anthocyanin was lower with aging. Anthocyanin concentration decrease due to the reaction with other phenols, enzymatic reactions by the production of quinoas via coupled oxidation reactions and/or condensation between quinines and/or non-enzymatic reactions by production of polymers from anthocyanin monomers (Figueiredo-González et al., 2014).

In the case of rose wines and for wine St. Laurent 50 mg.L⁻¹ of anthocyanins was found and for Zweigeltrebe of 64 mg.L⁻¹. Observed results in this study were lower in comparison to the results of 321 – 941 mg.L⁻¹ found in the study (Ivanova-Petropulos et al., 2015; Balík 2010).

Titration acidity was expressed as the amount of tartaric acid was for each wine under study ranging from 6.0 to 8.2 g.L⁻¹. The highest titratable acidity was found for the

Table 5 Measured L* a* b*, saturation (C*) and hue angle (H*) for variety of origin wines under study.

Labelling	L*	a*	b*	C*	h _{ab} *
DR	15.42	45.46	25.58	52.16	29.36
FR	16.53	46.50	27.26	53.89	30.38
SV	15.16	45.66	25.29	52.19	28.98
SVR	85.64	11.82	10.61	15.88	41.91
ZW	81.50	17.55	15.17	23.20	40.84
MT	95.67	-0.69	4.25	4.30	-80.77
VZ	94.28	-0.77	8.93	8.96	-85.07
RR	95.06	-1.22	8.07	8.16	-81.40
RV	95.84	-0.88	4.08	4.17	-77.83
SG	95.13	-0.92	6.42	6.48	-81.84

Table 6 Color differences of red and rose wines (ΔE*) between the samples of red wines (red colour), rose wines (pink colour) and the differences between red and rose wines (pink colour).

Labelling	DR	FR	SV	SVR	ZW
DR	-				
FR	2.3	-			
SV	0.4	2.5	-		
SVR	79.3	79.1	79.5	-	
ZW	72.5	72.1	72.8	8.4	-

Table 7 Colour differences of white and rose wines (ΔE*) between the samples of white wines (yellow colour), rose wines (pink colour) and the differences between white and rose wines (pink colour).

Labelling	MT	VZ	RR	RV	SG	SVR	ZW
MT	-						
VZ	4.9	-					
RR	3.9	1.2	-				
RV	0.3	5.1	4.1	-			
SG	2.2	2.7	1.7	2.4	-		
SVR	17.2	15.4	16.3	17.5	16.4	-	
ZW	25.5	23.2	24.2	25.9	24.6	8.4	-

sample of white wine Ryzlik rýnský (production year 2013, Late harvest) and rose St. Laurent. For wine St. Laurent red and rose, which was originated from the same grapes from the same winemaker, we can see the difference in titratable acidity. This difference is the production technology applied, where for St. Laurent red there was produced malic-lactic fermentation resulting in decreased acidity. The final concentration of titratable acidity measured for red wines within this work were similar to the results published in study of Ivanova-Petropulos et al. (Ivanova-Petropulos et al., 2015). They found titratable acidity of 5.5 to 7.9 g.L⁻¹. Also reported by authors (Fanzone et al., 2012), there were obtained similar results ranging between 4.4 to 6.8 g.L⁻¹ titratable acidity for studied red wine.

Color intensity *I* and hue *O* of red wine were obtained by calculation from the measure absorbance at the wavelengths of 420, 520 and 620 nm, according to equations (4) to (5) and results are shown in Table 4.

The brightest sample of studied red wines, with a value of L* = 16.53% was Lemberger blue. Overall the red wine of clarity did not significantly differ. The color of red wines is relative to the CIELab diagram, and it is located within a dark red and blue regions. For rosé wines the higher brightness was found for wine St. Laurent (L* = 85.64%) and sample Zweigeltrebe had a more intense colour to orange and pink (Table 5).

The brightest of white wines tested was Rizling Walnut (L* = 95.84 %). The color of all the white wines was in the colour space green and yellow. For comparison we included the value of color parameters from work package, where was in the evaluation of red wines, the brightness value L* ranged between 1.51 to 15.16%, coordinates a* = 19 to 52.31 and the coordinates b* = 2.61 to 25.33 for wine Dornfelder. For wine Lemberger blue represents values: L* = 15.40% to 23.94%; a* = 53.68 to 60.96; b* = 25.68 to 38.32 and for the wine St. Laurent: L* = 2.73 to 18.16%; a* = 29.88 to 55.73; b* = 4.58 to 28.16. Obtained values were not differing significantly each other. In Table 6 are shown the total color differences between the different wines (ΔE^*) as calculated according to equation (3).

Table 6 shows that the lowest color difference 0.4 was found between the samples of wine St. Laurent red wine and Dornfelder. The differences were "very weak" (Zmeškal, Čeppan and Dzik, 2002). In general, the eye is able to discriminate two colours when $\Delta E^* \geq 1$ (Gonnet, 2001). Between samples Dornfelder and Lemberger blue (2.3) and also St. Laurent red wine and Lemberger (2.5) submission was already a "clearly perceptible" differences. Between the samples of pink and red wines were very high differences which we designated as "disturbing". Of interest was "significant" difference observed between rose wine samples, St. Laurent rose and Zweigeltrebe (8.4). Average colour differences between two red wines was found to be 1.7. These results are similar to those obtained by other authors (Pérez-Magariño and González-Sanjosé, 2003b).

The colour difference observed for tested white wines was about 0.3 (Müller Thurgau and Riesling). Among these samples, the difference was "very weak". "Weak" contrast dyes were compared with samples of Grüner Veltliner and Riesling (1.2). Additionally, Sauvignon and

the other four samples of white wine, were "clearly perceptible" difference. "Medium" color difference was observed between the samples of wine Green Veltliner - Riesling walnut (5.1) and VZ – Müller Thurgau (4.9). Similarly, it was also in detecting the colour difference Riesling – Müller Thurgau (3.9) and RR – Rizling walnut (4.1). The differences between the white and rosé wine samples were as in the previous case, the high (interference), but significantly lower as compared with red rose wines.

CONCLUSIONS

There were measured basic physico-chemical and colour characteristics of the variety of wines produced in Slovak Republic in this study. It was found, that the quality of wines is a complex property of several physico-chemical properties in their mutual synergistic combination. That is why, individual factors affected by the human physiological perception sensitivity are determining overall wine quality perception. There was found, that the interpretation of the components of ΔE^*_{ab} – lightness, chroma, and especially hue differences, as the expression of qualitative observable change is very important for determination of wine quality.

REFERENCES

- Bajčan, D., Vollmanová, A., Šimanský, V., Bystrická, J., Trebichovský, P., Áray, J., Czako, P. 2016. Antioxidant activity, phenolic content and colour of the Slovak Cabernet Sauvignon wines. *Potravinarstvo*, vol. 10, no. 1, 89-94. <https://doi.org/10.5219/534>
- Balík, J. 2010. *Anthokyaninová barviva v hroznech a vinech*. Mendelova univerzita v Brně. 1st ed. Brno : Mendelova univerzita v Brně, 108 p. ISBN 978-80-7375-412-9. [PMCID:PMC2850483](https://doi.org/10.5219/534)
- Fanzone, M., Zamora, F., Jofré, V., Assof, M., Gómez-Cordovés, C., Peña-Neira, Á. 2012. Phenolic characterisation of red wines from different grape varieties cultivated in mendoza province (argentina). *Journal of the Science of Food and Agriculture*, vol. 92, no. 3, p. 704-718. <https://doi.org/10.1002/jsfa.4638> [PMid:21919008](https://pubmed.ncbi.nlm.nih.gov/21919008/)
- Figueiredo-González, M., Cancho-Grande, B., Simal-Gándara, J., Teixeira, N., Mateus, N., De Freitas, V. 2014. The phenolic chemistry and spectrochemistry of red sweet wine-making and oak-aging. *Food Chemistry*, vol. 152, p. 522-530. <https://doi.org/10.1016/j.foodchem.2013.12.018> [PMid:24444970](https://pubmed.ncbi.nlm.nih.gov/24444970/)
- Folin, O., Ciocalteu, V. 1927. Tyrosine and tryptophan determinations proteins. *Journal of Biological Chemistry*, vol. 73, p. 627-50.
- García-Marino, M., Escudero-Gilete, M. L., Heredia, F. J., Escribano-Bailón, M. T., Rivas-Gonzalo, J. C. 2013. Color-copigmentation study by tristimulus colorimetry (CIELAB) in red wines obtained from tempranillo and graciano varieties. *Food Research International*, vol. 51, no. 1, p. 123-131. <https://doi.org/10.1016/j.foodres.2012.11.035>
- Gonnet, J. 2001. Colour effects of co-pigmentation of anthocyanin revisited – 3. A further description using CIELAB differences and assessment of matched colours using the CMC model. *Food Chemistry*, vol. 75, no. 4, p. 473-485. [https://doi.org/10.1016/S0308-8146\(01\)00221-7](https://doi.org/10.1016/S0308-8146(01)00221-7)
- Hosu, A., Cristea, V., Cimpoi, C. 2014. Analysis of total phenolic, flavonoids, anthocyanins and tannins content in

romanian red wines: Prediction of antioxidant activities and classification of wines using artificial neural networks. *Food Chemistry*, vol. 150, p. 113-118. <https://doi.org/10.1016/j.foodchem.2013.10.153> PMID:24360427

Hronský, V. 2001. *Slovenské vína* (Slovak wines). Bratislava : BELIMEX s.r.o., 118 p. ISBN 8085327864.

Ivanova-Petropulos, V., Ricci, A., Nedelkovski, D., Dimovska, V., Parpinello, G. P., Versari, A. 2015. Targeted analysis of bioactive phenolic compounds and antioxidant activity of macedonian red wines. *Food Chemistry*, vol. 171, p. 412-420. <https://doi.org/10.1016/j.foodchem.2014.09.014> PMID:25308688

Jackson, R. S. 2008. 6 - chemical constituents of grapes and wine. In R. S. Jackson *Wine science*. San Diego : Academic Press, p. 270-331. ISBN: 978-0-12-373646-8.

OIV. 1990. International Organisation of Vine and Wine, Compendium of international Methods of wine and must analysis [online] s.a. [cit. 2017-01-20] Available at: <http://www.oiv.int/en/technical-standards-and-documents/methods-of-analysis/compendium-of-international-methods-of-analysis-of-wines-and-musts-2-vol>.

Pérez-Magariño, S., González-Sanjosé, M. L. 2003a. Application of absorbance values used in wineries for estimating CIELAB parameters in red wines. *Food Chemistry*, vol. 81, no. 2, p. 301-306. [https://doi.org/10.1016/S0308-8146\(02\)00509-5](https://doi.org/10.1016/S0308-8146(02)00509-5)

Pérez-Magariño, S., González-Sanjosé, M. L. 2003b. Application of absorbance values used in wineries for estimating CIELAB parameters in red wines. *Food Chemistry*, vol. 81, no. 2, p. 301-306. [https://doi.org/10.1016/S0308-8146\(02\)00509-5](https://doi.org/10.1016/S0308-8146(02)00509-5)

Rodríguez-Delgado, M., González-Hernández, G., Conde-González, J., Pérez-Trujillo, J. 2002. Principal component analysis of the polyphenol content in young red wines. *Food Chemistry*, vol. 78, no. 4, p. 523-532. [https://doi.org/10.1016/S0308-8146\(02\)00206-6](https://doi.org/10.1016/S0308-8146(02)00206-6)

Staško, A., Brezová, V., Mazúr, M., Čertík, M., Kaliňák, M., Gescheidt, G. 2008. A comparative study on the antioxidant properties of slovakian and austrian wines. *LWT – Food Science and Technology*, vol. 41, no. 10, p. 2126-2135. <https://doi.org/10.1016/j.lwt.2007.11.021>

Trouillas, P., Sancho-García, J. C., De Freitas, V., Gierschner, J., Otyepka, M., Dangles, O. 2016. Stabilizing and modulating color by copigmentation: Insights from

review theory and experiment. *Chemical Reviews*, vol. 116, no. 9, p. 4937-4982. <https://doi.org/10.1021/acs.chemrev.5b00507> PMID:26959943

Wang, L., Sun, X., Li, F., Yu, D., Liu, X., Huang, W., Zhan, J. 2015. Dynamic changes in phenolic compounds, colour and antioxidant activity of mulberry wine during alcoholic fermentation. *Journal of Functional Foods*, vol. 18, no. Part A, p. 254-265.

Wu, Z., Xu, E., Long, J., Pan, X., Xu, X., Jin, Z., Jiao, A. 2016. Comparison between ATR-IR, raman, concatenated ATR-IR and raman spectroscopy for the determination of total antioxidant capacity and total phenolic content of chinese rice wine. *Food Chemistry*, vol. 194, p. 671-679. <https://doi.org/10.1016/j.foodchem.2015.08.071> PMID:26471606

Stevenson T. 2011. *The Sotheby's wine encyclopedia*. 4th ed. United Kingdom : Dorling Kindersley Limited, 664 p. ISBN 978-1-4053-5979-5.

Zmeškal, O., Čeppan, M., Dzik, P. 2002. Barevné prostory a správa barev [online] 2002-10 [cit. 2017-01-20] Available at: http://www.fch.vut.cz/lectures/imagesci/download/stud06_roz_n02.pdf.

Acknowledgments:

This study was financially supported by the national budget of the Czech Republic within the research project of the Tomas Bata University in Zlín Internal Grant Agency (reg. number: IGA/FT/2017/004).

Contact address:

Barbora Lapčíková, Department of Food Technology, Faculty of Technology, Tomas Bata University in Zlín, Vavrečkova 275, 762 72 Zlín, Czech Republic, E-mail: lapcikova@ft.utb.cz

Lubomír Lapčík, Department of Food Technology, Faculty of Technology, Tomas Bata University in Zlín, Vavrečkova 275, 762 72 Zlín, Czech Republic, E-mail: lapcik@ft.utb.cz

Jana Hupková, Department of Food Technology, Faculty of Technology, Tomas Bata University in Zlín, Vavrečkova 275, 762 72 Zlín, Czech Republic, E-mail: hupkova@ft.utb.cz



ANTIBACTERIAL ACTIVITY OF *CAPSICUM* EXTRACT AGAINST SELECTED STRAINS OF BACTERIA AND MICROMYCETES

Peter Popelka, Pavlína Jevinová, Karel Šmejkal, Pavol Roba

ABSTRACT

One of traditional plant that has so many pharmacology effects is chilli fruit (*Capsicum* sp.) that belong to the family *Solanaceae*. Around the world is known five varieties of *Capsicum* which are *C. annuum*, *C. frutescens*, *C. chinense*, *C. baccatum*, and *C. pubescens*. Chilli peppers are known for causing the sensation of heat or burning when consumed. The heat sensation is incited by the type and the amount of a group of capsaicinoids, the alkaloids found only in chilli pepper pods. The HPLC method was used for determination of capsaicin and dihydrocapsaicin content in various dried peppers from genera *C. chinense*. Based on the results of HPLC the hottest pepper has been Bhut Jolokia, followed by Habanero Red Savina, Fatalii Yellow, Habanero Paper Latern, Habanero Maya Red, Habanero Red, and Scotch Bonnet Red. The inhibitory effect of the extract of *Capsicum chinense* pepper type was evaluated, using discs diffusion method, against selected bacteria and micromycetes. Extracts from Bhut Jolokia, Fatalii Yellow, Scotch Bonnet Red and habaneros did not inhibit growth of the any bacteria and micromycetes included in our test.

Keywords: antibacterial activity; capsaicin; chilli peppers; HPLC; micromycetes

INTRODUCTION

For a long time hot pepper fruit has been known all over the world as a delicious spice with a characteristic smell and taste. It is used for preparing spicy sauces and also in Mexican and Asian cuisines. The value of hot pepper consists in its sensorial attributes colour, spiciness and flavour (Perucka and Oleszek, 2000). Chilli pepper and their isolated constituents including capsaicinoids have shown also beneficial therapeutic effects, including antioxidant, anti-inflammatory, anticancer, antimicrobial and anti-immune modulator effects. The capsaicinoids have evolved in chilli peppers as a defence mechanism against mammalian predators; nevertheless, this trait is an important fruit quality attribute and one of the most important reasons chilli peppers are consumed. It is an extraordinarily versatile agent, and its use is ranging, in the fields from pharmaceutical purposes and nutrition (seasoning) to chemical weapons. It has been used as an analgesic against arthritis pain and inflammation (Deal et al., 1991). It has also been reported to show anticancer effect (Morré and Morré, 2003) and to be active against neurogenic inflammation (burning and stinging of hands, mouth and eyes) (Szolcsanyi, 2004). The latter property is the basis for the use of capsaicin in defensive pepper sprays. Capsaicin has also been reported to show protective effects against high cholesterol levels and obesity (Kempaiah et al., 2005). Capsaicin and other members of the capsaicinoids group produce a large

number of physiological and pharmacological effects on the gastrointestinal tract, the cardiovascular and respiratory system as well as the sensory and thermoregulation systems.

Capsaicinoids are derivatives of benzylamin. Differences within their structure depend mainly on their acyl moieties, and three structural elements are involved: first of all the length of the acyl chain (C8-C13), then the way it terminates (linear, iso or anteiso-series), and the presence or absence of unsaturation at the ω -3 (capsaicin type) or ω -4 carbon atom (homocapsaicin type I and II) (Fattorusso and Tagliatela-Scafati, 2008). Capsaicin, a homovanillic acid derivative (8-methyl-N-vanillyl-6-nonenamide), is an active component of the red pepper. The level of the capsaicin in the seasoned pepper is around 0.025%, and in the hot pepper around 0.25% (Holzer, 1991). Capsaicin is represented with 69% in the group of capsaicinoids; dihydrocapsaicinoids with 22%; nordihydrocapsaicinoids with 7%; homocapsaicin and homohydrocapsaicin takes only 1% in the group of capsaicinoids. Capsaicin and dihydrocapsaicin being approximately twice as pungent as nordihydrocapsaicin and homocapsaicin and they are responsible for the hotness of the pepper.

The amount of capsaicinoids in a chilli pepper pod is dependent on the genetic makeup of the plant and the environment where it is grown (Zewdie and Bosland, 2000). The amount of capsaicin in a given variety can vary

depending on the light intensity and temperature at which the plant is grown, the age of the fruit, and the position of the fruit on the plant. Chilli peppers must be harvested at an appropriate degree of development in accordance with the criteria proper to the variety and the area in which they are grown.

Chilli peppers contain also phenolic compounds, flavonoids and carotenoids, besides being a source of vitamin C. Among these, flavonoids are ubiquitous phytochemicals found in plants with a wide group of exploitable activities, including antimicrobial activity, antibiotic synergism and bacterial virulence removal. Once absorbed, they influence several biological functions, including protein synthesis, angiogenesis, cell proliferation and differentiation, thus benefiting a variety of human diseases. The flavonoids found in most peppers are glycosides and aglycones of myricetin, quercetin, luteolin, apigenin and kaempferol (Nascimento et al., 2014). Cinnamic and m-coumaric acids are present in the serrano and pimiento morrón, but not in the habanero. It was concluded that the capsaicinoids composition of the three peppers extract is different, and this may influence their antimicrobial effects. One the capsaicin analogues, vanillin, has shown inhibitory activity towards the growth of yeast (Serruti and Alzamora, 1996) and mould (López-Malo et al., 1998). Also, Kim and Ryeom (1979) reported antibacterial effects of capsaicin from Korean hot pepper on *Bacillus subtilis*, *Bacillus cereus*, and *Sarcina lutea*. The importance of finding natural inhibitors of pathogenic microorganisms has been stressed by López-Malo et al. (1998).

MATERIAL AND METHODOLOGY

Plant material

Four Habanero chilli varieties: Habanero Habanero Red Savina (HRS), Habanero Maya Red (HMR), Habanero Paper Lantern (HPL), Habanero Red (HR), and varieties Fatalii Yellow (FY), Scotch Bonnet Red (SBR) and Bhut Jolokia (BJ) have been used in our experiment. The experiment has been started buying seeds, the sowing, germination, transplanting gradually and care of mature plants, including adaptation of climatic conditions and fertilization. After harvesting the ripe fruits have been stored in a refrigerator at 0 – 4 °C. Samples of chili peppers (6 pieces of each variety were used in the experiment) were dried immediately after harvest in the stage of maturity in a laboratory oven with ventilation. Before the drying chilli peppers were cut to halves or quarters (depending on size) to speed up drying and to prevent undesired changes (moulds). Chili peppers have dried along with the placenta and seeds. Drying was carried out in two stages at 40 ± 5 °C, in a first phase of 24 h, and in the second phase 12 – 24 h depends on water content. After drying, the chili peppers were stored in a sealed glass container in a dry, dark place until analysis (not more than one month).

Extraction procedure and HPLC analysis

HPLC analysis of capsaicin content consisted of sample preparation (removing of placenta and seeds), extraction and liquid chromatography analysis.

Sample extraction

Fresh and dried material, without seeds was cut into pieces. The extraction was carried out with ethanol at a ratio of 1 : 10, sonication lasted 30 min, and 4 h of maceration with extraction efficiency 90%.

HPLC analysis

Column Ascentis Express RP-Amide 2.7 µm, 100 x 2.1 mm, gradient: acetonitrile : 0.2% HCOOH, 0 minutes 30 : 70, and 71 : 29 after 10 min, flow rate 0.5 mL.min⁻¹, injection volume 1 µL, temperature 40 °C and UV detection at 254 nm and 280 nm. Capsaicin content was determined based on a calibration curve and SHU units have been determined by calculation. According to the commonly accepted Scoville organoleptic test (Scoville, 1912), the spicy strength of the investigated samples was calculated by converting the capsaicin content expressed in grams of capsaicin per gram of pepper. This conversion to Scoville heat units was done by multiplying the capsaicin content in pepper dry weight by the coefficient corresponding to the heat value for pure capsaicin, which is 1.6 × 10⁷ and after correction of sample extraction 1.8 × 10⁷.

Antimicrobial activity of extracts from chilli peppers

Bacterial and micromycetes strains and media

For antibacterial activity, reference strains CCM 4223 *Staphylococcus aureus*, CCM 4420 *Salmonella enterica* subsp. *enterica* serovar Enteritidis, ATCC 11338 *E.coli* have been used in this experiment. These bacterial strains were collected from Czech Collection of Microorganisms. Terrain strains *Staphylococcus aureus* isolated from soft cheese bryndza, *Salmonella sp.* and *E.coli* isolates from poultry meat were included also in testing were obtained from the culture collections of Department of Food Hygiene and Technology, and maintained at -80 °C in cryobox. Antifungal activity have been tested against reference strains of micromycetes CCMF 269 *Aspergillus ochraceus*, CCMF 683 *Fusarium gramineum*, CCMF 583 *Penicillium viridicatum* and terrain strains *Aspergillus ochraceus* and *Penicillium purpurogenum* isolated from coffee, and *Fusarium gramineum* isolate from cornflakes obtained from the culture collections of Department of Food Hygiene and Technology, and maintained at -80 °C in cryobox.

For the preparation of the inoculum, bacteria strains were cultured in brain heart infusion (BHI) broth for 24 h at 37 ± 2 °C and standardized for the same absorbency, number 0.5 of the McFarland Nephelometer, which corresponds to the order of 10⁸ CFU.mL⁻¹. For the preparation of the inoculum, micromycetes strains were cultured in Sabouraud dextrose broth for 5 d at 25 ± 2 °C.

Disk diffusion method

The antimicrobial activity of the capsaicin extracts was carried out by disc diffusion method. The capsaicin extracts were prepared in ethanol at a ratio of 1 : 10, sonication lasted 30 min, and 4 h of maceration. Sterile filter paper discs (diameter 6 mm) was impregnated with 20 µL of the extracts, and placed on the agar plate, on which the test microorganisms were uniformly inoculated.

The assay dishes were then left for one hour and subsequently incubated for 24 h at 37 °C for bacteria and for 5 d at 25 °C for micromycetes. The diameter of inhibition was then observed and measured. The diameter of the clear zone shown on plates was measured using callipers and expressed in millimetres as its antimicrobial activity. Each experiment was performed in triplicate.

RESULTS AND DISCUSSION

In our study comparison of various Habanero varieties, Fatalii Yellow, Scotch Bonnet Red and Bhut Jolokia was performed. The results can be compared with following study undertaken to compare the heat levels of Habanero Red Savina and Bhut Jolokia in a replicated field trial; establish whether Bhut Jolokia truly has a higher heat level than Habanero Red Savina.

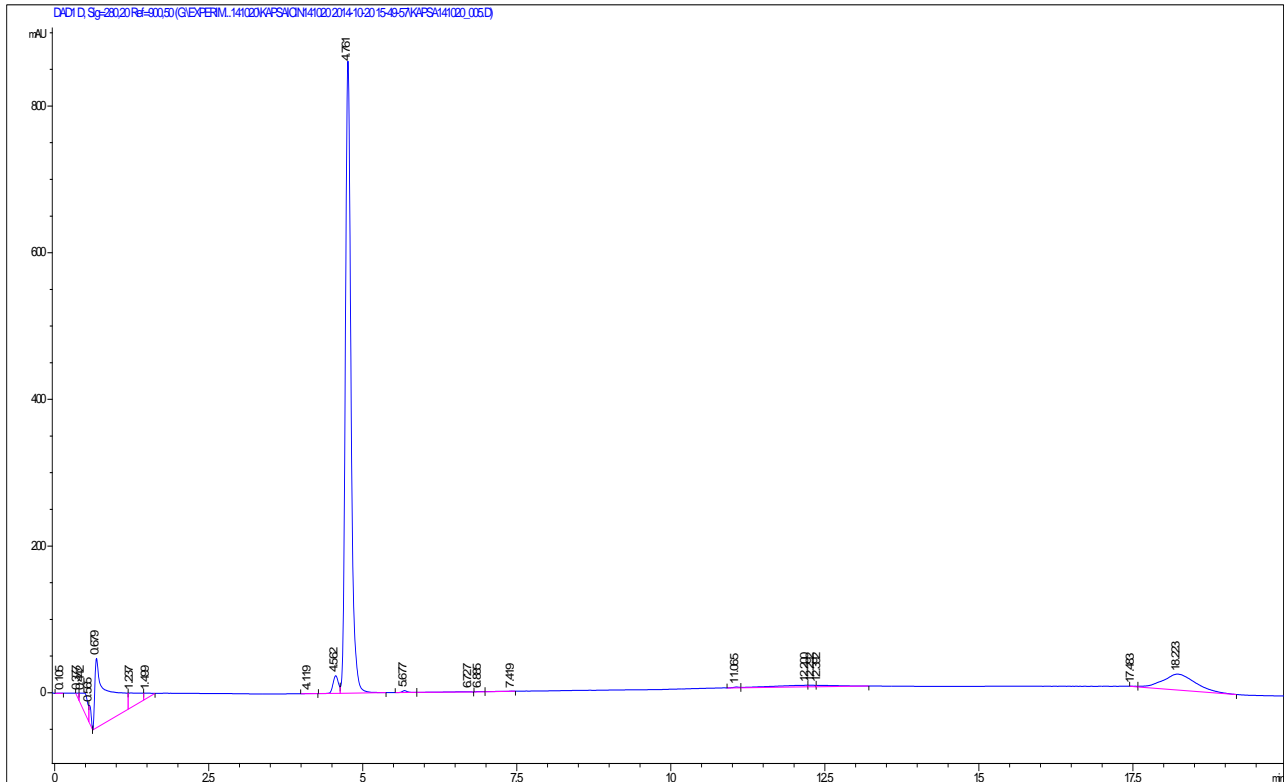

Figure 1 Chromatogram of capsaicin standard determination using HPLC.

Table 1 Capsaicin and dihydrocapsaicin concentrations in extract.

Chilli peppers	Capsaicin ($\mu\text{g.mL}^{-1}$)	Dihydrocapsaicin ($\mu\text{g.mL}^{-1}$)
BJ	2706.3	1738
HRS	886.5	259
FY	663.3	200
HPL	383.5	163
HMR	410.4	124
HR	229.5	110
SBR	126	88

Table 2 Concentration of capsaicin and dihydrocapsaicin in chilli peppers and calculation of SHU after correction of sample extraction.

Chilli peppers	Capsaicin ($\mu\text{g.g}^{-1}$)	Dihydrocapsaicin ($\mu\text{g.g}^{-1}$)	SHU (sum of capsaicin and dihydrocapsaicin) ($18 \times \mu\text{g.g}^{-1}$)
BJ	27145.26	17432.83	802406
HRS	8866.42	2590.41	206223
FY	6595.17	1988.59	154508
HPL	3840.28	1632.29	98506
HMR	4098.58	1238.36	96065
HR	2289.83	1097.52	60972
SBR	1242.97	868.10	37999



Figure 2 Bhut Jolokia.



Figure 3 Bhut Jolokia – dried.



Figure 4 Bhut Jolokia.



Figure 5 Habanero Red Savina.



Figure 6 Habanero Red Savina 1.



Figure 7 Scotch Bonnet Red.

Once the fruit had matured on the plants in the field, a single harvest of 25 random mature fruits from at least 10 plants in each replication was bulked. After harvest, the sample was dried and ground. The extraction of the capsaicinoids and the estimation of capsaicinoid amounts followed the high performance liquid chromatography (HPLC) procedures for the short run method as described by Collins et al. (1995). The HPLC data were converted

from parts per million to SHU by multiplying the parts per million by 16 (Bosland and Baral, 2007). The environment is known to affect the heat level of chilli pepper cultivars (Harvell and Bosland, 1997). Having a replicated field trial with standard control cultivars allows for a better comparison of heat levels among cultivars.

Capsaicin content in dried samples of each chilli peppers was determined on the basis of compliance with the

standard of capsaicin using HPLC. Figure 1 shows a chromatogram of standard of capsaicin determination by HPLC using the optimized conditions described above. The highest peak in the chromatogram represents the standard of capsaicin at a wavelengths of 254 nm and 280 nm. The absorbance for standards of capsaicin have been used in preparation of the calibration curve. The results for the concentration of capsaicin in the analysed samples were calculated using the equation $y = 0,0009x$ (μg).

In Table 1 are ranked dried chilli pepper according to capsaicin and dihydrocapsaicin content in extract expressed as $\mu\text{g}\cdot\text{mL}^{-1}$. Capsaicin content after drying has been increased 4 – 10 fold compared to fresh chilli peppers.

In Table 2 are ranked dried chili pepper according to capsaicin content expressed as SHU units ($18 \times \mu\text{g}\cdot\text{g}^{-1}$) calculated from capsaicin concentration given in Table 2 and after correction of extraction yield (90%).

The results of the analysis for Bhut Jolokia indicated that it possessed an extremely high heat level, 1 001 304 SHUs, whereas Habanero Red Savina recorded a heat level of 248 556 SHUs. Independent tests confirmed this high level of heat for Bhut Jolokia with 927 199 SHUs and 879 953 SHUs from Southwest Bio-Laboratories and Ag-Biotech, respectively (Bosland and Baral, 2007). The results of Bhut Jolokia heat level have been higher compared to our results. The aim of the next study was to determine the content of capsaicin and dihydrocapsaicin in *Capsicum* samples collected from city markets in Riyadh (Saudi Arabia), calculate their pungency in Scoville heat units (SHU) and evaluate the average daily intake of capsaicin for the population of Riyadh. The investigated samples consisted of hot chillies, red chillies, green chillies, green peppers, red peppers and yellow peppers. Extraction of capsaicinoids was done using ethanol as solvent, while high performance liquid chromatography (HPLC) was used for separation, identification and quantitation of the components. The limit of detection (LOD) of the method was 0.09 and 0.10 $\mu\text{g}\cdot\text{g}^{-1}$ for capsaicin and dihydrocapsaicin, respectively, while the limit of quantification (LOQ) was 0.30 and 0.36 $\mu\text{g}\cdot\text{g}^{-1}$ for capsaicin and dihydrocapsaicin, respectively. Hot chillies showed the highest concentration of capsaicin ($4\ 249 \pm 190.3 \mu\text{g}\cdot\text{g}^{-1}$) and the highest pungency level (67 984 SHU) comparable with our results for Bhut Jolokia (Al Othman et al., 2011).

Capsaicinoids are mainly ingested as naturally occurring pungency-producing components of *Capsicum* spices (chili, cayenne pepper, red pepper). Their concentrations typically range from 100 $\mu\text{g}\cdot\text{g}^{-1}$ in chili pepper to 2500 $\mu\text{g}\cdot\text{g}^{-1}$ in red pepper (Parrish, 1996). Pepper varieties from *Capsicum annum*, *C. frutescens* and *C. chinense* were found to contain 220 – 20 000 μg total capsaicinoids. $\cdot\text{g}^{-1}$ of dry weight (Thomas et al., 1998). In another study, cayenne pepper samples had mean capsaicin and dihydrocapsaicin contents of 1320 and 830 $\mu\text{g}\cdot\text{g}^{-1}$ dry weight, respectively (Lopez-Hernandez et al., 1996).

Capsaicinoids are synthesized exclusively in the epidermal cells of the placenta of *Capsicum* fruits and are accumulated in blisters along the epidermis. Their biosynthesis begins approximately 20 days postanthesis, with a number of enzymes being involved in the biosynthetic pathway. The degree of pungency depends on

the *Capsicum* species and cultivars, and the capsaicin and dihydrocapsaicin contents can be affected by different factors such as the developmental stage of the fruit and the environmental growth conditions (Garces-Claver et al., 2006). The biosynthesis of capsaicinoids occurs in the placenta, where the specialised epidermal cells accumulate in vacuoles and excrete on the inner surface of the seed and pericarp; therefore, the capsaicinoids should accumulate preferentially in the placenta rather than in the pericarp. The similar recent studies indicated that capsaicin is mostly located in vesicles or vacuole like sub-cellular organelles of epidermal cells of placenta in the pod. The highest concentrations of capsaicin are found in the ovary and in the lower flesh (tip) and the lowest content of capsaicin can be found in the seeds. The gland on the placenta of the fruit produces capsaicinoids. The seeds are not the source of pungency but they occasionally absorb capsaicin because they are in close proximity to the placenta. No other plant part produces capsaicinoids. The majority, about 89%, of the capsaicin is associated with the placental partition of the fruit and nearly 5 – 6% in the pericarp and the seed. Composition of capsaicin may vary among different varieties of same species and with fruit of a single variety (Arora et al., 2011). A likely explanation for our findings is that the presence of capsaicinoids in the pericarp suggests that capsaicinoids are translocated from the placenta to the pericarp tissue via the cell walls of the epidermal layer of the placenta. Removing of placenta and less likely environmental factors are obviously the reasons why the capsaicin concentration in our chillies is lower.

In our study no antibacterial and antifungal activity of capsaicin and dihydrocapsaicin against selected reference and terrain strains of bacteria and moulds was found. Sterile filter paper discs were impregnated with extracts, and placed on the agar plate, but no inhibition was subsequently observed and measured. Kim et al. (1995) tested the bactericidal activity of carvacrol [2-methyl-5-(1-methylethyl)phenol], geraniol (3,7dimethyl-2,6-octadien-1-ol) and citral (3,7dimethyl-2,6-octadienal) against *S. typhimurium* inoculated on fish cubes and reported that carvacrol at 3% killed the inoculated bacteria, while geraniol killed most of the bacteria and citral killed the least. From this work, it was concluded that the carvacrol showed to be a better antimicrobial. It is noteworthy that this substance is a phenol derivate, such as 3-hydroxycinnamic acid (coumaric acid) which has been reported by Dorantes et al. (2000). Capsaicin and dihydrocapsaicin (responsible for chilli pepper pungency) in the concentrations used in this study did not show an inhibitory effect on the growth of bacteria. It can be seen that *m*-coumaric and cinnamic acids are responsible for the inhibitory action of the four bacteria. It These findings agree with the fact that habanero pepper, which has the highest capsaicin content, was the least effective as a bacterial inhibitor (results not shown). On the other hand, pimiento morrón extract which contains both *m*-coumaric and cinnamic acids but no capsaicins, showed a good inhibitory action on the four bacteria tested. Among the bacteria tested *L. monocytogenes* was the most sensitive to the three chilli extracts, while the most resistant was *S. typhimurium*.

CONCLUSION

From a practical point of view, planting of four varieties of chilli peppers Habanero and Bhut Jolokia, Fatalii Yellow, Scotch Bonnet Red was successfully completed. After harvesting and drying, dried chilli peppers have been analysed by HPLC to determine the content of capsaicin and dihydrocapsaicin. Based on the results, the most pungent chilli pepper is Bhut Jolokia, which has a several times higher content of capsaicin and dihydrocapsaicin (802406 SHU) compared to Habanero Red Savina, Fatalii Yellow, other habaneros and Scotch Bonnet Red. There were found lower values in the content of capsaicin and dihydrocapsaicin, in contrast to the values reported by other studies. The pungency can be influenced with the weather conditions such as heat and it increases with the maturity of fruit. The great impact has also post harvesting processing such as removing of seeds and placenta when capsaicin content is decreased rapidly. Antimicrobial and antifungal activity of capsaicin and dihydrocapsaicin against selected strains of bacteria and moulds have not been proved. Based on the studies of various authors, extracts of pepper from ten different varieties of *Capsicum* contain phenylpropanoids and there were seven different compounds identified at varying concentrations depending on pepper variety (L-phenylalanine, t-cinnamic acid, o-coumaric acid, m-coumaric acid, ferulic acid, caffeic acid and capsaicin) which are intermediates of the capsaicinoids pathway. Non pungent varieties of chilli peppers, with major concentration of cinnamic and caffeic acids and without capsaicin content, presented the highest inhibitory effect. These results confirmed that bacteria are inhibited by some pepper extracts, and also that only some specific phenylpropanoids had a bacteriostatic effect.

REFERENCES

Al Othman, Z. A., Ahmed, Y. B., Habila, M. A., Ghafar, A. A. 2011. Determination of Capsaicin and Dihydrocapsaicin in Capsicum Fruit Samples using High Performance Liquid Chromatography. *Molecules*, vol. 16, no. 10, p. 8919-8929. <https://doi.org/10.3390/molecules16108919> PMID:22024959

Arora, R., Gill, N. S., Chauhan, G., Rana, A. C. 2011. An Overview about Versatile Molecule Capsaicin. A review article. *International Journal of Pharmaceutical Science and Drug Research*, vol. 3, no. 4, p. 280-286.

Bosland, P. W., Baral, J. B. 2007. Bhut Jolokia – The World’s Hottest Known Chile Pepper is a Putative Naturally Occurring Interspecific Hybrid. *HortScience*, vol. 42, no. 2, p. 222-224.

Collins, M. D., Wasmund, L. M., Bosland, P. W. 1995. Improved method for quantifying capsaicinoids in Capsicum using high-performance liquid chromatography. *Hort Science*, vol. 30, no. 1, p.137-139.

Deal, C. L., Schnitzer, T. J., Lipstein, E., Seibold, J. R., Stevens, R. M., Levy, M. D., Albert, D., Renold, F. 1991. Treatment of arthritis with topical capsaicin: A double-blind trial. *Clinical Therapeutics*, vol. 13, no. 3, p. 383-395. PMID:1954640

Dorantes, L., Colmenero, R., Hernandez, H., Motab, L., Jaramillo, M. E., Fernandez, E., Solano, C. 2000. Inhibition of growth of some foodborne pathogenic bacteria by Capsicum annum extracts. *International Journal of Food Microbiology*, vol. 57, no. 1-2, p. 125-128. [https://doi.org/10.1016/S0168-1605\(00\)00216-6](https://doi.org/10.1016/S0168-1605(00)00216-6)

Fattorusso, E., Tagliatela-Scafati, O. 2008. *Modern alkaloids: structure, isolation, synthesis and biology*. Weinheim : Wiley-VCH Verlag GmbH & Co. 689 p. ISBN: 978-3-527-31521-5.

Garces-Claver, A., Arnedo-Andres, M. S., Abadia, J., Gil-Ortega, R., Alvarez-Fernandez, A. 2006. Determination of Capsaicin and Dihydrocapsaicin in Capsicum Fruits by Liquid Chromatography-Electrospray/Time-of-Flight Mass Spectrometry. *Journal of Agricultural and Food Chemistry*, vol. 54, no. 25, p. 9303-9311. <https://doi.org/10.1021/jf0620261> PMID:17147411

Harvell, K. P., Bosland, P. W. 1997. The environment produces a significant effect on pungency of chiles (*Capsicum annum* L.). *HortScience*, vol. 32, no. 7, p. 1292.

Holzer, P. 1991. Capsaicin: cellular targets, mechanisms of action, and selectivity for thin sensory neurons. *Pharmacological Reviews*, vol. 43, no. 2, p. 143-201. PMID:1852779

Kempaiah, R. K., Manjunatha, H., Srinivasan, K. 2005. Protective effect of dietary capsaicin on induced oxidation of low-density lipoprotein in rats. *Molecular and Cellular Biochemistry*, vol. 275, no. 1-2, p. 7-13. <https://doi.org/10.1007/s11010-005-7643-3> PMID:16335782

Kim, K., Ryeom, K. 1979. A study on content and antibacterial effects of capsaicin from Korean hot pepper. *Report of the National Institute of Health*, vol. 16, 241-251.

Kim, J. M., Marshall, M. R., Cornell, J. A., Preston III, I. F., Wei, C. I. 1995. Antibacterial activity of carvacrol, citral and geraniol against Salmonella typhimurium in culture medium and on fish cubes. *Journal of Food Science*, vol. 60, no. 6, p. 1364-1368. <https://doi.org/10.1111/j.1365-2621.1995.tb04592.x>

Lopez-Hernandez, J., Oruna-Concha, M. J., Simal-Lozano, J., Gonzales-Castro, M. J., Vazquez-Blanco, M. E. 1996. Determination of capsaicin and dihydrocapsaicin in cayenne pepper and padron peppers by HPLC. *Deutsche Lebensmittel Rundschau*, vol. 92, p. 393-395.

López-Malo, A., Alzamora, S. M., Argais, A. 1998. Vanillin and pH synergistic effects on mould growth. *Journal of Food Science*, vol. 63, no. 1, p. 143-146. <https://doi.org/10.1111/j.1365-2621.1998.tb15695.x>

Morré, D. J., Morré, D. M. 2003. Synergistic Capsicum-tea mixtures with anticancer activity. *Journal of Pharmacy and Pharmacology*, vol. 55, no. 7, p. 987-994. <https://doi.org/10.1211/0022357021521> PMID:12906756

Nascimento, P. L. A., Nascimento, T. C. E. S., Ramos, N. S. M., Silva, G. R., Galindo Gomes, J. E., Falcão, R. E. A., Moreira, K. A., Porto, A. L. F., Silva, T. M. S. 2014. Quantification, Antioxidant and Antimicrobial Activity of Phenolics Isolated from Different Extracts of Capsicum frutescens (*Pimenta Malagueta*). *Molecules*, vol. 19, no. 4, p. 5434-5447. <https://doi.org/10.3390/molecules19045434> PMID:24879587

Parrish, M. 1996. Liquid chromatographic method of determining capsaicinoids in capsicums and their extractives: collaborative study. *Journal of AOAC International*, vol. 79, no. 3, p. 738-745.

Perucka, I., Oleszek, W. 2000. Extraction and determination of capsaicinoids in fruit of hot pepper *Capsicum annum* L. by spectrophotometry and high-performance liquid chromatography. *Food Chemistry*, vol. 71, no. 2, p. 287-291. [https://doi.org/10.1016/S0308-8146\(00\)00153-9](https://doi.org/10.1016/S0308-8146(00)00153-9)

Scoville, W. L., 1912: Note on Capsicum. *Journal of the American Pharmaceutical Association*, vol. 1, no. 5, p. 453-454. <https://doi.org/10.1002/jps.3080010520>

Serruti, P., Alzamora, S. M. 1996. Inhibitory effects of vanillin on some food spoilage yeast in laboratory media and fruit purees. *International Journal of Food Microbiology*, vol. 29, no. 2-3, p. 379-386. [https://doi.org/10.1016/0168-1605\(95\)00026-7](https://doi.org/10.1016/0168-1605(95)00026-7)

Szolcsanyi, J. 2004. Forty years in capsaicin research for sensory pharmacology and physiology. *Neuropeptides*, vol. 38, no. 6, p. 377-384. <https://doi.org/10.1016/j.npep.2004.07.005>
[PMid:15567473](https://pubmed.ncbi.nlm.nih.gov/15567473/)

Thomas, B. V., Schreiber, A. A., Weisskopf, C. P. 1998. Simple method for quantitation of capsaicinoids in peppers using capillary gas chromatography. *Journal of Agricultural and Food Chemistry*, vol. 46, no. 7, p. 2655-2663. <https://doi.org/10.1021/jf970695w>

Acknowledgments:

This work was supported by grant VEGA No. 1/0705/16.

Contact address:

Peter Popelka, University of Veterinary Medicine and Pharmacy in Košice, Department of Food Hygiene and Technology, Komenského 73, 041 81 Košice, Slovakia, E-mail: peter.popelka@uvlf.sk

Pavína Jevinová, University of Veterinary Medicine and Pharmacy in Košice, Department of Food Hygiene and Technology, Komenského 73, 041 81 Košice, Slovakia, E-mail: pavlina.jevinova@uvlf.sk

Karel Šmejkal, Veterinary and Pharmaceutical University in Brno, Faculty of Pharmacy, Department of Natural Drugs, Palackého tr. 1946/1, 612 42 Brno, Czech Republic E-mail: karel.mejkal@post.cz

Pavol Roba, University of Veterinary Medicine and Pharmacy in Košice, Department of Food Hygiene and Technology, Komenského 73, 041 81 Košice, Slovakia, E-mail: pavol.roba@uvlf.sk



ANTIMICROBIAL EFFECT OF SELECTED LACTIC ACID BACTERIA AGAINST MICROORGANISMS WITH DECARBOXYLASE ACTIVITY

Khatantuul Purevdorj, Kristýna Maršálková, Iva Březinová, Adéla Žalková, Pavel Pleva, Leona Buňková

ABSTRACT

The main purpose of this study was to evaluate the antimicrobial activity of twenty-one bacteriocinogenic lactic acid bacteria (12 strains of *Lactococcus lactis* subsp. *lactis*, 4 strains of *Lactobacillus gasser*, 3 strains of *Lb. helveticus* and 2 strains of *Lb. acidophilus*, LAB) against 28 *Staphylococcus* and 33 *Enterococcus* strains able to produce tyramine, putrescine, 2-phenylethylamine and cadaverine. The antimicrobial activity of cell-free supernatants (CFS) from tested LAB was examined by an agar-well diffusion assay. Nine out of twenty-one strains (33%) showed the inhibitory effect on tested enterococci and staphylococci, namely 9 strains of *Lactococcus lactis* subsp. *lactis*. The diameters of inhibition zones ranged between 7 mm and 14 mm. The biggest diameter of 14 mm inhibition was obtained with the CFS's from strains CCDM 670 and CCDM 731 on *Enterococcus* sp. E16 and E28. The cell-free supernatants from *Lactococcus lactis* subsp. *lactis* CCDM 71 and from *Lactococcus lactis* subsp. *lactis* CCDM 731 displayed the broadest antibacterial activity (52% inhibition of all tested strains). On the other hand, the cell-free supernatants from the screened *Lactobacillus* strains did not show any inhibitory effect on the tested *Staphylococcus* and *Enterococcus* strains. Nowadays, the great attention is given to the antibacterial substances produced by lactic acid bacteria. With the ability to produce a variety of metabolites displaying inhibitory effect, the LAB have great potential in biopreservation of food.

Keywords: biogenic amines; lactic acid bacteria; bacteriocins; nisin; *Enterococcus* spp.; *Staphylococcus* spp.

INTRODUCTION

Since ancient time, wild microorganisms naturally present in raw material has been played important role in food preservation (Galvéz et al., 2007). The lactic acid bacteria (LAB) have been used for centuries in the fermentation of food, not only for organoleptic properties (McAuliffe et al., 2001), but also as a natural competitor to other microorganisms that share the same niche (Reis et al., 2012). The antimicrobial activity of LAB is due to the production of metabolites such as organic acids (lactic and acetic acid), ethanol, diacetyl, hydrogen peroxide and carbon dioxide (Šušković et al., 2010; Reis et al., 2012; Cizeikiene et al., 2013). In addition, some strains are able to synthesize antimicrobial peptides known as bacteriocins and bacteriocin-like inhibitory substances (BLIS; Cleveland et al., 2001; Cizeikiene et al., 2013).

The bacteriocins produced by LAB are cationic amphiphilic molecules containing 20 to 60 amino acid residues (Chen and Hoover, 2003). These bacteriocins are thermostable and retained its activity in a wide range of pH values. Moreover, they are colorless, odorless, tasteless and they are easily digestible in the digestive tract and thus, they do not affect the composition of the intestinal

microflora (Perez et al. 2014). Nowadays, nisin is the only bacteriocin of gram-positive bacteria, which is approved by the European Food Safety Authority (EFSA) and the U.S. Food and Drug Administration (FDA) for use as a food preservative (EFSA, 2006). Nisin is a low-molecular-weight polypeptide (34 amino acids) with a pentacyclic structure containing one lanthionine and four β-methylanthionine residues (Ross et al., 2002). It is produced by *Lactococcus lactis* subsp. *lactis*, commonly found in milk and dairy products (Favaro et al., 2015). Therefore, it is non-toxic to humans and food containing nisin, can carry the label "preserved in a natural way" (Cleveland et al., 2001).

Biogenic amines (BA) are nitrogenous substances naturally occurring in living organisms, where they play an important role in many physiological processes (Silla Santos, 1996; Shalaby, 1996). On the other hand, their excessive intake due to the consumption of BA rich food may pose a potential health risk to the consumers (Gardini et al., 2016). The intake of BA can induce several digestive, circulatory and respiratory symptoms (Ladero et al., 2010).

In food, they are generally formed by microorganisms demonstrating decarboxylase activity from amino acids (Silla Santos, 1996; Shalaby, 1996, Ladero, 2010; Buňková et al., 2010). Therefore, microorganisms naturally present in raw materials, introduced throughout the processing or added as starter culture can critically influence BA production during the manufacture of fermented products (Bover-Cid et al., 2001). Enterococci and coagulase-negative staphylococci are commonly present in fermented dairy and meat products, where they can produce a large amount of BA (Martuscelli et al., 2000; Pleva et al., 2012; Buňková et al., 2012).

Most research works have focused on the isolation and characterisation of LAB with amino-oxidase activity (Dapkevicius et al., 2000; Fadda et al., 2001; García-Ruiz et al., 2011; Capozzi et al., 2012; Callejón et al., 2014). However, studies on inhibiting effect of bacteriocin-producing LAB on decarboxylase-positive bacteria are still lacking. Therefore, the main goal of this work was to evaluate the antimicrobial activity of cell-free supernatant from selected lactic acid bacteria against *Enterococcus* and *Staphylococcus* strains with decarboxylase activity.

MATERIAL AND METHODOLOGY

Tested microorganisms

The bacteriocin-producing lactic acid bacteria (12 strains of *Lactococcus lactis* subsp. *lactis*, 4 strains of *Lactobacillus gasserii*, 3 strains of *Lb. helveticus* and 2 strains of *Lb. acidophilus*) were obtained from Cultures Collection of Dairy Microorganisms Laktoflora® (CCDM; Czech Republic). The antimicrobial activity of the investigated cultures was tested against 28 *Staphylococcus* strains (8 strains of *S. warneri*, 4 strains of *S. haemolyticus*, 4 strains of *S. succinus*, 4 strains of *S. hominis*, 4 strain of *S. epidermidis*, 2 strains of *S. pasteurii* and 2 strains of *S. vitulinus*) and

33 *Enterococcus* strains (14 strains of *E. faecium*, 7 strains of *Enterococcus* sp., 6 strains of *E. durans*, 4 strains of *E. hirae* and 2 strains of *E. faecalis*) able to produce tyramine, putrescine, 2-phenylethylamine and cadaverine. Growth condition and origin of these isolates are displayed in Table 1. The strains were isolated from dairy and meat products (raw milk, cheese, pheasant meat, poultry and fish) in the Department of Environmental Protection Engineering of Faculty of Technology Tomas Bata University in Zlín. Some of these strains (isolated from pheasant meat) were described in previous study (Buňková et al., 2016).

Preparation of cell-free supernatants from LAB

The tested *Lactococcus* strains were cultivated in 10 mL M17 (Oxiod, United Kingdom) broth (1%, v/v) under aerobic condition at 30 °C for 72 h. The tested *Lactobacillus* strains were cultivated in 10 ml MRS (De Man, Rogosa and Sharpe; Merck, USA) broth (1%, v/v) under anaerobic condition at 37 °C for 72 h. After 72h cultivation, the cells were harvested by centrifugation at 10 000 x g for 15 min. The obtained cell-free supernatant (CFS) was adjusted to pH 6.0 ±0.2 with 10% NaOH in order to eliminate the inhibition effect due to organic acids (low pH) and was filtered through a membrane filter (0.22 µm pore size).

Agar-well diffusion test

The antimicrobial activity of selected lactic acid bacteria was tested by an agar well diffusion assay. The tested bacteria with decarboxylase activity were incubated in nutrient medium at appropriate temperature according Table 1 for 24 h. After incubation, the overnight cultures were serially diluted in 0.85% NaCl solution. Fraction (1 mL) of the dilution 10⁻² was plated in triplicate to a Petri dish and 20 mL of an appropriate medium (Table 1; HiMedia, India) was poured. A culture supernatant

Table 2 Tested strains with decarboxylase activity (AE – aerobic, MHB/A – Mueller-Hinton Broth/ Agar).

Microorganisms with decarboxylase activity		Growth condition	Origin
Strain	Name		
B: 151, 152, 153, 154, 160, 169	<i>Enterococcus durans</i>	30 C, AE, M-17	
B: 131, 142	<i>Enterococcus faecalis</i>	30 C, AE, M-17	
B: 129, 133, 143, 144, 145	<i>Enterococcus faecium</i>	30 C, AE, M-17	
B: 76, 122, 124, 147	<i>Enterococcus hirae</i>	30 C, AE, M-17	
B: 29	<i>Staphylococcus warneri</i>	37 C, AE, MHB/A	Pheasant meat
B: 40, 136, 137	<i>Staphylococcus epidermidis</i>	37 C, AE, MHB/A	
B: 47, 77, 80, 89	<i>Staphylococcus succinus</i>	37 C, AE, MHB/A	
B: 81, 82	<i>Staphylococcus vitulinus</i>	37 C, AE, MHB/A	
B: 138	<i>Staphylococcus hominis</i>	37 C, AE, MHB/A	
E: 2, 5, 8, 11, 13, 14, 17, 25, 27	<i>Enterococcus faecium</i>	30 C, AE, M-17	Raw milk, cheese
E: 15, 16, 18, 21, 26, 28, 30	<i>Enterococcus</i> sp.	30 C, AE, M-17	
S: 1, 2, 3, 13, 15, 16, 17	<i>Staphylococcus warneri</i>	37 C, AE, MHB/A	
S: 4, 14	<i>Staphylococcus pasteurii</i>	37 C, AE, MHB/A	
S: 5, 6, 7	<i>Staphylococcus hominis</i>	37 C, AE, MHB/A	Fish and poultry
S: 8	<i>Staphylococcus epidermidis</i>	37 C, AE, MHB/A	
S: 9, 10, 11, 12	<i>Staphylococcus haemolyticus</i>	37 C, AE, MHB/A	

(100 µL) was added to each well (6 mm in diameter) punched in the cooled agar plates and incubated for 24 – 48 h at the optimal growth temperature for inhibited bacteria. The antimicrobial activities of LAB were determined by measuring the inhibition zones (mm).

Statistical analysis

The obtained experimental data were analysed using a Statistical software Unistat 6.5 (Unistat, London, UK). The significance level of all statistical tests was set at $p < 0.05$.

RESULTS AND DISCUSSION

Inhibition effect of CFS on tested *Enterococcus* strains

Enterococci are known as ubiquitous bacteria and based on their association with the gastrointestinal tract, they often occur in foods of animal origin (Franz et al., 2011). *Enterococci*; due to their salt and pH tolerance, as well as their ability to grow over a wide range of temperature; can survive to the fermentation process and can be found in fermented foods such as sausages and cheeses (Bargossi et al., 2015). In these product, they can additionally produce a relevant amount of biogenic amines, especially tyramine (Suzzi and Gardini, 2003; Ladero et al., 2012; Jimenez et al., 2013).

In present work, twenty-one lactic acid bacteria able to produce nisin and bacteriocin like inhibitory substances (BLIS) were screened for their antimicrobial effect on 33 *Enterococcus* strains with decarboxylase activity. The data obtained from this experiment are demonstrated in Table 2. As can be seen in this table, out of 21 screened LAB

strains, 7 strains (33%) showed the inhibitory effect on tested enterococci, namely *Lactococcus lactis subsp. lactis* CCDM 71, CCDM 670, CCDM 686, CCDM 689, CCDM 695 and CCDM 698 and CCDM 731. The diameters of inhibition zones ranged between 7 mm and 14 mm (including diameter of well). The biggest diameter of 14 mm inhibition was obtained with the CFS's from strains CCDM 670 and 731 on strains E16 and E28 isolated from raw milk. The broadest antibacterial activity displayed CFS from *Lactococcus lactis subsp. lactis* CCDM 71 (85% inhibition of all tested strains) followed by CFS from *Lactococcus lactis subsp. lactis* CCDM 731 (82% inhibition) and *Lactococcus lactis subsp. lactis* CCDM 670 (82% inhibition). Similar study was carried out by Şanlıbaba et al. (2009) who studied the antimicrobial effect of *Lactococcus lactis subsp. lactis* LL27 isolated from Turkish raw milk. The CFS of this strain was found to show the inhibitory activity at different levels to 17 out of 23 indicator bacteria, namely, 9 strains of *L. lactis subsp. lactis*, 2 strains of *Enterococcus faecalis*, 1 strain of *Lactobacillus sakei*, 1 strain of *Lactobacillus plantarum*, 1 strain of *Pediococcus pentosaceus*, 1 strain of *Listeria innocua*, 1 strain of *Staphylococcus carnosus* and 1 strain of *Bacillus cereus*.

Enan et al. (2013) also reported the antibacterial activities of bacteriocinogenic strain *L. lactis subsp. lactis* Z11 isolated from Zabady (Arabian yoghurt). The inhibitory activity of cell-free supernatant of this strain inhibited other strains of lactic acid bacteria and some food-borne pathogens including *Listeria monocytogenes*, *Bacillus cereus* and *Staphylococcus aureus*.

In this study, the cell-free supernatants from the tested

Table 2 Antimicrobial activity of selected LAB strains against *Enterococcus* strains.

Strains	Inhibition effect of selected lactic acid bacteria*						
	CCDM 71	CCDM 670	CCDM 686	CCDM 689	CCDM 695	CCDM 698	CCDM 731
E2	++	+	++	++	+	++	++
E5	++	++	++	++	++	++	++
E8	++	++	++	++	++	++	++
E11	++	++	++	++	++	++	++
E13	+	+	++	++	++	+	+
E14	++	++	++	++	++	++	++
E15	++	++	++	++	+	++	++
E16	++	+++	++	++	++	++	++
E17	+	+	+	++	++	+	+
E18	++	++	+	++	++	++	++
E21	++	++	++	++	+	++	++
E25	++	++	++	++	++	++	++
E26	++	++	++	+	++	+	+
E27	+	+	+	+	+	++	+
E28	+	++	++	++	++	++	+++
E30	++	+	+	+	++	+	+
B76	+	+	-	-	-	+	+
B122	++	++	++	+	+	+	++
B129	++	++	++	+	+	+	++
B131	++	++	++	++	+	+	++
B133	++	++	++	+	+	+	+
B142	+	+	-	-	-	-	+
B143	+	-	+	-	-	-	-
B144	+	+	+	+	+	+	+
B147	+	+	-	-	-	-	+
B152	+	+	+	+	+	+	+
B154	+	+	+	+	+	+	+
B160	+	++	++	+	++	++	++

Note:*(-) no inhibition; (+) 7 – 10 mm inhibition zone; (++) 11 – 13 mm inhibition zone; (+++) 14 ≤mm inhibition zone.

Table 3 Antimicrobial activity of selected LAB strains against *Staphylococcus* strains.

Strains	Inhibition effect of selected lactic acid bacteria*								
	CCDM 71	CCDM 414	CCDM 418	CCDM 670	CCDM 686	CCDM 689	CCDM 695	CCDM 698	CCDM 731
B40	+	+	+	+	+	-	+	-	+
B138	+	+	+	+	+	-	-	-	+
S1	+	+	+	-	+	-	-	-	+
S4	-	+	+	-	-	-	-	-	-
S6	-	+	+	-	+	+	+	+	+
S7	-	+	+	-	-	-	-	-	-
S8	+	+	+	+	+	+	+	+	+
S9	-	++	+	-	-	-	-	-	-
S11	-	+	+	-	-	-	-	-	-
S12	-	++	+	-	-	-	-	-	-
S14	-	+	-	-	-	-	-	-	-
S17	-	+	-	-	-	-	-	-	-

Note: *(-) no inhibition; (+) 7–10 mm inhibition zone; (++) 11–13 mm inhibition zone; (+++) 14 ≤mm inhibition zone.

Lactobacillus strains did not show any inhibitory effect on the tested *Enterococcus* strains. This result is in disagreement with the results of study carried out by Xie et al. (2016). This study aimed to investigate the inhibitory effects of cell-free supernatant from *Lactobacillus plantarum* on four amine-positive bacteria, namely, *Enterobacter aerogenes*, *Enterobacter cloacae*, *Enterococcus faecium* and *Enterococcus faecalis*. Results showed that CFS from *L. plantarum* significantly reduced the cell growth and diamine production of all tested bacteria.

Study provided by Cizeikiene et al. (2013) also observed that CFS from BLIS-producer *Lactobacillus sakei* KTU05-6 isolated from spontaneous Lithuanian rye sourdoughs showed wide-ranging antimicrobial activities against gram-positive and gram-negative strains.

Among *Enterococcus* genus, *Enterococcus faecium* and *Enterococcus faecalis* are the main causative agents for serious relevant nosocomial infections such as urinary tract infections, endocarditis, bacteremia, intra-abdominal and intra-pelvic abscesses (Bhardwaj et al., 2013). In our study, the growth of *E. faecium* (E2, E5, E8, E11, E13, E14, E17, E25, E27, B129, B133 and B144) and the growth of *E. faecalis* B131 were effectively inhibited by all 7 strains displayed in Table 2. Among them, the strain *Lactococcus lactis subsp. lactis* CCDM 71 demonstrated a great inhibitory effect against 13 out of 14 strains of *E. faecium* and 2 out of 2 strains of *E. faecalis*.

In accordance with obtained results it can be concluded that strains isolated from raw milk were more sensitive to the antimicrobial metabolites produced by tested LAB than strains isolated from pheasant meat. The most resistant strain was *E. durans* (B151, B153 and B169).

Inhibition effect of CFS on tested *Staphylococcus* strains

The antimicrobial activity of tested lactic acid bacteria against the *Staphylococcus* strains is demonstrated in Table 3. As can be seen in this table, nine strains of *Lactococcus lactis subsp. lactis* (CCDM 71, CCDM 414, CCDM 418, CCDM 670, CCDM 686, CCDM 689, CCDM 695, CCDM 698 and CCDM 731) produced an inhibition zone against one or more *Staphylococcus* strains. The diameters of inhibition zones ranged between 7 mm and 12 mm (including diameter of well). The largest

inhibition zone of 12 mm in diameter was obtained with the cell-free supernatant from strain *Lactococcus lactis subsp. lactis* CCDM 414 on *S. haemolyticus* S9, isolate from fish. Moreover, the CFS from this strain displayed the broadest antibacterial activity against tested staphylococci including 2 strains of *S. epidermis*, 2 strains of *S. warneri*, 2 strains of *S. pasteurii*, 3 strains of *S. hominis* and 3 strains of *S. haemolyticus* (43% inhibition of all tested strains). Similar antibacterial spectrum showed also strain *L. lactis subsp. lactis* CCDM 418. Ten out of 28 strains were inhibited by this strain. The most sensitive strain was *S. epidermis* S8 inhibited by all 9 *Lactococcus* strains.

The antimicrobial activities of 5 *Lactococcus* strains (*L. garviae* K2, *L. piscium* SU4, *L. lactis subsp. cremoris* E22, *L. lactis subsp. hordinae* E91 and *L. plantarum* L7) against spoilage and pathogenic organisms were also studied by Olaoye (2016). The CFS of all 5 strains demonstrated an inhibition effect on growth of *Staphylococcus aureus*. The diameters of inhibition zones ranged between 1.5 mm and 2.5 mm. Also Lee et al. (2013) reported an inhibitory effect of *Lactococcus lactis* KU24 isolated from kimchi against methicillin-resistant *S. aureus* in their study. Same inhibitory effect against methicillin-resistant *S. aureus* was also displayed by *Lactobacillus acidophilus* and *Lactobacillus casei* (Karska-Wysocki et al., 2010). In present work, the cell-free supernatants from the screened lactobacilli did not show any inhibitory effect on the tested *Staphylococcus* strains.

In accordance with obtained results it can be concluded that strains isolated from fish were more sensitive to the antimicrobial metabolites produced by *Lactococcus* strains than isolates from pheasant meat and poultry. The most resistant strains were *S. warneri* (B29), *S. vitulinus* (B81 and B82) and *S. succinus* (B47, B77, B80 and B89).

CONCLUSION

The consumption of food containing large amounts of biogenic amines is potential health risk for some consumers. Therefore, a great effort is arising to prevent the formation and accumulation of these substances in foodstuffs, especially in fermented foods, where is their occurrence most common. The addition of selected starter cultures is one of the main tools able to prevent the

formation of high levels of BA in fermented meat and dairy products. According to the results presented above, it can be concluded that nine out of twenty-one *Lactococcus* strains demonstrated antimicrobial effect against tested *Enterococcus* and *Staphylococcus* strains. The use of bioprotective cultures producing bacteriocins or other antimicrobial substances needs greater attention due to their not fully explored potential in this field (Gardini et al., 2016).

REFERENCES

- Bargossi, E., Tabanelli, G., Montanari, Ch., Lanciotti, R., Gatto, V., Gardini, F., Torriani, S. 2015. Tyrosine decarboxylase activity of enterococci grown in media with different nutritional potential: tyramine and 2-phenylethylamine accumulation and tyrDC gene expression. *Frontiers in Microbiology*, vol. 6, p. 1-10. <https://doi.org/10.3389/fmicb.2015.00259> PMID:25914676
- Bhardwaj, S., Dhawale, K. B. J., Patil, M., Divase, S. 2013. *Enterococcus faecium* and *Enterococcus faecalis*, the nosocomial pathogens with special reference to multi-drug resistance and phenotypic characterization. *International Journal of Pharmaceutical Science and Practice*, vol. 2, no. 1, p. 1-10.
- Bover-Cid, S., Hugas, M., Izquierdo-Pulido a, M., Carmen Vidal-Carou, M. 2001. Amino acid-decarboxylase activity of bacteria isolated from fermented pork sausages. *International Journal of Food Microbiology*, vol. 66, no.3, p. 185-189. [https://doi.org/10.1016/S0168-1605\(00\)00526-2](https://doi.org/10.1016/S0168-1605(00)00526-2)
- Buňková, L., Buňka, F., Dráb, V., Kráčmar, S., Kubáň, V. 2012. Effects of NaCl, lactose and availability of oxygen on tyramine production by the *Enterococcus durans* CCDM 53. *European Food Research and Technology*, vol. 234, no.6, p. 973-979. <https://doi.org/10.1007/s00217-012-1714-y>
- Buňková, L., Buňka, F., Hlobilová, M., Vaňátková, Z., Nováková, D. 2009. Tyramine production of technological important strains of *Lactobacillus*, *Lactococcus* and *Streptococcus*. *European Food Research and Technology*, vol. 229, no. 3, p. 533-538. <https://doi.org/10.1007/s00217-009-1075-3>
- Buňková, L., Buňka, F., Mantlová, G., Čabalová, A., Sedláček, I., Švec, P., Pachlová, V., Kráčmar, S. 2010. The effect of ripening and storage conditions on the distribution of tyramine, putrescine and cadaverine in Edam-cheese. *Food Microbiology*, vol. 27, no. 7, p. 880-888. <https://doi.org/10.1016/j.fm.2010.04.014> PMID:20688229
- Buňková, L., Gál, R., Lorencová, E., Jančová, P., Doležalová, M., Kmet', V., Buňka, F. 2016. Microflora of farm and hunted pheasants in relation to biogenic amines production. *European Journal of Wildlife Research*, vol. 62, no. 3, p. 341-352. <https://doi.org/10.1007/s10344-016-1008-y>
- Callejón, S., Sendra, R., Ferrer, S., Pardo, I. 2014. Identification of a novel enzymatic activity from lactic acid bacteria able to degrade biogenic amines in wine. *Applied Microbiology and Biotechnology*, vol. 98, no. 1, p. 185-98. <https://doi.org/10.1007/s00253-013-4829-6> PMID:23515835
- Capozzi, V., Russo, P., Ladero, V., Fernández, M., Fiocco, D., Alvarez, M., Grieco, F., Spano, G. 2012. Biogenic amines degradation by *Lactobacillus plantarum*: toward a potential application in wine. *Frontiers in Microbiology*, vol. 3, p. 122. <https://doi.org/10.3389/fmicb.2012.00122> PMID:22485114
- Chen, H., Hoover, D. G. 2003. Bacteriocins and their food applications. *Comprehensive Reviews in Food Science and Food Safety*, vol. 2, no. 3, p. 82-100. <https://doi.org/10.1111/j.1541-4337.2003.tb00016.x>
- Cizeikiene, D., Juodeikiene, G., Paskevicius, A., Bartkiene, E. 2013. Antimicrobial activity of lactic acid bacteria against pathogenic and spoilage microorganism isolated from food and their control in wheat bread. *Food Control*, vol. 31, no. 2, p. 539-545. <https://doi.org/10.1016/j.foodcont.2012.12.004>
- Cleveland, T. J., Montville, I. F., Nes, M. L. Chikindas, M. L. 2001. Bacteriocins: Safe, natural antimicrobials for food preservation. *International Journal of Food Microbiology*, vol. 71, no. 1, p. 1-20. [https://doi.org/10.1016/S0168-1605\(01\)00560-8](https://doi.org/10.1016/S0168-1605(01)00560-8)
- Dapkevicius, M. L.N. E., Nouta, M. J. R., Rombouts, F. M., Houben, J. H., Wymenga, W. 2000. Biogenic amine formation and degradation by potential fish silage starter microorganisms. *International Journal of Food Microbiology*, vol. 57, no. 1-2, p. 107-114. [https://doi.org/10.1016/S0168-1605\(00\)00238-5](https://doi.org/10.1016/S0168-1605(00)00238-5)
- EFSA, 2006. Question number EFSA-Q-2005-031. Opinion of the Scientific Panel on Food Additives, Flavours, Processing Aids and Materials in Contact with Food on a request from the Commission related to the use of nisin (E 234) as a food additive [online] The EFSA Journal, vol. 314, p. 1-16 [cit. 2017-2-09] Available at: https://www.efsa.europa.eu/sites/default/files/scientific_output/files/main_documents/314.pdf.
- Enan, G., Abdel-Shafi, S., Ouda, S., Negm, S. 2013. Novel Antibacterial Activity of *Lactococcus Lactis Subspecies Lactis* Z11 Isolated from Zabady. *International Journal of Biomedical Science*, vol. 9, no. 3, p. 174-180. PMID:24151453
- Fadda, S., Vignolo, G., Oliver, G. 2001. Tyramine degradation and tyramine/histamine production by lactic acid bacteria and Kocuria strains. *Biotechnology Letters*, vol. 23, 2015-2019. <https://doi.org/10.1023/A:1013783030276>
- Favaro, L., Penna, A. L. B., Todorov, S. D. 2015. Bacteriocinogenic LAB from cheeses – Application in biopreservation? *Trends in Food Science & Technology*, vol. 41, no. 1, p. 37-48. <https://doi.org/10.1016/j.tifs.2014.09.001>
- Franz, C. M., Huch M., Abriouel, H., Holzapfel, W., Gálvez, A. 2011. Enterococci as probiotics and their implications in food safety. *International Journal of Food Microbiology*, vol. 151, no. 2, p. 125-140. <https://doi.org/10.1016/j.ijfoodmicro.2011.08.014> PMID:21962867
- Gálvez, A., Abriouel, H., López, R. L., Ben Omar, N. 2007. Bacteriocin-based strategies for food biopreservation. *International Journal of Food Microbiology*, vol. 120, no. 1-2, p. 51-70. <https://doi.org/10.1016/j.ijfoodmicro.2007.06.001> PMID:17614151
- García-Ruiz, A, González-Rompinelli, E. M., Bartolomé, B., Moreno-Arribas, M. V. 2011. Potential of wine-associated lactic acid bacteria to degrade biogenic amines. *International Journal of Food Microbiology*, vol. 148, no. 2, p. 115-120. <https://doi.org/10.1016/j.ijfoodmicro.2011.05.009> PMID:21641669
- Gardini, F., Özogul, Y., Suzzi, G., Tabanelli, G., Özogul, F. 2016. Technological Factors Affecting Biogenic Amine Content in Foods: A Review. *Frontiers in Microbiology*, vol. 7, p. 1-18.
- Jiménez, E., Ladero, V., Chico, I., Maldonado-Barragán, A., López, M., Martín, V., Fernández, L., Fernández, M., Álvarez, M. A., Torres, C., Rodríguez, J. M. 2013. Antibiotic resistance, virulence determinants and production of biogenic amines among enterococci from ovine, feline, canine, porcine

- and human milk. *BMC Microbiology*, vol. 13, p. 288. <https://doi.org/10.1186/1471-2180-13-288>
PMid:24325647
- Karska-Wysockib, B., Bazoja, M., Smoragiewicz, W. 2010. Antibacterial activity of *Lactobacillus acidophilus* and *Lactobacillus casei* against methicillin-resistant *Staphylococcus aureus* (MRSA). *Microbiological Research*, vol. 165, no. 8, p. 674-686. <https://doi.org/10.1016/j.micres.2009.11.008>
PMid:20116228
- Ladero V., Fernández M., Calles-Enríquez M., Sánchez-Llana E., Cañedo E., Martín M. C., Alvarez, M. A. 2012. Is the production of the biogenic amines tyramine and putrescine a species-level trait in enterococci? *Food Microbiology*, vol. 30, no. 1, p. 132-138. <https://doi.org/10.1016/j.fm.2011.12.016>
PMid:22265293
- Ladero, V., Calles, M., Ferná'ndez, M., Alavrez, M. 2010. Toxicological Effects of Dietary Biogenic Amines. *Current Nutrition and Food Science*, vol. 6, no. 2, p. 145-156. <https://doi.org/10.2174/157340110791233256>
- Lee, N.-K., Jin Han, E., Jun Han, K., Paik, H.-D. 2013. Antimicrobial Effect of Bacteriocin KU24 Produced by *Lactococcus lactis* KU24 against Methicillin-Resistant *Staphylococcus aureus*. *Journal of Food Science*, vol. 78, no. 3, p. M465-M469. <https://doi.org/10.1111/1750-3841.12053>
PMid:23398212
- Martuscelli, M., Crudele, M. A., Gardini, F., Suzzi, G. 2000. Biogenic amine formation and oxidation by *Staphylococcus xylosus* strains from artisanal fermented sausages. *Letters in Applied Microbiology*, vol. 31, no. 3, p. 228-232. <https://doi.org/10.1046/j.1365-2672.2000.00796.x>
PMid:10972734
- McAuliffe, O., Ross, R. P., Hill, C. 2001. Lantibiotics: structure, biosynthesis and mode of action. *FEMS Microbiology Reviews*, vol. 25, no. 3, p. 285-308. <https://doi.org/10.1111/j.1574-6976.2001.tb00579.x>
PMid:11348686
- Olaoye, O. A. 2016. Antimicrobial Activities of Five Strains Of *Lactococcus* Isolated from Beef Against Indicator Organisms of Public Health Significance. *Turkish Journal of Agriculture – Food Science and Technology*, vol. 4, no. 10, p. 887-892.
- Perez, R. H., Zendo, T., Sonomoto, K. 2014. Novel bacteriocins from lactic acid bacteria (LAB): various structures and applications. *Microbial Cell Factories*, vol. 13, no. Suppl 1, p. S3.
- Pleva, P., Buňková, L., Lauková, A., Lorencová, E., Kubáň, V., Buňka, F. 2012. Decarboxylation activity of enterococci isolated from rabbit meat and staphylococci isolated from trout intestines. *Veterinary Microbiology*, vol. 159, no. 3-4, p. 438-442. <https://doi.org/10.1016/j.vetmic.2012.04.028>
PMid:22608104
- Reis, J. A., Paula A. T., Casarotti, S. N., Penna, A. L. B. 2012. Lactic Acid Bacteria Antimicrobial Compounds: Characteristics and Applications. *Food Engineering Reviews*, vol. 4, no. 2, p. 124-140. <https://doi.org/10.1007/s12393-012-9051-2>
- Ross, R. P., Morgan, S., Hill, C. 2002. Preservation and fermentation: past, present and future. *International Journal of Food Microbiology*, vol. 79, no. 1-2, p. 3-16. [https://doi.org/10.1016/S0168-1605\(02\)00174-5](https://doi.org/10.1016/S0168-1605(02)00174-5)
- Şanlıbaba, P., Akkoç, n., Akçelik, M. 2009. Identification and Characterisation of Antimicrobial Activity of Nisin A Produced by *Lactococcus lactis* subsp. *lactis* LL27. *Czech Journal of Food Sciences*, vol. 27, p. 55-64.
- Santos, M. H. S. 1996. Biogenic amines: their importance in foods. *International Journal of Food Microbiology*, vol. 29, no. 2-3, p. 213-231. [https://doi.org/10.1016/0168-1605\(95\)00032-1](https://doi.org/10.1016/0168-1605(95)00032-1)
- Shalaby, A. R. 1996. Significance of biogenic amines to food safety and human health. *Food Research International*, vol. 29, no. 7, p. 675-690. [https://doi.org/10.1016/S0963-9969\(96\)00066-X](https://doi.org/10.1016/S0963-9969(96)00066-X)
- Šušković, J., Kos, B., Beganović, J., Pavunc, A. L., Habjanič, K., Matošić, S. 2010. Antimicrobial activity – The most important property of probiotic and starter lactic acid bacteria. *Food Technology and Biotechnology*, vol. 48, no. 3, p. 296-307.
- Suzzi, G., Gardini, F. 2003. Biogenic amines in dry fermented sausages: a review. *International Journal of Food Microbiology*, vol. 88, no. 1, p. 41-54. [https://doi.org/10.1016/S0168-1605\(03\)00080-1](https://doi.org/10.1016/S0168-1605(03)00080-1)
- Xie, Ch., Wang, H., Deng, Sh., Xu, X. 2016. The inhibition of cell-free supernatant of *Lactobacillus plantarum* on production of putrescine and cadaverine by four amine-positive bacteria in vitro. *LWT - Food Science and Technology*, vol. 67, p. 106-111. <https://doi.org/10.1016/j.lwt.2015.11.028>

Acknowledgments:

This work was supported from the Internal Grant of Tomas Bata University in Zlín (No. IGA/FT/2017/003).

Contact address:

Khatantuu Purevdorj, Tomas Bata University in Zlín, Faculty of Technology, Department of Environmental Protection Engineering, Vavrečkova 275, 760 01, Zlín, Czech Republic, E-mail: tuul@seznam.cz

Kristýna Maršálková, Tomas Bata University in Zlín, Faculty of Technology, Department of Environmental Protection Engineering, Vavrečkova 275, 760 01, Zlín, Czech Republic, E-mail: marsalkova@ft.utb.cz

Iva Březinová, Tomas Bata University in Zlín, Faculty of Technology, Department of Food Technology, Vavrečkova 275, 760 01, Zlín, Czech Republic, E-mail: brezinovaiva.12@seznam.cz

Adéla Žalková, Tomas Bata University in Zlín, Faculty of Technology, Department of Food Technology, Vavrečkova 275, 760 01, Zlín, Czech Republic, E-mail: adela.zalkova@gmail.com

Pavel Pleva, Tomas Bata University in Zlín, Faculty of Technology, Department of Environmental Protection Engineering, Vavrečkova 275, 760 01, Zlín, Czech Republic, E-mail: ppleva@ft.utb.cz

Leona Buňková, Tomas Bata University in Zlín, Faculty of Technology, Department of Environmental Protection Engineering, Vavrečkova 275, 760 01, Zlín, Czech Republic, E-mail: bunkova@ft.utb.cz



QUALITY DETERMINATION OF VEGETABLE OILS USED AS AN ADDITION TO FERMENTED MEAT PRODUCTS WITH DIFFERENT STARTER CULTURES

Hana Šulcerová, Tomáš Gregor, Radka Burdychová

ABSTRACT

There were developed samples of fermented meat products of „Mettwurst“ with an addition of a starter culture *pentosaceus* AS-3/100 or probiotic culture *Lactobacillus casei* Lc-01 and its combinations for this thesis. A part of animal fat was replaced with vegetable oils – sunflower oil and rapeseed oil. For comparison, there was also used a sample without an addition of vegetable oil. There were determined the characteristics of fats in samples: saponification value, acidity value, esteric, iodine and peroxide value. The samples were determined on the day of production and always once a week in a period of three following weeks. Every single sample was hereby determined 3 times. According to the results, it is more advantageous to use the samples with sunflower oil with an addition of specific cultures *Lactobacillus casei* Lc-01 and *Pediococcus pentosaceus* AS-3/100. The saponification value when adding sunflower oil detects that the quality of fat remains stable till the 14th day of storage ($p < 0.05$). The comparison of acid value detects that a sample with sunflower oil and culture *Pediococcus pentosaceus* AS-3/100 is more advantageous due to fast acidification in the first half of storage period. Good results of iodine and peroxide value had the variation of a sample with sunflower oil and a combination of both cultures. The variation of peroxide value maintained the lowest values. By using the samples with sunflower oil and unispecific cultures *L. casei* Lc-01 and *P. pentosaceus* AS-3/100, the culture *P. pentosaceus* AS-3/100, which remained stable till the 14th day of production, reached the best values of peroxide value. The sunflower oil is in spite of high content of PUFA more stable to which also contributes the increased content of vitamin E that works as an antioxidant here. The disadvantage of rapeseed oil is its higher susceptibility to oxidation. For reasons of faster decomposition of vegetable oils would be essential to cut down on the minimum durability. From the 14th day of storage, the content of free FA increases and the fat is still considerably quickly oxidized. The content of unsaturated FA, of which the vegetable fat is a source, quickly decreases. The sensory quality simultaneously decreases, too.

Keywords: Mettwurst; lactic acid bacteria; probiotics; human health; animal fat

INTRODUCTION

The medical organizations all over the world suggest that the total intake of fats should be lower than 30% (Arhiara, 2006; Fernández-Ginés et al., 2005). They also recommend the reduction of intake of SFA (saturated fatty acids) and cholesterol which means the cardiovascular diseases prevention.

Fermented meat products as a „biologically preserved food“ have indispensable place in human nutrition (Campos et al., 2013; Vandendriessche, 2008). There is a complex of biochemical and physical reactions during the fermentation that results in significant changes in the properties of final products (Casaburi et al., 2007). Fermented sausages represent a special group of fermented products (Romero, 2013; Evans et al., 2004). They mature less than 14 days and their spreadability is given by a high fat content. By fermentation the pH drops to 5.6 or

5.4, products do not dry they are only smoked by cold smoke. The products are not very resistant to microbial development, especially when the chain of low temperature is violated (Buckenhuskes and Fischer, 2001; Rodel and Scheuer, 2001). The main raw materials for fermented meat products are pork and beef and pork lard. Selecting raw materials and processing technology can affect the amount of fat in meat products (Del Nobile et al., 2009). Opinions of the need to reduce the amount of fat in the diet associated with promotion of low-fat and also often high-calorie products still remain. Health is not only reduction of fat intake, but choosing the right fats. By changing the lipid content and profile could be improved nutritional quality of so-called Western diet (Arihara, 2006), because some studies have made efforts to replace animal fat with vegetable oils (Cáceres et al., 2008). Vegetable oils are liquid non-hydrogenated oil, and therefore do not contain significant amounts of trans fatty

acids (FA) (Scollan et al., 2006). Type of vegetable oil used in meat products influenced the composition of fatty acids. Vegetable oils are rich sources of MUFA (monosaturated fatty acids) and PUFA (poly-unsaturated fatty acids) and cholesterol-free. In addition to increasing the fatty acids in the products, vegetable oils contain other bioactive ingredients such as antioxidants (Pelser et al., 2007; Chasco et al., 1993). Important microorganisms in fermented sausages ripening quickly are mainly lactic acid bacteria of the genus *Lactobacillus* and *Pediococcus*. At the beginning of ripening the number is low however, it multiplies rapidly and pushes against competing microflora. Lactic acid bacteria play an important role in the production of fermented meat products (Mati et al., 2015; Tripathi and Giri, 2014). They participate in the creation of sensory active substances involved in the development of texture, color, smell and taste (Leroy and De Vuyst, 2004). Application of starter and probiotic

cultures in fermented products may provide additional opportunity to prevention by food pathogens in salami (Santos et al., 2017; Gioia et al., 2016; Mainar et al., 2016; Corbière Morot-Bizot et al., 2006). The aim of an addition of suitable probiotics is to increase the frequency and thus the competitiveness of such microorganisms, which has positive effects on human health (Ruiz-Movano et al., 2008).

The aim of this work was to determine quality and stability of fat in fermented meat products “Mettwurst” with an addition of different starter and probiotic culture for 21 days.

MATERIAL AND METHODOLOGY

Samples of spreadable fermented meat sausage „Mettwurst“ were used to determine the qualitative characteristics of fat. The basic composition of “Mettwurst” was pork and back fat (50%), beef (45%),



Figure 1 Emulsion rapeseed (left) and sunflower (right) oil.



Figure 2 Fermented „Mettwurst“ before heat treated.

Table 1 Combination of oils and microbial cultures in the samples of fermented meat product „Mettwurst“.

Samples	Sampling (days)				Used vegetable oils and microbial cultures
R/L.	0	7	14	21	rapeseed oil / <i>Lactobacillus casei</i> Lc-01
R/P.	0	7	14	21	rapeseed oil / <i>Pediococcus pentosaceus</i> AS-3/100
R/P.+L.	0	7	14	21	rapeseed oil / <i>Pediococcus pentosaceus</i> AS-3/100 + <i>Lactobacillus casei</i> Lc-01
S/L.	0	7	14	21	sunflower oil / <i>Lactobacillus casei</i> Lc-01
S/P.	0	7	14	21	sunflower oil / <i>Pediococcus pentosaceus</i> AS-3/100
S/P.+L.	0	7	14	21	sunflower oil / <i>Pediococcus pentosaceus</i> AS-3/100 + <i>Lactobacillus casei</i> Lc-01
control	0	7	14	21	control sample

sucrose (0.1%), nitrite salt (2.46%), 0.43% of ground black pepper, capsicum and garlic, starter culture *Pediococcus pentosaceus* AS-3/100 (Almi, Austria) (0.25%) and probiotics *Lactobacillus casei* (Sacco, Italy) (0.02%). The starter culture and probiotic culture were added to achieve 10^6 at minimum cfu.g⁻¹ in sausage mixture. Our samples were made of pork (side, leg, shoulder, in fat up to 5%), oil emulsions, nitrite salt (2.46%), food ingredients - Teewurst fein 12, BIO-ELEMNETA 161, BGP LYOFASST 93 (5 Dosi), starter culture *Pediococcus pentosaceus* AS-3/100 (Almi, Austria) in the amount of 0.25% and probiotic culture *Lactobacillus casei* Lc-01 (Sacco, Italy) in the amount of 0.02%. The samples were produced in combination with an addition of vegetable oils - sunflower oil Lukana (Setuza, JSC) and rapeseed oil Vita, cold pressed (P. Brandl GmbH) (Figure 1 and Figure 2). For comparison, a sample without an addition of vegetable oils was used as well (Table 1). The work was subsequently thrust into the guts with a diameter of 43 mm, type N43 Nalo Krans, each in quantities of 1 kg. The products were smoked by cold smoke in a temperature of 20 ± 0.5 °C intermittently for 2 days and stored in a temperature of 6 ± 0.5 °C. For each experimental and control group was made 20 kg of meat products in 1 kg pieces. Random sampling were selected 10 pieces from samples and control group and analysis were carried out in three replications after the production and after 7, 14 and 21 days of production.

Extraction

For extraction it was used Soxhlet extractor with petrolether (Sigma-Aldrich, USA) at 50 °C. The rest of petrolether in samples was evaporated by nitrogen (Linde, Czech Republic, purity 99.996%) at room temperature.

Saponification value

The saponification value is an amount of potassium hydroxide needed to neutralize the free and bound fatty acids in 1 g of fat. A sample is saponified by boiling with an excess of alcoholic potassium hydroxide solution and an excess of KOH was set by the back titrating with hydrochloric acid to phenolphthalein (Knothe, 2002).

Acid value

The acid value indicates the content of free fatty acids in fat and is expressed as an amount of potassium hydroxide required to neutralize 1 g of fat under the terms of the method. The sample was dissolved in hot ethanol and titrated with standard potassium hydroxide solution to phenolphthalein (Gunstone et al., 2007).

Ester value

The ester value is an amount of potassium hydroxide required to neutralize the ester-bound acids in 1 g fat.

Iodine value

The iodine value indicates an amount of iodine (mg) which is bound to 100 g fat under the terms of the method. It is a measure of the content of double bonds in fat and is used to assess its purity, identification of unknown lipids and the applicability for different purposes. Halogens are

requires to double bonds of unsaturated fatty acids. The reaction takes place in chloroform which acts as a fat solvent and acetic acid which provides the necessary environment polarity (Haryati et al., 1998).

Peroxide value

The peroxide value indicates an amount of hydroperoxides in fat which are able to oxidize iodide into iodine under the terms of the method. It is expressed in milligrams of oxygen in 1 kg of fat and is a suitable measure for the degree of oxidation of fats (Aksu et al., 2007).

Statistical analysis

The results were processed by using statistical functions in MS Excel to calculate the arithmetic mean and standard deviation. For the statistical evaluation method was used the method of linear regression ($p < 0.05$) in program Statistic CZ 12.0 by Duncan's test.

RESULTS AND DISCUSSION

The measured values of acid value of „Mettwurst“ with an addition of rapeseed and sunflower oil and cultures *Pediococcus pentosaceus* AS-3/100, *Lactobacillus casei* Lc-01 and their combinations for storage of 21 days from production are shown in Figure 3.

The samples with an addition of rapeseed oil with culture *Lactobacillus casei* Lc-01 and the mixed culture of *Pediococcus pentosaceus* AS-3/100+*Lactobacillus casei* Lc-01 show direct growing dependence of acid value of „Mettwurst“ ($p = 0.0006$; $r^2 = 0.1358$). The content of fatty acids in these two samples grows slowly, for the other combinations in which the content of free fatty acid significantly decreases or increases in steps in relation to the production of other metabolites, possibly due to enzyme degradation of fatty acids, which is reflected in the final stage of maturation (week 3rd) ($p < 0.05$). The content of free fatty acids in the samples with an addition of sunflower oil at a time abruptly decreases, increases and then decreases again, due to biochemical changes caused by enzymes. This trend is evident when using the culture of *Pediococcus pentosaceus* AS-3/100. The most significant changes in free fatty acids between the first and the third week of storage recorded the sample with the addition of sunflower oil and a combination of cultures *Pediococcus pentosaceus* AS-3/100+*Lactobacillus casei* Lc-01 ($p < 0.05$). The control sample used in animal fat has a higher resistance to enzymes ripening cultures. The slight reduction in acid value at the end of shelf life explains Koutsopoulos et al. (2008) in fermented sausages probably due to formation of ammonia and amines that arise by the reactions associated with the metabolism of free amino acids during proteolysis as well as enzymatic digestion of fatty acids. The measured values for the determination of saponification value of „Mettwurst“ with added sunflower oil and rapeseed oil and cultures *Pediococcus pentosaceus* AS-3/100, *Lactobacillus casei* Lc-01 and their combination for 21 days from production are shown in Figure 4.

Generally, the saponification value decreases at the last stages of storage with an increasing number of free fatty acids, which grows faster than in the sample without an

addition of vegetable ($p = 0.0014$; $r^2 = 0.1182$). The high saponification value characterizes the quality and no left fat. The reduction of the saponification value agrees with the study in which **Johansson et al. (1994)** states that the content of free MK was in the early ripening of sausages low (0.6%), gradually increased and at the end of storage (after 63 days) reached values of 6.8%. **Beriain et al. (2000)** evaluated the fermented sausages with added cultures *Pediococcus pentosaceus* and *Micrococcus varians* and states that the concentration of free FA has gradually increased since the beginning of measurements (raw materials) to the final product. The rapid increase was recorded during the two weeks of fermentation and indicated a high enzymatic activity in this phase. These results could reflect declining saponification value of „Mettwurst“. Statistically, it was demonstrated that the samples with the addition of rapeseed oil were not changed depending on the time ($p > 0.05$). When using sunflower oil, the saponification value statistically significantly decreases ($p < 0.05$) depending on the time only for a

sample with a combination of *Pediococcus pentosaceus* AS-3/100+*Lactobacillus casei* Lc-01 cultures.

The ester value as well as the saponification value decreases with an increasing number of free FA. When using vegetable oils in the second half of the shelf life values suddenly decrease. Nevertheless, when using only animal fats, the ester value gradually decreases suggesting a slower breakdown of fat (Figure 5).

When using sunflower oil, the ester value statistically significantly decreases ($p < 0.05$) depending on time only for a sample with a combination of cultures of *P. pentosaceus* AS-3/100 + *L. casei* Lc-01. Statistically, it has been demonstrated that the ester value of samples with the addition of rapeseed oil depending on the time change ($p = 0.0002$; $r^2 = 0.1590$). The measured values for iodine value determination of „Mettwurst“ samples with an addition of sunflower and rapeseed oils and cultures *P. pentosaceus* AS-3/100, *L. casei* Lc-01 and its combinations for 21 days of production are shown in Figure 6.

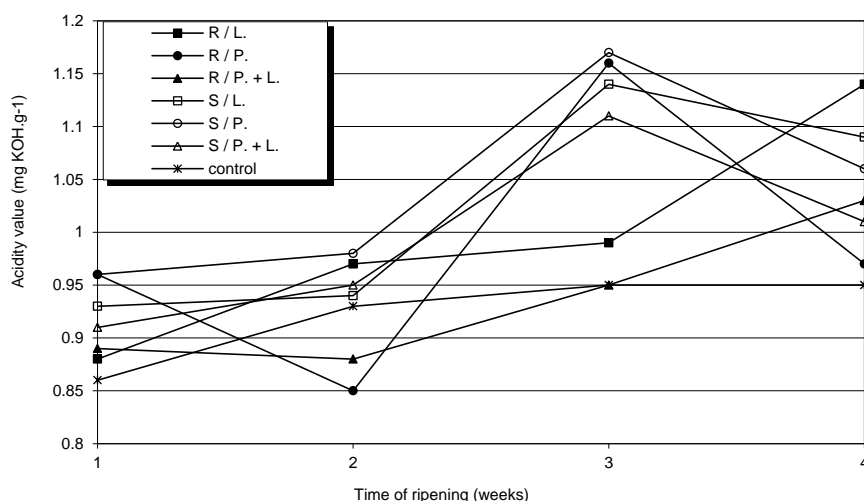

Figure 3 Acid value in mg KOH.g⁻¹ at the sample of „Mettwurst“ with an addition of sunflower and rapeseed oil depending on the time of ripening.

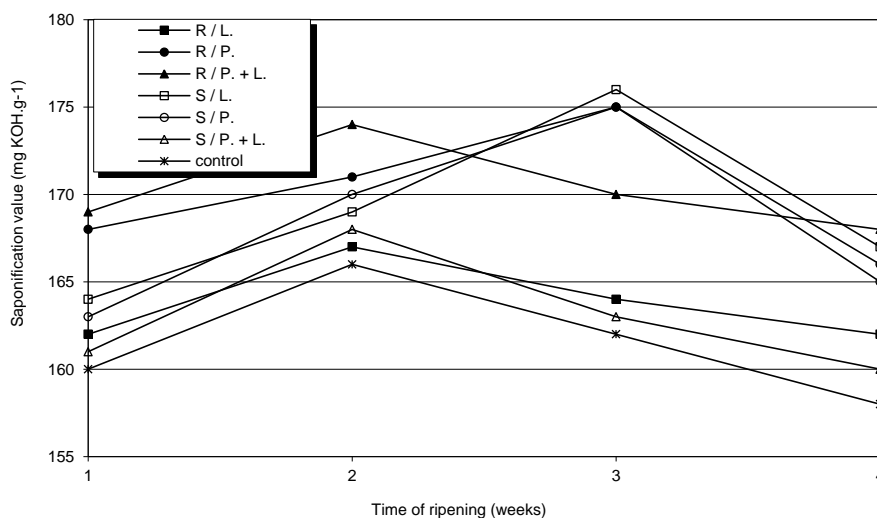

Figure 4 Saponification value KOH mg.g⁻¹ in the samples „Mettwurst“ with an addition sunflower and rapeseed oil depending on the time of ripening.

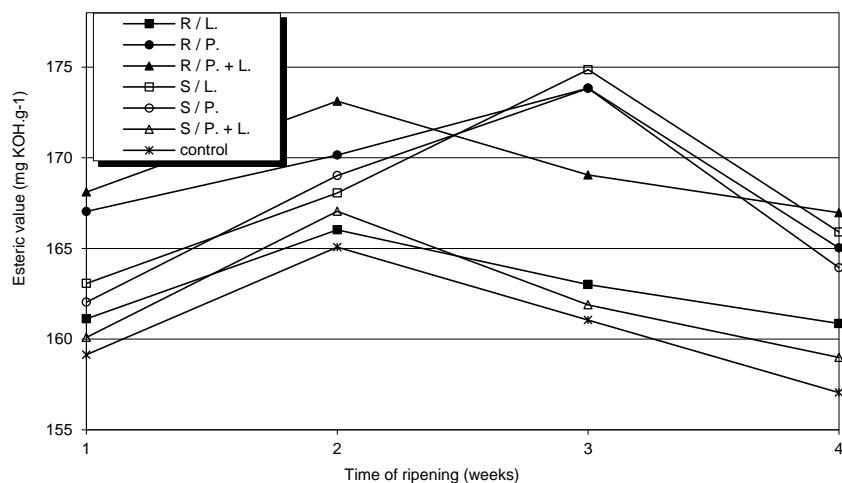

Figure 5 Esteric value mg KOH.g⁻¹ in the samples „Mettwurst“ with an addition sunflower and rapeseed oil depending on the time of ripening.

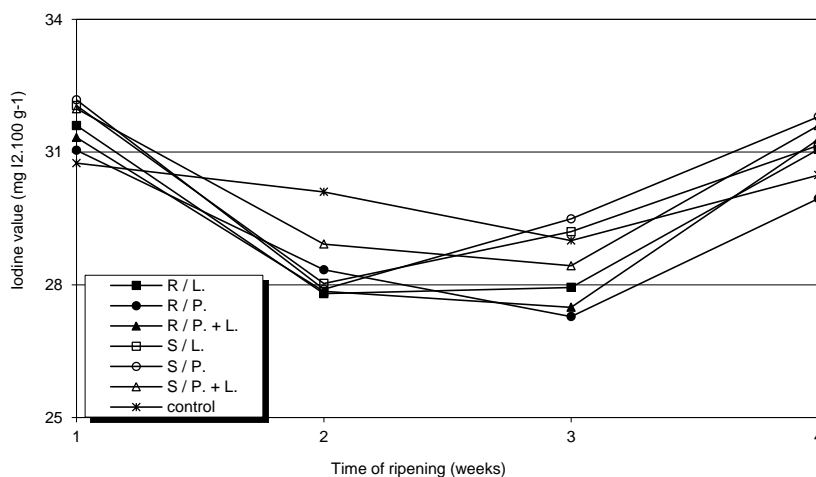

Figure 6 Iodine value mg I₂.100g⁻¹ in the samples „Mettwurst“ with an addition sunflower and rapeseed oil depending on the time of ripening.

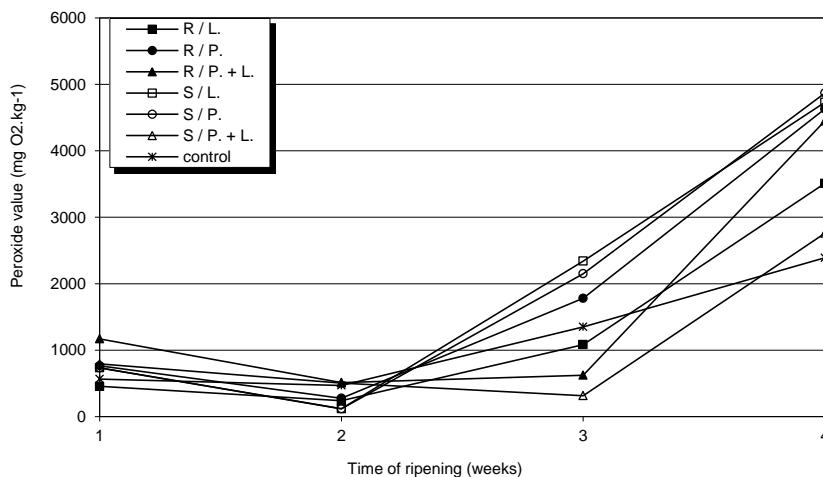

Figure 7 Peroxide value mg O₂.kg⁻¹ in the samples „Mettwurst“ with an addition sunflower and rapeseed oil depending on the time of ripening.

Iodine value during the first week of storage has plummeted, at the end of storage time again slightly increased ($p = 0.0033$; $r^2 = 0.1006$). This can be explained by the increase of oxy-labile substances during the storage, resulting starter and probiotic cultures. **Chasco et al. (1993)** in his work indicates that the initial fermentation is responsible for the increase of unsaturation, however, it varies later in the maturation of meat products. There is a reduction of MUFA and simultaneously an increase of the content of SFA. Oxidation processes particularly affect the unsaturated linoleic and oleic acid. These changes in unsaturation of lipid are reflected in the iodine value which shows the same behavior, increases with the development of microbial fermentation and decreases with maturation. Statistically, it has been shown that the iodine value for all samples depending on the time does not change ($p > 0.05$). The best values are achieved with a combination of sunflower oil with cultures *P. pentosaceus* AS-3/100+*L. casei* Lc-01 or the use of *L. casei* Lc-01 cultures. The most apparent change of samples was in the peroxide value during the storage of samples „Mettwurst“, (Figure 7).

The high and rapid increase of the peroxide value in samples of vegetable oils reflects easier oxidation of vegetable oils in comparison with the control sample made only from raw meat. Increasing peroxide value depending on the time for all samples was statistically significant ($p < 0.05$). Starter culture also affects the pH of the product, which length storage (fermentation) decreases. **Del Nobile et al. (2009)** shows the initial pH about 6.5 and decline to 5.0 after 22 days from production fermented sausages with the addition of extra virgin olive oil. The same changes also states **Bloukas et al. (1997)** in fermented meat products with a fat content of 25%. There were 10% and 20% lard replaced with olive oil in emulsion with the addition of soy protein isolate.

Auto-oxidation of unsaturated free fatty acids is one of the main reactions associated with the formation of volatile compounds. Some of them contribute to the specific flavor of meat products. **Ansorena and Astiasarán (2004)** demonstrated that it is possible to replace a part of the animal fat with vegetable oils containing n-3 fatty acids.

Pelser et al. (2007) in his work reduced the content of SFA by 20% in fermented sausage by adding of linseed oil and canola oil (*Brassica napus* var. *Napus*) compared to the control sample without an addition of vegetable oils. The low amount of palmitic and stearic acid in linseed and rapeseed oil is responsible for this effect. The products with linseed and rapeseed oil have increased the amounts of PUFA, especially sausages with linseed oil. The similar conclusions also stated **Ansorena and Astiasarán (2004)**. Peroxide value is higher in oils containing more n-3 FA due to easier oxidation (**Pelser et al., 2007**). That would explain larger values of peroxide in rapeseed oil which contains linoleic acid, unlike sunflower oil which contains almost no linoleic acid (**Gunstone et al., 2007**).

The susceptibility to oxidation of linolenic acid is 2.4 times higher than linoleic acid, linoleic acid is 40 times more reactive than oleic acid. The similar ratio of linolenic and linoleic acid would correspond with the results of the combination of cultures *P. pentosaceus* AS-3/100+*L. casei* Lc-01 between rapeseed and sunflower oil ($p < 0.05$).

When using sunflower oil, it is preferable to use a combination of cultures *P. pentosaceus* AS-3/100+*L. casei* Lc-01 for the lowest peroxide value. The most stable sample was the one with the culture of *L. casei* Lc-01 with an addition of rapeseed oil. From the perspective of a lower susceptibility to oxidation the use of sunflower oil, which suggests a lower value of peroxide of sunflower oil samples against samples with an addition of rapeseed oil, is more advantageous ($p = 0.0001$; $r^2 = 0.5737$).

Pelser et al. (2007) decreased the content of SFA by 20% in fermented salami. **Muguerza et al. (2001)** decreased in fermented salami the content of fat by 20% and 10% in the study (unlike the value of 30%) and replaced 20% of animal fat with olive oil. Reduction of the whole fats and the replacement of animal fat is hereby in meat products possible, however, it is essential to still perfect it. **Rubio et al. (2008)** and **Sheard et al. (2000)** reported that a high content of MUFAs and PUFAs causes greater susceptibility to oxidation and hence it is necessary to adjust the length of the shelflife and storage condition. Oxidation of lipids may affect the sensory characteristics of the products and participate in the creation of aroma, flavor, juiciness and texture **Muguerza et al. (2001)**.

CONCLUSION

The aim of this work was to determine quality of fat in fermented meat products “Mettwurst” with an addition of starter or probiotic culture and its combinations. Part of the animal fat has been replaced by sunflower and rapeseed oil. The determined characteristics of fats were saponification, acidity, ester, iodine and peroxide value. The samples were determined in a period of three following weeks. According to the result, using sunflower oil with culture *Pediococcus pentosaceus* AS-3/100 or *Lactobacillus casei* Lc-01 is preferable. Good results of peroxide value were reached also in „Mettwurst“ sausage with added sunflower oil and starter *P. pentosaceus* AS-3/100. It was fixed till 14th day from producing. This variation acidified the sample enough in the first week of storing. Due to faster decomposition of vegetable oils it would be appropriate to shorten the minimum shelf life. From the 14th day of the storage period, the content of free FA rises and the fat is rather rapidly oxidized ($p < 0.05$).

REFERENCES

- Aksu, M. I. 2007. The effect of alpha-tocopherol, storage time and storage temperature on peroxide value, free fatty acids and pH of kavurma in cooked meat product. *Journal of muscle foods*, vol. 18, no. 4, p. 370-379. <https://doi.org/10.1111/j.1745-4573.2007.00092.x>
- Ambrosiadis, J., Soutos, N., Abraham, A., Bloukas, J. G. 2004. Physicochemical, microbiological and sensory attributes for the characterization of Greek traditional sausages. *Meat Science*, vol. 66, no. 2, p. 279-287. [https://doi.org/10.1016/S0309-1740\(03\)00100-1](https://doi.org/10.1016/S0309-1740(03)00100-1)
- Ansorena, D., Astiasarán, I. 2004. The use of linseed oil improves nutritional quality of the lipid fraction of dry-fermented sausages. *Food Chemistry*, vol. 87, no. 1, p. 69-74. <https://doi.org/10.1016/j.foodchem.2003.10.019>
- Arihara, K. 2006. Strategies for designing novel functional meat products. *Meat Science*, vol. 74, no. 1, p. 219-229. <https://doi.org/10.1016/j.meatsci.2006.04.028> PMID:22062731

- Beriain, M. J., Lizaso, G., Chasco, J. 2000. Free amino acids and proteolysis involved in „salchichon“ processing. *Food Control*, vol. 11, no. 1, p. 41-47. [https://doi.org/10.1016/S0956-7135\(99\)00062-6](https://doi.org/10.1016/S0956-7135(99)00062-6)
- Bloukas, J. G., Paneras, E. D., Fournitzis, G. C. 1997. Effect of replacing pork backfat with olive oil on processing and quality characteristics of fermented sausages. *Meat Science*, vol. 45, no. 2, p. 133-144. [https://doi.org/10.1016/S0309-1740\(96\)00113-1](https://doi.org/10.1016/S0309-1740(96)00113-1)
- Buckenhuskes, H. J., Fischer, A. 2001. Investigation of the pretreatment of the raw material for fresh Mettwurst to improve the hygienic stability. *Fleischwirtschaft*, vol. 81, no. 3, p. 92-99.
- Cáceres, E., García, M. L., Selgas, M. D. 2008. Effect of pre-emulsified fish oil – as a source of PUFA n-3 – on microstructure and sensory properties of mortadella, a Spanish bologna-type sausages. *Meat Science*, vol. 80, no. 2, p. 183-193. <https://doi.org/10.1016/j.meatsci.2007.11.018> PMID:22063321
- Campos, S. D., Alves, R. C., Mendes, E., Costa, A. S. G., Casal, S., Oliveira, M. B. P. P. 2013. Nutritional value and influence of the thermal processing on a traditional Portuguese fermented sausage (alheira). *Meat Science*, vol. 93, no. 4, p. 914-918. <https://doi.org/10.1016/j.meatsci.2012.09.016> PMID:23122409
- Casaburi, A., Aristoy, M. C., Cavella, S., Di Monaco, R., Ercolini D., Toldrá F., Villani F. 2007. Biochemical and sensory characteristics of traditional fermented sausages of Vallo di Diano (Southern Italy) as affected by the use of starter cultures. *Meat Science*, vol. 76, no. 2, p. 295-307. <https://doi.org/10.1016/j.meatsci.2006.11.011> PMID:22064299
- Corbière Morot-Bizot, S., Leroy, S., Talon, R. 2006. Staphylococcal community of a small unit manufacturing traditional dry fermented sausages. *International Journal of Food Microbiology*, vol. 108, no. 2, p. 210-217. <https://doi.org/10.1016/j.ijfoodmicro.2005.12.006> PMID:16488037
- Del Nobile, M. A., Conte, A., Incoronato, A. L., Panza, O., Sevi, A., Marino, R. 2009. New strategies for reducing the pork back-fat content in typical Italian salami. *Meat Science*, vol. 81, no. 1, p. 263-269. <https://doi.org/10.1016/j.meatsci.2008.07.026> PMID:22063993
- Evans, J. A., Russell, S. L., James, CH., Corry, J. E. L. 2004. Microbial contamination of food refrigeration equipment. *Journal of Food Engineering*, vol. 60, no. 3, p. 225-232. [https://doi.org/10.1016/S0260-8774\(03\)00235-8](https://doi.org/10.1016/S0260-8774(03)00235-8)
- Fernández-Ginés, J. M., Fernández-López, J., Sayas-Barberá, I., Pérez-Álvarez, J. A. 2005. Meat products as functional Foods: a review. *Journal of Food Science*, vol. 70, no. 2, p. 37-43. <https://doi.org/10.1111/j.1365-2621.2005.tb07110.x>
- Gioia, D. D., Mazzola, G., Nikodinoska, I., Aloisio, I., Langerholc, T., Rossi, M., Raimondi, S., Melero, B., Rovira, J. 2016. Lactic acid bacteria as protective cultures in fermented pork meat to prevent *Clostridium* spp. Growth. *International Journal of Food Microbiology*, vol. 235, p. 53-59. <https://doi.org/10.1016/j.ijfoodmicro.2016.06.019> PMID:27400453
- Gunstone, F. D., Harwood, J. L., Dijkstra, A. J. 2007. *The Lipid Handbook*. California : CRC Press Taylor & Francis Group. 1472 p. ISBN 0-8493-9688-3.
- Haryati, T., Che Mana, Y. B., Ghazalia, H. M., Asbia, B. A., Buanab, L. 1998. Determination of Iodine Value of Palm Oil Based on Triglyceride Composition. *Journal of the American Oil Chemists' Society*, vol. 75, no. 7, p. 789-792. <https://doi.org/10.1007/s11746-998-0227-0>
- Chasco, J., Beriain, M. J., Bello, J. 1993. A Study of changes in the fat-content of some varieties of dry sausages during the curing process. *Meat Science*, vol. 34, no. 2, p. 191-204. [https://doi.org/10.1016/0309-1740\(93\)90027-F](https://doi.org/10.1016/0309-1740(93)90027-F)
- Johansson, G., Berdagué, J. L., Larsson, M., Tran, N., Borch, E. 1994. Lipolysis, proteolysis and formation of volatile components during ripening of a fermented sausage with *Pediococcus pentosaceus* and *Staphylococcus xylosus* as starter cultures. *Meat Science*, vol. 38, no. 2, p. 203-218. [https://doi.org/10.1016/0309-1740\(94\)90110-4](https://doi.org/10.1016/0309-1740(94)90110-4)
- Knothe, G. 2002. Structure Indices in FA Chemistry. How Relevant Is the Iodine Value? *Journal of the American Oil Chemists' Society*, vol. 79, no. 9, p. 847-854. <https://doi.org/10.1007/s11746-002-0569-4>
- Koutsopoulos, D. A., Koutsimanis, G. E., Bloukas, J. G. 2008. Effect of carrageenan level and packaging during ripening on processing and quality characteristics of low-fat fermented sausages produced with olive oil. *Meat science*, vol. 79, no. 1, p. 188-197. <https://doi.org/10.1016/j.meatsci.2007.08.016> PMID:22062612
- Leroy, F., De Vuyst, L. 2004. Lactic acid bacteria as functional starter cultures for the food fermentation industry. *Trends in Food Science & Technology*, vol. 15, no. 2, p. 67-78. <https://doi.org/10.1016/j.tifs.2003.09.004>
- Mainar, M. S., Xhaferi, R., Samapundo, S., Devlieghere, F., Leroya, F. 2016. Opportunities and limitations for the production of safe fermented meats without nitrate and nitrite using an antibacterial *Staphylococcus sciuri* starter culture. *Food Control*, vol. 69, p. 267-274. <https://doi.org/10.1016/j.foodcont.2016.04.056>
- Mati, M., Magala, M., Karovičová, J., Staruch, L. 2015. The influence of *Lactobacillus paracasei* lpc-37 on selected properties of fermented sausages. *Potravinarstvo*, vol. 9, 2015, no. 1, p. 58-65. <https://doi.org/10.5219/430>
- Muguerza, E., Gimeno, O., Ansorena, D., Bloukas, J. G., Astiasarán, I. 2001. Effect of replacing pork backfat with pre-emulsified olive oil on lepei fraction and sensory quality of Chorizo de Paloma – a traditional Spanish fermented sausages. *Meat Science*, vol. 59, no. 3, p. 251-258. [https://doi.org/10.1016/S0309-1740\(01\)00075-4](https://doi.org/10.1016/S0309-1740(01)00075-4)
- Pelsler, W. M., Linssen, J. P. H., Legger, A., Houben, J. H. 2007. Lipid oxidation in n-3 fatty acid enriched Dutch style fermented sausages. *Meat Science*, vol. 75, no. 1, p. 1-11. <https://doi.org/10.1016/j.meatsci.2006.06.007> PMID:22063405
- Rodel, W., Scheuer, R. 2001. Production of safe products – 1. Research into the stop of microorganisms of Teewurst by the example of *Escherichia coli*. *Fleischwirtschaft*, vol. 81, no. 12, p. 81-84.
- Romero, C., Romero, M., Doval, M., Judis, M. A. 2013. Nutritional value and fatty acid composition of some traditional Argentinean meat sausages. *Food Science and technology*, vol. 33, no. 1, p. 161-166. <https://doi.org/10.1590/S0101-20612013005000007>
- Rubio, B., Martínez, B., García-Cachán, M.D., Rovira, J., Jaime, I. 2008. Effect of the packaging method and the storage time on lipid oxidation and colour stability on dry fermented sausage *salchichón* manufactured with raw material with a high level of mono and polyunsaturated fatty acids. *Meat Science*, vol. 80, no. 4, p. 1182-1187. DOI: 10.5713/ajas.2013.13728. <https://doi.org/10.5713/ajas.2013.13728>

Ruiz-Movano, S., Martín, A., Benito, M. J., Nevado, F. P., De Guia Cordoba, A. 2008. Screening of lactic acid bacteria and bifidobacteria for potential probiotic use in Iberian dry fermented sausages. *Meat Science*, vol. 80, no. 3, p. 715-721. <https://doi.org/10.1016/j.meatsci.2008.03.011>
PMid:22063588

Santos, S. C., Fraqueza, M. J., Elias, M., Barreto, A. S., Semedo-Lemsaddek, T. 2017. Traditional dry smoked fermented meat sausages: Characterization of autochthonous enterococci. *LWT – Food Science and Technology*, vol. 79, p. 410-415. <https://doi.org/10.1016/j.lwt.2017.01.042>

Scollan, N., Hocquette, J. F., Nuernberg, K., Dannenberger, D., Richardson, I., Moloney, A. 2006. Innovation in beef production systems that enhance the nutritional and health value of beef lipids and their relationship with meat quality. *Meat Science*, vol. 74, no. 1, p. 17-33. <https://doi.org/10.1016/j.meatsci.2006.05.002>
PMid:22062713

Sheard, P. R., Enser, M., Wood, J. D., Nute, G. R., Gill, B. P., Richardson, R. I. 2000. Shelf life and quality of pork and pork products with raised n-3 PUFA. *Meat Science*, vol. 55, no. 2, p. 213-221. [https://doi.org/10.1016/S0309-1740\(99\)00145-X](https://doi.org/10.1016/S0309-1740(99)00145-X)

Vandendriessche, F. 2008. Meat products in the past, today and in the future. *Meat Science*, vol. 78, no. 1-2, p. 104-113. <https://doi.org/10.1016/j.meatsci.2007.10.003>
PMid:22062100

Tripathi, M. K., Giri, S. K. 2014. Probiotic functional foods: Survival of probiotics during processing and storage. *Journal of Functional Foods*, vol. 9, p. 225-241. <https://doi.org/10.1016/j.jff.2014.04.030>

Acknowledgments:

The results and outcomes were prepared using instrumentation funded from the Research and Development for Innovations Operational Programme, project CZ.1.05/4.1.00/04.0135 Teaching and Research Facilities for Biotechnological Disciplines and Extension of Infrastructure.

Contact address:

Ing. Hana Šulcerová, Ph.D., Mendel University in Brno, Faculty of AgriSciences, Department of Food Technology, Zemědělská 1, 613 00 Brno, Czech Republic, E-mail: hana.sulcerova@mendelu.cz

Ing. Tomáš Gregor, Ph.D., Mendel University in Brno, Faculty of AgriSciences, Department of Food Technology, Zemědělská 1, 613 00 Brno, Czech Republic, E-mail: tomas.gregor@mendelu.cz

Ing. Radka Burdychová, Ph.D., NutriAcademy, s r.o., Dolnopolní 894/8, 614 00 Brno, Czech Republic, E-mail: radka.burdychova@nutriacademy.cz



DOES APRICOT SEEDS CONSUMPTION CAUSE CHANGES IN HUMAN URINE?

*Eva Tušimová, Anton Kováčik, Marek Halenár, Katarína Michalcová, Katarína Zbyňovská,
Anna Kolesárová, Jana Kopčeková, Jozef Valuch, Adriana Kolesárová*

ABSTRACT

Natural substances, such as amygdalin, used in alternative medicine gained high popularity. Common people as well as patients with different diseases have almost unlimited access to various natural supplements. To protect human health, it is very important to study effect of these substances. Amygdalin is a cyanogenic glucoside derived from seeds of rosaceous plants, for example seeds of bitter almonds (*Prunus dulcis*), or apricot, cherry, apple, peach, plum, etc. It is a natural product that owns antitumor activity, it has also been used for the treatment of asthma, bronchitis, emphysema, leprosy and diabetes and produces a kind of antitussive and antiasthmatic effects. The present *in vivo* study was designed to reveal whether amygdalin in apricot seeds has got an effect on human urine composition, pH value and urine associated health status after six weeks of oral administration. The study group finally consisted of 34 healthy adult volunteers (21 females and 13 males). All participants were asked to consume 60 mg.kg⁻¹ body weight of bitter apricot seeds daily (approximately 3.0 mg.kg⁻¹ of amygdalin) during 6 weeks. During the experiment, three urine collections were carried out (first collection – at the beginning of the experiment; second collection – after 21 days; third collection – after 42 days). Quantification of urine calcium (Ca), magnesium (Mg), phosphorus (P), sodium (Na), potassium (K), chlorides (Cl⁻), urea and pH value after apricot seeds supplementation was performed. Statistical analysis of variance showed, that consumption of bitter apricot seeds during 42 days had a significant ($p < 0.01$) effect on amount of calcium excreted in urine, though this decrease shifted its level from elevated mean value in control collection into normal physiological range. Significant changes were observed in urea ($p < 0.05$) and phosphorus ($p < 0.01$) levels in urine after apricot seed ingestion, but gender was also considered to be a source of their variation.

Keywords: amygdalin; apricot seed; urine; minerals; urea

INTRODUCTION

Fruit and vegetable contain a significant amount of biologically active substances able to lower a risk of any type of cancer or other civilization diseases (Jakubcova et al., 2014; Mendelová et al., 2016). CN-containing glycosides and nitrilosides exist in thousands of plants including strawberries, alfalfa sprouts, spinach, pecans, and in particularly high concentration in apricot kernels and other seeds, thus responsible for their characteristically bitter taste. It should be noted that bitterness is an important sensory indicator of potently anti-inflammatory, yet potentially poisonous compounds (in excessive amounts) within a plant. Amygdalin and other glycosidic compounds were abundant in the diets of early humans, and are commonly eaten by animals in the wild; the dietary lack thereof may contribute to increased cancer rates observed not only in humans, but also domesticated animals (Sokolsky and Wargovich, 2012). Amygdalin,

D-mandelonitrile-β-D-glucoside-6-β-D-glucoside is a cyanogenic glucoside derived from seeds of rosaceous plants, for example seeds of bitter almonds (*Prunus dulcis*), or apricot, cherry, apple, peach, plum, etc. (Holzbecher et al., 1984; Chwalek and Plé, 2004; Santos Pimenta et al., 2014; Lee and Moon, 2016). Amygdalin C₂₀H₂₇NO₁₁, is composed of one molecule of benzaldehyde, two molecules of glucose and one molecule of hydrocyanic acid (Chang et al., 2006).

Amygdalin is a natural product that owns antitumor activity, less side effects and relatively low priced (Song and Xu, 2014). Besides the antitumor activity, amygdalin has also been used for the treatment of asthma, bronchitis, emphysema, leprosy and diabetes (Zhou et al., 2012). It is also decomposed by the action of β-D-glucosidase to yield hydrocyanic acid which stimulates the respiratory center reflexively and produces a kind of antitussive and

antiasthmatic effects (Badr and Tawfik, 2010; Lv et al., 2005).

Patients with cancer use complementary and alternative medicine frequently, up to 90% within one year at least part of their therapy (Gansler et al., 2008; Hunt et al., 2010). It is not surprising, that use of amygdalin is recently increasingly advocated as an anticancer therapy (Milazzo et al., 2011). It can be applied by apricot seed or tablet ingestion, or by intravenous administration (Moertel et al., 1982). Cyanide from amygdalin can be released by the action of beta-glucosidase or emulsin. Although these enzymes are not found in mammalian tissues, the human intestinal microflora appears to possess these or similar enzymes capable of effecting cyanide release resulting in human poisoning. For this reason amygdalin may be as much as 40 times more toxic by the oral route as compared with iv injection (Casarett et al., 1980). It was reported, that after consumption of apricot seeds, cyanide can be produced in high enough level to cause a potential chronic toxicity problem (Seigler, 1975), in another study Seghers et al. (2013) concluded that a daily intake of 70 apricot kernels during more than six weeks induces abnormal liver chemistry tests without other toxicity signs. However, in medicinal chemistry, there is a little distinction between a drug and poison, and the specific poisoning of cancer cells is also the basis of chemotherapy (Sokolsky and Wargovich, 2012).

Urine may be a waste product, but it contains an enormous amount of information (Delanghe and Speeckaert, 2014) and it have been studied extensively (Kirchmann and Pettersson, 1994; Karak and Bhattacharyya, 2011). Urine is composed of 91 – 96% water (Heinonen-Tanski, 2007), and the remainder can be characterized into inorganic salts, urea, organic compounds and organic ammonium salts (Putnam, 1971). Variation in its composition is caused by differences in physical exercise, environmental conditions, as well as water, salt and high protein intakes (Rose et al., 2015).

The present *in vivo* study was designed to reveal whether amygdalin in apricot seeds has got an effect on human urine composition, pH value and urine associated health status after six weeks of oral administration.

MATERIAL AND METHODOLOGY

Chemicals

Bitter apricot seeds were provided by Trasco (Žiar n. Hronom, Slovakia). Thin Layer Chromatography (TLC) was performed for the analysis of amygdalin content in bitter apricot seeds used in our experiment. Grinded apricot seeds (2 g) were mixed with 10 mL of methanol in a vial and put into ultrasonic bath for 30 minutes at 55 °C. After cooling, 10 µL of solution was applied onto TLC

plates Kieselgel UV 254 20 x 20 cm (Merck KGaA, Darmstadt, Germany). Mixture of n-butanol, acetic acid and water (95 : 5 : 25) was used as a mobile phase. Separation took about 5 hours at room temperature. After separation, amygdalin content was determined by UV densitometer CS – 9000 (Shimadzu, Japan) at 205 nm. An external standard was used (1% amygdalin solution in methanol). Crude protein content was performed according to Kjeldahl (1883), fat content was determined using Soxhlet method for fat extraction (1879) and crude fibre by Henneberg-Stohmann method (1860). Amount of starch was measured via polarimetry and total sugars by Luff-Schoorl titration. Organic content in apricot seeds is shown in Table 1.

Mineral content in apricot seeds was determined using atomic absorption spectroscopy and is shown in Table 2.

Volunteers

The study group finally consisted of 34 healthy adult volunteers (21 females and 13 males). Volunteers were recruited from the general population of Slovakia (Nitra district). Respondents were 23-65 years old, where the average age of women was 40.65 ±11.31 years and the average age of men was 36.91 ±9.98 years. All subjects involved in the study were informed of all risks, discomforts and benefits and written informed consent to participate in the study was provided to them. The study was performed between September and December 2015. The trial was approved by the Ethic Committee at the Specialized Hospital St. Zoerardus Zobor, n. o., protocol number 030809/2015. All participants were asked to consume 60 mg.kg⁻¹ body weight of bitter apricot seeds daily (approximately 3.0 mg.kg⁻¹ of amygdalin) during 6 weeks. Volunteers were instructed as follows: not to change their usual diet and habits (physical exercise etc.), to consume approximately one seed each hour, to chew it as thoroughly as possible and to drink a lot of water after each consumption.

Urine sample collection

During the experiment, three urine collections were carried out (first collection – at the beginning of the experiment; second collection – after 21 days; third collection – after 42 days). First morning sample of urine was collected from all volunteers into sterile tubes. Urine analysis was performed at the same day.

Analysis

Quantification of calcium (Ca), magnesium (Mg), phosphorus (P) and urea after apricot seeds supplementation was performed through commercial sets

Table 1 Organic content in apricot seeds (%).

Dry matter	Amygdalin	Crude protein	Fat	Crude fibre	Starch	Total sugars
95.9	5.8	22.8	39.7	28.5	2.3	6.3

Table 2 Dry matter (%) and mineral content (mg.kg⁻¹) in apricot seeds.

Dry matter	Ca	P	Mg	Na	K
95.9	1 774	4 700	2 050	642	5 925

DiaSys (Diagnostic Systems GmbH, Germany) on device Rx Monza (Randox Laboratories Ltd., United Kingdom). Amount of sodium (Na), potassium (K) and chlorides (Cl⁻) was determined on device EasyLyte Plus (Medica

Corporation, United States). Urine pH values were measured by pH meter 3200P (Agilent Technologies, United States).

Table 3 Analysis of variance calculated for parameters of human urine.

Source of variation Parameter	Gender	Length of consumption	Interaction
Calcium	F = 0.4844	F = 5.810**	F = 3.061
Phosphorus	F = 4.171*	F = 3.350*	F = 3.938*
Magnesium	F = 0.908	F = 0.460	F = 0.082
Sodium	F = 0.304	F = 0.571	F = 0.930
Potassium	F = 1.639	F = 0.600	F = 2.390
Chlorides	F = 2.161	F = 0.399	F = 1.820
Urea	F = 6.224*	F = 4.379*	F = 0.019
pH	F = 2.118	F = 1.611	F = 0.184

Note. The level of significance was set at **p* < 0.05, ***p* < 0.01, ****p* < 0.001. Two-way ANOVA with gender and length of consumption as between-subject factors. See Material and methodology for details.

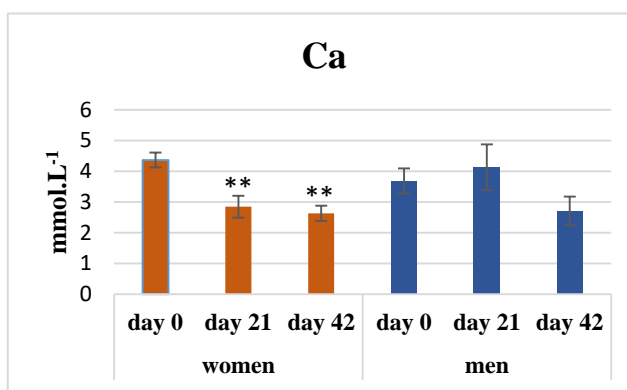

Figure 1 Urine levels of calcium in men and women during 42 days of experiment (mean ±SEM). The level of significance was set at **p* < 0.05, ***p* < 0.01, ****p* < 0.001.

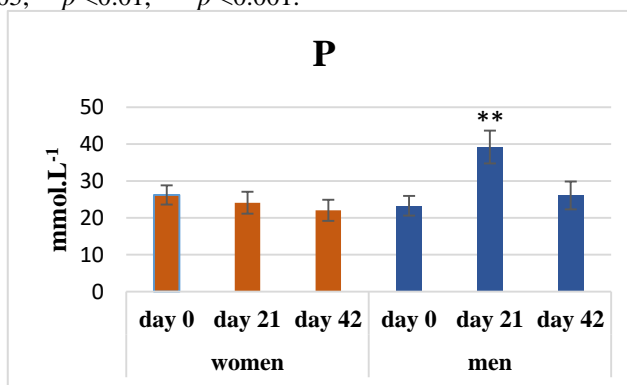

Figure 2 Urine levels of phosphorus in men and women during 42 days of experiment (mean ±SEM). The level of significance was set at **p* < 0.05, ***p* < 0.01, ****p* < 0.001.

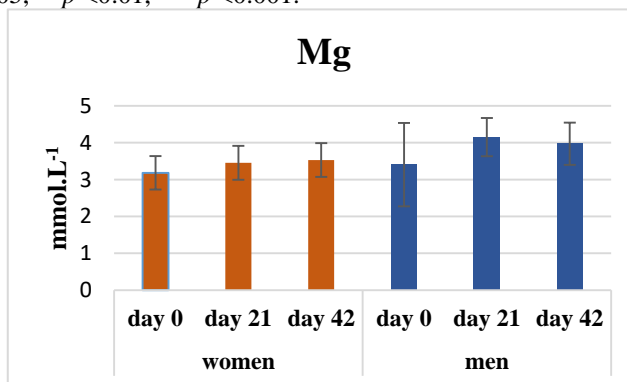

Figure 3 Urine levels of magnesium in men and women during 42 days of experiment (mean ±SEM). The level of significance was set at **p* < 0.05, ***p* < 0.01, ****p* < 0.001.

Statistical analysis

Parameters of human urine at the beginning of experiment, after 21 and after 42 days of apricot seeds consumption were statistically evaluated and are given as means and SEM. All groups passed Shapiro-Wilk normality test and were compared by a within-subjects two-way analysis of variance (ANOVA), followed by Bonferroni post-tests when required using statistical software GraphPad Prism 5.0 (GraphPad Software Inc., San Diego, CA, USA). Differences were considered significant if the probability of error was <5%.

RESULTS

A total of 34 adult volunteers were used in the final data analysis, of which 21 (61.8%) were females and 13 (38.2%) were males. First sample collection (at the beginning of the experiment) was used as a control. Effect of gender and length of apricot seeds consumption on

urine concentration of Ca, P, Mg, Na, K, Cl, urea and pH value is revealed by two-way ANOVA (Table 3). Urine concentration of calcium was affected by the length of consumption ($p = 0.004$). Level of phosphorus in urine was affected by gender ($p = 0.044$), by length of consumption ($p = 0.039$), but analysis of variance confirmed also their mutual interactions ($p = 0.023$). Urine concentration of urea was affected by length of consumption ($p = 0.015$), and by gender significantly ($p = 0.014$). Other following parameters were not significantly affected.

Figure 1 shows the concentrations of the urine calcium divided by the gender and length of consumption. We found statistically significant decrease of Ca content between first and second collection ($p < 0.01$), and third collection ($p < 0.01$) in the female group. In the male group, no significant differences were found.

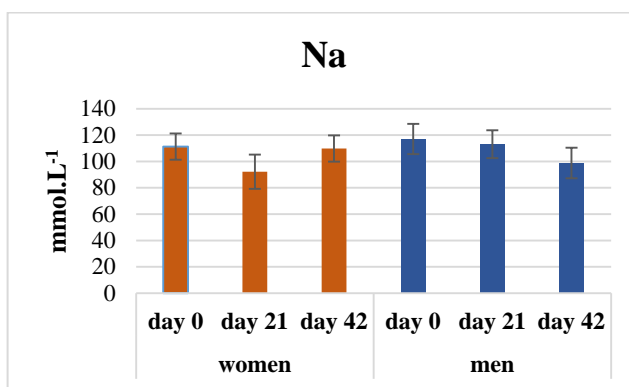

Figure 4 Urine levels of sodium in men and women during 42 days of experiment (mean ±SEM). The level of significance was set at * $p < 0.05$, ** $p < 0.01$, *** $p < 0.001$.

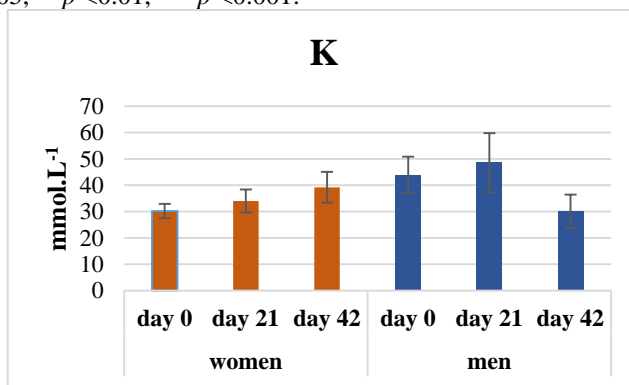

Figure 5 Urine levels of potassium in men and women during 42 days of experiment (mean ±SEM). The level of significance was set at * $p < 0.05$, ** $p < 0.01$, *** $p < 0.001$.

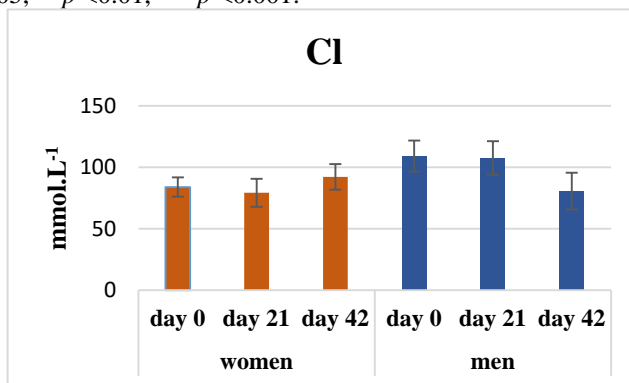

Figure 6 Urine levels of chlorides in men and women during 42 days of experiment (mean ±SEM). The level of significance was set at * $p < 0.05$, ** $p < 0.01$, *** $p < 0.001$.

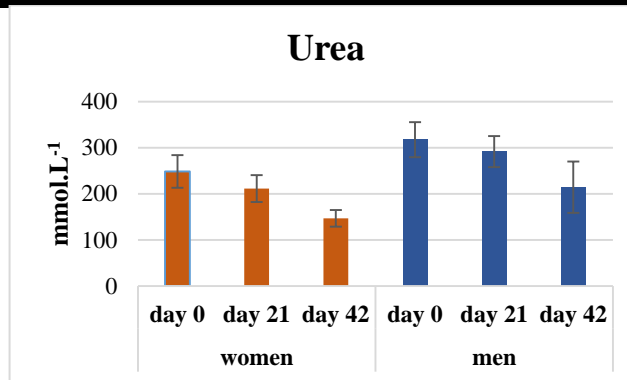

Figure 7 Urine levels of urea in men and women during 42 days of experiment (mean \pm SEM). The level of significance was set at * $p < 0.05$, ** $p < 0.01$, *** $p < 0.001$.

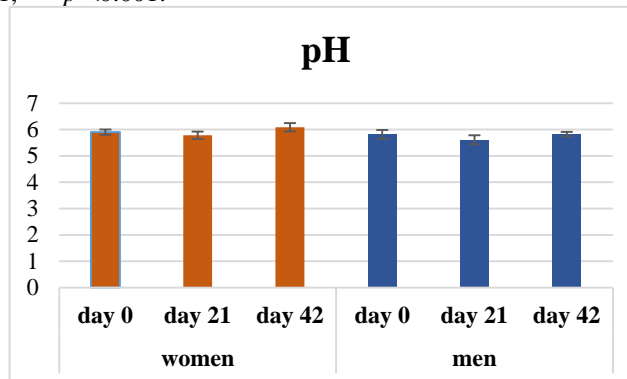

Figure 8 Urine levels of pH in men and women during 42 days of experiment (mean \pm SEM). The level of significance was set at * $p < 0.05$, ** $p < 0.01$, *** $p < 0.001$.

The concentration of phosphorus in the male urine significantly ($p < 0.01$) increased to the maximum in 21st day of experiment (Figure 2). In the female group, a slight decrease of P content was observed.

Figure 3 describes how apricot seeds consumption influenced level of urine magnesium. In the both genders, we didn't found significant differences, however we found a moderate increase of the observed parameter.

Content of the urine sodium shows the opposite tendency than previous parameter (Figure 4). Results show a slight decrease of Na in collections after 21, resp. 42 days of consumption with non-significant differences in the both genders.

Differences between potassium levels were statistically non-significant too, but we recorded considerable decrease of this parameter between male control collection (day 0) and male third collection. Opposite tendency, an increase, was observed in the female group, also statistically non-significant (Figure 5).

Urine concentration of chlorides showed very similar tendency (Figure 6). A slight decrease of Cl level occurred in the male group and slight increase occurred in the female group.

Content of urea in both groups had similar tendency (Figure 7). Decrease of urea level was recorded in the male group and in the female group too. Besides that, decrease in the female group between first and third collection was significant ($p < 0.05$).

The last studied parameter, pH value, was shown to be the most stable (Figure 8). The analysis of variance of this parameter showed only negligible effect of apricot kernels consumption.

DISCUSSION

In past decades, amygdalin has been studied extensively from different points of view. It has been reported, that amygdalin is a natural product that owns antitumor activity (Song and Xu, 2014) has also been used for the treatment of asthma, bronchitis, emphysema, leprosy and diabetes (Zhou et al., 2012) and produces a kind of antitussive and antiasthmatic effects (Badr and Tawfik, 2010; Lv et al., 2005). Besides that, it has possible modulatory impact on cell viability (Halenár et al., 2016) and the steroid production in porcine ovaries *in vitro*, as Halenár et al. (2015a, 2015b) published in their study. Michalcová et al. (2016) reported, that natural substances present in apricot seeds may be involved in mechanisms of ovarian folliculogenesis of rabbits through inhibition of FSH levels. Amygdalin is also a potential antifibrotic agent that may have therapeutic potential for patients with fibrotic kidney disease (Guo et al., 2012). Kováčová et al. (2016) observed a significantly lower values of primary osteons' vascular canals and secondary osteons in femoral bones of rabbits administered by amygdalin. Our previous *in vivo* study on rabbits showed no obvious effect of intramuscular administration of amygdalin (0.6 and 3.0 mg.kg⁻¹) on energy profile (Tušimová et al., 2016a). Similarly, Miller et al. (1981) did not observe changes in blood chemistry of rats fed a diet containing 10% ground apricot kernels.

There are just a few studies of blood chemistry changes and even fewer studies of urine composition changes after amygdalin administration *in vivo*.

Statistically significant decrease of calcium content between first and second collection ($p < 0.01$), and also between first and third collection ($p < 0.01$) was found in the female group. However, this decrease may be

considered as a positive effect, since the reduction of excreted calcium shifted its level from elevated mean value in control collection (4.36 mmol.L^{-1}) into normal physiological range ($1.2 - 3.7 \text{ mmol.L}^{-1}$) according to Vasudevan et al. (2011). In the male group, no significant differences were found. Two-way analysis of variance showed very significant effect of length of apricot seeds consumption on urine calcium ($p = 0.004$) in presented study. Urine calcium level can be also decreased by very low protein intake (Calloway and Margen, 1971).

The concentration of phosphorus in the male urine significantly ($p < 0.01$) increased to the maximum in 21st day of experiment. In the female group, a slight decrease of P content was observed, though all the values were in the reference range ($20 - 50 \text{ mmol.L}^{-1}$) (Vasudevan et al., 2011). According to ANOVA results, amount of P in urine was significantly affected by gender ($p = 0.044$), length of consumption ($p = 0.039$) and by interaction of these two factors ($p = 0.023$). In very low protein diets phosphorus levels in urine were shown to be increased (Calloway and Margen, 1971).

Sodium and potassium are major solutes excreted in urine (Rose et al., 2015). In very low protein diets, urine potassium level can be increased and magnesium concentration in urine is not affected (Calloway and Margen, 1971). Our results did not show any significant differences in sodium, potassium, magnesium and chlorides levels between collections either in males or in females.

Nitrogen in urine is predominantly in the form of organic nitrogen and mostly in the form of urea (Belser-Baykal et al., 2011). Urea is the most predominant constituent making up over 50% of total organic solids, and it is produced through the metabolism of protein (Rose et al., 2015). Urinary nitrogenous components increase with levels of protein in the diet; a positive correlation between urinary nitrogen and protein intake was found to be 0.91 (Magee et al., 2004). Normal urea concentration range from 167 mmol.L^{-1} to 583 mmol.L^{-1} (Vasudevan et al., 2011). Results of our study showed concentrations of urea within this range except for the last collection in females (146 mmol.L^{-1}) with decreasing tendency also in males. The difference in urea concentration between control and third collection in female group was found significant ($p < 0.05$). Two-way analysis of variance showed significant effect of length of apricot seeds consumption ($p = 0.015$), but gender was also considered to be a source of variation ($p = 0.014$). Vasudevan et al. (2011) reported, that urea level decrease may be caused by low protein intake, prolonged fasting, but also by liver failure. However, our previous *in vivo* study on rabbits showed no obvious effect of amygdalin administration (0.6 and 3.0 mg.kg^{-1}) on hepatic profile after (Tušimová et al., 2016b).

Value of pH in our study varied from 5.7 to 6.1, which is only slightly lower in comparison to values that Rose et al. (2015) observed. According to their results, the pH of fresh urine was largely neutral with a median of pH 6.2 with a range of pH values of 5.5 – 7.0. Our results showed no significant differences in pH values between urine collections in comparison to control collection, even there is a moderate increase in urine pH in both groups. Changes in urinary pH can be caused by numerous factors. It is

reduced by high protein intake through meat and dairy products as well as through alcohol consumption (Kanbara et al., 2012) and increased by higher consumption of potassium and organic acids in vegetables and fruit (Rose et al., 2015).

CONCLUSION

Natural substances, such as amygdalin, used in alternative medicine gained high popularity. Common people as well as patients with different diseases have almost unlimited access to various natural supplements. To protect human health, it is very important to study effect of these substances.

In summary, consumption of bitter apricot seeds (60 mg.kg^{-1} of body weight) during 42 days had a significant effect on amount of calcium excreted in urine, though this decrease shifted its level from elevated mean value in control collection into normal physiological range. Significant changes were observed in urea and phosphorus levels in urine after apricot seed ingestion, but gender was also considered to be a source of their variation. Although the detailed mechanisms behind the action of amygdalin remain undefined, we hypothesize that this natural substance may moderately affect mineral and nitrogen management and possibly acid-base balance of the body. However, future studies are required to investigate the mechanisms by which amygdalin affects regulatory systems in human organism.

REFERENCES

- Badr, J. M., Tawfik, M. K. 2010. Analytical and pharmacological investigation of amygdalin in *Prunus armeniaca L.* kernels. *Journal of Current Pharmaceutical Research*, vol. 3, no. 9, p. 2134-2137.
- Belser-Baykal, B., Allar, A., Bayram, S. 2011. Nitrogen recovery from source-separated human urine using clinoptilolite and preliminary results of its use as fertilizer. *Water Science and Technology*, vol. 63, no. 4, p. 811-817. <https://doi.org/10.2166/wst.2011.324> [PMid:21330732](https://pubmed.ncbi.nlm.nih.gov/21330732/)
- Calloway, D. H., Margen, S. 1971. Variation in endogenous nitrogen excretion and dietary nitrogen utilization as determinants of human protein requirement. *The Journal of Nutrition*, vol. 101, no. 2, p. 205-216. [PMid:5540441](https://pubmed.ncbi.nlm.nih.gov/5540441/)
- Casarett, L. J., Doull, J., Klaassen, C. D., Amdur, M. D. 1980. Casarett and Doull's Toxicology. 2nd ed. New York : Macmillan Publishing. p. 328. ISBN 978-80-0023-304-04.
- Chang, H. K., Shin, M. S., Yang, H. Y., Lee, J. W., Kim, Y. S., Lee, M. H., Kim, J., Kim, K. H., Kim, C. J. 2006. Amygdalin Induces Apoptosis through Regulation of Bax and Bcl-2 Expressions in Human DU145 and LNCaP Prostate Cancer Cells. *Biological and Pharmaceutical Bulletin*, vol. 29, no. 8, p. 1597-1602. <https://doi.org/10.1248/bpb.29.1597> [PMid:16880611](https://pubmed.ncbi.nlm.nih.gov/16880611/)
- Chwalek, M., Plé, K. 2004. Convenient syntheses of isomaltose derivatives from amygdalin. *Tetrahedron Letters*, vol. 45, no. 24, p. 4749-4753. <https://doi.org/10.1016/j.tetlet.2004.04.057>
- Delanghe, J., Speeckaert, M. 2014. Preanalytical requirements of urinalysis. *Biochemia Medica*, vol. 24, no. 1, p. 89-104. <https://doi.org/10.11613/BM.2014.011> [PMid:24627718](https://pubmed.ncbi.nlm.nih.gov/24627718/)
- Gansler, T., Kaw, C., Crammer, C., Smith, T. 2008. A population-based study of prevalence of complementary

- methods use by cancer survivors: a report from the American Cancer Society's studies of cancer survivors. *Cancer*, vol. 113, no. 5, p. 1048-57. <https://doi.org/10.1002/cncr.23659> PMID:18680170
- Guo, J., Wu, W., Sheng, M., Yang, S., Tan, J. 2013. Amygdalin inhibits renal fibrosis in chronic kidney disease. *Molecular Medicine Reports*, vol. 7, no. 5, p. 1453-1457. PMID:23525378
- Halenár, M., Medved'ová, M., Maruniaková, N., Kolesárová, A. 2015a. Ovarian hormone production affected by amygdalin addition in vitro. *Journal of Microbiology, Biotechnology and Food Sciences*, vol. 4, special no. 2, p. 19-22.
- Halenár, M., Medved'ová, M., Maruniaková, N., Kolesárová, A. 2015b. Assessment of a potential preventive ability of amygdalin in mycotoxin-induced ovarian toxicity. *Journal of Environmental Science and Health B*, vol. 50, no. 6, p. 411-416. <https://doi.org/10.1080/03601234.2015.1011956> PMID:25844862
- Halenár, M., Tušimová, E., Nynca, A., Sadowska, A., Ciereszko, R., Kolesárová, A. 2016. Stimulatory effect of amygdalin on the viability and steroid hormone secretion by porcine ovarian granulosa cells in vitro. *Journal of Microbiology, Biotechnology and Food Sciences*, vol. 5, special no. 1, p. 44-46.
- Heinonen-Tanski, H., Sjöblom, A., Fabritius, H., Karinen, P. 2007. Pure human urine is a good fertiliser for cucumbers. *Bioresource Technology*, vol. 98, no. 1, p. 214-217. <https://doi.org/10.1016/j.biortech.2005.11.024> PMID:16413181
- Henneberg, W., Stohmann, F. 1860. *Beitrage zur Begrundung einer rationeller Fütterung der Weiderkauer*. Braunschweig : Schmetschke und Sohn. 315 p.
- Holzbecher, M. D., Moss, M. A., Ellenberger, H. A. 1984. The cyanide content of laetrile preparations, apricot, peach and apple seeds. *Journal of Toxicology. Clinical Toxicology*, vol. 22, no. 4, p. 341-347. <https://doi.org/10.3109/15563658408992565> PMID:6098693
- Hunt, K. J., Coelho, H. F., Wider, B., Perry, R., Hung, S., Terry, R. Ernst, E. 2010. Complementary and alternative medicine use in England: results from a national survey. *International Journal of Clinical Practice*, vol. 64, no. 11, p. 1496-1502. <https://doi.org/10.1111/j.1742-1241.2010.02484.x> PMID:20698902
- Jakubcova, Z., Zeman, L., Mares, P., Mlcek, J., Jurikova T., Dostalova, L., Mrazkova, E., Mrkvicova, E., Balla, S., Sochor, J. 2014. Effect of chamomile supplements to feeding doses on antimicrobial parameters in poultry. *Potravinárstvo*, vol. 8, no. 1, p. 228-232. <https://doi.org/10.5219/383>
- Kanbara, A., Miura, Y., Hyogo, H., Chayama, K., and Seyama, I. 2012. Effect of urine pH changed by dietary intervention on uric acid clearance mechanism of pH-dependent excretion of urinary uric acid. *Nutrition Journal*, vol. 11, no. 1, p. 39. <https://doi.org/10.1186/1475-2891-11-39> PMID:22676161
- Karak, T., Bhattacharyya, P. 2011. Human urine as a source of alternative natural fertilizer in agriculture: A flight of fancy or an achievable reality. *Resources, Conservation and Recycling*, vol. 55, no. 4, p. 400-408. <https://doi.org/10.1016/j.resconrec.2010.12.008>
- Kirchmann, H., Pettersson, S. 1994. Human urine – chemical composition and fertilizer use efficiency. *Fertilizer Research*, vol. 40, no. 2, p. 149-154. <https://doi.org/10.1007/BF00750100>
- Kjeldahl, J. 1883. New method for the determination of nitrogen in organic substances. *Zeitschrift für analytische Chemie*, vol. 22, no. 1, p. 366-383. <https://doi.org/10.1007/BF01338151>
- Kovacova, V., Omelka, R., Sarocka, A., Sranko, P., Adamkovicova, M., Toman, R., Halenar, M., Kolesarova, A., Martiniakova, M. 2016. *Potravinárstvo*, vol. 10, no. 1, p. 393-399. <https://doi.org/10.5219/625>
- Lee, H. M., Moon, A. 2016. Amygdalin Regulates Apoptosis and Adhesion in Hs578T Triple-Negative Breast Cancer Cells. *Biomolecules & therapeutics*, vol. 24, no. 1, p. 62-66. <https://doi.org/10.4062/biomolther.2015.172> PMID:26759703
- Lv, W. F., Ding, M. Y., Zheng, R. 2005. Isolation and quantitation of amygdalin in apricot kernel and *Prunus Tomentosa Thunb.* by HPLC with solid phase extraction. *Journal of Chromatographic Science*, vol. 43, no. 7, p. 383-387. <https://doi.org/10.1093/chromsci/43.7.383> PMID:16176653
- Magee, E. A., Curno, R., Edmond, L. M., and Cummings, J. H. 2004. Contribution of dietary protein and inorganic sulfur to urinary sulfate: Toward a biomarker of inorganic sulfur intake. *The American Journal of Clinical Nutrition*, vol. 80, no. 1, p. 137-142. PMID:15213040
- Mendelová, A., Mendel, L., Czako, P., Mareček, J. 2016. Evaluation of carotenoids, polyphenols content and antioxidant activity in the sea buckthorn fruit juice. *Potravinárstvo*, vol. 10, no. 1, p. 59-64. <https://doi.org/10.5219/551>
- Michalčová, K., Halenár, M., Tušimová, E., Kováčik, A., Chrástínová, Ľ., Ondruška, Ľ., Jurčík, R., Kolesárová, A. 2016. Blood plasma levels of anterior pituitary hormones of rabbits after apricot seed exposure in vivo. *Journal of Central European Agriculture*, vol. 17, no. 4, p. 1241-1252. <https://doi.org/10.5513/JCEA01/17.4.1838>
- Milazzo, S., Ernst, E., Lejeune, S., Boehm, K., Horneber, M. 2011. Laetrile treatment for cancer. *The Cochrane Database of Systematic Reviews*, no. 2, p. CD005476. <https://doi.org/10.1002/14651858.cd005476.pub3>
- Miller, K. W., Anderson, J. L., Stoewsand, G. S. 1981. Amygdalin metabolism and effect on reproduction of rats fed apricot kernels. *Journal of Toxicology and Environmental Health*, vol. 7, no. 3-4, p. 457-467. <https://doi.org/10.1080/15287398109529994> PMID:7288898
- Moertel, C. G., Fleming, T. R., Rubin, J., Kvols, L. K., Sarna, G., Koch, R., Currie, V. E., Young, C. W., Jones, S. E., Davignon, J. P. 1982. A clinical trial of amygdalin (Laetrile) in the treatment of human cancer. *The New England Journal of Medicine*, vol. 306, no. 4, p. 201-206. <https://doi.org/10.1056/NEJM198201283060403> PMID:7033783
- Putnam, D. F. 1971. Composition and concentrative properties of human urine (CR-1802) [online]. Washington, DC: NASA. p. 38. [cit.2017-01-28] Available at: <https://ntrs.nasa.gov/archive/nasa/casi.ntrs.nasa.gov/19710023044.pdf>.
- Rose, C., Parker, A., Jefferson, B., Cartmell, E. 2015. The characterization of feces and urine: a review of the literature to inform advanced treatment technology. *Critical Reviews in Environmental Science and Technology*, vol. 45, no. 1, p. 1827-1879. <https://doi.org/10.1080/10643389.2014.1000761> PMID:26246784
- Santos Pimenta, L. P., Schilthuisen, M., Verpoorte, R., Choi, Y. H. 2013. Quantitative analysis of amygdalin and prunasin in *Prunus serotina Ehrh.* using (1) H-NMR

spectroscopy. *Phytochemical analysis : PCA*, vol. 25, no. 2, p. 122-126. [PMid:24115144](#)

Seghers, L., Walenbergh-van Veen, M., Salome, J., Hamberg, P. 2013. Cyanide intoxication by apricot kernel ingestion as complementary cancer therapy. *The Netherlands Journal of Medicine*, vol. 71, no. 9, p. 496-498. [PMid:24218429](#)

Seigler, D. S. 1975. Isolation and characterization of naturally occurring cyanogenic compounds. *Phytochemistry*, vol. 14, no. 1, p. 9-29. [https://doi.org/10.1016/0031-9422\(75\)85001-1](https://doi.org/10.1016/0031-9422(75)85001-1)

Sokolsky, M. L., Wargovich, M. J. 2012. Homeostatic Imbalance and Colon Cancer: The Dynamic Epigenetic Interplay of Inflammation, Environmental Toxins, and Chemopreventive Plant Compounds. *Frontiers in oncology*, vol. 2, no. 57, p. 1-21. <https://doi.org/10.3389/fonc.2012.00057>

Song, Z., Xu, X. 2014. Advanced research on anti-tumor effects of amygdalin. *Journal of Cancer Resesarch & Therapy*, vol. 1, p. 3-7.

Soxhlet, F. 1879. Die gewichtsanalytische Bestimmung des Milchfettes. *Dinglers Polytechnisches Journal*, vol. 232: p. 461-465.

Tušimová, E., Kováčik, A., Halenár, M., Zbyňovská, K., Chrastinová, E., Ondruška, E., Jurčík, R., Kolesár, E., Kolesárová, A. 2016a. Energetic profile of rabbits after amygdalin administration. *Journal of Microbiology, Biotechnology and Food Sciences*, vol. 5, special no. 1, p. 50-52.

Tušimová, E., Kováčik, A., Halenár, M., Zbyňovská, K., Tomková, M., Tirpák, F., Chrastinová, E., Ondruška, E., Jurčík, R., Kolesár, E., Kolesárová, A. 2016b. Hepatic profile of female rabbits after amygdalin administration. In *12th International Scientific Conference Animal Physiology 2016 : proceedings*. Bořetice : Mendel University in Brno, p. 253-259. ISBN 978-80-7509-416-2.

Vasudevan, D. M., Sreekumari, S., Vaidyanathan, K. 2011. Textbook of Biochemistry for Medical Students, 6th edition. New Delhi : Jaypee Brothers Medical Publishers. p. 332-339. <https://doi.org/10.5005/jp/books/11333>

Zhou, C., Qian, L., Ma, H., Yu, X., Zhang, Y., Qu, W., Zhang, X., Xia, W. 2012. Enhancement of amygdalin activated with β -D-glucosidase on HepG2 cells proliferation and apoptosis. *Carbohydrate Polymers*, vol. 90, no. 1, p. 516-523. <https://doi.org/10.1016/j.carbpol.2012.05.073> [PMid:24751072](#)

Acknowledgments:

This work was financially supported by the Ministry of Education, Science, Research and Sport of the Slovak Republic projects no. 1/0039/16, 011SPU-4/2016 KEGA, APVV-0304-12, and European Community under project no. 26220220180: Building Research Centre „AgroBioTech“.

Contact address:

Eva Tušimová, Slovak University of Agriculture, Research Centre AgroBioTech, Tr. A. Hlinku 2, 949 76 Nitra Slovakia, E-mail: tusimova.eva@gmail.com

Anton Kováčik, Slovak University of Agriculture, Faculty of Biotechnology and Food Sciences, Department of Animal Physiology, Tr. A. Hlinku 2, 949 76 Nitra Slovakia, E-mail: anton.kovacik@yahoo.com

Marek Halenár, Slovak University of Agriculture, Faculty of Biotechnology and Food Sciences, Department of Animal Physiology, Tr. A. Hlinku 2, 949 76 Nitra Slovakia, E-mail: halenarmarek@gmail.com

Katarína Michalcová, Slovak University of Agriculture, Faculty of Biotechnology and Food Sciences, Department of Animal Physiology, Tr. A. Hlinku 2, 949 76 Nitra Slovakia, E-mail: kmichalcova86@gmail.com

Katarína Zbyňovská, Slovak University of Agriculture, Faculty of Biotechnology and Food Sciences, Department of Animal Physiology, Tr. A. Hlinku 2, 949 76 Nitra, Slovakia, E-mail: zbynovska.katarina@gmail.com

Anna Kolesárova, Slovak University of Agriculture, Faculty of Biotechnology and Food Sciences, Department of Plant Products Storage and Processing, Tr. A. Hlinku 2, 949 76 Nitra Slovakia, E-mail: kolesarovanna@gmail.com

Jana Kopčková, Slovak University of Agriculture, Faculty of Agrobiological and Food Resources, Department of Human Nutrition, Tr. A. Hlinku 2, 949 76 Nitra Slovakia, E-mail: jana.kopcekova@gmail.com

Jozef Valuch, Health Care Surveillance Authority, Želova 2, 829 24 Bratislava, Slovakia, E-mail: dodovaluch@gmail.com

Adriana Kolesárová, Slovak University of Agriculture, Faculty of Biotechnology and Food Sciences, Department of Animal Physiology, Tr. A. Hlinku 2, 949 76 Nitra Slovakia, E-mail: adriana.kolesarova@uniag.sk



LINSEED FIBRE – EFFECT ON COMPOSITE FLOUR PROPERTIES AND CEREAL PRODUCTS QUALITY

Marie Hrušková, Ivan Švec

ABSTRACT

Wheat flour was fortified by 2.5 or 5.0 wt. per cent of linseed fibre, gained from seeds of golden flax varieties Amon and Raciol and brown one Recital (granulation 500 – 700 m), prepared from 2015 harvest. Technological quality of six flour composites was described analytically by Falling Number and Zeleny sedimentation test. Both screening methods shown a little impact on amylases activity and protein quality, respectively. Rheological tests included the farinograph, the extensigraph and the Rapid Visco Analyser (RVA) proofs. Additions of brown and yellow flax fibre significantly increased farinograph water absorption and shortened dough stability, somewhat stronger by addition of brown linseed fibre. Extensigraph curves course depended on dough resting time, higher differences between wheat control and flour composites were observed after 60 min dough resting. Linseed fibre supported dough extensibility, and energy as area under curve significantly decreased about 7 – 18%, mainly due to increasing alternative material portion in dough. In general, fibre is characterised as hydrophilic material, and pasting profiles of flour composites confirmed this experience. During dough leavening, tested samples were differentiated according to maturograph dough resistance; optimal leavening time of wheat-linseed fibre dough was shorter than control. Regardless described modifications in dough machinability, specific volumes of bread buns were similar though whole sample set. A weak worsening of buns vaulting reflected a partial dilution of dough gluten skeleton. Cut-off biscuits were characterised by gradually lowering spread ratio, correspondingly to elevated dough elasticity. Laboratory prepared elbow-pasta have the same cooking time as the control (8.0 min), and data variation could not be attributed to linseed fibre or addition level. All three cereal products were found to have acceptable sensory profiles. PCA method verified partial lowering of protein quality and pointed at tested sample differentiation according to linseed addition level.

Keywords: brown and golden linseed fibre; dough rheology; bread; biscuits; pasta; principal component analysis

INTRODUCTION

Flax (*Linum usitatissimum* L.) is old utility plant originated in Asia. In the Central Europe during the Middle Ages, canvas was manufactured from linen and hemp. The plant is characteristics by slim stalk and white or light-blue flowers. Fruit named boll contains tiny brown seeds. Nowadays, flax varieties producing yellow seeds, known as “golden flax”, are bred, too. Within seeds cover, there could be found layers containing heteropolysaccharides, characterised by high hydration capacity (up to 1,200%). Weight ratio of this fraction oscillates between 7 – 12%. Responsible structures were analysed as neutral arabinoxylans and acid complex of galacturonic acid and rhamnose (namely rhamnogalacturonan backbone) (Kaewmanee et al., 2014). In water even at low concentrations (approx. 0.2%) (Mazza and Biliaderis, 2006), they form viscous gel (Prazdnik et al., 2016) known as mucilage. Simple sugars, namely d-xylose, d-glucose and d-glucuronic acid could be also

detected in the gel. Troshchynska et al. (2016) verified differences in flow properties between mucilage from brown and golden flax seeds. At concentration around 1%, flax mucilage exhibits good foam stability (Mazza and Biliaderis, 2006). Mucilage viscosity is probably positively correlated with the neutral sugars and negatively with the amount of proteins – dependence on actual composition predefines its usage as either thickener, or stabiliser (Kaewmanee et al., 2014).

Linseed fibre is a food supplement, gained at the end of milling and sieving of defatted linseed press cake. As mentioned in our previous article (Hrušková and Švec, 2016), one of its world producer is the Walramcom company from the New Zealand. They offer both golden and brown linseed fibre types, in which ca 45% of total dietary fibre is declared (38% insoluble and 7% soluble fraction). For significant health benefit, consumption of 13 g linseed fibre is recommended daily, e.g. as muesli or yogurt spread at breakfast, or a component of fruit

cocktails. Linseed fibre could be consumed alone in form of water gel like chia seeds, or could be added into cookie, pancake or bread recipes. Besides good unsaturated fatty acids content, also polyphenols are represented in valuable extent (Gutiérrez et al., 2010). Oomah (2001) manufactured biscuits with linseed lignans and genistein in recipe, and verified their usefulness in combating cancer. At least, diets containing flaxseed are able to amend unbalanced serum lipidemia to normal values (Mervat et al., 2015).

In wheat composite dough, additions of flax seed flour increased water absorption and mixing tolerance index, but shortened dough stability and extensibility (Koca and Anil, 2007; Xu et al., 2014). Nor roasting of flaxseed flour did not suppress its negative effects (Chetana et al., 2010). Mentioned changes were only softly reflected in bread quality characteristics as the specific volume. Within their study, Mervat et al. (2015) evaluated properties of wheat-flax bread variants containing full fat or partially defatted flax flour and concluded comparable quality of both enriched modifications. Contrary to that, 5% flaxseed hull flour decreased bread specific volume and increased crumb firmness (Sęczyk et al., 2017).

Flaxseed flour portion, added at level 18%, significantly decreased cookies stickiness but supported their firmness. Lower alternative material dosages (6 and 12%) resulted in cookies still acceptable for common consumers (Khouryieh and Aramouni, 2012). Muffins are further type of cereal product suitable for such enrichment – 20% raw flaxseed flour decreased volume of the final product softly, but its roasted version significantly (from 150 to 145 and 125 mL, respectively). In combination with rising weight of muffin pieces, their specific volume flaxseed flour was lowered approximately about 5% and about 17% for counterparts with non-treated and roasted flaxseed flour, respectively (Chetana et al., 2010).

Addition of majority of non-traditional plant materials leads to disruption of gluten net in wheat-composite dough. In case of pasta containing flaxseed flour, loss of mechanical compactness did not avoid a higher rate of dried pasta shattering (Manthey et al., 2000). In comparison to traditional pasta, the same authors have reported lower cooked firmness and cooking loss for fresh pasta containing 15% of flaxseed flour, stored 1 week at 4 °C (Manthey et al., 2008). By usage of non-linear regression, Kishk et al. (2011) found addition of 3% flaxseed mucilage and drying temperature ranging between 68.2 and 70 °C as optimal for production of noodle with high cooking quality; mucilage improved the texture and overall acceptability of prepared product.

The presented study is aimed at complex evaluation of linseed fibre additions effect on technological quality of wheat flour, and comparison of influence of fibre from golden and brown oilseeds. Study covered basic analytical properties, rheological behaviour of non-fermented and fermented dough as well as final-usage potential of wheat-linseed fibre in form of bread, cookies and pasta.

MATERIAL AND METHODOLOGY

Preparation of flour composites

Semi-bright wheat flour (WF) was delivered by industrial mill Delta Prague, and it was characterized by protein

content 11.2%, Falling number 372 s and Zeleny value 44 mL. Linseed fibre was produced at laboratory conditions, treating seeds from golden varieties Amon and Raciol and brown one Recital – all prepared from flax of 2015 harvest. To disintegrate the seeds, mill Stephan UM/SK 5 (Stephan Machinery, Hameln, Germany) was employed. Using vibration laboratory hand sieve machine (Stavební strojírenství n.p. Brno, Czechoslovakia) with sieve openings: 1.0, 0.8, 0.71, 0.50, 0.315 and >0.315 mm, demanded fraction 500 – 700 μm was collected to ensure comparability with our previous study (Hrušková and Švec, 2016). In tested composites, linseed fibre replaced either 2.5 or 5.0 wt. % wheat flour. Samples abbreviations combined simplified wheat flour sign, addition level of linseed fibre and first letter of flax variety name (W2.5A, W5.0A, W2.5Ra, W5.0Ra, W2.5Re, and W5.0Re).

Technological quality of flour composites

Technological features of WF and flour composites are described by Zeleny test (ČSN ISO 5529) and Falling number (ČSN ISO 3093). Non-fermented dough properties were determined with the help of farinograph and extensigraph Brabender (Germany), following the international norms (ISO 5530-1, 5530-2, respectively). Behaviour of suspension flour-water was recorded on the RVA 4500 equipment (Perten Instruments, Sweden; AACC method 76-21). According to internal procedures of the UCT Prague, rheological parameters of fermented dough were measured, using fermentograph SJA (Sweden), maturograph and oven spring recorder (OTG) Brabender (Germany). From prepared wheat-flax composites, manually moulded bread, cut-off biscuits and pasta were manufactured, following further internal methods including quality evaluation and sensory analysis.

Statistical evaluation of linseed fibre effect

Influence of non-traditional material type and addition level on selected dough rheological and final product features was evaluated by Tukey HSD test ($p = 95\%$). Aim of Principal Components Analysis (PCA) usage was an identification of main quality features of bread, biscuits and pasta quality. In mentioned three cases, the PCA datasets analogously comprised two analytical features, three farinograph and two extensigraph ones, a pair of the pasting characteristics and foursome of the product quality attributes immanent to the product type.

Owing to non-gluten character of flax proteins, worsening of protein quality in composite dough is presumed. Pasting behaviour of wheat flour-linseed fibre composites will be influenced by high water absorption ability of the non-traditional material. Quality of leavened bread, cut-off biscuits and elbow-pasta may be varied for single cereal products in a different way; e.g. for biscuits, diluted gluten net in dough can support cookie spread during baking. With respect to low addition levels, all three types of cereal products could reach a sensory score in acceptable category.

RESULTS AND DISCUSSION

Evaluation of technological quality of flour composites

With respect to measured ratio of Zeleny test values (37 – 44 mL), linseed fibre lowered protein technological

Table 1 Falling number and RVA Peak Viscosity for wheat flour (WF) and flour composites.

Flour, flour composite	Linseed fibre type						
	<i>none</i> WF	<i>golden</i>				<i>brown</i>	
	WF	W2.5A	W5.0A	W2.5Ra	W5.0Ra	W2.5Re	W5.0Re
Falling Number* (s)	372a	362a	387a	386a	384a	378a	364a
Peak Viscosity* (mPa·s)	1452a	1565ab	1682bc	1902d	1767cd	1822cd	1794cd

Note: WF: wheat flour. Flax varieties: A – Amon, Ra - Raciol (both golden), Re – Recital (brown). RVA – Rapid Visco Analyser. Example of sample coding: W2.5A – wheat flour composite containing 2.5 wt. % of linseed fibre from variety Amon. * a – d: row means described by the same letter are not significantly different ($p = 95\%$).

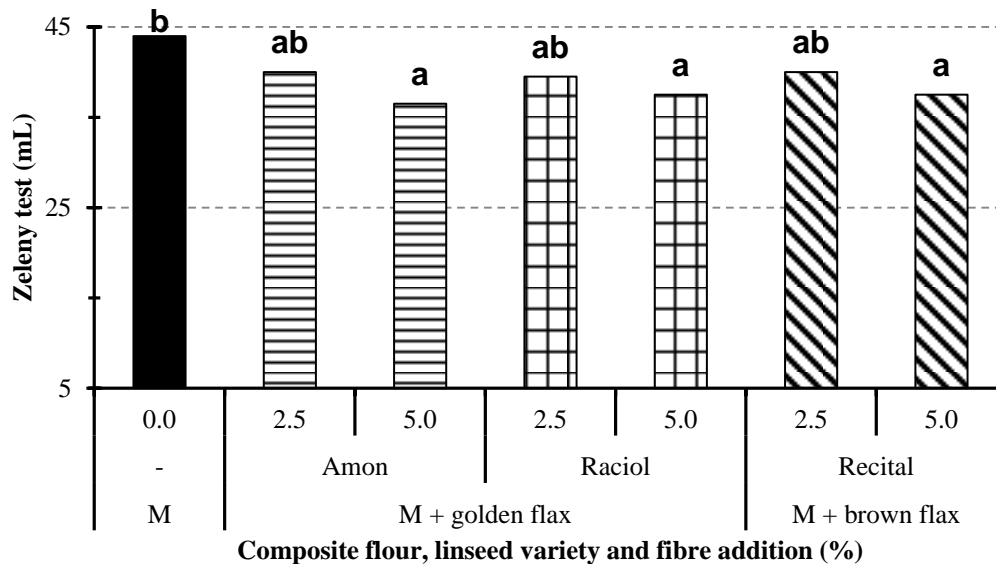

Figure 1 Zeleny test results of wheat flour (WF) and wheat-linseed fibre composites. For samples coding, see Table 1.

quality softly. The higher addition, the lower Zeleny value could be noticed on Figure 1. The same plot declares, there could not be differentiated type of added linseed fibre. The same conclusion could be stated above results of Falling number test (Table 1), which estimates amyloses activity and degree of damaged starch. For the test, measured range 362 – 387 s is covered by its repeatability (25 s).

Viscous and viscoelastic behaviour of flour composites

During RVA proof, detailed description of pasting behaviour of tested flour composites shown a partial differences among tested samples. In the point of Peak Viscosity, linseed fibre from Amon variety interacted with addition level and obviously increased measured maximum (from 1492 mPa·s for WF to 1682 mPa·s for

W5.0A). For other composite samples, higher viscosities in peak than for control were determined for lower enhancement tested (e.g. 1822 and 1794 mPa·s for W2.5Ra and W5.0Ra, respectively; Table 1). At the end of the RVA proof, only WF and W2.5A samples could be considered as outliers owing to the lowest viscosity (1869 and 2046 mPa·s, respectively, vs. 2296-2562 mPa·s for resting fivesome; Figure 2). Addition of the same portions of linseed fibre produced from seeds bred in New Zealand also caused significant increase of viscosity during RVA test (Hrušková and Švec, 2016). Inglett et al. (2013) arrived at contrary conclusion for ground flaxseeds mixed with barley flour used as control; thus, the higher portion of flaxseed flour in barley flour composite, the lower viscosity was measured.

Table 2 Farinograph characteristics of non-fermented dough from wheat flour (WF) and flour composites.

Flour, composite flour	Water absorption* (%)	Dough stability (min)	Dough softening degree* (FU)
WF	66.5a	10.00b	55a
W2.5A	70.0b	9.75b	100b
W5.0A	72.5c	7.00a	95b
W2.5Ra	70.0b	9.25b	85b
W5.0Ra	72.5c	6.50a	135c
W2.5Re	70.3b	7.45a	80b
W5.0Re	72.8c	6.75a	95b

Note: WF: wheat flour. Flax varieties: A – Amon, Ra – Raciol (both golden), Re – Recital (brown). RVA – Rapid Visco Analyser. Example of sample coding: W2.5A – wheat flour composite containing 2.5 wt. % of linseed fibre from variety Amon. * a – d: row means described by the same letter are not significantly different ($p = 95\%$).

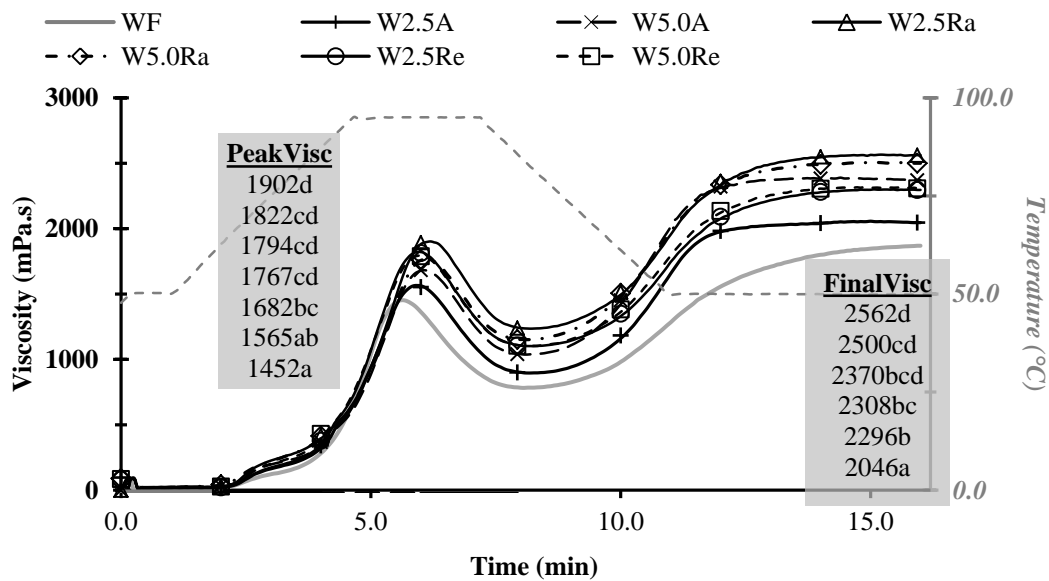

Figure 2 Pasting profiles of wheat flour (WF) and wheat-linseed fibre composites. For samples coding, see Table 1.

Water absorption of WF has risen according to enhancement level, as is documented in Table 2, no difference between three types of linseed fibre was observed. Dough development time was rather not influenced by dough recipe modifications, but dough stability did. The shorter stability about 7.00 min was revealed out for both composites containing brown linseed fibre (W2.5Re and W5.0Re), and similar values were recorded for dough with 5% dosage of both golden linseed fibre types (Table 2). Course of farinograph curves confirmed empirical knowledge about a reversal relationship between dough stability and its softening degree. Satisfying compactness of WF dough (55 FU) was lowered to half (100 FU, sample W2.5A) or almost to one-third (135 FU, sample W5.0Ra). In previous study (Hrušková and Švec, 2016), linseed fibre produced by Walramcom company had a reversal influence on dough softening degree. Koca and Anil (2007) incorporated flaxseed flour into wheat one at level 5%, and stated any changes in water absorption, but twice prolongation of dough development due to full-fat character of the alternative material. Stability of that composite dough was dough development due to full-fat character of the comparable to wheat control, but its softening degree increased twice.

Dough machinability was changed verifiably, as indicated elasticity-to-extensibility ratio after 60 min of

dough resting – value 1.94 of control was elevated to 2.31, 3.17 and 2.74 for dough composites W5.0A, W5.0Ra and W5.0Re, respectively. By Tukey’s test, mentioned differences were marked as significant (data not shown). Increase of extensigraph ratio means multiplying of dough elasticity by linseed addition, as documented Inglett et al. (2013) for flaxseed flour combined with barley one. Reversely, extensigraph energy decreased only softly, from 128.8 cm² to 117.5, 119.6 and 105.6 for composites in the same order as supra. There could be noticed, that addition of linseed fibre produced from brown seeds of Recital variety caused the highest change, although partially provable only. Wheat dough containing 5% of flaxseed flour exhibited similar extensigraph energy as control (111.0 vs. 107.0 cm², respectively; Koca and Anil, 2007). A clear drop in such bi-composite dough quality meant 20% dosage of the non-traditional material (85.0 cm²).

Evaluation of fermented dough behaviour

During simulation of three technological stages of the fermentation process, negative effect of linseed fibre on dough behaviour varied. Scatter in the fermentograph trait final dough volume was evaluated as the narrowest (homogenous groups ‘a’-‘b’). Contrary, dough proofing on maturograph was unequivocally dependent on dough composition, differentiating tested samples from ca 57%

Table 3 Quality features of leavened bread prepared from wheat flour and flour composites.

Flour, flour composite	Specific bread volume** (mL.100g ⁻¹)	Bread shape*, ** (-)	Crumb penetration** (mm)
WF	352a	0.65de	22.8ab
W2.5A	331a	0.69e	23.6b
W5.0A	349a	0.62cd	22.6ab
W2.5Ra	397b	0.62bcd	23.1ab
W5.0Ra	354a	0.53a	19.9a
W2.5Re	336a	0.58abc	21.5ab
W5.0Re	341a	0.56ab	22.0ab

Note: WF: wheat flour. Flax varieties: A – Amon, Ra - Raciol (both golden), Re – Recital (brown). Example of sample coding: W2.5A – wheat flour composite containing 2.5 wt. % of linseed fibre from variety Amon. * a – d: row means described by the same letter are not significantly different (p = 95%).

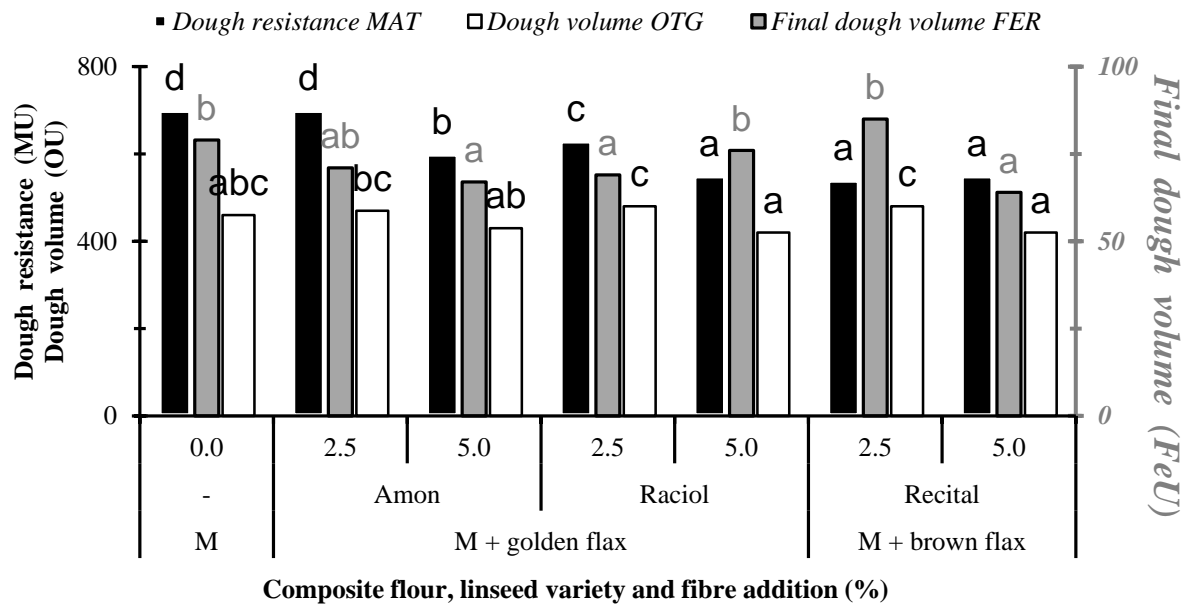

Figure 3 Rheological behaviour of leavened dough prepared from wheat flour (WF) and wheat-linseed fibre composites. Note: FER – fermentograph, MAT – maturograph, OTG – oven-rise recorder. For samples coding, see Table 1.

(feature dough resistance – 4 groups ‘a’ – ‘d’ from 7 possible). Within the third fermentation stage of simulated baking on the OTG apparatus, determined values fell into close interval 420-480 OTG units, allowing statistical distinguishing of 3 groups only (Figure 3).

Evaluation of wheat and wheat composite bread quality

In agreement with small changes in extensigraph energy, also specific volumes of bread enhanced by linseed fibre were assessed in narrow extent (331 – 397 mL.100 g⁻¹ vs. 352 mL.100 g⁻¹ for control, Table 3). With respect to measurement accuracy (±15 mL.100 g⁻¹), partial and significant rise of bun sizes could be considered for the sample W2.5Ra only (397 mL.100 g⁻¹).

Verifiably higher changes were found in bread pieces shape, for which some negative effect of increasing amount of linseed fibre could be remarked. Crumb of all bread modifications was very pleasant to masticate, as indicated penetration depth over 20 mm (Table 3). Golden and brown linseed fibre from New Zealand caused undoubtedly worsening of bread quality, a drop came to 33% (Hrušková and Švec, 2016). Bread shape as well as

crumb penetration got worse, too (e.g. range 5.8-10.4 vs. 14.3 mm for the latter feature). Flaxseed meal replacing 15% wheat flour also significantly lowered bread volume as well as increased crumb firmness about 8% and 40%, respectively (Conforti and Davis, 2006). Flaxseed hulls up to 3% in leavened bread recipe had no verifiable negative effect on bread volume; 5% of that flax form lowered bread volume about approx. 8% and increased crumb firmness about approx. 22% (Sęczyk et al., 2017). With respect to PCA results, the first two principal components (PC) explained 74% data variability, 57% by PC1 and 17% by PC2 (Figure 4). Within PC1 x PC2 plot, baking potential of flour composites decreased contrariwise along PC1 axis. As mentioned supra, wheat-linseed blends have partially lowered protein and consecutively dough quality, resulting in soft increase of dough softening degree (mixing tolerance index, MTI). Further, higher water absorption capacity of linseed was reflected in higher Peak Viscosity (PV). In summary, technological and bread quality of flour composites containing 5% of three types of linseed fibre were more or less comparable.

Table 4 Quality features of biscuits prepared from wheat flour and flour composites.

Flour, flour composite	Specific biscuit volume** (mL.100g ⁻¹)	Spread ratio*, ** (-)	Sensory profile** (-)
WF	139.9ab	4.00a	12.0a
W2.5A	150.1ab	3.68a	12.0a
W5.0A	142.2ab	3.55a	12.0a
W2.5Ra	143.4ab	3.53a	11.0a
W5.0Ra	153.7b	3.76a	11.0a
W2.5Re	127.1a	3.73a	11.0a
W5.0Re	129.5ab	4.34a	11.0a

Note: WF: wheat flour. Flax varieties: A - Amon, Ra – Raciol (both golden), Re – Recital (brown). Example of sample coding: W2.5A – wheat flour composite containing 2.5 wt. % of linseed fibre from variety Amon. * Diameter-to-height ratio. ** a – b: row means marked by the same letter are not statistically different (p = 95%).

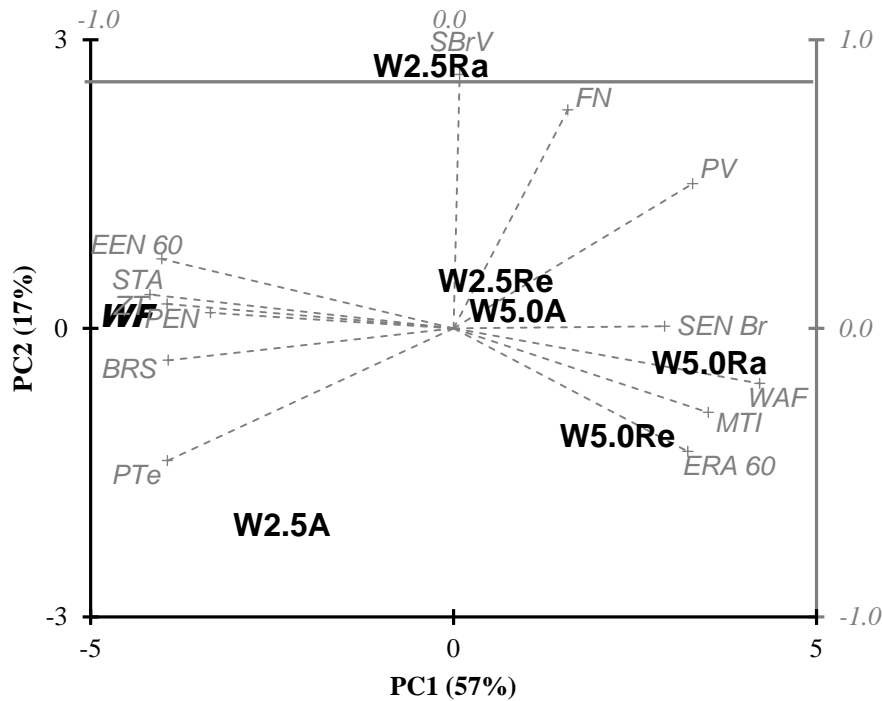

Figure 4 Principal component (PC) analysis of flax fibre effect on dough and bread technological quality. FN – Falling number, ZT – Zeleny test; WAB – water absorption, STA – dough stability, MTI – mixing tolerance index (dough softening degree); ERA 60, EEN 60 – extensigraph elasticity-to-extensibility ratio and energy, respectively (dough resting 60 min); PTe – pasting temperature, PV – peak viscosity; SBV – specific bread volume, BRS – bread shape (height-to- diameter ratio), PEN – crumb penetration, SEN Br – bread sensory profile. For samples coding, see Table 1.

Table 5 Quality features of pasta prepared from wheat flour and flour composites.

Flour, flour composite	Absorption* (%)	Swelling index* (-)	Sediment ^{†,*} (mL)
WF	159.2b	1.45a	120b
W2.5A	128.0a	1.51a	120b
W5.0A	130.4a	1.46a	100a
W2.5Ra	118.8a	1.43a	140c
W5.0Ra	124.4a	1.46a	120b
W2.5Re	129.6a	1.46a	110a
W5.0Re	126.8a	1.44a	120b

Note: WF: wheat flour. Flax varieties: A – Amon, Ra - Raciol (both golden), Re – Recital (brown). Example of sample coding: W2.5A – wheat flour composite containing 2.5 wt. % of linseed fibre from variety Amon. [†] Equivalent to cooking loss. * a – d: row means described by the same letter are not significantly different ($p = 95\%$).

Evaluation of wheat and wheat composite biscuits quality

Biscuit appearance was influenced in similar extent as wheat bread one – any of analysed factors (linseed type and addition level) was not recognized as dominant. In sweet composite dough, linseed fibre supported dough elasticity – during cooking, biscuit pieces retracted in diameter lowering their spread ratio (Table 4). Sensory analysis results show acceptability of all sweetmeat modifications. Linseed fibre moderated intensity of sweet taste, and mouthful seemed to be drier with lowered stickiness to teeth. **Khouryieh and Aramouni (2012)** confirmed our findings by statement, that incorporation of flaxseed flour up to 12% did not vary physical and sensory aspect of biscuits.

Principal components analysis confirmed presumed primary effect of extensigraph features (i.e. dough machinability) on biscuits quality. Summarised, PC1 x PC2 plot indicated a medium role of linseed addition level

– the higher non-traditional material ratio in recipe, the higher difference in biscuit quality related to WF control was observed (results not shown).

Evaluation of wheat and wheat composite pasta quality

Cooking proof of laboratory prepared elbow-pasta pointed at lowered water amount absorbed during boiling, perhaps due to higher fat content in composite flour. In further two pasta quality features, swelling index and sediment, any statistical differences were not evaluated. Cooking loss expressed as sediment volume in boiling water 1 hour after pasta straining varied accidentally without any observable tendency (Table 5). Brown linseed fibre produced by Walramcom company affected both absorption and sediment features (**Hrušková and Švec, 2016**). Higher quality of noodles could be attributed to products containing up to 3% of flax mucilage (**Kishk et al., 2011**).

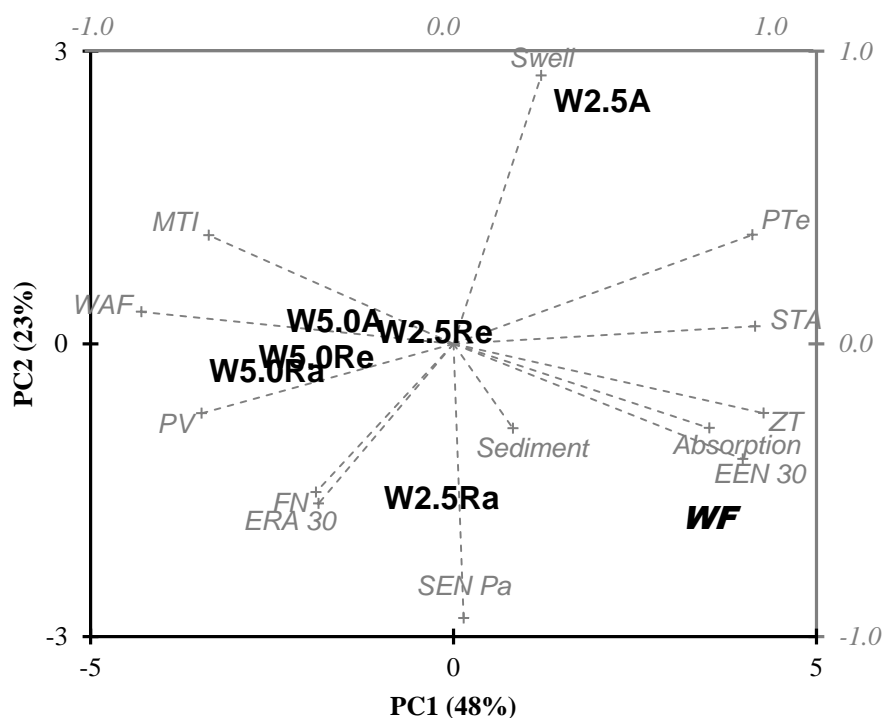

Figure 5 Principal component (PC) analysis of flax fibre effect on dough and pasta technological quality. FN – Falling number, ZT – Zeleny test; WAB – water absorption, DDE – dough development time, MTI – mixing tolerance index (dough softening degree); ERA 30, EEN 30 – extensigraph elasticity-to-extensibility ratio and energy, respectively (dough resting 30 min); PTe – pasting temperature, PV – peak viscosity; Absorption – amount of water absorbed by pasta, Swell – Swelling ratio, Sediment – height of sediment after pasta cooking, SEN Pa – pasta sensory profile. For samples coding, see Table 1.

Multivariate analysis of dough composition on wheat-linseed fibre pasta quality explained 71% of data scatter; PC1 and PC2 expressed 48% and 23% of data variance (Figure 5). Comparably to bread and biscuits, wheat pasta position in Figure 5 reflects higher protein and non-fermented dough quality. Samples W5.0A, W5.0Ra, W5.0Re are grouped together, based on higher water absorption during dough preparation on farinograph and reversely lower after proper pasta samples cooking. In our previous study (Hrušková and Švec, 2016), pasta quality was also dependent on golden and brown linseed granulation; dominant role was attributed to linseed type tested.

CONCLUSION

Nowadays, non-traditional or forgotten plant materials are recognized to be a functional component of novel food. Their benefit lies in presence of unsaturated fatty acids, dietary fibre or minerals, together able to correct some health or metabolic disharmony. Full-fat flaxseed flour or purified linseed fibre fulfil these presumptions, and our study documents its possible usage in cereal products, namely bread, biscuits and pasta. Leavened wheat-linseed fibre dough was characterised by higher water absorption, presenting important aspect for baker technologists. Such modified dough perhaps requests a shorter leavening stage in bakery to ensure optimal bread volume and crumb properties. Quality of composite cut-off biscuits was comparable to standard without dependence on golden or brown linseed type or their addition level. Fibre partially masked biscuits sweetness, and visible light orange-beige

dots in their surface may be attractive for consumers. Non-traditional materials also did not affect process of pasta pressing. Surface of pasta variants was smooth with recognizable spots of fibre particles. In cooked form, quality of elbow-pasta was statistically comparable to control, and optimal cooking time was 8.0 min for all seven samples.

REFERENCES

Chetana, Sudha, M. L., Begum, K., Ramasarma, P. R. 2010. Nutritional characteristics of linseed/flaxseed (*Linum usitatissimum*) and its application in muffin making. *Journal of Texture Studies*, vol. 41, no. 4, p. 563-578. <https://doi.org/10.1111/j.1745-4603.2010.00242.x>

Conforti, F. D., Davis, S. F. 2006. The effect of soya flour and flaxseed as a partial replacement for bread flour in yeast bread. *International Journal of Food Science and Technology*, vol. 41, no. Suppl. 2, p. 95-101.

Gutiérrez, C., Rubilar, M., Jara, C., Verdugo, M., Sineiro, J., Shene C. 2010. Flaxseed and flaxseed cake as a source of compounds for food industry. *Journal of Soil Science and Plant Nutrition*, vol. 10, no. 4, p. 454-463. <https://doi.org/10.4067/S0718-95162010000200006>

Hrušková, M., Švec, I. 2016. Flax – evaluation of composite flour and using in cereal products. *Potravinárstvo*, vol. 10, no. 1, p. 287-294. <https://doi.org/10.5219/594>

Inglett, G. E., Chen, D., Lee, S. 2013. Rheological properties of barley and flaxseed composites. *Food and Nutrition Sciences*, vol. 4, p. 41-48. <https://doi.org/10.4236/fns.2013.41007>

Kaewmanee, T., Bagnasco, L., Benjakul, S., Lanteri S., Morelli, C. F., Speranza, G., Cosulich, M. E. 2014. Characterisation of mucilages extracted from seven Italian

cultivars of flax. *Food Chemistry*, vol. 148, p. 60-69.

<https://doi.org/10.1016/j.foodchem.2013.10.022>

[PMid:24262527](https://pubmed.ncbi.nlm.nih.gov/24262527/)

Khouryieh, H., Aramouni, F. 2012. Physical and sensory characteristics of cookies prepared with flaxseed flour. *Journal of the Science of Food and Agriculture*, vol. 92, no. 11, p. 2366-2372. <https://doi.org/10.1002/jsfa.5642>

[PMid:22419245](https://pubmed.ncbi.nlm.nih.gov/22419245/)

Kishk, Y. F. M., Elsheshetawy, H. E., Mahmoud, E. A. M. 2011. Influence of isolated flaxseed mucilage as a non-starch polysaccharide on noodle quality. *International Journal of Food Science and Technology*, vol. 46, no. 3, p. 661-668.

<https://doi.org/10.1111/j.1365-2621.2010.02547.x>

Koca, A. F., Munir A. 2007. Effect of flaxseed and wheat flour blends on dough rheology and bread quality. *Journal of the Science of Food and Agriculture*, vol. 87, no. 6, p. 1172-1175. <https://doi.org/10.1002/jsfa.2739>

Manthey, F. A., Lee, R. E., Kegode, R. B. 2000. Quality of spaghetti containing ground flaxseed. In *Proceedings of the 58th Flax Institute of the U.S.* Fargo, ND : North Dakota State University, Fargo, ND, pp. 92-99.

Manthey, F. A., Sinha, S., Wolf-Hall, Ch. E. Hall, C. A. III 2008. Effect of flaxseed flour and packaging on shelf life of refrigerated pasta. *Journal of Food Processing and Preservation*, vol. 32, no. 1, p. 75-87.

Mazza, G., Biliaderis, C. G. 2006. Functional properties of flax seed mucilage. *Journal of Food Science*, vol. 54, no. 5, p. 1302-1305.

<https://doi.org/10.1111/j.1365-2621.1989.tb05978.x>

Oomah, B. 2001. Flaxseed as a functional food source. *Journal of Science in Food and Agriculture*, vol. 81, no. 4, p. 889-894. <https://doi.org/10.1002/jsfa.898>

Prazdnik, W., Loeppert, R., Vierstein, H., Mueller, M. 2016. Characterization of heteropolysaccharides from seed mucilage of chia (*Salvia hispanica* L.), basil (*Ocimum basilicum* L.), and flax (*Linum usitatissimum* L.) and their healthy functionality. In *International Conference on Polysaccharides*

– *Glycoscience*. Prague : Czech Chemical Society, p. 9-11. ISBN 978-80-86238-59-3.

Sęczyk, L., Swieca, M., Dziki, D., Anders, A., Gawlik-Dziki, U. 2017. Antioxidant, nutritional and functional characteristics of wheat bread enriched with ground flaxseed hulls. *Food Chemistry*, vol. 214, no. 1, p. 32-38.

<https://doi.org/10.1016/j.foodchem.2016.07.068>

[PMid:27507444](https://pubmed.ncbi.nlm.nih.gov/27507444/)

Troshchynska, Y., Synytsya, A., Kyselka, J., Štětina, J. 2016. Flaxseed meal mucilage polysaccharides: chemical characterization. In *International Conference on Polysaccharides – Glycoscience*. Prague : Czech Chemical Society, p. 273-277. ISBN 978-80-86238-59-3.

Xu, Y., Hall, C. A. III, Manthey, F. A. 2014. Effect of flaxseed flour on rheological properties of wheat flour dough and on bread characteristics. *Journal of Food Research*, vol. 3, no. 6, p. 83-91. <https://doi.org/10.5539/jfr.v3n6p83>

Acknowledgments:

This work was supported by grant NAZV OI 151 027. Authors gratefully thank to Ing. Jan Kyselka, Ph.D., Department of Dairy, Fat and Cosmetics of the UCT Prague, for preparation of all linseed fibre samples.

Contact address:

Marie Hrušková, University of Chemistry and Technology Prague, Faculty of Food and Biochemical Technology, Department of Carbohydrates and Cereals, Technická 5, 166 28 Praha 6, Czech Republic, E-mail: Marie.Hruskova@vscht.cz

Ivan Švec, University of Chemistry and Technology Prague, Faculty of Food and Biochemical Technology, Department of Carbohydrates and Cereals, Technická 5, 166 28 Praha 6, Czech Republic, E-mail: Ivan.Svec@vscht.cz



SELECTED PARAMETERS OF ARABICA COFFEE QUALITY AFFECTED BY ITS GEOGRAPHICAL ORIGIN

Alica Bobková, Martina Fikselová, Marek Šnirc

ABSTRACT

The aim of this paper was to evaluate selected parameters of Arabica coffee quality. Arabica coffee beans originated from 21 different regions of the world. Parameters of their moisture content, water extract, water extract in dry matter, dry matter, caffeine and caffeine content in dry matter were assessed by the Slovak Technical Standard. Dry matter content ranged from 98.64 to 99.07%, the highest content was measured in sample from Cuba. Minimum dry matter content was detected in coffee beans from Mexico. Caffeine in studied samples ranged from 10 200 mg.kg⁻¹ to 13 500 mg.kg⁻¹. The lowest caffeine content was determined in Panama coffee, the highest was found in the sample from Indonesia. The results of moisture content and caffeine in dry matter were evaluated by the Food Code of the Slovak Republic and all observed parameters in the coffee beans meet the maximum levels given in legislation. By statistical processing it can be seen that coffee samples originating from Ecuador, Indonesia and Nepal were similar in parameters of caffeine content and caffeine in dry matter. Other similar samples originating from Cuba, Peru, Ethiopia and Panama were statistically similar at dry matter content. Special statistical group was coffee from Salvador at the parameters of water extract and water extract in dry matter.

Keywords: coffee; Arabica; quality; caffeine; dry matter

INTRODUCTION

Coffee is one of the most popular beverages in the world. It is consumed for its refreshing and stimulating properties. Coffee is very common plant that grows throughout the tropical and subtropical zone. It is cultivated in the nutritious, and particularly acidic soil of plantations (Veselá, 2010). There are approximately 60 kinds of coffee, but from the economic point of view just three of them are important: *Coffea arabica* (70-75 % production), *Coffea robusta*- *canephora* and *Coffea liberica* (Burešová, 2016; Fodran et al., 2011). Arabica grows at higher altitudes. It is more demanding for planting, the first harvest it can have after 6 years of growing. Ideal temperature of cultivation is between 15 – 24 °C. Arabica contains lower percentage of caffeine than Robusta. To cultivate Robusta is less difficult than Arabica. The first harvest of Robusta is after 2 – 3 years. Robusta contains more caffeine than arabica, and has a bitter taste (Veselá, 2010). The quality of coffee depends on the moisture, origin, price, biochemical and taste qualities. It should be noted that each country can define its organoleptic properties (Leroy et al., 2006). Physical properties, chemical composition and properties of the drink prepared from roasted ground coffee of each species

are different (Farah, 2012). Due to its commercial importance, the detection of impurities and foreign matters in coffee has been a constant concern in fraud verification (De Moura Ribeiro et al., 2017).

Coffee is a complex mixture of compounds including carbohydrates, lipids, crude protein, vitamins, minerals, alkaloids, phenolic compounds and melanoidins. As biologically active class components in coffee are generally considered caffeine, chlorogenic acid and diterpenes (cafestol and kahweol) (Williamson, 2012). The best known sources of caffeine are coffee, cocoa beans, nuts and tea. Coffee beans contain between 0.8 and 2.8% of caffeine, depending on the type and origin. The caffeine content in coffee beans during roasting is not significantly affected (Phan et al., 2012). By roasting of the beans the water evaporates and aroma is formed (Burešová, 2016).

According to Slovak legislation, coffee is a product which is obtained by roasting of green coffee. The content of caffeine must be present in the amount of at least 0.6 percent in the dry matter. Caffeine is an alkaloid known as the stimulant of the central nervous system.

The aim of this work was to compare the selected chemical parameters of Arabica coffee quality, which originated from different geographical areas of the world.

MATERIAL AND METHODOLOGY

Observed material were Arabica coffee beans (Fig.1) which originated from 21 different geographical areas of the world: Nicaragua (1), Colombia (2), India (3) Mexico (4), Salvador (5), Brazil (6) Guatemala (7), Cuba (8), Costa Rica (9), Ethiopia (10), Indonesia (11), Kenya (12),

result was calculated as the mean of the two determinations.

Determination of caffeine (Slovak Technical Standard 580113-21)



Ecuador



Papua New Guinea



Mexico



Cuba

Figure 1 Coffee beans of Arabica originating from different countries (Hambáľková, 2013).

Peru (13), Dominican Republic (14), Papua New Guinea (15), Honduras (16), Ecuador (17), Jamaiva Blue Mountain (18), Indonesia Kopi Luwak (19), Nepal Mounth Everest (20), Panama (21).

Coffee beans were roasted and the subject for determination of the following parameters: moisture content, water extract and water extract in dry matter, caffeine content and caffeine in dry matter, the content of dry matter.

Dry mater determination (Slovak Technical Standard 580114)

3 g of the sample was placed in a vacuum oven (pressure 5.0 bar). Under the flow, the sample was dried for 16 hours in a vacuum oven at 70 °C. Dry matter content was calculated as a percentage of the weight of the sample. The

0.5 grams of ground coffee was weighed and transferred to 100 cm³ flask. To the flask were added 2 g of pure quartz sand and 5 cm³ of ammonia solution, mixed together and were allowed to stand for 3 minutes. Flask was placed for 2 minutes in a boiling water bath.

Alkaline and acidic column were used for determination according to given procedure. Then purification and extraction of caffeine were performed. Extinction of obtained solution was measured spectrophotometrically against chloroform. Wavelength 276 nm was applied. The content of caffeine in the test solution is determined from the measured values using a calibration curve.

Caffeine content in dry matter (%) was calculated using the formula (1):

$$(1) \quad X = \frac{1000 \cdot c}{m_0 \cdot (100 - w)} \cdot 100 \cdot 100$$

Where:

- c is the concentration of caffeine in the tested solution (obtained from the calibration curve), g.cm⁻³;
- m₀ is weight of sample in g;
- w is moisture in %.

Determination of moisture (Slovak Technical Standard 580113)

5 g of coffee beans was weighed and was crushed in purpose to 100% of the particles passed through the sieve of size 2.0 mm and 80% of the particles on the sieve size 1.0 mm. The sample was placed in an oven at (105 ± 1) °C. The sample was dried for 5 hours. Drying was repeated every 30 minutes as long as the difference between two measures is not more than 0.1%.

Water extract determination (Slovak Technical Standard 580113)

Water extract is the amount of substances which, under certain conditions are coming to the water solution. The milled coffee is boiled to reflux condenser, the obtained suspension is filtered and by the evaporation of a filtrate are determined water-soluble substances.

Statistical processing

Correlation coefficients among attributes were calculated by the Principal component analysis (PCA) at significance level (*p* < 0.05). All obtained results, including the graphical presentations, were processed using MS Excel (2010) and XLSTAT 2014 (Addinsoft, NY, USA) package program.

Our hypothesis was to characterise the selected chemical parameters of coffee samples in term of their possible variability associated with different origin of coffee.

RESULTS AND DISCUSSION

Production of quality coffee is characterized by climatic conditions and clearly shows that climate is an important factor in determining the quality of coffee (Da Silva et al., 2005).

The dry matter content of our samples ranged from 98.64% to 99.07%. The highest content of dry matter (99.07%) was measured in sample originating from Cuba. Minimum dry matter content of 98.64% was detected in of coffee beans from Mexico. Dry matter content decreased in the following order: Cuba (99.07%), Honduras (98.96%), Peru (98.93%), Ethiopia (98.93%), Salvador (98.92%); Indonesia (98.88%), Papua New Guinea (98.87%), Panama Geisha (98.85%), Jamaiva Blue Mountain (98.84%), Kenya (98.82%), Costa Rica (98.82%), Brazil (98.81%), Nicaragua (98.79%), the Dominican Republic (98.77%), Indonesia Kopi Luwak (98.73%), Colombia (98.71%), India (98.7%), Nepal Mounth Everest (98.69%), Guatemala (98.67%), Ecuador (98.65%), Mexico (98.64%). Hoffmann (2014) indicates that coffee beans have initial moisture content approx. 60% and by the drying process they should be dried to the moisture content 11 – 12%, to avoid their spoliage. Also by Burešová (2016) green coffee contains approx. 12 % water. By roasting water evaporates (to 3 % content). As it was expected, very strong negative correlation was observed between dry matter and moisture. The moisture content of the samples ranged from 0.93% to 1.36%. Correlation coefficients were statistically different at significance level (*p* < 0.05). Low moisture content 0.93% was measured in the coffee from Cuba. The highest value was measured in the sample from Mexico (1.36%).

Table 1 Observed chemical parameters of Arabica coffee quality.

Origin/Parameter	Caffeine (mg.kg ⁻¹)	Caffeine in DM (% DM)	Dry matter (%)	Water extract (%)	Water extract in DM (%)
Nicaragua	12100	1.21	98.79	30.87	31.25
Colombia	11900	1.21	98.71	31.2	31.61
India	12600	1.28	98.7	31.37	31.78
Mexico	12000	1.22	98.64	32.05	32.49
Salvador	11400	1.15	98.92	38.81	39.23
Brazil	12300	1.24	98.81	29.67	30.03
Guatemala	12000	1.22	98.67	29.98	30.38
Cuba	11800	1.19	99.07	29.41	29.69
Costa Rica	12600	1.28	98.82	31.47	31.85
Etiopia	10900	1.1	98.93	30.4	30.73
Indonesia	12500	1.26	98.88	31.1	31.45
Kenya	11500	1.16	98.82	30.3	30.66
Peru	11400	1.15	98.93	29.45	29.77
Dominican republic	11800	1.19	98.77	30.12	30.49
Papua New Guinea	12100	1.22	98.87	30.55	30.9
Honduras	11900	1.2	98.96	29.83	30.14
Ecuador	12200	1.24	98.65	31.28	31.71
Jamaiva Blue Mountain	12600	1.28	98.84	30.28	30.64
Indonesia Kopi Luwak	13500	1.37	98.73	30.53	30.92
Nepal Mounth Everest	13100	1.33	98.69	31.04	31.45
Panama Geisha	10200	1.03	98.85	29.18	29.52

Table 2 Factor scores of centroids for Arabica coffee in PC1 vs. PC2 dimension and their squared cosines.

Parameter/Origin	F1		F2	
	Factor score	cos ²	Factor score	cos ²
Nicaragua (1)	0.2324	0.4978	-0.0321	0.0095
Colombia (2)	0.8391	0.4027	0.2207	0.0279
India (3)	1.4905	0.7644	0.2573	0.0228
Mexico (4)	1.6684	0.5052	0.8077	0.1184
Salvador (5)	-1.2801	0.0441	5.9438	0.9500
Brazil (6)	0.3120	0.0863	-0.9621	0.8209
Guatemala (7)	1.2520	0.4256	-0.7045	0.1348
Cuba (8)	-2.7423	0.6176	-0.9942	0.0812
Costa Rica (9)	0.8305	0.4002	0.2800	0.0455
Ethiopia (10)	-2.6503	0.9577	-0.0929	0.0012
Indonesia (11)	0.0563	0.0019	0.0496	0.0015
Kenya (12)	-0.8373	0.5475	-0.3209	0.0804
Peru (13)	-2.0276	0.8333	-0.9003	0.1643
Dominican Republic (14)	0.0149	0.0003	-0.5299	0.3481
Papua New Guinea (15)	-0.4436	0.3070	-0.2634	0.1083
Honduras (16)	-1.5824	0.5906	-0.7314	0.1261
Ecuador (17)	1.7999	0.7189	0.2017	0.0090
Jamaiva Blue Mountain (18)	0.5664	0.1713	-0.5875	0.1843
Indonesia (19)	2.8175	0.7720	-0.6283	0.0384
Nepal Mounth Everest (20)	2.6629	0.9613	-0.1713	0.0040
Panama (21)	-2.9793	0.5963	-0.8422	0.0477

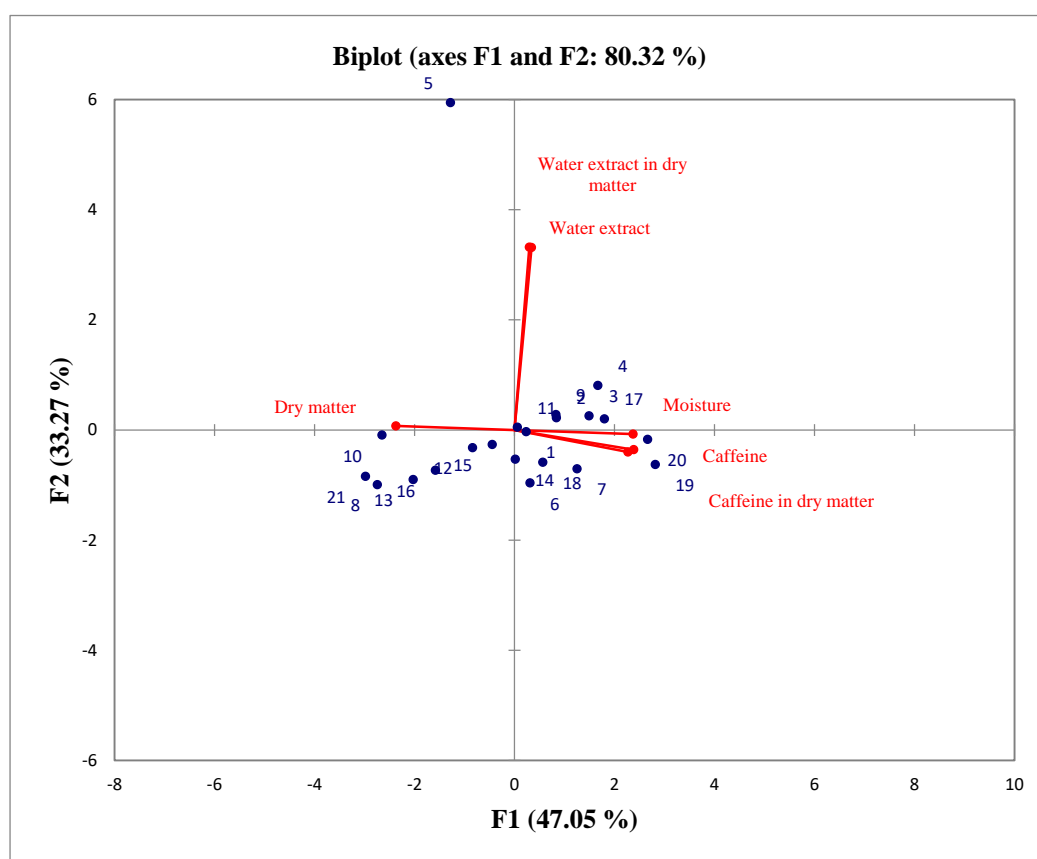

Figure 2 Map of PC1 and PC2 with observations. The labels correspond to sample notation given in the Table 2.

By the **Law 309/2015** of the Slovak republic the moisture content of the coffee should be max. 5%. Following this requirement, all our samples were in accordance with legislation. By **Leroy et al. (2006)** moisture is important indicator of quality coffee. The high moisture content of the grains results in the loss of material and the physical

and sensory problems. Water evaporation caused by roasting, accounts for 40 % weight reduction of coffee bean (**Fodran et al., 2011**).

Water extract content of our samples ranged from 29.18% to 38.81%. Minimum content of it was determined in Panama coffee. The highest content (38.81%) was

determined in sample from Salvador. The content of water extract in dry matter ranged from 29.52% to 39.23% (Table 1). The lowest content of the water extract in dry matter (29.52%) was confirmed in samples from Panama again. The highest value of water extract in dry matter 39.23% was confirmed in samples from Salvador.

Caffeine and important constituents of coffee, have been shown to possess biological activities that highlight a possible mechanistic link to the pathology of depression. Bioactive coffee constituents have been shown to positively influence various parameters, including inflammation, oxidative stress and behaviour, associated with the neuroinflammatory hypotheses of depression in both in vitro and in vivo studies (Hall et al., 2015). Dziki et al. (2015) presented possibilities of using green coffee beans from Ethiopia, Kenya, Brazil and Colombia as a functional additive. Bread enriched with green coffee beans possessed higher antiradical activity than control samples.

Our observed coffee samples ranged in caffeine content from 10 200 mg.kg⁻¹ to 13 500 mg.kg⁻¹. The lowest caffeine content was found in Panama coffee, the highest was found in the sample from Indonesia. Caffeine decreases in the following order: Indonesia Kopi Luwak (13 500 mg.kg⁻¹), Nepal Mounth Everest (13 100 mg.kg⁻¹), Blue Mountain Jamaiva (12 600 mg.kg⁻¹), Costa Rica (12 600 mg.kg⁻¹), India (12 600 mg.kg⁻¹), Indonesia (12 500 mg.kg⁻¹), Brazil (12 300 mg.kg⁻¹), Ecuador (12 200 mg.kg⁻¹), Papua New Guinea (12 100 mg.kg⁻¹), Nicaragua (12 100 mg.kg⁻¹), Guatemala (12 000 mg.kg⁻¹), Mexico (12 000 mg.kg⁻¹), Honduras (11 900 mg.kg⁻¹), Colombia (11 900 mg.kg⁻¹), Cuba (11 800 mg.kg⁻¹), Dominican Republic (11 800 mg.kg⁻¹), Kenya (11 500 mg.kg⁻¹), Peru (11 400 mg.kg⁻¹), Salvador (11 400 mg.kg⁻¹), Ethiopia (10 900 mg.kg⁻¹), Panama (10 200 mg.kg⁻¹).

By statistical procesing (Figure 2) it can be noted that samples of coffee originating from Ecuador, Indonesia and Nepal (19, 20, 17) were similar at the parameters of caffeine content and caffeine in dry matter. Other group of samples originating from Cuba, Peru, Ethiopia, Panama (8, 13, 10, 21) were statistically similar at dry matter content. Special sample was coffee from Salvador (5) in parameter of water extract and water extract in dry matter.

As it was expected statistically there was observed a strong positive correlation between caffeine and caffeine in dry matter and water extract and water extract in dry matter. Correlation coefficients were statistically different at significance level ($p < 0.05$). Caffeine content in dry matter of our coffee samples ranged from 1.03% to 1.37%. The lowest caffeine content in dry matter 1.03%, was found in the sample from Panama. The highest content of 1.37% was determined in the sample from Indonesia. By the **Law 309/2015 of the Slovak republic** the caffeine content in dry matter should be min. 0.6%. Following this requirement all our samples were in accordance with legislation. Content of caffeine and chlorogenic acid in commercial coffee brands were determined by Phan et al. (2015) in Czech, Vietnamese and Brazilian ground roasted coffee brands. The lower content of caffeine was observed in Vietnamese coffees. Among our countries the sample from Panama was the lowest in caffeine, water extract, caffeine in dry matter as well.

Noguchi et al. (2015) performed a study in healthy volunteers with a cup of either caffeinated or decaffeinated coffee. Caffeinated coffee intake significantly elevated blood pressure and decreased finger blood flow as compared with decaffeinated coffee intake. There was no significant difference in heart rate between caffeinated and decaffeinated coffee intake. Caffeine in a cup of coffee enhances microvascular function in healthy individuals.

Table 2 presents factor scores and squared cosines of our samples, which are the coordinates and representation qualities, respectively, of the centroids in the 2-D space. Results in bold correspond for each observation to the factor for which the squared cosine is the largest. All these variables from table 2 are placed in the loading plot (Figure 2). The first two principal components (PC) explain more than 80% of total variation for analyzed variables. Šnirc et al. (2016) found the first five PC analyzing chemical and technological parameters in red deer meat explained more than 85% of total variability of those measurements.

The PC1 in our case, accounting for 47.05% of the inertia (Figure 2), contrasted dry matter with moisture, and caffeine content and caffeine in dry matter whereas PC2, explaining 33.26% of the inertia, clearly reflected the different content of water extract and water extract in dry matter for tested coffee variables.

CONCLUSION

We can conclude that our samples of Arabica coffee originating from the different places of the world were affected by climatic conditions at observed parameters of quality. Among selected 21 countries, the sample from Panama was the lowest in caffeine content, water extract and caffeine in dry matter as well.

However, all observed samples of coffee beans were in accordance with the required legislative requirements, regarding their moisture content and caffeine content in dry matter as well.

REFERENCES

- Addinsoft, 2014. XLSTAT, Analyse de données et statistique avec MS Excel [online] s.a. [cit. 2017-03-02] Available at: <https://www.xlstat.com/fr/formation/formation-en-ligne-analyse-de-donnees-avec-xlstat>.
- Burešová, P. 2016. Káva (Coffee). In Fišera, M. et al. *Gastronomy- selected chapters (Gastronomie- vybrané kapitoly)*. Český Tešín: Václav Helán- 2 Theta, p. 70-71. ISBN 978-80-86380-78-0.
- Da Silva, E. A., Mazaffera, P., Brunini, O., Sakai, E., Arruda, F. B., Mattoso, L. H. C., Carvalho, C. R. L., Pires, R. C. M. 2005. The influence of water management and environmental conditions on the chemical composition and beverage quality of coffee beans. *Brazilian Journal of Plant Physiology*, vol. 17, no. 2, p. 229-238. <https://doi.org/10.1590/S1677-04202005000200006>
- De Moura Ribeiro, M. V., Borallo, N., Redigolo Pezza, H., Pezza, L., Toci, A. T. 2017. Authenticity of roasted coffee using 1H NMR spectroscopy. *Journal of Food Composition and Analysis*, vol. 57, p. 24-30. <https://doi.org/10.1016/j.jfca.2016.12.004>
- Dziki, D., Dziki, G., Pecio, U. et al. 2015. Ground green coffee beans as a functional food supplement – Preliminary study. *LWT - Food Science and Technology*, vol. 63, p. 691-699.

- Farah, A. 2012. Coffee constituents. In Chu, Y. F. *Coffee: Emerging Health Effects and Disease Prevention*. USA : Wiley-Blackwell. 352 p. ISBN 978-0-470-95878-0. <https://doi.org/10.1002/9781119949893.ch2>
- Fodran, P., Brezová, V., Hybenová, E. et al. 2011. *Food Chemistry (Chémia potravín)*. Bratislava: STU. 394 p. ISBN 978-80-227-3569-8.
- Hall, S., Desbrow, B., Anoopkumar-Dukie, Shailendra et al. 2015. A review of the bioactivity of coffee, caffeine and key coffee constituents on inflammatory responses linked to depression. *Food Research International* [online], vol. 76, pp. 626-636 <http://dx.doi.org/10.1016/j.foodres.2015.07.027>
- Hambáľková, B. 2013. *Analysis of coffee in terms of its quality and safety (Analýza kávy z pohľadu jej kvality a bezpečnosti)*. Nitra : SPU. 71 p.
- Hoffmann, J. 2014. *The World Atlas of Coffee: from beans to brewing – coffees explored, explained and enjoyed*. 1st ed. London : Octopus Publishing Group Ltd. 256 p. ISBN 978-1-84533-787-2.
- Law 309/2015 of the Slovak republic no. 309/2015 Col. about snacks, edible salt, dehydrated dishes, soups and flavorings (VYHLÁŠKA č. 309 Ministerstva pôdohospodárstva a rozvoja vidieka Slovenskej republiky zo 4. novembra 2015 o pochutinách, jedlej soli, dehydrovaných pokrmoch, polievkových prípravkoch a o ochucovadlách)*. Zbierka zákonov č.309/2015.
- Leroy, T., Ribeyre, F., Bertrand, B., Charmetant, P., Dufour, M., Montagnon, Ch., Marraccini, P., Pot, D. 2006. Genetics of coffee quality. *Brazilian Journal of Plant Physiology*, vol. 18, no. 1, p. 229-242. <https://doi.org/10.1590/S1677-04202006000100016>
- Noguchi, K., Matsuzaki, T., Sakanashi, M. et al. 2015. Effect of caffeine contained in a cup of coffee on microvascular function in healthy subjects. *Journal of Pharmacological Sciences* 127 p. 217-222. <http://dx.doi.org/10.1016/j.jphs.2015.01.003>
- Phan, T. T. D., Bittová, M., Mikulášek, K., Kubán, V., Kráčmar, S., Valášek, P., Svobodová, B. 2015. Content of 4(5) -methylimidazole, caffeine and chlorogenic acid in commercial coffee brands. *Potravinárstvo*, vol. 9, no. 1, p. 31-38. <https://dx.doi.org/10.5219/422>
- Phan, T. T. D., Kubán, V., Kráčmar, S. 2012. Determination of caffeine contents in vietnamese and czech coffee. *Journal of Microbiology, Biotechnology and Food Sciences*, vol. 1, special no., p. 995-1002.
- Slovak Technical Standard (STN) 580113:1991. *Methods of coffee evaluation (Metódy skúšania kávy)*.
- Slovak Technical Standard (STN) 580113-21:1991. *Methods of coffee evaluation. Caffeine determination (Metódy skúšania kávy. Stanovenie kofeínu)*.
- Slovak Technical Standard (STN) 580114:2000. *Methods for testing of coffee extracts and chicory (Metódy skúšania extraktov kávy a cigórie)*.
- Šnirc, M., Král, M., Ošťádalová, M., Golian, J., Tremlová, B. 2017. Application of principal component analysis method for characterization chemical, technological, and textural parameters of farmed and pastured red deer. *International Journal of Food Properties*, vol. 20, no. 4, p. 1-8. <https://doi.org/10.1080/10942912.2016.1180532>
- Veselá, P. 2010. *Book about the coffee (Kniha o káve)*. Praha : Smart Press s.r.o., 180 p. ISBN 978-80-87049-34-1.
- Williamson, G. 2012. Coffee and Health. In Crozier, A. et al. *Teas, Cocoa and Coffee: Plant Secondary Metabolites and Health*. 1st ed. UK : Wiley-Blackwell. 270 p. ISBN 1-4443-3441-8.

Contact address:

Alica Bobková, Slovak University of Agriculture, Faculty of Biotechnology and Food Sciences, Department of Hygiene and Food Safety, Tr. A. Hlinku 2, 949 76 Nitra Slovakia, E-mail: alica.bobkova@uniag.sk

Martina Fikselová, Slovak University of Agriculture, Faculty of Biotechnology and Food Sciences, Department of Hygiene and Food Safety, Tr. A. Hlinku 2, 949 76 Nitra Slovakia, E-mail: martina.fikselova@uniag.sk

Marek Šnirc, Slovak University of Agriculture, Faculty of Biotechnology and Food Sciences, Department of Animal Products Evaluation and Processing, Tr. A. Hlinku 2, 949 76 Nitra Slovakia, E-mail: marek.snirc@uniag.sk



ANTIOXIDANT PROPERTIES, TOTAL PHENOLIC AND TOTAL FLAVONOID CONTENT OF THE SLOVAK WHITE WINES – WELSCHRIESLING AND CHARDONNAY

Daniel Bajčan, Július Árvay, Alena Vollmannová, Judita Bystrická, Pavol Trebichalský, Ľuboš Harangozo, Vladimír Šimanský

ABSTRACT

The biologically active compounds in wines, especially phenolics, are responsible for reduced risk of developing chronic diseases (cardiovascular diseases, cancer, diabetes, Alzheimer disease, *etc.*), due to their antioxidant activities. Twenty six Slovak white wines, produced from different geographical origins, were examined in this study. The antioxidant activity, total phenolic and flavonoid contents of two types monovarietal wines – Welschriesling and Chardonnay were evaluated. All three mentioned parameters were determined by UV-VIS absorption spectrometry. The results showed that both types of Slovak white wines were high in polyphenols (average content was 303.2 mg GAE.L⁻¹ in Welschriesling, resp. 355.6 mg GAE.L⁻¹ in Chardonnay) and flavonoids (average content was 51.9 mg CE.L⁻¹ in Welschriesling, resp. 60.1 mg CE.L⁻¹ in Chardonnay), as well as a high antioxidant activity (average value was 35.0% inhibition of DPPH in Welschriesling, resp. 43.3% inhibition of DPPH in Chardonnay), comparable to the wines produced in other regions in the world. Among the white wines, Chardonnay had higher content of total polyphenols, as well as flavonoids and higher values of antioxidant activity. Our results confirmed very strong linear correlations between all three analysed parameters (TPC, TFC and AA): TPC and TFC ($r = 0.818$), AA and TPC ($r = 0.699$), resp. TFC and AA ($r = 0.693$).

Keywords: antioxidant activity; flavonoid; polyphenol; white wine

INTRODUCTION

The terms antioxidant and free radical are popular expressions used by nutritionists, scientists and general public. Free radicals are chemical species, compounds and/or elements with one or two unpaired electrons in their outer layer, which can be created in a multiple ways. They can be exogenic (e.g. ultraviolet radiation, xenobiotics and infections) or endogenic (Andzi Barhé and Feuya Tchouya, 2014). A lack of antioxidant or an overproduction of free radicals can lead to an imbalance between the oxidant and antioxidant system (Guerci et al, 2001; Puitha et al., 2005). Oxidative stress is involved in several illnesses, including diabetes (Huang et al., 2004), atherosclerosis, Alzheimer's disease and Parkinson's disease (Drobek-Slowik and Karczewicz, 2007). The provision of antioxidants through diet is a simple means to reduce the development of illnesses brought on by oxidative stress (Zafra-Stone et al., 2007).

Wine is an alcoholic fermented beverage with considerable amounts of phytochemicals (Gresele et al., 2011). Wine is very rich source of polyphenols, such as catechins, epicatechins, quercetin, rutin, myricetin, anthocyanins, phenolic acids (gallic acid, caffeic acid,

p-coumaric acid, *etc.*), trans-resveratrol and many others polyphenols and compounds. Many of these compounds have been reported to have multiple biological activities, including cardioprotective, anti-carcinogenic, antiviral and antibacterial properties (King et al., 2006; Santos-Buelga and Scalbert, 2000; Špakovská et al., 2012). To date, over 3000 flavonoids have been identified. These can mainly be found in the pigments in flowers or in leaves (Marfak, 2003). Flavonoids are primarily known for their anti-oxidative (Bruneton, 1999), vasculoprotective (Vitor et al., 2004), anti-inflammatory (Chen et al., 2008) and anti-diabetic (Marfak, 2003) properties. Currently, chemoprevention is being used in medicine as a new strategy to prevent cancers. Natural phytochemicals, including wine and/or grape polyphenols, appear to be very promising substances to block, reverse, retard or prevent the process of carcinogenesis (Russo, 2007).

The total amount of polyphenols in wines has been estimated to range from 200 to 6000 mg.L⁻¹ (Quideau et al., 2011). The highly variable level of phenolic compounds in wine is due to differences in grape variety and source as well as processing. Wine polyphenols have been reported to be bioavailable in several studies

(Nardini et al., 2009; Vitaglione et al., 2005). These compounds are directly related to the quality of wines, so phenolic analysis can be used as an effective tool in characterizing different wines. Many factors can influence the phenolic composition of wines, including grape variety and the technology applied (Mulero et al., 2011).

The purpose of this study was to determine and evaluate chosen properties (the content of total polyphenols, content of total flavonoids and antioxidant activity) and their mutual correlations in white wines – Welschriesling (typical Central European variety) and Chardonnay (most famous world variety), originated from 3 most important Slovak vineyard areas.

MATERIAL AND METHODOLOGY

Chemicals and instruments

All analysed parameters – content of total polyphenols, content of total flavonoids and antioxidant activity in wines were analyzed using UV/VIS spectrophotometry (spectrophotometer Shimadzu UV/VIS – 1240, Shimadzu, Japan). The chemicals used for all analysis were: Folin-Ciocalteu reagent, monohydrate of gallic acid p.a., anhydrous sodium carbonate p.a., aluminium chloride p.a., sodium nitrite p.a., sodium hydroxide p.a., 35%, catechin hydrate 98%, methanol p.a., 2,2-diphenyl-1-picrylhydrazyl (DPPH) radical p.a.

Samples

Analysed, bottled, white, especially dry wines Welschriesling (WR), resp. Chardonnay (CH) and their characteristics are mentioned in Table 1 and 2. Wine samples with origin in various Slovak vineyard areas (VA) were purchased in retail network, to provide that analysed samples of wine would have the same properties as wines that are consumed by common consumers (properties of wine affected by various factors, such as period and conditions of storage or distribution of wine).

Methods

Antioxidant activity determination

Antioxidant activity (AA) was assessed by method of Brand-Williams et al. (1995) using of DPPH (2,2-diphenyl-1-picrylhydrazyl) radical. This method is based on the reduction of DPPH in methanol solution in the

presence of a hydrogen-donating antioxidant due to the formation of the nonradical form DPPH-H (Chanda and Dave, 2009). This transformation results in a color change from purple to yellow, which is measured spectrophotometrically. Briefly, 0.1 mL of white wine was added to 3.9 mL of a 6×10^{-5} mol.L⁻¹ solution of DPPH in methanol. A control sample containing the same volume of water instead of extract was used to measure the maximum DPPH absorbance. After the reaction had been allowed to take place in the dark for 10 min, the absorbance at 515.6 nm was recorded to determine the concentration of remaining DPPH. The percentage inhibition of the initial concentration of DPPH radical was calculated as: % inhibition = [(ADPPH - A_{wine})/ADPPH] x 100. The results were also expressed as Trolox equivalent antioxidant capacity using calibration curve method.

Determination of total polyphenol content

Total polyphenol content (TPC) was determined by modified method of Singleton and Rossi (1965). 0.1 mL of wine sample was pipetted into 50 mL volumetric flask and diluted with 5 mL of distilled water. To diluted mixture 2.5 mL Folin-Ciocalteu reagent was added and after 3 minutes 7.5 mL of 20% solution of Na₂CO₃ was added. Then the sample was filled with distilled water to volume 50 mL and after mixing left at the laboratory temperature for 2 hours. By the same procedure the blank and calibration solutions of gallic acid were prepared. Absorbance of samples solutions was measured against blank at 765 nm. The content of total polyphenols (TP) in wines was calculated as amount of gallic acid equivalent (GAE) in mg per 1 litre of wine.

Determination total flavonoid content

Total flavonoid content (TFC) was assessed by aluminium chloride method (Chang et al., 2002). 1 mL of wine sample and 4 mL of deionised water were added to a 10 mL volumetric flask. 5 min after adding 0.3 mL of 5% sodium nitrite, 0.3 mL of 10% aluminium chloride was added. 2 mL of sodium hydroxide with concentration 1 mol.L⁻¹ was added to the reaction mixture after 6 min incubation. The final volume was immediately made up to 10 mL with deionised water. The absorbance of the solution was measured at 510 nm against blank solution.

Table 1 Characteristics of analysed Welschriesling wine samples.

Sample	Producer	Vineyard area	Vintage	Quality
WR-1	Villa Víno Rača, Bratislava	Little Carpathian	2011	quality
WR-2	Malokarpatská vinohrad. spol., Pezinok	Little Carpathian	10/2012 ^d	quality
WR-3	Víno Matyšák, Pezinok	Little Carpathian	2011	quality
WR-4	Víno Jano, Limbach	Little Carpathian	10/2014 ^d	quality
WR-5	Virex, Nesvady	South Slovak	5/2011 ^d	quality
WR-6	VVD, Dvory nad Žitavou	South Slovak	2011	quality
WR-7	Vitis Pezinok / Hubert J.E. Sered'	South Slovak	2012	quality
WR-8	Víno Matyšák, Pezinok	South Slovak	2013	quality
WR-9	Víno Nitra, Nitra	Nitra	2011	quality
WR-10	Vinárske závody Topoľčianky, Topoľčianky	Nitra	2011	quality
WR-11	Vinárstvo Šintavan, Šintava	Nitra	2010	cabinet
WR-12	Vinárstvo Trnovec, Nitra	Nitra	2013	quality

^d – date of bottling (unknown vintage).

Table 2 Characteristics of analysed Chardonnay wine samples.

Sample	Producer	Vineyard area	Vintage	Quality
CH-1	Mrva & Stanko, Trnava	Little Carpathian	2010	late harvest
CH-2	Villa Víno Rača, Bratislava	Little Carpathian	2011	quality
CH-3	Chateau Zumberg, Pezinok	Little Carpathian	2012	quality
CH-4	Víno Matyšák, Pezinok	Little Carpathian	2013	quality
CH-5	Vitis Pezinok / Hubert J.E. Sered'	South Slovak	2011	quality
CH-6	Víno Nitra, Nitra	South Slovak	2011	quality
CH-7	Vinárske závody Topoľčianky, Topoľčianky	South Slovak	2012	late harvest
CH-8	Chateau Modra, Modra	South Slovak	2011	select harvest
CH-9	Víno Velkeer 1113, Veľký Kýr	South Slovak	2014	late harvest
CH-10	Vinárstvo Trnovec, Nitra	Nitra	2011	select harvest
CH-11	Vinárske závody Topoľčianky, Topoľčianky	Nitra	2012	quality
CH-12	Ivan Czako, Nit. Hrnčiarovce	Nitra	2011	late harvest
CH-13	Peter Belan, Mojmírovce	Nitra	2013	late harvest
CH-14	PD Mojmírovce, Mojmírovce	Nitra	2012	select harvest

The content of total flavonoids (TF) in wine samples was calculated as amount of catechin equivalent (CE) in mg per 1 litre of wine.

Statistical analysis

Statistical analysis were performed using the software Statistica 6.0 (StatSoft) and the results were evaluated by analysis of variance ANOVA.

RESULTS AND DISCUSSION

All studied parameters – the content of total polyphenols, the content of total flavonoids and antioxidant activity of the slovak wines Welschriesling, resp. Chardonnay are described in Table 3 and Table 4.

Total polyphenol content in analysed Welschriesling wine samples was in the range from 247.5 to 388.1 mg GAE.L⁻¹. Average content of TP was 303.2 mg GAE.L⁻¹. The results are very similar to results reported by Slezák (2007), who found out the content of TP in slovak wines – Welschriesling in range from 250 to 361 mg GAE.L⁻¹ (average value was 304.6 GAE.L⁻¹). Other (foreign) scientists (Li et al., 2009; Lužar et al., 2016; Ma et al.,

2014) analyzing TPC in WR wines reported also very similar results (219 – 445 mg GAE.L⁻¹). Ivanova et al. (2010) and Stratil et al. (2008) reported much lower average value of TPC (205, resp. 97 mg GAE.L⁻¹) in WR wines. On the other hand, Sato et al. (1996) found out much higher phenolic content (721 mg GAE.L⁻¹) in one wine sample of Welschriesling. According to the average value of TPC an order for wines – Welschriesling could be as following: wines from Nitra VA >wines from South Slovak VA >wines from Little Carpathian VA. Gained results did not exert statistically significant differences (at significance level $p = 0.05$) between TPC in wines – Welschriesling made in various vineyard areas in Slovakia.

Total polyphenol content in analysed Chardonnay wine samples was in the range from 280.2 to 475.1 mg GAE.L⁻¹. Average content of TP was 355.6 mg GAE.L⁻¹. Our results are very similar to results reported by Chircu Brad et al. (2012) and Ma et al. (2014), who found out the content of TP in wines – Chardonnay in range from 275 to 454 mg GAE.L⁻¹. Other scientists (Frankel et al., 1995; Li et al., 2009; Minussi et al., 2003 and Stratil et al., 2008) analyzing TPC in CS wines reported much lower average

Table 3 The content of total polyphenols (TPC), content of total flavonoids (TFC) and antioxidant activity (AA) in analysed wines Welschriesling.

Wine sample	TPC (mg GAE.L ⁻¹ ±SD)	TFC (mg CE.L ⁻¹ ±SD)	AA (% inhib. ±SD)	AA (mmol Trolox.L ⁻¹ ±SD)
WR-1L	327.2 ±2.5	58.9 ±0.5	33.0 ±1.0	0.375 ±0.012
WR-2L	272.3 ±9.4	44.2 ±1.1	28.2 ±0.7	0.321 ±0.009
WR-3L	289.6 ±2.3	44.5 ±3.0	29.9 ±0.7	0.340 ±0.009
WR-4L	247.5 ±6.5	42.4 ±1.8	44.2 ±0.5	0.501 ±0.006
Average LCVA	284.2 ±38.7^a	47.5 ±8.0^a	33.8 ±7.8^a	0.384 ±0.087^a
WR-5S	317.6 ±4.7	61.1 ±2.0	35.5 ±0.5	0.403 ±0.006
WR-6S	275.0 ±14.2	45.6 ±3.5	29.5 ±0.7	0.335 ±0.009
WR-7S	292.7 ±2.4	44.0 ±1.1	30.3 ±1.1	0.344 ±0.014
WR-8S	310.7 ±6.4	44.7 ±1.1	33.9 ±0.7	0.385 ±0.009
Average SSVA	299.0 ±20.7^b	48.9 ±8.3^b	32.3 ±2.9^b	0.367 ±0.023^b
WR-9N	342.3 ±9.7	55.0 ±1.1	32.7 ±0.9	0.371 ±0.011
WR-10N	388.1 ±11.8	83.7 ±0.5	42.5 ±1.6	0.482 ±0.020
WR-11N	293.7 ±3.1	49.4 ±0.4	41.6 ±0.8	0.472 ±0.010
WR-12N	281.2 ±8.7	49.6 ±3.4	38.8 ±0.5	0.440 ±0.006
Average NVA	326.3 ±52.0^c	59.4 ±16.7^c	38.9 ±4.8^b	0.441 ±0.054^b
Total average	303.2 ±37.3	51.9 ±11.8	35.0 ±5.5	0.397 ±0.062

Note: ^{a-c} Values with the same letters denote significant differences ($p < 0.05$) among vineyard areas.

LCVA – Little Carpathian vineyard area, SSVA – South Slovak vineyard area, NVA – Nitra vineyard area.

Table 4 The content of total polyphenols (TPC), content of total flavonoids (TFC) and antioxidant activity (AA) in analysed wines Chardonnay.

Wine sample	TPC (mg GAE.L ⁻¹ ±SD)	TFC (mg CE.L ⁻¹ ±SD)	AA (% inhib. ±SD)	AA (mmol Trolox.L ⁻¹ ±SD)
CH-1L	376.7 ±2.5	57.3 ±0.8	42.1 ±1.1	0.477 ±0.014
CH-2L	314.9 ±4.7	42.3 ±0.5	34.5 ±0.9	0.391 ±0.011
CH-3L	321.2 ±5.2	67.5 ±3.3	47.3 ±0.5	0.537 ±0.006
CH-4L	324.8 ±6.2	65.2 ±3.4	44.0 ±0.3	0.499 ±0.004
Average LCVA	334.4 ±30.0^a	58.1 ±12.2^a	42.0 ±6.2^a	0.476 ±0.071^a
CH-5S	288.0 ±4.6	47.9 ±1.6	31.9 ±0.8	0.362 ±0.010
CH-6S	357.4 ±2.5	50.9 ±0.5	32.5 ±1.5	0.369 ±0.019
CH-7S	475.1 ±4.8	92.5 ±0.5	76.3 ±1.9	0.924 ±0.023
CH-8S	389.3 ±5.3	92.3 ±1.3	47.5 ±0.8	0.540 ±0.010
CH-9S	377.9 ±5.0	64.4 ±1.4	39.4 ±0.7	0.447 ±0.009
Average SSVA	377.5 ±76.2^b	69.6 ±19.2^b	45.5 ±19.1^b	0.528 ±0.242^b
CH-10N	371.2 ±4.7	52.5 ±1.2	40.3 ±0.5	0.457 ±0.006
CH-11N	435.4 ±2.5	82.3 ±1.1	48.4 ±3.2	0.550 ±0.040
CH-12N	280.2 ±4.8	35.9 ±0.5	32.8 ±1.8	0.372 ±0.022
CH-13N	353.3 ±9.6	47.4 ±1.0	45.3 ±0.8	0.514 ±0.010
CH-14N	313.2 ±3.7	43.2 ±1.9	44.1 ±0.4	0.500 ±0.005
Average NVA	350.7 ±66.7^c	52.3 ±20.0^c	42.2 ±6.7^c	0.479 ±0.077^c
Total average	355.6 ±54.6	60.1 ±18.2	43.3 ±11.1	0.496 ±0.140

Note: ^{a-c} Values with the same letters denote significant differences ($p < 0.05$) among vineyard areas.

LCVA – Little Carpathian vineyard area, SSVA – South Slovak vineyard area, NVA – Nitra vineyard area.

value of TPC (119 – 258 mg GAE.L⁻¹) in CH wines.

According to the average value of TPC an order for wines – Chardonnay could be as following: wines from South Slovak VA >wines from Nitra VA >wines from Little Carpathian VA. Gained results also did not exert statistically significant differences (at significance level $p = 0.05$) between TPC in wines – Chardonnay made in various vineyard areas in Slovakia.

Total flavonoid content in analysed Welschriesling wine samples varied from 42.4 to 83.7 mg CE.L⁻¹. Average content of TF was 51.9 mg CE.L⁻¹. Similar results (42.5 – 89.7 mg CE.L⁻¹) were reported by **Ivanova et al. (2010)**, **Li et al. (2009)** and **Ma et al. (2014)**. According to the average value of TFC an order for wines – Welschriesling could be as following: wines from Nitra VA >wines from South Slovak VA >wines from Little Carpathian VA. Gained results did not exert statistically significant differences (at significance level $p = 0.05$) between TFC in wines – Welschriesling made in various vineyard areas in Slovakia.

Total flavonoid content in analysed Chardonnay wine samples was in the range from 35.9 to 92.5 mg CE.L⁻¹. Average content of TF was 60.1 mg CE.L⁻¹. Our results are in agreement with the data of **Li et al. (2009)**, **Ma et al. (2014)** and **Mitic et al. (2010)** who found out TFC in range 31.0 – 94.2 mg CE.L⁻¹. **Chircu Brad et al. (2012)** determined lower values of total flavonoid content in Chardonnay wines which varied from 16.7 to 63.7 mg CE.L⁻¹. On the other hand, **Lee and Rennaker (2007)** found out much higher TFC (85.5 – 249 mg CE.L⁻¹) in Chardonnay wine samples. According to the average value of TFC an order for wines – Chardonnay could be as following: wines from South Slovak VA >wines from Little Carpathian VA >wines from Nitra VA. Gained results also did not exert statistically significant differences (at significance level $p = 0.05$) between TFC in

wines – Chardonnay made in various vineyard areas in Slovakia.

Antioxidant activity in analysed Welschriesling wine samples was in range 28.2 – 44.2% inhibition of DPPH (0.321 – 0.501 mmol Trolox.L⁻¹). Average value of AA was 35.0% inhibition of DPPH (0.397 mmol Trolox.L⁻¹). Our data are in agreement with the results published by **Li et al. (2009)** and **Ma et al. (2014)** who determined values of AA in the range 0.26 – 0.602 mmol Trolox/L. Slightly lower values of AA reported **Slezák (2007)**, who found out AA in slovak wines – Welschriesling in the range from 20.11 to 41.95% inhibition of DPPH (average value was 30.9% inhibition of DPPH). On the basis of value of AA for wines – Welschriesling an order could be as following: wines from Nitra VA >wines from Little Carpathian VA >wines from South Slovak VA. Gained results exert statistically significant differences between values of antioxidant activity in wines made in South Slovak VA and AA in wines made in Nitra VA.

Antioxidant activity in analysed Chardonnay wine samples was in range 31.9 – 76.3% inhibition of DPPH (0.362 – 0.924 mmol Trolox.L⁻¹). Average value of AA was 43.3% inhibition of DPPH (0.496 mmol Trolox.L⁻¹). Similar data (49.1 – 74.7% inhibition of DPPH, resp. 0.082 – 0.87 mmol Trolox.L⁻¹) were reported by **Chircu Brad et al. (2012)**, **Li et al. (2009)**, **Ma et al. (2014)** and **Stratil et al., (2008)**. On the basis of value of AA for wines – Chardonnay an order could be as following: wines from South Slovak VA >wines from Nitra VA >wines from Little Carpathian VA. Gained results also did not exert statistically significant differences (at significance level $P = 0.05$) between values of AA in wines – Chardonnay made in various vineyard areas in Slovakia.

The results showed that both types of Slovak white wines were high in polyphenols and flavonoids, as well as a high antioxidant activity, comparable to the wines produced in other regions in the world. Similar conclusions were

reported by Sák et al. (2013) and Špakovská et al. (2012) who analysed Slovak white and red wines.

In order to investigate the mutual relations between analyzed parameters, the linear regressions were obtained. The statistical evaluation of the obtained results confirmed very highly significant correlations at significance level $p < 0.001$ between all 3 studied parameters: TPC and TFC ($r = 0.818$), AA and TPC ($r = 0.699$), resp. TFC and AA ($r = 0.693$). This was consistent with many other articles in the literature, which also reported a very high degree of correlation between the total phenols, total flavonoids and antioxidant properties of wines (Chircu Brad et al., 2012; Li et al., 2009; Ma et al., 2014 and Minussi et al., 2003).

CONCLUSION

The phenolic, resp. flavonoid content and antioxidant properties of white wines (Welschriesling and Chardonnay) made in 3 most important Slovak vineyard areas was evaluated in the present study. All 3 studied parameters of analysed Slovak wines – total polyphenol content, total flavonoid content and antioxidant activity are comparable to the wines produced in other regions in the world. Slovak white wines – Welschriesling and Chardonnay have high content of healthy useful phenolic compounds and high antioxidant activity. The results didn't showed statistically significant differences for all 3 studied parameters (except AA in Welschriesling) in wines made in different vineyard areas in Slovakia. On the basis of statistical evaluation of our results we can state that statistically very highly significant correlations were demonstrated between all 3 parameters (TPC, TFC and AA).

REFERENCES

Barhé, T. A, Feuya Tchouya, G. R. 2016. Comparative study of the anti-oxidant activity of the total polyphenols extracted from *Hibiscus Sabdariffa* L., *Glycine max* L. Merr., yellow tea and red wine through reaction with DPPH free radicals. *Arabian Journal of Chemistry*, vol. 9, no. 1, p. 1-8. <http://dx.doi.org/10.1016/j.arabjc.2014.11.048>

Brand-Williams, W., Cuvelier, M. E., Berset, C. 1995. Use of a free radical method to evaluate antioxidant activity. *Lebensmittel Wissenschaft und Technologie – Food Science and Technology*, vol. 28, no. 1, p. 25-30. [http://dx.doi.org/10.1016/s0023-6438\(95\)80008-5](http://dx.doi.org/10.1016/s0023-6438(95)80008-5)

Bruneton, J. 1999. *Pharmacognosie, phytochimie et plantes médicinales*. 5th ed. Paris : La Voisier TEC et DOC. p. 250-270. ISBN 2743011882.

Chanda, S., Dave, R. 2009. In vitro models for antioxidant activity evaluation and some medicinal plants possessing antioxidant properties: An overview. *African Journal of Microbiology Research*, vol. 3, no. 13, p. 981-996.

Chang, C. C., Yang, M. H., Wen, H. M., Chern, J. C. 2002. Estimation of total flavonoid content in propolis by two complementary colometric methods. *Journal of Food and Drug Analysis*, vol. 10, no. 3, p. 178-182.

Chen, H. Q., Jin, Z. Y., Wang, X. J., Xu, X. M., Deng, L., Zhao, J. W., 2008. Luteolin protects dopaminergic neurons from inflammation-induced injury through inhibition of microglial activation. *Neuroscience Letters*, vol. 448, no. 2, p. 175-179. <http://doi.org/10.1016/j.neulet.2008.10.046>

Chircu Brad, C., Muste, S., Mudura, E., Bobis, O. 2012. The content of polyphenolic compounds and antioxidant activity of three monovarietal wines and their blending, used

for sparkling wine production. *Bulletin UASVM serie Agriculture*, vol. 69, no. 2, p. 222-227.

Drobek-Slowik, M., Karczewicz, D. K., 2007. The potential role of oxidative stress in the pathogenesis of the age-related macular degeneration (AMD). *Postepy Higieny i Medycyny Doswiadczalnej*, vol. 61, p. 28-37. [PMid:17245315](http://pubmed.ncbi.nlm.nih.gov/17245315/)

Frankel, E. N., Waterhouse, A. L., Teissedre, P. L. 1995. Principal phenolic phytochemicals in selected California wines and their antioxidant activity in inhibiting oxidation of human low-density lipoproteins. *Journal of Agricultural and Food Chemistry*, vol. 43, no. 4, p. 890-894. <http://dx.doi.org/10.1021/jf00052a008>

Gresele, P., Cerletti, C., Guglielmini, G., Pignatelli, P., de Gaetano, G., Violi, F. 2011. Effects of resveratrol and other wine polyphenols on vascular function: an update. *The Journal of nutritional biochemistry*, vol. 22, no. 3, p. 201-211. <http://dx.doi.org/10.1016/j.jnutbio.2010.07.004>

Guerci, B., Bohme, P., Kearney-Schwartz, A., Zannad, F., Drouin, P. 2001. Endothelial dysfunction and type 2 diabetes. Part 2: Altered endothelial function and the effects of treatments in type 2 diabetes mellitus. *Diabetes & Metabolism*, vol. 27, no. 4, p. 436-447. [PMid:11547217](http://pubmed.ncbi.nlm.nih.gov/11547217/)

Huang, D. J., Lin, C. D., Chen, H. J., Lin, Y. H. 2004. Antioxidant and antiproliferative activities of sweet potato (*Ipomoea batatas* [L.] Lam 'Tainong 57') constituents. *Botanical Bulletin of Academia Sinica*, vol. 45, p. 179-186.

Ivanova, V., Stefova, M., Chinnici, F. 2010. Determination of the polyphenol contents in Macedonian grapes and wines by standardized spectrophotometric methods. *Journal of the Serbian Chemical Society*, vol. 75, no. 1, p. 45-59. <https://doi.org/10.2298/JSC1001045I>

King, R. E., Bomser, J. A., Min, D. B. 2006. Bioactivity of resveratrol. *Comprehensive Reviews in Food Science and Food Safety*, vol. 5, no. 3, p. 65-70. <http://doi.org/10.1111/j.1541-4337.2006.00001.x>

Lee, J., Rennaker, C. 2007. Antioxidant capacity and stilbene contents of wines produced in the Snake River Valley of Idaho. *Food Chemistry*, vol. 105, no. 1, p. 195-203. <http://dx.doi.org/10.1016/j.foodchem.2007.03.069>

Li, H., Wang, X., Li, Y., Li, P., Wang, H. 2009. Polyphenolic compounds and antioxidant properties of selected China wines. *Food chemistry*, vol. 112, no. 2, p. 454-460. <http://doi.org/10.1016/j.foodchem.2008.05.111>

Lužar, J., Jug, T., Jamnik, P., Košmerl, T. 2016. Comparison of total polyphenols content and antioxidant potential of wines from 'Welschriesling' and 'Sauvignon Blanc' varieties during ageing on fine lees. *Acta Agriculturae Slovenica*, vol. 107, no. 2, p. 473-482. <http://doi.org/10.14720/aas.2016.107.2.18>

Ma, T. T., Sun, X. Y., Gao, G. T., Wang, X. Y., Liu, X. Y., Du, G. R., Zhan, J. C. 2014. Phenolic Characterisation and Antioxidant Capacity of Young Wines Made From Different Grape Varieties Grown in Helanshan Donglu Wine Zone (China). *South African Journal of Enology and Viticulture*, vol. 35, no. 2, p. 321-331. <http://dx.doi.org/10.21548/35-2-1020>

Marfak, A. 2003. *Radiolyse gamma des flavonoides: Étude de leur réactivité avec les radicaux issus des alcools: formation des depsides* : dissertation theses. France : University of Limoges. 220 p.

Minussi, R. C., Rossi, M., Bologna, L., Cordi, L., Rotilio, D., Pastore, G. M., Duran, N. 2003. Phenolic compounds and total antioxidant potential of commercial wines. *Food Chemistry*, vol. 82, no. 3, p. 409-416. <http://dx.doi.org/10.1016/j.jfoodmicro.2013.11.008>

- Mitic, M. N., Obradović, M. V., Grahovac, Z. B., Pavlović, A. N. 2010. Antioxidant capacities and phenolic levels of different varieties of Serbian white wines. *Molecules*, vol. 15, no. 3, p. 2016-2027. <http://doi.org/10.3390/molecules15032016>
- Mulero, J., Zafrilla, P., Cayuela, J. M., Martinez-Cacha, A., Pardo, F. 2011. Antioxidant activity and phenolic compounds in organic red wine using different winemaking techniques. *Journal of Food Science*, vol. 76, no. 3, p. C436-C440. <http://dx.doi.org/10.1111/j.1750-3841.2011.02104.x>
- Nardini, M., Forte, M., Vrhovsek, U., Mattivi, F., Viola, R., Scaccini, C. 2009. White wine phenolics are absorbed and extensively metabolized in humans. *Journal of Agricultural and Food Chemistry*, vol. 57, no. 7, p. 2711-2718. <https://doi.org/10.1021/jf8034463>
- Punitha, I. S. R., Rajendran, K., Shirwaikar, A., Shirwaikar, A., 2005. Alcoholic stem extract of *Coscinium fenestratum* regulates carbohydrate metabolism and improves antioxidant status in streptozotocinnicotinamide induced diabetic rats. *Evidence-based Complementary and Alternative Medicine*, vol. 2, no. 3, p. 375-381. <http://dx.doi.org/10.1093/ecam/neh099>
- Quideau, S., Deffieux, D., Douat-Casassus, C., Pouysegou, L. 2011. Plant polyphenols: Chemical properties, biological activities and synthesis. *Angewandte Chemie (International ed. in English)*, vol. 50, no. 3, p. 586-621. <http://dx.doi.org/10.1002/anie.201000044>
- Russo, G. L. 2007. Ins and outs of dietary phytochemicals in cancer chemoprevention. *Biochemical Pharmacology*, vol. 74, no. 4, p. 533-544. <http://dx.doi.org/10.1016/j.bcp.2007.02.014>
- Santos-Buelga, C., Scalbert, A. 2000. Proanthocyanidins and tannin-like compounds-nature, occurrence, dietary intake and effects on nutrition and health. *Journal of the Science of Food and Agriculture*, vol. 80, p. 1094-1117. <http://dx.doi.org/10.1016/j.bcp.2007.02.014>
- Sák, M., Dokupilová, I., Lakatošová, J., Šajbidor, J. 2013. Characterization of polyphenols in Slovak red wines cv. Cabernet Sauvignon. *Potravinárstvo*, vol. 7, special no., p. 209-213. http://www.potravinarstvo.com/dokumenty/mc_march_2013/bezpecnost_potraviny_rastlinneho_povodu/sak.pdf
- Sato, M., Ramarathnam, N., Suzuki, Y., Ohkubo, T., Takeuchi, M., Ochi, H. 1996. Varietal differences in the phenolic content and superoxide radical scavenging potential of wines from different sources. *Journal of Agricultural and Food Chemistry*, vol. 44, no. 1, p. 37-41. <http://dx.doi.org/10.1021/jf950190a>
- Singleton, V. L., Rossi, J. A. 1965. Colorimetry of total phenolics with phosphomolybdic-phosphotungstic acid reagents. *American Journal of Enology and Viticulture*, vol. 16, no. 3, p. 144-158.
- Slezák, F. 2007. Preserving of antioxidant components in wines from Little Carpathian region: research report. Biocentrum Modra and VÚP Bratislava, Modra, Slovakia. 19 p.
- Stratil, P., Kubáň, V., Fojtová, J. 2008. Comparison of the phenolic content and total antioxidant activity in wines as determined by spectrophotometric methods. *Czech Journal of Food Sciences*, vol. 26, no. 4, p. 242-253.
- Špakovská, E., Marcinčák, S., Bača, M., Turek, P. 2012. Polyphenolic content and antioxidative activity of wines from Sobrance region. *Potravinárstvo*, vol. 6, no. 3, p. 32-35. <http://dx.doi.org/10.5219/204>
- Vitaglione, P., Sforza, S., Galaverna, G., Ghidini, C., Caporaso, N., Vescovi, P. P., Fogliano, V., Marchelli, R. 2005. Bioavailability of trans-resveratrol from red wine in humans. *Molecular Nutrition & Food Research*, vol. 49, no. 5, p. 495-504. <http://dx.doi.org/10.1002/mnfr.200500002>
- Vitor, R. F., Mota-Filipe, H., Teixeira, G., Borges, C., Rodrigues, A. I., Teixeira, A., Paulo, A. 2004. Flavonoids of an extract of *Pterospartum tridentatum* showing endothelial protection against oxidative injury. *Journal of Ethnopharmacology*, vol. 93, no. 2-3, p. 363-370. <http://dx.doi.org/10.1016/j.jep.2004.04.003>
- Zafra-Stone, S., Yasmin, T., Bagchi, M., Chatterjee, A., Vinson, J. A., Bagchi, D., 2007. Berry anthocyanins as novel antioxidants in human health and disease prevention. *Molecular Nutrition & Food Research*, vol. 51, no. 6, p. 675-683. <http://dx.doi.org/10.1002/mnfr.200700002>

Acknowledgments:

The work was supported by the Slovak Science Foundation VEGA (Grant no. 1/0308/14 and 1/0290/14).

Contact address:

Daniel Bajčan, Slovak University of Agriculture in Nitra, Faculty of Biotechnology and Food Sciences, Department of Chemistry, Tr. Andreja Hlinku 2, 949 76 Nitra, Slovakia, E-mail: bajcan@gmail.com

Július Árvay, Slovak University of Agriculture in Nitra, Faculty of Biotechnology and Food Sciences, Department of Chemistry, Tr. Andreja Hlinku 2, 949 76 Nitra, Slovakia, E-mail: julius.arvaymail.com

Alena Vollmannová, Slovak University of Agriculture in Nitra, Faculty of Biotechnology and Food Sciences, Department of Chemistry, Tr. Andreja Hlinku 2, 949 76 Nitra, Slovakia, E-mail: alena.vollmannova@uniag.sk

Judita Bystrická, Slovak University of Agriculture in Nitra, Faculty of Biotechnology and Food Sciences, Department of Chemistry, Tr. Andreja Hlinku 2, 949 76 Nitra, Slovakia, E-mail: judita.bystricka@uniag.sk

Pavol Trebichalský, Slovak University of Agriculture in Nitra, Faculty of Biotechnology and Food Sciences, Department of Chemistry, Tr. Andreja Hlinku 2, 949 76 Nitra, Slovakia, E-mail: pavol.trebichalsky@uniag.sk

Ľuboš Harangozo, Slovak University of Agriculture in Nitra, Faculty of Biotechnology and Food Sciences, Department of Chemistry, Tr. Andreja Hlinku 2, 949 76 Nitra, Slovakia, E-mail: harangozolubos@gmail.com

Vladimír Šimanský, Slovak University of Agriculture in Nitra, Faculty of Agrobiological and Food Resources, Department of pedology and geology, Tr. Andreja Hlinku 2, 949 76 Nitra, Slovakia, E-mail: vladimir.sinamsky@uniag.sk

THE CONTENT OF POLYPHENOLS AND CHOSEN HEAVY METALS IN FABA BEAN (*FABA VULGARIS* MOENCH) RELATING TO DIFFERENT DOSES OF ZINC APPLICATION

Mária Timoracká, Alena Vollmannová, Dalaram Sulaiman Ismael

ABSTRACT

We investigated the impact of zinc on chosen heavy metals contents (Cu, Zn, Co, Cd, Pb, Cr, Ni) and polyphenols content and antioxidant capacity of chosen legume. Used soil was from Cakajovce locality (located in Nitra upland) with the neutral soil reaction suitable for the legume cultivation. Determined Cd content as well as Pb content in the soil was on the level of critical value given for the relationship between soil and plant. The values of both elements were far below threshold values proposed by European Commission. In experiment we used two cultivars of fababean – Saturn, Zobor. Seeds of fababean were harvested in milk ripeness. The different high doses of zinc (as $ZnSO_4 \cdot 7H_2O$) were applied into the uncontaminated soil in model conditions. The strong statistical relationship between added Zn content in the soil and in seeds of both faba bean cultivars as well as was the total polyphenols content and the total antioxidant capacity values was confirmed. In all variants the determined Zn amount was below (Saturn) or slightly above (Zobor) the hygienic limit given by the legislative. On the other hand faba bean of both cultivars accumulated high amounts of Pb and Cd – in all variants higher than hygienic limits. The contents of all other heavy metals (Ni, Co, Cr, Cu) were lower than hygienic limits. The polyphenols content ranged from 2208 to 4622 milligrams per kilogram of fresh sample calculated as gallic acid equivalents. Faba bean shows a very small antioxidant capacity – 4.66 – 5.71% of DPPH inhibition.

Keywords: antioxidant capacity; heavy metals; faba bean; polyphenol; zinc

INTRODUCTION

Agricultural production is the main source of foodstuffs, it is important to evaluate negative effects of risky elements on quality of agricultural products. The monitoring of heavy metals content is very important because consumption of legume is necessary for human nutrition. Soil is a dynamic system which is influenced by various factors, whether natural or anthropic, causing the contamination. Changes that occur due to these factors in the soil cause bioaccessibility of metals and can enrich the soil with other elements that are biologically active, or contrary, degrade a land, and it becomes inappropriate for crop growth. Heavy metals occur naturally in the ecosystem with large variations in concentration. Living organisms require varying amounts of "heavy metals." Iron, cobalt, copper, manganese, molybdenum, and zinc are required by humans. Excessive levels can be harmful to the organism. Certain elements that are normally toxic, for certain organisms or under certain conditions, beneficial. Some of these elements are actually necessary for humans in trace amounts (cobalt, copper, chromium, manganese, nickel) while others are carcinogenic or toxic, affecting, among others, the central nervous system

(manganese, mercury, lead, arsenic), the kidneys or liver (mercury, lead, cadmium, copper) or skin, bones, or teeth (nickel, cadmium, copper, chromium) (Cimoláková and Nováková, 2009). Plants which exhibit hyperaccumulation can be used to remove heavy metals from soils by concentrating them in their biomatter. Reference Reference Rutkowska et al. (2014) reported the higher Zn concentration can be projected in the soil solution of acidic soils when compared with soils with neutral soil reaction.

Legumes are rich and inexpensive source of nutrients to millions of peoples but also an excellent Zn accumulator (Genççelep et al., 2009). Zn as well as Cu are essential micronutrients, they can be toxic when taken in excess. Lead and cadmium are nonessential metals as they are toxic, even in trace (Genççelep et al., 2009). Relations between toxic metals (Pb, Cd) and essential elements (eg. Zn) are very important for mineral balance, because heavy metals can cause a lack of some essential elements in plants. Next, the presence of antinutrient, e.g. polyphenols seems to be one of the reasons why zinc is a limiting nutrient in many diets of people. On the other hand, polyphenols presence in food is connected with antioxidant effect on human health. The quantitative

determination of phenolic compound content as well as their antioxidant capacity may provide valuable information in considering health-promoting properties of legume seeds (Dalaram, 2017). Turco et al., (2016) reported that immature faba bean fractions have significantly higher phytochemical contents and display a better antioxidant activity than those of mature ones.

Therefore we investigated the effect of accumulation of heavy metals in faba bean (milk ripeness) grown in model conditions in the targeted contaminated soil with increasing rates of the selected heavy metal (zinc). Zinc was added to the soil to reduce the intake of other heavy metals, especially of Cd or Pb (these elements are present in the soil above the hygienic limit on most territory of the Slovak Republic) as well as to determine the level of beneficial and safety intake of observed elements on human organism. Neither, we also investigated the effect of accumulation of selected micronutrient content (zinc) on total polyphenols and antioxidant activity assessed in faba bean grown in soil with increasing rates of the zinc doses.

MATERIAL AND METHODOLOGY

In the pot experiments the soil from locality Cakajovce was used. Slovak village Cakajovce is located in Nitra upland with annual rainfall 600 – 700 mm and annual temperature 8 – 9 °C. Before the realization of pot experiments the soil from this locality was sampled by valid method with pedological probe GeoSampler fy. Fisher.

Two cultivars of faba bean (Saturn, Zobor) used in the pot experiments were obtained from the Research Centre of Plant Production in Piestany (Slovakia). Faba beans were harvested in milk ripeness.

In model conditions of the vegetation pot experiments realised at the Department of Chemistry, we investigated the effect of addition of independent increasing rates of selected micronutrient (zinc) into the soil and its consecutive accumulation and polyphenols production in faba bean seeds.

Zinc was applied in the form of $ZnSO_4 \cdot 7H_2O$.

For cvs. Zobor and Saturn, the experiments were realised:

A: control (without Zn addition)

B: 40 mg $Zn \cdot kg^{-1}$ of soil (hygienic limit)

C: 250 mg $Zn \cdot kg^{-1}$ of soil (half dose of analytically significant contamination)

D: 500 mg $Zn \cdot kg^{-1}$ of soil (analytically significant contamination)

The experiment was based on four replications in each variant.

Chemical analysis of the soil

Analyses were conducted in samples of soil ground on fine soil I. and from this fine soil the representative sample was taken and sieved through the sieve with average 0.2 mm (fine soil II). In each soil sample the exchangeable reaction (pH/KCl), the contents of available nutrients (K, Mg, P) and mobile forms of Ca according Mehlich II. and content of humus by Tjurin method were determined. Pseudototal content of risk metals including all of the forms besides residual metal fraction was assessed in soil extract by aqua regia and content of mobile forms of selected heavy metals in soil extract by NH_4NO_3 ($c = 1$

$mol \cdot dm^{-3}$) and HNO_3 ($c = 2 mol \cdot dm^{-3}$). Gained results were evaluated according to Law No. 220/2004 – extract by NH_4NO_3 and Decision of Ministry of Agriculture in Slovak republic about highest acceptable limits of toxic compounds in soil No. 531/1994 – 540 – extract by HNO_3 (valid in the Slovak Republic) as well as threshold values proposed by European Commission (EC) (2006). Analytical ending was flame AAS (AAS Varian AA Spectr DUO 240 FS/240Z/UltrAA).

Heavy metals in the plant material

The samples of legume seeds were collected from the same sampling points as the soil samples. After their drying and regulation the plant samples were decomposed with using of HNO_3 in the microwave digestion instrument MARS X-PRESS. The solutions were analyzed by flame AAS (AAS Varian AA Spectr DUO 240 FS/240Z/UltrAA). Gained results in $mg \cdot kg^{-1}$ of fresh mater (FM) were evaluated according to the Food Codex of the Slovakia valid in the Slovak Republic (FC SR) as well as according to Commission Regulation 1881/2006 (CR). Maximum levels for the content of risky metals in foodstuffs in these legislative norms are given in $mg \cdot kg^{-1}$.

Phenolics extraction

Phenolic compounds were extracted from seeds by preparation of methanol extracts. Methanol is a typical solvent for the extraction of phenolic acids and flavonoids. For 12 hours extraction, dry milled material (10 g) was used and continuously extracted by a Twisselmann extractor with methanol (80%, v/v).

Total polyphenol content determination (TP)

The amount of total phenolics was determined using Folin-Ciocalteu reagent (FCR) (Merck, Germany) according to Lachman et al. (2003). Sample extracted (0.05 g to 1 mL of 80% methanol according to the expected polyphenol content), 2.5 mL of FCR and 3 mL of H_2O were added to a 50 mL flask. After 3 minutes 7.5 mL of Na_2CO_3 (20%) were also added to the flask and diluted to 50 mL with H_2O . The mixture was then incubated for two 2 h at laboratory temperature and the absorbance was measured at 765 nm on a Shimadzu spectrophotometer (710, Shimadzu, Kyoto, Japan) against a blank (sample extract replaced with 80% methanol). The amount of total phenolics was calculated as gallic acid equivalents (GAE) in milligrams per kilogram of fresh sample.

Total antioxidant capacity determination (TAC)

For the analysis of free radical scavenging activity 2,2-diphenyl-1-picrylhydrazyl (DPPH) was used according to Brand-Williams et al. (2005). To obtain a stock solution: 0,025 g of DPPH (Sigma-Aldrich) was diluted to 100 mL with methanol (Spectranal Rideld de Haen, Hanover, Germany), and kept in a cool and dark place. Immediately before the analysis, a 1:10 dilution of the stock was made with methanol. For the analysis, 3.9 mL of the DPPH working solution was added to a cuvette and the absorbance at 515 nm was measured (At_0) with a Shimadzu spectrophotometer (Shimadzu, Kyoto, Japan). Subsequently, 0.1 mL of the extract was added to the cuvette with DPPH, and the absorbance was measured

after 10 min (At_{10}). An increasing amount of antioxidants present in the methanol extract of the sample reduced DPPH inhibition according to the following equation:

$$\text{Inhibition (\%)} = [(At_0 - At_{10}) / At_0] \times 100$$

Statistics

All statistical analyses were carried out using the statistical software Statistica 12.0 (Statsoft, USA). Each analysis was done in six repetitions. Descriptive data analysis included mean, standard deviation. Mean comparisons between heavy metals, polyphenols content and total antioxidant activity were done by the LSD-test, $p < 0.05$.

RESULTS AND DISCUSSION

Two experiments were realised as the pot trials in the vegetation cage with the aims to investigate the relationship between soil content of chosen risky metals and their accumulation in seeds of faba bean. In the pot trials the soils from the locality Cakajovce was used.

The soil evaluation

The soil from Cakajovce locality is characterized by low supply of humus and the neutral soil reaction suitable for the legume cultivation. The used soil is characterized also by high content of potassium and phosphorus as well as by a very high content of magnesium (Table 1). The soil used in the pot trial was uncontaminated. Only determined Cd content was on the level of limit value given by Law No. 220/2004 for the soil extract by aqua regia as well as Pb content on the level of critical value given by Law No. 220/2004 for the relationship between soil and plant. The values were far below threshold values proposed by EC (Table 2).

The evaluation of application of graded Zn doses into soil

Seeds of faba bean harvested of milk ripeness are

consumed in Slovakia, so the determined contents of heavy metals were compared with limit values given by Food Codex of the Slovak Republic valid in the Slovak Republic (FC SR) as well as according to Commission Regulation 1881/2006 (CR). The results show the mean value plus/minus the standard deviation.

In fresh seeds of cv. Saturn (Table 3) in control variant the extremely high content of Pb (by 310% higher than maximal allowed amount given by the legislative) was determined. In all variants the determined Pb content was increased and the highest Pb content was determined in D variant (by 500% higher than limit value). Also Cd content in fresh seeds of faba bean Saturn was increased in variants with application of 250 and 500 mg Zn.kg⁻¹, but the highest Cd content in D variant was still below the limit value. Contents of other observed metals were lower in variants with Zn application in relation to control variant (with exception of Zn) and were far below the limits. The results in Table 3 show the mean value plus the standard deviation (in parenthesis).

In fresh seeds of faba bean cv. Zobor (Table 4) in control variant the extremely high contents of Pb and Cd (by 630% and 30% respectively higher than maximal allowed amounts given by the legislative) were determined. In B, C and D variants with graded Zn doses the determined Pb contents were by 685%, 545% and 610% higher than limit value (respectively). The determined Cd content was in B and C variants identical (by 60% higher than hygienic limit) and in D variant with the highest Zn dose applied into the soil the determined Cd content was by 30% lower than maximal allowed amount in foodstuffs. The determined Zn content was in variants with Zn application increased, but even in D variant it was lower than the hygienic limit. Contents of Cu, Ni and Cr were only slightly changed in variants with Zn application, only Ni content determined in D variant was 2.4 fold lower than that in the control variant. The results in Table 5 show the mean value plus the standard deviation (in parenthesis).

The determined contents of Cr, Cu and Pb (0.1 mg.kg⁻¹, 0.7 mg.kg⁻¹ and 0.1 mg.kg⁻¹, respectively) by Hicsonmez

Table 1 Agrochemical characteristics, macroelements content (mg.kg⁻¹) in the soil from locality Cakajovce (Slovakia).

Agrochemical characteristics	pH (H2O)	pH (KCl)	Cox (%)	Humus (%)	
	8.53	7.23	1.53	1.44	
Macroelements	N	K	Ca	Mg	P
	1225	291	5210	380	90.8

Table 2 Heavy metal contents (mg.kg⁻¹) in the soil from locality Cakajovce (Slovakia).

Heavy metals	Cu	Zn	Co	Cd	Pb	Cr	Ni
Aqua regia	19.8	48.5	13.0	0.72	18.3	27.4	29.2
limit value*	60	150	15	0.7	70	70	50
Threshold value***	100	200	-	1.5	100	100	70
HNO ₃	8.44	8.74	5.5	0.29	9.06	1.8	7.3
Reference value**	20	40	-	0.1	30	10	10
NH ₄ NO ₃	0.085	0.025	0.14	0.026	0.11	0.06	0.16
Critical value*	1.0	2.0	-	0.1	0.1	-	1.5

Note: *Law No. 220/2004 valid in Slovakia.

**Decision No. 531/1994 – 540 valid in Slovakia.

***European Commission (2006).

Table 3 Heavy metals contents in the faba bean cv. Saturn ($\text{mg.kg}^{-1} \pm \text{S.D.}$).

Variant	Zn	Cu	Ni	Cr	Pb	Cd
A (control)	8.46 \pm 0.02	2.25 \pm 0.03	0.87 \pm 0.07	0.40 \pm 0.01	0.83 \pm 0.02	0.03 \pm 0.01
B (40 mg Zn.kg ⁻¹)	9.42 \pm 0.11	1.83 \pm 0.02	0.42 \pm 0.02	0.40 \pm 0.03	0.97 \pm 0.05	0.02 \pm 0.01
C (250 mg Zn.kg ⁻¹)	14.84 \pm 0.25	1.79 \pm 0.03	0.63 \pm 0.01	0.24 \pm 0.03	1.00 \pm 0.03	0.04 \pm 0.01
D (500 mg Zn.kg ⁻¹)	17.70 \pm 0.08	2.26 \pm 0.08	0.73 \pm 0.02	0.37 \pm 0.02	1.20 \pm 0.08	0.06 \pm 0.01
Limit	50.0	15.0	3.0	4.0	0.2	0.1
Maximal level	-	-	-	-	0.2	0.1

Note: Limit is limit value for legumes according to the Food Codex of the Slovakia. Maximal level according to Commission Regulation 1881/2006.

Table 4 Heavy metals contents in the faba bean cv. Zobor ($\text{mg.kg}^{-1} \pm \text{S.D.}$).

Variant	Zn	Cu	Ni	Cr	Pb	Cd
A (control)	9.02 \pm 0.07	1.89 \pm 0.01	1.15 \pm 0.02	0.42 \pm 0.03	1.46 \pm 0.03	0.13 \pm 0.01
B (40 mg Zn.kg ⁻¹)	12.33 \pm 0.02	1.90 \pm 0.02	1.17 \pm 0.04	0.34 \pm 0.01	1.57 \pm 0.10	0.16 \pm 0.01
C (250 mg Zn.kg ⁻¹)	15.58 \pm 0.05	1.93 \pm 0.07	1.13 \pm 0.04	0.42 \pm 0.03	1.29 \pm 0.02	0.16 \pm 0.01
D (500 mg Zn.kg ⁻¹)	20.37 \pm 0.09	1.96 \pm 0.02	0.47 \pm 0.02	0.42 \pm 0.02	1.42 \pm 0.18	0.07 \pm 0.01
Limit	50.0	15.0	3.0	4.0	0.2	0.1
Maximal level	-	-	-	-	0.2	0.1

Note: Limit is limit value for legumes according to the Food Codex of the Slovakia. Maximal level according to Commission Regulation 1881/2006.

Table 5 Total polyphenol content ($\text{mg GAE.kg}^{-1} \pm \text{S.D.}$) and total antioxidant capacity (% of DPPH inhibition \pm S.D.).

Variant	Cultivar	Total polyphenol content		Total antioxidant capacity	
		Saturn	Zobor	Saturn	Zobor
A (control)		2208 \pm 10	2360 \pm 11	3.23 \pm 0.02	4.66 \pm 0.06
B (40 mg Zn.kg ⁻¹)		4087 \pm 12	2758 \pm 16	3.58 \pm 0.01	4.80 \pm 0.01
C (250 mg Zn.kg ⁻¹)		4622 \pm 21	2530 \pm 19	3.52 \pm 0.01	4.80 \pm 0.02
D (500 mg Zn.kg ⁻¹)		2987 \pm 11	4095 \pm 12	4.52 \pm 0.01	5.71 \pm 0.01

et al. (2012) in faba bean seeds were many times lower than those determined in our faba bean cultivars, only Ni content determined by these authors was similar to that in our samples (3.4 mg.kg^{-1}). On other hand, reference **Haciseferoğullari et al. (2003)** determined higher amounts of Cr, Cu (11.25 mg.kg^{-1} and 18 mg.kg^{-1} , respectively), a lower Pb content (1.5 mg.kg^{-1}) and a similar Ni content (3.83 mg.kg^{-1}) in comparison to our results. **Dalaram et al. (2016)** showed the content of the metals studied in similar uncontaminated (from point of view of heavy metals content), with the exception of cadmium, not exceed the maximum permissible value in legumes.

The graded Zn doses applied into the soil in the model conditions resulted in increased Zn content in seeds of faba bean harvested in the stage of milk ripeness. The strong statistical relationship between soil Zn content and Zn amount in seeds of both of investigated faba bean cultivars was confirmed ($R = 0.944$ and $R = 0.965$, respectively). Despite of very high Zn doses applied into the soil, the determined Zn amount in seeds of both of faba bean cultivars was lower than maximal allowed content in foodstuffs given by the legislative.

References **Gadd (1992)** and **Giller et al. (1998)** postulated that some metals such as Zn, Cu, Ni and Cr are essential or beneficial micronutrients for plants, animals and microorganisms, whereas others, such as Cd, Hg, and Pb have no known biological and/ or physiological functions. However, all these metals could be toxic at relative low concentrations. These metals are taken up from soils and bioaccumulated in crops, causing damage to

plants when reach high levels and under certain conditions becoming toxic to human and animals feed on these metal enriched plants (**El-Sokkary and Sharaf, 1996**). Heavy metal accumulation in plants depends upon plant species, and efficiency of different plants in absorbing metals in evaluated by either plant uptake or soil to plant transfer factors of the metals (**Rattan et al., 2005**).

The total polyphenols and total antioxidant capacity evaluation

Total polyphenol content (TP) and total antioxidant capacity (TAC) determined in seeds of both of investigated faba bean cultivars harvested in the stage of milk ripeness are presented in Table 5. The determined values of total polyphenol content were in interval 2208 – 4622 mg GAE.kg⁻¹ FM (after calculation to dry mater 10045 – 23225 mg GAE.kg⁻¹ DM). Generally, in all variants the determined TP values in seeds of faba bean cv. Zobor were lower in comparison to cv. Saturn with exception of D variant. The determined values of total antioxidant capacity (TAC) were in interval 3.23 – 5.71% DPPH and in all variants the TAC values determined in seeds of faba bean cv. Zobor were higher than those in cv. Saturn. Reference **Chaieb et al. (2011)** determined total content of polyphenols and antioxidant capacity of thirteen genotypes of faba bean (16980 – 67470 mg GAE.kg⁻¹ DM; 2.15 – 28.60% DPPH). These results correspond with our findings. **Turco et al. (2016)** reported results of polyphenols determination in faba bean from different countries – Algeria (4490 – 42440 mg.kg⁻¹), Tunisia

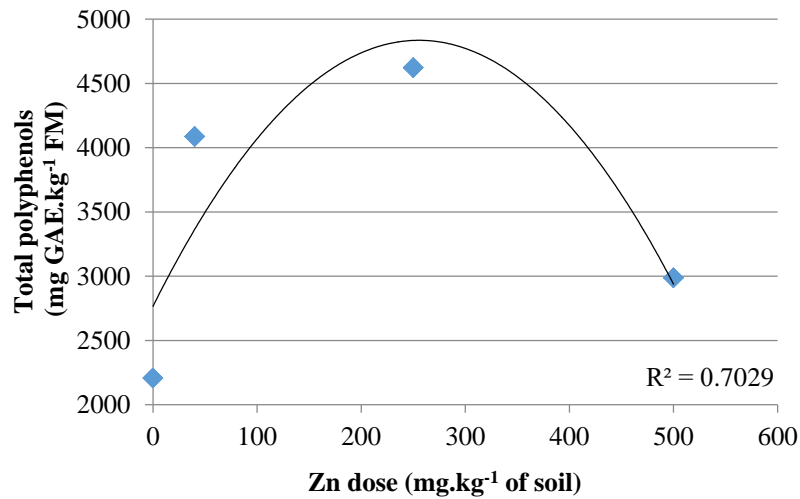

Figure 1 Relationship between Zn input into soil and TP content in seeds of faba bean cv. Saturn.

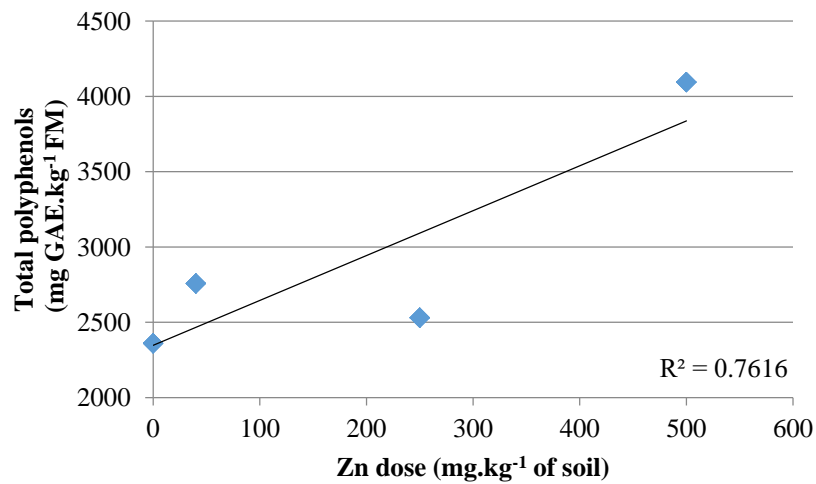

Figure 2 Relationship between Zn input into soil and TP content in seeds of faba bean cv. Zobor.

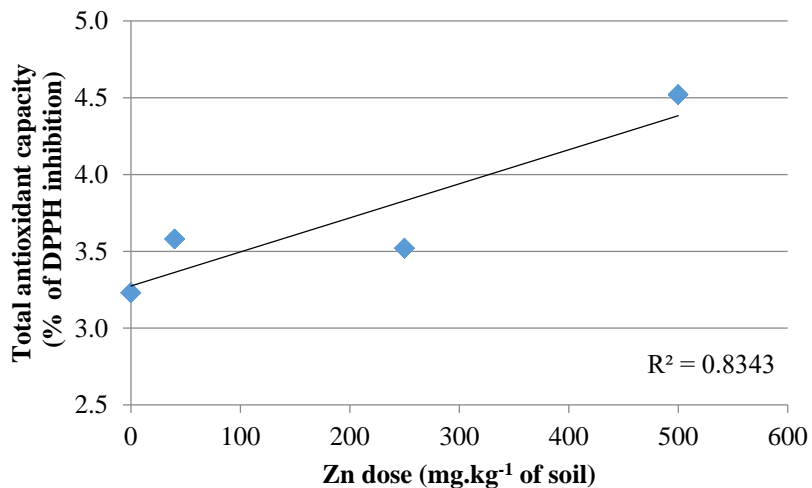

Figure 3 Relationship between Zn input into soil and TAC content in seeds of faba bean cv. Saturn.

(16980 – 67470 mg.kg⁻¹), Canada (5590 – 37760 mg.kg⁻¹), Chile (820 – 1340 mg.kg⁻¹). In addition to genetic factors, total phenolic content in seeds is modulated by other factors such as growing stage (vegetative, reproductive and mature).

With increased Zn doses applied into the soil in the model conditions the TP contents determined in seeds of both of faba bean cultivars Saturn and Zobor harvested in the stage of milk ripeness were increased. The maximal TP content in seeds of faba bean cv. Saturn can be expected at 200 – 300 mg Zn applied into 1 kg of the soil (Figure 1),

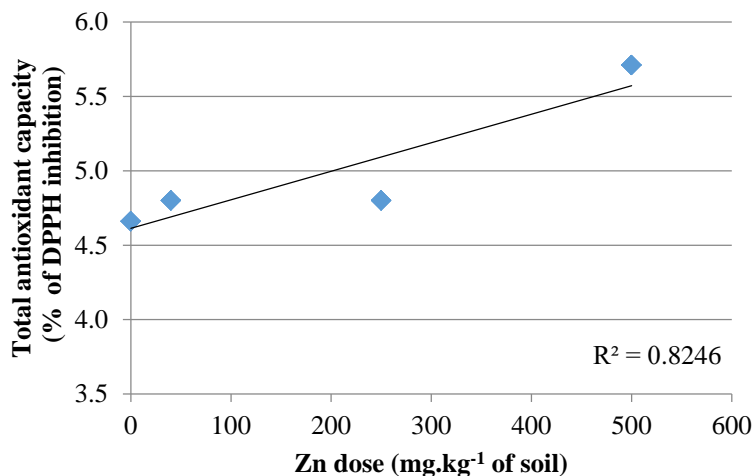

Figure 4 Relationship between Zn input into soil and TAC content in seeds of Zabor faba bean.

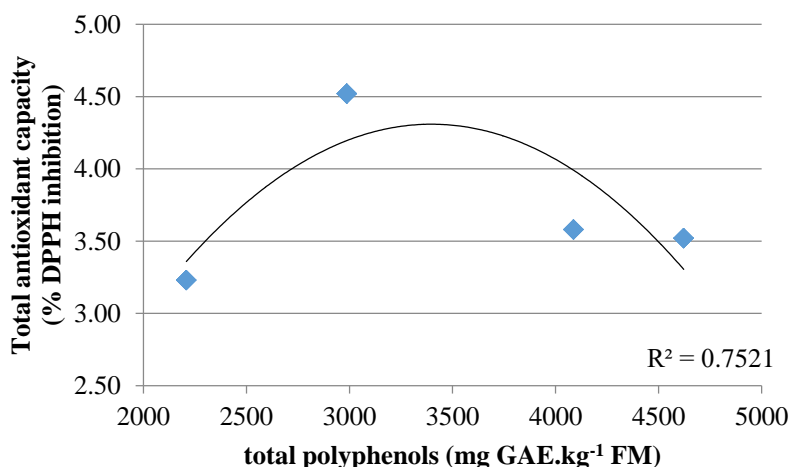

Figure 5 Correlation between TP and TAC (faba bean cv. Saturn).

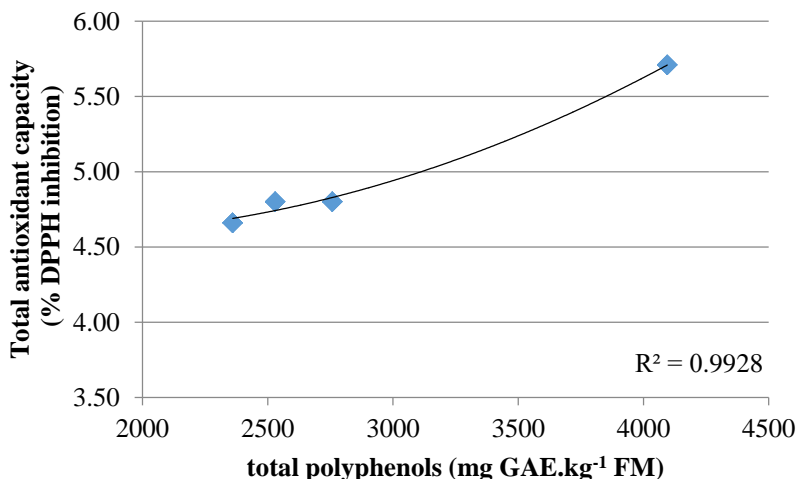

Figure 6 Correlation between TP and TAC (faba bean cv. Zabor).

while after application of higher Zn doses into the soil a lower TP content in seeds of cv. Saturn can be expected. The strong statistical relationship between soil Zn content and TP amount in seeds of this faba bean cultivar was confirmed ($R = 0.875$). On other hand, the graded Zn doses applied into the soil resulted in increased TP content in seeds of faba bean cv. Zabor harvested in the stage of milk ripeness (Figure 2). The strong statistical relationship

between soil Zn content and TP amount in seeds of this faba bean cv. Zabor was confirmed ($R = 0.688$).

Graded Zn doses applied into the soil resulted in increased TAC values in seeds of both of faba bean cultivars harvested in the stage of milk ripeness (Figure 3 and Figure 4). The strong statistical relationship between soil Zn content and TAC values in seeds of faba bean was confirmed ($R = 0.913$ and $R = 0.908$).

Figures 5 and Figure 6 show correlations between total polyphenol content and total antioxidant capacity values of both faba bean cultivars.

CONCLUSION

Legumes are considered to be a promising crop in the view of human nutrition. Therefore it is important to obtain the complex knowledge about their safety from the aspect of heavy metal content as well as about the bioactive important components and their possible entry into the food chain. The graded Zn doses applied into the soil in the model conditions resulted in increased Zn content in seeds of faba bean harvested in the stage of milk ripeness. The strong statistical relationship between soil Zn content and Zn amount in seeds of both of investigated faba bean cultivars was confirmed. With increased Zn doses applied into the soil in the model conditions the TP contents and total antioxidant capacity values determined in seeds of both of faba bean cultivars Saturn and Zobor harvested in the stage of milk ripeness were increased. The strong statistical relationship between soil Zn content and TP amount and TAC in seeds of faba bean cultivars was confirmed.

REFERENCES

Brand-Williams, W., Cuvelier, M. E., Berste, C. 2005. Use free radical method to evaluate antioxidant activity. *LWT - Food Science and Technology*, vol. 28, no. 1, p. 25-30. [https://doi.org/10.1016/S0023-6438\(95\)80008-5](https://doi.org/10.1016/S0023-6438(95)80008-5)

Cimboláková, I., Nováková, J. 2009. Heavy metals – the important element of the food chain. *Potravinárstvo*, vol. 3, no. 3, p. 14-16.

Dalaram, I. S., Nabil, R. H., Dina, A. S. 2016. The relationship of heavy metals contents in soils to their content in legume seeds used in famous traditional food in Kurdistan region-Iraq. *Potravinárstvo*, vol. 10, no. 1, p. 550-556. <http://dx.doi.org/10.5219/663>

Dalaram, I. S. 2017. Evaluation of total polyphenol content and antioxidant capacity of different variety lupin seeds. *Potravinárstvo Slovak Journal of Food sciences*, vol. 11, no. 1, p. 36-34. <http://dx.doi.org/10.5219/6678>

Decision of the Ministry of Agriculture SR No. 531/1994 – 540 about the maximum permitted levels of hazardous substances in the soil. Ministry of Agriculture of the Slovak Republic, Bulletin, Vol. XXVI, item I, decision 3, No. 531/1994 (Rozhodnutie o najvyšších prípustných hodnotách rizikových látok v pôde. Ministerstvo pôdohospodárstva SR, Vestník, roč. XXVI, časť I., rozhodnutie 3, číslo 531/1994).

Dinelli, A., Gadd, G. M. 1992. Metals and microorganisms: a problem of definition. *FEMS Microbiology Letters*, vol. 100, no. 1-3, p. 197-204. <http://dx.doi.org/10.1111/j.1574-6968.1992.tb14040.x>

El-Sokkary, I. H., Sharaf, A. I. 1996. Enrichment of soils and plants irrigated by wastewater by zinc and cadmium. *Egyptian Journal of Soil Science*, vol. 36, no. 1-4, p. 219.

Food Codex of the Slovak Republic (Potravinový kódex SR, 2006. Výnox č. 18558/2006-SL [online] s.a. [cit. 2015-09-29] Available at: http://www.svps.sk/legislativa/legislativa_kodex.asp.

Genççelep, H., Uzun, Y., Tunçtürk, Y., Demirel, K. 2009. Determination of mineral content of wild-grown edible mushrooms. *Food Chemistry*, vol. 133, no. 4, p. 1033-1036. <http://dx.doi.org/10.1016/j.foodchem.2008.08.058>

Giller, K. E., Witte, E., McGrath, S. P. 1998. Toxicity of heavy metals to microorganisms and microbial process in agricultural soils: a review. *Soil Biology and Biochemistry*, vol. 30, no. 10-11, p. 1389-1414. [https://doi.org/10.1016/S0038-0717\(97\)00270-8](https://doi.org/10.1016/S0038-0717(97)00270-8)

Haciseferoğullari, H., Gezer, I., Bahtiyarç, Y., Menges, H. O. 2003. Determination of some chemical and physical properties of Sakiz faba bean (*Vicia faba* L. var. major). *Journal of Food Engineering*, vol. 60, no. 4, p. 475-479. [https://doi.org/10.1016/S0260-8774\(03\)00075-X](https://doi.org/10.1016/S0260-8774(03)00075-X)

Fratianni, F., Cardinale, F., Cozzolino, A., Granesa, T. 2014. Polyphenol composition and antioxidant activity of different grass pea (*Lathyrus sativus*), lentils (*Lens culinaris*), and chickpea (*Cicer arietinum*) ecotypes of the Campania region (Southern Italy). *Journal of Functional Foods*, vol. 7, p. 551-557. <https://doi.org/10.1016/j.jff.2013.12.030>

Hicsonmez, U., Ozdemir, C., Cam, S., Ozdemir, A., Erees, F. S. 2012. Major-minor element analysis in some plant seeds consumerd as feed in Turkey. *Natural Science*, vol. 4, no. 5, p. 298-303. <https://doi.org/10.4236/ns.2012.45042>

Chaieb, N., González, J. L., López-Mesasa, M., Bouslamab, M., Valiente, M. 2011. Polyphenols content and antioxidant capacity of thirteen faba bean (*Vicia faba* L.) genotypes cultivated in Tunisia. *Food Research International*, vol. 44, no. 4, p. 970-977. <https://doi.org/10.1016/j.foodres.2011.02.026>

Lachman, J., Hejtmánková, A., Dudjak, E. 2003. Content polyphenolic antioxidants and phenolcarboxylic acids in selected parts of yacon. In *Vitamins 2003 – Naturals antioxidants and free radicals*. Pardubice : Univerzita Pardubice, p. 89-97. ISBN 80-7194-549-8.

Law No. 220/2004. Criteria for identification of risky spots of soil contamination and methodology procedurs of their evaluation.

Rattan, R. K., Dattaa, S. P., Chhonkara, P. K., Suribabua, K., Singhb, A. K. 2005. Long-term impact of irrigation with sewage effluents on heavy metal content in soils. Crops and groundwater – a case study. *Agriculture Ecosystems & Environment*, vol. 109, no. 3-4, p. 310-322. <https://doi.org/10.1016/j.agee.2005.02.025>

Rutkowska, B., Szulc, W., Łabętowicz, J. 2014. Zinc speciation in soil solution of selected Poland'agricultural soils. *Zemdirbyste-Agriculture*, vol. 101, no. 2, p. 147-152. <https://doi.org/10.13080/z-a.2014.101.019>

Turco, I., Ferretti, G., Bacchetti, T. 2016. Review of the health benefits of Faba bean (*Vicia faba* L.) polyphenols. *Journal of Food and Nutrition Research*, vol. 55, no. 4, p. 283-293.

Acknowledgments:

This work was supported by grant VEGA No.1/0308/14.

Contact address:

Mária Timoracká, Slovak University of Agriculture, Faculty of Biotechnology and Food Sciences, Department of Chemistry, Tr. A. Hlinku 2, 949 76 Nitra, Slovakia, E-mail: maria.timoracka@uniag.sk

Alena Vollmannová, Slovak University of Agriculture, Faculty of Biotechnology and Food Sciences, Department of Chemistry, Tr. A. Hlinku 2, 949 76 Nitra, Slovakia, E-mail: alena.vollmannova@uniag.sk

Dalaram Sulaiman Ismael, Slovak University of Agriculture, Faculty of Biotechnology and Food Sciences, Department of Chemistry, Tr. A. Hlinku 2, 949 76 Nitra, Slovakia, E-mail: dalaram.dizayee@gmail.com



THE INFLUENCE OF SOME SELECTED VARIABLES FROM ACCOUNTING SYSTEM ON PROFIT OR LOSS OF AGRICULTURAL COMPANIES IN THE SLOVAK REPUBLIC

Alexandra Ferenczi Vaňová, Renáta Krajčírová, Michal Munk, Iveta Košovská, Ivana Váryová

ABSTRACT

The article presents the influence assessment of significance of some selected variables from the entrepreneurs' accounting system on the achieved profit or loss of the agricultural companies in the Slovak Republic. Accounting information serves as an active tool for internal users for operational as well as strategic company management, and for external users the information is determined as legally binding output information which is a subject to disclosure. Individual financial statements of assessed agricultural companies are considered to be the relevant source of information. Agricultural companies are represented by commercial companies and agricultural cooperatives. Profit or loss after income tax presents the final complex effect of economic company's performance. The existence and development of companies is conditioned by assets which amount and structure depend on focus and the range of subject activity but as well as on specific factors set by the production process in the agricultural primary production. The increase in liabilities is notable by the influence of insufficient amount of own company funding sources, mainly the increase in trade payables. The continuance of company reproduction process is secured by a bank loan drawdown. The income situation of companies of agricultural primary production is favourably influenced by the subsidies of non-investment character. During the observed period of years 2004 – 2014 the examined variables were assessed by means of statistical methods. The obtained results of rate determination of statistical correlation between selected variables by means of classical canonical analysis and non-parametric correlation analysis secured that in the assessed group of companies all analysed variables influenced statistically significantly profit or loss after income tax, mainly the total value of assets and non-investment subsidies, except for years 2010, 2012 a 2013, when the statistically insignificant correlations was determined between profit or loss and especially short-term trade payables and current bank loans. As regards the existence point of view it is recommended to companies to maintain the optimal assets and capital structure as well as the achievement of suitable profitability of company's activity. Only the complex attitude towards the subject issue can be the assumption of sustainability for companies of agricultural primary production in the Slovak Republic and the increase in their performance.

Keywords: variable; accounting; profit or loss; correlation; agricultural company

INTRODUCTION

For many centuries Slovakia with its countryside was a typical agrarian country. Despite the areal industrialization after 1950 agriculture remained its characteristic feature. Evidential sector organization of agricultural production was created as a result of manufacturing expansion. It was caused by industrialization process. It caused largely one-sided orientation of rural regions towards the agricultural activities. In the current era of globalization, especially after the accession to the EU, the position of agriculture is changing especially in the trend of the EU Common Agricultural Policy reforms (Horská et al., 2013). Hanová et al. (2015) compared economic position of the Slovak Republic with the EU countries by using the

selected socio-economic indicators. The entrepreneurship in agriculture takes place in a certain environment which is partially the same as an environment in other economy spheres but in part it has specifics which are conditioned by the character of transformation relations and the participation of soil and climatic factors in the reproduction process (Grznár et al., 2010). The specifics of agricultural companies are presented by a high correlation on natural conditions, a time variance between the flow of production and work process typical mainly for crop production, work seasonality in agricultural production (Bielik and Turčeková, 2013). The different natural and geographical conditions caused the creation of the specific regions with the economic structures, and with

the variety of environmental and social conditions (Papcunová et al., 2015). Agricultural production is linked to a risk. Some of the risks are common with other sectors in the economy and some are unique. Climate and weather related risks have a strong effect on agricultural production (Tóth et al., 2016). Risk and return are negatively related and investors are comparing the risk with a profitability.

By means of the specific function and the importance of agriculture within the national economy this sector is the subject of government regulations which deforms a market and market prices as these are the input for accounting systems of agricultural companies and significantly influence the profit or loss of agricultural companies and the assessment of their economic performance (Dvořáková, 2012). Accounting shall report the unique character of agricultural activities (biological substance of production process) which influences mainly the several variants of measurement and classification of assets but as well as the calculation of profit or loss which correctly indicates the company performance. Accounting is a conservative discipline however it should follow the global trends and apply them in a manner that would ultimately ensure reliable and relevant information about financial position and performance of a company (Stárová et al., 2014). The primary function of financial accounting is to provide all its users with reliable data not only for evaluating the company performance in the past, but also for the ability to take right decisions in the future, i.e. to predict the future conditions of business activities. The issue of accounting information provided by the company financial reporting is treated by Tumpach et al. (2013), Bähr et al. (2006), Grünberger (2006), Kieso et al. (2004).

Profit or loss is an important financial indicator expressing the effectiveness and efficiency of a business activity mainly in connection to the contributed capital. It is the basic information source and the measurement of financial profitability of contributed capital to the respective accounting period (Baštinová, 2007). Profit or loss represents the measurement of sold production, the efficiency of used live and materialized labour and the measurement of used contributed capital (Serenčěš et al., 2010). The objectively affecting disparities and particularities of agricultural companies influence the amount of profit. The maximization of profitability is one of the main tasks (Kotulič et al., 2007). In connection with this statement, various determinants of profitability are mentioned: natural conditions, economic conditions, production structure, used manners and technologies, the level of labour utilization, production quality, sales prices, the amount of costs, turnover, liquidity, the manner of financing of business activity, other factors. Consistently Grznár et al. (2010) state that the creation and division of profit is influenced by many factors. In order to analyse carefully the company economy it is essential to identify them. Profit or loss for the current accounting period is treated by Pakšiová and Kubaščíková (2014), Strouhal et al. (2013), Šteker and Otrusínová (2013).

Maintenance and repair of company property substance is the base for time and content differentiation and cost allocation to company income when determining profit or loss. It presents one form of income situation

determination of an accounting entity which is combined with the assessment of property situation through the changes in property substance of a company (Pakšiová, 2014). Understanding the business property of a company is a starting point and a criterion for determining the economic result (Pakšiová and Kubaščíková, 2015). Decision-making on assets acquisition and on acquiring the financial sources needed for assets acquisition belong to the strategic decisions of management as it influences the future development and effectiveness of subject activity (Baštinová, 2009). Basic sources for assets are conditioned by the activity range as well as the legal form. Gyurián and Kútina (2016) analysed the development of various business forms. The process of decision, in general, is the process of the optimal choice from the set of eventual possibilities under existing conditions. The current law highly determines the most appropriate form of economic activity for them. Property and financial structure of companies is as well as treated by Kieso et al. (2004), Ross (2008), Scheffler (2006), Wagenhofer (2002).

Users utilize information about the financial position mainly for the prediction of company loan needs in the future and as well as for the consideration of ability to pay its debts in time. Information on company performance is used for the assessment of potential changes in the structure of economic sources which will be probably used in the future and for effectiveness consideration with which the additional sources should be used (Bohušová et al., 2013). Trade payables and loans from commercial banks which help companies to secure fluent operational cycle of agricultural production are as well as treated by Serenčěš et al. (2010). The essential specific of entrepreneurship in agriculture is the active participation of government and its agrarian policy trying to sustain the food balance, to utilize the domestic production potential and the fulfilment of outside production functions of agriculture (Grznár et al., 2010). The subsidies from European sources have the crucial importance in the income of agricultural companies. Legally eligible direct payments from the EU are long-term guarantees of short-term bridge loans from commercial banks which farmers pay directly after the granting of subsidies (Serenčěš et al., 2010). Direct payments have strong impact on production in countries with relatively lower incomes because financially constrained farms quite often use direct payments as a source of credit (Ciaian et al., 2011). Baštinová (2009) points to subsidies as an external source of funding. Šteker and Otrusínová (2013) state that from the accounting point of view the subsidies are classified as subsidies to acquisition or technical improvement of fixed assets (so called investments subsidies) and subsidies for cost recovery (so called operational subsidies).

The article task is to assess the influence of selected variables from accounting system on profit or loss in the assessed group of agricultural companies in the Slovak Republic during the observed period of years 2004 – 2014 by means of selected statistical methods.

MATERIAL AND METHODOLOGY

In connection with the article content the data source is presented by the data from resort database for the selected

group of companies of agricultural primary production in the Slovak Republic. They derive from the Information Letters of the Ministry of Agriculture and Rural Development of the Slovak Republic (hereinafter referred as "MARD SR") expressing the data from individual financial statements of selected companies in the time horizon of years 2004 – 2014.

The assessed selected group of agricultural companies present those legal persons who performed the entrepreneurship activity without the change of legal form during the assessed period of years. They present the same companies in the observed time line. The mostly occurring forms of entrepreneurship in the agriculture of the Slovak Republic are a company with limited liability, a joint stock company and a cooperative. Commercial companies prevail upon agricultural cooperatives in the assessed group of agricultural companies as regards their frequency pursuant to the legal form. In the observed period the change of legal forms was noticeable from the economic reasons, presented mainly by the transformation of agricultural cooperatives to companies with limited liability. Therefore, the number of cooperatives decreased. The final group of companies is presented by 737 legal persons who are represented by 292 agricultural cooperatives and 445 commercial companies.

The article assesses the significance of correlations between selected variables from accounting system of companies of agricultural primary production to their accounting result (profit or loss) after income tax for the current accounting period (hereinafter referred to as "AR"). The analysed variables present the following: assets total (hereinafter referred to as "AT"), short term trade liabilities (payables) (hereinafter referred to as "STTL"), current bank loans (hereinafter referred to as "CBL") and subsidies of non-investment character (current bank loans and financial assistance) (hereinafter referred to as "CBLFA").

Canonical analysis is used for the assessment of correlations between two examined sets of variables which belongs to multivariate explanatory techniques. Simultaneously the correlation rate is assessed between selected evaluated variables from accounting system of agricultural companies and their achieved profit or loss during the observed years by means of non-parametric correlation, namely as regards deviations from normality. For this purpose the Kendall coefficient Tau is used which obtains values from the interval $<-1, 1>$, where -1 presents indirect correlation, 1 direct correlation and 0 independence of variables. The null hypothesis is tested which declares that the pair of variables is independent (Munk, 2011).

MS Access and MS Excel are used for the data pre-processing and the system STATISTICA is utilized for the purpose of relation analysis between variables, concretely the modules Non-parametric methods and Multivariate exploratory techniques.

Standard methods of scientific work are used for the article processing, viz. selection, analysis, comparison, synthesis and deduction, presenting the basic methodical attitudes towards the processing of theoretical and applicable part of article.

RESULTS AND DISCUSSION

The entrepreneurship activities of agricultural companies are performed in specific conditions in comparison with other entrepreneurs. Peculiarities of agricultural productions present climate conditions and seasonality.

The effectiveness of decision-making and management of companies is directly depend on volume and quality of required information, provided by accounting information system. The dominant of accounting function is to secure information for receipt and control of decision in each area of an entrepreneurship activity. The integrated set of such information is provided by the financial statements of a company. The aim of individual financial statements preparation is to provide its users with such a structure, volume and character of information which enables to acquire the overview of assets, liabilities, equity and disclosed profit or loss.

Profit or loss for a certain accounting period provides information about profitability of company activities, presenting the own source for assets covering acquired from entrepreneurship activities from the date of preparation of the financial statements till the date of decision about its using during the accounting period following its acquiring. The level of disclosed profit or loss is influenced by the obtained income and expenses mainly from operational activities which closely relates to subject of company activities. Profit positively affects the disclosed company equity, while loss has negative influence on the value of equity. In the year 2014 differences in profit or loss between agricultural cooperatives and commercial companies moderated (**Report on agriculture and food sector in the Slovak Republic 2014**). According to **Adamišín and Kotulič (2013)** a higher economic performance of commercial companies can be determined not only by different approaches to the management of subjects, but as well by a better starting situation in the past (on contrary to cooperatives) or even the potentially inconvenient selected basis for comparison of economic performance (agricultural land).

Deriving from the literary sources the selected variables from accounting systems of companies in the Slovak Republic with the influence on profit or loss of agricultural companies were identified. Canonical analysis was used for the determination of correlation between two sets of variables.

Based on the achieved results of canonical correlation coefficient (Canonical $R = 0.9650$; $\text{Chi}^2(400) = 1703.4$; $p = 0.0000$), left set of variables 10 and right set 40 (Table 1) very strong level of correlation was determined between sets of selected variables which is as well as statistically significant. The first set of variables presents profit or loss and other assessed variables belong to the second set. As the canonical correlation coefficient is closed to 1, the greater level of correlation is determined.

Based on the Chi-Square tests with successive roots removed the statistically significant results of canonical correlation coefficient were achieved. The values of canonical correlation coefficient of 10 variables observed for the analysed period of 10 years are statistically significant (Figure 1).

Nonparametric (rank-order) correlation analysis by means of Kendall Tau correlation coefficient was used for

Table 1 Canonical Analysis Summary (2005 – 2014).

N=159		Left Set	Right Set
No. of variables	10		40
Variance extracted	100.000%		53.5083%
Total redundancy	76.9482%		40.4427%
Variables: 1	AR2005		AT2005
2	AR2006		STTL2005
3	AR2007		CBL2005
4	AR2008		CBLFA2005
5	AR2009		AT2006
6	AR2010		STTL2006
7	AR2011		CBL2006
8	AR2012		CBLFA2006
9	AR2013		AT2007
10	AR2014		STTL2007
11			CBL2007
12			CBLFA2007
13			AT2008
14			STTL2008
15			CBL2008
16			CBLFA2008
17			AT2009
18			STTL2009
19			CBL2009
20			CBLFA2009
21			AT2010
22			STTL2010
23			CBL2010
24			CBLFA2010
25			AT2011
26			STTL2011
27			CBL2011
28			CBLFA2011
29			AT2012
30			STTL2012
31			CBL2012
32			CBLFA2012
33			AT2013
34			STTL2013
35			CBL2013
36			CBLFA2013
37			AT2014
38			STTL2014
39			CBL2014
40			CBLFA2014

Source: Own calculation based on data from the Information Letters of the MARD SR.

the influence examination of selected variables to the total profit or loss after income tax for the accounting period. In the time horizon of years 2004 – 2014 the statistically significant influence of analysed variables on profit or loss was determined in the selected group of companies except for year 2010, 2012 and 2013 when the statistically insignificant correlation was identified between profit or loss and several selected variables.

As regards the achieved values of correlation coefficient in 2004 – 2014 the total value of assets and subsidies of

non-investment characters had the greatest influence on profit or loss. In 2014 the statistically significant influence on profit or loss was determined for all variables in the assessed group of ($p = 0.0000$). Furthermore the proportional correlation between profit or loss and selected variables was determined in 2014 based on the values of correlation coefficient (Kendall Tau = 0.1070 – 0.1940).

Correlations of analysed variables are presented by a matrix chart (Figure 2). The chart figures correlation fields from the pairs of points of individual variables and a

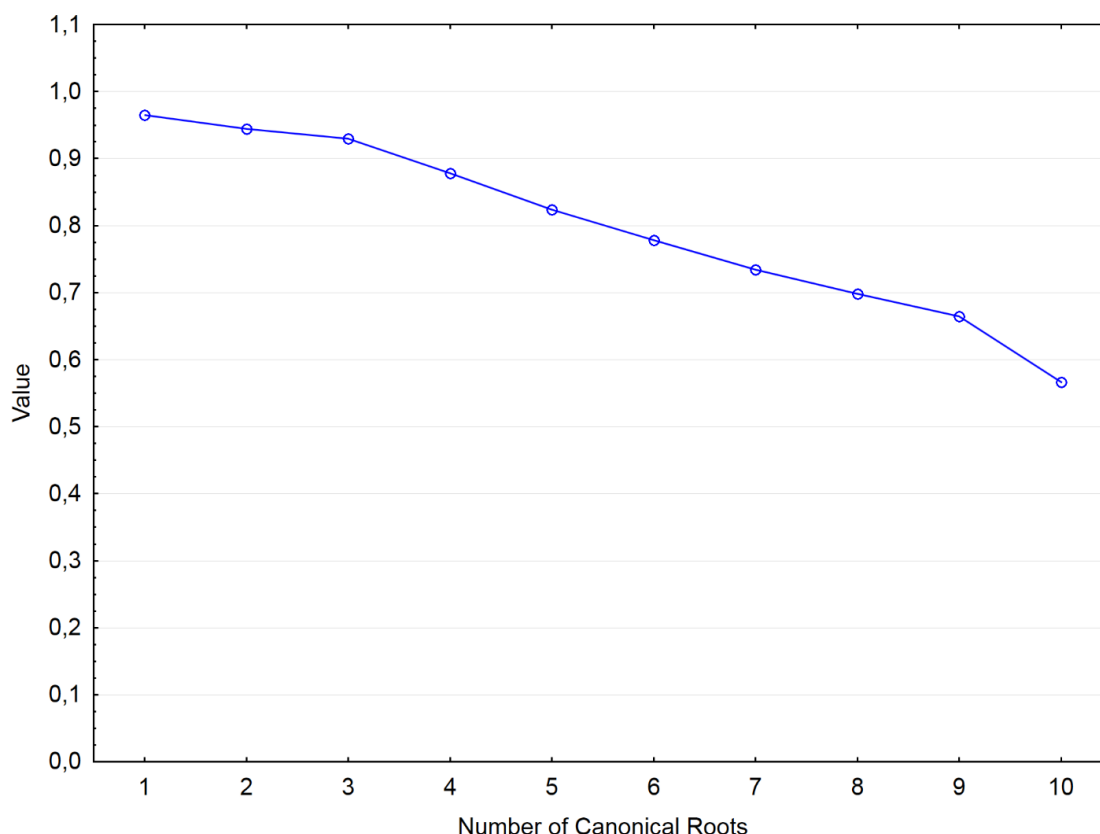

Figure 1 Plot of Canonical Correlations (2005 – 2014).

Source: Own calculation based on data from the Information Letters of the MARD SR.

dependent variable presented by profit or loss. The points in chart are overlaid by a growing axis for a proportional correlation.

In 2010 (Table 2) the statistically significant influence was determined between AR and STTL ($p = 0.7291$), AR and CBL ($p = 0.8927$), in 2012 (Table 3) between variables AR and CBL ($p = 0.1093$) and in 2013 (Table 4) between AR and STTL ($p = 0.6966$), AR and CBL ($p = 0.1668$), AR and CBLFA ($p = 0.2341$). Based on the statistical significance of Kendall coefficient Tau the low correlation was acquired in further assessed years (mainly for total assets and subsidies of non-investment character) and trivial correlation (mainly for short-term trade

payables and current bank loans). In 2009 the inversely proportional correlation was between variables, in 2010 between AR and STTL, AR and CBL, and in 2013 between AR and STTL

Size, profitability, collateral value of assets, non-debt tax shield, retained profit and liquidity were selected as the main determinants of the capital structure of agricultural companies (Aulová and Hlavsa, 2013).

Amount and structure of property is conditioned by sources of funding which differentiate as regards the maintenance of production process and simultaneously the realization of output in companies of agricultural primary production. The optimal ratio between separate items of

Table 2 All Groups Kendall Tau Correlations for the year 2010.

Pair of Variables	Valid	Kendall	Z	p-level
AR2010 & AT2010	1255	0.041089	2.180375	0.029230
AR2010 & STTL2010	1245	-0.006552	-0.346310	0.729110
AR2010 & CBL2010	744	-0.003305	-0.134902	0.892689
AR2010 & CBLFA2010	1223	0.066971	3.508089	0.000451

Source: Own calculation based on data from the Information Letters of the MARD SR.

Table 3 All Groups Kendall Tau Correlations for the year 2012.

Pair of Variables	Valid	Kendall	Z	p-level
AR2012 & AT2012	1425	0.098294	5.558931	0.000000
AR2012 & STTL2012	1397	0.065567	3.671374	0.000241
AR2012 & CBL2012	779	0.038333	1.601257	0.109320
AR2012 & CBLFA2012	1376	0.081493	4.528657	0.000006

Source: Own calculation based on data from the Information Letters of the MARD SR.

Table 4 All Groups Kendall Tau Correlations for the year 2013.

Pair of Variables	Valid	Kendall	Z	p-level
AR2013 & AT2013	1428	0.074087	4.194360	0.000027
AR2013 & STTL2013	1412	-0.006926	-0.389882	0.696624
AR2013 & CBL2013	752	0.033689	1.382534	0.166808
AR2013 & CBLFA2013	1376	0.021412	1.189884	0.234092

Source: Own calculation based on data from the Information Letters of the MARD SR.

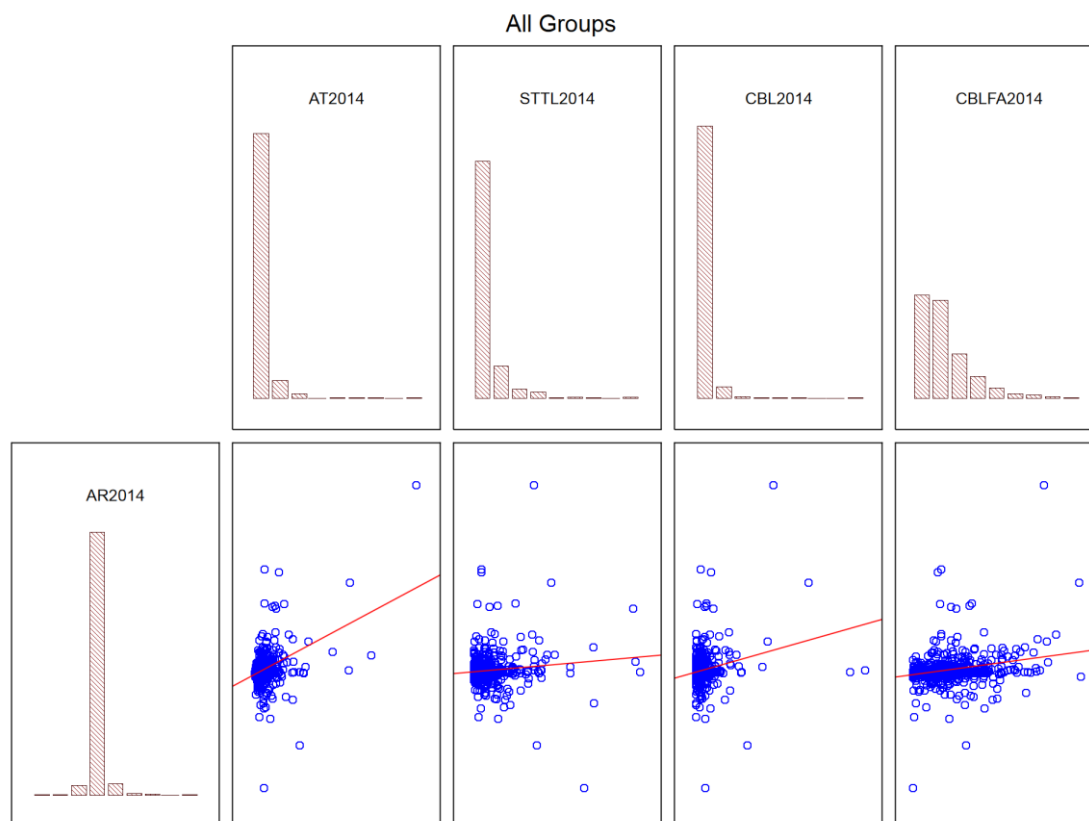

Figure 2 Matrix chart of selected variables for the year 2014.

Source: Own calculation based on data from the Information Letters of the MARD SR.

fixed assets and current assets depends on a company amount, its production focus and economic situation.

Companies acting in the same industry produce similar products, have similar technological equipment, similar structure of expenses and these tendencies are expressed in the financial structure of these companies (Kalusová and Fetisovová, 2015). This profit or loss presents the situation when more profitable companies are able to generate more own sources for financing of their entrepreneurship activities and are not forced to appeal to external institutions providing companies with the capital.

The determination of optimal financial structure belongs to the crucial decisions of management leading to a financial stability. The ratio of own and external capital differentiate from individual conditions of separate companies. Mainly it is applicable for agricultural companies as they are influenced by the biological character of production, seasonality but as well as currently valid system of subsidies payments (Serencěš et al., 2014).

Currently the short-term liabilities have a decisive ratio to the structure of total capital, mainly trade payables as

external sources of assets funding. They present the existing companies commitments arising from past events. Days payable outstanding is the economical expression of cash flow transitivity. It has the proven predictive ability for creditors. It requires the systematic managing activity.

Bank loans participate significantly in the total liabilities. Short-term loans prevailed in the structure of total loans with a critical amount mainly as regards the operation of agricultural companies and hassle-free collateral realized by means of subsidies – direct payments from the EU (Report on agriculture and food sector in the Slovak Republic 2014). Direct payments from the EU were vital as the loan collateral which was the guarantee against short-term bridge loans provided by commercial banks to agricultural companies. In that way companies decrease the risk of loan repayments and maintain the credit-worthiness and credit market position, as evidenced by the increase in short-term loans to this industry for the financing of operational cycle of agricultural output (from soil preparation till output realization) (Report on agriculture and food sector in the Slovak Republic

2012). Companies drew down loans, mainly for the purchase of inventory, the settlement of trade payables and payables towards employees. Agricultural companies began to drawdown loans more extensively after 2004. Precisely the year 2004 and the implementation of direct payments caused that agricultural companies became more credit-worthy for banks. (Serenčič et al., 2010).

In the case of Slovak agricultural companies we can conclude that the structure of funding sources is not optimal. As the main reason we consider the strict requirements and credit standards of banks due to their precautions and the need to respect their capital adequacy. Companies fail to fulfil the strict requirements and as a result they cannot obtain a bank loan (Kalusová and Badura, 2017). Slovak agricultural companies are struggling with a high indebtedness and an inappropriate structure of external funding sources (a decisive share of liabilities consists of short-term funds, while the share of long-term external funds is minimal).

Subsidies of investment and non-investment character belong to the forms of government intervention to the financing of companies. They positively affect the profitability situation of entrepreneurs. Received subsidies of non-investment character as a part of other income from operation activities underlie the obtained level of profit or loss of assessed companies. They are presented mainly by direct payments which relate to a disclosed area of agricultural soil in companies.

Financial situation of agricultural companies was influenced by the system of subsidies payments which the Slovak agriculture adopted in the intentions of the Common Agricultural Policy (CAP) after the accession of the Slovak Republic to the EU (Serenčič et al., 2014).

The biggest increase in operational subsidies in the monitored period 2004-2012 occurred in Slovakia (Svoboda et al., 2015). Together with investment subsidies and other possible measures they are the basis of the Common Agricultural Policy which is financed from the EU budget.

Capping of direct payments was especially an important issue for countries with large farms, like the Slovak Republic (Pokrivčák et al., 2015). Farms that would be affected by capping cultivate a much larger area; have higher assets, equity, sales, and profits.

Subsidies partially compensated the loss, without them the majority of agricultural companies would report the loss (Report on agriculture and food sector in the Slovak Republic 2014). Subsidies in agriculture in a total amount decreased as a consequence of resource depletion from the Rural Development Programme 2007 – 2013 and the slower receiving of payments from the Rural Development Programme 2014 – 2020 as well as the moderate decrease in the subsidies from the budget of the Slovak Republic.

Kozáková et al. (2014) compared organic and conventional agriculture in the Slovak Republic over period of years 2009 – 2012. In respect to their results they concluded that organic farms in their sample generate results comparable with conventional farms in a sense of profitability. Higher subsidies of organic farms successfully compensate lower revenues. Therefore the motivation for an owner to focus on organic farming is not lower than the focus on conventional farming.

Subsidies were motivating and financial stabilizers of agricultural companies (Report on agriculture and food sector in the Slovak Republic 2010). Direct payments and other subsidies are an indispensable part of production cost recovery of farmers and maintenance of their income on the socially accepted level.

CONCLUSION

A content and methodical point of view of financial accounting secures the relevant information on processes and results of entrepreneurship activities. The priority objective of accounting is to provide the true and fair view on all facts related to property, income and financial situation of entrepreneurs. Profit or loss after income tax, namely net profit, presents the crucial source of entrepreneurship financing activities with a direct influence on equity.

The article aim was to assess the influence of selected variables from accounting systems on achieved profit or loss of companies of agricultural primary production in the Slovak Republic. Based on the statistical assessment it can be stated that in the selected group of companies there was found the high statistically significant correlation between profit or loss as a dependent variable and other independent variables. Furthermore, we can state that in the assessed years 2004 – 2014 particularly assets and subsidies of non-investment character had the significant influence on profit or loss after income tax.

According to our opinion there exist several differences in company property structure deriving from the ability to create and acquire funding sources which concretely differentiate in agricultural companies. The securing of entrepreneurship activities increase the needs for allocation of external sources for financing of current operational requests as well as the repair and improvement of assets. Company indebtedness is crucially influenced by the increase in trade payables and the participation of bank loans in the structure of external funding sources. During the accounting period the suitable amount of cash is secured by means of loan drawdown which is paid by granted subsidies. Pursuant to the Common Agricultural Policy the significant financial sources of companies of agricultural primary production in the Slovak Republic are the received non-investment subsidies mainly in the form of direct payments which influence the assessment of their credit worthiness performed by banks when providing loan products. Without subsidies the assessed companies would report loss. The selection of optimal capital structure from short-term as well as from long-term point of view should be a continuous task of management in companies. Above mentioned facts are documented also by the reports on agriculture and food sector in the Slovak Republic for the observed period of years 2004 – 2014.

REFERENCES

- Adamišin, P., Kotulič, R. 2013. Evaluation of the agrarian businesses results according to their legal form. *Agricultural Economics*, vol. 59, no. 9, p. 396-402.
- Aulová, R., Hlavsa, T. 2013. Capital structure of agricultural businesses and its determinants. *Agris on-line papers in economics and informatics*, vol. 5, no. 2, p. 23-36.
- Baštincová, A. 2007. *Výsledok hospodárenia z účtovného a daňového hľadiska. (Profit or loss from the accounting and*

tax point of view). Bratislava : Iura Edition. 104 p. ISBN 978-80-8078-144-6.

Baštincová, A. 2009. *Dlhodobý hmotný majetok z účtovného a daňového hľadiska. (Non current tangible assets from the accounting and tax point of view)*. Bratislava : Iura Edition. 124 p. ISBN 978-80-8078-199-6.

Bähr, G., Fischer-Winkelmann, W. F., List, S. 2006. *Buchführung und Jahresabschluss*. Wiesbaden : Gabler. 622 p. ISBN 3-8349-0335-3.

Bielik, P., Turčeková, N. 2013. *Podnikové hospodárstvo. (Business economics)*. Nitra : SPU. 414 p. ISBN 978-80-552-1028-5. PMid:24065530

Bohušová, H., Svoboda, P., Nerudová, D., Boček, M. 2013. *Konvergence systémů IFRS a US GAAP pro vznik jediného systému finančního výkaznictví. (Convergency of IFRS and US GAAP systems for establishment of unified system of financial reporting)*. Brno : Policy Research Center, s.r.o.. 280 p. ISBN 978-80-87909-00-3.

Ciaian, P., Pokrivčák, J., Szegényová, K. 2011. *Do agricultural subsidies crowd out or stimulate rural credit institutions?: the Case of CAP Payments*. Brussels : Centre for European policy studies. ISBN 978-94-6138-131-6.

Dvořáková, D. 2012. *Specifika účetnictví a oceňování v zemědělství. (Specifics of accounting and assessing in the agriculture sector)*. Praha : Wolters Kluwer ČR, a. s.. 156 p. ISBN 978-80-7357-961-6.

Grünberger, D. 2006. *Buchhaltung und Bilanz; Ein systematischer Überblick*. 2nd ed. Wien : Orac. 112 p. ISBN 3-7007-3303-8.

Grznár, M., Tršťanská, A., Szabo, E., Šubertová, E., Foltínová, A., Vybíralová, J., Hudáková, I. 2010. *Podnikanie v agropotravinárstve. (Doing business in agri-food sector)*. 2nd ed. Bratislava : Ekonóm. 218 p. ISBN 978-80-225-3061-3.

Gyurián, N., Kútina, A. 2016. The assessment of the impact of selected tax system elements on choosing a business form in Slovak Republic. In *Conference proceedings RELIK 2016 : Reproduction of human capital (mutual links and connections)*. Praha : Vysoká škola ekonomická, pp. 124-133. ISBN 978-80-245-2166-4.

Hanová, M., Benda Prokeinová, R., Hallová, M., Čierna, Z. 2015. Economic position of the Slovak inhabitant in Europe. In *ICABR 2015*. Brno : Mendel University, pp. 273-282. ISBN 978-80-7509-379-0.

Horská, E., Espolov, T. I., Gálová, J., Krasnodębski, A., Kornalska, E., Trela, W., Voronina, A., Singh, A. K. 2013. *Sustainability in business and society: global challenges – local solutions*. Kraków : Wydawnictwo Episteme. 166 p. ISBN 978-83-7759-015-7.

Kalusová, L., Badura, P. 2017. Factors determining the financial structure of Czech and Slovak agricultural enterprises. *Agricultural Economics*, vol. 63, no. 1, p. 24-33.

Kalusová, L., Fetisovová, E. 2015. Determinanty finančnej štruktúry slovenských malých a stredných podnikov. (Determinants of financial structure in small and medium enterprises of the Slovak Republic.) *Ekonomický časopis/Journal of Economics*, vol. 63, no. 3, p. 278-300.

Kieso, D. E., Weygandt, J. J., Warfield, T. D. 2004. *Intermediate Accounting*. 11th ed. USA : Wiley. 1331 p. ISBN 0-471-07208-7.

Kotulič, R., Király, P., Rajčániová, M. 2007. *Finančná analýza podniku. (Financial Analysis of a Company)*. Bratislava : Iura Edition. 208 p. ISBN 978-80-8078-117-0.

Kozáková, J., Lančarič, D., Savov, R., Tóth, M. 2014. Organic and conventional production in Slovakia: comparison of selected managerial and financial indicators.

Potravinárstvo, vol. 8, no. 1, p. 254-260. <https://dx.doi.org/10.5219/386>

Munk, M. 2011. *Počítačová analýza dát. (Computer analyses of dates)*. Nitra : UKF. 361 p. ISBN 978-80-8094-895-5.

Pakšiová, R. 2014. *Majetková podstata podniku. (The assets substance in a company)*. Bratislava : Ekonóm. 144 p. ISBN 978-80-225-3962-3.

Pakšiová, R., Kubaščíková, Z. 2014. Risks of company's non-realised profits distribution. In *Managing and Modelling of Financial Risks : 7th International Scientific Conference : 8th-9th September 2014 Ostrava, Czech Republic : proceedings*. Ostrava : VŠB - Technical University of Ostrava, pp. 598-605.

Pakšiová, R., Kubaščíková, Z. 2015. Business property of company and investments. In *Procedia economics and finance : 16th Annual conference on finance and accounting, ACFA, Prague 2015, 29th May 2015*. Holandsko : Elsevier B.V., vol. 25, pp. 70-78. [https://doi.org/10.1016/s2212-5671\(15\)00714-5](https://doi.org/10.1016/s2212-5671(15)00714-5)

Papcunová, V., Hornyák Gregáňová, R., Országhová, D. 2015. Evaluating of the financial management of the municipalities via parameters of data matrix in the Slovak Republic conditions. In *ICABR 2014*. Brno : Mendel University, pp. 803-814. ISBN 978-80-7509-223-6.

Pokrivčák, J., Tóth, M., Zima, Š. 2015. The political economy of capping direct payments in Slovakia. In *ICABR 2015*. Brno : Mendel University, pp. 783-792. ISBN 978-80-7509-379-0.

Ross, S. A. et al. 2008. *Modern financial management*. 8th ed. New York : McGraw-Hill/Irwin. 926 p. ISBN 978-0-07-128652-7.

Serenčేశ, P., Serenčేశ, R., Tóth, M., Čierna, Z., Rábek, T. 2010. *Financie v poľnohospodárstve. (Finance in agriculture)*. Nitra : SPU. 189 p. ISBN 978-80-552-0438-3.

Serenčేశ, P., Tóth, M., Čierna, Z., Rábek, T., Prevužňáková, J. 2014. *Benchmarking pomerových ukazovateľov finančnej analýzy v slovenskom poľnohospodárstve. (Benchmarking of ratio indicators of financial analyzes in agriculture of the Slovak Republic)*. Nitra : SPU. 156 p. ISBN 978-80-552-1159-6.

Scheffler, E. 2006. *Bilanzen richtig lesen. Rechnungslegung nach HGB und IAS/IFRS*. 7th ed. München : C.H.Beck Vrl.. 421 p. ISBN 978-3-423-05827-8.

Správa o poľnohospodárstve a potravinárstve v SR za rok 2010. (Report on agriculture and food sector in the Slovak Republic 2010.) [online] s.a. [cit. 2016-12-13] Available at: <http://www.mpsr.sk/index.php?navID=122&id=5214>.

Správa o poľnohospodárstve a potravinárstve v SR za rok 2012. (Report on agriculture and food sector in the Slovak Republic 2012.) [online] s.a. [cit. 2016-12-13] Available at: <http://www.mpsr.sk/index.php?navID=122&id=8150>.

Správa o poľnohospodárstve a potravinárstve v SR za rok 2014. (Report on agriculture and food sector in the Slovak Republic 2014.) [online] s.a. [cit. 2016-12-13] Available at: <http://www.mpsr.sk/index.php?navID=122&id=9779>.

Stárová, M., Hinke, J., Čermáková, H., Lőrinczová, E., Valder, A., Kuchařová, I., Štáfek, P. 2014. *Asymmetries in accounting information*. Praha : PowerPrint. 174 p. ISBN 978-80-87994-10-8.

Strouhal, J. et al. 2013. *Oceňování v účetnictví. (Valuation in accountancy)*. Praha : Wolters Kluwer ČR, a. s.. 420 p. ISBN 978-80-7478-366-1.

Svoboda, J., Lososová, J., Zdeněk, R. 2015. Analysis of operating costs of subsidies in the field of agriculture of EU

countries. *Agris on-line papers in economics and informatics*, vol. 7, no. 4, p. 161-173.

Šteker, K., Otrusínová, M. 2013. *Jak číst účetní výkazy. Základy českého účetnictví a výkaznictví. (How to read financial statements. Basics of Czech accounting and reporting.)*. Praha : Grada Publishing, a. s.. 264 p. ISBN 978-80-247-4702-6.

Tóth, M., Matveev, V., Boháčiková, A. 2016. Risk of agricultural production in Russian Orel region. *Potravinarstvo*, vol. 10, no. 1, p. 557-562. <https://doi.org/10.5219/664>

Tumpach, M., Juhászová, Z., Meluchová, J. 2013. Is there any relevance of business-related financial reporting in Slovakia. In *Financial management of firms and financial institutions : proceedings : 9th international scientific conference*. Ostrava : VŠB - Technical university of Ostrava, pp. 987-994. ISBN 978-80-248-3172-5. ISSN 2336-162X.

Wagenhofer, A. 2002. *Bilanzierung & Bilanzanalyse*. 7th ed. Wien : Linde Verl.. 320 p. ISBN 3-7073-0425-6.

Acknowledgement:

This article was supported by the project VEGA no. 1/0666/17 with the title Impact of Integration and Globalization on Business Risk in Slovak Agriculture.

Contact address:

Alexandra Ferenczi Vaňová, Slovak University of Agriculture, Faculty of Economics and Management, Department of Accounting, Tr. A. Hlinku 2, 949 76 Nitra Slovakia, E-mail: alexandra.ferenczi@uniag.sk

Renáta Krajčírová, Slovak University of Agriculture, Faculty of Economics and Management, Department of Accounting, Tr. A. Hlinku 2, 949 76 Nitra Slovakia, E-mail: renata.krajcirova@uniag.sk

Michal Munk, Constantine the Philosopher University in Nitra, Faculty of Natural Sciences, Department of Informatics, Tr. A. Hlinku 1, 949 74 Nitra Slovakia, E-mail: mmunk@ukf.sk

Iveta Košovská, Slovak University of Agriculture, Faculty of Economics and Management, Department of Accounting, Tr. A. Hlinku 2, 949 76 Nitra Slovakia, E-mail: iveta.kosovska@uniag.sk

Ivana Váryová, Slovak University of Agriculture, Faculty of Economics and Management, Department of Accounting, Tr. A. Hlinku 2, 949 76 Nitra Slovakia, E-mail: ivana.varyova@uniag.sk



MORPHOMETRIC CHARACTERISTICS OF SWEET CHESTNUT (*CASTANEA SATIVA* MILL.) FRUITS

Ol'ga Grygorieva, Svitlana Klymenko, Ján Brindza, Zuzana Schubertová, Nataliia Nikolaieva, Jana Šimková

ABSTRACT

Aim of this study was to determine morphometric differences of fruits between selected sweet chestnuts (*Castanea sativa* Mill.). The 28 genotypes (referred as CS-01 to CS-28) were introduced by seeds from Czech Republic, Carpathians, Kyrgyzstan. Genotypes of sweet chestnut are grow more than 30 years in Forest-Steppe of Ukraine in the M.M. Gryshko National Botanical Garden of NAS of Ukraine. They are well adapted to the climatic and soil conditions. The fruits were collected at the period of their full maturity (September). The population differs in weight, shape, size and color of fruits. Their morphometric parameters were following: weight from 1.70 g (CS-26) to 18.60 g (CS-20), length from 8.07 mm (CS-28) to 33.39 mm (CS-11), width from 16.34 mm (CS-28) to 40.95 mm (CS-11), thickness from 9.02 mm (CS-26) to 28.70 mm (CS-11) and hilum length from 6.62 mm (CS-26) to 31.30 mm (CS-07), hilum width from 6.50 mm (CS-23) to 19.99 mm (CS-07). The shape index of the fruits was found in the range of 0.81 (CS-20) to 0.98 (CS-12). The shape index of the hilum was found in the range of 1.48 (CS-04) to 2.03 (CS-23). The outcome of the research point to the fact that the genepool Ukrainian sweet chestnut is a rich source of genetic diversity and might be used in selection for creation a new genotypes and cultivars.

Keywords: Sweet chestnuts; Forest-Steppe of Ukraine; fruit; morphometric characteristics; variability

INTRODUCTION

Preservation and growth of biological diversity is of strategic importance for the sustainable development of society. Therefore, the introduction, as a part of experimental botany and plant geography, remains the main direction of activity botanical gardens and other plant growing scientific and research institutions. The urgency of our research is due to the Neglected and Underutilized Plant Species: strategic plan of action the Bioversity International, which provides the stability of ecosystems and conservation of biological diversity (IPGRI, 2002). Nowadays, the awareness is given more and more to underutilized and unusual fruits as *Sorbus domestica* L. (Žiarovská and Poláčková, 2012), *Cydonia oblonga* Mill. (Monka et al., 2015). One of them is *Castanea sativa* Mill. not only as an endangered species, but as well as a promising and economically usable crop. Especially important is the question about introduction of new plants into cultivation in connection with global climate change, which had started in the last decade. Introduction and acclimatization of rare fruit plants in Ukraine contribute to increase biodiversity of our flora. To promising underutilized fruit plants for Forest-Steppe of Ukraine belongs *Castanea sativa* (Klymenko and Grygorieva, 2013). Chestnut (*Castanea* Mill.) has been placed in the Fagaceae family. In total, 13 *Castanea* species are

recognized and are native to the temperate zone of the Northern Hemisphere; five in East Asia, seven in North America and one in Europe (Burnham et al., 1986). The most important of them are: *Castanea sativa* Mill. (Europe, Asia Minor, North Africa), *C. dentata* (Marsh.) Borkh. (USA), *Castanea mollissima* Blume and *C. crenata* Sieb. et Zucc. (Eastern Asia). *C. sativa* is the most consumed (Goulão et al., 2001). In common, chestnuts are used as a food, its chemical composition is similar to potatoes or cereals (Vojtaššáková et al., 2000), however chestnuts or chestnuts by-products may be used as a source of energy, nutrients and active substances also in animal nutrition (Gálik et al., 2014; Šimko et al., 2014). Chestnuts possess many characteristics that are used by human for different purposes, not only as a part of the food. One of them is the utilization of the sweet chestnut pollen for its pharmacological benefits (Žiarovská et al., 2015).

There are many authors who have been researching phenotypic diversity among various local populations of sweet chestnut in Italy (Borghetti et al., 1986; Casini et al., 1993; Jacoboni, 1993; Ponchia et al., 1993; Beccaro et al., 2005), in France (Breisch, 1993), in Portugal (Costa et al., 2005), in Spain (Pereira-Lorenzo et al., 1996; Fernández-López, 2005), in Greece (Alizoti and Aravanopoulos, 2005), in Turkey (Villani, 1992; Serdar, 1999; Serdar and Soylu, 1999; Ertan, 2007; Ormeci et

al., 2016), in Romania (Botu et al., 1999), in Slovenia (Solar et al., 1998; Podjavoršek et al., 1999), in Slovak Republic (Bolvanský et al., 2009), in Czech Republic (Haltofová and Jankovsky, 2003), in Spain (Alvarez, 2005; Furones and Fernández-López, 2005; Alvarez-Alvarez et al., 2006), in Bosnia and Herzegovina (Mujić et al., 2010), in Iran (Atefe et al., 2015) and in India (Pandit et al., 2011). This researches form basis for the selection of the best types from natural populations of sweet chestnut (Bounous et al., 2000). Most of the chestnut cultivars, used in commercial production, were obtained with selection studies from natural chestnut populations (Ertan et al., 2007; Pandit et al., 2011).

The aim of this study was to separate, based on our research, the best genotypes from our collections sweet chestnut, which can be successfully grown on plantations, as well as ornamental trees.

MATERIAL AND METHODOLOGY

Locating trees and data collection

The objects of the research were 30-year-old plants of sweet chestnut from seed origin, which are growing in Forest-Steppe of Ukraine in M.M. Gryshko National Botanical Garden of NAS of Ukraine (NBG). Seeds were brought from Czech, Carpathians, Kyrgyzstan. They are well adapted to the climatic and soil conditions. Observations on the collection’s forms of sweet chestnut in

the period 2013 – 2015 were performed during mass fruiting. We have described 28 genotypes of sweet chestnut. In autumn, when the nuts began to fall, a sample of one kg with burrs was collected from the marked trees. The harvest time was recorded.

Morphometric characteristics

Pomological characteristics were conducted with four replications on a total 30 nuts per genotypes. In the study only one plant (tree) used for per genotype.

The following measurements were taken: fruit length (FL), in mm, fruit weight (FS), in g, fruit thickness (FT), in mm, fruit width (FW), in mm and hilum length (HL), in mm, hilum width (HW), in mm. The measurements were made in each nut element as shown in Figure 1. Data, we are working with, were tested for normal distribution.

Basic statistical analyses were performed using SAS System v. 9.2 (SAS 2009). The DISTRIBUTION analysis (verification of normal distribution of input data), the CORRELATION procedure, the CLUSTER procedure, the TREE procedure (creating the dendrogram) in SAS 9.2. for further detailed analysis were used. Variability of all these parameters was evaluated using descriptive statistics. Correlation between traits was determined using the Pearson correlation coefficient. Dendrogram clustering the data from the individual experimental genotypes using average linkage using Euclidian distance as metric.

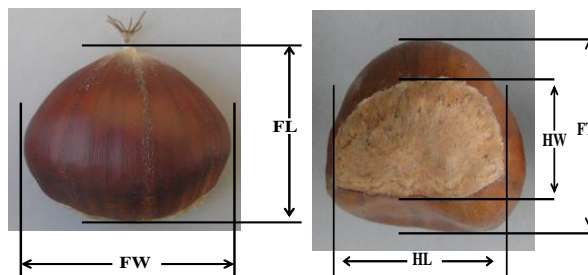

Figure 1 Illustration of measuring process: length, width, thickness and hilum length and width.



Figure 2 Variability in the shape of sweet chestnut (*Castanea sativa* Mill.) fruits.



Figure 3 Variability in the shape of sweet chestnut (*Castanea sativa* Mill.) hilum.

RESULTS AND DISCUSSION

The weight of the whole fruit is one of significant production characteristics of plant species. Further important features of the fruit are shape, size and color. These characteristics of the sweet chestnut fruit varied significantly. The images of sweet chestnut fruits of various genotypes are shown on Figure 2, 3. High variability of the size, shape and color of these fruits are evident.

Fruit weight (g)

The weight of sweet chestnut fruits of present study was in the range of 1.70 to 20.0 g (Table 1). Coefficient of variation was 45.92%, which shows a very high degree of variability of fruit weight. Significant differences in fruit weight were reaffirmed a lot of authors from different countries (Table 2). The fruit weight was determined in range from 2.98 g by Aravanopoulos et al. (2001) to 39.73 g by Ormeci et al. (2016). Data comparison shows a high consistency with our results. There are genotypes, which reached minimum and maximum values in these characteristic, in Table 3.

Fruit length (mm)

The fruit length in our analyses was determined in the range of 8.07 to 33.39 mm (Table 1). The value of the coefficient of variation was 13.74%, which documented medium degree of variability of the character within the collection. Significant differences in fruit length were reaffirmed a lot of authors from different countries (Table 2). The fruit length was determined in range from 19.10 mm (Aravanopoulos et al., 2001) to 39.73 mm (Ormeci et al., 2016). In case of data comparison tested genotypes from Ukraine have low values on this characteristic. There are genotypes, which reached minimum and maximum values in these characteristic, in Table 3.

Fruit width (mm)

In our experiments the fruit width was determined in the range of 16.34 to 40.95 mm (Table 1). The variation coefficient (14.98%) confirmed medium degree of variability within the collection. Significant differences in fruit width were reaffirmed a lot of authors from different countries (Table 2). The fruit width was determined in

Table 1 The variability of some morphometric characteristics of fruits for the whole collection of sweet chestnut (*Castanea sativa* Mill.) genotypes from Kyiv.

Characteristics	Unit	n	min	max	mean	CV%
Fruit weight	g	840	1.70	20.0	6.85	45.92
Fruit length	mm	840	8.07	33.39	23.74	13.74
Fruit width	mm	840	16.34	40.95	26.52	14.98
Fruit thickness	mm	840	9.02	28.70	16.62	20.57
Hilum length	mm	840	6.62	31.30	21.15	19.58
Hilum width	mm	840	6.50	19.99	12.24	20.66

Note: n – number of measurements; min, max – minimal and maximal measured values; mean – arithmetic mean; CV – coefficient of variation (%).

Table 2 Variability of some morphometric characteristics on sweet chestnut fruits according to the authors from different countries.

Authors	Fruit			Hilum		
	Weight (g)	Length (mm)	Width (mm)	Thickness (mm)	Length (mm)	Width (mm)
Borghetti et al., (1986)	9.41 – 16.60	25.89 – 30.41	30.86 – 37.59	19.09 – 23.96	–*	–*
Pereira-Lorenzo et al., (1996)	8.00 – 15.00	24.80 – 32.70	28.20 – 35.90	–*	–*	–*
Aravanopoulos et al., (2001)	2.98 – 6.07	19.10 – 24.90	18.80 – 23.80	10.80 – 14.80	12.90 – 14.50	6.00 – 7.00
Solar et al., (2005)	3.50 – 18.60	20.00 – 37.00	12.00 – 39.00	14.00 – 25.00	12.00 – 32.00	7.00 – 16.00
Alvarez-Alvarez et al., (2006)	–*	25.80 – 31.40	25.20 – 34.40	14.20 – 20.20	–*	–*
Ertan, (2007)	–*	30.39 – 34.31	23.70 – 35.17	18.95 – 23.70	–*	–*
Mujić et al., (2010)	4.32 – 6.67	20.45 – 24.89	23.45 – 27.10	21.26 – 27.29	–*	–*
Odalovic et al., (2013)	4.80 – 10.60	19.60 – 30.60	23.70 – 34.90	13.30 – 23.80	19.00 – 31.00	11.00 – 16.00
Ormeci et al., (2016)	10.26 – 22.32	27.74 – 39.73	26.80 – 42.47	–*	–*	–*
Silva et al., (2016)	9.00 – 18.67	29.30 – 37.90	25.40 – 34.00	16.10 – 23.50	–*	–*
Bolvanský et al., (2012)	2.94 – 13.40	16.41 – 27.75	19.81 – 34.17	–*	–*	–*

range from 12.00 mm (Solar et al., 2005) to 42.47 mm (Ormeci et al., 2016). Data comparison shows a high consistency with our results. There are genotypes, which

reached minimum and maximum values in these characteristic, in Table 3.

Table 3 The fruits variability of sweet chestnut (*Castanea sativa* Mill.) genotypes from the collection.

Genotypes	Mean Lowest values	SD	CV%	Genotypes	Mean Highest values	SD	CV%
Fruit weight (g)							
CS-28	2.68	0.42	15.72	CS-07	9.12	1.71	18.75
CS-26	2.78	0.78	28.28	CS-03	10.29	1.82	17.74
CS-14	3.59	0.65	18.29	CS-08	11.95	2.53	21.25
CS-27	3.63	0.68	18.94	CS-11	13.58	2.60	19.02
CS-16	4.00	0.75	18.72	CS-20	13.61	2.88	21.19
Fruit length (mm)							
CS-28	16.54	1.85	11.23	CS-08	26.83	1.48	5.54
CS-26	17.94	1.38	7.72	CS-03	27.12	0.80	2.97
CS-27	18.72	1.09	5.82	CS-20	27.83	2.04	7.32
CS-14	20.16	1.03	5.03	CS-05	28.17	1.08	3.86
CS-24	22.05	1.23	5.60	CS-11	29.90	1.78	5.95
Fruit width (mm)							
CS-28	19.07	1.35	7.10	CS-08	29.75	1.36	4.59
CS-26	20.24	2.02	9.99	CS-05	29.94	1.63	5.46
CS-14	21.95	1.24	5.63	CS-03	30.54	1.23	4.03
CS-27	22.06	1.83	8.30	CS-11	33.44	2.53	7.57
CS-16	23.35	1.49	6.38	CS-20	33.96	2.68	7.90
Fruit thickness (mm)							
CS-26	11.86	1.76	14.83	CS-01	19.90	2.45	12.34
CS-28	12.61	1.93	15.33	CS-07	20.04	3.56	17.76
CS-27	12.97	1.33	10.30	CS-11	20.43	3.25	15.94
CS-14	13.22	1.64	12.40	CS-03	21.75	2.46	11.31
CS-16	14.09	1.24	8.84	CS-20	23.72	2.11	8.91
Hilum length (mm)							
CS-12	15.16	2.62	17.34	CS-21	24.82	2.29	9.24
CS-28	15.43	2.04	13.26	CS-01	25.00	2.15	8.61
CS-26	15.95	2.62	16.42	CS-20	26.18	2.62	10.01
CS-09	16.57	3.23	19.54	CS-07	26.42	3.39	12.84
CS-14	17.63	1.87	10.65	CS-03	26.81	1.97	7.34
Hilum width (mm)							
CS-12	8.98	0.68	7.67	CS-01	14.64	1.79	12.29
CS-28	9.31	1.21	13.08	CS-04	15.14	2.03	13.41
CS-26	9.57	1.34	14.03	CS-20	15.75	1.65	10.50
CS-09	10.01	1.20	12.00	CS-07	15.94	2.15	13.51
CS-24	10.12	0.93	9.22	CS-03	15.98	2.06	12.94

Note: mean – arithmetic mean; SD – standard deviation; CV – coefficient of variation (%).

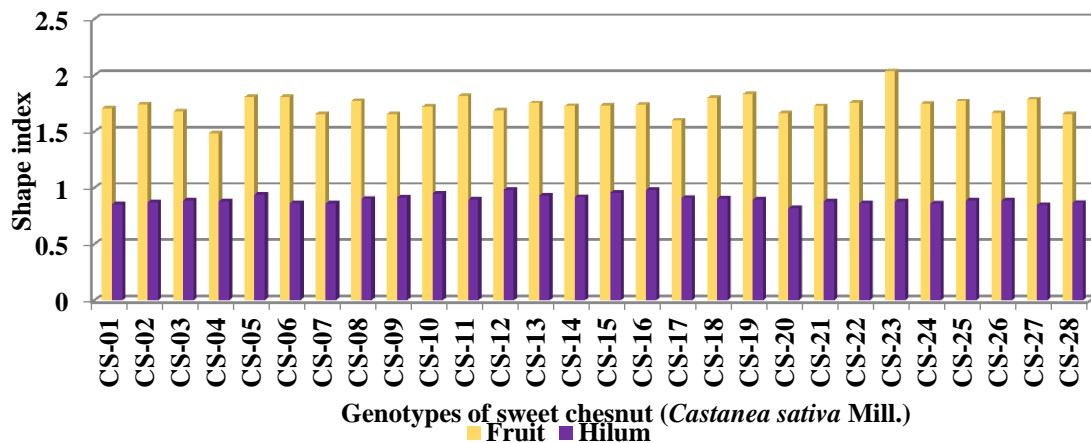

Figure 4 Comparison of the tested sweet chestnut (*Castanea sativa* Mill.) genotypes in the shape index of fruit and hilum.

Fruit thickness (mm)

In evaluated genotypes we determined the fruit thickness in the range of 9.02 to 28.70 mm (Table 1). The value of the coefficient of variation was 20.57%, which documents a high degree of variability of the characteristic within the collection. Significant differences in fruit thickness were reaffirmed a lot of authors from different countries (Table 2). The fruit thickness was determined in range from 10.80 mm (Aravanopoulos et al., 2001) to 27.29 mm (Mujić et al., 2010). Data comparison shows a high consistency with our results. There are genotypes, which reached minimum and maximum values in these characteristic, in Table 3.

Hilum length (mm)

Hilum length was identified in range from 6.62 mm to 31.30 mm (Table 1). The value of the coefficient of variation documented a high degree of variability of these characteristic. Significant differences in fruit hilum length were reaffirmed a lot of authors from different countries (Table 2). The hilum length was determined in range 12.00 – 32.00 mm (Solar et al., 2005). Data comparison shows a high consistency with our results. There are genotypes, which reached minimum and maximum values in these characteristic, in Table 3.

Table 4 The linear relationship between of the morphometric characteristics of evaluated genotypes of sweet chestnut (*Castanea sativa* Mill.).

Characteristic	r	sr	Confidence Interval r _{95%}	r ²	p
1 FW/FL	0.85	1.60	0.70 ≤ r ≤ 0.93	0.73	**
2 FW/FS	0.92	1.38	0.83 ≤ r ≤ 0.96	0.85	**
3 FW/FT	0.91	1.13	0.83 ≤ r ≤ 0.96	0.84	**
4 FW/HL	0.68	2.48	0.42 ≤ r ≤ 0.84	0.47	**
5 FW/HW	0.67	1.58	0.39 ≤ r ≤ 0.83	0.45	**
6 HL/HW	0.94	0.69	0.88 ≤ r ≤ 0.97	0.89	**
7 FL/FS	0.94	1.20	0.87 ≤ r ≤ 0.97	0.88	**
8 FL/FT	0.82	1.63	0.64 ≤ r ≤ 0.91	0.67	**
9 FL/HL	0.70	2.43	0.44 ≤ r ≤ 0.85	0.49	**
10 FL/HW	0.63	1.64	0.34 ≤ r ≤ 0.81	0.40	**
11 FS/FT	0.90	1.19	0.80 ≤ r ≤ 0.95	0.82	**
12 FS/HL	0.80	2.00	0.62 ≤ r ≤ 0.90	0.65	**
13 FS/HW	0.74	1.42	0.51 ≤ r ≤ 0.87	0.55	**
14 FT/HL	0.78	2.13	0.57 ≤ r ≤ 0.89	0.61	**
15 FT/TP	0.77	1.35	0.55 ≤ r ≤ 0.88	0.59	**

Legend: r – Pearson’s correlation coefficient, sr – standard error of the coefficient, r² – coefficient of determination, ** p ≤ 0.01

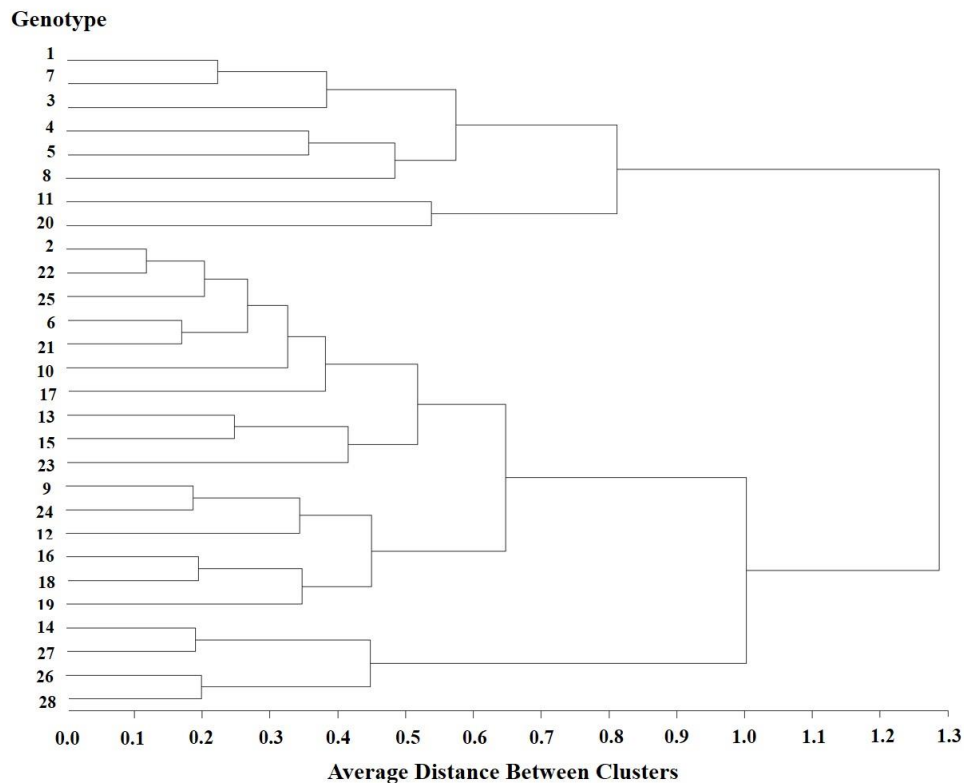

Figure 5 Dendrogram of 28 genotypes of sweet chestnut (*Castanea sativa* Mill.) based on morphometric characteristics of fruits.

Hilum width (mm)

Hilum width was identified in range from 6.50 – 19.99 mm (Table 1). The value of the coefficient of variation documented a high degree of variability of these characteristic. Significant differences in fruit hilum width were reaffirmed a lot of authors from different countries (Table 2). The hilum width was determined in range from 6.00 mm (Aravanopoulos et al., 2001) to 16.00 mm (Solar et. al., 2005; Odalovic et al., 2013). Data comparison shows a high consistency with our results. There are genotypes, which reached minimum and maximum values in these characteristic, in Table 3.

Shape index

The shape of each object can be characterized by the shape index, i.e. the length to width ratio. Figure 3 represents the shape indexes of fruits and hilum. The shape index of the fruits was found in the range from 1.48 (CS-04) to 2.03 (CS-23), so the genotype's collection demonstrates significant variability in the shape of the fruit, as seen in Figure 2 and Figure 3. The shape index of the hilum was found in the range from 0.81 (CS-20) to 0.98 (CS-12). This parameter can be used for the identification of the genotypes.

The relationship between specific characteristics

The results of the analysis are given in Table 4. The results indicated high correlations ($r = 0.63 - 0.94$). The results document that between specific characteristics is positive relationship which is very important in sweet chestnut's breeding.

Clustering of sweet chestnut genotypes based on fruit characteristics

The genetic relationship among the 28 genotypes was examined by cluster analysis. The figure clearly identified significant differences between tested sweet chestnut genotypes. Dendrogram has showed 3 main groups (Figure 5). Eight of the 28 genotypes were included in cluster group A, 16 genotypes in group B, 4 genotypes in group C. The group B had the highest mean for morphological characteristics (fruit weight, fruit length, fruit width, fruit thickness, hilum length, hilum width), that were significantly different with other groups. The results this assessment related to group C had the lowest mean of morphological parameters. Figure confirms the results from the evaluated variability of morphometric characteristics (Table 1).

CONCLUSION

The results of the experiment presented in this work are consistent with the results reported earlier. In evaluating 28 genotypes of sweet chestnut we determined the weight of the fruits in the range from 1.70 g (CS-26) to 18.60 g (CS-20), length from 8.07 mm (CS-28) to 33.39 mm (CS-11), width from 16.34 mm (CS-28) to 40.95 mm (CS-11), thickness from 9.02 mm (CS-26) to 28.70 mm (CS-11) and hilum length from 6.62 mm (CS-26) to 31.30 mm (CS-07), hilum width from 6.50 mm (CS-23) to 19.99 mm (CS-07).

The results about relationship between specific characteristics were indicated as a high correlation ($r = 0.63 - 0.94$).

Presented results also showed that significant differences in the evaluated characteristics were found for the studied sweet chestnut genotypes. Obtained results are important for breeding new varieties of sweet chestnut as well as their practical use.

This study is significant because it is the first selection work in Ukraine. Adaptation studies will also be required for the selected sweet chestnut genotypes. The results of the study are helpful for understanding the variability and attempting the selection of superior desirable sweet chestnut accessions for bringing to commercial cultivation.

REFERENCES

- Alizoti, P. G., Aravanopoulos, F. A. 2005. Genetic variation of fruit traits in hellenic chestnut (*Castanea sativa* Mill.) populations: a first assessment. *Acta Horticulturae*, vol. 693, p. 413-420. <https://doi.org/10.17660/ActaHortic.2005.693.51>
- Alvarez, J. B., Martin, M. A., Muñoz, C., López, S., Martin, L. M. 2005. Genetic variability of chestnut in Andalusia (Spain). *Acta Horticulturae*, vol. 693, p. 471-476. <https://doi.org/10.17660/ActaHortic.2005.693.60>
- Alvarez-Alvarez, P., Barrio-Anta, M., Dieguez-Aranda, U. 2006. Differentiation of sweet chestnut (*Castanea sativa* Mill.) cultivars by leaf, nut and burr dimensions. *Forestry*, vol. 79, no. 2, p. 149-158. <https://doi.org/10.1093/forestry/cpl006>
- Aravanopoulos, F. A., Drouzas, A. D., Alizoti, P. G. 2001. Electrophoretic and quantitative variation in chestnut (*Castanea sativa* Mill.) in Hellenic populations in old-growth natural and coppice stands. *Forest Snow and Landscape Research*, vol. 76, no. 3, p. 429-434.
- Atefe, K., Kambiz, T. A., Javad, T. 2015. Variations in Leaf and Fruit Morphological Traits of Sweet Chestnut (*Castanea sativa*) in Hyrcanian Forests, Iran. *International Journal of Plant Research*, vol. 1, no. 4, p. 155-161.
- Beccaro, G. L., Botta, R., Torello Marinoni, D., Akkak, A., Bounous, G. 2005. Application and evaluation of morphological, phenological and molecular techniques for the characterization of *Castanea sativa* Mill. cultivars. *Acta Horticulturae*, vol. 693, p. 453-458. <https://doi.org/10.17660/ActaHortic.2005.693.57>
- Bolvanský, M., Užík, M. 2012. Variability of chestnuts in selected localities of Slovakia (Variabilita gaššana jedlého na vybraných lokalitách Slovenska). Biodiversity in agricultural landscape and ecosystem (Biodiverzita v poľnohospodárskej krajine a v ekosystéme). In *Proceedings of the International Congress REVERSE-INTERREG IVC*. Piešťany : Research Institute of Plant Production, p. 44-47.
- Bolvanský, M., Tokár, F., Tarinová, D., Užík, M. and Kormuťák, A. 2009. Phenotypic and genetic differences among populations of European chestnut (*Castanea sativa* Mill.) in Slovakia. *Acta Horticulturae*, vol. 844, p. 235-242. <https://doi.org/10.17660/ActaHortic.2009.844.32>
- Borghetti, M., Menozzi, P., Vendramin, G. G., Giannini, R. 1986. Morphological variation in chestnut fruits (*Castanea sativa* Mill.) in Tuscany (Italy). *Silvae Genetica*, vol. 35, no. 2-3, p. 124-128.
- Botu, M., Achim, G., Turcu, E. 1999. Evaluation of some chestnut selections from the population formed into the ecological conditions from the north-east of Oltenia. *Acta Horticulturae*, vol. 494, p. 77-83. <https://doi.org/10.17660/ActaHortic.1999.494.10>
- Bounous, G., Botta, R., Beccaro, G. 2000. The chestnut: the ultimate energy source nutritional value and alimentary benefits. *Nucis*, vol. 9, p. 44-50.

- Breisch, H. 1993. Harvesting, storage and processing of chestnuts in France and Italy. In: *Proceedings of International Congress on Chestnut. Comunità Montana Monti Martani e Serano e Istituto di Coltivazioni Arboree*. Spoleto, Italy : Università di Perugia, p. 429-436. ISBN 9066051000.
- Burnham, C. R., Rutter, P. A., French, D. W. 1986. Breeding blight-resistant chestnuts. *Plant Breeding Reviews*, vol. 4, p. 347-397. <https://doi.org/10.1002/9781118061015.ch11>
- Casini, E., Alessandri, S., Caivelli, S. 1993. Quantitative description of chestnut (*Castanea sativa*) accessions, selected from a population grown in Florence province (Mugello zone). In: *Proceedings of the International Congress on Chestnut*. Spoleto, Italy, Perugia: Istituto di Coltivazioni Arboree, University of Perugia. 687 p.
- Costa, R., Valdivieso, T., Marum, L., Fonseca, L., Borges, O., Soeiro, J., Matos Soares, F. A., Sequeira, J., Assunção, A., Correia, P. 2005. Characterisation of traditional Portuguese chestnut cultivars by nuclear SSRs. *Acta Horticulturae*, vol. 693, p. 437-440. <https://doi.org/10.17660/ActaHortic.2005.693.54>
- Ertan, E. 2007. Variability in leaf and fruit morphology and in fruit composition of chestnuts (*Castanea sativa* Mill.) in the Nazilli region of Turkey. *Genetic Resources and Crop Evolution*, vol. 54, p. 691-699. <https://doi.org/10.1007/s10722-006-0020-6>
- Fernández-López, J., Zas, R., Diaz, R., Villani, F., Cherubini, M., Aravanopoulos, F. A., Alizoti, P. G., Eriksson, G., Botta, R., Mellano, M.G. 2005. Geographic variability among extreme European wild chestnut populations. *Acta Horticulturae*, vol. 693, p. 181-186. <https://doi.org/10.17660/ActaHortic.2005.693.21>
- Furones, P., Fernández-López, J. 2005. Differentiation among chestnut cultivars using adaptative and morphological traits. *Acta Horticulturae*, vol. 693, p. 497-504. <https://doi.org/10.17660/ActaHortic.2005.693.64>
- Gálik, B., Biro, D., Rolinec, M., Šimko, M., Juráček, M. 2014. Nutrition and feeding as a critical point of meat production. In: Chrenek, P. et al. *Biotechnology and Animal Food Quality, Part IV, Biotechnology in Animal Biodiversity and Food Resources*. 1st ed. Nitra: Slovak University of Agriculture in Nitra, p. 86-108. ISBN 978-80-552-1198-5.
- Goulão, L., Valdivieso, T., Santana, C., Oliveira, C. M. 2001. Comparison between phonetic characterization using RAPD and ISSR markers and phenotypic data of cultivated chestnut (*Castanea sativa* Mill.). *Genetic Resources and Crop Evolution*, vol. 48, p. 329-338. <https://doi.org/10.1023/A:1012053731052>
- Haltofová, P., Jankovský, L. 2003. Distribution of sweet chestnut *Castanea sativa* Mill. in the Czech Republic. *Journal of Forest Science*, vol. 49, no. 6, p. 259-272.
- IPGRI, (2002) Annual report for 2002. Neglected and Underutilized Plant Species: Strategic Action Plan of the International Plant Genetic Resources Institute. Rome: International Plant Genetic Resources Institute.
- Jacoboni, A. 1993. Observations about ecotypes of chestnut in the Spoleto area. In: *Proceedings of the International Congress on Chestnut*. Spoleto, Perugia : Istituto di Coltivazioni Arboree, University of Perugia. 687 p.
- Klymenko, S., Grygorieva, O. 2013. Non-traditional horticultural plants in the register of sorts of plants of Ukraine. *Biologija*, vol. 59, no. 1, p. 80.
- Monka, A., Grygorieva, O., Chlebo, P., Brindza, J. 2014. Morphological and antioxidant characteristics of quince (*Cydonia oblonga* Mill.) and chinese quince fruit (*Pseudocydonia sinensis* Schneid.). *Potravinarstvo*, vol. 8, no. 1, p. 333-340. <https://dx.doi.org/10.5219/415>
- Mujić, I., Alibabici, V., Zivkovic, J., Jahici, S., Jokic, S., Prgommet, Z., Tuzlak, P. 2010. Morphological characteristics of chestnut *Castanea sativa* from the area of NUA- SANA cantion. *Journal of Central European Agriculture*, vol. 11, no. 2, p. 185-190.
- Odalovic, A., Prekic, R., Dubak, D., Jovancevic, M., Cizmovic, M., Radunovic, M. 2013. Effect of ecological conditions on expression of biopomological characteristics of chestnut (*Castanea sativa* Mill.) in natural populations of Montenegro. *Genetika*, vol. 45, no. 1, p. 251-260. <https://doi.org/10.2298/GENSRI3012510>
- Ormeci, Y., Akca, Y., Ercisli, S. 2016. Selection of promising chestnuts (*Castanea sativa*) among wild growing trees from southern Mediterranean region forests of Turkey. *Journal of Forestry Research*, vol. 27, no. 2, p. 349-355. <https://doi.org/10.1007/s11676-015-0142-9>
- Pandit, A. H., Mir, M. A., Kour, A., Bhat, K. M. 2011. Variability and selection of chestnut (*Castanea sativa* Mill.) genotypes in Srinagar district of the Kashmir Valley. *Pakistan Journal of Agricultural Sciences*, vol. 50, no. 2, p. 205-209.
- Pereira-Lorenzo, S., Fernandez-Lypez, J., Moreno-Gonzalez, J. 1996. Variability and grouping of northwestern Spanish chestnut cultivars. I. Morphological traits. *Journal of the American Society for Horticultural Science*, vol. 121, no. 2, p. 183-189.
- Podjavoršek, A., Štampar, F., Solar, A., Batic, F. 1999. Morphological variation in chestnut fruits (*Castanea sativa* Mill.) in Slovenia. *Acta Horticulturae*, vol. 494, p. 129-132. <https://doi.org/10.17660/ActaHortic.1999.494.18>
- Ponchia, G., Bergamini, A., Tomasi, G., Gardiman, M., Fila, G. 1993. Observations on some chestnut cultivars found in the Trento area. In: *Proceedings of the International Congress on Chestnut*. Spoleto, Perugia : Istituto di Coltivazioni Arboree, University of Perugia. 687 p.
- SAS, 2009. User's Guide Version 9. 2. SAS/STAT® SAS Institute Inc. Cary, NC, USA.
- Serdar, Ü. 1999. Selection of chestnut (*Castanea sativa* Mill.) in Sinop vicinity. *Acta Horticulturae*, vol. 494, p. 327-332. <https://doi.org/10.17660/ActaHortic.1999.494.50>
- Serdar, Ü., Soylu, A. 1999. Selection of chestnuts (*C. sativa* Mill.) in Samsun vicinity. *Acta Horticulturae*, vol. 494, p. 333-338. <https://doi.org/10.17660/ActaHortic.1999.494.51>
- Solar, A., Podjavoršek, A., Štampar, F. S. 2005. Phenotypic and Genotypic Diversity of European Chestnut (*Castanea sativa* Mill.) in Slovenia – Opportunity for Genetic Improvement. *Genetic Resources and Crop Evolution*, vol. 52, no. 4, p. 381-394. <https://doi.org/10.1007/s10722-005-2252-2>
- Solar, A., Štampar, F., Podjavoršek, A., Siftar, A., Kodric, I. 1998. Characterisation of seven preselected chestnut fruit types from Slovene chestnut (*Castanea sativa* Mill.) population. *Acta Horticulturae*, vol. 494, p. 95-100.
- Šimko, M., Biro, D., Juráček, M., Gálik, B., Rolinec, M. 2014. Nutrition and feeding as a critical point of milk production. In: Chrenek, P. et al. *Biotechnology and Animal Food Quality, Part IV, Biotechnology in Animal Biodiversity and Food Resources*. 1st ed. Nitra : Slovak University of Agriculture in Nitra, p. 109-128. ISBN 978-80-552-1198-5.
- Villani, F., Pigliucci, M., Lauteri, M., Cherubini, M. 1992. Congruence between genetic, morphometric and physiological data on differentiation of Turkish chestnut (*Castanea sativa*). *Genome*, vol. 35, no. 2, p. 251-256. <https://doi.org/10.1139/g92-038>

Vojtaššáková, A., Kováčiková, E., Simonová, E., Holčíková, K., Pastorová, J., Klvanová, J. 2000. Fats, Oil-bearing Plants, Oils and Nuts. 1st ed. Nitra: ÚVTIP Nitra.

Žiarovská J., Grygorieva O., Zeleňáková L., Bežo M., Brindza J. 2015. Identification of sweet chestnut pollen in bee pollen pellet using molecular analysis. *Potravinárstvo*, vol. 9, no. 1, p. 352-358. <https://doi.org/10.5219/497>

Žiarovská J., Poláčeková, P. 2012. Efficiency of real-time PCR for 18S rRNA amplification of *Sorbus domestica* L. *Potravinárstvo*, vol. 6, no. 3, p. 47-49. <https://doi.org/10.5219/203>

Acknowledgments:

The publication was prepared with the active participation of researchers in international network AGROBIONET, as a part of international program "Agricultural biodiversity to improve nutrition, health and quality of life" within the project ITEBIO-ITMS 26220220115 „Support of technologies innovation for special bio-food products for human healthy nutrition“. Experimental activities were realized in laboratories of Excellent center for the conservation and use of agrobiodiversity at the Faculty of Agrobiolgy and Food Resources, Slovak Agricultural University in Nitra.

Contact address:

Mgr. Oľga Grygorieva, PhD., M.M. Gryshko National Botanical Gardens of Ukraine National Academy of

Sciences, Timiryazevska 1, 01014 Kyiv, Ukraine, E-mail: ogrygorieva@mail.ru

Prof. Svitlana Klymenko, M.M. Gryshko National Botanical Gardens of Ukraine National Academy of Sciences, Timiryazevska 1, 01014 Kyiv, Ukraine, E-mail: cornusklymenko@mail.ru.

doc. Ing. Ján Brindza, PhD., Slovak University of Agriculture in Nitra, Faculty of Agrobiolgy and Food Resources, Institute of Biological Conservation and biosafety, Trieda Andreja Hlinku 2, 949 76 Nitra, Slovakia, E-mail: Jan.Brindza@uniag.sk

Ing. Zuzana Schubertová, PhD., Slovak University of Agriculture in Nitra, Faculty of Agrobiolgy and Food Resources, Institute of Biological Conservation and biosafety, Trieda Andreja Hlinku 2, 949 76 Nitra, Slovakia, E-mail: zuzana.schubertoval@uniag.sk

Ing. Nataliia Nikolaieva, Slovak University of Agriculture in Nitra, Faculty of Agrobiolgy and Food Resources, Institute of Biological Conservation and biosafety, Trieda Andreja Hlinku 2, 949 76 Nitra, Slovakia, E-mail: n.nikolaeva703@gmail.com

Ing. Jana Šimková, Slovak University of Agriculture in Nitra, Faculty of Agrobiolgy and Food Resources, Institute of Biological Conservation and biosafety, Trieda Andreja Hlinku 2, 949 76 Nitra, Slovakia, E-mail: jana.simkova@uniag.sk



EFFECT OF RIPENING TIME ON COLOUR AND TEXTURE PROPERTIES IN CHEESE

Šárka Nedomová, Libor Kilián, Roman Pytel, Vojtěch Kumbár

ABSTRACT

The group of semi-hard cheeses is quite heterogenous and there are distinctions between individual representatives of this group. The aim of this paper was a comparison the colour changes and texture properties of semi-hard pasta filata cheeses during ripening. Spectrophotometer Konica Minolta CM-3500d was used for the colour measurements of cheese samples. Color parameters L^* a^* b^* were determined for the edge part and for the middle part of samples. The texture properties of cheese were measured by TIRATEST 27025. Measurements were made for part following the edge and the middle part of samples as well. During ripening of cheese samples there were observed statistically significant changes in the colour parameters of the edge part of oiled cheese. Total colour difference (ΔE^*_{ab}) during storage was the most noticeable in first 10 days of ripening. In compare with changes in a^* parameter of the edge part of cheese samples, red tone (a^* parameter) in the middle part of cheese samples did not show so large change. The measured strenght of edge part of the cheese samples was in range between from 7.44 N up to 23.49 N. Firmness of middle part varied from 4.46 N to 24.40 N in 60 days of maturing.

Keywords: colour; texture; ripening; semi-hard cheese

INTRODUCTION

Classify a cheese to group of semi-hard cheeses is very arbitrary. In comparison with other groups of cheeses (e.g., hard cheeses, smear-ripened varieties or pasta filata cheeses), the group of semi-hard cheeses is quite heterogenous and there are distinctions between individual representatives of this group. Semi-hard cheeses include Colby and Monterey (Cheddar typer cheeses), British Territorial varieties (Caerphilly, Lancashire), Slovak Bryndza cheese and Majorero cheese from Spain (Fox, 2000). Keresteš et al. (2016) divided semi-hard cheeses into few smaller groups of cheeses (semi-soft cheeses, white cheeses, blue-veined cheeses and pasta filata cheeses).

Under common designation “Caciocavallo” fall Italian pasta filata cheese “Caciocavallo Silano” which obtained PDO mark, Caciocavallo Molisano etc., Balkanian types “Kashkaval Balkan” and Russian “Kashkaval”. In Northern Italy is produced PDO pasta filata cheese “Provolone Valpadana” which is made by using a similar method but sold under the different names (Piraino et al., 2005). Between pasta filata cheeses belong “Klenovecký syrec”, “Ostiepok”, “Parenica” and “Korbacik” which obtained PGI mark and have its origin in Slovak Republic (Keresteš et al., 2016). One of the most important Turkish cheese varieties of pasta filata semi-hard cheese is “Kashar” cheese, which is similar to Caciocavallo,

Provolone, Regusono, Kashkaval, and Mozzarella (Kavas et al., 2015).

Most rennet-coagulated cheeses are ripened (matured) for period ranging from about 3 weeks to more than 2 years. Duration of the ripening inversely related to the moisture content of cheese (Fox, 2000). Based on US Food and Drug Administration’s 2013 Food Code, cheeses made of raw milk are divided into 30 categories based on pH and water activity. These attributes were used for control of vegetative cells and spores in non-heat-treated food. Category C1 is represented by semisoft stretched cheese “Provolone” and hard stretched “Caciocavallo Siciliano” (Trmčič et al., 2017).

The ripening is complex of biochemical processes which takes place under physical, microbial and enzymatic conditions. During ripening, composition, organoleptic properties and the structure are modified (Fox, 2004; Spreer, 1998).

Lovayová et al. (2010) made semi-hard cheese with the addition of probiotic culture as additional cultures, monitored their survival during maturation and effect on the physicochemical and sensory evaluation of final product during ripening.

The physical properties of cheese (body/texture, melt/stretch, and colour) are influenced by the initial cheesemilk composition, manufacturing procedures, and maturation conditions (Lucey, 2003).

The biggest change in texture properties occur in the first two days, but the solidification takes place and continues only for a few weeks to balance. The surface layers of the cheese faster loses moisture and change the chemical composition, which may be reflected in the rheological properties and other during maturation (Nuath et al., 2000).

The rheological properties of cheese are those that determine its response to a stress or strain (e.g., compression, shearing, or cutting) that is applied during processing (e.g., portioning, slicing) and consumption (slicing, chewing). These properties include intrinsic characteristics such as elasticity, viscosity, and viscoelasticity that are related primarily to the composition, structure, and strength of the attractions between the structural elements of the cheese (Fox, 2000).

Physical attributes such as unmelted and melted states of matter were observed in low-moisture part-skim pizza Mozzarella which is the variety of pasta filata cheese used extensively as a topping on baked dishes in North America (Lucey, 2008).

Several articles focusing on texture, rheological and physical properties of pasta filata cheeses depending on method of cheese production or different storage conditions have been published. Hwang et al. (2015) investigated effect of drying and storage on the rheological characteristics of Mozzarella cheese.

Impact of the thermo-mechanical treatments and hot brining on composition, yield, solid loss, microstructure and hardness of pasta filata cheese were proved (Bähler, 2016; Banville, 2016).

The aim of this paper was a comparison the colour changes and texture properties of semi-hard pasta filata cheeses during ripening.

MATERIAL AND METHODOLOGY

Making of cheese samples

This research was carried out in Biotechnology Pavilion M, financed by the OP VaVpI CZ.1.05/4.1.00/04.0135 project at the Department of Food Technology at Mendel University.

Milk for manufacturing came from Holstein dairy cows originally from South Moravia region. The elementary analysis of basic components of milk was conducted in Table 1.

Milk for making of cheese samples was subjected to heat treatment. Raw milk was heated at 72 °C for 30 s and then was immediately cooled to 33 °C. Acidification was performed by adding cheese culture TM1 (Bulgaricus, Czech Republic) and MC1 (Bulgaricus, Czech Republic). Milk was held at 32 °C during 40 min and 10 mL 36% CaCl was added.

Coagulation (renneting) was induced by the commercial chymosin rennet Naturen 145 IMCU (CH.HANSEN, Denmark). For 70 L vat was needed 40 mL of chymosin rennet. Forty minutes later followed cutting of curd into small cubes (15 mm x 15 mm). After next 15 min 18 L of whey was removed from the vat and replaced by 15 L of warm water (40 °C).

Mixture was heated and agitated at 40 °C for 30 min and after that moulding and formation of curd were done. The curd was filled into forms and whey was separated. Formating and pressing lasted 45 min, then the curd was turned and pressed next 20 min.

Cheese samples were fermented for 20 hours. After this time of fermentation, Pasta Filata treatment was applied. Samples were placed into vat full of warm water (85 °C) for 2 min for a pasta filata surface. Next step was salting in salt brine (18% NaCl) for 20 hours at 10 °C.

Drying and resting lasted in a chamber (12 °C) for 2



Figure 1 Cheese samples.

Table 1 Composition of milk for cheesemaking.

Parameter	Value	Method (Standard)
Dry matter	12.69%	gravimetry (ISO 6731:2010)
Fat	3.60%	Gerber (ISO 2446:2008)
Protein	3.19%	Kjeldahl (EN ISO 8968-1:2002)
Lactose	4.92%	Polarimetry (ČSN 570530)
Tit. acidity	6.50SH	Soxhlet-Henkel (ČSN 570530)

days. Cheese samples were treated by oil (rape seed oil, Czech Republic). Maturation of treated cheeses took place in ripening chamber at 12 ±1 °C, relative humidity 85% for 85 days. A total of 40 cheese samples were produced due to study chemical parameters, colour and texture during ripening. Cheese samples were analyzed after each 10, 20, 30, 40, 60 and 85 days.

Cheese samples (loaves) had cylindrical shape, average height 33.7 mm and average width 71.8 mm. Cheese loaves weight varied between 112 g to 140 g. Cheese samples are shown in Figure 1.

Colour measurement

Spectrophotometer Konica Minolta CM-3500d (Japan) were used for colour measurements. The instrument processed measured data using the SpectraMagic software version NX. Color standardization was performed using white and black standard cylinder. Color measurement was made in accordance with Commission Internationale de l’Eclairage (CIE, 1978). Standart daylight (light source D65) was used as the reference illuminant. For all samples were determined three color parameters, L* (lightness), a* (green-red value), and b* (blue-yellow value). Color parameters of samples were measured on the basis of reflected light retrospectively captured by detector of spectrophotometer (reflectance SCE mode). The size of the aperture of the optical system was adjusted to 8 mm.

Sample preparation was carried out as follows: cheese loaves were cut in half and colour measurements always took place on the inner surfaces of each half of cheese loaves. Color parameters were determined for the edge part and for the middle part of samples and measurements were made in triplicate. There were observed L* a* b* parameters depending on the length of maturation.

The differences between the samples were evaluated either in individual parameters (L* a* b*), or by using the total colour difference (ΔE*_{ab}) that is dedicated from the already measured parameters and calculated using following formula (1):

$$(1) \quad \Delta E^*_{ab} = [(\Delta L^*)^2 + (\Delta a^*)^2 + (\Delta b^*)^2]^{1/2}$$

Zmeškal et al. (2002) said, that resulting difference in colours are from undetectable to very pronounced or interfering. This change is an accepted method of evaluating colour difference. Final values of ΔE*_{ab} were compared with a range by Zmeškal (Table 2).

Texture properties of cheese

The texture properties of cheese were measured by TIRATEST 27025 (TIRA Maschinenbau GmbH, Germany) – universal testing machine measuring of various materials for tensile, pressure and bending resistance. The samples were cut in half for texture measurements the inner consistence of maturing cheese.

Measurements were made in triplicate for part following the edge of cheese (0.5 cm from the external surface) and for middle part of samples as well. The method with a 200 N compression load cell with a crosshead speed of 100 mm.min⁻¹ was used. The texture properties were determined through the penetration with cylindrical probe with diameter 3 mm to the depth 16 mm.

Similar trend as values measured in the edge part of cheese samples is detectable in the middle part of oiled cheese. Parameter L* (lightness) decreased during period from 0 to 60 day of ripening. The darkest middle part of cheese samples was detected in 60 days of ripening (L* 80.29). In compare with values measured in the edge part, higher values were measured for parameter b* (yellow axis). Yellow tone values were in range between from 16.26 (0 day) up to 20.32 (60 day).

Statistical analysis

For determining statistically significant difference in ripening on individual parameters was used program STATISTICA 12.

RESULTS AND DISCUSSION

During ripening of cheese samples there were observed

Table 2 Colour difference based on the total difference (Zmeškal et al. 2002).

ΔE* _{ab}	Colour difference
0.0 – 0.2	imperceptible
0.2 – 0.5	very light
0.5 – 1.5	light
1.5 – 3.0	clearly perceptible
3.0 – 6.0	middle
6.0 – 12.0	significant
12.0 – 16.0	very significant
more then 16.0	interference

Table 3 Colour characteristic of the edge part of oiled cheeses during ripening.

Days of ripening		0	10	20	30	40	60	85
L* (D65)	M	89.56 ^d	86.69 ^a	85.89 ^a	84.04 ^c	82.80 ^b	82.30 ^b	85.71 ^a
	SD	0.26	0.47	0.82	0.59	0.58	0.13	0.83
a* (D65)	M	0.52 ^b	0.49 ^b	0.14 ^a	0.12 ^a	0.04 ^a	0.19 ^{ac}	0.51 ^b
	SD	0.12	0.14	0.05	0.05	0.12	0.06	0.13
b* (D65)	M	15.83 ^c	17.36 ^b	18.53 ^a	18.54 ^a	17.39 ^b	18.78 ^a	18.62 ^a
	SD	0.42	0.59	0.48	0.22	0.08	0.64	0.15
ΔE* _{ab}		---	4.29	3.18	1.58	2.08	1.06	2.93

a, b, c, d – different superscripts in a line indicate a statistically significant difference at p <0.05.

statistically demonstrative changes in the colour parameters of the edge part of oiled cheese. **Dufossé et al. (2005)** said that color is the clue for many qualities of food such as flavour, naturalness or maturity, and influences consumer choices. Values of the L* parameter (lightness) declined from the start (0 day) till 60 days of ripening. In that context, the edge part of cheese turned dark during ripening. The darkest edge parts were apparent just 60 days of ripening. Lightness of sample in 80 days of ripening (L* 85.71) was statistically the most similar to the lightness between 10 – 20 days of ripening. Parameter a* (green-red axis) showed almost same trend as L* parameter. Values declined till 40 days of ripening. Red colour tone was the most obvious in the beginning (0 – 10 days of ripening) and at the end of experiment. Parameter b* represents blue-yellow axis. Yellow tone was least obvious at the start of experiment (0 day). Values of b* parameter rose till 30 days of ripening. There were no statistically significant differences between yellow tone of samples in 20, 30 days and 60, 85 days of ripening.

According to the criteria **Zmeškal et al. (2002)** is a total colour difference (ΔE^*_{ab}) during storage most noticeable in first 10 days of ripening. Changing in the parameters of edge part of oiled cheese during storage is given in Table 3.

Therefore, yellow tone was most saturated between 40 and 60 days of ripening. At the end of ripening (85 day), parameter b*, there was no statistically significant difference from values of parameter b* in 10, 20 and 30 days of ripening. In compare with changes in a* parameter of the edge part of cheese samples, red tone (a* parameter) in the middle part of cheese samples did not show so large change. Variability in the parameters of middle part of oiled cheese during storage is shown in Table 4.

From the values of parameter L* and b* it is evident that changes were more obvious for the middle part of oiled cheese. The middle parts showed less lightness and yellow tone (b*) was more saturated. Pasta filata cheeses were

judged quite evenly colored and free of marbling or other deficiencies in color after 180 days of ripening according to **Santillo et al. (2012)**.

There are other techniques for treating the surface of cheeses. According to **Cetinkaya et al. (2005)**, maturation of pasta filata cheese in bee wax for 7 days and over (10 days) had significant positive effects on the organoleptic properties of pasta filata cheese and these were distinguishable by the panelists.

Cheese samples in each stage of maturation were subjected to texture test. Texture of semihard pasta filata cheeses depend on several factors (coagulant, lactic acid microflora and time of ripening) in accordance with **Santillo et al. (2012)**.

Strenght needed to go over the internal matter was recorded. Measuring points were located in the edge and middle part of cheese sample cutted in half. Strenght was measured three times for each location. Variability in firmness for both, edge and middle part, is shown in Table 5.

The measured strenght of edge part of the cheese samples was in range between from 7.44 N up to 23.49 N. Therefore, firmness during maturing process increased three times. Cheese samples had soft consistency immediately after manufacturing and the lowest firmness was measured for middle part of cheese samples (4.46 N). The biggest change in firmness was occurred during first 10 days of ripening when sample became more than twice more rigid.

In first 30 days of maturation, the edge part of samples became more rigid. After 30 days of maturation, sample became softer for next 10 days. Firmness between 40 and 60 days showed almost the same values. There was no statistically significant difference between firmness in 30 days and 85 days of maturation.

Almost same trend were monitored in middle part of cheese sample. Firmness of middle part varied from 4.46 N to 24.40 N in 60 days of maturing.

Table 4 Colour characteristic of the middle part of oiled cheeses during ripening.

Days of ripening		0	10	20	30	40	60	85
L* (D65)	M	87.93 ^c	85.14 ^c	84.09 ^{bc}	81.45 ^a	81.87 ^a	80.29 ^d	81.58 ^a
	SD	0.05	0.45	0.43	0.74	0.44	1.03	0.92
a* (D65)	M	0.61 ^{ab}	0.65 ^b	0.54 ^{ab}	0.54 ^{ab}	0.47 ^{ac}	0.36 ^c	0.54 ^{ab}
	SD	0.01	0.07	0.17	0.05	0.02	0.07	0.08
b* (D65)	M	16.26 ^c	18.44 ^{ab}	18.71 ^{ab}	19.28 ^{ac}	20.05 ^{cd}	20.32 ^d	19.02 ^a
	SD	0.02	0.40	0.90	0.30	0.33	0.68	0.38
ΔE^*_{ab}		---	2.44	1.56	1.49	1.32	2.85	1.42

Table 5 Firmness of edge and middle part of cheese samples.

Days of ripening	Edge part	Middle part
	Firmness (N)	Firmness (N)
0	7.44 ± 0.34 ^c	4.46 ± 0.38 ^d
10	18.59 ± 0.94 ^d	18.97 ± 0.88 ^b
20	21.68 ± 0.39 ^a	18.71 ± 0.94 ^b
30	23.49 ± 0.26 ^b	22.91 ± 0.47 ^{ac}
40	20.27 ± 1.10 ^a	21.93 ± 1.05 ^a
60	21.53 ± 0.32 ^a	24.40 ± 1.09 ^c
85	23.34 ± 0.10 ^b	22.56 ± 0.59 ^a

^{a, b, c, d} – different superscripts in a column indicate a statistically significant difference at $p < 0.05$.

In first 10 days of ripening, the difference in firmness was more noticeable than in edge part in accordance with Nuath et al. (2000). There was no statistically significant difference between firmness in 85, 30 and 40 days of maturation. Strength measured between 10 and 20 days of maturation was similar.

According to Bertola et al. (2000) cheese can be ripened packaged in plastic films of low gaseous permeability and the cheese had similar texture characteristics to that given by traditional ripening conditions (unpacked conditions). As well as rheological parameters, water content, pH and nonprotein nitrogen were temperature dependent. The ripening process in plastic films was accelerated by a temperature increase from 10 to 20 °C.

CONCLUSION

This paper was focused on the changes in colour and texture of semi-hard pasta filata cheese, treated by oil, during 85 day of ripening. Lightness of samples (L^*) declined and yellow tone (parameter b^*) was more pronounced during maturation. Firmness of samples correspond with L^* and b^* parameters in first 30 days of maturation. Content of water in cheese loaves was getting lower by evaporating from the surface, therefore cheese has become more rigid especially in first 10 days of ripening when the evaporating was the most pronounced.

REFERENCES

- Banville, V., Chabot, D., Power, N., Pouliot, Y., Britten, M. 2016. Impact of thermo-mechanical treatments on composition, solid loss, microstructure, and rheological properties of pasta filata-type cheese. *International Dairy Journal*, vol. 61, p. 155-165. <http://dx.doi.org/10.1016/j.idairyj.2016.05.004>
- Bähler, B., Kunz, A., Hinrichs J. 2016. Hot brining of pasta filata cheese: effect of sodium and calcium chloride on composition, yield, and hardness. *Dairy Science & Technology*, vol. 96, no. 5, p. 703-714. <http://dx.doi.org/10.1007/s13594-016-0299-9>
- Bertola, N. C., Califano, A. N., Bevilacqua, A. E., Zaritzky, N. E. 2000. Effects of ripening conditions on the texture of Gouda cheese. *International Journal of Food Science and Technology*, vol. 35, no. 2, p. 207-214. <http://dx.doi.org/10.1046/j.1365-2621.2000.00347.x>
- Cetinkaya, A., Yaman, H., Elmali, M., Karadagoglu, G. 2005. A Preliminary Study of Kashar Cheese and Its Organoleptic Qualities Matured in Bee Wax. *Internet Journal of Food Safety*, vol. 6, p. 1-4.
- CIE (Commission Internationale de l'Eclairage):1978. *Recommendations on Uniform Color Spaces, Color Difference Equation, Psychometric Color Terms. Supplement No.2 to CIE Publication No. 15. Colorimetry*, Bureau Central de la CIE, Paris, France.
- Dufossé, L., Galaup, P., Carlet, E., Flamin, C., Valla, A. 2005. Spectrocolorimetry in the CIE $L^*a^*b^*$ color space as useful tool for monitoring the ripening process and the quality of PDO red-smear soft cheeses. *Food Research International* vol. 38, no. 8-9, p. 919-924. <https://doi.org/10.1016/j.foodres.2005.02.013>
- Fox, P. F., McSweeney, P. L. H., Cogan, T. M., Guinee, T. P. 2004. *Cheese: Chemistry, Physics and Microbiology*. 3rd ed. San Diego, USA : Elsevier Academic Press, 456 p. ISBN-10: 0-12-263652-x.
- Fox, P. F., Guinee, T. P., Cogan, T. M., McSweeney, P. L. H. 2000. *Fundamentals of cheese Science*. 1st ed. USA : Aspen Publisher, Inc., 638 p. ISBN-10: 0-8342-1260-9.
- Kavas, G., Kavas, N., Saygili, D. 2015. The effects of thyme and clove essential oil fortified edible films on the physical, chemical and microbiological characteristics of Kashar cheese. *Journal of Food Quality*, vol. 38, no. 6, p. 405-412. <https://dx.doi.org/10.1111/jfq.12157>
- Keresteš, J. et al. 2016. *Mlieko vo výžive ľudí (Milk in human nutrition)*. 1st ed. Bratislava, Slovak Republic : CAD press, 649 p. ISBN-13: 978-80-88969-72-3.
- Lovayová, V., Dudriková, E., Nemcová R., Rimárová K. 2010. Influence of the ripening onto the growth of selected probiotic cultures in low-cooked cheese. *Potravinárstvo*, vol. 4, no. 3, p. 40-45. <https://dx.doi.org/10.5219/29>
- Lucey, J. A., Johnson, M. E., Horne, D. S. 2003. Perspectives on the basis of the rheology and texture properties of cheese. *Journal of Dairy Science*, vol. 89, no. 9, p. 2725-2743. [http://dx.doi.org/10.3168/jds.S0022-0302\(03\)73869-7](http://dx.doi.org/10.3168/jds.S0022-0302(03)73869-7)
- Lucey, J. A. 2008. Some perspectives on the use of cheese as a food ingredient. *Dairy Science & Technology*, vol. 88, no. 4, p. 573-594. <http://dx.doi.org/10.1051/dst:2008010>
- Nuath, K., Hines, J. T., Harris, R. D. 2000. Cheese Rheology In F. J. Francis *Wiley Encyclopedia of Food Science and Technology*. Hoboken, USA : John Wiley & Sons, 2816 p. ISBN-13: 978-0-471-19285-5.
- Piraino, P., Zotta, T., Ricciardi, A., Parente, E. 2005. Discrimination of commercial Caciocavallo cheeses on the basis of the diversity of lactic microflora and primary proteolysis. *International Dairy Journal*, vol. 15, no. 11, p. 1138-1149. <http://dx.doi.org/10.1016/j.idairyj.2004.12.006>
- Spreer, E. 1998. *Milk and dairy product technology*. 1st ed., New York, USA : Marcel Dekker, Inc., 483 p. ISBN-10: 0-8247-0094-5.
- Santillo, A., Caroprese, M., Ruggieri, D., Marino, R., Sevi, A., Albenzio, M. 2012. Consumer acceptance and sensory evaluation of Monti Dauni Meridionali Caciocavallo cheese. *Journal of Dairy Science*, vol. 95, no. 8, p. 4203-4208. <http://dx.doi.org/10.3168/jds.2011-4777>
- Trmčič, A., Ralyea, R., Meunier-Goddik, L., Donnelly, C., Glass, K., D. Amico, D., Meredith, E., Kehler, M., Tranchina, N., McCue, C., Wiedmann, M. 2017. Consensus categorization of cheese based on water activity and pH-A rational approach to systemizing cheese diversity. *Journal of Dairy Science*, vol. 100, no. 1, p. 841-847. <http://dx.doi.org/10.3168/jds.2016-11621>
- Zmeškal, O., Čeppan, M., Džík, P. 2002. Color spaces and color management [online] s.a [cit. 2017-02-01] Available at: http://www.fch.vut.cz/lectures/imagesci/download/stud06_roz_n02.pdf.

Acknowledgments:

This work was supported by TP 2/2017 “Effect of additives on the rheological behaviour of foodstuffs and product and raw materials for their production” financed by IGA AF MENDELU.

Contact address:

doc. Ing. Šárka Nedomová, Ph.D., Mendel University in Brno, Faculty of AgriSciences, Department of Food Technology, Zemědělská 1, 613 00 Brno, Czech Republic, E-mail: snedomov@mendelu.cz

Ing. Libor Kilián, Mendel University in Brno, Faculty of AgriSciences, Department of Food Technology, Zemědělská 1, 613 00 Brno, Czech Republic, E-mail:

xkilian@mendelu.cz Ing. Roman Pytel, Mendel University in Brno, Faculty of AgriSciences, Department of Food Technology, Zemědělská 1, 613 00 Brno, Czech Republic, E-mail: roman.pytel@mendelu.cz

Ing. Vojtěch Kumbár, Ph.D., Mendel University in Brno, Faculty of AgriSciences, Department of Technology and Automobile Transport, Zemědělská 1, 613 00 Brno, Czech Republic, E-mail: vojtech.kumbar@mendelu.cz

BIOGENIC AMINES DEGRADATION BY MICROORGANISMS ISOLATED FROM CHEESE

Irena Butor, Hana Pištěková, Khatantuul Purevdorj, Petra Jančová, František Buňka, Leona Buňková

ABSTRACT

The aim of this study was the isolation and characterization of microorganisms able to degrade biogenic amines and their identification. Individual microorganisms were obtained by isolation from commercially available foodstuffs and food produced in the technological laboratories of Faculty of Technology, Tomas Bata University in Zlín and subsequently identified by MALDI-TOF MS. The results of MALDI-TOF MS identification were verified by 16S rRNA sequencing. In this work was studied the ability of 5 bacterial strains positive to biogenic amines degradation isolated from dairy products to decrease biogenic amines content in vitro and quantified reduction in the concentration of biogenic amines tryptamine, β -phenylethylamine, putrescine, cadaverine, histamine and tyramine. The level of degradation (decrease of biogenic amines) was determined on the base of the ability to grow in media with biogenic amines as the sole source carbon and nitrogen. The isolated strains with the ability of degradation of one or more biogenic amines were cultured in medium supplemented with relevant biogenic amines, the media derivatized with dansyl chloride and these amines separated by HPLC at a wavelength of 254 nm. From five tested strains identified as *Bacillus subtilis*, *Bacillus pumilus*, *Enterobacter cloacae*, *Rhizobium radiobacter* and *Acinetobacter pitii*, isolated from gouda type cheese, the greatest ability of degradation was observed in *Bacillus subtilis*, which was capable to degrade almost all amount of histamine, cadaverine and putrescine. Other four strains showed a lower rate of degradation than *Bacillus subtilis*, but the ability to degrade biogenic amines with these microorganisms was still significant.

Keywords: biogenic amines; *Bacillus*; degradation; cheese

INTRODUCTION

Biogenic amines (BA) are volatile basic nitrogen compounds of low molecular weight that are characterized by biological activity. They occur naturally in living organisms as metabolic intermediates and products of proteins and amino acids. These compounds are synthesized and degraded during normal metabolism of animals, plants and microorganisms. Biogenic amines are formed mainly by decarboxylation of amino acids or by amination and transamination of aldehydes and ketones (Askar and Treptow, 1986; Maijala et al., 1993). These compounds can be divided according to their chemical structure of aromatic (β -phenylethylamine and tyramine), aliphatic (putrescine, cadaverine, spermidine and spermine) and heterocyclic (histamine and tryptamine). According to the number of amino groups in the molecule can be biogenic amines classified as monoamines - histamine, tyramine and tryptamine; diamines - putrescine and cadaverine, and polyamines - spermine, spermidine and agmatine (Bardócz et al., 1993). They play an important role in many human physiological functions,

such as cerebral activity, gastric acid production, and immune responses (Shalaby, 1996) or cell growth and differentiation (Ladero et al., 2010). During microbiological activity BA may accumulate in food in higher concentrations. Excessive oral intake of BAs can cause health problems such as nausea, headache, rash, and changes in blood pressure (Ladero et al., 2010; Lovenberg, 1973). Possible health complications relate primarily susceptible individuals whose detoxification systems work insufficiently from genetic causes or as a result of pharmacological treatment (Bodmer et al., 1999), e.g., as antidepressants such as monooxidase inhibitors (MAOIs) (Hernandez-Jover et al., 1997; Yongmei, et al., 2009). Due to the potential adverse effects of BAs on human health, it is necessary to prevent their accumulation in food (EFSA, 2011). For foods or their parts that have passed through fermentation process, or were exposed to microbial contamination during production or storage can be expected a higher probability of BA occurrence (Mariné-Font et al., 1995). Foods that often contain elevated levels of BA are fish, fish products and

derivatives and fermented products (ten Brink et al., 1990; Halász et al., 1994). Cheeses usually contain significant amounts of biogenic amines and in some cases have been reported high levels of BA (Joosten and Stadhouders, 1987; Buňková et al., 2013). Cheese is the one of most common fermented food associated with the BA poisoning (Joosten, 1988, Tawfik et al., 1992). The term „cheese reaction“ is used for tyramine intoxication. Small amounts of BA were detected in milk powder (Voigt et al., 1974), yoghurts and in large quantities in many varieties of cheese (Stratton et al., 1991; Buňková et al., 2013). The most important biogenic amines occurring in cheese are histamine, tyramine, tryptamine, putrescine, cadaverine and β -phenylethylamine (Tawfik et al., 1992). During the cheese ripening casein is slowly degraded by proteolytic enzymes, it is leading to increased free amino acids content (Foster et al., 1958; Joosten and Olieman, 1986). These amino acids can then be used for further reactions catalysed by specific bacterial decarboxylases and lead to the formation of CO₂ and amines. Therefore, the content of biogenic amines (particularly histamine, putrescine and cadaverine) gradually increases, and varies with increasing cheese ripening time (Degheidi et al., 1992). Concentration of tyramine and histamine higher than 1 g/1 kg was recorded in cheese. It was demonstrated that tyramine and histamine are also the most frequent BA in foodstuffs. Their concentrations in cheese were recorded as the highest (Stratton et al., 1991; Fernandez et al., 2007). Due to adverse effects on health, BA accumulation in foods should be prevented (EFSA, 2011). Content of biogenic amines in foods fluctuates and also the composition of microflora is changing. One of the most important role play the actual quality and conditions of raw materials, for fermented products, then added a suitable choice of starter cultures. Other, no less important factors affected the BA formation or reduction is e.g. pH, NaCl concentration, the temperature or metabolic and biochemical activity of present microflora (Gücüköglü and Küplülü, 2010; Buňková et al., 2009). To reduce BAs accumulation in food many various strategies were suggested, such as inhibition of bacteria that can produce BAs, reducing the number of BAs producers using pasteurization of milk for cheese production, reducing proteolytic activity (therefore reduce the availability of amino acid precursors of biogenic amines). Another way to reduce the amount of BAs in food is their direct removal from foodstuff. The only known method to remove the BAs that were already created in foods is their removal by means of enzymes or microorganisms which are able to degrade BA. Possibility of BA removal from food in this way is based on the fact

that aminooxidases, which are responsible for the BA detoxification, received in the diet have been found in some microorganisms (Alvarez and Moreno-Arribas, 2014). The use of such strains seem appropriate strategy to reduce the value of BA in foods where it is very difficult to avoid: accumulation BAs due to the presence of BA-producing bacteria, including lactic acid bacteria (LAB), which are often part of the normal microflora of the food, thereby BA are present in the final stages of the manufacturing process (Fadda et al., 2001). It is known that some representatives of the genera *Brevibacterium*, *Bacillus*, *Lactobacillus*, *Pediococcus*, or *Micrococcus* are capable to degrade the BA (Herrero-Fresno et al., 2012, Postollec et al., 2011). It is important to note known that microbial decarboxylase activity is very variable, while in most cases, species specific. The detection of these bacteria is thus important to estimate the content of BA in foods and the associated risks and the effort to prevent their accumulation in fermented foods (Martinez et al., 2011; Postollec et al., 2011).

MATERIAL AND METHODOLOGY

Isolation of microorganisms

Microorganisms were isolated from commercially available food. Food-samples were sterilely removed and 10 x diluted with saline and resuspended in Stomacher. Ten microliters of bacterial suspension was inoculated into tubes with 5000 μ l of mineral medium MM1 according Vítková (2016) with biogenic amines (tryptamine, phenylethylamine, putrescine, cadaverine, histamine and tyramine). These samples were cultivated for one week at 30 °C. Partial results were read every 24 hours. The basic ability of degradation was identified on the basis of ability to grow in mineral medium supplemented with BAs, but the inability to grow in mineral medium without the addition of BAs (control). Of the 408 food samples, 5 different strains able to degrade biogenic amines were isolated. All of them were obtained from gouda type cheese. These 5 species of microorganisms were transferred from tubes to plates with medium Nutrient agar (HiMedia; India) and cultured for 48 hours at 30 °C.

MALDI-TOF MS analysis

Samples for analysis were prepared by isolating a pure culture that has been grown for 24 hours at 30 °C, then was resuspended and transferred to 150 μ L of sterile distilled water in a microtube. 450 μ L of 96% ethanol was added. Samples were frozen at -70 °C and identified by MALDI-TOF MS system according to Gregova et al. (2012).

Table 1 The HPLC gradient elution program.

Time (min)	10% acetonitrile (%)	10% acetonitrile (%)
0.1	41	59
1.9	37	63
3.5	18	82
4.0	0	100
9.5	0	100
11.5	41	59
15.5	41	59

Table 2 PCR conditions.

Step	Temperature (°C)	Time	Number of cycles
Denaturation	94	10 min	1
Amplification	94	30 s	35
	57	30 s	
	72	60 s	
Final extension	70	10 min	1

Note: *Sequencing was carried out in SEQme s.r.o. (SEQme, Dlouhá 176, Dobříš, Czech Republic). Sequencing results were processed and evaluated by BLAST algorithm (Simon et al., 2006).

HPLC analysis

Concentration of given biogenic amines in individual experiments was determined by HPLC. Broth after culturing of the tested isolates was centrifuged at 4600 rpm for 10 minutes and the supernatant was diluted 1:1 (v/v) with perchloric acid ($c = 1.2 \text{ mol.L}^{-1}$). The acidified mixture was subjected to derivatisation according to Dadáková et al. (2009). 1,7-heptanediamine was used as an internal standard. Derivatised samples were filtered through a syringe filter with a porosity of 0.22 μm , and applied to a column (Agilent Eclipse Plus C18 RRHD, 50 x 3.0 mm, particle size 1.8 mm) chromatography system (Column Thermostat Agilent 1260 Infinity; autosampler LabAlliance, USA; binary pump LabAlliance, USA; UV/VIS DAD detector Agilent Technologies). Separation of dansylderivate of biogenic amines was proceeded with a gradient elution and detection was carried out by UV spectrophotometry ($\lambda = 254 \text{ nm}$). Conditions for derivatisation, separation and detection of monitored biogenic amines according to Smělá et al. (2004) and Dadáková et al. (2009) are summarized in Table 1.

Measurement of the optical density of the cells

Measuring of optical density of the cells was detected the growth of bacterial cells in an appropriate cultivation medium MM1 for a defined time interval. Measurements

were carried out using a spectrophotometer TECAN. Culture was in microtitre plates monitored at 600 nm against negative control (pure medium without bacterial biomass).

Statistical analysis

The non-parametrical analyses of variance from the Kruskal-Wallis and Wilcoxon tests (Unistat® 6.5 software; Unistat, London, UK) were used in order to evaluate the obtained results (the significance level was 0.05).

PCR and strain identification by sequencing

Polymerase chain reaction (PCR) and 16S rRNA sequencing was used to verify identification of bacterial strains. DNA isolation was performed according to study of Simmon et al., 2006 and Christensen and Bisgaard, 2010. For amplification forward primer 341F (5'-CCTA CGGGAGGCAGCAG-3') and reverse primer 907R (5'-CCGTCAATT CCTTTGAGTTT-3') were used (Zhao, et al., 2008). PCR was performed using commercial kit G2 Hot Start Green Master Mix (ROCHE, Germany). The reaction volume included 10 μL of commercial master mix, 800 nmol.L⁻¹ of forward primer, 800 nmol.L⁻¹ of reverse primer and 1 μL of DNA. Negative control was performed – the same volumes of primers and master mix,

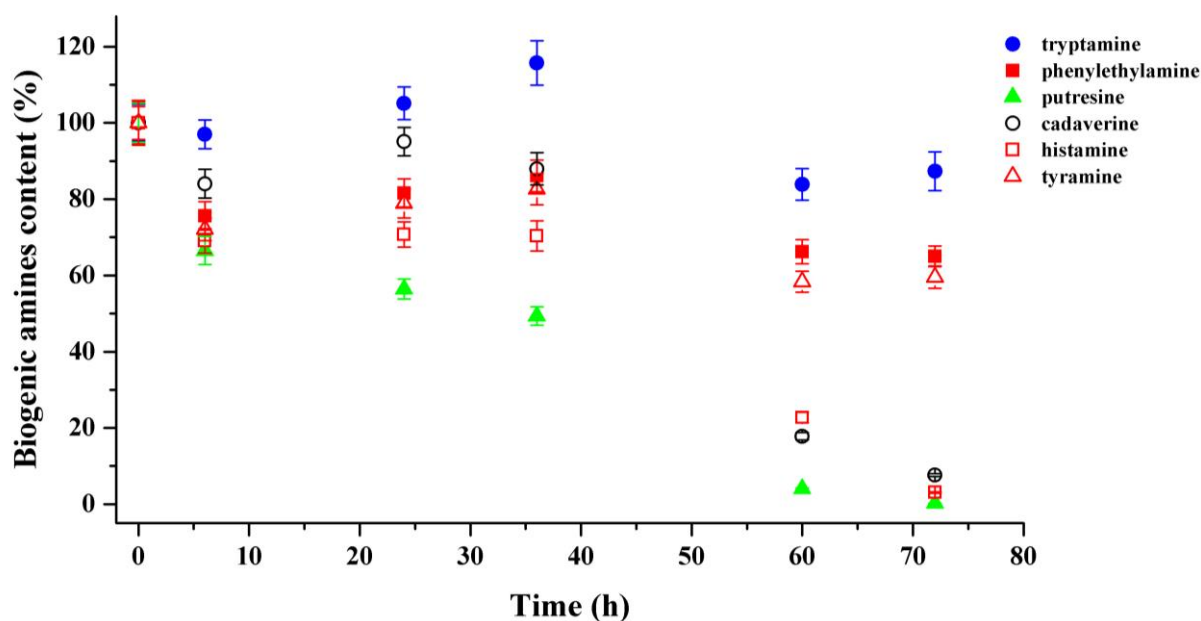

Figure 1 Changes in BAs concentration during the 72 hour cultivation of *Bacillus subtilis* 1a (the values were expressed as mean with standard deviation depicted as the bars).

Table 3 Changes in concentration of biogenic amines due to *Bacillus subtilis* 1a after 6 and 72 hours of cultivation.

BA*	after 6 hours of cultivation **	after 72 hours of cultivation ***
tryptamine	97.00	87.32 ††
phenylethylamine	75.63 †	65.03 ††
putrescine	66.52 †	0.23 ††
cadaverine	84.06 †	7.60 ††
histamine	69.05 †	3.05 ††
tyramine	72.11 †	59.55 ††

Note:

* percent concentration of biogenic amines in the sample after cultivation (in comparison with the start concentration).

** the means followed by “†” in superscript differ from the start concentration ($p < 0.05$).

*** the means followed by “††” in superscript differ from the concentration measured after 6 hours of cultivation ($p < 0.05$).

without a DNA as template. PCR conditions are shown in Table 2.

RESULTS

From 408 food samples were isolated 5 strains able to degrade biogenic amines. They were identified as *Bacillus subtilis* 1a, *Bacillus pumilus* 13b, *Enterobacter cloacae* 16b, *Rhizobium radiobacter* 16a and *Acinetobacter pitii* 5a.

During the cultivation of all tested degraders amounts of all monitored biogenic amines in broth slightly declined after a 6-hour cultivation (Table 3, Figure 1). After a 24-hour cultivation concentration of 6 biogenic amines moderately increased ($p \geq 0.05$) while the concentration of putrescine was still declining ($p < 0.05$). In the time of 36 hours started sharply to fall concentration of all biogenic amines. Within the times between 60 and 72 hours there was again a slight increase in concentration. *Bacillus subtilis* 1a showed the best ability to reduce biogenic amines in the medium. The greatest reduction of the BAs concentration was observed with putrescine, cadaverine and histamine ($p < 0.05$) (Figure 1). Total volumes of putrescine and histamine after the 72-hour cultivation were nearly zero ($p < 0.05$). As can be seen in Figure 1, the graph demonstrates that the amounts of BAs started sharply to increase after the 6-hour cultivation. *B. subtilis* 1a had ideal conditions for growth in that particular time. Thus, it grew and consumed free substrate from the medium and as a result it produced BA's as secondary metabolites. This metabolic pathway is probably more energetically preferable for this microorganism, therefore it consumed of free substrate instead of using BAs. The results of the tests for biogenic amines degradation by *B. subtilis* 1a are summarized in Table 3. As it shown in

Figure 1, concentration of BAs in samples gradually declined. After a depletion of free nutrients from substrate is organism forced to use carbon and nitrogen bound in BAs. This phenomenon was described in other studies (Latorre-Moratalla, et al., 2010; Alvarez and Moreno-Arribas, 2014; Zaman, et al., 2011). Significant decrease in the concentration of biogenic amines in the sample was observed for other four isolates ($p < 0.05$) – *Enterobacter cloacae* 16b, *Bacillus pumilus* 13b, *Rhizobium radiobacter* 16a and *Acinetobacter pitii* 5a.

None of these four strains showed such a high degradation potential as *Bacillus subtilis* 1a. By *Enterobacter cloacae* 16b was degraded 15.5% of tryptamine, 25.8% of putrescine, 45% of phenylethylamine, 24.1% of cadaverine, 19.5% of histamine and 38.5% of tyramine. Ability of *Bacillus pumilus* 13b to degrade biogenic amines was lower compared with *Enterobacter cloacae* 16b but still significant ($p < 0.05$). The levels of biogenic amines have been reduced by about one quarter. *B. pumilus* is most applied in the reduction of cadaverine, wherein the concentration of this BA was decreased by 29% ($p < 0.05$). *Rhizobium radiobacter* 16a showed almost an equal ability to degrade each of the six investigated biogenic amines such as *B. pumilus* 13b ($p < 0.05$).

Significant differences in the reduction of the concentration were observed only with phenylethylamine, when its amount after 72-hour cultivation lowered to a half ($p < 0.05$). *Acinetobacter pitii* 5a was able to reduce the quantity of biogenic amines also about one quarter. An exception was histamine whose concentrations were decreased only by 3% ($p \geq 0.05$). Comparison of biogenic amines degradation efficiency can be seen in Table 4.

Table 4 Comparison of changes in concentrations by individual species after 72 hours of cultivation.

BA*	<i>Bacillus subtilis</i> 1a **	<i>Bacillus pumilus</i> 13b	<i>Enterobacter cloacae</i> 16b	<i>Rhizobium radiobacter</i> 16a	<i>Acinetobacter pitii</i> 5a
tryptamine	12.68 †c	8.55 †b	15.46 †c	9.65 †b	3.25 †a
phenylethylamine	34.97 †b	27.7 †a	43.96 †c	43.31 †c	23.77 †a
putrescine	99.77 c	27.57 †b	25.80 †b	25.14 †b	21.85 †a
cadaverine	92.40 b	28.68 †a	24.05 †a	28.30 †a	25.04 †a
histamine	96.95 c	20.55 †b	19.57 †a,b	20.43 †b	16.36 †a
tyramine	40.45 †c	36.23 †a	38.49 †a,b	39.75 †a,b	37.42 †a

* percentage reduction in the concentration of biogenic amines (in comparison with the start concentration).

** the means followed by “†” in superscript differ from the start concentration ($p < 0.05$); the means within a line (the difference between the species) followed by superscript letters differ ($p < 0.05$).

DISCUSSION

In this study the biogenic amines degradation ability of microorganisms isolated from ripened cheese was studied. The results obtained from 5 samples isolated from commercially available cheese show that in these 5 selected isolates studied the ability to degrade biogenic amines in time in *in vitro* conditions. *Bacillus subtilis* 1a showed the highest degradation activity of biogenic amines compared to other tested degraders. It was observed 100% degradation of putrescine, 97% degradation of histamine, and 92% degradation of cadaverine, other biogenic amines were degraded to 50%. Other 4 degraders showed less degradation activity. All isolates have reduced amounts of biogenic amines in broth by less than 50%. *Acinetobacter pitii* 5a and *Bacillus pumilus* 13b have the highest degradation activity for tyramine, *Rhizobium radiobacter* 16a and *Enterobacter cloacae* 16b most degraded phenylethylamine. Lee et al. (2015) observed also in *Bacillus subtilis* degradation of histamine in the broth of 74% within 24 hours, 100% degradation of histamine showed different isolated species *B. polymyxa*. Another study described in *B. subtilis* degradation of histamine by 27 – 60%, putrescine 7 to 30% and cadaverine 22 to 29% at 24 hours in *in vitro* conditions (Zaman et al., 2010). The study of Eom et al. (2015) suggesting that histamine degradation was apparently mediated by suppression of histamine H3 receptor expression. According to the results of it was suggested that the *B. subtilis* might affect the synthesis and degradation of BAs, such as histamine and tyramine, by decreasing the expression of histidine and tyrosine decarboxylase-related genes (*hdc* and *tydc*). *Bacillus subtilis* 1a is able to significantly degrade BAs in mineral medium. This strain degraded the entire volume of histamine, putrescine and cadaverine. This fact points to the possibility of application of this strain as a part of the starter cultures for cheese, fermented meat products and fermented beverages where histamine, putrescine and cadaverine occur in high concentrations (Latorre-Moratalla, et al., 2010; Silla Santos, 1996). Cheese, especially that made from raw milk, in which a specific non-starter microflora is essential for the organoleptic characteristics of the final product, is a particular technological challenge because it is a complex ecosystem involving many various microorganisms with different metabolic instruments, including amino acid decarboxylase enzymes that are responsible for high amounts of biogenic amines (Fernández et al., 2007). Consistent with previously reported results, the addition of this strain as positive starter cultures could help to reduce the most dangerous BAs, such as histamine that is considered as the most toxic biogenic amine. Must not forget the fact that in many cases, the accumulation of BAs has been attributed mainly to the activity of the non-starter microflora (Valsamaki et al., 2000). Furthermore, cadaverine and putrescine can react with nitrite to form heterocyclic carcinogenic nitrosamines, nitrosopyrrolidine or nitrosopiperidine (Silla Santos, 1996). It is important to say that during the first 12 hours of cultivation volume of histamine increased which was highlighted in earlier studies (Zaman, et al., 2011). This fact can be a problem when adding *B. subtilis* to starter cultures for food with a short fermentation time. The fact that *B. subtilis* addition

to started microflora may change the composition of microflora due to competitive action on other strains should not be forgotten. This effect could devalue the final product during the ripening process (Linares et al., 2011). The use of BA-degrading bacteria to reduce the BA content of foods would be to eliminate them from the food matrix. This might to be the strategy of choice with those fermented foods in which it is difficult to avoid the presence of BA-producing LAB because they are part of the usual microbiota, and consequently BA are present at the final stages of the manufacturing process (Alvarez and Moreno-Arribas, 2014).

CONCLUSION

In conclusion it can be emphasized that all studied strains, primarily *B. subtilis* 1a, exhibited the ability to degrade biogenic amines *in vitro* and they could be used as microbiological indicators to prevent BAs accumulation in food. However, they require additional studies to verify the ability of biogenic amines degradation in the fermentation conditions and normal manufacturing process.

REFERENCES

- Alvarez, M. A., Moreno-Arribas, M. V. 2014. The problem of biogenic amines in fermented foods and the use of potential biogenic amine-degrading microorganisms as a solution. *Trends in Food Science and Technology*, vol. 39, no. 2, p. 146-155. <https://doi.org/10.1016/j.tifs.2014.07.007>
- Askar, A., Treptow, H. 1986. Biogene amine in Lebensmitteln – Vorkommen, Bedeutung und Bestimmung. *Molecular Nutrition Food Research*, vol. 32, no. 4, p. 420.
- Arnold, S. H., Brown, W. D. 1978. Histamine toxicity from fish products. *Advances in Food Research*, vol. 34, p. 113-154. [https://doi.org/10.1016/S0065-2628\(08\)60157-3](https://doi.org/10.1016/S0065-2628(08)60157-3)
- Bardócz, S., Grant, G., Brow, D. S., Ralph, A. and Pusztai, A. 1993. Polyamines in food - implications for growth and health. *The Journal of Nutritional Biochemistry*, vol. 4, no. 2, p. 66-71. [https://doi.org/10.1016/0955-2863\(93\)90001-D](https://doi.org/10.1016/0955-2863(93)90001-D)
- Bodmer, S., Imark, C., Kneubühl, M. 1999. Biogenic amines in foods: histamine and food processing. *Inflammatory Research*, vol. 48, no. 6, p. 296-300. <https://doi.org/10.1007/s000110050463>
- Buňková, L., Buňka, F., Hlobilová, M., Vaňátková, Z., Nováková, D., Dráb, V. 2009. Tyramine production of technological important strains of *Lactobacillus*, *Lactococcus* and *Streptococcus*. *European Food Research and Technology*, vol. 229, p. 533-538. <https://doi.org/10.1007/s00217-009-1075-3>
- Buňková, L., Adamcová, G., Hudcová, K., Velichová, H., Pachlová, V., Lorencová, E., Buňka, F. 2013. Monitoring of biogenic amines in cheeses manufactured at small-scale farms and in fermented dairy products in the Czech Republic. *Food Chemistry*, vol. 141, no. 1, p. 548-551. <https://doi.org/10.1016/j.foodchem.2013.03.036>
- Dadáková, E., Křížek, M., Pelikánová, T. 2009. Determination of biogenic amines in foods using ultra-performance liquid chromatography (UPLC). *Food Chemistry*, vol. 116, no. 1, p. 365-370. <https://doi.org/10.1016/j.foodchem.2009.02.018>
- Degheidi, M. A., Effat, B. A., Shalaby, A. R. 1992. Development of some biogenic amines during Ras cheese ripening with special reference to different starters. In *Proceedings 5th Egyptian Conference for Dairy Science and Technology*. Cairo, Egypt, p. 205-217.

- El-Sayed, M. M. 1997. Biogenic amines in processed cheese available in Egypt. *International Journal of Dairy Science*, vol. 6, no. 11-12, p. 1079-1086. [https://doi.org/10.1016/S0958-6946\(96\)00031-3](https://doi.org/10.1016/S0958-6946(96)00031-3)
- Eom, J. S., Seo, B. Y., Choi, H. S. 2015. Biogenic Amine Degradation by *Bacillus* Species Isolated from Traditional Fermented Soybean Food and Detection of Decarboxylase-Related Genes. *Journal of Microbiology and Biotechnology*, vol. 25, no. 9, p. 1519-1527. <https://doi.org/10.4014/jmb.1506.06006>
- European Food Safety Authority (EFSA), 2011. Scientific opinion on risk based control of biogenic amine formation in fermented foods. *EFSA Journal*, vol. 9, no. 10, p. 1-93. <https://doi.org/10.2903/j.efsa.2011.2393>
- Fadda, S., Vignolo, G., Oliver, G. 2001. Tyramine degradation and tyramine/histamine production by lactic acid bacteria and *Kocuria* strains. *Biotechnology Letters*, vol. 23, no. 24, p. 2015-2019. <https://doi.org/10.1023/A:1013783030276>
- Fernández, M., Linares, D. M., Rodríguez, A., Alvarez, M. A. 2007. Factors affecting tyramine production in *Enterococcus durans* IPLA655. *Applied Microbiology and Biotechnology*, vol. 73, no. 6, p. 1400-1406.
- Foster, J. W., Hall, H. K. 1991. Inducible pH homeostasis, and the acid tolerance response to *Salmonella typhimurium*. *Journal of Bacteriology*, vol. 173, no. 16, p. 5129-5135. <https://doi.org/10.1128/jb.173.16.5129-5135.1991>
- Gregová, G., Kmetová, M., Kmet, V., Venglovský, J., Feher, A. 2012. Antibiotic resistance of *Escherichia coli* isolated from a poultry slaughterhouse. *Annals of Agricultural and Environmental Medicine*, vol. 19, no. 1, p. 75-77. [PMid:22462449](https://doi.org/10.1016/j.aem.2012.02.003)
- Güçüglü, A., Küpülü, Ö. 2010. The effect of different starter cultures and ripening temperatures on formation of biogenic amine in Turkish fermented sausages. *European Food Research and Technology*, vol. 230, p. 875-884. <https://doi.org/10.1007/s00217-010-1220-z>
- Halász, A., Baráth, A., Simon-Sarkadi, L., Holzapfel, W. 1994. Biogenic amines and their production by microorganisms in food-review. *Trends in Food Science and Technology*, vol. 5, no. 2, p. 49. [https://doi.org/10.1016/0924-2244\(94\)90070-1](https://doi.org/10.1016/0924-2244(94)90070-1)
- Hernandez-Jover, T., Izquierdo-Pulido, M., Veciana-Nogues, M. T., Marine-Font, A., Vidal-Carou, M. C. 1997. Biogenic amine and polyamine contents in meat and meat products. *Journal of Agricultural and Food Chemistry*, vol. 45, no. 6, p. 2098-102. <https://doi.org/10.1021/jf960790p>
- Herrero-Fresno, A., Martínez, N., Sánchez-Llana, E., Díaz, M., Fernández, M., Martín, M. C., Ladero, V., Alvarez, M. A. 2012. *Lactobacillus casei* strains isolated from cheese reduce biogenic amine accumulation in an experimental model. *International Journal of Food Microbiology*, vol. 157, no. 2, p. 297-304. <https://doi.org/10.1016/j.ijfoodmicro.2012.06.002>
- Christensen, H., Bisgaard, M. 2010. Molecular classification and its impact on diagnostics and understanding the phylogeny and epidemiology of selected member of Pasteurellaceae of veterinary importance. *Berliner und Münchener Tierärztliche Wochenschrift*, vol. 123, no. 1-2, p. 20-30.
- Joosten, H. M. L. G., Olieman, C. 1986. Determination of biogenic amines in cheese and some other food products by high-performance liquid chromatography in combination with thermo-sensitized reaction detection. *Journal of Chromatography*, vol. 356, no. 2, p. 311-319. [https://doi.org/10.1016/S0021-9673\(00\)91491-2](https://doi.org/10.1016/S0021-9673(00)91491-2)
- Joosten, H. M. L. G., Stadhouders, J. 1987. Conditions allowing the formation of biogenic amines in cheese. 1. Decarboxylative properties of starter bacteria. *Netherlands Milk Dairy Journal*, vol. 41, p. 247-259.
- Joosten, H. M. L. G. 1988. Conditions allowing the formation of biogenic amines in cheese. 3. Factors influencing the amounts formed. *Netherlands Milk Dairy Journal*, vol. 41, p. 329-357.
- Ladero, V., Calles-Enríquez, M., Fernández, M., Alvarez, M. A. 2010. Toxicological effects of dietary biogenic amines. *Current Nutrition and Food Science*, vol. 6, p. 145-156. <https://doi.org/10.2174/157340110791233256>
- Latorre-Moratalla, M. L., Bover-Cid, S., Aymerich, T., Marcos, B., Vidal-Carou, M. C., Garriga, M. 2007. Aminogenesis control in fermented sausages manufactured with pressurized meat batter and starter culture. *Meat Science*, vol. 75, no. 3, p. 460-469. <https://doi.org/10.1016/j.meatsci.2006.07.020>
- Latorre-Moratalla, M., Bover-Cid, S., Talon, R., Garriga, M., Zanardi, E., Ianieri, A., Fraqueza, M., Elias, M., Drosinos, E., Vidal-Carou, M. 2010. Strategies to reduce biogenic amine accumulation in traditional sausage manufacturing. *Food Science and Technology*, vol. 43, no. 1, p. 20-25. <https://doi.org/10.1016/j.lwt.2009.06.018>
- Lee, Y. C., Lin, C. S., Liu, F. L., Huang, T. Z. 2015. Degradation of histamine by *Bacillus polymyxa* isolated from salted fish products. *Journal of Food and Drug Analysis*, vol. 23, no. 4, p. 836-844. <https://doi.org/10.1016/j.jfda.2015.02.003>
- Linares, D. M., del Río, B., Ladero, V., Martínez, N., Fernández, M., Cruz Martín, M., Álvarez, M. A. 2011. Factors influencing biogenic amines accumulation in dairy products. *Frontiers in Microbiology*, vol. 3, p. 180. <https://doi.org/10.3389/fmicb.2012.00180>
- Lovenberg, W. 1973. Some vaso- and psychoactive substances in food: amines stimulates depressants and hallucinogens. In *Toxicants Occurring Naturally in Foods*, Washington, DC : National Academy of Science.
- Majjala, R. L. 1993. Formation of histamine and tyramine by some lactic acid bacteria in MRS-broth and modified decarboxylation agar. *Letters in Applied Microbiology*, vol. 17, no. 1, p. 40-43. <https://doi.org/10.1111/j.1472-765X.1993.tb01431.x>
- Mariné-Font, A., Vidal-Carou, M. C., Izquierdo-Pulido, M., Veciana-Nogues, M. T., Hernández-Jover T. 1995. Les amines biogènes dans les aliments: leur signification, leur analyse. *Annales des Falsifications et de l'Expertise Chimique et Toxicologique*, vol. 88, p. 119-140.
- Martinez, N., Cruz Martín, M., Herrero, A., Fernandez, M., Alvarez, M., Ladero, V. 2011. qPCR as a powerful tool for microbial food spoilage quantification: significant for food quality. *Trends in Food Science and Technology*, vol. 22, no. 7, p. 367-376. <https://doi.org/10.1016/j.tifs.2011.04.004>
- Postollec, F., Falentin, H., Pavan, S., Combrisson, J., Sohier, D. 2011. Recent advances in quantitative PCR (qPCR) applications in food microbiology. *Food Microbiology*, vol. 28, no. 5, p. 848-861. <https://doi.org/10.1016/j.fm.2011.02.008>
- Shalaby, A. R. 1996. Significance of biogenic amines in food safety and human health. *Food Research International*, vol. 29, no. 7, p. 675-690. [https://doi.org/10.1016/S0963-9969\(96\)00066-X](https://doi.org/10.1016/S0963-9969(96)00066-X)
- Silla Santos, H. M. 1996. Biogenic amines: their importance in foods. *International Journal of Food Microbiology*, vol. 29, no. 2-3, p. 213-231. [https://doi.org/10.1016/0168-1605\(95\)00032-1](https://doi.org/10.1016/0168-1605(95)00032-1)

Simmon, K. E., Croft, A. C., Petti, C. A. 2006. Application of SmartGene IDNS Software to partial 16S rRNA gene sequences for a diverse group of bacteria in a clinical laboratory. *Journal of Clinical Microbiology*, vol. 44, no. 12, p. 4400-4406. <https://doi.org/10.1128/JCM.01364-06>

Smělá, D., Pechová, P., Komprda, T., Klejduš, B., Kubáň, V. 2004. Chromatografické stanovení biogenních aminů v trvanlivých salámech během fermentace a skladování (*Chromatographic determination of biogenic amines in durable salami during fermentation and storage*). *Chemické listy*, vol. 98, p. 432-437.

Stratton, J. E., Hutkins, R. W., Taylor, S. L. 1991. Biogenic amine contents of ras cheese and incidence of their bacterial producers. *Journal of Food Protection*, vol. 54, p. 460-470. <https://doi.org/10.4315/0362-028X-54.6.460>

Tawfik, N. F., Shalaby, A. R., Effat, B. A. 1992. Biogenic amine contents of ras cheese and incidence of their bacterial producers. *Egyptian Journal of Dairy Science*, vol. 20, p. 219-225.

ten Brink, B., Damink, C., Joosten, H. M., Huis in't Veld, J. H. 1990. Occurrence and formation of biologically active amines in foods. *International Journal of Food Microbiology*, vol. 11, no. 1, p. 73-84. [https://doi.org/10.1016/0168-1605\(90\)90040-C](https://doi.org/10.1016/0168-1605(90)90040-C)

Valsamaki, K., Michaelidou, A., Polychroniadou, A. 2000. Biogenic amine production in Feta cheese. *Food chemistry*, vol. 71, no. 2, p. 259-266. [https://doi.org/10.1016/S0308-8146\(00\)00168-0](https://doi.org/10.1016/S0308-8146(00)00168-0)

Vítková, L. 2016. *Izolace mikroorganismů degradujících biogenní aminy (Isolation of microorganisms degrading biogenic amines)* : Diploma theses. Zlín : UTB, p. 85.

Voigt, M. N., Eitenmiller, R. R. 1978. Role of histidine and tyrosine decarboxylases and mono-diamine oxidases in amine on build-up in cheese. *Journal of Food Protection*, vol. 41, p. 182-186. <https://doi.org/10.4315/0362-028X-41.3.182>

Yongmei, L., Xiaohong, C., Mei, J., Xin, L., Rahman, N., Mingsheng, D., Yan, G. 2009. Biogenic amines in Chinese soy sauce. *Food Control*, vol. 20, no. 6, p. 593-597. <https://doi.org/10.1016/j.foodcont.2008.08.020>

Zaman, M. Z., Bakar, F. A., Selamat, J., Bakar, J. 2010. Occurrence of Biogenic Amines and Amine Degrading Bacteria in Fish Sauce. *Czech Journal of Food Sciences*, vol. 28, p. 440-449.

Zaman, M. Z., Bakar, F. A., Jinap, S., Bakar, J. 2011. Novel starter cultures to inhibit biogenic amines accumulation during fish sauce fermentation. *International Journal of Food*

Microbiology, vol. 145, no. 1, p. 84-91.

<https://doi.org/10.1016/j.ijfoodmicro.2010.11.031>

Zaman, M. Z., Bakar, F. A., Selamat, J., Bakar, J., Ang, S. S., Chong, C. Y. 2014. Degradation of histamine by the halotolerant *Staphylococcus carnosus* FS19 isolate obtained from fish sauce. *Food Control*, vol. 40, p. 58-63. <https://doi.org/10.1016/j.foodcont.2013.11.031>

Zhao, X., Yng, L., Yu, Z., Peng, N., Xiao, L., Yin, D., Qin, B. 2008. Characterization of depth-related microbial communities in lake sediment by denaturing gradient gel electrophoresis of amplified 16S rRNA fragments. *Journal of Environmental Sciences*, vol. 20, no. 2, p. 224-230. [https://doi.org/10.1016/S1001-0742\(08\)60035-2](https://doi.org/10.1016/S1001-0742(08)60035-2)

Acknowledgments:

This work was supported from the Internal Grant of Tomas Bata University in Zlín (No. IGA/FT/2017/003) and the Grant Agency of the Czech Republic (GAČR No. 17-09594S).

Contact address:

Irena Butor, Tomas Bata University in Zlín, Faculty of Technology, Department of Environmental Protection Engineering, Vavrečkova 275, 760 01, Zlín, Czech Republic, E-mail: butor@ft.utb.cz

Hana Pištěková, Tomas Bata University in Zlín, Faculty of Technology, Department of Environmental Protection Engineering, Vavrečkova 275, 760 01, Zlín, Czech Republic, -mail: h.pistekova@gmail.com

Khatantuu Purevdorj, Tomas Bata University in Zlín, Faculty of Technology, Department of Environmental Protection Engineering, Vavrečkova 275, 760 01, Zlín, Czech Republic, E-mail: purevdorj@ft.utb.cz

Petra Jančová, Tomas Bata University in Zlín, Faculty of Technology, Department of Environmental Protection Engineering, Vavrečkova 275, 760 01, Zlín, Czech Republic, E-mail: jancova@ft.utb.cz

František Buňka, Tomas Bata University in Zlín, Faculty of Technology, Department of Food Technology, Vavrečkova 275, 760 01, Zlín, Czech Republic, E-mail: bunka@ft.utb.cz

Leona Buňková, Tomas Bata University in Zlín, Faculty of Technology, Department of Environmental Protection Engineering, Vavrečkova 275, 760 01, Zlín, Czech Republic, E-mail: bunkova@ft.utb.cz



EFFECT OF APRICOT SEEDS ON RENAL STRUCTURE OF RABBITS

Anna Kolesárová, Juraj Pivko, Marek Halenár, Katarína Zbyňovská, Ľubica Chrastinová, Ľubomír Ondruška, Rastislav Jurčík, Jana Kopčeková, Jozef Valuch, Adriana Kolesárová

ABSTRACT

Amygdalin is the major cyanogenic glycoside present in apricot seeds and is degraded to cyanide by chewing or grinding. The animal data available did not provide a suitable basis for acute human health hazard. The apricot seeds are potentially useful in human nutrition and for treatment of several diseases especially cancer. The present study demonstrates the potential effect of short-term oral application of apricot seeds on renal structure of rabbit as a biological model. Meat line P91 Californian rabbits from the experimental farm of the Animal Production Research Centre Nitra (Slovak Republic) were used in the experiments. The animals were randomly divided into the three groups (C-control, P1, P2 – experimental groups) leading to 8 rabbits in each group. The control group received no apricot seeds while the experimental groups P1 and P2 received a daily dose 60 and 300 mg.kg⁻¹ b.w. of crushed apricot seeds mixed with feed during 28 days, respectively. After 28 days all animals were slaughtered and kidney tissue was processed by standard histopathological techniques. Tissue sections were observed under an optical microscope with camera Olympus CX41 (Olympus, Japan) at a magnification of 10 x 0.40. The basic morphometric criteria of the preparations were quantified using image program MeasurIT (Olympus, Japan). From each sample (n = 24) three histological sections with five different fields of view in each section were analysed and followed parameters were analysed: diameter of renal corpuscles (RC), diameter of glomeruli (G), diameter of tubules (T) and the height of epithelial tubules (E). In our study, we observed a slight increase in the most frequent occurrence parenchyma dystrophy experimental animals. These changes were more pronounced in the experimental group (P2) rabbits received a daily dose of 300 mg.kg⁻¹ of body weight of apricot seeds. Most often, we have found enlarged glomeruli filling the entire space of the capsule, and also glomerular basement membrane thickening. The most frequent alterations of tubular organs manifested by thickening and dilatation of proximal tubules and in the lumen of the occurrence fuchsinophilic mass, grains and hyaline cylinders. The occurrence of the vacuole and parenchymal atrophy was mostly balanced groups. Changes in P2 group are also reflected in morphometric evaluation structures. We have found significant decrease ($p < 0.001$) in the average of all renal structures (diameter of renal corpuscles, diameter of glomeruli, diameter of tubules, and the height of epithelial tubules). Inversely, oral administration a daily dose of 60 mg.kg⁻¹ of body weight of apricot seeds had no significant impact on these parameters. The change displays only the increase of renal tubule diameter. Our data may provide more specific evidence of oral application of apricot seeds on renal structure but further detailed studies are also required.

Keywords: seeds; amygdalin; rabbits; kidney

INTRODUCTION

Apricot (*Armeniaca vulgaris* L.) is typically ingested as fruits (Hakan et al., 2009). The fruit seeds of apricot trees are classified according to their taste into sweet apricot, semi-bitter apricot, and bitter apricot. Apricot seeds are found as an ingredient in a variety of processed foods, including baked and confectionery products (Lee et al., 2013). Apricot seeds contain a wide variety of bioactive components, and that consumption of apricot kernel has been associated with a reduced risk of chronic diseases (Zhang et al., 2011). Bitter apricot seeds have long been

used in Chinese traditional medicine for the treatment of asthma, bronchitis, emphysema, constipation, nausea, leprosy, leucoderma, and pain (Bensky et al., 2004). It is a natural product that owns antitumor activity, less side effects and relatively low priced (Song and Xu, 2014). Alternative cancer therapy represents a variety of treatments used by cancer patients for cancer prevention, treatment or management of symptoms caused by the malignancy or cancer therapies (Balmer, 1998). Natural plant substances like amygdalin are still a major part of traditional medicine. However, its effect on animal and

human organisms is still not clear (Kováčová, 2016). The use of apricot seeds for human nutrition is limited because of their content of the toxic, cyanogenic glycoside amygdalin, accompanied by minor amounts of prunasin (Gomez et al., 1998). Many edible plants contain cyanogenic glycosides, whose concentrations can vary widely as a result of genetic and environmental factors, location, season, and soil types (JECFA, 1993). Amygdalin and prunasin are members of a large class of natural products called CNGs (cyanogenic glycosides) (Yamaguchi et al., 2014). In intact apricot kernels, amygdalin and its catabolic enzymes are stored in separate compartments and are brought into contact by physical processes such as grinding or chewing thereby releasing hydrocyanic acid (HCN). Complete degradation of 1 g of amygdalin releases 59 mg HCN (EFSA, 2016). Hydrogen cyanide can be produced by hydrolytic reaction catalysed by one or more enzymes from the plants containing cyanogenic glycosides. In kernels, for example, this reaction is catalysed by the enzyme emulsin (Lasch and El Shawa, 1981) when the seeds are crushed and moistened. Amygdalin (which is also present in cassava, bitter almonds, and peach stones) is converted to glucose, benzaldehyde, and hydrogen cyanide (IPCS, 1992). Liberation of hydrogen cyanide from cyanogenic glycosides occurs usually after ingestion and hydrolysis by the glycosidases of the intestinal microflora and, to a lesser degree, by glucosidases of the liver and other tissues (Padmaja, 1995). Kidney as a central apparatus of urinary system is exposed to high demands for ensuring the homeostasis of the organism (Jelinek et al., 2003). Kidneys have an important role in the body. Any damage to kidney role can damage many organs of the body (Mahjour et al., 2017). The present study demonstrates the potential effect of short-term oral application of apricot seeds on renal structure of rabbit as a biological model.

MATERIAL AND METHODOLOGY

Chemicals

Bitter apricot seeds were provided by Trasco (Žiar n. Hronom, Slovakia). Thin Layer Chromatography (TLC) was performed for the analysis of amygdalin content (5.2%) in bitter apricot seeds used in our experiment. Grinded apricot seeds (2 g) were mixed with 10 mL of methanol in a vial and put into ultrasonic bath for 30 minutes at 55 °C. After cooling, 10 µL of solution was applied onto TLC plates Kieselgel UV 254 20x20 cm (Merck KGaA, Darmstadt, Germany). Mixture of n-butanol, acetic acid and water (95: 5: 25) was used as a mobile phase. Separation took about 5 hours at room temperature. After separation, amygdalin content was determined by UV densitometer CS – 9000 (Shimadzu, Japan) at 205 nm. An external standard was used (1% amygdalin solution in methanol).

Animals

Twenty four healthy rabbits females of meat line P91 (Californian rabbit) from the experimental farm of the Animal Production Research Centre Nitra (Slovak Republic) were used for the purpose of this study. The rabbits were 150 days old, weighing 4.00 ± 0.5 kg, and were housed in individual wire cages and kept in 12-h

dark/light cycle, at a temperature between 20 – 24 °C and humidity 55% \pm 10%. The rabbits were fed a standard commercially available feed based on a pelleted concentrate. Animals had free access to feed and water during the study period and no toxic or side effects or death was observed throughout the study. The animals were randomly divided into the three groups (C-control, P1, P2 – experimental groups) leading to 8 rabbits in each group. The control group received no apricot seeds while the experimental groups P1 and P2 received a daily dose 60 and 300 mg.kg⁻¹ b.w. of crushed apricot seeds mixed with feed during 28 days, respectively. The body weight of each experimental animal was recorded weekly during the whole study. Conditions of animals care, manipulations and use corresponded with the instruction of ethical commission. Care and use of animals and experimental devices met the requirement of the certificate of Authorization to Experiment on Living Animals, no. 3398/11-221/3 (certified by State Veterinary and Food Institute of Slovak Republic). All efforts were made to minimize suffering.

Collection of tissue samples

The animals were killed by technology used for the Animal Production Research Centre Nitra – electrocution and then bled. Using surgical scissors were taken from the abdominal organs. The kidneys were evaluated macroscopically (visual) and processed for histological analysis. Kidney samples were washed in physiological saline solution and then individually weighed. For histopathological and histochemical examinations, small pieces of the liver and kidney were collected and rinsed in 10% buffered neutral formalin solution.

Histopathological analysis

For histopathological examinations, the kidney tissue samples (n = 24) were fixed in 10% neutral buffered formalin (Sigma-Aldrich), dehydrated with (of) ethanol (70% and 96% 2 hours 100% 1 hour) and embedded in paraffin wax. The samples were cut rotary microtome AC-820 (American Corporation, USA) cut rotary microtome AC-820 (American Corporation, USA) and stained with hematoxylineeosin (H & E). Stained sections were mounted in Entelan and examined with an Olympus CX41 optical microscope with camera (Olympus Optical Co., Osaka, Japan) at a magnification of 10x40.

The basic morphometric criteria of the preparations were quantified using image program MeasurIT (Olympus, Japan). From each sample three histological sections with five different fields of view in each section were analysed and followed parameters were analysed: diameter of renal corpuscles (RC), diameter of glomeruli (G), diameter of tubules (T) and the height of epithelial tubules (E).

Statistical analysis

Statistical analyses were performed using the program STATISTICA Cz version 10 belonging to the available statistical programs. All values were expressed as mean \pm standard deviation (SD). Differences between control and experimental groups were assessed by Tukey HSD test (one-way ANOVA). Differences from controls ($p < 0.05$, $p < 0.01$, $p < 0.001$) were considered as significant.

RESULTS AND DISCUSSION

Kidney is a parenchyma apparatus with microscopic structure looks like tubular gland. Kidney's parenchyma consists of nephron and intrarenal efferent urinary tract. The nephron consists of capillary tuft (*glomerulum*) coated by two-bladed Bowman's capsule (*capsula glomerula*) and known as renal corpuscle (*corpusculum renis*) (Lukáč et al., 2006). After the pathological-anatomical autopsy we assess kidney macroscopically. We

found out russet color, fabaceous shape of rabbit kidney with a smooth surface, cover by a gentle fibrosis casing. Kidney parenchyma on section showed no pathological damage. On the histological preparations were clearly formed glomeruli encapsulated two-bladed Bowmanov coated casing, which produced typically renal corpuscle. As the excisions came from cortex area of kidney, marked representation was created by proximal convoluted tubules.

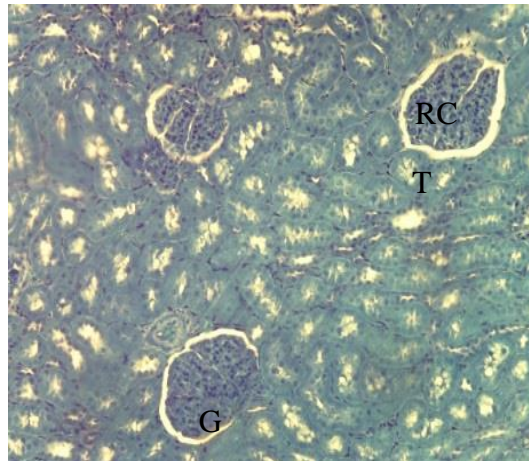

Figure 1 Representative photomicrographs of kidney sections from control groups: normal renal architecture – renal corpuscles (RC), glomeruli (G), tubules (T).

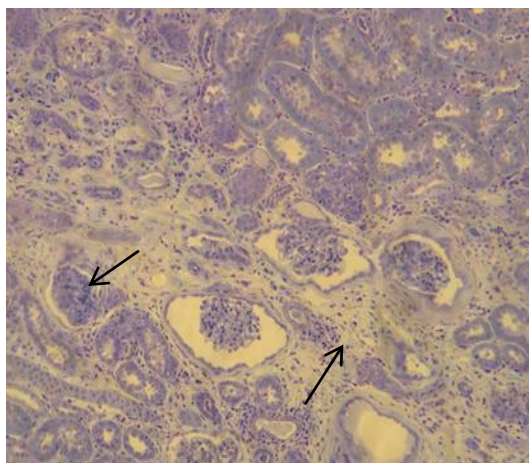

Figure 2 Representative photomicrographs of kidney sections from experimental P1 groups: part of atrophic renal parenchyma with renal corpuscle and left dark atrophic glomerulus.

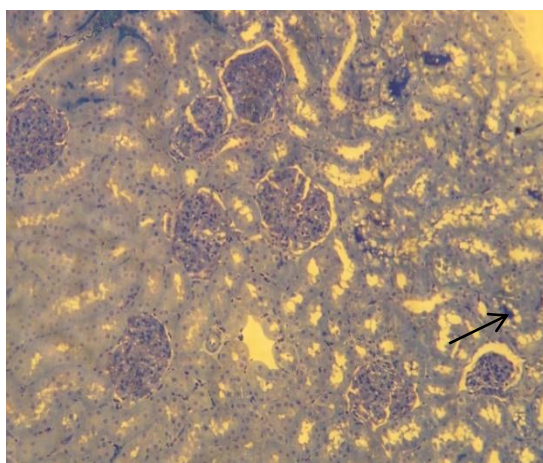

Figure 3 Representative photomicrographs of kidney sections from experimental P2 groups: in the tubules are visible dark hyaline cylinders.

Table 1 Histopathological evaluation of the renal tissue from animals in the control and experimental groups.

groups	n	Glomeruli		Dystrophic changes of tubules		
		expansion	thickening of bm	thickening of pk	vacuoles	atrophy p
C	8	+	+	+ fm	-	+
P1	8	++	++	++ fm, hc, dt	+	+
P2	8	++	++	++ fm, hc, dt, fg	+	+

Note: intensity of change: + low, ++ medium, +++ high, bm- basement membrane; pk- proximal convoluted tubule; atrophy p- parenchymal atrophy; pgf- periglomerular fibrosis; fm- fuchsinophilic mass; fg- fuchsinophil grains; hc- hyaline cylinder; dt- tubular dilatation.

Table 2 Quantitative evaluation of basic structures of the rabbit kidney.

	C	P1	P2
n	255	175	266
Diameter of renal corpuscles (µm) (µm)	129.44 ±23.67	130.08 ±22.14	118.01 ±26.42 ^a
n	255	175	266
Diameter of glomeruli (µm)	111.86 ±20.36	110.43 ±17.83	102.36 ±23.73 ^a
n	995	863	1125
The height of epithelial (µm)	15.20 ±2.78	15.55 ±2.85	13.79 ±3.28 ^a
n	756	616	842
Diameter of tubules (µm)	55.88 ±7.73	58.88 ±9.22 ^a	49.35 ±12.99 ^a

Note: data are expressed as the mean ±SD, p-values resulted from ANOVA, a – statistically significant differences compared to control group, $p < 0.001$, C- control; P1, P2 – experiment.

The results of histopathological analysis of the control (C) and experimental (P1, P2) rabbit kidney samples presented in the summary table (Table 1), prepared from data obtained by examination of histological slides of all (n = 24) and the section (n = 72). Control rabbits' kidney sections showed normal architecture of the characteristic renal parenchyma with normal renal tubular epithelia (Figure 1). Most often, we found enlarged glomeruli filling the entire space of the capsule, and also glomerular basement membrane thickening. The proximal tubule is uniquely susceptible to a variety of metabolic and hemodynamic factors (Thomas et al., 2005). The most frequent alterations of tubular organs manifested by thickening and dilatation of proximal tubules and in the lumen of the occurrence fuchsinophilic mass, grains and hyaline cylinders. The occurrence of the vacuole and parenchymal atrophy was mostly balanced groups (Figure 2 and Figure 3).

Glomerular filtration rate has a central role in the pathophysiology of chronic kidney disease complications. Chronic kidney disease occurs when the impaired kidney function persists for three months or more. In this disorder, there is a decrease kidney function based on the presence of kidney damage (Levey et al., 2012).

In our study morphometric evaluation of each kidney structures (Table 2) showed a decrease diameters of renal corpuscles and diameter of glomeruli in P2 group when compared to the control group. These changes were statistically significant ($p < 0.001$). Diameters of renal corpuscles decreased about 11.43 µm and a diameter of glomeruli decreased about 9.5 µm. The differences between C and P1 group were no significant in these structures. The authors (Tulsawani et al., 2005) found no significant changes in body weight and organ-body index in the treatment group Female Wistar rats dosed by gavage to 7 mg KCN.kg⁻¹ b.w. once daily for 14 days. Glomerular congestion, tubular lesions displaying vacuolar degeneration at proximal tubular epithelial cells and scattered tubule disorganisation due to damaged renal parenchyma were also observed. Other authors have found

that marked changes take place in tubular epithelial cells in experimental postischemic (ischemia-reperfusion) rat kidney (Aunapuu et al., 2005).

Most of the substances presented in the glomerular filtrate were in a greater or lower extent absorbed in the tubules (Trojan, 1992). In the assessment the average of the tubules diameter, we found a statistically significant increase ($p < 0.001$) in the groups P1 (about 3.0 µm) and significant decrease (about 6.53 µm) in the group P2 in comparison with the control group. Epithelium height was a statistically significant decrease ($p < 0.001$) only in the C/P2 group (about 1.41 µm). The differences between C and P1 group were remained insignificant.

Sousa et al. (2002) found moderate to severe congestion and cytoplasmic vacuolisation of the epithelial cells of the kidney proximal tubules at fifteen-day study male adult Wistar rats treated with KCN in drinking water adjusting KCN concentration to body weight and water consumption in order to administer 3.0 or 9.0 mg.kg⁻¹ per day.

Hydrogen cyanide after oral administration is readily absorbed. After absorption, cyanide is rapidly distributed in the body through the blood (EPA, 1990). Cyanogenic glycosides are hydrolyzed by β-glucosidase produced by intestinal bacteria to glucose, HCN and benzaldehyde or acetone (Oke, 1979). Beta-glucosidase was demonstrated in cat, rat and rabbit kidney tissue that catalyzed the hydrolytic cleavage of terminal glucose residue of amygdalin (Freese et al., 1980).

In a 13-week study, male Sprague-Dawley rats were administered potassium cyanide in drinking-water at a dose level of 40, 80, or 160/140 mg.kg⁻¹ body weight per day. Histopathological investigation of the brain, heart, liver, testes, thyroid, and kidneys did not reveal adverse effects (Leuschner et al., 1989). Acute oral median lethal dose (LD50) values for cyanide in laboratory animals range from 2.13 to 6 mg.kg⁻¹ body weight. Lethal levels of cyanide lead to dyspnoea, irregular and gasping breathing, ataxia, tremor, spasms, loss of consciousness, convulsions and eventually asphyxiation. Short-term dietary exposure

to cyanide leads to histopathological changes and alterations in organ weights (EFSA, 2016).

In none of the reported short-term studies was mortality observed at doses up to 40 mg CN.kg⁻¹ bw per day, even though some of the doses were equal to or higher than the oral LD50 for cyanide. Since in the short-term studies analysed, cyanide was administered through the diet or drinking water, absence of mortality is possibly due to a slower absorption rate following dietary exposure, thus not exhausting the detoxification capacity of the enzyme rhodanese, which occurs after bolus administration in LD50 tests (Hayes, 1967; US EPA, 2010).

The dystrophy of parenchyma, which we most frequently observed is the lowest level of regressive damage cells and extracellular tissue. It is a reversible process caused by changes in cell metabolism, manifested by morphological changes. The changes were more pronounced in the experimental group of rabbits which received a daily dose 300 mg.kg⁻¹ b.w. of crushed apricot seeds mixed with feed during 28 days, respectively.

The pathologic findings of renal fibrosis are often described as glomerulosclerosis, tubulo-interstitial fibrosis, inflammatory infiltration, and loss of renal parenchyma characterized by tubular atrophy, capillary loss, and podocyte depletion (Liu, 2006). Cyanide causes a decrease in the utilization of oxygen in the tissues, producing a state of histotoxic anoxia (Solomonson, 1981). Parenchymal kidney cells contained a small grains or larger or smaller vacuoles of watery fluid. Slightly increased incidence of parenchymal organs dystrophy experimental rabbits could cause damage in the circulatory system and insufficient supply of oxygen-hypoxia or nutrient substances to the cells, but also an excessive load on the kidney function in pregnancy.

CONCLUSION

In our short-term study, we most often observed a slight increase in the incidence of renal parenchyma dystrophy of experimental animals. The changes were more pronounced in the experimental group of rabbits which received a daily dose 300 mg.kg⁻¹ b.w. of apricot seeds. Changes in this group is also reflected in morphometric evaluation structures and a significant decrease in the average of all renal structures (diameter of renal corpuscles, diameter of glomeruli, diameter of tubules, and the height of epithelial tubules). Inversely, oral administration a daily dose of 60 mg.kg⁻¹ of body weight of apricot seeds had no significant impact on these parameters. The change displays only the increase of renal tubules diameter. These changes inform about possible nephrotic dysfunction and thereby disrupt the homeostasis of urinal excretion, but further detailed studies are also required.

REFERENCES

Aunapuu, M., Pechter, U., Kühnel, W., Ots, M., Arend, A. 2005. Morphological changes in experimental postischemic rat kidney. A pilot study. *Annals of Anatomy – Anatomischer Anzeiger*, vol. 187, no 1, 2005, p. 63-70. <https://doi.org/10.1016/j.aanat.2004.07.002> PMID:15835402

Balmer, C. B. 1998. Alternative therapies in cancer patient care. *Highlights in oncology practice*, vol. 15, p. 83-84.

Bensky, D., Clavey, E., Stöger, E. 2004. *Chinese Herbal Medicine: Materia Medica*. 3rd ed. Seattle : Eastland Press, p. 437-440. ISBN-13: 978-0939616824.

EPA, 1990. Summary Review of Health Effects Associated with Hydrogen Cyanide, Health Issue Assessment Environmental Criteria and Assessment Office, Office of Health and Environmental Assessment Office of Research and Development, US Environmental Protection Agency Research Triangle Park, North Carolina, USA.

Freese, A., Brady, R. O., Gal, A. E., 1980. A beta-glucosidase in feline kidney that hydrolyzes amygdalin (Laetrile). *Archives of Biochemistry and Biophysics*, vol. 201, no. 2, p. 363-368. [https://doi.org/10.1016/0003-9861\(80\)90523-8](https://doi.org/10.1016/0003-9861(80)90523-8)

Gomez, E., Burgos, L., Soriano, C. 1998. Amygdalin content in the seeds of several apricot cultivars. *Journal of the Science of Food and Agriculture*, vol. 77, no. 2, p. 184-186. [https://doi.org/10.1002/\(SICI\)1097-0010\(199806\)77:2<184::AID-JSFA22>3.0.CO;2-H](https://doi.org/10.1002/(SICI)1097-0010(199806)77:2<184::AID-JSFA22>3.0.CO;2-H)

Hakan, P., Ercument, O., Ahmet, A., Feral, O., Seda, T., Burhan, A., Mehmet, G., Ali, O. 2009. Beneficial effects of apricot-feeding on myocardial ischemia-reperfusion injury in rats. *Food and Chemical Toxicology*, vol. 47, no. 4, p. 802-808. <https://doi.org/10.1016/j.fct.2009.01.014>

Hayes, W. J. 1967. The 90 day LD50 and chronicity factors as a measure of toxicity. *Toxicology and Applied Pharmacology*, vol. 11, no. 2, p. 327-335. [https://doi.org/10.1016/0041-008X\(67\)90076-2](https://doi.org/10.1016/0041-008X(67)90076-2)

IPCS, 1992. Poison Information Monograph – Cyanides. Geneva, World Health Organization, International Programme on Chemical Safety, September (IPCS/INTOX/PIM 159).

JECFA, 1993. Cyanogenic glycosides. In: *Toxicological evaluation of certain food additives and naturally occurring toxicants*. Geneva : World Health Organization, 49 p.

Jelínek, P., Koudela, K. 2003. *Fyziologie hospodářských zvířat (Animal physiology)*. Brno : Mendelova zemědělská a lesnická univerzita v Brně, p. 208-219. ISBN 80-7157-644-1.

Kováčová, V., Omelka, R., Šarocká, A., Šranko, P., Adamkovičová, M., Toman, R., Halenár, M., Kolesárová, A., Martiniaková, M. 2016. Histological analysis of femoral bones in rabbits administered by amygdalin. *Potravinárstvo*, vol. 10, no. 1, p. 393-399. <https://doi.org/10.5219/625>

Lasch, E. E., El Shawa, R. 1981. Multiple cases of cyanide poisoning by apricot kernels in children from Gaza. *Pediatrics*, vol. 68, no. 1, p. 5-7.

Lee, J., Zhang, G., Wood, E., Castillo, C., Mitchell, A. E. 2013. Quantification of amygdalin in nonbitter, semibitter, and bitter almonds (*Prunus dulcis*) by UHPLC-(ESI)QqQ MS/MS. *Journal of Agricultural and Food Chemistry*, vol. 61, no. 32, p. 7754-7759. <https://doi.org/10.1021/jf402295u> PMID:23862656

Leuschner, F., Neumann, B. W., 1989. 13-Week toxicity study of potassium cyanide administered to Sprague-Dawley rats in the drinking water: Unpublished study. *Laboratory of Pharmacology and Toxicology*.

Levey, A. S., Coresh, J. 2012. Chronic kidney disease. *The Lancet*. vol. 379, no. 9811, p. 165-180. [https://doi.org/10.1016/S0140-6736\(11\)60178-5](https://doi.org/10.1016/S0140-6736(11)60178-5)

Liu, Y. 2016 Renal fibrosis: New insights into the pathogenesis and therapeutics. *Kidney International*, vol. 69, no. 2, p. 213-217. <https://doi.org/10.1038/sj.ki.5000054> PMID:16408108

Lukáč, N., Massányi, P., Toman, R., Trandžík, J., Capcarová, M., Stawarz, R., Cigánková, V., Jakabová, D.,

Kožáková, I., Forgács, Z., Somosy, Z. 2006. Prejavy toxicity olova a ortuti. In Kováčik, J., et al.: *Biologické aspekty zvyšovania kvality surovín a potravín živočíšneho pôvodu: Vedecká monografia* (Biological aspects of improving the quality of raw materials and food of animal origin: Scientific monograph). Nitra : SPU, p. 145-155.

Mahjour, M., Khoushabi, A., Novi, M. M. G., Feyzabadi Z. 2017. Food strategies of renal atrophy based on Avicenna and conventional medicine. *Journal of Traditional and Complementary Medicine*, In Press, Corrected Proof. <https://doi.org/10.1016/j.jtcme.2016.12.004>

OKE, O. L. 1979. Some aspects of the role of cyanogenic glycosides in nutrition. *World Review of Nutrition and Dietetics*, vol. 33, p. 70-103. <https://doi.org/10.1159/000402550>

Padmaja, G. 1995. Cyanide detoxification in cassava for food and feed use. *Critical Reviews in Food Sciences and Nutrition*, vol. 35, no. 4, p. 259-339. <https://doi.org/10.1080/10408399509527703> [PMid:7576161](https://doi.org/10.1080/10408399509527703)

Panel on Contaminants in the Food Chain. 2016. Acute health risks related to the presence of cyanogenic glycosides in raw apricot kernels and products derived from raw apricot kernels. *EFSA Journal*; vol. 14, no.4, p. 47.

Solomonson, L. P. 1981. Cyanide as a metabolic inhibitor. In Vennesland, B. *Cyanide in Biology*. Michigan : Academic Press, p. 11-18. ISBN 0127169806.

Song, Z., Xu, X. 2014. Advanced research on anti-tumor effects of amygdalin. *Journal of Cancer Research & Therapy*, vol. 1, p. 3-7.

Sousa, A. B., Soto-Blanco, B., Guerra, J. L., Kimura, E. T., Gorniak, S. L. 2002. Does prolonged oral exposure to cyanide promote hepatotoxicity and nephrotoxicity? *Toxicology*, vol. 174, no. 2, p. 87-95. [https://doi.org/10.1016/S0300-483X\(02\)00041-0](https://doi.org/10.1016/S0300-483X(02)00041-0)

Thomas, M. C., Burns, W. C., Cooper, M. E. 2005. Tubular changes in early diabetic nephropathy. *Advances in Chronic Kidney Disease*, vol. 12, no. 2, 2005, p. 177-186. <https://doi.org/10.1053/j.ackd.2005.01.008> [PMid:15822053](https://doi.org/10.1053/j.ackd.2005.01.008)

Trojan, S. 1992. *Fyziológia I (Physiology I)*. Martin : Osveta, p.411. ISBN 80-217-0452-7.

Tulsawani, R. K., Debnath, M., Pant, S. C., Kumar, O., Prakash, A. O., Vijayaraghavan, R., Bhattacharya, R. 2005. Effect of sub-acute oral cyanide administration in rats: protective efficacy of alpha-ketoglutarate and sodium thiosulfate. *Chemico-Biological Interactions*, vol. 156, no. 1, p. 1-12. <https://doi.org/10.1016/j.cbi.2005.05.001> [PMid:16154552](https://doi.org/10.1016/j.cbi.2005.05.001)

US EPA (US Environmental Protection Agency), 2010. Toxicological review of hydrogen cyanide and cyanide salts (CAS No. various) in support of summary information on the Integrated Risk Information System (IRIS). Environmental Protection Agency, Washington, DC, USA.

Yamaguchi, T., Yamamoto, K., Asano, Y., 2014. Identification and characterization of CYP79D16 and CYP71AN24 catalyzing the first and second steps in L-phenylalanine-derived cyanogenic glycoside biosynthesis in the Japanese apricot, *Prunus mume* Sieb. et Zucc. *Plant Molecular Biology*, vol. 86, p. 215-223.

<https://doi.org/10.1007/s11103-014-0225-6> [PMid:25015725](https://doi.org/10.1007/s11103-014-0225-6)

Zhang, J., Gu, H. D., Zhang, L., Tian, Z. J., Zhang, Z. Q., Shi, X. C., Ma, W. H. 2011. Protective effects of apricot kernel oil on myocardium against ischemia-reperfusion injury in rats. *Food and Chemical Toxicology*, vol. 49, no. 12, p. 3136-3141. <https://doi.org/10.1016/j.fct.2011.08.015> [PMid:21896302](https://doi.org/10.1016/j.fct.2011.08.015)

Acknowledgments:

This work was financially supported by the research projects VEGA, 1/0039/16, KEGA 011SPU-4/2016, APVV-0304-12, and European Community under project no 26220220180: Building Research Centre „AgroBioTech“.

Contact address:

Ing. Anna Kolesárová, PhD., Slovak University of Agriculture in Nitra, Department of Storing and Processing of Plant Products, Faculty of Biotechnology and Food Sciences, Tr. A. Hlinku 2, 949 76 Nitra, E-mail: Anna.Kolesarova@uniag.sk

prof. MVDr. Juraj Pivko, DrSc., Animal Production Research Centre Nitra, National Agricultural and Food Center, Hlohovecká 2, 951 41 Lužianky, Slovak Republic; E-mail: jurajpivko@gmail.com

Ing. Marek Halenár, PhD., Slovak University of Agriculture in Nitra, Department of Animal Physiology, Faculty of Biotechnology and Food Sciences, Tr. A. Hlinku 2, 949 76 Nitra, E-mail: Marek.Halenar@uniag.sk

Ing. Katarína Zbyňovská, PhD., Slovak University of Agriculture in Nitra, Department of Animal Physiology, Faculty of Biotechnology and Food Sciences, Tr. A. Hlinku 2, 949 76 Nitra, E-mail: Katarina.Zbynovska@uniag.sk

Ing. Ľubica Chrastinová, PhD. Animal Production Research Centre Nitra, National Agricultural and Food Center, Hlohovecká 2, 951 41 Lužianky, Slovak Republic; E-mail: chrastinova@vuzv.sk

Ing. Ľubomír Ondruška, PhD., Animal Production Research Centre Nitra, National Agricultural and Food Center, Hlohovecká 2, 951 41 Lužianky, Slovak Republic; E-mail: ondruska@vuzv.sk

MVDr. Rastislav Jurčík, PhD., Animal Production Research Centre Nitra, National Agricultural and Food Center, Hlohovecká 2, 951 41 Lužianky, Slovak Republic; E-mail: jurcik@vuzv.sk

Ing. Jana Kopčeková, PhD., Slovak University of Agriculture in Nitra, Department of Human Nutrition, Faculty of Agrobiology and Food Resources, Tr. A. Hlinku 2, 949 76 Nitra, E-mail: Jana.Kopcekova@uniag.sk

RNDr., Jozef Valuch, CSc., Health Care Surveillance Authority, Želova 2, 829 24 Bratislava, Slovakia, E-mail: dodovaluch@gmail.com

doc. Ing. Adriana Kolesárová, PhD., Slovak University of Agriculture in Nitra, Department of Animal Physiology, Faculty of Biotechnology and Food Sciences, Tr. A. Hlinku 2, 949 76 Nitra, E-mail: Adriana.Kolesarova@uniag.sk



ORAL AND INTRAMUSCULAR APPLICATION OF CYANOGENIC GLYCOSIDE AMYGDALIN DID NOT INDUCE CHANGES IN HAEMATOLOGICAL PROFILE OF MALE RABBITS

Katarína Zbyňovská, Marek Halenár, Ľubica Chrastinová, Ľubomír Ondruška, Rastislav Jurčík, Peter Čupka, Eva Tušimová, Anton Kováčik, Eduard Kolesár, Jozef Valuch, Adriana Kolesárová

ABSTRACT

Amygdalin is a cyanogenic glycoside initially obtained from the seeds of bitter almonds. It is composed of one molecule of benzaldehyde, two molecules of glucose and one molecule of hydrocyanic acid. Various ways of amygdalin application play a different role in recipient organism. Intravenous infusion of amygdalin produced neither cyanidemia nor signs of toxicity, but oral administration resulted in significant blood cyanide levels. The present *in vivo* study was designed to reveal whether amygdalin is able to cause changes in the haematological profile and thus alter the physiological functions, using rabbits as a biological model. Adult male rabbits ($n = 20$) were randomly divided into five groups: the control group without any amygdalin administration, two experimental groups received a daily intramuscular injection of amygdalin at a dose 0.6 and 3.0 mg.kg⁻¹ b.w. and other two groups were fed by crushed apricot seeds at dose 60 and 300 mg. kg⁻¹ b.w., mixed with commercial feed over the period of 14 days. After two weeks, haematological parameters in whole blood were analysed (WBC – total white blood cell count, LYM - lymphocytes count, MID – medium size cell count, GRA – granulocytes count, RBC – red blood cell count, HGB – haemoglobin, HCT – haematocrit, MCV – mean corpuscular volume, MCH – mean corpuscular hemoglobin, MCHC – mean corpuscular hemoglobin concentration, RDWc – red cell distribution width, PLT – platelet count, PCT – platelet percentage, MPV – mean platelet volume, PDWc – platelet distribution width) using haematology analyser Abacus junior VET. Our findings indicate that intramuscular and oral application of amygdalin for two weeks did not significantly affect the haematology parameters in experimental animals. In this study, no obvious beneficial or negative effects of amygdalin administration on the blood of male rabbits were observed.

Keywords: apricot seed; amygdalin; haematology; rabbit

INTRODUCTION

Since ancient times, plants have been exemplary source of medicine (Grover et al., 2002) and have played key roles in traditional health care systems and also form the basis of a significant percentage of allopathic and modern drugs in industrialised nations of the world (Calson, 1998; Samy and Gopalakrishnakone, 2007). Fruit and vegetable contain a significant amount of biologically active substances able to lower a risk of any type of cancer or other civilization diseases (Mendelová et al., 2016; Jakubcova et al., 2014). Cyanogenic glycosides are plant secondary metabolites which consist of an aglycone and a sugar moiety. They are widely distributed in the plant kingdom, being present in more than 2500 plant species. Cyanogenic glycoside amygdalin can be found in plant families of the *Caprifoliaceae*, *Mimosaceae*, *Oleaceae* and *Rosaceae*. It is abundant in the seeds of bitter almond

and apricots of the *Prunus* genus (Vetter, 2000; Fukuda et al., 2003). For more than 40 years, amygdalin has been one of the most popular “alternative cancer cures” in many European and South American countries (Hwang et al., 2008). It has been isolated in 1830 by the French chemists Robiquet and Boutron-Charlard from kernels of the bitter almond (*Prunus amygdalus*) and has been thoroughly investigated in 1837 by Liebig and Wöhler. Its detailed chemical structure was at last established by the carbohydrate chemists Haworth and Wylam in 1923 (Rauws et al., 1982). Amygdalin, is composed of two molecules of glucose, one of benzaldehyde, which induces an analgesic action, and one of hydrocyanic acid, which is an anti-neoplastic compound (Chang et al., 2006). Amygdalin is sometimes confused with laevomandelonitrile, which is commonly known as laetrile. However, amygdalin and laetrile are different chemical

compounds (Andrew et al., 1980; Du et al., 2005). Many studies have reported that amygdalin can be effectively used for prevention and treatment of various diseases including cancers, migraine, chronic inflammation, relieve fever and pain (Fukuda et al., 2003; Yan et al., 2006; Zhou et al., 2012). Still, evidence based research on amygdalin is sparse and its benefit controversial. Proponents consider amygdalin a natural cancer cure, whereas opponents warn that amygdalin is ineffective and even toxic. Although it has been argued that amygdalin is unsafe, no serious acute toxicity has been encountered (Milazzo et al., 2007). Amygdalin itself is non-toxic, but its production of hydrocyanic acid decomposed by some enzymes is poisonous substance (Suchard et al., 1998). *In vivo* the enzyme complex emulsin containing the enzymes β -D-glucosidase, benzocyanase, and others, degrades the amygdalin into four components: hydrocyanic acid, benzaldehyde, prunasin, and mandelonitrile, which are absorbed into the lymph and portal circulations (Chang and Zhang, 2012). Various ways of amygdalin application play a different role in recipient organism, what was confirmed by Moertel et al. (1981), who demonstrated in human, that intravenous infusion of amygdalin produced neither cyanidemia nor signs of toxicity, but oral administration resulted in significant blood cyanide levels. The present *in vivo* study was designed to reveal whether amygdalin is able to cause changes in the haematological profile and thus alter the physiological functions, using rabbits as a biological model.

MATERIAL AND METHODOLOGY

Chemicals

Amygdalin from apricot kernels ($\geq 99\%$ purity) was purchased from Sigma-Aldrich (St. Louis, MO, USA). Amygdalin was freshly dissolved in sterile saline and 0.5 ml were applied intramuscularly (IM) to musculus biceps femoris on a daily basis. Bitter apricot seeds were provided by Trasco (Žiar n. Hronom, Slovakia). Thin Layer Chromatography (TLC) was performed for the analysis of amygdalin content in bitter apricot seeds used in our experiment. Grinded apricot seeds (2 g) were mixed with

10 mL of methanol in a vial and put into ultrasonic bath for 30 minutes at 55°C. After cooling, 10 μ L of solution was applied onto TLC plates Kieselgel UV 254 20x20 cm (Merck KGaA, Darmstadt, Germany). Mixture of n-butanol, acetic acid and water (95 : 5 : 25) was used as a mobile phase. Separation took about 5 hours at room temperature. After separation, amygdalin content was determined by UV densitometer CS – 9000 (Shimadzu, Japan) at 205 nm. An external standard was used (1% amygdalin solution in methanol). Crude protein content was performed according to Kjeldahl (1883), fat content was determined using Soxhlet method for fat extraction (1879) and crude fibre by Henneberg-Stohmann method. Amount of starch was measured via polarimetry and total sugars by Luff-Schoorl titration. Organic composition of the apricot seeds is shown in Table 1.

Animals

Male rabbits (n = 20), meat line P91 Californian from the experimental farm of the Animal Production Research Centre Nitra (Slovak Republic) were used in the experiment. The rabbits were 150 days old, weighing 4.00 \pm 0.5 kg, and were housed in individual flat-deck wire cages under a constant photoperiod of 12 h of daylight, temperature 20 – 24 °C and humidity 55% \pm 10%. The rabbits were fed a standard commercially available feed (Table 2) based on a pelleted concentrate. Animals had free access to feed and water during the study period and no toxic or side effects or death were observed throughout the study. The animals were randomly divided into the five groups, leading to 4 male rabbits in each group. The control group received no amygdalin while the two experimental groups E1 and E2 received a daily intramuscular injection of amygdalin at a dose 0.6 and 3.0 mg.kg⁻¹ b.w. respectively during 14 days. The experimental groups E3 and E4 were fed by crushed apricot seeds, at dose 60 and 300 mg.kg⁻¹ b.w., mixed with commercial feed for rabbits during the same period. Institutional and national guidelines for the care and use of animals were followed appropriately, and all experimental procedures were approved by the State Veterinary and

Table 1 Organic content in apricot seeds (%).

Dry mater	Amygdalin	Crude protein	Fat	Fiber	Starch	Sugar
95.9	5.2	22.8	39.7	28.5	2.3	6.3

Table 2 Chemical composition (g.kg⁻¹) of the experimental diet.

Component	
Dry matter	926.26
Crude protein	192.06
Fat	36.08
Fibre	135.79
Non-nitrogen compounds	483.56
Ash	78.78
Organic matter	847.49
Calcium	9.73
Phosphorus	6.84
Magnesium	2.77
Sodium	1.81
Potassium	10.94
Metabolizable energy	12.35 MJ.kg ⁻¹

Food Institute of Slovak Republic, no. 3398/11-221/3 and Ethic Committee.

Blood sample collection and haematology analysis

Blood samples from *vena auricularis* were taken to tubes treatment with EDTA from all animals by macromethods after two weeks of experiment. In whole blood, haematological parameters were analysed (WBC – total white blood cell count, LYM – lymphocytes count, MID – medium size cell count, GRA – granulocytes count, RBC – red blood cell count, HGB – haemoglobin, HCT – haematocrit, MCV – mean corpuscular volume, MCH – mean corpuscular hemoglobin, MCHC – mean corpuscular hemoglobin concentration, RDWc – red cell distribution width, PLT – platelet count, PCT – platelet percentage, MPV – mean platelet volume, PDWc – platelet distribution width) using haematology analyser Abacus junior VET (Diatron MI Ltd., Budapest, Hungary). The impedance method counts and sizes cells by detecting and measuring changes in electrical impedance when a particle in a conductive liquid passes through a small aperture. Each cell passing through the aperture – where a constant DC current flows between the external and internal electrodes – causes some change in the impedance of the conductive blood cell suspension. These changes are recorded as increases in the voltage between the electrodes. The number of pulses is proportional to the number of particles. The intensity of each pulse is proportional to the volume of that particle.

Statistical analysis

The data used for statistical analysis represent means of values obtained in blood collection. To compare the results, one-way ANOVA test was applied to calculate basic statistic characteristics and to determine significant differences among the experimental and control groups. Statistical software SIGMA PLOT 12.0 (Jandel, Corte Madera, CA, USA) was used. Differences was compared for statistical significance at the levels $p < 0.001$, 0.01 and 0.05.

RESULTS AND DISCUSSION

Natural plant origin products like amygdalin are still a major part of traditional medicine. However, its effect on animal and human organisms is still not clear. (Nabavizadeh et al., 2011; Kovacova et al., 2016). It has been used as a traditional drug because of its wide range of medicinal benefits, including curing or preventing cancer, relieving fever, suppressing cough, and quenching thirst (Zhou et al., 2012). In addition, it can be used as a cerebral function improver that is effective as a therapeutic agent for cerebrovascular lesions such as psychogenic symptoms, nerve symptoms, subjective symptoms, and daily life activity disorder (Hiromi, 1995). Previous studies on amygdalin have focused on its purification, toxicity related to the release of cyanide, anti-tumor mechanism, and identification of its metabolites in plasma or herbs, and its pharmacological effect on cancers (Rauws et al., 1982; Yildirim and Askin, 2010; Makarević et al., 2014). It has been known that the harmful effects of amygdalin are directly related to the toxicity of cyanide, which is released following hydrolysis

of the parent compound (Newton et al., 1981). Haematological studies have been found useful for disease prognosis and for the therapeutic and feed stress monitoring (Togun and Oseni, 2005). Haematological studies are important because the blood is the major transport system of the body, and evaluations of the haematological profile usually furnishes vital information on the body's response to injury of all forms, including toxic injury (Schalm et al., 1975; Coles, 1986; Ihedioha et al., 2004). Haematological studies represent an useful process in the diagnosis of many diseases as well as investigation of the extent of damage to the blood (Onyeyili et al., 1991). There are just a few studies of blood chemistry changes and changes in haematology profile after amygdalin administration *in vivo*. Our previous study did not confirm a negative effect on the energetic and hepatic profile of rabbits *in vivo* (Tušimová et al., 2016a, Tušimová et al., 2016b). At the beginning of the experiment, before treatment with amygdalin and apricot seeds, all haematological parameters were in physiological range. On base of these results we could state that all animals were in good health condition. Haematological parameters of rabbits after two weeks of oral and intramuscular application of amygdalin are shown in Table 3.

The highest count of WBC was observed in E4 group where rabbits were fed by crushed apricot seeds, at dose 300 mg.kg⁻¹ b.w., mixed with commercial feed (equivalent to 15.6 mg.kg⁻¹ of amygdalin, equivalent to 0.92 mg.kg⁻¹ of HCN – hydrogen cyanide). In this group we also observed the highest count of MID among the groups. In case of GRA we found lower count of this kind of cells in all experimental groups in comparison with the control group. However the results were not significant and they were in physiological reference range for WBC, MID and GRA in rabbit blood. The total WBC can be used to further characterize acute stress from chronic stress (e.g., malnutrition, improper husbandry, prolonged social stress, dental disease), as both a leukopenia and lymphopenia are more common with chronic stress (Melillo, 2007). Higher WBC count may explain the reason for disease resistance which has been reported by Nwosu (1979) or the prevalence of disease condition. It may also explain longevity as reported by Mbanasor et al. (2003). Lower count of GRA could be caused in acute inflammation, acute infection and intoxication (Vrzgula et al., 1990). Olafadehan et al. (2010) carried out a study on the effect of residual cyanide in processed cassava peel meal on haematological indices of growing rabbits and observed that with exception of neutrophil and eosinophil, other haematological parameters were significantly affected by the dietary treatments. Amygdalin can significantly increase polyhydroxyalkanoates (PHA) induced human peripheral blood T lymphocyte proliferation and can promote peripheral blood lymphocytes stimulated by PHA secrete IL-2 and IFN-g, and then inhibit the secretion of TGF-β1, therefore enhance immune function (Baroni et al., 2005). Amygdalin plays a positive role in the expression of regulatory T-cells in the treatment of atherosclerosis, and can also expand the lumen area, reduce aortic plaque coverage (Jiagang et al., 2011; Perez, 2013). In our *in vivo* study, the highest LYM count in rabbit blood after addition of amygdalin was observed

Table 3 Haematological parameters of rabbits after oral and intramuscular application of amygdalin.

Parameter	C	E1	E2	E3	E4
WBC ($10^9.L^{-1}$)	10.78 \pm 3.21	11.12 \pm 0.97	11.01 \pm 1.85	10.67 \pm 2.54	12.29 \pm 3.92
LYM ($10^9.L^{-1}$)	2.91 \pm 0.90	3.16 \pm 0.75	4.31 \pm 0.71	3.36 \pm 0.89	2.85 \pm 1.20
MID ($10^9.L^{-1}$)	0.36 \pm 0.21	0.70 \pm 0.41	0.45 \pm 0.28	0.62 \pm 0.37	1.15 \pm 0.44
GRA ($10^9.L^{-1}$)	7.51 \pm 2.87	6.83 \pm 2.59	5.60 \pm 2.44	6.70 \pm 2.43	6.78 \pm 0.83
RBC ($10^{12}.L^{-1}$)	7.11 \pm 0.22	7.00 \pm 0.28	6.40 \pm 0.25	6.89 \pm 0.36	6.72 \pm 0.38
HGB (g.L ⁻¹)	135.8 \pm 11.79	137.3 \pm 8.66	130.3 \pm 4.43	132.3 \pm 3.60	132.3 \pm 4.79
HCT (%)	43.97 \pm 3.03	43.10 \pm 2.56	41.53 \pm 1.88	42.26 \pm 0.68	42.40 \pm 1.42
MCV (fl)	61.75 \pm 2.63	61.50 \pm 2.08	64.75 \pm 2.06	61.25 \pm 2.75	63.00 \pm 2.16
MCH (pg)	19.05 \pm 1.17	19.63 \pm 0.77	20.33 \pm 0.19	19.30 \pm 0.80	19.70 \pm 0.96
MCHC (g.L ⁻¹)	308.2 \pm 6.60	318.5 \pm 5.45	313.5 \pm 11.48	314.0 \pm 10.23	311.5 \pm 3.70
RDWc (%)	16.28 \pm 0.92	16.08 \pm 0.33	15.88 \pm 0.71	16.73 \pm 1.41	16.25 \pm 0.81
PLT ($10^9.L^{-1}$)	313.8 \pm 106.8	285.0 \pm 149.5	326.0 \pm 106.9	171.0 \pm 59.8	252.75 \pm 108.4
PCT	0.23 \pm 0.07	0.21 \pm 0.09	0.23 \pm 0.05	0.13 \pm 0.04	0.19 \pm 0.07
MPV (fl)	7.30 \pm 0.22	7.40 \pm 0.56	7.23 \pm 0.74	7.30 \pm 0.44	7.38 \pm 0.67
PDWc (%)	35.35 \pm 0.58	34.50 \pm 1.66	34.80 \pm 1.61	35.03 \pm 1.20	35.28 \pm 2.10

Note: WBC, total white blood cell count; LYM, lymphocytes count; MID, medium-size cell count; GRA, granulocytes count; RBC, red blood cell count; HGB, hemoglobin; HCT, hematocrit; MCV, mean corpuscular volume; MCH, mean corpuscular hemoglobin; MCHC, mean corpuscular hemoglobin concentration; RDWc, red cell distribution width; PLT, platelet count; PCT, platelet percentage; MPV, mean platelet volume; PDWc, platelet distribution width. C – control group, without addition of amygdalin; E1 and E2 experimental groups - intramuscular injection of amygdalin at a dose 0.6 and 3.0 mg.kg⁻¹ b.w.; E3 and E4 experimental groups - crushed apricot seeds, at dose 60 and 300 mg.kg⁻¹ b.w. The values shown are the mean \pm SD (standard deviation).

in E2 experimental group when compared with the control and with the other experimental groups but the results were not significant. In E2 experimental group animal received amygdalin intramuscularly in concentration 3 mg.kg⁻¹ b.w. (equivalent to 0.177 mg.kg⁻¹ of HCN). Higher count of LYM may be due to intoxication and chronic infectious diseases (Vrzgula et al., 1990). RBC count, content of HGB and HCT in rabbit blood were not significantly affected by treatment with amygdalin however the values of these parameters were the lowest in E2 experimental groups, when compared with the control and the other experimental groups. This values were still in physiological reference range for RBC, HGB and HCT in rabbit blood. In another fourteen-day toxicity study in rats HGB significantly increased after treatment with 20 mg.kg⁻¹ of amygdalin (Oyewole and Olayinka, 2009). Lower values of RBC, HGB and HCT may indicate anemia (Melillo, 2007). The lowest count of PLT and the lowest value of PCT were observed in E3 experimental group among the groups. In this group animals received apricot seeds in concentration 60 mg.kg⁻¹ b.w. in rabbit feed (equivalent to 3.12 mg.kg⁻¹ of amygdalin, equivalent to 0.184 mg.kg⁻¹ of HCN). These results were not significant and the values of this parameters were in physiological reference range. Liu et al. (2012) observed that Taoren–Honghua herb (TH) and its main components amygdalin and HSYA (hydroxysafflor yellow A) could significantly reduce platelet aggregation and protect vascular endothelial cells. Based on these results, amygdalin and HSYA were responsible for the main curative effects of TH and usually had synergetic effects, such as decreasing platelet aggregation percentage. Platelet aggregation is thought to be one of the factors that determine blood viscosity (Ryu et al., 2009). Lower count of PLT may be due to intoxication (Vrzgula et al., 1990). We did not observe any changes in the other analysed haematological parameters. In two feeding experiments (respectively 63 and 56 days) one day old broiler chickens

(male and female) were fed a diet containing 0, 10, 20 or 30% cassava, respectively. Cassava also contains cyanogenic glycosides. The animals were studied for haematological and histopathological effects. No changes in the haematological parameters due to cassava were seen (Gomez et al., 1988).

No clinical signs were observed in short-term studies and changes in haematology were minor, sporadic and not dose related. In none of the reported short-term studies was mortality observed at doses up to 40 mg cyanide.kg⁻¹ b.w. per day, even though some of the doses were equal to or higher than the oral LD50 for cyanide. Since in the short-term studies analysed, cyanide was administered through the diet or drinking water, absence of mortality is possibly due to a slower absorption rate following dietary exposure, thus not exhausting the detoxification capacity of the enzyme rhodanese, which occurs after bolus administration in LD50 tests (Hayes, 1967; US EPA, 2010). Acute oral median lethal dose (LD50) values for cyanide in laboratory animals range from 2.13 to 6 mg.kg⁻¹ b.w. (EFSA, 2016). As a result of the occurrence of cyanide in food originating from flavouring substances, the Council of Europe (CoE, 2000) reviewed cyanide toxicity and established a Tolerable Daily Intake (TDI). JECFA (FAO/WHO, 2012) established a Provisional Maximum Tolerable Daily Intake (PMTDI) of 20 μ g.kg⁻¹ b.w. of CN (cyanide) based on findings in a 13-week toxicity study on sodium cyanide conducted by the US National Toxicology Program (NTP).

CONCLUSION

Our findings indicate that intramuscular and oral application of amygdalin for two weeks did not significantly affect the haematology parameters in experimental animals. In this study, no obvious beneficial or negative effects of amygdalin administration on the blood of male rabbits were observed. Given that amygdalin is occurring cyanogenic glycoside in food with

the possible therapeutic effects and there are not many in vivo studies about its effects on biochemical and haematological parameters in blood, thus it is necessary to be examined further.

REFERENCES

- Andrew, F., Roscoe, O. B., Anrew, E. G. 1980. A β -glucosidase in feline kidney that hydrolyzes amygdalin (Laetrile). *Archives of Biochemistry and Biophysics*, vol. 201, no. 2, p. 363-368.
- Baroni, A., Paoletti, I., Greco, R., Satriano, R. A., Ruocco, E., Tufano, M. A., Perez, J. J. 2005. Immunomodulatory effects of a set of amygdalin analogues in human keratinocyte cells. *Experimental Dermatology*, vol. 14, no. 11, p. 854-859. <https://doi.org/10.1111/j.1600-0625.2005.00368.x> PMID:16232308
- Calson, I. J. S. 1998. Ethnomedical field research, medicinal plants and tropical public health. *Rainforest Med. Bulletin*, vol. 5, no. 1, p. 8-15.
- CoE, 2000. Council of Europe Committee of Experts on Flavouring Substances 46th meeting-RD 4.13/1-46 data sheet on HCN.
- Coles, E. H. 1974. *Veterinary clinical pathology*. St. LOUIS, USA : W.B. Saunders Company. 615 p. ISBN: 0721626416.
- Du, Q., Jerz, G., He, Y., Li, L., Xu, Y., Zhang, Q., Zheng, Q., Winterhalter, P., Ito, Y. 2005. Semi-industrial isolation of salicin and amygdalin from plant extracts using slow rotary counter-current chromatography. *Journal of Chromatography A*, vol. 107, no. 1-3, p. 43-46. <https://doi.org/10.1016/j.chroma.2005.03.064>
- FAO/WHO (Food and Agricultural Organization/World Health Organization), 2012. Safety evaluation of certain food additives and contaminants prepared by the seventy-fourth meeting of the joint FAO/WHO expert committee.
- Fukuda, T., Ito, H., Mukainaka, T., Tokuda, H., Nishino, H., Yoshida, T. 2003. Anti-tumor promoting effect of glycosides from *Prunus persica* seeds. *Biological and Pharmaceutical Bulletin*, vol. 26, no. 2, p. 271-273. <https://doi.org/10.1248/bpb.26.271> PMID:12576693
- Gomez, G., Aparicio, M. A., Wilolhite, C. C. 1988. Relationship between dietary cassava cyanide levels and Brailer performance. *Nutrition Reports International*, vol. 37, p. 63-75.
- Grover, J. K., Yadav, S., Vats, V. 2002. Medicinal plants of India with antidiabetic potential. *Journal of Ethnopharmacology*, vol. 81, no. 1, p. 81-100. [https://doi.org/10.1016/S0378-8741\(02\)00059-4](https://doi.org/10.1016/S0378-8741(02)00059-4)
- Hayes, W. J. 1967. The 90 day LD50 and chronicity factors as a measure of toxicity. *Toxicology and Applied Pharmacology*, vol. 11, no. 2, p. 327-335. [https://doi.org/10.1016/0041-008X\(67\)90076-2](https://doi.org/10.1016/0041-008X(67)90076-2)
- Henneberg, W., Stohmann, F. 1860-1864. Beiträge zur Begründung einer rationellen Fütterung der Wiederkäuer I & II. Braunschweig. German : Braunschweig.
- Cerebral function improver. Patent owner Hiromi, S. Patent no. JP 7,165,589.
- Hwang, H. J., Lee, H. J., Kim, Ch. J., Shim, I., Hahm, D. H. 2008. Inhibitory effect of amygdalin on lipopolysaccharide-inducible TNF- α and IL-1 β mRNA expression and carrageenan-induced rats arthritis. *Journal of Microbiology and Biotechnology*, vol. 18, no. 10, p. 1641-1647. PMID:18955812
- Chang, H. K., Shin, M. S., Yang, H. Y., Lee, J. W., Kim, Y. S., Lee, M. H., Kim, J., Kim, K. H., Kim, C. J. 2006. Amygdalin Induces Apoptosis through Regulation of Bax and Bcl-2 Expressions in Human DU145 and LNCaP Prostate Cancer Cells. *Biological and Pharmaceutical Bulletin*, vol. 29, no. 8, p. 1597-1602. <https://doi.org/10.1248/bpb.29.1597> PMID:16880611
- Chang, J., Zhang, Y. 2012. Catalytic degradation of amygdalin by extracellular enzymes from *Aspergillus niger*. *Process Biochemistry*, vol. 47, no. 2, p. 195-200. <https://doi.org/10.1016/j.procbio.2011.10.030>
- Ihedioha, J. T., Okafor, C., Ihedioha, T. E. 2004. The haematological profile of the Sprague Dawley out bred albino rat in Nsukka. *Animal Research International*, vol. 1, no. 2, p. 125-132.
- Jakubcova, Z., Zeman, L., Mares, P., Mlcek, J., Jurikova T., Dostalova, L., Mrazkova, E., Mrkvicova, E., Balla, S., Sochor, J. 2014. Effect of chamomile supplements to feeding doses on antimicrobial parameters in poultry. *Potravinárstvo*, vol. 8, no. 1, p. 228-232. <https://doi.org/10.5219/383>
- Jiangang, D., Li, C., Wang, H., Hao, E., Du, Z., Bao, C., Jianzhen, L., Wang, Y. 2011. Amygdalin mediates relieved atherosclerosis in apolipoprotein E deficient mice through the induction of regulatory T cells. *Biochemical and Biophysical Research Communication*, vol. 411, no. 3, p. 523-529. <https://doi.org/10.1016/j.bbrc.2011.06.162> PMID:21756879
- Kjeldahl, J. 1883. New method for the determination of nitrogen in organic substances. *Zeitschrift für analytische Chemie*, vol. 22, no. 1, p. 366-383. <https://doi.org/10.1007/BF01338151>
- Kovacova, V., Omelka, R., Sarocka, A., Sranko, P., Adamkovicova, M., Toman, R., Halenar, M., Kolesarova, A., Martiniakova, M. 2016. Histological analysis of femoral bones in rabbits administered by amygdalin. *Potravinárstvo*, vol. 10, no. 1, p. 393-399. <https://dx.doi.org/10.5219/625>
- Liu, L., Duan, J., Tang, Y., Guo, J., Yang, N., Ma, H., Shi, X. 2012. Taoren-Honghua herb pair and its main components promoting blood circulation through influencing on hemorheology, plasma coagulation and platelet aggregation. *Journal of Ethnopharmacology*, vol. 139, no. 2, p. 381-387. <https://doi.org/10.1016/j.jep.2011.11.016> PMID:22123200
- Makarević, J., Rutz, J., Juengel, E., Kaulfuss, S., Reiter, M., Tsaour, I., Bartsch, G., Haferkamp, A., Blaheta, R. A. 2014. Amygdalin blocks bladder cancer cell growth in vitro by diminishing cyclin A and cdk2. *PLoS ONE*, vol. 9, no. 8, p. 1-9. <https://doi.org/10.1371/journal.pone.0105590> PMID:25136960
- Mbanasor, U. U., Anene, B. M., Chiniezie, A. B., Nnaji, T. O., Eze, J. I., Ezekwe, A. G. 2003. Haematology of normal trypanosome infected muturu cattle in South-Eastern Nigeria. *Nigerian Journal of Animal Production*, vol. 30, no. 2, p. 236-241. <https://doi.org/10.4314/njap.v30i2.3300>
- Melillo, A. 2007. Rabbit clinical pathology. *Journal of Exotic Pet Medicine*, vol. 16, no. 3, p. 135-145. <https://doi.org/10.1053/j.jepm.2007.06.002>
- Mendelová, A., Mendel, L., Czako, P., Mareček, J. 2016. Evaluation of carotenoids, polyphenols content and antioxidant activity in the sea buckthorn fruit juice. *Potravinárstvo*, vol. 10, no. 1, p. 59-64. <https://doi.org/10.5219/551>
- Milazzo, S., Lejeune, S., Ernst, E. 2007. Laetrile for cancer: a systematic review of the clinical evidence. *Support Care Cancer*, vol. 15, no. 6, p. 583-595. <https://doi.org/10.1007/s00520-006-0168-9> PMID:17106659

- Moertel, C. G., Ames, M. M., Kovach, J. S., Moyer, T. P., Rubin, J. R., Tinker, J. H. 1981. A pharmacologic and toxicological study of amygdalin. *JAMA*, vol. 245, no. 6, p. 591-594. <https://doi.org/10.1001/jama.1981.03310310033018> PMID:7005480
- Nabavizadeh, F., Alizadeh, A. M., Sadroleslami, Z., Adeli, S. 2011. Gastroprotective effects of amygdalin on experimental gastric ulcer: Role of NO and TNF- α . *Journal of Medical Plants Research*, vol. 5, no. 14, p. 3122-3127.
- Newton, G. W., Schmidt, E. S., Lewis, J. P., Conn, E., Lawrence, L. 1981. Amygdalin toxicity studies in rats predict chronic cyanide poisoning in humans. *The western Journal of Medicine*, vol. 134, no. 2, p. 97-103. PMID:7222669
- Nwosu, C. C. 1979. Characteristics of local chicken of Nigeria and its potential for egg and meat production. In *Poultry Production in Nigeria, 1st National Seminar on Poultry Production*. Nigeria, Zaria.
- Olafedehan, C. O., Obun, A. M., Yusuf, M. K., Adewumi, O. O., Olafedehan, A. O., Awofolaji, A. O., Adeniji, A. A. 2010. Effects of residual cyanide in processed cassava peel meals on haematological and biochemical indices of growing rabbits. In *35th Annual Conference of the Nigerian Society for Animal Production*. Nigeria : University of Ibadan, p. 212.
- Onyeyili, P. A., Egwu, G. O., Jibike, G. I., Pepple, O. J., Gbaegbulan, J. O. 1991. Seasonal variation in haematological indices in the grey breasted guinea fowl (*Numida mealagris Gallata pallatas*). *Nigerian Journal of Animal Production*, vol. 18, no. 2, p. 108-111.
- Oyewole, O. I., Olayinka, E. T. 2009. Hydroxocobalamin (vit b12a) effectively reduced extent of cyanide poisoning arising from oral amygdalin ingestion in rats. *Journal of Toxicology Environmental Health Science*, vol. 1, no. 1, p. 8-11.
- Perrez, J. J. 2013. Amygdalin analogs for the treatment of psoriasis. *Future Medicinal Chemistry*, vol. 5, no. 7, p. 799-808. <https://doi.org/10.4155/fmc.13.27> PMID:23651093
- Rauws, A. G., Olling, M., Timmerman, A. 1982. The pharmacokinetics of amygdalin. *Archive of Toxicology*, vol. 49, no. 3, p. 311-312. <https://doi.org/10.1007/BF00347879> PMID:7092570
- Ryu, K. H., Han, H. Y., Lee, S. Y., Jeon, S. D., Im, G. J., Lee, B. Y., Kim, K., Lim, K. M., Chung, J. H., 2009. Ginkgo biloba extract enhances antiplatelet and antithrombotic effects of cilostazol without prolongation of bleeding time. *Thrombosis Research*, vol. 124, no. 3, p. 328-334. <https://doi.org/10.1016/j.thromres.2009.02.010> PMID:19349067
- Samy, R. P., Gopalakrishnakone, P. 2007. Current status of herbals and their future perspective. *Nature Preceding*, vol. 7, no. 28, p. 1-13.
- Schalm, O. W., Jain, N. C., Carroll, E. J. 1975. *Veterinary haematology*. Philadelphia, USA : Lea and Fabiger. 368p. ISBN 9781437701739.
- Soxhlet, F. 1879. Die gewichtsanalytische Bestimmung des Milchfettes. *Dinglers Polytechnisches Journal*, vol. 232, p. 461-465.
- Suchard, J. R., Wallace, K. L., Gerkin, R. D. 1998. Acute cyanide toxicity caused by apricot kernel ingestion. *Annals of emergency medicine*, vol. 32, no. 6, p. 742-744. [https://doi.org/10.1016/S0196-0644\(98\)70077-0](https://doi.org/10.1016/S0196-0644(98)70077-0)
- Togun, V. A., Oseni, B. S. A., Ogundipe, J. A., Arewa, T. R., Hammed, A. A., Ajonijebu, D. C., Oyeniran, A., Nwosisi, I. Mustapha, F. 2007. Effects of chronic lead administration on the haematological parameters of rabbit – a preliminary study. In *41st Conference of the Agriculture Society of Nigeria*, Abeokuta, Ogun State, p. 341.
- Tušimová, E., Kováčik, A., Halenár, M., Zbyňovská, K., Chrastinová, L., Ondruška, L., Jurčík, R., Kolesár, E., Kolesárová, A. 2016a. Energetic profile of rabbits after amygdalin administration. *Journal of Microbiology, Biotechnology and Food Sciences*, vol. 5, special no. 1, p. 50-52.
- Tušimová, E., Kováčik, A., Halenár, M., Zbyňovská, K., Tomková, M., Tirpák, F., Chrastinová, L., Ondruška, L., Jurčík, R., Kolesár, E., Kolesárová, A. 2016b. Hepatic profile of female rabbits after amygdalin administration. In *12th International Scientific Conference Animal Physiology*. Bořetice : Mendel University in Brno, p. 253-259. ISBN 978-80-7509-416-2.
- US EPA (US Environmental Protection Agency), 2010. Toxicological review of hydrogen cyanide and cyanide salts (CAS No. various) in support of summary information on the Integrated Risk Information System (IRIS). Washington, DC, USA : Environmental Protection Agency.
- Vetter, V. 2000. Plant cyanogenic glycosides. Review. *Toxicon: Official Journal of the International Society on Toxicology*, vol. 38, no. 1, p. 11-36. [https://doi.org/10.1016/S0041-0101\(99\)00128-2](https://doi.org/10.1016/S0041-0101(99)00128-2)
- Vrzgula, L. 1990. *Poruchy látkového metabolizmu hospodárskych zvierat a ich prevencia (Animal metabolism disorders and their prevention)*. Bratislava, Slovakia : Príroda. 503 p. ISBN 80-07-00256-1.
- Yan, J., Tong, S., Li, J., Lou, J. 2006. Preparative Isolation and Purification of Amygdalin from *Prunus armeniaca* L. with High Recovery by High-Speed Countercurrent Chromatography. *Journal of Liquid Chromatography & Related Technologies*, vol. 29, no. 9, p. 1271-1279. <https://doi.org/10.1080/10826070600598985>
- Yildirim, F. A., Askin, M. A. 2010. Variability of amygdalin content in seeds of sweet or bitter apricot cultivars in Turkey. *African Journal of Biotechnology*, vol. 9, no. 39, p. 6522-6524.
- Zhou, C. G., Qian, L., Ma, H., Yu, X., Zhang, Y., Qu, W., Zhang, X., Xia, W. 2012. Enhancement of amygdalin activated with β -D-glucosidase on HepG2 cells proliferation and apoptosis. *Carbohydrate Polymers*, vol. 90, no. 1, p. 516-523. <https://doi.org/10.1016/j.carbpol.2012.05.073> PMID:24751072

Acknowledgments:

This work was financially supported by the Ministry of Education, Science, Research and Sport of the Slovak Republic projects no. 1/0039/16, 011SPU-4/2016 KEGA, APVV-0304-12, APVV 15-0543 and European Community under project no. 26220220180: Building Research Centre „AgroBioTech“.

Contact address:

Katarína Zbyňovská, Slovak University of Agriculture, Faculty of Biotechnology and Food Sciences, Department of Animal Physiology, Tr. A. Hlinku 2, 949 76 Nitra, Slovakia, E-mail: zbynovska.katarina@gmail.com

Marek Halenár, Slovak University of Agriculture, Faculty of Biotechnology and Food Sciences, Department of Animal Physiology, Tr. A. Hlinku 2, 949 76 Nitra, Slovakia, E-mail: marek.halenar@uniag.sk

Lubica Chrastinová, National Agricultural and Food Center, Animal Production Research Centre Nitra, Hlohovecká 2, 951 41 Lužianky, Slovakia, E-mail: chrastinova@vuzv.sk

Lubomír Ondruška, National Agricultural and Food Center, Animal Production Research Centre Nitra, Hlohovecká 2, 951 41 Lužianky, Slovakia, E-mail: ondruska@vuzv.sk

Rastislav Jurčík, National Agricultural and Food Center, Animal Production Research Centre Nitra, Hlohovecká 2, 951 41 Lužianky, Slovakia, E-mail: jurcik@vuzv.sk

Peter Čupka, Slovak University of Agriculture, Faculty of Biotechnology and Food Sciences, Department of Animal Physiology, Tr. A. Hlinku 2, 949 76 Nitra, Slovakia, E-mail: peter.cupka@uniag.sk

Eva Tušimová, Research Centre AgroBioTech, Slovak University of Agriculture in Nitra, Tr. A. Hlinku 2, 949 76 Nitra, Slovakia, E-mail: eva.tusimova@uniag.sk

Anton Kováčik, Slovak University of Agriculture, Faculty of Biotechnology and Food Sciences, Department of Animal Physiology, Tr. A. Hlinku 2, 949 76 Nitra, Slovakia, E-mail: anton.kovacik@uniag.sk

Eduard Kolesár, Slovak University of Agriculture, Faculty of Biotechnology and Food Sciences, Department of Animal Physiology, Tr. A. Hlinku 2, 949 76 Nitra, Slovakia, E-mail: xkolesar@is.uniag.sk

Jozef Valuch, Health Care Surveillance Authority, Želova 2, 829 24 Bratislava, Slovakia, E-mail: dodovaluch@gmail.com

Adriana Kolesárová, Slovak University of Agriculture, Faculty of Biotechnology and Food Sciences, Department of Animal Physiology, Tr. A. Hlinku 2, 949 76 Nitra, Slovakia, E-mail: adriana.kolesarova@uniag.sk



INFLUENCE OF ESSENTIAL OILS ON THE GROWTH OF *ASPERGILLUS FLAVUS*

Denisa Foltinová, Dana Tančinová, Miroslava Císarová

ABSTRACT

This paper was focused on the determination of the inhibitory effect of selected essential oils on growth of ten isolates of *Aspergillus flavus* and their potential ability to produce mycotoxins *in vitro* by TLC method. The isolates were obtained from moldy bread of domestic origin. We followed the impact of five essential oils at 100% concentration – lemon, eucalyptus, oregano, sage and thyme. The effect of the essential oils we tested the gaseous diffusion method. We isolates grown on CYA (Czapek yeast extract agar), in the dark at 25 ± 1 °C, 14 days. The diameter of colonies grown we continuously measured on the 3rd, 7th, 11th, and 14th day of cultivation. The results of the paper suggest that oregano and thyme essential oil had 100% inhibited the growth of all tested isolates of *Aspergillus flavus*. Lemon, eucalyptus and sage essential oil had not significant inhibitory effects on tested isolates *Aspergillus flavus*, but affected the growth of colonies throughout the cultivation. In addition to the inhibitory effect we witnessed the stimulative effect of lemon, eucalyptus and sage essential oil to some isolates. Together with the antifungal effect of essential oils, we monitored the ability of *Aspergillus flavus* isolates to produce mycotoxins – aflatoxin B₁ (AFB₁) and cyclopiazonic acid (CPA) in the presence of essential oils. Production mycotoxins we have seen in the last (14th) day of cultivation. Lemon and eucalyptus essential oil did not affect the production of mycotoxins. In the case of sage essential oil we were recorded cyclopiazonic acid production in three of the ten isolates from the all three repetitions, while neither isolate did not produced aflatoxin B₁. The production of secondary metabolites was detected in all control samples. From the results we can say that oregano and thyme essential oil could be used as a natural preservative useful in the food industry.

Keywords: essential oils; inhibitory effect; *Aspergillus flavus*; mycotoxins

INTRODUCTION

Microscopic filamentous fungi are significant destroyers of foodstuffs during storage, rendering them unfit for human consumption by retard their nutritive value and sometimes by producing mycotoxins (Kumar et al., 2007). The present and growth of fungi in food may cause spoilage and result in a reduction in quality and quantity (Baratta et al., 2008).

Mold growth on bakery products during storage is a serious economic problem. Mold spoilage of bakery products has been the subject of many studies and a number of species have been implicated. The mold frequently involved are *Penicillium*, *Aspergillus*, *Eurotium* and *Walemia* species (Dantigny et al., 2005).

In addition to the economic losses associated with bakery products, another concern is the possibility of mycotoxin production. Therefore, the presence of toxinogenic fungi and mycotoxins in food and grains stored for long periods of time present a potential hazard to human and animal health. Improper storage conditions offer favorable environment for the growth of *Aspergillus* spp. Some

species such as *Aspergillus flavus* can produce toxic secondary metabolites: like aflatoxins, ochratoxins, cyclopiazonic acid and they affect the food safety (Pardo et al., 2006).

Management of food stuffs contaminations are required to ensure that food commodities remain safe and uncontaminated throughout the supply chain (from 'farm to plate'). Several synthetic preservatives have been effectively used in management of food contamination by *Aspergillus* spp. (Leslie et al., 2008). Effectively, the use of synthetic chemicals to control food deterioration has been restricted because of their carcinogenicity, teratogenicity, high and acute residual toxicity, and other effects on food and humans (Tripathy and Dubey, 2004).

This negative consumer perception of chemical preservatives drives attention towards natural alternatives (Sharma and Tripathi, 2008). Due to an increasing risk of chemical contamination upon the application of synthetic fungicides to preserve fresh fruits and vegetables, essential oils are gaining increasing attention (Farzaneh et al., 2015). Essential oils are aromatic and

volatile liquids extracted from plants. Essential oils from plants have a broad spectrum of antifungal activity (Yamamoto-Ribeiro et al., 2013). Natural antimicrobial or antifungal substances are promising to replace these synthetic fungicides. The chemicals in essential oils are secondary metabolites, which play an important role in plant defense as they often possess antimicrobial properties (Hyldgaard et al., 2012).

European Union allowed the use of EOs in food and aromatherapy. So, EOs with antimicrobial activity are possible candidates for the preservation of food commodities against *Aspergillus* spp (Razzaghi-Abyaneh et al., 2009). This study was undertaken to investigate the *in vitro* inhibitory effects of selected essential oils on the growth of *Aspergillus flavus* isolates. Together with the antifungal activity of essential oils we determined the ability of *Aspergillus flavus* isolates produce mycotoxins – aflatoxin B₁ and cyclopiazonic acid.

MATERIAL AND METHODOLOGY

Isolation of *Aspergillus flavus*

In this paper, we investigated influence of essential oils on the growth of isolates (10) *Aspergillus flavus* (Table 1) obtained from bread of domestic origin (Slovakian). We followed the impact of the following oils: lemon, eucalyptus, oregano, sage, thyme. All these samples of the essential oils were compared to the control sample. The control sample contained 50 µL of distilled water and it was free of essential oil. These isolates belong to the collection of microorganisms at the Department of Microbiology of the Slovak Agricultural University in Nitra.

Isolates grown on moldy breads we are using microscopic observations included in the genus *Aspergillus*. We restreaked to have their identification media. We used Czapek yeast extract agar (CYA), in malt extract agar (MEA) and the agar with yeast extract and

Table 1 List of isolates.

Number isolate	Label isolates <i>Aspergillus flavus</i>
1	KMi – 48 – MC
2	KMi – 43 – MC
3	KMi – 42 – MC
4	KMi – 41 – MC
5	KMi – 40 – MC
6	KMi – 1 – MC
7	KMi – 6 – MC
8	KMi – 33 – MC
9	KMi – 34 – MC
10	KMi – 35 – MC

Table 2 CYA – Czapek yeast extract agar.

K ₂ HPO ₄	1 g
Czapek concentrate	10 mL
Cu-Zn concentrate	1 mL
Yeast extract	5 g
Sucrose	30 g
Agar	15 g
Distilled water	1 000 mL

Table 3 MEA - In malt extract agar.

Malt extract	20 g
Glucose	20 g
Peptone	1 g
Agar	20 g
Distilled water	1 000 mL

Table 4 YES - Agar yeast extract and sucrose

Yeast exktract	20 g
Sucrose	150 g
MgSO ₄ . 7 H ₂ O	0,5 g
CuSO ₄ . 5 H ₂ O	0,005 g
ZnSO ₄ . 7 H ₂ O	0,01 g
Agar	20 g
Distilled water	1 000 mL

Table 5 Peptone water

Peptone	10 g
NaCl	5 g
Distilled water	1 000 mL

Table 6 The major constituents of essential oils analyzed by Calendula company a.s.

Essential oils	Compound	Amount (%)
Oregano	Carvacrol	44%
	1,8-cineole	minimum 5.0%
Sage	Thujone	minimum 15.0%
	Borneole	minimum 5.0%
	β -pinene	7.0 – 17%
	Sabinene	1.0 – 3.0%
	Limonene	56 – 78%
	γ -terpinene	6.0 – 12%
	β -caryophyllene	maximum 0.5%
Lemon	Neral	0.3 – 1.5%
	α -terpineol	maximum 0.6%
	neryl acetate	0.2 – 0.9%
	Geranial	0.5 – 2.3%
	geranyl acetate	0.1 – 0.8%
	α -pinene	9.0%
	β -pinene	maximum 1.5%
	Sabinene	maximum 0.3%
Eucalypt	Phellandrene	maximum 1.5%
	Limonene	12%
	1,8-cineol	minimum 70%
	camphor	maximum 0.1%
	β -myrcene	1.0 – 3.0%
	γ -terpinene	5.0 – 10%
	p -cymene	15 – 18%
	linalool	4.0 – 6.5%
	terpinene-4-ol	0.2 – 2.5%
	Thyme	thymol
carvacrol		1.0 – 4.0%

sucrose (YES) (Tables 2, 3, 4). As intermediate solution we used peptone water (Table 5). Petri dishes we cultured at 25 °C \pm (CYA and at 37 \pm °C), 7 days in the dark. The agar medium and the peptone water were sterilized at 0.1 MPa for 20 minutes in the autoclave.

Identification of *Aspergillus flavus*

Identification of isolated micromycetes we conducted by mycological keys: Pitt (1985), Pitt and Hocking (1997), Samson and Frisvad (2004), Klich (2002), Samson et al., (2002), Varga et al., (2007), Tančinová et al., (2012). Micromorphological characters we have seen in the microscope. For the preparation of formulations were used Melzer lactic acid solution and the methylene blue. We followed macroscopic features and microscopic features. Identification of the isolates of *Aspergillus flavus* was confirmed by mass spectrometry (MALDI-TOF MS).

Plant essential oils

Essential oils have been bought in Calendula s.a., Nová Lubovňa, Slovakia. The composition of the essential oils specified by the manufacturer – retailer Calendula a.s. (Table 6).

Testing the antifungal activity

The antifungal activity of selected essential oils was investigated by microatmosphere method. The test was performed in sterile Petri dishes (\varnothing 90 mm) containing 15 ml of CYA. Evaluation by filter paper was made by the

method adapted from Guynot et al. (2003). Plates were kept in an inverted position. A sterilized filter paper (square of 1 x 1 cm) was placed in the centre of the lid and 50 μ L of pure essential oil were added to the paper. Blank were made by adding 50 μ L of water to it. Each fungus was inoculated in the centre on Petri dish with needle. Plates were tightly sealed with parafilm and incubated for 14 days at 25 \pm 1 °C (three replicates were used for each treatment). Diameters (\varnothing mm) of the growing colonies were measured at the 3rd, 7th, 11th and 14th day with a ruler. The results were processed using Microsoft Excel 2010.

Investigation of the potential ability of isolates to produce mycotoxins *in vitro*

All isolates of *Aspergillus flavus* were used for toxigenic analyse by thin layer chromatography (TLC) method adapted from Samson et al. (2002) modified by Labuda and Tančinová (2006). For the determination of mycotoxins we used Colonies grown on CYA agar, which we have cultivated in the dark at 25 \pm 1 °C for two weeks. Three small pieces (each 1x1 cm) were cut from the colony growing on CYA and placed into 1.5 mL Eppendorf vials. Then 500 μ L of extraction solvent (chloroform/methanol, 2:1) was added to vials containing the agar plugs and shaken on a vortex for at least 2 minutes. Extracts (30 – 50 μ L) were applied afterwards as spots to the TLC plate (Silicagel 60, Merck, Germany) 1 cm apart. Chromatographic plate we put in a developing

system (toluene/ethyl acetate/formic acid, 5:3:1). Visualisation mycotoxins we characterized by Samson et al. (2002). CPA was reflected in the daylight as purple spot with a tail. AFB1 under UV light at 365 nm showed as a blue fluorescent spot (Samson et al., 2002).

Statistical analysis

The size averages of colonies (mm) of ten isolates affected by five essential oils (TREATMENT) on third, seventh, eleventh and fourteenth day of cultivation were analysed by the mixed model as implemented in SAS package (SAS, ver. 8.2, 2001).

The statistical model can be written in the following form:

$$y_{ij} = \mu + \text{TREATMENT}_i / \text{ISOLATES}_j + \text{STRAIN}_j + e_{ij}$$

where:

y_{ij} = the measurements in third, seventh, eleventh and fourteenth day of cultivation independently,

μ = overall mean,

TREATMENT_i = the fixed effects of tested oil (i = control, and five oils),

ISOLATE_j = fixed effect of strain (j = ten isolates),

e_{ij} = random error, assuming $e_{ij} \sim N(0, I \sigma^2)$.

Differences between the levels of the effects were tested by Scheffe multiple range test for studied size of colonies in different days of cultivations. Statistical significances of LSmeans were tested at level <0.05. Results are presented as LSmeans \pm standard error. The size averages of colonies (mm) in figures are presented as arithmetic means (Excel).

RESULTS AND DISCUSSION

The antimicrobial compounds in plant materials are commonly found in the essential oils fractions obtained by steam or supercritical distillation, pressing, or extraction by liquid or volatile solvents. The traditionally most well – known antimicrobial species and herbs are clove, cinnamon, chilli, garlic, thyme, oregano and rosemary. But also bay, basil, sage, anise, coriander, allspice, marjoram, nutmeg, cardamom, mint, parsley, lemongrass, celery, cumin, fennel and many others have been reported to have an inhibitory effect toward microorganisms (Elgayyar et al., 2001).

The aim of our paper was to determine the activity of volatile components of five essential oils – lemon, thyme, eucalyptus, sage and oregano on the growth of *Aspergillus flavus* isolates.

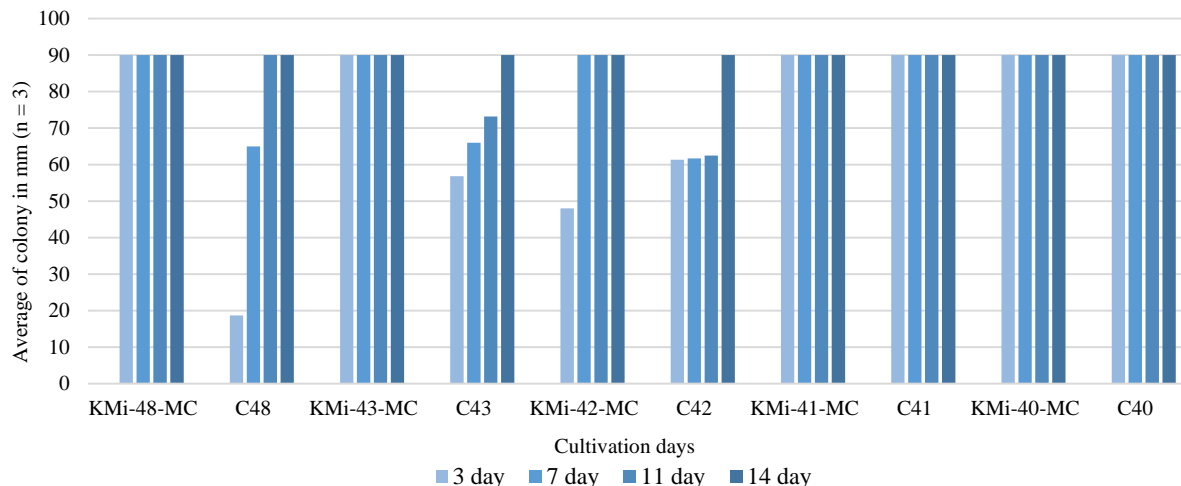

Figure 1 Influence of lemon essential oil on the growth of less sensitive isolates *A. flavus* on CYA at 25 ± 1 ° C. Kmi – x – MC tested isolates, C – control samples, n – the number of repetitions.

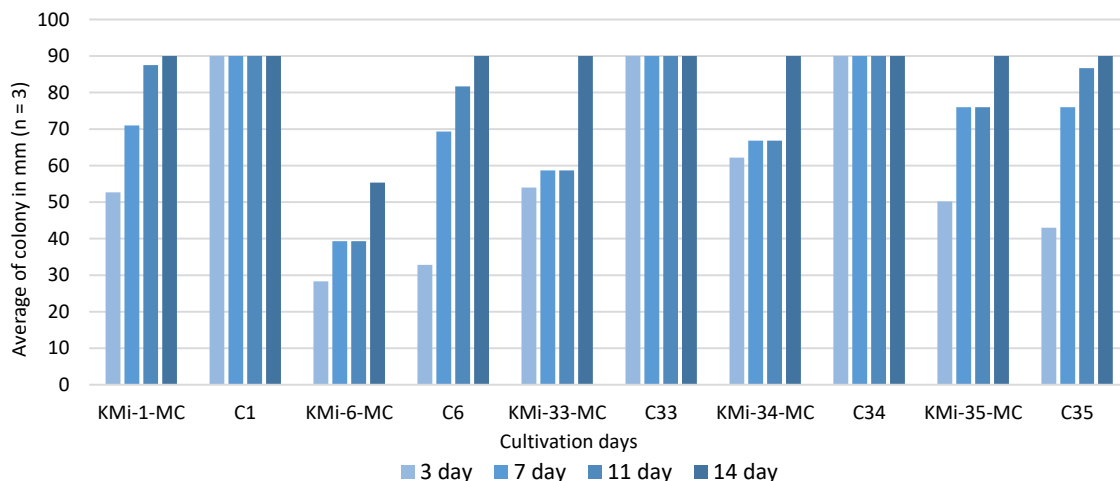

Figure 2 Influence of lemon essential oil on the growth of more sensitive isolates *A. flavus* on CYA at 25 ± 1 ° C.

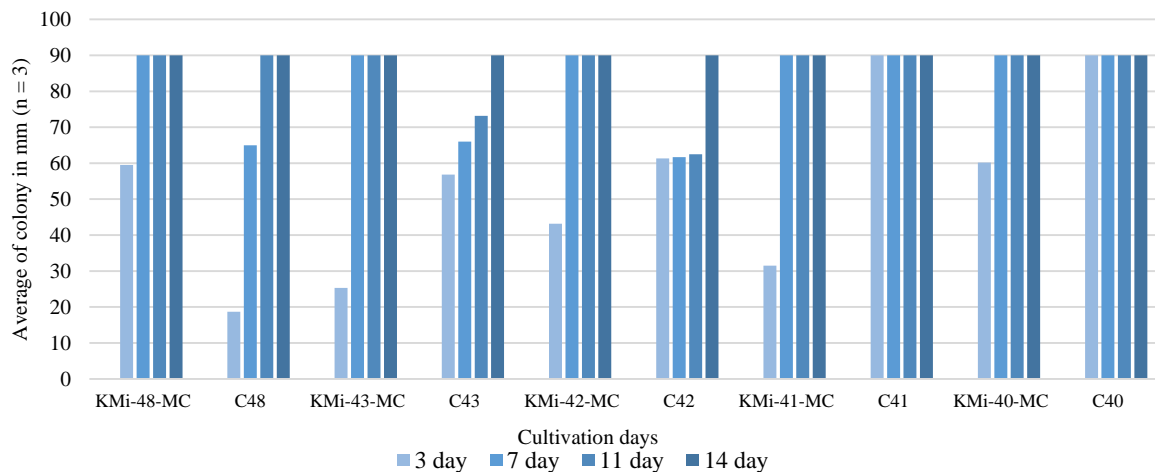

Figure 3 Influence of eucalypt essential oil on the growth of less sensitive isolates *A. flavus* on CYA at 25 ±1 °C. KMi – x – MC – tested isolates, C – control samples, n – the number of repetitions.

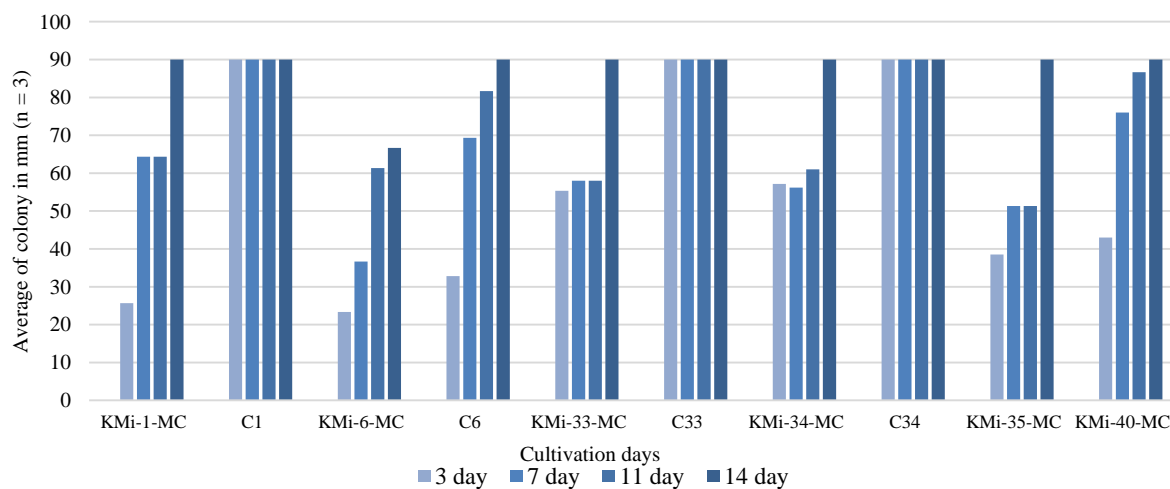

Figure 4 Influence of eucalypt essential oil on the growth of more sensitive isolates *A. flavus* on CYA at 25 ±1 °C. KMi – x – MC – tested isolates, C – control samples, n – the number of repetitions.

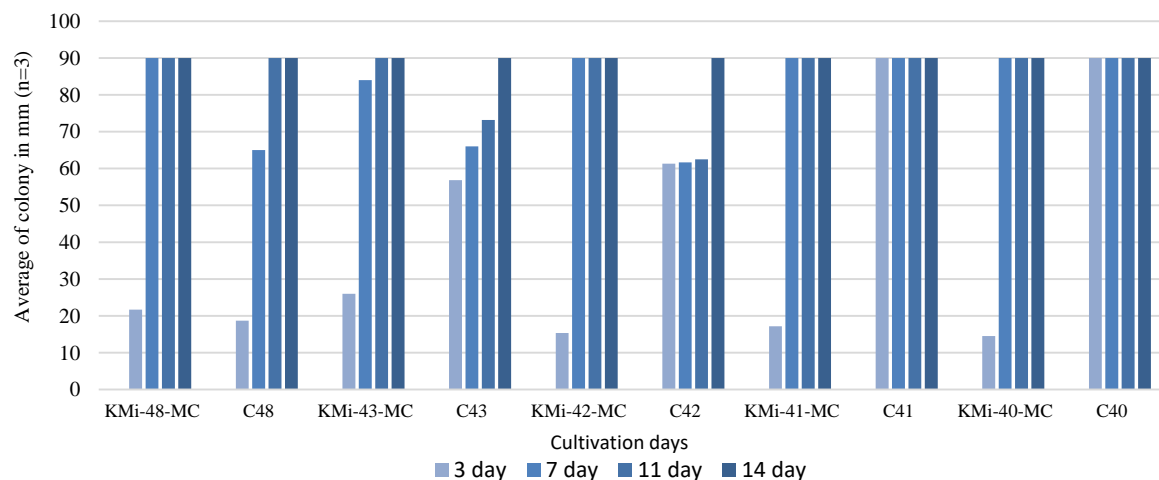

Figure 5 Influence of sage essential oil on the growth of less sensitive isolates *A. flavus* on CYA at 25 ±1 °C. KMi – x – MC – tested isolates, C – control samples, n – the number of repetitions.

A. flavus isolates reacted differently to the presence of the essential oil. For a better overview of the results, we divided them into two groups: the group of isolates which were less sensitive to the effect of essential oils and to the group of isolates which were more affected by essential oil – sensitive isolates. Figures 1 and 2 show the inhibitory

effect of lemon essential oil. The most sensitive isolate was KMi – 6 – MC, where in the oil slowed the growth of their colonies until the last day of cultivation. In isolate KMi – 48 – MC compared to the control sample we may say that the essential oil had a stimulating effect on the growth of the isolate.

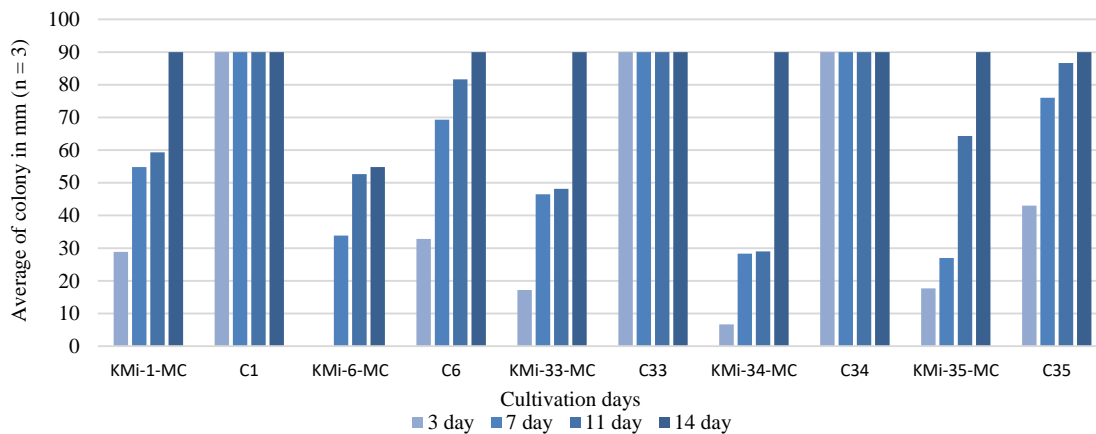

Figure 6 Influence of Sage essential oil on the growth of more sensitive isolates *A. flavus* on CYA at 25 ± 1 °C. KMi – x – MC – tested isolates, C – control samples, n – the number of repetitions.

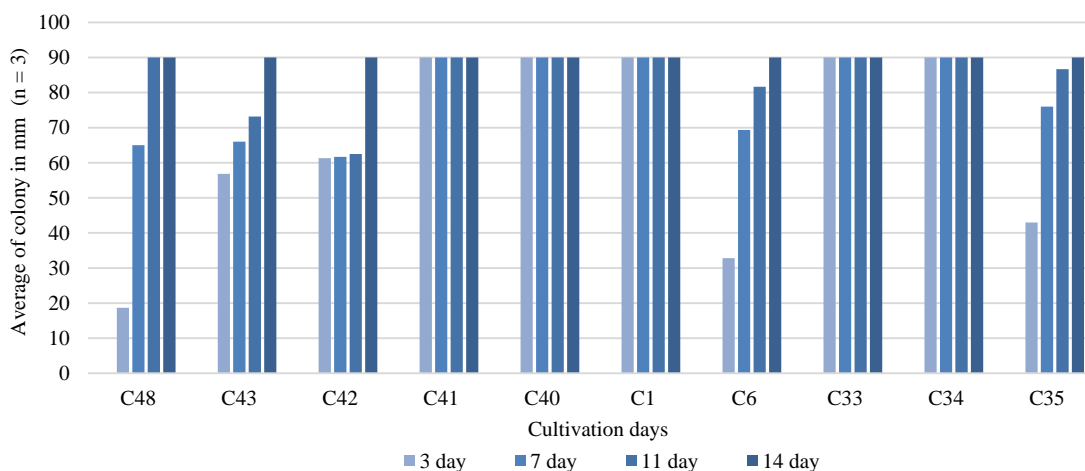

Figure 7 Growth curve of the control samples *A. flavus* isolates without the addition of essential oil on Czapek yeast extract agar at 25 ± 1 °C. C – control samples, n – the number of repetitions.

Eucalyptus essential oil has not expressed full inhibitory effect. Compared with the control sample, we found out that from the seventh day of cultivation had the oil rather than stimulatory inhibitory effects on the growth of colonies. The greatest activity was to isolate KMi – 6 – MC that inhibited growth until the last day of cultivation, as can be seen in the said figures 3 and 4.

Figure 5 and Figure 6 show the inhibitory effect of sage essential oil. This essential oil also has not expressed full inhibitory effect. In the picture 6 we can see isolates, which were most sensitive to the effect of the oil While the greatest effect had on the isolate KMi – 6 – MC, wherein we have not seen the growth of colonies until the third day. Particular isolates differed in the amount of growth in the absence of essential oil (control sample).

Figure 7 shows an overview of the control samples of tested isolates on the 3rd, 7th, 11th and 14th day of cultivation. Control samples of several isolates in comparison to other control samples completely filled Petri dish already on the third day of cultivation.

Oregano and thyme oils have 100% inhibitory effect on growth of all tested isolates disregarding the cultivation day. Lemon, eucalyptus and sage essential oils showed

partial antifungal activity, that means, the tested isolates did not inhibited completely, but affected the growth of colonies in some cases up to the last day of culture. Between individual isolates, we found significant differences in their growth in the presence of essential oils. The inhibitory effect of essential oils on the growth of colonies affects the length of cultivation and specific isolate. That's why *Origanum vulgare* is very well known for significant antifungal character. Table 7 displays the statistical analysis of influence of essential oils on the growth of isolates of *A. flavus* using gaseous diffusion method.

Carmo et al. (2008) dealt with study its inhibitory activity. The aim of their study was to evaluate the antifungal activity of oregano oil towards the microscopic thread-like fungi *Aspergillus*. They focused on species *A. flavus*, *A. parasiticus*, *A. terreus*, *A. ochraceus*, *A. fumigatus* and *A. niger*. The essential oil showed complete inhibitory effect on the growth of colonies throughout the culture to all species tested. Results showed a significant inhibitory character of oregano essential oil.

Table 7 The effect of essential oils on the growth of isolates of *A. flavus* using gaseous diffusion method.

Cultivation days		3 rd day		7 th day		11 th day		14 th day	
Treatment	Isolate	Average	S.e	Average	S.e	Average	S.e	Average	S.e
Control		90 ^a	0.66	90 ^a	0.69	90 ^a	0.66	90.00	0.49
LEO	KMi – 1 – MC	52.67 ^b	0.66	71 ^b	0.69	87.5 ^a	0.66	90.00	0.49
EEO		25.67 ^c	0.66	64.33 ^b	0.69	64.33 ^b	0.66	90	0.49
SEO		28.83 ^c	0.66	54.83 ^c	0.69	59.33 ^b	0.66	90	0.49
Control		32.83 ^a	0.66	69.33 ^a	0.69	81.67 ^a	0.66	90 ^a	0.49
LEO	KMi – 6 – MC	28.32 ^{ac}	0.66	39.33 ^b	0.69	39.33 ^b	0.66	52.33 ^b	0.49
EEO		23.33 ^{bc}	0.66	36.67 ^{bc}	0.69	61.33 ^c	0.66	66.67 ^c	0.49
SEO		0 ^d	0.66	33.83 ^c	0.69	52.67 ^d	0.66	54.83 ^b	0.49
Control		90 ^a	0.66	90 ^a	0.69	90 ^a	0.66	90	0.49
LEO	KMi – 33 – MC	54 ^b	0.66	58.67 ^b	0.69	58.67 ^b	0.66	90	0.49
EEO		55.33 ^b	0.66	58 ^b	0.69	58 ^b	0.66	90	0.49
SEO		17.17 ^c	0.66	46.5 ^c	0.69	48.17 ^c	0.66	90	0.49
Control		90 ^a	0.66	90 ^a	0.69	90 ^a	0.66	90	0.49
LEO	KMi – 34 – MC	62.17 ^b	0.66	66.83 ^b	0.69	66.83 ^b	0.66	90	0.49
EEO		57.17 ^b	0.66	56.17 ^c	0.69	61 ^b	0.66	90	0.49
SEO		6.67 ^c	0.66	28.83 ^d	0.69	29 ^c	0.66	90	0.49
Control		43 ^a	0.66	76 ^a	0.69	86.67 ^a	0.66	90	0.49
LEO	KMi – 35 – MC	50.17 ^b	0.66	76 ^a	0.69	76 ^b	0.66	90	0.49
EEO		38.5 ^a	0.66	51.33 ^b	0.69	51.33 ^c	0.66	90	0.49
SEO		17.67 ^c	0.66	27 ^c	0.69	64.33 ^d	0.66	90	0.49
Control		90 ^a	0.66	90	0.69	90	0.66	90	0.49
LEO	KMi – 40 – MC	90 ^a	0.66	90	0.69	90	0.66	90	0.49
EEO		60.17 ^b	0.66	90	0.69	90	0.66	90	0.49
SEO		14.42 ^c	0.66	90	0.69	90	0.66	90	0.49
Control		90 ^a	0.66	90	0.69	90	0.66	90	0.49
LEO	KMi – 41 – MC	90 ^a	0.66	90	0.69	90	0.66	90	0.49
EEO		31.5 ^b	0.66	90	0.69	90	0.66	90	0.49
SEO		14.42 ^c	0.66	90	0.69	90	0.66	90	0.49
Control		61.33 ^a	0.66	61.67 ^a	0.69	62.5 ^a	0.66	90	0.49
LEO	KMi – 42 – MC	48 ^b	0.66	90 ^b	0.69	90 ^b	0.66	90	0.49
EEO		43.17 ^b	0.66	90 ^b	0.69	90 ^b	0.66	90	0.49
SEO		15.33 ^c	0.66	90 ^b	0.69	90 ^b	0.66	90	0.49
Control		56.83 ^a	0.66	66 ^a	0.69	73.17 ^a	0.66	90	0.49
LEO	KMi – 43 – MC	90 ^b	0.66	90 ^b	0.69	90 ^b	0.66	90	0.49
EEO		25.33 ^c	0.66	90 ^b	0.69	90 ^b	0.66	90	0.49
SEO		26 ^c	0.66	84 ^b	0.69	90 ^b	0.66	90	0.49
Control		18.67 ^a	0.66	65 ^a	0.69	90	0.66	90	0.49
LEO	KMi – 48 – MC	90 ^b	0.66	90 ^b	0.69	90	0.66	90	0.49
EEO		59.5 ^c	0.66	90 ^b	0.69	90	0.66	90	0.49
SEO		21.67 ^a	0.66	90 ^b	0.69	90	0.66	90.00	0.49

* ^{a,b,c} LS Means in the same column at different isolates within the day of cultivation with different letters are different ($p < 0.05$)

** LEO – lemon essential oil, EEO – eucalyptus essential oil, SEO – sage essential oil, S.e – standard error.

Antifungal activity of rosemary and thyme and was observed by Centeno et al. (2010). They are focusing in particular on the species of microscopic filamentous fungi *Aspergillus flavus* and *Aspergillus ochraceus*, which are considered frequent crop and producers of mycotoxins contaminant. They followed the minimum fungicidal concentration (MFC) of selected essential oil. The results confirmed that the analyzed oils have shown inhibitory activity against the testes fungi *Aspergillus flavus* and *Aspergillus ochraceus*.

Abu-Darwish et al. (2013) dealt in its studies with *Salvia officinalis*'s features. The aim was to consider antifungal and anti-inflammatory capabilities of sage essential oil. Antifungal activity of sage essential oil tested on yeast and microscopic filamentous fungi *Aspergillus*. The active ingredients of sage essential oil 1,8-cineole

(50.3%) and camphor (25%) showed only partial antifungal activity against the tested species.

Mekonnen et al. (2016) dealt in their studies with the inhibitory effects of eucalyptus, thyme and rosemary oils towards certain types of microscopic filamentous, which confirmed a partial inhibitory activity of eucalyptus oil on tested species. Baratta et al. (2008) dealt in their studies with the antioxidant and antimicrobial activity of lemon essential oil against *Aspergillus niger* and *Aspergillus flavus*, which confirmed a partial inhibitory effect of lemon oil towards all tested species.

Císarová et al. (2016) in their studies also dealt inhibitory effect of lemon and eucalyptus essential oils, but there were found different results. These essential oils showed very poor inhibitor effects.

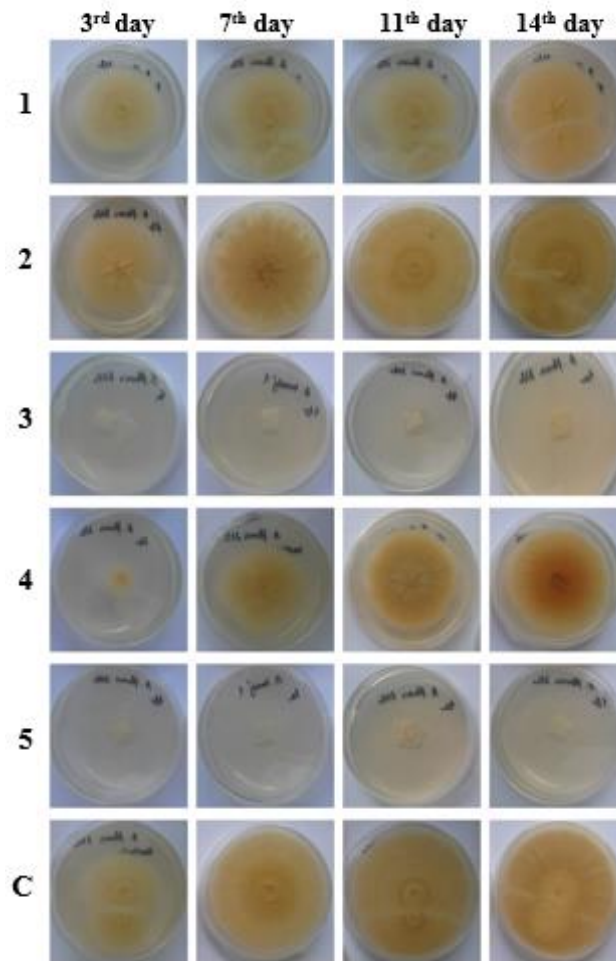

Figure 8 Comparison of the growth of isolate *Aspergillus flavus* KMI – 6 – MC of control sample (C), with the samples of lemon (1), eucalyptus (2), oregano (3), sage (4), thyme (5) essential oil on 3rd, 7th, 11th and 14th day of culture (Foltinová, 2016).

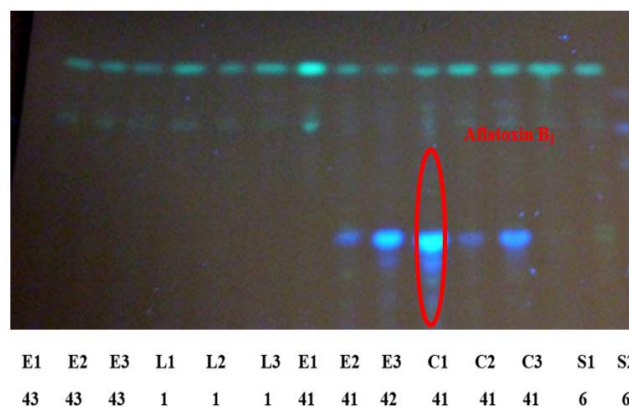

Figure 9 The production of aflatoxin B₁ *Aspergillus flavus* isolates, in vitro TLC method (the 14th day of cultivation, on YES at 25 ± 1 °C) (Foltinová, 2016). E – eucalyptus essential oil, L – lemon essential oil, S – sage essential oil, C – control samples.

In our study, we watched the ability of various isolates of *Aspergillus flavus* to produce mycotoxins – aflatoxin B₁, cyclopiazonic acid (Figure 9 and Figure 10) in conditions *in vitro* by TLC method. All control samples of the tested isolates in the absence essential oil produced mycotoxins in condition *in vitro*. Lemon essential oil had only partial inhibitory effect on the production of aflatoxin B₁ and cyclopiazonic acid, one isolate in the presence of

eucalyptus essential oil produced aflatoxin B₁ and by four isolates was observed cyclopiazonic acid production. None of tested isolates did not produce aflatoxin B₁ in the presence of sage essential oil, but in some isolates was recorded cyclopiazonic acid production. The production of mycotoxins have not been observed in oregano and thyme essential oil, because of their full inhibiting effect on growth of all isolates.

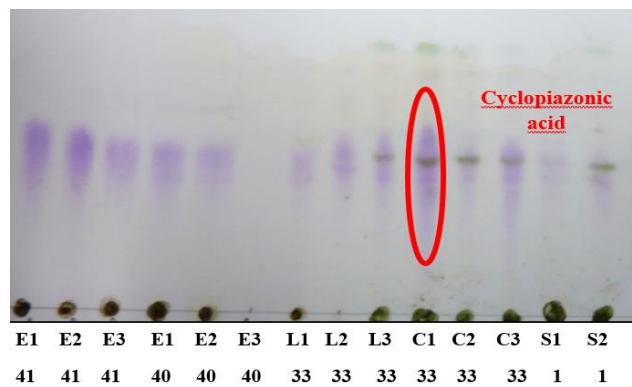

Figure 10 The production of cyclopiazonic acid *Aspergillus flavus* isolates, in conditions *in vitro* by TLC method (the 14th day of cultivation, on CYA at 25 ± 1 °C) (Foltinová, 2016). E – eucalyptus essential oil, L – lemon essential oil, S – sage essential oil, C – control samples.

Aflatoxins are produced by particular species of *A. flavus* and *A. parasiticus*. These mycotoxins are toxic compounds that are carcinogenic, mutagenic and teratogenic effects and present a risk to human and animal health. Antifungal activity of *Thymus vulgaris* against *Aspergillus flavus* and its effects on the production of secondary metabolites (AFB₁, AFB₂) *in vitro* was dealt by Abdel-Wahhab et al. (2010). The results of their work have confirmed the full inhibitory effect of thyme oil on the production of both mycotoxins, which is also consistent with our results.

CONCLUSION

The conclusions indicate that volatile phase of combinations of thyme oil and oregano oil showed good potential to inhibit growth of *Aspergillus flavus*. Even though that essential oils such as lemon, eucalyptus and sage had not antifungal activity like thyme and oregano essential oils, they should find a practical application in the inhibition of the fungal mycelial growth. In our paper we tested the antifungal activity of essential oils against common fungi causing spoilage of bakery products for 3rd, 7th, 11th and 14th days of cultivation. Based on the results of our paper, we can sort essential oils by the strongest inhibitory effect on the growth of *Aspergillus flavus* isolates and production of aflatoxin B₁ and cyclopiazonic acid as follows: oregano and thyme – sage – eucalyptus – lemon. Our paper gives support that essential oils can be used to control plant pathogens such as *Aspergillus flavus*.

REFERENCES

Abdel-Wahhab, M. A., Hassan, N. S., El-Kady, A. A., Khadrawy, Y. A. 2010. Red ginseng extract protects against aflatoxin B₁ and fumonisins-induced hepatic pre-cancerous lesions in rats. *Food and Chemical Toxicology*, vol. 48, no. 2, p. 733-742. <http://dx.doi.org/10.1016/j.fct.2009.12.006>

Abu-Darwish, M. S., Cabral, C., Ferreira, I. V., Goncalves, M. J., Cavaleiro, C. 2013. Essential Oil of Common Sage (*Salvia officinalis* L.) from Jordan: Assessment of Safety in Mammalian Cells and Its Antifungal and Anti-Inflammatory Potential. *BioMed Research International*, vol. 100, no. 2. <http://dx.doi.org/10.1155/2013/538940>

Baratta, M., Dorman, H. J., Deans, S. G., Figueiredo, C. 2008. Antimicrobial and antioxidant properties of some commercial essential oils. *Flavour and Fragrance Journal*, vol. 13, no. 4, p. 235-244.

[http://dx.doi.org/10.1002/\(SICI\)10991026\(1998070\)13:4<235::AID-FFJ733>3.0.CO;2-T](http://dx.doi.org/10.1002/(SICI)10991026(1998070)13:4<235::AID-FFJ733>3.0.CO;2-T)

Carmo, E. S., Oliveira-Lima, E., Leite De Souza, E. 2008. The potential of *Origanum vulgare* L. (*Lamiaceae*) essential oil in inhibiting the growth of some food-related *Aspergillus* species. *Brazilian Journal of Microbiology*, vol. 39, no. 2, p. 362-367. <http://dx.doi.org/10.1590/S1517-83822008000200030>

Centeno, S., Calvo, M. A., Adelantado, C., Figueroa, S. 2010. Antifungal activity of extracts of *Rosmarinus officinalis* and *Thymus vulgaris* against *Aspergillus flavus* and *Aspergillus ochraceus*. *Pakistan journal of biological sciences*, vol. 13, no. 9, p. 452-455. <https://doi.org/10.3923/pjbs.2010.452.455> PMID:20973400

Císarová, M., Tančinová, D., Medo, J. 2016. Antifungal activity of lemon, eucalyptus, thyme, oregano, sage and lavender essential oils against *Aspergillus niger* and *Aspergillus tubingensis* isolated from grapes. *Potravinárstvo*, vol. 10, no. 1, p. 83-88. <https://doi.org/10.5219/554>

Dantigny, P., Guilmar, A., Radoi, F., Bensoussan, M., Zwietering, M. 2005. Modelling the effect of ethanol on growth rate of food spoilage moulds. *International Journal of Food Microbiology*, vol. 98, no. 3, p. 261-269. <http://dx.doi.org/10.1016/j.ijfoodmicro.2004.07.008>

Elgayyar, M., Draughon, F. A., Golden, D. A., Mount, J. R. 2001. Antimicrobial activity of essential oils from plants against selected pathogenic and saprophytic microorganisms. *Journal of Food Protection*, vol. 64, no. 7, p. 1019-1024. <https://doi.org/10.4315/0362-028X-64.7.1019> PMID:11456186

Farzaneh, M., Kiani, H., Sharifi, R., Reisi, M., Hadian, J. 2015. Chemical composition and antifungal effects of three species of *Satureja* (*S. hortensis*, *S. spicigera*, and *S. khuzistanica*) essential oils on the main pathogens of strawberry fruit. *Postharvest Biology and Technology*, vol. 109, p. 145-151. <http://doi.org/10.1016/j.postharvbio.2015.06.014>

Foltinová, D. 2016. *Vplyv esenciálnych olejov na rast Aspergillus flavus (The effect of essential oils on the growth of Aspergillus flavus)*: diploma thesis. Nitra : SPU. 75 p.

Guynot, M. E., Ramos, A. J., Setó, L., Purroy, P., Sanchis, V., Marín, S. 2003. Antifungal activity of volatile compounds generated by essential oils against fungi commonly causing deterioration of bakery products. *Journal of Applied Microbiology*, vol. 94, no. 5, p. 893-899. <http://doi.org/10.1046/j.1365-2672.2003.01927.x>

Hyldgaard, M., Mygind, T., Meyer, R. L. 2012. Essential oils in food preservation: Mode of action, synergies, and

- interactions with food matrix components. *Frontiers in Microbiology*, vol. 3, no. 12, p. 1-24. <http://doi.org/10.3389/fmicb.2012.00012>
- Klich, A. M. 2002. *Identification of common Aspergillus species*. The Netherlands: Centraalbureau voor Schimmelcultures. p. 116. ISBN 90-70351-6-3. <http://doi.org/10.1017/S0269915X03243123>
- Kumar, R., Mishra, A. K., Dubey, N. K., Tripathi, Y. B. 2007. Evaluation of *Chenopodium ambrosioides* oil as a potential source of antifungal, antiaflatoxigenic and antioxidant activity. *International Journal of Food Microbiology*, vol. 115, no. 2, p. 159-164. <http://dx.doi.org/10.1016/j.ijfoodmicro.2006.10.017>
- Labuda, R., Tančinová, D. 2006. Mykotická kontaminácia vybraných surovín rastlinného pôvodu. In Bojňanská, T. et al. *Výživná a technologická kvalita rastlinných produktov a ich potravinárske využitie (Nutritional and technological quality of plant products and their use in food industry)*. Nitra : SPU Nitra, p. 167-194. ISBN 80-8069-780-9.
- Leslie, J. F., Bandyopadhyay, R., Visconti, A. 2008. *Mycotoxins: Detection Methods, Management, Public Health and Agricultural Trade*. UK : CAB International. 476 p. ISBN 13-978-1-84593-082-0.
- Mekonnen, A., Yitayew, B., Tesema, A., Taddese, S. 2016. *In Vitro* Antimicrobial Activity of Essential Oil of *Thymus schimperi*, *Matricaria chamomilla*, *Eucalyptus globulus*, and *Rosmarinus officinalis*. *International Journal of Microbiology*, vol. 2016, no. 1, p. 8. <http://dx.doi.org/10.1155/2016/9545693>
- Pardo, E., Marín, S., Ramos, A., Sanchis, V. 2006. Ecophysiology of ochratoxigenic *Aspergillus ochraceus* and *Penicillium verrucosum* isolates. Predictive models for fungal spoilage prevention a review. *Food Additives and Contaminants: Part A*, vol. 23, no. 4, p. 398-410. <http://dx.doi.org/10.1080/02652030500376102>
- Pitt, J. I. 1985. *Nomenclatorial and taxonomic problems in the genus Eurotium. Advances in Penicillium and Aspergillus systematics*. New York and London : Plenum Press. p. 383-396. ISBN 03-0642-222-0.
- Pitt, J. I., Hocking, A. D. 1997. *Fungi end food spoilage*. 2nd ed. London : Cambridge Blackie Academic and Profesional, 593 p. ISBN 0-8342-1306-0.
- Razzaghi-Abyaneh, M., Shams-Ghahfarokhi, M., Rezaee, M. B., Jaimand, K., Alinezhad, S., Saberi, R. 2009. Chemical composition and antiaflatoxigenic activity of *Carum carvi* L., *Thymus vulgaris* and *Citrus aurantifolia* essential oils. *Food Control*, vol. 20, no. 11, p. 1018-1024. <http://dx.doi.org/10.1016/j.foodcont.2008.12.007>
- Samson, R. A., Frisvad, J. C. 2004. *Penicillium subgenus Penicillium : new taxonomic schemes and mycotoxins and other extrolites*. Utrecht : Centraalbureau voor Schimmelcultures. 260 p. ISBN 90-70351-53-6.
- Samson, R. A., Hoekstra, E. S., Frisvad, J. C., Filtenborg, O. 2002. *Introduction to Food and Airborne Fungi*. 6th revised ed. Utrecht : Centraalbureau voor Schimmelcultures, p. 283-297. ISBN 90-70351-42-0. <http://dx.doi.org/10.1007/s11046-005-4201-1>
- Sharma, N., Tripathi, A. 2008. Effects of *Citrus sinensis* (L.) Osbeck epicarp essential oil on growth and morphogenesis of *Aspergillus niger* (L.) Van Tieghem. *Microbiological Research*, vol. 163, no. 3, p. 337-344. <http://doi.org/10.1016/j.micres.2006.06.009>
- Tančinová, D., Mašková, Z., Felšöciová, S., Dovičičová, M., Barboráková, Z. 2012. *Úvod do potravinárskej mykológie (Introduction to food mycology)*. Nitra : SPU. 292 p. ISBN 978-80-552-0753-7.
- Tripathi, P., Dubey, N. K. 2004. Exploitation of natural products as an alternative strategy to control postharvest fungal rotting of fruit and vegetables. *Postharvest Biology and Technology*, vol. 32, no. 3, p. 235-245. <http://dx.doi.org/10.1016/j.postharvbio.2003.11.005>
- Varga, J., Frisvad, J. C., Samson, R. A. 2007. Polyphasic taxonomy of *Aspergillus* section *Candidi* based on molekular, morphological and physiological data. *Studies in Mycology*, vol. 59, p. 75-88. <http://dx.doi.org/10.3114/sim.2007.59.10>
- Yamamoto-Ribeiro M. M. G., Grespan, R., Kohiyama, C. Y., Ferreira, F. D., Mossini, S. A. G. 2013. Effect of *Zingiber officinale* essential oil on *Fusarium verticillioides* and fumonisin production. *Food Chemistry*, vol. 141, no. 3, p. 3147-3152. <http://dx.doi.org/10.1016/j.foodchem.2013.05.144>

Acknowledgments:

This paper was co-funded under project KEGA 015 SPU - 4/2015.

This work was supported by Research Center AgroBioTech built in accordance with the project Building Research Centre „AgroBioTech“; ITMS 26220220180.

Contact address:

Denisa Foltinová, Slovak University of Agriculture in Nitra, Faculty of Biotechnology and Food Sciences, Department of Microbiology, Tr. A. Hlinku 2, 949 76 Nitra, Slovakia, E-mail: foltinova.d@gmail.com

Dana Tančinová, Slovak University of Agriculture in Nitra, Faculty of Biotechnology and Food Sciences, Department of Microbiology, Tr. A. Hlinku 2, 949 76 Nitra, Slovakia, E-mail: Dana.Tancinova@uniag.sk

Miroslava Cisarová, Slovak University of Agriculture in Nitra, Faculty of Biotechnology and Food Sciences, Department of Microbiology, Tr. A. Hlinku 2, 949 76 Nitra, Slovakia, E-mail: miroslava.cisarova@gmail.com

MOLECULAR VARIABILITY OF OAT BASED ON GENE SPECIFIC MARKERS

Želmíra Balážová, Zdenka Gálová, Martin Vivodík, Lenka Petrovičová,
Radomíra Hornyák Gregáňová

ABSTRACT

Oat (*Avena sativa* L.) is a grass planted as a cereal crop. Cultivation of oat is increasing in the recent years because of its good nutrition value. The aim of our study was to analyze genetic variability of oat accessions based on SCoT markers. Eighteen primers were used to study polymorphism of 8 oat genotypes. All 18 primers produced polymorphic and reproducible data. Altogether 153 different fragments were amplified of which 67 were polymorphic with an average number of 3.72 polymorphic fragments per genotype. The number of polymorphic fragments ranged from one (SCoT9, SCoT62) to nine (SCoT40). The percentage of polymorphic bands ranged from 14.29% (SCoT9) to 60% (SCoT59) with an average of 41.62%. Genetic polymorphism was characterized based on diversity index (DI), probability of identity (PI) and polymorphic information content (PIC). The diversity index of the tested SCoT markers ranged from 0 (SCoT9, SCoT62) to 0.878 (SCoT40) with an average of 0.574. The polymorphic information content ranged from 0 (SCoT9, SCoT62) to 0.876 (SCoT40) with an average of 0.524. Dendrogram based on hierarchical cluster analysis using UPGMA algorithm grouped genotypes into two main clusters. Two genotypes, Taiko and Vok were genetically the closest. Results showed the utility of SCoT markers for estimation of genetic diversity of oat genotypes leading to genotype identification.

Keywords: *Avena sativa* L.; SCoT technique; genetic diversity; polymorphism; dendrogram

INTRODUCTION

Cereals belong to a group of key foods of plant production. Oat together with corn and barley is the most used for feed but for human nutrition is used only a little. Cultivated oats are hexaploid cereals belonging to the genus *Avena* L., which is found worldwide in almost all agricultural environments. Recently, oats have been receiving increasing interest as human food, mainly because the cereal could be suitable for consumptions by celiac patients (Gálová et al., 2012). In the Nordic countries and Northern Europe it became a well-established crop both for food and feed. Oat belongs to alternative cereals which are used mainly as a supplement to traditional species of cereals (Daou and Zhang, 2012).

Recently, the studies of genetic diversity based mainly on the molecular analysis. Worldwide collections of oats were described by several types of dominant molecular markers, for example AFLP (Fu et al., 2003), RAPD (Baohong et al., 2003) and ISSR (Boczkowska and Tarczyk, 2013). With initiating a trend away from random DNA markers towards gene-targeted markers, a novel marker system called SCOT (Collard and Mackill, 2009) was developed based on the short conserved region flanking the ATG start codon in plant genes. SCOT markers are generally reproducible, and it is suggested that primer length and annealing temperature are not the sole factors determining

reproducibility. They are dominant markers like RAPDs and could be used for genetic analysis, quantitative trait loci (QTL) mapping and bulk segregation analysis (Collard and Mackill, 2009). In principle, SCOT is similar to RAPD and ISSR because the same single primer is used as the forward and reverse primer (Collard and Mackill, 2009; Gupta et al. 1994). SCoT marker system has gained popularity for its superiority over other dominant DNA marker systems like RAPD and ISSR for higher polymorphism and better marker resolvability (Gorji et al., 2011; Que et al. 2014; Satya et al., 2015; Zhang et al., 2015). Suitability of SCoT markers system has been successfully employed in genetic diversity analysis and fingerprinting of a number of agricultural and horticultural crop species, such as peanut (Xiong et al., 2011), tomato (Shahlaei et al., 2014), citrus (Mahjbi et al., 2015), date palm (Al-Qurainy et al., 2015), ramie (Satya et al., 2015), castor (Kallamadi et al., 2015), maize (Vivodík et al., 2016) and mango (Gajera et al., 2014).

The aim of our study was to detect genetic variability among the set of 8 oat genotypes using 18 SCoT markers and to testify the usefulness of a used set of SCoT primers for the identification and differentiation of oat genotypes.

MATERIAL AND METHODOLOGY

Eight oat (*Avena sativa* L.) genotypes were used in the present study. Seeds of oat were obtained from the Gene Bank of the Slovak Republic of the Plant Production Research Center in Piešťany. Genomic DNA of rye cultivars was isolated from 100 mg freshly-collected leaf tissue according to GeneJET™ protocol (Fermentas, USA). The concentration and quality of DNA was checked up on 1.0% agarose gel coloured by ethidium bromide and detecting by comparing to λ -DNA with known concentration.

SCoT analysis: For analysis 18 SCoT primers were chosen (Table 2) according to the literature (Collard a Mackill, 2009). Amplification of SCoT fragments was performed according to (Collard a Mackill, 2009) (Table 2.). Polymerase chain reaction (PCR) was performed in 15 μ L mixture in a programmed thermocycler (Biometra, Germany). Amplified products were separated in 1% agarose gels in 1 \times TBE buffer. The gels were stained with ethidium bromide and documented using gel documentation system UVP PhotoDoc-t®. Size of amplified fragments was determined by comparing with 100 bp standard length marker (Promega).

Data analysis: For the assessment of the polymorphism between castor genotypes and usability of SSR markers in their differentiation diversity index (DI) (Weir, 1990), the probability of identity (PI) (Paetkau et al., 1995) and

polymorphic information content (PIC) (Weber, 1990) were used. The SCoT bands were scored as present (1) or absent (0), each of which was treated as an independent character regardless of its intensity. The binary data generated were used to estimate levels of polymorphism by dividing the polymorphic bands by the total number of scored bands and to prepare a dendrogram. A dendrogram based on hierarchical cluster analysis using the unweighted pair group method with arithmetic average (UPGMA) with the SPSS professional statistics version 17 software package was constructed.

RESULTS AND DISCUSSION

The development of molecular markers has opened up numerous possibilities for their application in plant breeding. For detecting polymorphisms new molecular marker system called SCoT (Collard a Mackill, 2009) was developed which tag coding sequences of the genome. SCoT marker system had initially been validated in the model species rice (*Oryza sativa*) (Collard and Mackill 2009).

For the molecular analysis of 8 oat genotypes 18 SCoT primers were used. PCR amplifications using 18 SCoT primers produced total 153 DNA fragments that could be scored in all genotypes. The selected primers amplified DNA fragments across the 8 genotypes studied with the number of amplified fragments varying from 4 (SCoT62)

Table 1 List of analyzed genotypes of oat.

No.	Genotype of oat (<i>Avena</i> spp. L.)	Country of origin	Breeding year
1.	Azur	Czech Republic	2004
2.	Dalimil	Czech Republic	2004
3.	Vok	Czech Republic	2004
4.	Revisor	Netherland	1996
5.	Taiko	Netherland	2004
6.	Argentina	Italy	2004
7.	Euro	Austria	1995
8.	Vilma	Sweden	2004

Table 2 List of used SCoT markers.

SCoT primer	Sequence of primers (5' -3')	Anealing temperature [°C]
SCoT 6	CAACAATGGCTACCACGC	50
SCoT 8	CAACAATGGCTACCACGT	50
SCoT 9	CAACAATGGCTACCAGCA	50
SCoT 12	ACGACATGGCGACCAACG	50
SCoT 23	CACCATGGCTACCACCAG	50
SCoT 26	ACCATGGCTACCACCGTC	50
SCoT 28	CCATGGCTACCACCGCCA	50
SCoT 29	CCATGGCTACCACCGGCC	50
SCoT 30	CCATGGCTACCACCGGCG	50
SCoT 36	GCAACAATGGCTACCACC	50
SCoT 40	CAATGGCTACCACTACAG	50
SCoT 44	CAATGGCTACCATTAGCC	50
SCoT 45	ACAATGGCTACCACTGAC	50
SCoT 54	ACAATGGCTACCACCAGC	50
SCoT 59	ACAATGGCTACCACCATC	50
SCoT 60	ACAATGGCTACCACCACA	50
SCoT 61	CAACAATGGCTACCACCG	50
SCoT 62	ACCATGGCTACCACGGAG	50
SCoT 63	ACCATGGCTACCACGGGC	50
SCoT 65	ACCATGGCTACCACGGCA	50

to 17 (SCoT40) and the amplicon size varied from 200 to 3000 bp. Of the 153 amplified bands, 67 were polymorphic with an average of 3.72 fragments per primer (Table 3). The percentage of polymorphic bands ranged from 14.29% (SCoT9) to 60% (SCoT59) with an average of 41.62%. The polymorphic information content (PIC) values varied from 0 (SCoT9, SCoT62) to 0.876 (SCoT40) with an average of 0.524 and index diversity (DI) value ranged from 0 (SCoT9, SCoT62) to 0.878 (SCoT40) with an average of 0.574 (Tab.3). The most polymorphic SCoT40 marker is showed on Figure 2.

A dendrogram was constructed from a genetic distance matrix based on profiles of the 18 SCoT primers using the unweighted pair-group method with the arithmetic average (UPGMA). According to analysis, the collection of 8 diverse accessions of oat was clustered into two main clusters (Figure 1). The first cluster contained unique genotype Azur coming from the Czech Republik. Second cluster contained 7 genotypes of oat which were further

subdivided into two subclusters (2a, 2b). Subcluster 2a contained unique Austrian genotype Euro and rest of genotypes (6) were included in the subcluster 2b. Genetically the closest were two genotypes, Vok (coming from the Czech Republik) and Taiko (coming from Netherland).

Lower average polymorphism (21%) obtained by SCoT technique was detected by Kallamadi et al. (2015) who analysed molecular diversity of castor (*Ricinus communis* L.). Out of 36 SCoT primers tested, all primers produced amplification products but only 10 primers resulted in polymorphic fingerprint patterns. Out of a total of 108 bands, 23 (21%) were polymorphic with an average of 2.1 polymorphic bands per primer. The total number of bands per primer varied from 5 and 20 in the molecular size range of 100 – 3000 bp. The PIC/DI varied from 0.06 for SCoT28 to 0.45 for SCoT12 with an average of 0.24.

On the other side, higher polymorphism with SCoT primers has been reported in crops like peanut (Xiong et

Table 3 Statistical characteristics of the SCoT markers used in oat.

SCoT marker	Number of all fragments	Number of polymorphic fragments	Percentage of polymorphic bands (%)	DI	PIC	PI
SCoT6	8	4	50.00	0.715	0.697	0.026
SCoT8	8	2	25.00	0.486	0.368	0.160
SCoT9	7	1	14.29	0.000	0.000	1.000
SCoT12	5	2	40.00	0.500	0.375	0.375
SCoT23	6	2	33.33	0.497	0.374	0.376
SCoT26	8	3	37.50	0.561	0.467	0.285
SCoT28	10	5	50.00	0.719	0.688	0.087
SCoT29	10	4	40.00	0.722	0.690	0.091
SCoT30	12	7	58.33	0.778	0.769	0.034
SCoT36	7	4	57.14	0.648	0.589	0.176
SCoT40	17	9	52.94	0.878	0.876	0.002
SCoT54	9	3	33.33	0.625	0.586	0.148
SCoT59	10	6	60.00	0.741	0.735	0.040
SCoT60	6	2	33.33	0.500	0.375	0.375
SCoT61	8	4	50.00	0.613	0.542	0.078
SCoT62	4	1	25.00	0.000	0.000	1.000
SCoT63	9	3	33.33	0.667	0.617	0.038
SCoT65	9	5	55.56	0.688	0.681	0.046
Average	8.50	3.72	41.62	0.574	0.524	0.241
Total	153	67				

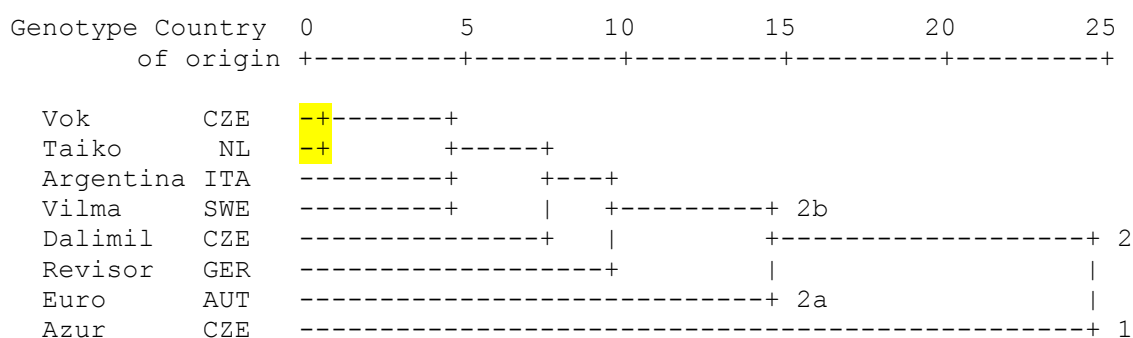

Figure 1 Dendrogram of 8 oat genotypes prepared based on 18 SCoT markers.

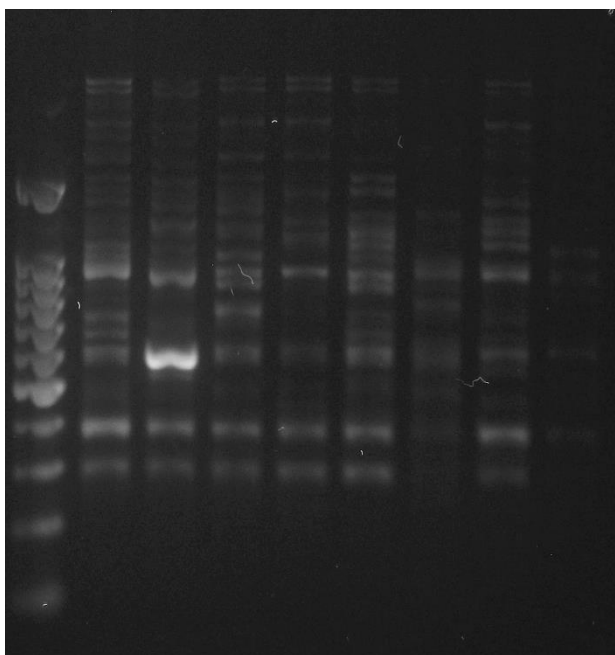

Figure 2 Electrophoreogram of SCoT40 marker.

al., 2011), cicer (Amirmoradi et al., 2012), mango (Luo et al., 2010), ramie (Satya et al., 2015), sugarcane (Que et al., 2014), Chinese bayberry (Fang-Yong and Ji-Hong, 2014), pepper (Tsaballa et al., 2015), castor (Kallamadi et al., 2015), maize (Vivodik et al., 2016).

Satya et al. (2015) used 20 SCoT markers to assess genetic diversity and population structure of indigenous, introduced and domesticated ramie (*Boehmeria nivea* L. Gaudich.). A total of 155 genotypes from five populations were investigated for SCoT polymorphism, which produced 136 amplicons with a range of 4 to 10 bands per primer, of which 119 (87.5%) were polymorphic. Percent polymorphism varied from 20% to 100%, with 3 – 10 polymorphic bands per primer. Polymorphism information content ranged from 0.25 to 0.93 with an average of 0.69. Gajera et al. (2014) used 19 SCoT primers for amplification among 20 cultivars which yielded a total of 117 clear and bright loci. Number of loci varied from 4 to 10 with an average of 6.16 loci per primer. Of 117 loci, 96 loci (79.57%) were found to be polymorphic, the number of polymorphic loci varied from 2 to 10 with an average of 5.05 loci per primer. The detected polymorphism per primer among the tested cultivars ranged from 50% (SCoT26) to 100% (SCoT-33, SCoT-40, and SCoT-51). In our study we detected by SCoT26 primer of percentage of polymorphic bands 37.5%. Also Luo et al. (2010) found high percentage of polymorphism (76.2%) using SCoT markers in analysis of diversity and relationships among mango cultivars. Que et al. (2014) used 20 SCoT primers to assess the genetic diversity among 107 sugarcane accessions within a local sugarcane germplasm collection. Twenty SCoT primers amplified 176 DNA fragments, of which 163 were polymorphic (92.85%). Fang-Yong and Ji-Hong (2014) assessed the genetic diversity of 31 germplasm resources of *Myrica rubra* of China using 38 SCoT markers. Authors detected 298 reproducible bands of which 251 were polymorphic (84.23%).

Level of polymorphism in analysed oat genotypes was also determined by calculated polymorphic information

content (PIC) (Table 3). Lower PIC values compare to our analysis (0.524) were detected by Tsaballa et al. (2015) and Kallamadi et al. (2015). Tsaballa et al. (2015) analyzed genetic variability among the 30 landraces and one commercial Greek cultivar of pepper (*Capsicum annuum* L.) using 6 SCoT primers. They detected PIC values ranged from 0.123 (SCoT33) to 0.258 (SCoT15), with an average value of 0.232 per primer. Kallamadi et al. (2015) detected average PIC/DI values from 0.06 (SCoT28) to 0.45 (SCoT12) with an average of 0.24 in analysis of genetic diversity in 31 accessions of castor representing seven geo-graphic areas by 36 SCoT markers.

Similar values of PIC were detected by other authors (Luo et al. 2010; Gajera et al. 2014; Que et al. 2014; Gao et al. 2014; Fang-Yong et al. 2014; Jiang et al. 2014; Huang et al. 2014; Satya et al. 2015, Hajibarat et al., 2015) and these values presented a high level of polymorphism of genotypes detected by SCoT markers. Huang et al. (2014) assessed the genetic diversity of six *Hemarthria* cultivars using seven SCoT primers. They calculated PIC values ranged from 0.471 to 0.758 with an average of 0.612. Hajibarat et al. (2015) used a set of 9 SCoT primers to fingerprint 48 chickpea genotypes. PIC values ranged from 0.43 to 0.47 with an average value of 0.45 per primer. Higher PIC values were detected by Que et al. (2014) who used assessed the genetic diversity among 107 sugarcane accessions using 20 SCoT markers and calculated PIC values from 0.783 to 0.907 with a mean of 0.861.

For the revealing of the genetic relationships among the cultivars it is necessary to construct a dendrogram. In the study Que et al. (2014), used 20 SCoT primers to assess the genetic diversity among 107 sugarcane accessions within a local sugarcane germplasm collection. Unweighted pair group method of arithmetic averages (UPGMA) cluster analysis of the SCoT marker data divided 107 sugarcane accessions into six clusters. Jiang et al. (2014) used start codon-targeted (SCoT) markers to analyze the diversity and genetic relationships among 95

orchardgrass accessions. In total, 273 polymorphic bands were detected with an average of 11.4 bands per primer. The UPGMA dendrogram separated 95 accessions into 7 main clusters according to the geographical origin. **Kallamadi et al. (2015)** by analysis of genetic diversity of 31 accessions of castor using 36 SCoT markers constructed the UPGMA dendrogram based in which the accessions of castor separated into two major clusters (11 and 17 accessions). Three accessions failed to cluster with others accessions. **Rajesh et al. (2015)** constructed dendrogram using corresponding genetic similarity coefficients obtained from UPGMA analysis and determined the clustering pattern among the coconut accessions. Coconut accessions grouped into two main clusters. Cluster analysis supported population genetic analysis and suggested close association between introduced and domesticated genotypes. **Gajera et al. (2014)** constructed dendrogram of the 20 mango cultivars using 19 SCoT primers which clustered into two major groups based on the SCoT data analysis with UPGMA.

Recent advances in genomic research has resulted in a change of preference from the use of random DNA markers to gene-targeted, functional markers and the development of novel DNA-based marker systems (**Poczai et al., 2013**). Functional markers developed from the transcribed region of the genome have the ability to reveal polymorphism, which might be directly related to gene function (**Poczai et al., 2013**). Start codon targeted polymorphism (SCoT) is a simple and novel marker system first described by **Collard and Mackill (2009)**, which is based on the short conserved region flanking the ATG translation start codon in plant genes. The technique is similar to RAPD or ISSR in that a single primer acts as the forward and the reverse primer, amplicons can be visualized by standard agarose gel electrophoresis, without the need for costly automated electrophoresis systems (**Collard and Mackill, 2009**). The higher primer lengths and subsequently higher annealing temperatures ensure higher reproducibility of SCoT markers, compared to RAPD markers (**Rajesh et al., 2015**). **Gorji et al. (2011)** presented that SCoTs markers were more informative and effective, followed by ISSRs and AFLP marker system in in fingerprinting of potato varieties.

CONCLUSION

The present work reported utilization of SCoT markers for the detection of genetic variability of oat genotypes. In summary, SCoT marker analysis was successfully developed to evaluate the genetic relationships among the genus of oat accessions originated from various regions. The hierarchical cluster analysis divided oat genotypes into 2 main clusters. SCoT markers are generated from the functional region of the genome; the genetic analyses using these markers would be more useful for crop improvement programs. Polymorphism revealed by SCoT technique was abundant and could be used for molecular genetics study of the oat accessions, providing high-valued information for the management of germplasm, improvement of the current breeding strategies, construction of linkage maps, conservation of the genetic resources of oat species and QTL mapping.

REFERENCES

- Al-Qurainy, F., Khan, S., Nadeem, M., Tarroum, M. 2015. SCoT marker for the assessment of genetic diversity in Saudi Arabian date palm cultivars. *Pakistan Journal of Botany*, vol. 47, no. 2, p. 637-640.
- Amirmoradi, B., Talebi, R., Karami, E. 2012. Comparison of genetic variation and differentiation among annual Cicer species using start codon targeted (SCoT) polymorphism, DAMD-PCR, and ISSR markers. *Plant Systematics and Evolution*, vol. 298, no. 9, p. 1679-1688. <https://doi.org/10.1007/s00606-012-0669-6>
- Baohong, G., Zhou, X., Murphy, J. P. 2003. Genetic variation within Chinese and Western cultivated oat accessions. *Cereal Research Communications*, vol. 31, no. 3-4, p. 339-346.
- Boczowska, M., Tarczyk, E. 2013. Genetic diversity among Polish landraces of common oat (*Avena sativa* L.). *Genet Resources and Crop Evolution*, vol. 60, no. 7, p. 2157. <https://doi.org/10.1007/s10722-013-9984-1>
- Collard, B. C. Y., Mackill, D. J. 2009. Start codon targeted (SCoT) polymorphism: a simple, novel DNA marker technique for generating gene-targeted markers in plants. *Plant Molecular Biology Report*, vol. 27, p. 86-93. <https://doi.org/10.1007/s11105-008-0060-5>
- Daou, C., Zhang, H. 2012. Oat Beta-Glucan: Its Role in Health Promotion and Prevention of Diseases. *Comprehensive Reviews in Food Science and Food Safety*, vol. 11, no. 4, p. 355-365. <https://doi.org/10.1111/j.1541-4337.2012.00189.x>
- Fang-Yong, Ch., Ji-Honga, L. 2014. Germplasm genetic diversity of *Myrica rubra* in Zhejiang Province studied using inter-primer binding site and start codon-targeted polymorphism markers. *Scientia Horticulturae*, vol. 170, p. 169-175. <https://doi.org/10.1016/j.scienta.2014.03.010>
- Fu, Y. B., Peterson, G. W., Scoles, G., Rossnagel, B., Schoen, D. J., Richards, K. W. 2003. Allelic diversity changes in 96 Canadian oat varieties released from 1886 to 2001. *Crop Science*, vol. 43, p. 1989-1995. <https://doi.org/10.2135/cropsci2003.1989>
- Gajera, H. P., Bambharolia, R. P., Domadiya, R. K., Patel, S. V., Golakiya, B. A. 2014. Molecular characterization and genetic variability studies associated with fruit quality of indigenous mango (*Mangifera indica* L.) cultivars. *Plant Systematics and Evolution*, vol. 300, p. 1011-1020. <https://doi.org/10.1007/s00606-013-0939-y>
- Gálová, Z., Palenčárová, E., Chňapek, M., Balážová, Ž. 2012. *Využitie obilnín, pseudoobilnín a strukovín v bezlepkovej diete (Utilization of cereals, pseudocereals and legumes in gluten-free diet)*. 1st ed. Nitra, Slovakia : Slovenská poľnohospodárska univerzita, p. 38-40. ISBN 978-80-552-0826-8.
- Gao, Y. H., Zhu, Y. Q., Tong, Z. K., Xu, Z. Y., Jiang, X. F., Huang, Ch. H. 2014. Analysis of genetic diversity and relationships among genus *Lycoris* based on start codon targeted (SCoT) marker. *Biochemical Systematics and Ecology*, vol. 57, p. 221-226. <https://doi.org/10.1016/j.bse.2014.08.002>
- Gorji, A. M., Poczai, P., Polgar, Z., Taller, J. 2011. Efficiency of arbitrarily amplified dominant markers (SCoT, ISSR and RAPD) for diagnostic fingerprinting in tetraploid potato. *American Journal of Potato Research*, vol. 88, no. 3, p. 226-237. <https://doi.org/10.1007/s12230-011-9187-2>
- Gupta, P. K., Chyi, Y. S., Romero-Severson, J., Owen, J. L. 1994. Amplification of DNA markers from evolutionary diverse genomes using single primers of simple-sequence

- repeats. *Theoretical and Applied Genetics*, vol. 89, no. 7-8, p. 998-1006. [PMid:24178116](https://doi.org/10.1007/s12298-015-0306-2)
- Hajibarat, Z., Saidi, A. Hajibarat, Z., Talebi, R. 2015. Characterization of genetic diversity in chickpea using SSR. *Physiology and Molecular Biology of Plants*, vol. 21, no. 3, p. 365-373. <https://doi.org/10.1007/s12298-015-0306-2>
[PMid:26261401](https://doi.org/10.1007/s12298-015-0306-2)
- Huang, L., Huang, X., Yan, H., Yin, G., Zhang, X., Tian, Y., Zhang, Y., Jiang, X., Yan, Y., Ma, X., Peng, Y., Zhou, J., Nie, G. 2014. Constructing DNA fingerprinting of *Hemarthria* cultivars using EST-SSR and SCoT markers. *Genetic Resources and Crop Evolution*, vol. 61, p. 1047-1055. <https://doi.org/10.1007/s10722-014-0107-4>
- Jiang, L. F., Qi, X., Zhang, X. Q., Huang, L. K., Ma, X., Xie, W. G. 2014. Analysis of diversity and relationships among orchardgrass (*Dactylis glomerata* L.) accessions using start codon-targeted markers. *Genetic and Molecular Research*, vol. 13, no. 2, p. 4406-4418. <https://doi.org/10.4238/2014.June.11.4>
[PMid:25036346](https://doi.org/10.4238/2014.June.11.4)
- Kallamadi, P. R., Ganga, R., Nadigatlab, V. P. R., Mulpurib, S. 2015. Molecular diversity in castor (*Ricinus communis* L.). *Industrial Crops and Products*, vol. 66, p. 271-281. <https://doi.org/10.1016/j.indcrop.2014.12.061>
- Luo, C., He, X. H., Chen, H., Ou, S. J., Gao, M. P. 2010. Analysis of diversity and relationships among mango cultivars using start codon targeted (SCoT) markers. *Biochemical Systematics and Ecology*, vol. 38, no. 6, p. 1176-1184. <https://doi.org/10.1016/j.bse.2010.11.004>
- Mahjbi, A., Baraket, G., Oueslati, A., Salhi-Hannachi, A. 2015. Start Codon Targeted (SCoT) markers provide new insights into the genetic diversity analysis and characterization of Tunisian Citrus species. *Biochemical Systematics and Ecology*, vol. 61, p. 390-398. <https://doi.org/10.1016/j.bse.2015.07.017>
- Paetkau, D., Calvert, W., Stirling, I., Strobeck, C. 1995. Microsatellite analysis of population structure in Canadian polar bears. *Molecular Ecology*, vol. 4, no. 3, p. 347-354. <https://doi.org/10.1111/j.1365-294X.1995.tb00227.x>
[PMid:7663752](https://doi.org/10.1111/j.1365-294X.1995.tb00227.x)
- Poczai, P., Varga, I., Laos, M., Cseh, A., Bell, N., Valkonen, J. P., Hyvonen, J. 2013. Advances in plant gene-targeted and functional markers: a review. *Plant Methods*, vol. 9, no. 1, p. 6. <https://doi.org/10.1186/1746-4811-9-6>
[PMid:23406322](https://doi.org/10.1186/1746-4811-9-6)
- Que, Y., Pan, Y., Lu, Y., Yang, C., Yang, Y., Huang, N., Xu, L. 2014. Genetic Analysis of Diversity within a Chinese Local Sugarcane Germplasm Based on Start Codon Targeted Polymorphism. *BioMed Research International*, vol. 2014, p. 1-10. <https://doi.org/10.1155/2014/468375>
[PMid:24779012](https://doi.org/10.1155/2014/468375)
- Rajesh, M. K., Sabana, A. A., Rachana, K. E., Rahman, S., Jerard, B. A., Karun, A. 2015. Genetic relationship and diversity among coconut (*Cocos nucifera* L.) accessions revealed through SCoT analysis. *3 Biotech*, vol. 5, no. 6, p. 999-1006.
- Satya, P., Karana, M., Jana, S., Mitraa, S., Sharma, A., Karmakar, P. G., Rayb, D. P. 2015. Start codon targeted (SCoT) polymorphism reveals genetic diversity in wild and domesticated populations of ramie (*Boehmeria nivea* L. Gaudich.), a premium textile fiber producing species. *Meta Gene*, vol. 3, p. 62-70. <https://doi.org/10.1016/j.mgene.2015.01.003>
[PMid:25750860](https://doi.org/10.1016/j.mgene.2015.01.003)
- Shahlaei, A., Torabi, S., Khosroshahli, M. 2014. Efficiency of SCoT and ISSR markers in assessment of tomato (*Lycopersicon esculentum* Mill.) genetic diversity. *International Journal of Biosciences*, vol. 5, no. 2, p. 14-22. <https://doi.org/10.12692/ijb/5.2.14-22>
- Tsaballa, A., Ganopoluos, I., Timplalexi, A., Alik, X., Bosmali, I., Irini, N. O., Athanasios, T. Madesis, P. 2015. Molecular characterization of Greek pepper (*Capsicum annum* L.) landraces with neutral (ISSR) and gene-based (SCoT and EST-SSR) molecular markers. *Biochemical Systematics and Ecology*, vol. 59, p. 256-263. <https://doi.org/10.1016/j.bse.2015.02.005>
- Vivodík, M., Gálová, Z., Balážová, Ž., Petrovičová, L. 2016. Start codon targeted (scot) polymorphism reveals genetic diversity in European old maize (*Zea mays* L.) genotypes. *Potravinárstvo*, vol. 10, no. 1, p. 563-569. <https://doi.org/10.5219/660>
- Weber, J. L. 1990. Informativeveness of human (dC-dA)n x (dG-dT)n polymorphism. *Genomics*, vol. 7, no. 4, p. 524-530. [https://doi.org/10.1016/0888-7543\(90\)90195-Z](https://doi.org/10.1016/0888-7543(90)90195-Z)
- Weir, B. S. 1990. *Genetic data analysis*. Sunderland, Massachusetts : Sinauer Associated, 445 p, ISBN 0 87893 871 00 87893.
- Xiong, F., Zhong, R., Han, Z., Jiang, J., He, L., Zhuang, W., Tang, R. 2011. Start codon targeted polymorphism for evaluation of functional genetic variation and relationships in cultivated peanut (*Arachis hypogaea* L.) genotypes. *Molecular Biology Reports*, vol. 38, no. 5, p. 3487-3494. <https://doi.org/10.1007/s11033-010-0459-6>
[PMid:21104441](https://doi.org/10.1007/s11033-010-0459-6)
- Zhang, J., Xie, W., Wang, Y., Zhao, X. 2015. Potential of Start Codon Targeted (SCoT) Markers to Estimate Genetic Diversity and Relationships among Chinese *Elymus sibiricus* Accessions. *Molecules*, vol. 20, no. 4, p. 5987-6001. <https://doi.org/10.3390/molecules20045987>
[PMid:25853316](https://doi.org/10.3390/molecules20045987)

Acknowledgments:

This work was funded by KEGA project No 021SPU-4/2015.

Contact address:

Želmíra Balážová, Slovak University of Agriculture, Faculty of Biotechnology and Food Sciences, Department of Biochemistry and Biotechnology, Tr. A. Hlinku 2, 949 76 Nitra, Slovakia, E-mail: zelmira.balazova@uniag.sk

Martin Vivodík, Slovak University of Agriculture, Faculty of Biotechnology and Food Sciences, Department of Biochemistry and Biotechnology, Tr. A. Hlinku 2, 949 76 Nitra, Slovakia, E-mail: martin.vivodik@uniag.sk

Zdenka Gálová, Slovak University of Agriculture, Faculty of Biotechnology and Food Sciences, Department of Biochemistry and Biotechnology, Tr. A. Hlinku 2, 949 76 Nitra, Slovakia, E-mail: zdenka.galova@uniag.sk.

Lenka Petrovičová, Slovak University of Agriculture, Faculty of Biotechnology and Food Sciences, Department of Biochemistry and Biotechnology, Tr. A. Hlinku 2, 949 76 Nitra, Slovakia, E-mail: lenka.petrovicova@uniag.sk.

Radomíra Hornyák Gregáňová, Slovak University of Agriculture, Faculty of Economics and Management, Department of Mathematics, Tr. A. Hlinku 2, 949 76 Nitra, Slovakia, E-mail: radomira.greganova@uniag.sk



DETECTION OF OVINE MILK ADULTERATION USING TAQMAN REAL-TIME PCR ASSAY

Marek Šnirc, Tomáš Fekete, Eubomír Belej, Radoslav Židek, Jozef Golian, Peter Haščík, Peter Zajác, Jozef Čapla

ABSTRACT

Food safety, quality and composition have become the subjects of increasing public concern. To prevent fraud and enhance quality assurance, credible analysis of dairy products is crucial. Bovine milk is more widely available and cheaper than milk of sheep and goat. Bovine milk is also processed in large quantities to produce a range of dairy produce. DNA-based methods have proven to be more reliable, because of the stability of DNA under the conditions of high temperature, high pressure, and chemical treatment used during the processing of some food products. The commercial InnuDETECT cheese assay based on the principle TaqMan real-time PCR systems have been tested for the identification and quantification of bovine DNA in ovine milk samples. DNA was extracted using the InnuPREP DNA Mini Kit and quantified by the QuantiFluor dsDNA system. The assay showed good linearity, with correlation coefficient of $R^2 = 0.983$ and efficiency of 86%. The internal control amplified fragment from different mammalian species (cow, sheep and goat), with similar C_T values. Detection of bovine DNA in milk mixtures was achieved even in samples containing 0.5% of bovine milk. The InnuDETECT cheese assay has been successfully used to measure bovine DNA in ovine milk, and will prove useful for bovine species identification and quantitative authentication of animal-derived products.

Keywords: TaqMan PCR; Cow; Sheep; Milk adulteration

INTRODUCTION

Nowadays, consumers are more and more interested in the topic of wholesomeness and authenticity of food, so the identification of the animal species is gaining increasing importance (Dalmasso, Sacchi and Bottero, 2012). Dairy field is subjected to growing number of frauds (Kemal Seçkin, Yilmaz and Tosun, 2017).

Differences in price and seasonal availability might make it attractive for farmers to adulterate expensive ovine milk with cheaper bovine milk (López-Calleja et al., 2007). Besides, milk origin is important in cheese making, especially those made from one pure species and with protected designation of origin, such as pure ovine or pure caprine cheese. In addition, some cheeses are manufactured with defined amounts of each type of milk (Mafra, Ferreira and Oliveira, 2007).

European Regulations require that producers declare the type of milk used in manufacturing. Unintentional mislabelling may also occur when several species are handled on the same manufacturing equipment (Di Domenico et al., 2017; Kemal Seçkin, Yilmaz and Tosun, 2017). Whether fraudulent or unintentional, compliance of dairy products with the Regulations is mandatory since mislabelled products give rise to

economic loss and possible dangers to public health because milk proteins from any animals (most commonly bovine) are potential allergens (Agrimonti et al., 2015; (Di Domenico et al., 2017).

Unfortunately, in the market, milk origin cannot be identified by consumers looking at the name of the product. Therefore, there has been huge effort to develop and improve analytical methods for milk authentication. The official EU reference method, which is based on the isoelectrofoculation of γ -caseins, is an appropriate tool to detect bovine milk in products made from milk of other species (detection limit $\leq 0.5\%$) (Mayer, Bürger and Kaar, 2012). Other protein-based approaches include ELISA (López-Calleja et al., 2007; Costa et al., 2008; Zeleňáková et al., 2016) and HPLC (Mayer, 2005; Motta et al., 2014).

In recent years, significant attention has been turning towards DNA-based approaches, which have proven to be reliable, sensitive and fast for many aspects of food authentication (Mayer, 2005). The amount of DNA recoverable from milk and milk products is directly related to the somatic cell content of the raw milk and to the strength of the technique used to process the product,

because this can influence the integrity and the extractability of the DNA (Rea et al., 2001).

Traceability of foods has become very important problem respect to food quality and typicalness of foods. Milk origin cannot be identified by the consumer and they are sold at different prices under various product names. Recently, this has caused the problem of 'adulteration' (Kemal Seçkin, Yilmaz and Tosun, 2017).

Among them, the polymerase chain reaction (PCR) is undoubtedly the most common genetic technique used for tracing the species origin in food because DNA is extremely persistent during food processing and can retain sequence-specific information retrievable after an amplification (Agrimonti et al., 2015).

As DNA can be obtained from thermally treated milks such as, pasteurised milk, ultra-pasteurised and powder milks, as well as bovine milk caseinates, cheese adulterations by partial or total substitution of non-declared milk species can be easily detected by PCR techniques (Mafra, Ferreira and Oliveira, 2007). If the somatic cell content in a mixture (milk or cheese) is similar in the two species, it should be possible to quantitatively trace the amount of undeclared milk by comparing the sample to well-known standard DNA mixtures (Rea et al., 2001).

Molecular techniques using DNA technology to combat fraud, improve traceability and distinguish between closely related species are being increasingly utilised in food forensic analysis (Caldwell, 2017).

A successful PCR assay depends largely on the quality of extracted DNA; thus, extraction of high-quality DNA has been a crucial step in the authentication process. Numerous DNA extraction methods have been used for the preparation of DNA from milk, including research protocols and commercial kits (Liu et al., 2014; Liao et al., 2017; Pokorska et al., 2016).

In the study, a commercial kit for real-time PCR was used to test reliability of quantification of bovine milk in prepared milk mixtures.

MATERIAL AND METHODOLOGY

Sample preparation

Fresh and processed commercial cow and sheep milks were purchased from several national food retailers and/or producers in Nitra, SVK. Samples were transported to the laboratory and stored at 4 °C. Milk mixtures of cow's milk in sheep milk were prepared for further DNA extraction and PCR analysis. Five different mixtures, containing 50, 10, 5, 1, and 0,5% (v/v) cow's milk, were prepared in a final volume of 1 mL.

DNA extraction

DNA was extracted using the InnuPREP DNA Mini Kit

(Analytik Jena, Jena, Germany) rendering an elution volume of 250 µL DNA according to the manufacturer's instruction. DNA samples were quantified using the QuantiFluor dsDNA system (Promega) with Quantus™ Fluorometer (Promega).

Real-time PCR reaction

With the InnuDETECT Cheese Assay, cattle and sheep species were identified by using specific primers complementary to the cattle and sheep species. An internal positive control was incorporated in the InnuDETECT Cheese Assay kit. The internal control coamplified with the primers used for the qPCR reaction. PCR amplification was performed according to the manufacturer's recommendations by adding 10 µL 2x MasterMix, 3 µL Primer/Probe Mix cattle (sheep), 1 µL Internal control, 5 µL of sample and the mixture was filled up to 20 µL. Real-time qPCR assay was performed with a LightCycler (Roche, Germany) based on the TaqMan principle. Cattle and sheep DNA have been detected in separated tubes (FAM channel) in order to reach the maximum sensitivity. Internal Control was used as an amplification control (HEX channel). Real-time PCR cycling parameters were optimized based on manufacturer's manual: Initial denaturation 95 °C, 120 s, followed 40 by cycles of 95 °C 10 s of denaturation, 62 °C 45s of annealing/elongation and finally, absolute quantification analysis.

Data analysis

Primary real-time PCR data were analysed by the LightCycler Software 4.1.1.21 (Roche, Germany) and the threshold cycle (C_T) was calculated. C_T values of standard curve replicates (Y) and \log_{10} (DNA amount) (X) were analysed using XLSTAT (Addinsoft, 2016) software and a linear regression equation of the C_T value plotted against the \log_{10} (DNA amount) was calculated.

RESULTS AND DISCUSSION

Sensitivity and efficiency of qPCR assay

DNA extracted from a sample of 100% cow milk was used for the sensitivity and efficiency determination of the TaqMan real-time PCR assay. Linear range of positive amplification for the cow milk assay was achieved over five log units, which extended from 10 ng to 0,001 ng bovine DNA (Figure 1, Table1).

Parameters of the model for calibration curve are shown in Table 2. The assay showed good linearity, with correlation coefficient of $R^2 = 0.983$ and efficiency of 86%. López-Calleja et al. (2007) observed the correlation between the two variables, C_t and logarithm of cow's DNA concentration, using the plasmid cow DNA as standard a determination coefficient value of 0.9955. The initial somatic cell content was not known for ovine milk

Table 1 Sensitivity of cow-specific assay.

Dilution (%)	DNA amount (ng)	\log_{10} (DNA amount)	Mean $C_T \pm SD$
100	10	1.00	23.36 ± 0.23
10	1	0.00	26.54 ± 0.08
1	0.1	-1.00	32.09 ± 0.37
0.1	0.01	-2.00	34.90 ± 0.16
0.01	0.001	-3.00	37.80 ± 0.21

Table 2 Parameters of the model.

Source	Value	Standard error	t	Pr > t	Lower bound (95% CI)	Upper bound (95% CI)
Intercept	27.214	0.234	116.272	<0.01	26.708	27.720
Slope	-3.724	0.135	-27.558	<0.01	-4.016	-3.432

Table 3 Mean C_T values and mean absolute amount of cattle DNA in milk mixtures as predicted by the model.

cow/sheep mixture (v/v)	CT \pm SD	DNA \pm 95% CI (ng)
50	28.81 \pm 0.25	4.15 \pm 1.47
10	30.86 \pm 0.30	0.65 \pm 1.34
5	31.28 \pm 0.05	0.15 \pm 1.29
1	32.23 \pm 0.16	0.05 \pm 1.30
0.5	37.21 \pm 0.22	0.0022 \pm 1.48

Note: CT – Cycle treshold; SD – Standard deviation; CI – Confidence interval.

because in European Union there is no maximum limit for the number of somatic cells. The maximum limit for the number of somatic cells in raw bovine milk is $\leq 400\,000$ per mL, according to Regulation (EC) No. 1662/2006 of the European parliament and of the council laying down specific hygiene rules for food of animal origin.

Rentsch et al. (2012) developed and interlaboratory validated two multiplex TaqMan real-time PCR assays to determine DNA of bovine, ovine and caprine in milk and cheese. For caprine DNA, milk and cheese assays showed amplification efficiency of 85% and 116%, respectively. Linear detection and quantification range was 0.32 – 32 ng of sheep DNA ($R^2 = 0.97$).

Specificity

Detection system was tested for its selectivity and cross reactions to other milk-producing species. The cow-specific system amplified fragment from cow DNA, whereas no amplification was obtained from sheep and

goat DNA. The internal control amplified fragment from different mammalian species (cow, sheep and goat), with similar C_T values.

Quantification of bovine DNA in milk mixtures

Table 3 summarises mean CT values for individual milk mixtures and total bovine DNA content as predicted by linear regression model. Amount of amplified DNA in all mixtures corresponded to ~ 10 ng DNA. Detection of bovine DNA in milk mixtures was achieved even in samples containing 0.5% of cows' milk.

The authenticity assessment of dairy products is an important issue regarding the consumer's interests due not only to the economic point of view, but also to medical requirements, food allergies or religious practices (Mafra, Ferreira and Oliveira, 2007).

Polymerase Chain Reaction (PCR), single-plex PCR and quadru-plex PCR, are suitable methods to detect animal species origin in milk and in dairy products. At the

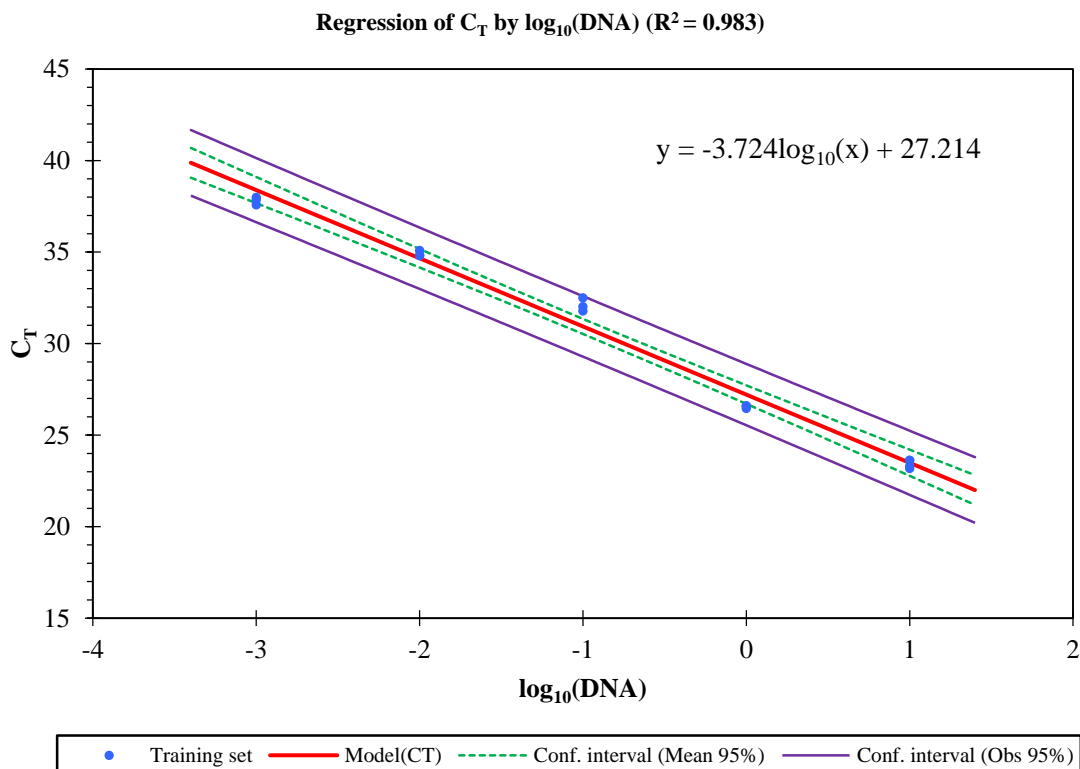

Figure 1 Calibration curve.

purpose, single-plex (Agrimonti et al., 2015; Bania et al., 2001; Cozzolino et al., 2002), duplex (Mafra et al., 2007), and triplex end-point PCR have been used (Geng, 2014).

Klančnik et al. (2015) took an addition of >5% bovine milk as the limit for fraudulent addition of bovine milk to these caprine and ovine cheeses. We achieve detection limit for addition bovine milk in sheep milk 0.5%.

Fluorescence can be measured throughout the PCR, providing real-time analysis of the reaction kinetics and allowing quantification of specific DNA targets. Realtime PCR also offers a lower potential for contamination of the PCR mixture with target DNA because the reaction tubes remain closed throughout the assay. Moreover, the threshold cycle is observed when PCR amplification is still in the exponential phase and none of the reaction components is limited. This is the main reason why Ct is a more reliable measure of starting DNA copy number than an endpoint measurement of the amount of accumulated PCR product (Rodríguez et al., 2004; López-Calleja et al., 2007).

Real-time analysis can facilitate quantification of the amount of cow DNA present in the sample by ascertaining when (i.e., during which PCR cycle) fluorescence in a given reaction tube exceeds that of a threshold (threshold cycle (Ct)). Comparison between reaction tubes and known standards allows quantification of cows' milk content present in a given sample (López-Calleja et al., 2007).

The specificity and sensitivity of the real-time quantitative polymerase chain reaction (PCR), combined with its high speed, robustness, reliability, and the possibility of automation (Heid et al., 1996; López-Calleja et al., 2007).

Mininni et al. (2009), developed a TaqMan real-time PCR assay to detect and quantify bovine milk in ovine and caprine cheeses, based on two target genes. The *cyt-b* gene of *Bos taurus* was used to detect and quantify bovine DNA. The nuclear gene *Myo*, *mt18S* rRNA and *mt16S* rRNA were used alternatively as universal reference markers. Caprine (n = 30) and ovine (n = 51) cheese samples were purchased and analysed and most were shown to be contaminated by bovine milk. Regarding the sensitivity, the limit of detection of *cyt-b* assay for bovine DNA corresponded to 0.2% (v/v) of bovine for standard caprine and ovine cheeses. The limit of detection of 16S assay for bovine DNA corresponded to 0.5% (v/v) for ovine cheese, the 0.5% (v/v) for ovine cheese obtained by the 16S assay, the 1% (v/v) for the 16S assay in caprine cheese. The limit of quantification of *Myo* and 18S assays was 1% (v/v) for both species.

Branciarri et al. (2000) developed PCR-RFLP system for cytochrome b (*cyt-b*) gene to investigate the adulteration rate of feta cheeses, made from mixture of ovine and caprine milk, with less expensive bovine milk. The restriction enzymes *HaeIII* and *Sau3AI* differentiated DNA of bovine, ovine, and caprine milk. The limit of detection of undeclared milk admixture was about 1% for all tested samples.

Zeleňáková et al. (2009) have analysed 70 milk and cheese samples by using PCR method. From twenty samples of the analysed sheep milk samples, cow milk

occurrence was detected in eight samples. From the thirty samples of sheep cheese, eleven samples contained a mixture of the cow milk.

CONCLUSION

The uptake of real-time PCR system by the food industry depends on its technical advantages and relatively low cost. The TaqMan real-time PCR system for the identification of milks is sensitive, quick and safe. Its capability to detect low levels of bovine DNA will meet the standard required by many authentication measurements. If the somatic cell content in a mixture of bovine and ovine milk is similar, it should be possible to quantitatively trace the amount of undeclared milk by comparing the sample to well-known DNA mixture standard. From practical point of view, in the mixtures of sheep and bovine milk the volume of both kind of milk can be different and also the concentration of somatic cells in both kind of milk can be different as well. This mean, this method ca is not suitable for quantification purposes because mainly due to the factor of different concentration of somatic cells in both kind of milk.

The InnuDETECT cheese array based on bovine and sheep specific primers and probes has been used to measure DNA amounts in commercial milks. The InnuDETECT cheese array reported herein gives reasonably accurate and reproducible estimates, it may be used to detect minimal amounts of cow's milk in milk mixtures, which is important for a variety of economic, religious and health reasons. We recommend to use this method for the purpose of qualitative determination only.

REFERENCES

- Agrimonti, C., Pirondini, A., Marmiroli, M., Marmiroli, N. 2015. A quadruplex PCR (qxPCR) assay for adulteration in dairy products. *Food Chemistry*, vol. 187, no. 15, p. 58-64. <http://dx.doi.org/10.1016/j.foodchem.2015.04.017>
- Bania, J., Ugorski, M., Polanowski, A. And Adamczyk, E. 2001. Application of polymerase chain reaction for detection of goats' milk adulteration by milk of cow. *Journal of Dairy Research*, vol. 68, no 2, p. 333-336. <http://dx.doi.org/10.1017/s0022029901004708>
- Branciarri, R., Nijman, I., Plas, M., Di Antonio, E., Lenstra, J. 2000. Species Origin of Milk in Italian Mozzarella and Greek Feta Cheese. *Journal Of Food Protection*, vol. 63, no. 3, p. 408-411. <http://dx.doi.org/10.4315/0362-028x-63.3.408>
- Caldwell, J. 2017. Food Analysis Using Organelle DNA and the Effects of Processing on Assays. *Annual Review Of Food Science And Technology*, vol. 8, no. 1, p. 57-74. <http://dx.doi.org/10.1146/annurev-food-030216-030216>
- Commission Regulation (EC) No 1662/2006 of 6 November 2006 amending Regulation (EC) No 853/2004 of the European Parliament and of the Council laying down specific hygiene rules for food of animal origin (Text with EEA relevance). *OJ L 320*, 18.11.2006, p. 1–10.
- Costa, N., Ravasco, F., Miranda, R., Duthoit, M., Roseiro, L. 2008. Evaluation of a commercial ELISA method for the quantitative detection of goat and cow milk in ewe milk and cheese. *Small Ruminant Research*, vol. 79, no. 1, p. 73-79. <http://dx.doi.org/10.1016/j.smallrumres.2008.07.012>
- Cozzolino, R., Passalacqua, S., Salemi, S. and Garozzo, D. 2002. Identification of adulteration in water buffalo mozzarella and in ewe cheese by using whey proteins as biomarkers and matrix-assisted laser desorption/ionization

- mass spectrometry. *Journal of Mass Spectrometry*, vol. 37, no. 9, p. 985-991. <http://dx.doi.org/10.1002/jms.358>
- Dalmasso, A., Sacchi, P., Bottero, M. 2012. Development of a real-time PCR assay for the detection of cow and donkey milk. *European Food Research and Technology*, vol. 235, no. 1, p. 47-52. <http://dx.doi.org/10.1007/s00217-012-1732-9>
- Di Domenico, M., Di Giuseppe, M., Wicochea Rodríguez, J., Cammà, C. 2017. Validation of a fast real-time PCR method to detect fraud and mislabeling in milk and dairy products. *Journal of Dairy Science*, vol. 100, no. 1, p. 106-112. <http://dx.doi.org/10.3168/jds.2016-11695>
- Geng, Q. 2014. A duplex polymerase chain reaction assay for the identification of goat cashmere and sheep wool. *Mitochondrial DNA*, vol. 27, no. 3, p. 1-4. <http://dx.doi.org/10.3109/19401736.2014.963823>
- Heid, C., Stevens, J., Livak, K. and Williams, P. 1996. Real time quantitative PCR. *Genome Research*, vol. 6, no. 10, p. 986-994. <http://dx.doi.org/10.1101/gr.6.10.986>
- Kemal Seçkin, A., Yilmaz, B., Tosun, H. 2017. Real-time PCR is a potential tool to determine the origin of milk used in cheese production. *LWT - Food Science and Technology*, vol. 77, p. 332-336. <http://dx.doi.org/10.1016/j.lwt.2016.11.065>
- Klančnik, A., Toplak, N., Kovač, M., Ogrinc, N., Jeršek, B. 2015. Robust PCR-based method for quantification of bovine milk in cheeses made from caprine and ovine milk. *International Journal of Dairy Technology*, vol. 69, no. 4, p. 540-549. <http://dx.doi.org/10.1111/1471-0307.12287>
- Liao, J., Liu, Y. F., Ku, T., Liu, M. H., Huang, Y. 2017. "Qualitative And Quantitative Identification Of Adulteration Of Milk Powder Using DNA Extracted With A Novel Method". *Journal of Dairy Science*, vol. 100, no. 3, p. 1657-1663. <http://dx.doi.org/10.3168/jds.2016-11900>
- Liu, Y., Gao, J., Yang, Y., Ku, T., Zan, L. 2014. Novel extraction method of genomic DNA suitable for long-fragment amplification from small amounts of milk. *Journal of Dairy Science*, vol. 97, no. 11, p. 6804-6809. <http://dx.doi.org/10.3168/jds.2014-8066>
- López-Calleja, I., González, I., Fajardo, V., Hernández, P., García, T., Martín, R. 2007. Application of an indirect ELISA and a PCR technique for detection of cows' milk in sheep's and goats' milk cheeses. *International Dairy Journal*, vol. 17, no. 1, p. 87-93. <http://dx.doi.org/10.1016/j.idairyj.2006.01.006>
- López-Calleja, I., González, I., Fajardo, V., Martín, I., Hernández, P. E., García, T., Martín, R. 2007. Quantitative detection of goats' milk in sheep's milk by real-time PCR. *Food Control*, vol. 18, no. 11, p. 1466-1473. <http://dx.doi.org/10.1016/j.foodcont.2006.11.006>
- López-Calleja, I., González, I., Fajardo, V., Martín, I., Hernández, P., García, T. and Martín, R. 2007. Real-time TaqMan PCR for quantitative detection of cows' milk in ewes' milk mixtures. *International Dairy Journal*, vol. 17, no. 7, p. 729-736. <http://dx.doi.org/10.1016/j.idairyj.2006.09.005>
- Mafra, I., Ferreira, I., Oliveira, M. 2007. Food authentication by PCR-based methods. *European Food Research and Technology*, vol. 227, no. 3, p. 649-665. <http://dx.doi.org/10.1007/s00217-007-0782-x>
- Mininni, A., Pellizzari, C., Cardazzo, B., Carraro, L., Balzan, S., Novelli, E. 2009. Evaluation of real-time PCR assays for detection and quantification of fraudulent addition of bovine milk to caprine and ovine milk for cheese manufacture. *International Dairy Journal*, vol. 19, no. 10, p. 617-623. <http://dx.doi.org/10.1016/j.idairyj.2009.04.003>
- Mayer, H. 2005. Milk species identification in cheese varieties using electrophoretic, chromatographic and PCR techniques. *International Dairy Journal*, vol. 15, no. 6-9, p. 595-604. <http://dx.doi.org/10.1016/j.idairyj.2004.10.012>
- Mayer, H., Bürger, J., Kaar, N. 2012. Quantification of cow's milk percentage in dairy products – a myth? *Analytical and Bioanalytical Chemistry*, vol. 403, no. 10, p. 3031-3040. <http://dx.doi.org/10.1007/s00216-012-5805-1>
- Motta, T., Hoff, R., Barreto, F., Andrade, R., Lorenzini, D., Meneghini, L., Pizzolato, T. 2014. Detection and confirmation of milk adulteration with cheese whey using proteomic-like sample preparation and liquid chromatography–electrospray–tandem mass spectrometry analysis. *Talanta*, vol. 120, p. 498-505. <http://dx.doi.org/10.1016/j.talanta.2013.11.093>
- Pokorska, J., Kułaj, D., Dusza, M., Żychlińska-Buczek, J., Makulska, J. 2016. New Rapid Method of DNA Isolation from Milk Somatic Cells. *Animal Biotechnology*, vol. 27, no. 2, p. 113-117. <http://dx.doi.org/10.1080/10495398.2015.1116446>
- Rea, S., Chikuni, K., Branciari, R., Sangamayya, R., Ranucci, D., Avellini, P. 2001. Use of duplex polymerase chain reaction (duplex-PCR) technique to identify bovine and water buffalo milk used in making mozzarella cheese. *Journal of Dairy Research*, vol. 68, no. 4, p.689-698. <http://dx.doi.org/10.1017/s0022029901005106>
- Rentsch, J., Weibel, S., Ruf, J., Eugster, A., Beck, K., Köppel, R. 2012. Interlaboratory validation of two multiplex quantitative real-time PCR methods to determine species DNA of cow, sheep and goat as a measure of milk proportions in cheese. *European Food Research And Technology*, vol. 236, no. 1, p. 217-227. <http://dx.doi.org/10.1007/s00217-012-1880-y>
- Rodríguez, M., García, T., González, I., Asensio, L., Hernández, P., Martín, R. 2004. Quantitation of Mule Duck in Goose Foie Gras Using TaqMan Real-Time Polymerase Chain Reaction. *Journal of Agricultural and Food Chemistry*, vol. 52, no. 6, p. 1478-1483. <http://dx.doi.org/10.1021/jf035240n>
- Zeľňáková, L., Šesták M., Židek, R. 2009. Monitoring of sheep milk and milk products adulteration on common european food market. *Potravinárstvo*, vol. 3, no. 2, p. 69-73.
- Zeľňáková, L., Židek, R., Čanigová, M., Žiarovská, J., Zajác, P., Maršáľková, L., Fikselová M., Golian J. 2016. Research And Practice: Quantification Of Raw And Heat-Treated Cow Milk in Sheep Milk, Cheese And Bryndza By ELISA Method. *Potravinárstvo*, vol. 10, no. 1, p. 14-22. <http://dx.doi.org/10.5219/566>

Acknowledgments:

This work was supported by grant VEGA no. 1/0316/15.

Contact address:

Marek Šnirc, Slovak University of Agriculture, Faculty of Biotechnology and Food Sciences, Department of Evaluation and Processing of Animal Products, Tr. A. Hlinku 2, 949 76 Nitra Slovakia, E-mail: marek.snirc@uniag.sk

Tomáš Fekete, Slovak University of Agriculture, Faculty of Biotechnology and Food Sciences, Department of Hygiene and Food Safety, Tr. A. Hlinku 2, 949 76 Nitra Slovakia, E-mail: xfeketet@uniag.sk

Lubomír Belej, Slovak University of Agriculture, Faculty of Biotechnology and Food Sciences, Department of Hygiene and Food Safety, Tr. A. Hlinku 2, 949 76 Nitra Slovakia, E-mail: lubomir.belej@uniag.sk

Radoslav Židek, Slovak University of Agriculture, Faculty of Biotechnology and Food Sciences, Department of Hygiene and Food Safety, Tr. A. Hlinku 2, 949 76 Nitra Slovakia, E-mail: radoslav.zidek@uniag.sk

Jozef Golian, Slovak University of Agriculture, Faculty of Biotechnology and Food Sciences, Department of Hygiene and Food Safety, Tr. A. Hlinku 2, 949 76 Nitra Slovakia, E-mail: jozef.golian@uniag.sk

Peter Haščík, Slovak University of Agriculture, Faculty of Biotechnology and Food Sciences, Department of Evaluation and Processing of Animal Products, Tr. A.

Hlinku 2, 949 76 Nitra Slovakia, E-mail: peter.hascik@uniag.sk

Peter Zajác, Slovak University of Agriculture, Faculty of Biotechnology and Food Sciences, Department of Hygiene and Food Safety, Tr. A. Hlinku 2, 949 76 Nitra Slovakia, E-mail: peter.zajac@uniag.sk

Jozef Čapla, Slovak University of Agriculture, Faculty of Biotechnology and Food Sciences, Department of Hygiene and Food Safety, Tr. A. Hlinku 2, 949 76 Nitra Slovakia, E-mail: jozef.capla@uniag.sk



NITRATE AND NITRITE CONTENTS IN IN THE PRIVATE GROUND WATER WELLS

Mária Angelovičová, Zuzana Szabóová, Jana Tkáčová, Marek Angelovič

ABSTRACT

The aim of the study was to investigation and statistical evaluation of nitrate and nitrite in ground sources of drinking water, particularly in private wells and springs in the surroundings of town Nitra, in the river basin Žitava. Samples were taken in the spring month May and the autumn month October of the same water sources. The contents of nitrate and nitrite was determined by test strips QUANTOFIX Nitrate and nitrite. The results were evaluated in the system SAS program, version 8.2. The difference of nitrate in drinking water sources between spring and autumn months was statistically evaluated by t-test. The nitrate content in drinking water samples taken from the surroundings of town Nitra, in the river basin Žitava, was measured in the spring month of May with exceeding values that exceeded the 50 mg.L^{-1} , which is the limit value for the adult human population, in the well of municipalities Veľká Maňa, Žitavce, Michal nad Žitavou, Malá Maňa, Uľany nad Žitavou, Hul, Kmeťovo and 50 mg.L^{-1} was measured in spring Vikas, in well of municipality Lúčnica nad Žitavou, Veľká Maňa, part of the Stará Hora. In the autumn month October measured nitrate content was reduced in samples taken in the municipalities Lúčnica nad Žitavou, Malá Maňa, Kmeťovo and Uľany nad Žitavou. The difference of nitrate content in water from water sources investigated in surroundings of town Nitra was not statistically significant ($p > 0.05$) between the months May and October. The nitrite content in the same water sources in the surrounding of town Nitra was not detected.

Keywords: water; well; private; nitrate; nitrite

INTRODUCTION

The European Charter on Water, which was announced May 6, 1968 in Strasbourg, including the text, which is important for the understanding of water protection, and that there is no life without water and the water pollution is harmful to humans, so water resources need to be examined, checked and, if necessary, taken measures for their improvement.

The European Food Safety Authority – dietetic products, nutrition and allergies (NDA) (EFSA, 2010) elaborated on the request of the European Commission a scientific opinion on the reference water intake. Water is consumed from diverse sources, which include drinking water (from the faucet and bottled water), water in foods, drinks, water from the oxidation of nutrients in the human body. Water intake from foods and drinks can be defined as the total water intake, the sum of total water intake and water from the oxidation of nutrients is the overall disposition of water.

Characteristics of nitrates and nitrites

Nitrates and nitrites are naturally occurring ions that are part of the nitrogen cycle. The nitrate ion (NO_3^-) is a stable form. Chemically, non-reactive, but the state can be changed by microbial action. Nitrite ion (NO_2^-) containing nitrogen in a relatively unstable oxidation state. Chemical and biological processes may further change nitrite into various compounds or oxidize it into nitrate (ICAIR Life Systems, Inc., 1987).

Nitrate concentrations in natural waters based on different diffuse sources, such as the atmosphere, the wildlife and naturally derived from the degradation of soil organic matter in environment. The term nitrate was defined as the range of concentrations of NO_3^- only from natural sources. However, this term shall also include the organic matter in the soil from the rest of fertilized and non-fertilized crops, products of combustion and the evaporation of ammonia (NH_3) from synthetic and organic nitrogenous fertilizers and animal waste, other than naturally-derived NO_3^- (Panno et al., 2006).

Some studies have defined values for nitrates, which is to determine the limit. If the nitrate concentration exceeds the

limit, it can only be attributed to anthropogenic induced process (Matschullat et al., 2000).

The occurrence of nitrates in drinking water and sources of drinking water pollution by nitrates

The occurrence of nitrate in drinking water is mainly associated with the use of inorganic fertilizers in agriculture. Nitrates are used as well as an oxidizing agent, potassium nitrate is used in the manufacture of glass, and sodium nitrite is used as a preservative in the production of smoked meat. Sometimes they can be added to foods and serve as a reservoir for nitrite. An excess nitrates easily passes into ground water (Van Duijvenboden a Matthijsen, 1989).

Under aerobic conditions, the nitrates penetrate a relatively large amount into water resources in the soil, where there it does not grow the plant material. Nitrate can advance all the way to the lower layers of soil. Degradation or denitrification occurs only to a small extent in soil and rocks, where there is ground water. Under anaerobic conditions, nitrate may be degraded or almost completely denitrified to nitrogen. The presence of high or low mineral water, the amount of rain water, of other organic compounds, and physicochemical properties of the water are also important in the identification and evaluation of nitrates in soil (Van Duijvenboden a Loch, 1983; Fewtrell, 2004; Dubrovský a Hamilton, 2010).

The occurrence of nitrates in drinking water in Slovak republic

The average concentration of nitrate in the years from 1991 to 1995 in ground water of Slovakia accounted $36.17 \pm 71.25 \text{ mg.L}^{-1}$ and a median 8.8 mg.L^{-1} . It is the result of a very specific distribution of the whole set of values, as nearly a third of the samples showed values lower than 3.0 mg.L^{-1} , and to almost 55% of the samples had nitrate concentrations below or equal to 11.3 mg.L^{-1} . These lower concentrations are implicitly linked to the mountain areas and in some cases (particularly in the case of the Danube River) to coast zone of surface water infiltration (Rapant et al., 1996).

Reduced nitrate content according to the Water Research Institute in Bratislava in the years 2003 – 2011 was due to lower average application of nitrogen fertilizers and the reduction of agricultural lands. The results showed that the increase of nitrates in ground water in Slovakia slowed, not only due to the decline in agricultural production, but also as a result of implementation of the measures in accordance with Directive 2000/60/EC of the European Parliament and of the Council of 23 October 2000 and other measures. It proves the assessment of the development trends in nitrate content compared with the previous period (2004 – 2007). The reduction in average concentrations of NO_3^- in ground water was found in 34% of evaluable subjects. The largest share recorded a stable development trend (45%) and an increasing trend of nitrate content was found in 21%. In many cases, however, it is lower than the concentration of 25 mg.L^{-1} . Effects of the implementation of the measures in housekeeping and in codes of good agricultural practice can be assumed that the extent of penetration of nitrogen into ground water should

not substantial increase in the coming years (Ondrejková, 2012).

Endangering human health caused by nitrates from water

The priority of all government policies around the globe there is sufficient quantity to healthy water. Around 18% of the world population lives in an environment with poor as far as highly problematic water quality. The market of water and aquatic environments, but differs significantly from other commodity prices on the supply side. The amount of water on our planet it remains constant and its availability in some areas is severely restricted. Less than 2% of the total amount of water that is about 1.4 billion cubic kilometers is exploitable population. On the other hand, demand for water increases. According to World Health Organization and agencies of Deutsche Bank Research, which regularly monitors the global market for water management, it increased water consumption in the last 50 years to double. Average water consumption, however, remains the same per capita, which means that water consumption has increased drastically for industry, agriculture and adjacent sectors. The requirements for the amount of water increases, but the quality of health safe water decreases, due to it's the pollution. As a new source of drinking water pollution and in general all the water we can include hormonally active substances called endocrine disruptors and pharmaceuticals. Existing technologies to remove these harmful substances is either ineffective or too costly and intrusive to the environment. Annual estimate of financial volume worldwide market for water is about 250 billion US dollars, of which almost 20% is investment in the development and implementation of new technologies in water treatment (Černík a Zbořil, 2013).

The growing use of fertilizers, liquidation waste (mainly from livestock) and changes in land use are the main factors that lead to a gradual increase in the levels of nitrates in ground water over the past 20 years. In some areas of Denmark and the Netherlands, for example nitrate concentration increased about 0.2 to 1.3 mg.L^{-1} for one year (WHO, 1985).

Individual outbreaks of the agricultural areas of the world, which contribute to problems of toxicity of the nitrate, are related to the well water; often contain more than 50 mg.L^{-1} . Nitrite levels in drinking water it is usually achieved below 0.1 mg.L^{-1} (RIVM, 1993).

Factors influencing the occurrence of nitrates and nitrites in ground water

It is well known that ground water is a valuable natural resource which should be protected from deterioration and chemical pollution. However, the quality of ground water due to agricultural practices, population growth and economic development, the amount of nitrogen released into the subsurface from manure, waste and animal waste in the past decade has deteriorated. Because of the high solubility and mobility of nitrate through the water to the surface area of surface water their content increases, and they are a major threat to ground water and its contamination by nitrates (Igúzquiza et al., 2015).

Many studies include characterization of the factors that influence spatial distribution of soil nitrogen at different

scales, including climate, topography, soil type, type of land use and agricultural practices.

These factors are generally classified into two types:

- internal factors (such as basic materials, topography and soil types),
- external factors (including the type of land use and agricultural practices) (Mendes a Ribeiro, 2010).

In accordance with Lake et al. (2003) are factors that affect the vulnerability of ground water nitrate pollution are:

1. leaching, quantity and quality (nitrate concentration) of water, leaving the root of the crops grown on the land;
2. soil characteristics can reduce nitrate pollution or lead to horizontal movement of water;
3. variations in low-permeability coating surface deposits, namely glacial origin, or alluvial muds and clays, which can form an impermeable cover layer and thereby preventing the movement of water;
4. distinguish between the aquifer e.g. geological units, which are highly permeable and/or cracked, and thus vulnerable to pollution and those smaller units which have low permeability and non-aquifer i. e. geological units that were not considered to be a risk of contamination by nitrates given their negligible permeability and the potential for limiting nitrate transport from diffuse sources.

An inverse relation between the depth and the concentration of nitrate is consistent with previous studies of ground water. Earlier transcended nitrogen is usually in deep ground water and can come from a period of intensive use of fertilizers. In this area, a better opportunity for the denitrification of nitrate, because ground water requires more time to change into greater depths. Moreover, if the deeper the well, the more likely that the sample contain ground water mixture of nitrates, which transgressed at different times (Wheeler et al., 2015).

Topographic factors including altitude, inclination of the slope, the curvature of the vertical, horizontal curvature, the length of the slope, topography index of flow and moisture output, correlated significantly with soil properties and thus affect the penetration of the nitrate and nitrite in the ground water. The three most important variables are altitude, inclination, distance and length of the slope up to 1 km (Zhang et al., 2012).

Research suggests that the use of land by controlled cultivation and fertilization is another crucial factor for change nitrogen in the soil. This fact is among other factors affecting the quality of ground water in agricultural areas (Cesar a Roš, 2013).

In connection with the transfer of nitrates in ground water by Wang et al. (2015) the most important variable factors include depth of farmland, fertilizer and their variable group, duration of action, population density, aquifers and breeding of farm animals (with feeding).

Guideline values of nitrates and nitrites in drinking water

Guideline values by Government Regulation no. 354/2006 Coll. Slovak Republic, as amended by no. 496/2010 Coll. and 8/2016 Coll. (Nariadenie vlády č. 354/2006 Z. z. Slovenskej republiky, v znení č. 496/2010 Z. z. a 8/2016 Z. z.) are: limites for nitrate 50.0 mg.L^{-1} and nitrite 0.5 mg.L^{-1} . Sum of the ratios detected nitrate

divided by 50 and detected quantities of nitrite divided by 3 must be less than or be equal to 1.0.

The nitrite content in drinking water at the outlet of the treatment plant must be less than 0.1 mg.L^{-1} . Guideline values of nitrate and nitrite by World Health Organization (2011): nitrate 50.0 mg.L^{-1} as nitrate ion (or 11.0 mg.L^{-1} as nitrate-nitrogen) to protect against methaemoglobinaemia in bottle-fed infants (short-term exposure), nitrite: 3.0 mg.L^{-1} as nitrite ion (or 0.9 mg.L^{-1} as nitrite-nitrogen) to protect against methaemoglobinaemia in bottle-fed infants (short-term exposure) and combined nitrate plus nitrite: the sum of the ratios of the concentrations as reported or detected in the sample of each to its guideline value should not exceed 1.0. This proof is made more difficult by the presence of microbial contamination and subsequent gastrointestinal infections, which can significantly increase the risk for this group of people. Inspection authorities should tighten control of water used for infants fed by this bottle for microbiological safety if the nitrate concentration is near the guideline value for nitrate. It is recommended that the water, having a content of nitrates of 100 mg.L^{-1} or more, not be used for infants fed from bottle. Inspection authorities for food safety, including water, they should critically assess the relation between methaemoglobinaemia and nitrate concentration in the range of 50 to 100 mg.L^{-1} . This recommendation is especially true where gastrointestinal infections occur at infants and children in the population. In this context, it is the best measure to prevent this condition and put more emphasis on prevention of microbiological risks. Recommendation nitrite content 3 mg.L^{-1} follow from the data obtained from studies in humans. Use the lowest level of nitrites 0.4 mg.kg^{-1} body weight means that a child who weighs 5 kg and consumes about 0.75 liters of drinking water, the indicative amount of nitrite is 3 mg.L^{-1} .

We have focused our study on the investigation of nitrate and nitrite in the ground water resources in the surroundings of Nitra, in the river basin Žitava. Following the main aim was determined following partial aims: sampling of the water from wells and springs in the surroundings of Nitra, in the river basin Žitava, analysis of water samples for nitrate and nitrite content and assessment of the results.

It was established a scientific hypothesis. It was established scientific hypotheses. My assume that the nitrate content in the water of a private well will be higher than the limit value of 50.0 mg.L^{-1} for adult human population in drinking water.

MATERIAL AND METHODOLOGY

The object of investigation was water from wells water resources in the nearby town of Nitra, in the basin Žitava.

Water sampling and water sampling procedure

We collected one water sample from 10 different sources in the surroundings of Nitra, in river basin Žitava, in the months of May 2015 ($n = 10$) and October 2015 ($n = 10$). Sampling places of the well water were these water resources: private well, municipality Veľká Maňa – sample no. 1; private well, municipality Lúčnica nad Žitavou – sample no. 2; private well, municipality Žitavce – sample no. 3; well, municipality Michal nad Žitavou –

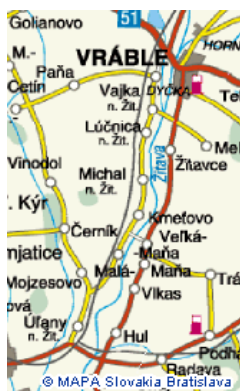

Figure 1 Water sampling sites.

sample no. 4; private well, municipality Malá Maňa – sample no. 5; well, municipality Uľany nad Žitavou – sample no. 6; private well, municipality Hul – sample no. 7; spring, municipality Vlka – sample no. 8; private well, municipality Kmeťovo – sample no. 9; private well, municipality Veľká Maňa, part Stará Hora – sample no. 10. Capacity of the taken sample was of 250 mL in laboratory bottle with cap.

Analysis of water samples

Preparation of the water sample for analysis

Water analysis for the content of nitrate and nitrite was carried out directly in the field as described below in this chapter.

Analysis of water samples for nitrate and nitrite content

Measurement of nitrates and nitrites

Test strips QUANTOFIX Nitrato a Nitrito from company Macherey-Nagel, Nemecko were used to measure the, type $10 - 500 \text{ mg.L}^{-1} \text{ NO}_3^-$, $1 - 80 \text{ mg.L}^{-1} \text{ NO}_2^-$.

QUANTOFIX test strip consists of a plastic strip 0.2 mm thick, on which is affixed at the lower end of test strips specific for the measurement of nitrate and nitrite. The size of the display surface papers allows easy comparison with the color scale on the aluminum tube, which is wrapped papers. To preserve the effectiveness and reliability of the strips to measure the protective cap tubes filled with drying agent. Strip length is sufficient for the testing of water samples. The advantage of the test strip for the detection of nitrate and nitrite in water samples is that it is quick and relatively reliable method.

Measurement procedure

Measurement of nitrate and nitrite contents was carried out by following the steps recommended by the manufacturer of the test strips Macherey-Nagel, Germany:

- we take hold of test strips between thumb and forefinger so that the adhered specific test slip was to the bottom end,
- we plunge a test strips into water in a beaker for 1 second,
- we taken a test strips from the water sample and hold between thumb and forefinger for 60 seconds,
- we attach a test strips to color scale indicating the numerical values of nitrate and nitrite content on the packaging of test papers and determine the content of nitrates and nitrates in measured water sample in mg.L^{-1} .

Statistical methods

The obtained data were assessed according to basic statistical characteristics (\bar{x} = mean, SD = standard deviation and c_v = coefficient of variation). T-test at the significance level of $\alpha = 0.05$ was used to compare a difference of nitrate content between taken samples in month May and month October. It was used program system SAS, version 8.2.

RESULTS

Nitrate and nitrite contents in water resources of private wells in the surrounding area of Nitra

We present in this chapter the results of verification of the contents of nitrates and nitrites that we measured in the samples of water from wells and springs. In the Figures we present the results of nitrate content in water samples taken in May and October 2015 by individual water sources that are documented in the Figure with that brief description.

Water source of water samples no. 1 shows Figure 4

Water source of water samples no. 1 is located in the center of municipality Veľká Maňa. In its surroundings is leafy park with a manor-house and also dump. Water source is located in residential part of the municipality. Nitrate content in water sample of taken sample no. 1 from home well in the municipality of Veľká Maňa was in May 150.0 mg.L^{-1} and in October also 150.0 mg.L^{-1} . In a water sample from the same source was measured no nitrite content.



Figure 2 Cup containing water sample, water in a beaker for the determination of nitrate and nitrite test strips QUANTOFIX Nitrato and Nitrito from company Macherey-Nagel (Foto: Angelovičová, 2016).

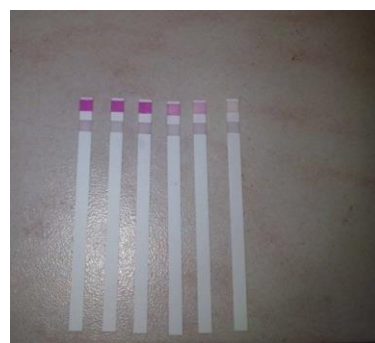

Figure 3 Test strips QUANTOFIX semi-quantitative determination of nitrate and nitrite in water samples (Foto: Szabóová, 2016).

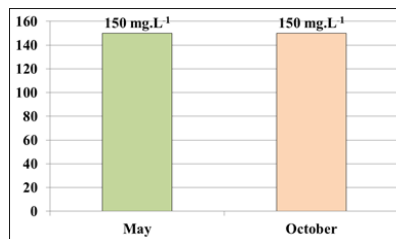

Figure 4 Water source of water sample no. 1 and nitrate content in month may and october (Foto: Szabóová, 2015).

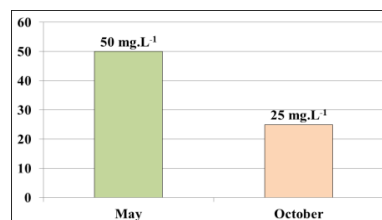

Figure 5 Water source of water sample no. 2 and nitrate content in month may and october (Foto: Szabóová, 2015).

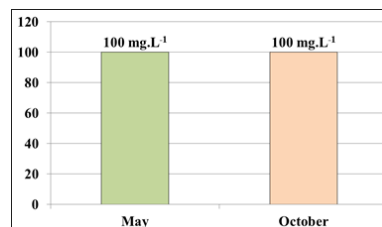

Figure 6 Water source of water sample no. 3 and nitrate content in month may and october (Foto: Szabóová, 2015).

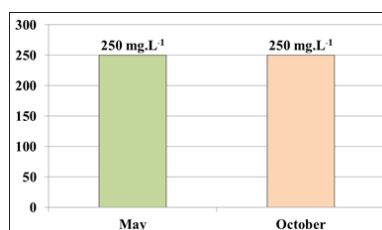

Figure 7 Water source of water sample no. 4 and nitrate content in month may and october (Foto: Szabóová, 2015).

Water source of water samples no. 2 shows Figure 5

Water source of the water sample no. 2 is located on the outskirts of municipality Lúčnica nad Žitavou. In its nearness there is a cemetery and railway. This water source is located in a sparsely populated part of the municipality. Nitrate content in water from home well in the municipality Lúčnica nad Žitavou was 50.0 mg.L⁻¹ in

May and 25.0 mg.L⁻¹ in October. In a sample of water from the same source was measured no nitrite content.

Water source of water samples no. 3 shows Figure 6

Water source sample no. 3 is located in the municipality Žitavce. In the nearness of private water resource there is a community center, shopping center, and old vacant apartments. In the gardens, which are located near the

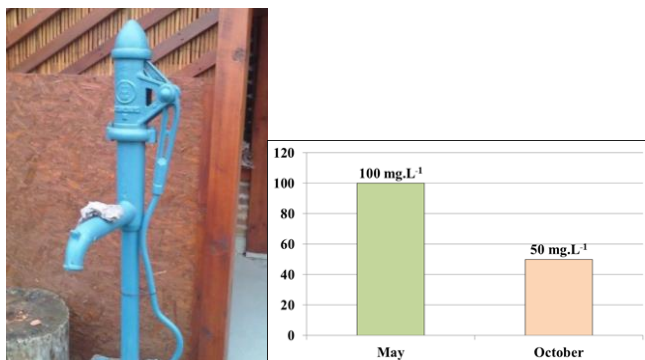

Figure 8 Water source of water sample no. 5 and nitrate content in month may and october (Foto: Szabóová, 2015).

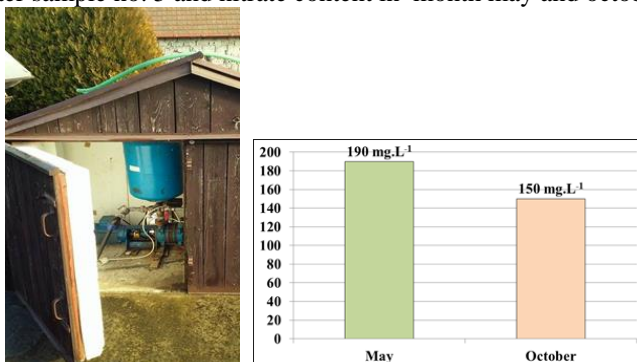

Figure 9 Water source of water sample no. 6 and nitrate content in month may and october (Foto: Szabóová, 2015).

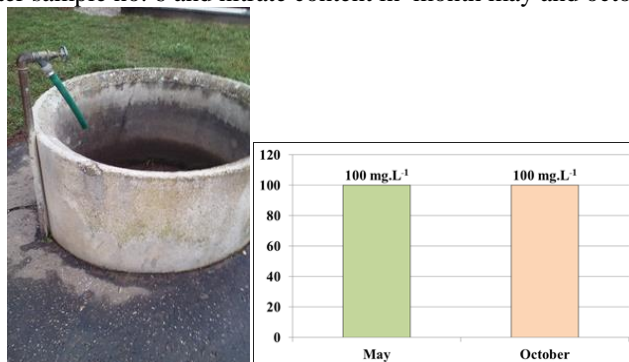

Figure 10 Water source of water sample no. 7 and nitrate content in month may and october (Foto: Szabóová, 2015).

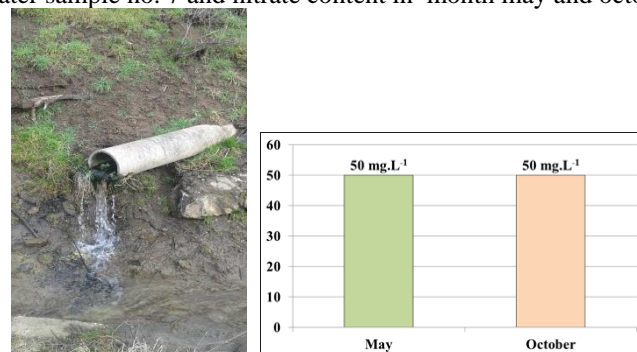

Figure 11 Water source of water sample no. 8 and nitrate content in month may and october (Foto: Szabóová, 2015).

water source, there were not grown any crops. Nitrate content in water from private well in the municipality Žitavce was 100.0 mg.L⁻¹ in May and also 100.0 mg.L⁻¹ in October. In a sample of water from the same source was measured no nitrite content.

Water source of water samples no. 4 shows Figure 7

Water source sample no. 4 is located on the outskirts of the municipality Michal nad Žitavou. In the nearness there is a garden, where every year grows crops. The well is open and the ground water rain water is mixed there.

Water source is located on the outskirts of the municipality adjacent to agricultural use of arable land. Nitrate content in water from private well in the municipality Michal nad Žitavou was 250.0 mg.L⁻¹ in May and also 250 mg.L⁻¹ in October. In a sample of water from the same source was measured no nitrite content.

Water source of water samples no. 5 shows Figure 8

Water source sample no. 5 is located on the outskirts of the municipality Malá Maňa. In its nearness are fields where crops cultivate every year such as cabbage,

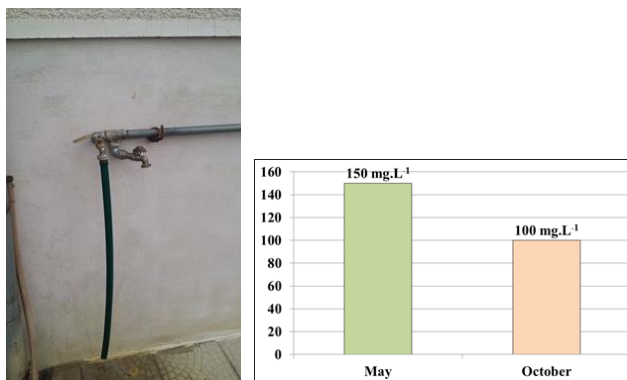

Figure 12 Water source of water sample no. 9 and nitrate content in month may and october (Foto: Szabóová, 2015).

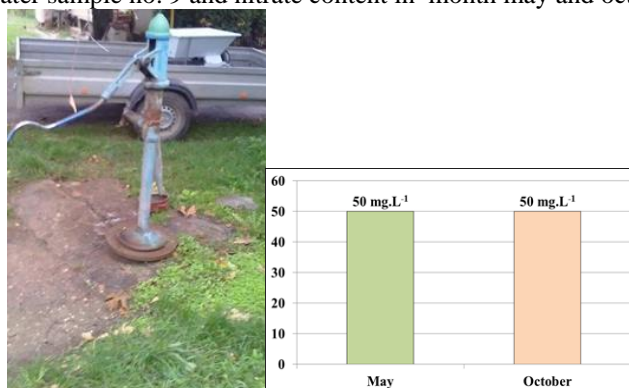

Figure 13 Water source of water sample no. 10 and nitrate content in month may and october (Foto: Szabóová, 2015).

potatoes, cauliflower. Nitrate content in water from private well in the municipality Malá Maňa was in May 100.0 mg.L⁻¹ in May and 50.0 mg.L⁻¹ in October. In a sample of water from the same source was measured no nitrite content.

Water source of water samples no. 6 shows Figure 9

Water source sample no. 6 is located on the outskirts of the municipality Kmeťovo. In its nearness are used gardens, agriculturally cultivated fields and small collective farm, where are bred dairy cows. Nitrate content in water from private well in the municipality Kmeťovo was 190.0 mg.L⁻¹ in May in October and 150.0 mg.L⁻¹ in October. In a sample of water from the same source was measured no nitrite content.

Water source of water samples no. 7 shows Figure 10

Water source sample no. 7 is located on the outskirts of the municipality Hul. In its nearness are around gardens and fields where potatoes are grown every year of early and late sorties. Nitrate content in water from private well in the municipality Hul was 100.0 mg.L⁻¹ in May and 100.0 mg.L⁻¹ in October. In a sample of water from the same source was measured no nitrite content.

Water source of water samples no. 8 shows Figure 11

Water source sample no. 8 was spring, which is located approximately one kilometer from municipality Vlkaš. In its surroundings, there are fields in which the yearly crops cultivate mainly as corn, wheat, barley. The water is obtained from ground springs. Nitrate content in water from private well in the municipality Vlkaš was 50.0 mg.L⁻¹ in May and 50.0 mg.L⁻¹ in October too. In a

sample of water from the same source was measured no nitrite content.

Water source of water samples no. 9 shows Figure 12

Water source sample no. 9 is located on the outskirts of municipality Úľany nad Žitavou. Nearby, there are gardens, where vegetables are cultivated and fields are agriculturally used. The surrounding gardens are characterized by the cultivation of fruit trees. Nitrate content in water from private well in the municipality of Úľany nad Žitavou was 150.0 mg.L⁻¹ in May and 100.0 mg.L⁻¹ in October. In a sample of water from the same source was measured no nitrite content.

Water source of water samples no. 10 shows Figure 13

Water source sample no. 10 is located on the outskirts of municipality Veľká Maňa, part of the Stará Hora. The sampling place is the wine region, located on a mild slope above the municipality Veľká Maňa. Nitrate content in water from private well near the municipality Veľká Maňa, part of the Stará Hora was 50.0 mg.L⁻¹ in May and 50.0 mg.L⁻¹ in October too. In a sample of water from the same source was measured no nitrite content.

The average content of nitrate and nitrite in water resources of surroundings Nitra according to the time sampling of water

Comparison of nitrate content in water resources of surroundings of Nitra according to the time water sampling of water is given in table 1.

The average content of nitrates in water resources observed in the surroundings Nitra was 119.00 mg.L⁻¹ in May, while the minimum was 50.00 mg.L⁻¹ and the maximum value of 250.00 mg.L⁻¹. Nitrate content in water

Table 1 Average nitrate content in water of water sources of surroundings Nitra.

Taken samples	n	\bar{x}	Min	Max	SD	c_v , %	t-test
May	10	119.00	50.00	250.00	66.24	55.66	0.55 ⁻
October	10	102.50	25.00	250.00	67.13	65.50	

Note: n – number of samples, \bar{x} – arithmetical mean, Min – minimum, Max – maximum. s – standard deviation, v_k – coefficient of variation. Statistically non-significant difference ($p > 0.05$).

resources was reduced to average value 102.50 mg.L⁻¹ in monitored surroundings Nitra in October compared to the month of May, with the variation range from 25.00 to 250.00 mg.L⁻¹. According to the results of standard deviation and coefficient of variation, we found that greater variation of measured nitrate levels in water resources of surroundings Nitra was in October (SD = 67.13 mg.L⁻¹, c_v = 65.50%) compared to the nitrate content of water resources in surroundings Nitra in the month of May (s = 66.24 mg.L⁻¹, c_v = 55.66%). The difference in nitrate levels in water resources of monitored surroundings Nitra between the months of May and October was not statistically significant ($p > 0.05$). The nitrite content in water of the same water sources surrounding area of Nitra was not found.

DISCUSSION

Based on the results of ground water pollution and exceeding the limits of nitrate and nitrite in the ground water world organizations have adopted certain measures. Directive 2000/60/EC of the European parliament and of the Council establishes a framework for community action in the field of water policy requires member states to characterize the quality of its ground water, identify trends and to introduce measures to achieve good quantitative state to 15 years from the date of entry into force of this directive.

According to literary knowledge are nitrates and mainly nitrites harmful for human from health aspect. Nitrates and nitrites are found in the atmosphere, soil, water, and foods. In our work we have focused mainly verify the nitrate and nitrite contents that are present in ground water. As we mentioned above, ground water is on the first place of obtaining quality drinking water. That is the reason, why we should be protecting its quality, protects drinking water. In recent decades, it is an alarming increase in nitrate and nitrite contents before good quality ground water. We can mention that nitrate concentrations to 1500 mg.L⁻¹ were detected in ground water, example in the agricultural area of India (Jacks and Sharma, 1983). Ground water in coastal areas Daweijia territory in north-east China is characterized with high nitrate concentration variation in values from 33 to 521 mg.L⁻¹ (Dongmei et al., 2015). Serious problems with the accumulation of nitrite have been rare so far mainly in the Nordic countries, such as Finland. However, also in Finland samples of water were found, which has been the accumulation of nitrite almost critical guideline value (0.50 mg.L⁻¹) (Lipponen et al., 2002). Over the limit nitrate levels above 100 mg.L⁻¹ were measured also in Belgium, in areas with intensive agriculture (Batlle and Aquilar et al., 2007). Amount of nitrate and nitrite monitors in Slovakia, and regularly samples collect of water pipes, as well as samples of other resources such as are ground water springs, rivers, rain

water and other. According to the results of the Water Research Institute in Bratislava has a content of ground water nitrites and nitrates in the Slovak Republic is still decreasing. The average values are also the limit level. However, these results misrepresent the high-mountain areas and areas with low agricultural activity. The results achieved in our work, in which water samples were collected from water sources serving households are located in the nearby town of Nitra, in the river basin Žitava, where it is still actively farming and nitrate levels are well above the limit. On the other hand, it is favorable that the nitrates were not presented in the ground water. Over limit of nitrate content above 50 mg.L⁻¹ was in all samples, except for sample no. 2, where even in October decreased nitrate content to 25 mg.L⁻¹, samples no. 8 and 10. In the sample no. 5 was in October satisfactory nitrate content, but in the month of May was the nitrate content of 100 mg.L⁻¹. Especially surroundings of the source of well water had an effect on the occurrence of nitrate in larger quantities.

Sample no. 1 was located near a park where they grow broadleaved trees. They cannot have an impact on the content of nitrates. There is also, however, a waste dump, which could cause over limit values. According to Wheeler et al. (2015) in forests keep nitrates in soil and water longer than in other areas, because trees are not degraded to such an amount of nitrogen than other plants.

Water source of sample no. 2 was located in a sparsely populated area of the village, near the cemetery is located. In the nearness of the source is not carried out intensive agricultural activity. Sample no. 2 had as the only one satisfactory content of nitrate, less than 50 mg.L⁻¹. In October, the nitrate content decreased to 25 mg.L⁻¹. If we were investigated also the other water quality parameters and water would met these criteria, it could be water from the wells used for drinking.

Sample no. 3 was collected from a quiet environment. There is nothing not grow for several years. Even though, the occurrence of nitrate was in above the threshold rate. In all probability it could have been caused in this case, the proximity of permeable septic tanks, which appeared from the well in less than four meters. In the past it is not introduced such strict measures to prevent penetration of their contents. According to STN 75 5115 should be household wells for at least 12 meters from the permeable septic tank, piping internal drains and sewer connections.

Sample no. 4 was collected from open wells, where water was stirred rainwater and ground water. This water sample measured significantly exceeded the permissible limit of nitrate. According Outram et al. (2016), who investigated the influence of precipitation on the transfer of phosphates and nitrates into the ground water. Precipitation has a big impact on nitrate content in ground water or rainwater.

Therefore, we should not be surprised that in a sample no. 4 was measured nitrate content up to 250 mg.L⁻¹.

In the sample no. 5 was observed decrease of nitrates in October. We assume that this decrease was caused just grown crops. On the fields were cultivated especially early potatoes, cauliflower and cabbage in recent years. These plants need for their growth sufficient amount of nitrogen that comes through nitrogen fertilizers. Crop depletes nitrogen in the soil and it is further not get into ground water.

Sample no. 7 was collected from the water source; where for surrounding area is also typical growing potatoes. In this sample, however, there was not a decrease of nitrates in repeated measurements in October.

Sample no. 6 was collected from the land, which is located near the small agricultural cooperatives, where there is farm of breeding dairy cows. This is probably the major factor that influenced the nitrate content in water up to 190 mg.L⁻¹. Permitted limit has been exceeded almost 4-fold. We assume that it may cause the presence of urea in the near ground water resources.

Sample no. 8 was collected from ground water springs in the vicinity of the village Vlkaš. This water sample contained a nitrate threshold level 50 mg.L⁻¹. Water source is surrounded by fields where crops are grown for animal feed. We provided that these crops to a greater extent from soil collected nitrogen, and soil is not fertilized the same extent as in the surrounding villages, from which we not collected water samples from water sources.

Water source of sample no. 9 is located in the garden of a family house. Surroundings accounted other gardens. In these gardens is a long tradition of growing vegetables and fruit trees. We collected water samples in the month of May and October, while in October decreased nitrate content from 150 mg.L⁻¹ to 100 mg.L⁻¹. Decrease of nitrates may result from the use of nitrogen cultivated plants for their growth.

High levels of nitrates in ground water, as stated in professional literature review, could be due to the particular use of nitrogen fertilizers. According to the results disclosed by **Wheeler et al. (2015)**, nitrate concentration decreases with increasing depth. Well from which water was collected, was characterized by depth of only 3 m, which may therefore be another cause of high nitrate level in the water.

Sample no. 10 was collected from wine-growing region. This area is located on a gentle slope. According to the research work **Zhang et al. (2012)** vineyards have an impact on the content of nitrates and nitrites in the soil and thus in ground water, as well as the length of the vineyard acreage and depth of their root system. Length of hillside vineyards exceeded in research of these authors one kilometer. The results of the research confirmed that the length of the slope one km vineyard was the limit for nitrate content. With increasing depth and slope length decreased content of nitrates and nitrites.

Samples that we examined were collected from a rural area. In general we can state that over the limit for nitrates in water of the investigated water resources were mainly due to the fact that in this area is intensively fertilized soil. Another factor affecting the increased nitrate content is certainly the fact that in various municipalities where the samples were collected, there is no sewerage.

Thus each house has a cesspool which in most cases is leaking because in the past did not put such emphasis on their isolation as today. It happens that the content of the cesspool in some cases released into the garden. Ultimately, for soil and ground water and water resources (from which is used for drinking water), in some cases residents themselves are responsible in their activities.

As stated by **Lukačínová et al. (2012)** in the publication that the results extend knowledge about the health risks of lifetime exposure to low doses of cadmium in drinking water rats, we are also of the same opinion, but in connection with exceeding values of nitrate in water. We agree with their conclusions, the results must be evaluated for more intervals of time, not only on the basis of the start and end of the experiment, and in this case the spring and autumn.

CONCLUSION

In surroundings of the town Nitra was measured different content of nitrates and nitrites in water samples from private wells or springs depending on the location and sampling in the months of May and October, 2015. Based on analysis of samples of well water from various water sources in the surroundings of Nitra, in the river basin Žitava can be stated as follows:

- The measured nitrate content in ground water exceeded the 50 mg.L⁻¹, which is the limit value for the adult human population and for children dependent on the bottle 15 mg.L⁻¹, in the well Veľká Maňa, Žitavce, Michal nad Žitavou, Malá Maňa, Uľany nad Žitavou, Hul, Kmeťovo and 50 mg.L⁻¹ were measured in spring Vlkaš, in the well Lúčnica nad Žitavou, Veľká Maňa, part of the Stará Hora.
- Any content of nitrite not detected in the taken samples of the water resources in the surrounding area of Nitra, in the river basin Žitava.

In our work, we also examined 10 water samples for nitrate and nitrite contents, depending from term of agro-technical time, in month May and October, and can be stated as follows:

- Measured nitrate content was reduced in October compared to the nitrate levels in the month of May in water samples taken in the municipalities Lúčnica nad Žitavou, Malá Maňa, Kmeťovo, Uľany nad Žitavou.
- The nitrate content of the other samples has not been changed from time aspect, which does not decreased nor increased in October compared to the nitrate levels in May.
- The difference in nitrate level in water of investigated water resources of surrounding area of Nitra, in the river basin Žitava, was not statistically significant different ($p > 0.05$) between samples taken in May and October.

Based on the results observed at solving our work, we recommend continued monitoring of the nitrate content in water resources at regular time cycles, and the results stored in the databases.

Various factors have a significant impact on the nitrate content present in ground waters, which are presented in theoretical part of work and confronted with our results.

We recommend monitoring, and evaluating the factors that influence to increase nitrate levels in ground waters for further research of nitrates in the water.

Because in water samples dominated overflow occurrence of nitrates in ground water, it is important to recommend the results to their use in practical terms,

through communication with the owner of the private water resource and management of farms and growers of crops and advised the procedure for the gradual reduction of nitrates in the soil under the checking nutrient reserves. It is one of the possibilities to reduce the nitrate in ground water.

REFERENCES

- Battle-Aguilar, J., Orban, P., Dassargues, A., Brouyère, S. 2007. Identification of groundwater quality trends in a chalk aquifer threatened by intensive agriculture in Belgium. *Hydrogeology Journal*, vol. 15, no. 8, p. 1615-1627. <https://doi.org/10.1007/s10040-007-0204-y>
- Cesar, A., Roš, M. 2013. Long-term study of nitrate, nitrite and pesticide removal from groundwater: A two-stage biological process. *International Biodeterioration & Biodegradation*, vol. 82, p. 117-123. <https://doi.org/10.1016/j.ibiod.2012.11.015>
- Černík, M., Zbořil, R. 2013. Nanomaterials and health conscious water (Nanomateriály a zdravotně nezávadná voda). *Vodní hospodářství*, vol. 63, no. 5, p. 140-144.
- Directive No. 2000/60/EC of the European parliament and of the Council of 23 October 2000 establishing a framework for community action in the field of water policy.
- Dongmei, H., Cao, G., Song, X., McCallum, L. J. 2015. Residence times of groundwater and nitrate transport in coastal aquifer systems: Daweijia area, northeastern China. *Science of The Total Environment*, vol. 538, p. 539-554. <https://doi.org/10.1016/j.scitotenv.2015.08.036>
- Dubrovsky, N., Hamilton, P. 2010. Nutrients in the nation's streams and groundwater: national findings and implications [online] s.a. [cit 2017-02-09] Available at: <http://pubs.usgs.gov/fs/2010/3078/>.
- EFSA, 2010. Panel on Dietetic Products, Nutrition, and Allergies (NDA). Scientific Opinion on Dietary reference values for water. *EFSA Journal*, vol. 8, no. 3, p. 1459. <https://doi.org/10.2903/j.efsa.2010.1459>
- Fewtrell, L. 2004. Drinking-water nitrate, methaemoglobinaemia, and global burden of disease: a discussion. *Environmental Health Perspectives*, vol. 112, no. 14, p. 1371-1374. <https://doi.org/10.1289/ehp.7216> PMID:15471727
- ICAI, Life Systems, Inc. 1987. *Drinking water criteria document on nitrate/nitrite*. 2nd ed. Washington, DC, United States : Environmental Protection Agency, Office of Drinking Water.
- Igúzquiza-Pardo, E., Chica-Olmo, M., Luque-Espinar, A. J., Rodríguez-Galiano, V. 2015. Compositional cokriging for mapping the probability risk of groundwater contamination by nitrates. *Science Total Environment*, vol. 532, no. 11, p. 162-175. <https://doi.org/10.1016/j.scitotenv.2015.06.004> PMID:26070026
- Jacks, G., Sharma, K. 1983. Nitrogen circulation and nitrate in ground water in an agricultural catchment in southern India. *Environmental Geology*, vol. 5, no. 2, p. 61-64. <https://doi.org/10.1007/BF02381097>
- Lake, I., Lovett, A. A., Hiscock, M. K., Betson, M., Foley, A., Sünnerberg, G., Evers, S., Fletcher, S. 2003. Evaluating factors influencing groundwater vulnerability to nitrate pollution: developing the potential of GIS. *Journal of Environmental Management*, vol. 68, no. 3, p. 315-328. [https://doi.org/10.1016/S0301-4797\(03\)00095-1](https://doi.org/10.1016/S0301-4797(03)00095-1)
- Lipponen, M., Satuuri, M., Martikainen, P. 2002. Occurrence of nitrifying bacteria and nitrification in Finnish drinking water distribution systems. *Water research*, vol. 36, no. 17, p. 4319-4329. [https://doi.org/10.1016/S0043-1354\(02\)00169-0](https://doi.org/10.1016/S0043-1354(02)00169-0)
- Lukačinová, A., Nováková, J., Lovásová, E., Cimboláková, I., Ništiar, F. 2012. Influence of lifetime exposure of sublethal doses of cadmium to selected parameters of carbohydrate metabolism. *Potravinárstvo*, vol. 6, 2012, no. 4, p. 36-40. <http://dx.doi.org/10.5219/231>
- Matschullat, J., Ottenstein, R., Reimann, C. 2000. Geochemical background-can we calculate it? *Environmental geology*, vol. 39, 2000, no. 9, p. 990-1000.
- Mendes, M., Ribeiro, L. 2010. Nitrate probability mapping in the northern aquifer alluvial system of the river Tagus (Portugal) using Disjunctive Kriging. *Science of the Total Environment*, vol. 48, no. 5, p. 1021-103. <https://doi.org/10.1016/j.scitotenv.2009.10.069> PMID:19932915
- Nariadenie vlády Slovenskej republiky z 9. decembra 2015, ktorým sa mení a dopĺňa nariadenie vlády Slovenskej republiky č. 354/2006 Z. z., ktorým sa ustanovujú požiadavky na vodu určenú na ľudskú spotrebu a kontrolu kvality vody určenej na ľudskú spotrebu v znení nariadenia vlády Slovenskej republiky č. 496/2010 Z. z. (Order of the Government of the Slovak Republic of 9 December 2015 amending and supplementing the Decree of the Government of the Slovak Republic No. 354/2006 Coll. Laying down requirements for water intended for human consumption and quality control of water intended for human consumption, as amended by Regulation Of the Government of the Slovak Republic No. 496/2010 Coll.)
- Ondrejková, I. 2012. *Výsledky monitorovania dusičnanov v podzemných vodách SR (Results of Nitrate Monitoring in Groundwater of the Slovak Republic)*. 1st ed Bratislava : Výskumný ústav vodného hospodárstva [online] s.a. [cit. 2017-02-09] Available at: <http://www.vuvh.sk/download/dok/POV/3.pdf>.
- Outram, N. F., Cooper, J. R., Sünnerberg, G., Hiscock, M. K., Lovett, A. A. 2016. Antecedent conditions, hydrological connectivity and anthropogenic inputs: Factors affecting nitrate and phosphorus transfers to agricultural headwater streams. *Science of The Total Environment*, vol. 545, p. 184-199. <https://doi.org/10.1016/j.scitotenv.2015.12.025> PMID:26747982
- Panno, S. V., Kelly, W. R., Martinsek, A. T., Hackley, K. C. 2006. Estimating background and threshold nitrate concentrations using probability graphs. *Ground Water*, vol. 44, no. 5, p. 697-709. <https://doi.org/10.1111/j.1745-6584.2006.00240.x> PMID:16961492
- Rapant, S., Vrana, K., Bodiš, D. 1996. *Geochemický atlas Slovenska časť I podzemné vody*. 1st ed. Bratislava : Geologická služba Slovenskej republiky. 127 p. ISBN: 80-85314-67-3.
- RIVM, 1993. *Maintenance of the environmental law 1995/1997. The quality of the drinking water in the Netherlands in 1993*. Bilthoven : National Institute for Public Health and the Environment (RIVM Report No. 731011007) (in Dutch).
- STN 75 7151: 2002. *Kvalita vody. Požiadavky na kvalitu vody dopravovanej potrubím (Water quality. Requirements for the quality of water conveyed by pipeline)*.
- Van Duijvenboden, W., Loch, G. 1983. Nitrate in the Netherlands: a serious threat to groundwater. *Aqua*, vol. 2, p. 59-60.
- Van Duijvenboden, W., Matthijsen, M. 1989. *Integrated criteria document nitrate*. Bilthoven : National Institute for

Public Health and the Environment (RIVM Report No. 758473012).

Wang, X., Pu, L., Zhang, M., Wang, Q., Yu, X. 2015. Spatial and temporal variations of soil organic carbon and total nitrogen pools in the coastal reclamation area, eastern China. *Atmospheric Chemistry Physics*, vol. 15, no. 6, p. 13585-13589. <https://doi.org/10.5194/acp-15-13585-2015>

Wheeler, C. D., Nolan, B. T., Flory, A. R., Dellavalle, C. T., Ward, M. H. 2015. Modeling groundwater nitrate concentrations in private wells in Iowa. *Science of The Total Environment*, vol. 536, p. 481-488. <https://doi.org/10.1016/j.scitotenv.2015.07.080>
[PMid:26232757](https://pubmed.ncbi.nlm.nih.gov/26232757/)

WHO, 1985. *Health hazards from nitrate in drinking-water* : Report on a WHO meeting.

World Health Organization, 2011. *Nitrate and nitrite in drinking-water Background document for development of WHO Guidelines for Drinking-water Quality*. Geneva, Switzerland : WHO Press.

Zhang, S., Huang, Y., Shen, C., Ye, H., Du, Y. 2012. Spatial prediction of soil organic matter using terrain indices and categorical variables as auxiliary information. *Geoderma*,

vol. 171, p. 35-43.
<https://doi.org/10.1016/j.geoderma.2011.07.012>

Contact address:

Mária Angelovičová, Slovak University of Agriculture, Faculty of Biotechnology and Food Sciences, Department of Hygiene and Food Safety, Tr. A. Hlinku 2, 949 76 Nitra Slovakia, E-mail: maria.angelovicova@gmail.com

Zuzana Szabóová, Slovak University of Agriculture, Faculty of Biotechnology and Food Sciences, Department of Hygiene and Food Safety, Tr. A. Hlinku 2, 949 76 Nitra Slovakia, E-mail: zuzana.szaboova1@centrum.sk

Jana Tkáčová, Slovak University of Agriculture, Faculty of Biotechnology and Food Sciences, Department of Evaluation and Processing of Animal Products, Tr. A. Hlinku 2, 949 76 Nitra Slovakia, E-mail: jana.tkacova@uniag.sk

Marek Angelovič, Slovak University of Agriculture, Faculty of Biotechnology and Food Sciences, Department of Machines and Production Systems, Tr. A. Hlinku 2, 949 76 Nitra Slovakia, E-mail: marek.angelovic@uniag.sk



QUANTITATIVE REAL-TIME PCR DETECTION OF PUTRESCINE-PRODUCING GRAM-NEGATIVE BACTERIA

Kristýna Maršáľková, Khatantuul Purevdorj, Petra Jančová, Hana Pištěková, Leona Buňková

ABSTRACT

Biogenic amines are indispensable components of living cells; nevertheless these compounds could be toxic for human health in higher concentrations. Putrescine is supposed to be the major biogenic amine associated with microbial food spoilage. Development of reliable, fast and culture-independent molecular methods to detect bacteria producing biogenic amines deserves the attention, especially of the food industry in purpose to protect health. The objective of this study was to verify the newly designed primer sets for detection of two inducible genes *adiA* and *speF* together in *Salmonella enterica* and *Escherichia coli* genome by Real-time PCR. These forenamed genes encode enzymes in the metabolic pathway which leads to production of putrescine in Gram-negative bacteria. Moreover, relative expression of these genes was studied in *E. coli* CCM 3954 strain using Real-time PCR. In this study, sets of new primers for the detection two inducible genes (*speF* and *adiA*) in *Salmonella enterica* and *E. coli* by Real-time PCR were designed and tested. Amplification efficiency of a Real-time PCR was calculated from the slope of the standard curves (*adiA*, *speF*, *gapA*). An efficiency in a range from 95 to 105 % for all tested reactions was achieved. The gene expression (R) of *adiA* and *speF* genes in *E. coli* was varied depending on culture conditions. The highest gene expression of *adiA* and *speF* was observed at 6, 24 and 36 h ($R_{adiA} \sim 3, 5, 9$; $R_{speF} \sim 11, 10, 9$; respectively) after initiation of growth of this bacteria in nutrient broth medium enriched with amino acids. The results show that these primers could be used for relative quantification analysis of *E. coli*.

Keywords: putrescine; Gram-negative bacteria; *speF*; *adiA*; Real-time PCR

INTRODUCTION

Biogenic amines (BAs) are low molecular weight nitrogen compounds formed by several bacterial species in food and beverages during fermentation. These amines are indispensable components of living cells, but they could exert toxic effect in humans in higher concentrations (Santos, 1996).

However, in food, such as fermented products, BAs are also produced by genera of the family *Enterobacteriaceae*, such as *Escherichia*, *Salmonella*, *Citrobacter*, *Klebsiella*, *Proteus* and *Shigella* (Suzzi and Garnini, 2003). The main biogenic amines encountered in foods and drinks include histamine, tyramine, putrescine, and cadaverine (Landete et al., 2005). Moreover, the ingestion of contaminated food containing high amounts of BAs can be toxic. For example, histamine induces headache, diarrhea, edema, respiratory difficulties, allergy; tyramine can cause hypertension, migraine and neurological disorders, while putrescine and cadaverine could possess carcinogenic effects (Ladero et al., 2010; Shalaby, 1996).

Nevertheless, removing of produced BAs from material is very complicated because of their persistence. They resist high temperature, even autoclaving (Zaman et al., 2010). Therefore, attention is focused on the prevention of their formation, such as using fresh raw material, keeping hygienic precautions and technological procedure (Avarez and Moreno-Arribas, 2014).

Nowadays, the prevention of BAs accumulation in food industry has become one of the major priorities. Thus, the development of tools for research on BAs accumulation appears to be extraordinarily important. Putrescine is supposed to be the major biogenic amine associated with microbial food spoilage. Putrescine can be produced by the starter cultures and contaminating microbiota in food. Contaminating microorganisms from the family *Enterobacteriaceae* and *Pseudomonadaceae* among many cases are thought to be the most frequent producers of putrescine (Curiel et al., 2011; Lavizzari et al., 2010; Pons-Sánchez-Cascado et al., 2005).

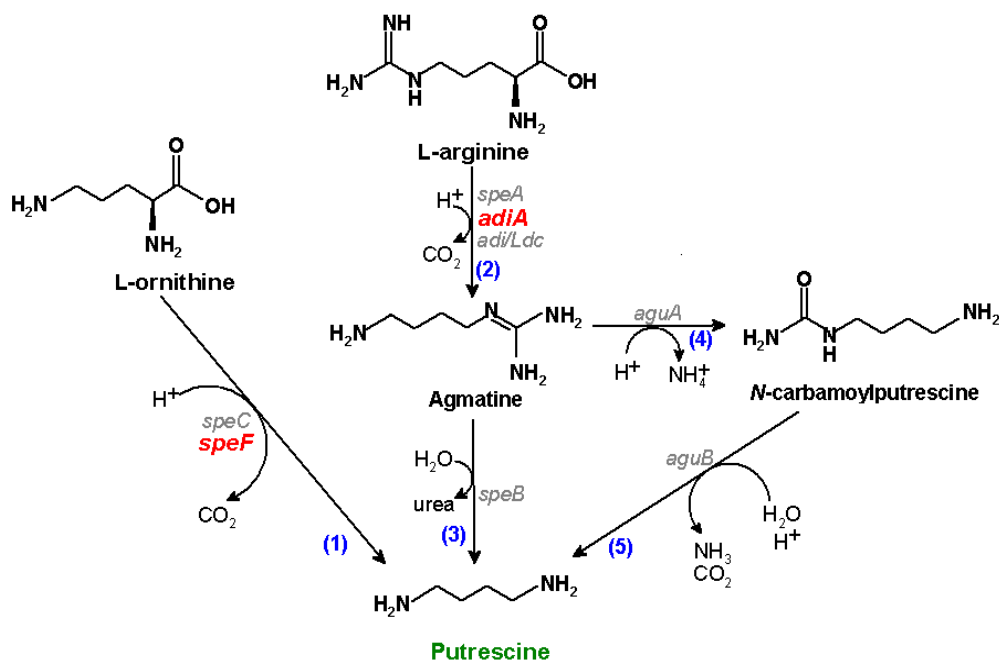

Key enzymes:
 (1) Ornithine decarboxylase (ODC); (2) Arginine decarboxylase (ADC); (3) Agmatinase,
 (4) Agmatine deiminase; (5) *N*-carbamoyl putrescine amidohydrolase.

Figure 1 Putrescine metabolism in Gram-negative bacteria (Wunderlichova et al., 2014).

In contrast to other BAs formed by straight decarboxylation of appropriate amino acids, Gram-negative bacteria can produce putrescine by three different metabolic ways, in which certain enzymes can even exist in two different forms (in biosynthetic or biodegradative form) as shown in Figure 1.

Putrescine might be formed directly by decarboxylation of ornithine by the ornithine decarboxylase enzyme (ODC) in the first pathway. The gene *speC* codes for biosynthetic form of this enzyme. The catabolic form of ODC is encoded by the *speF* gene included in genome of only few *Enterobacteriaceae* family members, such as *Escherichia coli* and *Salmonella enterica*. Both, the second and third pathway of putrescine formation begin with decarboxylation of arginine by arginine decarboxylase (ADC) which leads to production of agmatine. This enzyme may also be present as a biosynthetic form, encoded by the *speA* gene that occurs in a wide range of Gram-negative bacteria or it might be present in its catabolic form, inducible ADC, which is encoded by the *adiA* gene. The genome of several Gram-negative bacteria such as *E. coli* and *Salmonella enterica* strains includes the *adiA* gene. The third pathway typically occurs in plants. Within the third pathway, agmatine is converted to putrescine via formation of intermediate *N*-carbamoyl putrescine and the overall pathway is catalyzed by two enzymes. The first step is catalyzed by agmatine deiminase (the *aguA* gene product) and the second one by *N*-carbamoyl putrescine amidohydrolase (the *aguB* gene product) (Wunderlichova et al., 2014).

Methods for detection of bacteria which produce biogenic amines in higher, potentially dangerous concentrations to humans have been developed during the last three decades. Several detection methods are based on use of differential growth media where the increase of the

pH signalling BAs formation (Maila, 1993). The most useful method for BAs detection in food is chromatography, especially high performance liquid chromatography (Lorencova et al., 2012; Costa et al., 2015). However, detection of biogenic amines producing bacteria by conventional culture techniques is often unreliable, tedious with certain disadvantages, such as low throughput score, frequent appearance of false positive or negative results, insufficient sensitivity, and high demands for expensive and sophisticated equipment (Actis et al., 1999). Molecular biology methods for detection and identification of food-borne bacteria have become an alternative tools in contrast to traditional culture microbiological methods. The PCR technique has become one of the most important methods and offers the advantages of simplicity, sensitivity, specific detection of targeted genes and high throughput outcome. Moreover, molecular methods can detect potential risk score even before BA is produced. Though standard PCR and Real-time PCR follow similar principles and rules, Real-time PCR has many advantages over basic PCR technique. Real-time PCR measures the product formation (gene amplification) during the exponential phase while standard PCR measures the amount of the product during the plateau phase. It is more effective to perform the measurement during the exponential phase because results obtained during the plateau phase do not always reliably indicate the quantity of starting material. For example, with the Real-time PCR results can be acquired in an hour but with traditional PCR the whole procedure usually lasts 3 - 4 h to obtain the final results. Standard PCR is followed by post-PCR analysis, usually with agarose gel electrophoresis; the product of our interest is identified either by size or sequence. Although gel electrophoresis is relatively cheap technique, it falls in the group of low

throughput techniques since it is time-consuming and non-automated. Moreover, it also exerts low specificity, since the molecules with the same or similar molecular weight cannot be easily differentiated. In comparison, technique beats down traditional PCR in terms of highthroughput outcome, selectivity and sensitivity. Furthermore, major disadvantage of traditional PCR is the detection of non-viable cells. In contrast, Real-time PCR method is capable of detecting of the viable cells (Postollec et al., 2011).

In this study, sets of new primers for the detection of two inducible genes (*speF* and *adiA*) involved in the putrescine metabolism in Gram-negative bacteria were designed and tested. Real-time PCR method for the direct detection and relative quantification of bacterial gene expression in nutrient broth medium was proposed and finally optimized.

The aim of further experimental studies will be the monitoring of putrescine producers (*E. coli* and *Salmonella enterica*) by Real-time PCR in real food samples.

MATERIAL AND METHODOLOGY

Design of PCR primers

The optimal length of primers is generally accepted as 18 - 24 bp. For better optimization of Real-time PCR the finding of primers of minimal length which have melting temperatures (T_m) that are between 59 and 68 °C, with an optimal T_m of 63 – 64 °C is essential (Thornton and Basu, 2011). Following the study of Wunderlichova et al. (2014), the specific oligonucleotide primers for detection and relative quantification of *speF* by Real-time PCR in *E. coli* a *Salmonella enterica* were designed and tested.

Primers for endogen (housekeeping gene; *gapA*) in *E. coli* were adopted from Fitzmaurice's study (Fitzmaurice et al., 2014). The last sets of primers, those for *adiA*, enabling analysis of gene expression by Real-time PCR were developed especially for this study. Sequences for the gene encoding the arginine decarboxylase (ADC) in *Salmonella enterica* and *E. coli* were obtained using database GenBank. Sequences were aligned using Jalview Editor and a consensus sequence was generated. Two conserved regions were identified and primers were designed in these regions. The size of amplified PCR product was anticipated to be 192 bp. The acquired sequences of desired genes were compared using BLAST at the NCBI site (<http://www.ncbi.nlm.nih.gov/blast>). Primers designed and used in this study are listed in Table 1.

Bacterial strain

Escherichia coli CCM 3954 used in this study, was

purchased from the Czech collection of Microorganism (CCM).

Escherichia coli was cultivated in nutrient broth (NB) medium for 24 hours at the temperature of 37 °C, in the next step, strain was incubated in a mineral broth medium enriched with glucose and vitamins for 48 hours at 30 °C (decarboxylases genes were inactivated in this step). Bacteria with inactivated decarboxylase activity were subsequently transferred to the NB medium with 0.2% amino acids (L-ornithine, L-arginine) and cultured for 48 hours at 37 °C. Samples were collected during incubation in a time mode, *Escherichia coli* strain was tested separately at time intervals of 0, 6, 9, 12, 24, 30, 36 and 48 hours.

Reverse transcriptase

Collected samples were centrifuged at 5,000 RPM for 5 min at 4 °C. After centrifugation, isolation of total RNA using High pure RNA isolation kit (ROCHE, Germany) was performed following the ROCHE's protocol (ROCHE Web site, High Pure RNA Isolation Kit). Isolated RNA was immediately translated into cDNA form by Transcriptor first strand cDNA synthesis kit (ROCHE, Germany) following the ROCHE's manuscript (ROCHE Web site, Transcriptor First Strand cDNA Synthesis Kit).

The mix of template and primers (the final volume of 13 µL included 60 µmol.L⁻¹ of Random Hexamer Primer and maximum volume of RNA) was incubated for 10 min at 65 °C. Then 4 µL of Transcriptor reverse transcriptase reaction buffer, 0.5 µL of Protector RNase inhibitor (40 U.µL⁻¹), 1 mmol.L⁻¹ of deoxynucleotidemix, 0.5 µL of Transcriptor reverse transcriptase (40 U.µL⁻¹) were added to the final volume of 20 µL.

Real-time PCR

Relative expression of *speF* and *adiA* genes was determined using the Real-time PCR technique. Each cDNA sample was amplified using SYBR Green (Fast Start Universal SYBR Green Master (Rox ROCHE, Germany) using the Thermocycler CFX 96 Real-Time (BIO RAD). Briefly, the reaction mixture consisted of 12.5 µL of ROCHE mix, 300 nmol.L⁻¹ of forward primer, 300 nmol.L⁻¹ of reverse primer and 2.5 µL of cDNA in the final volume of 25 µL of supermix. Each cycle included initial denaturation step at 95 °C for 3min, denaturation step at 95 °C for 30 s, annealing at 57.9 °C for 30 s, extension at 72 °C for 60 s, melting curve in range of 55 – 95 °C and final extension step at 72 °C held for 5 min. The gene *GapA*, which encodes for expression of a member of the glyceraldehyde-3-phosphate dehydrogenase protein family, was used as an endogenous control to normalize

Table 1 PCR primers used in the quantitative Real-time PCR assays.

Target gene	Primer name	Sequence 5' → 3'	Amplicon size (bp)
<i>speF</i>	2F	5'-TCGCCRCTGYTGCTG-3'*	196
	4R	5'-GATAGAAYGGCTGGTGG-3'*	
<i>adiA</i>	adiAU F	5'-CTGGTTGAAGCGGAGAART-3'*	192
	adiAU R	5'-TGGTACGGCTATGCRGTYTT-3'*	
<i>gapA</i>	gapA F	5'-ACTTCGACAAATATGCTGGC-3'	200
	gapA R	5'-CGGGATGATGTTCTGGGAA-3'	

Note: *Y=C or T; R= A or G.

each sample for evaluation of real quantification of desired genes. The experimental study was designed as three independent experiments with each sample as triplicate.

The baseline and cycle threshold (Ct) were automatically calculated by CFX 96 Touch™ System Software, version 2.1. The melting curve analysis was done on the same device (CFX 96 Real-Time) after the completion of Real-time PCR analyses. Amplification efficiency, E, was calculated from the slope of the standard curves. It is expressed as a percentage that is the percent of template that was amplified in each cycle. For calculation of the following formula (1) (Bio-Rad Laboratories, 2006) was applied:

$$(1) \quad \%E = (10^{1/slope} - 1) \cdot 100\%$$

The relative expression ratio (R) was subsequently calculated for each gene of interest by using an equation (2) described by Pfaffl (2001):

$$(2) \quad R = \frac{E_{target}^{\Delta Ct_{target}(control-sample)}}{E_{reference}^{\Delta Ct_{reference}(control-sample)}}$$

Where: E_{target} is Real-time PCR efficiency of the target gene transcript (*speF* or *adiA*); $E_{reference}$ is Real-time PCR efficiency of a reference gene transcript (*gapA*); ΔCt_{target} is the Ct deviation of control (0 h) – sample (6, 9, 12, 24, 30 36 and 48 h) of the target gene transcript; $\Delta Ct_{reference}$ is the Ct deviation of control (0 h) – sample (6, 9, 12, 24, 30 36 and 48 h) of the reference gene transcript.

The geometric mean of the reference gene was applied as a normalization factor in the analysis. Measurement of gene expression was conducted in triplicate and the geometric mean of these values was used for the analysis.

RESULTS AND DISCUSSION

In this study, sets of primers were designed, tested and used for the detection and relative quantification of two inducible genes involved in putrescine metabolism (the ornithine decarboxylase (ODC) is encoded by the *speF* gene and the arginine decarboxylase (ADC) by the *adiA* gene) occurring in *E. coli* and *Salmonella enterica*.

In the first step, designed primers were tested with use of the classical PCR technique. Agarose gel electrophoresis was used for the separation of DNA fragments. Subsequently, the optimal temperatures for primer annealing were selected (based on the Tm primers) followed by optimization of Real-time PCR.

Optimization Real-time PCR

Efficiency, reproducibility, and dynamic range of Real-time PCR assays for *adiA* and *speF* were determined by constructing standard curves using serial dilutions of template with a known amount.

Slopes for standard curves achieved the values from -3.18 to -3.40 for *adiA*, *gapA* and *speF*, as shown in Figure 2. The slope of the curve with an ideal efficiency of the PCR reaction is around the value -3.32 (Mackay, 2007). Real-time PCR efficiencies (E) calculated from the standard curve slope were 106%, 103% and 97% for *adiA*, *speF* and *gapA*, respectively. Ideal efficiency value of Real-time PCR reaction should be 90 – 110% (Mackay, 2007). The coefficient of determination (R^2) was >0.99 for all the *adiA*, *gapA* and *speF* Real-time PCR assays.

Specificity of the primers and thus verification that nonspecific products were not amplified during PCR cycles was determined by melting curve analysis. Primer-dimers formation can limit the dynamic range of the desired standard curve due to competition for reaction

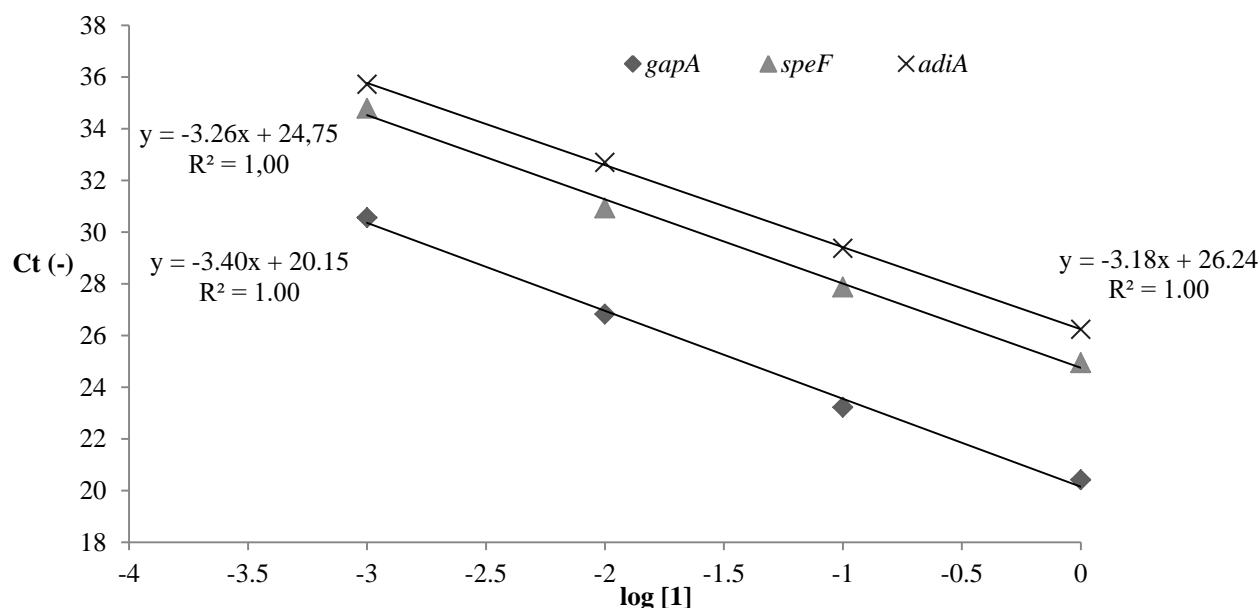

Figure 2 Real-time PCR standard curves of *speF* and *adiA* gene with endogenous control *gapA*.

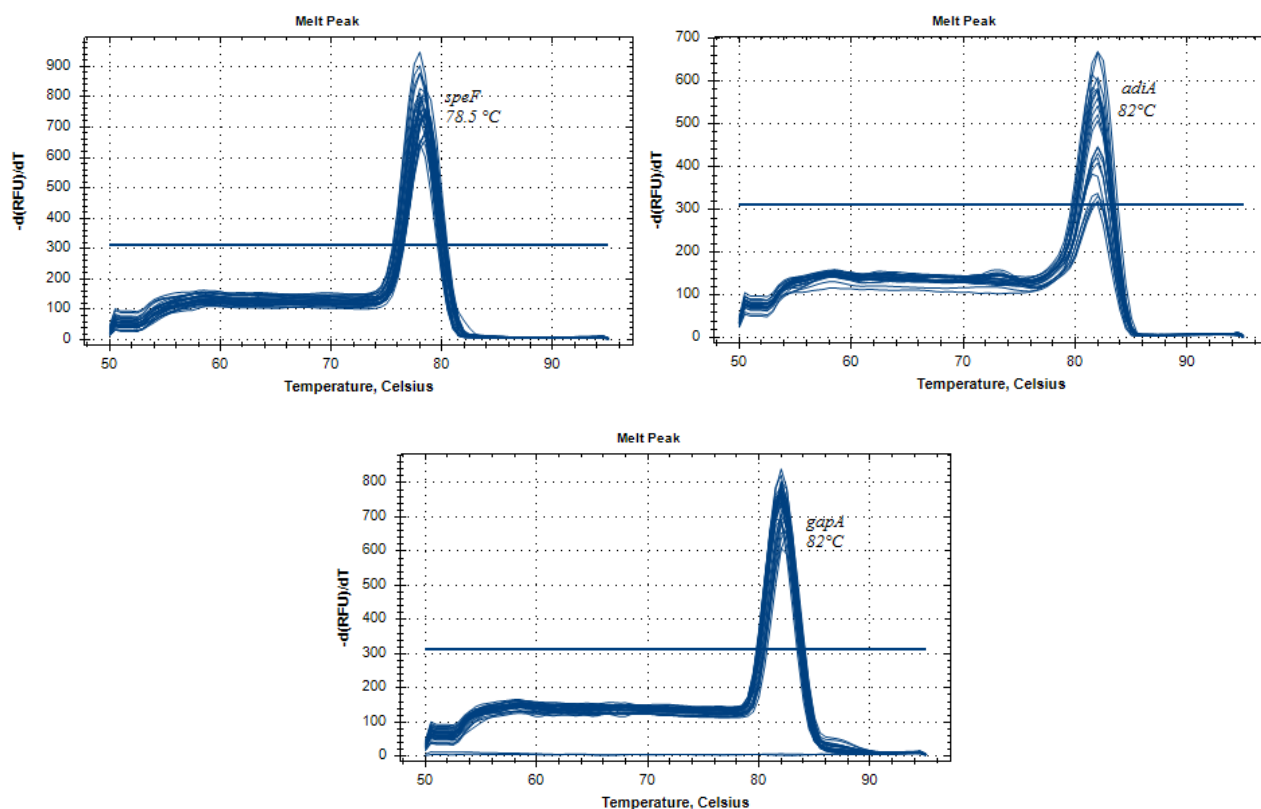

Figure 3 Melting curves for *speF*, *adiA* and *gapA*, (melting temperature *speF* 78.5°C, *adiA* 82 °C and *gapA* 82 °C).

components during amplification. Therefore, melt-curve analysis is essential in designing an efficient and specific quantitative PCR assay (Wilhelm and Pingoud, 2003). Only one peak appeared in the melt curve, as can be seen in Figure 3, indicating that only one product was amplified. In other words, primer dimers were not generated with any of the primer sets used.

Relative genes expressions

Quantitative PCR is the method of choice for precise quantification of gene expression. Analysis of expression of target gene compared to expression of an endogenous control gene is commonly used method for quantification of gene expression (Relative Quantification). As an important aspect in gene expression studies, the housekeeping gene (endogenous control gene) must be properly selected for the normalization of cDNA content.

In this study, the *E. coli* CCM 3954 was the tested strain. Based on the literature review, two housekeeping genes were chosen to be tested. First endogen was *gyrA* that encoded protein DNA gyrase subunit A (Weigel, 1998; Yin, 2008). Results indicated (data not shown) that this gene was not suitable as endogene control for this study.

For this reason, the other gene, *gapA*, was chosen and tested. The *gapA* encoded protein glyceraldehyde-3-phosphate dehydrogenase which catalyzes the oxidative phosphorylation of glyceraldehyde 3-phosphate to 1,3-bisphosphoglycerate using the cofactor NAD (Carey, 2009; Fitzmaurice, 2004). Based on the results obtained in preliminary tests, the last mentioned housekeeping gen was evaluated as suitable control for the purpose of our study.

The gene expression (R) of *adiA* and *speF* genes was varied depending on culture conditions. At time intervals of 0, 6, 9, 12, 24, 30, 36 and 48 hours after initiation of incubation samples were collected. Isolated total RNA obtained from individual samples was immediately reverse transcribed into cDNA. Relative expression of *speF* and *adiA* was determined using Real-time PCR technique. Expressions of *E.coli* decarboxylases genes were determined using *gapA* as the endogenous control selected for the normalization.

The results have shown the change of gene expression of tested genes (*speF* and *adiA*) in different time points from the start of cultivation. In other words, after six hours of cultivation of *E. coli* CCM 3954 in the NB medium enriched with L-ornithine, gene expression of *speF* was 11 x higher than it was detected at the time point 0 h. Likewise, if this bacteria was cultivated in NB medium with L-arginin, gene expression of the *adiA* was 3 times higher than at the beginning (time 0 h). Changes in gene expression could be monitored for both genes at all time points (Figure 4).

The highest gene expression of *speF* and *adiA* was observed at 6, 24 and 36 h ($R_{speF} \sim 11, 10, 9$; $R_{adiA} \sim 3, 5, 9$; respectively) during growth of *E. coli* CCM 3954 in nutrient broth (NB) medium with addition of the respective amino acids. These results were consistent with the growth curve of bacteria (data not shown). The phenomenon of variations in expression of both genes could be explained by autolysis of the bacteria with the subsequent use of the dead biomass. Amino acids might have been released and again converted to putrescine.

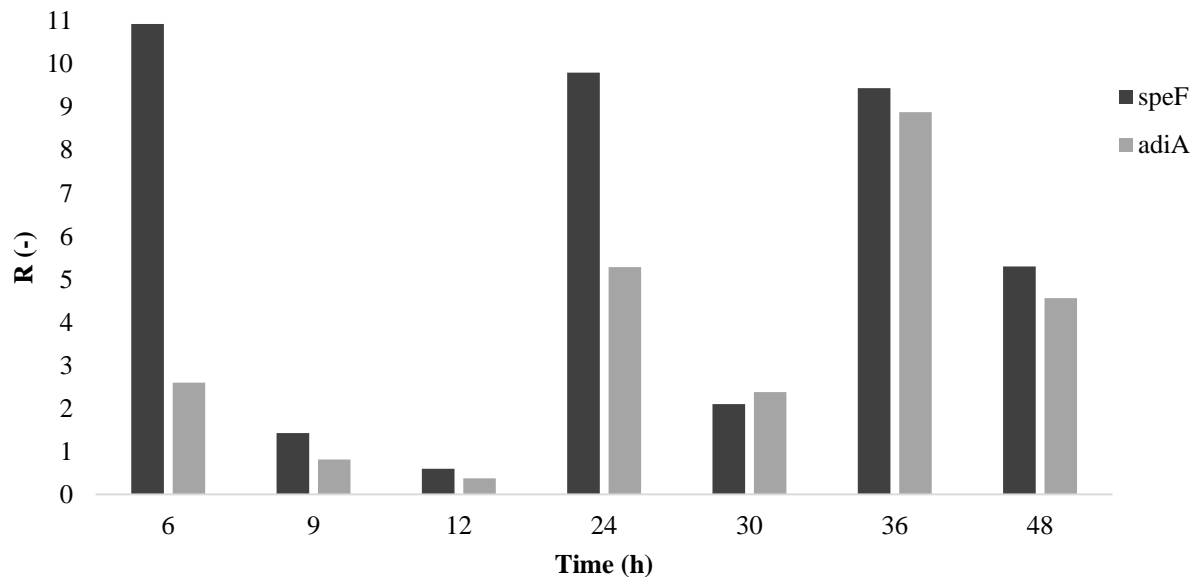

Figure 4 Relative expression of *speF* and *adiA* genes in different culture conditions (*gapA* was used as a housekeeping gene).

Note: The results show the change of gene expression of both enzymes in different time points of cultivation of *E. coli* in NB medium with appropriate amino acids (relative to time 0 h point).

In this study, the development of Real-time PCR method for detection of Gram-negative putrescine-producing bacteria (*E. coli* and *Salmonella enterica*) was described.

In the last few years, a large number of methods have been developed to determine the content of BAs or their producers in food but the complexity of putrescine metabolism is probably the main reason for a relatively small number of studies focussing on the detection and investigation of putrescine metabolism in Gram-negative bacteria.

Only a few PCR methods have been developed to determine the producers of putrescine in a food material. Assays for the detection of a single gene need careful choice of primers, target sequence, and suitable method for detection of the amplified DNA product. Most of the developed primers are designed to detect a mixture of genes encoding ODC in Gram-negative bacteria (de las Rivas et al., 2005, 2006, 2007). Several of these primers were also used in multiplex PCR for simultaneous detection of more decarboxylase genes (Nannelli et al., 2008; Coton et al., 2010).

For typical cycling conditions (Real-time PCR), ideal amplicon size is between 70 and 200 bp. Therefore, a number of primers that can be used for conventional PCR or touchdown-PCR are not suitable for Real-time PCR. However, several Real-time PCR methods for the quantification of putrescine producers (Gram-positive bacteria) were published. Nannelli et al. (2008) and Ladero et al. (2011) used *agdif/agdir* and *odcf/odcr* primers for the quantification of lactic acid bacteria (LAB)-producing putrescine.

Molecular methods, primarily PCR-based ones, have been previously developed for the detection of Gram-negative putrescine-producing bacteria (Wunderlichova, 2014). However, our method constitutes one of the first reported efforts to develop a Real-time PCR assay for Gram-negative putrescine-producing bacteria detection.

CONCLUSION

In this study, the development of an unique Real-time PCR method for rapid and sensitive detection of high putrescine-producing Gram-negative bacteria (*Escherichia coli* and *Salmonella enterica*) were established.

Sets of new primers for the detection of two inducible genes (*speF* and *adiA*) involved in the putrescine metabolism in Gram-negative bacteria were designed and tested. The results have shown that these sets are suitable for Real-time PCR analysis (Tm of primers: 56 – 62 °C; length of amplicons: approximately 200 bp; efficiency of amplification: 95 – 105%).

Based on the results of our experimental study, newly designed sets of primers could be useful tool for relative quantification of *E. coli* in food. Moreover, our team has been working on monitoring of gene expression of *speF* and *adiA* genes in *Salmonella enterica*.

REFERENCES

- Actis, L., Smoot, J., Barancin, C., Findlay, R. 1999. Comparison of differential plating media and two chromatography techniques for the detection of histamine production in bacteria. *Journal of Microbiological Methods*, vol. 39, no. 1, p. 79-90. [http://dx.doi.org/10.1016/S0167-7012\(99\)00099-8](http://dx.doi.org/10.1016/S0167-7012(99)00099-8).
- Alvarez, M., Moreno-Arribas, M. 2014. The problem of biogenic amines in fermented foods and the use of potential biogenic amine-degrading microorganisms as a solution. *Trends in Food Science & Technology*, vol. 39, no. 2, p. 146-155. <http://dx.doi.org/10.1016/j.tifs.2014.07.007>
- Bio-Rad Laboratories, 2006. Real-Time PCR Applications Guide. Bio-Rad Laboratories [online] s.a. [cit.2017-01-15] Available at: <http://www.gene-quantification.de/real-time-pcr-guide-bio-rad.pdf>
- Carey, C. M., Kostrzynska, M., and Thompson, S. 2009. *Escherichia coli* O157: H7 stress and virulence gene expression on Romaine lettuce using comparative real-time

- PCR. *Journal of Microbiological Methods*, vol. 77, no. 2, p. 235-242. <http://dx.doi.org/10.1016/j.mimet.2009.02.010>
- Coton, M., Romano, A., Spano, G., Romano, A., Spano, G., Ziegler, K., Vetrana, C., Desmarais, C., Lonvaud-Funel, A., Lucas, P., Coton, E. 2010. Occurrence of biogenic amine-forming lactic acid bacteria in wine and cider. *Food Microbiology*, vol. 27, no. 8, p. 1078-1085. <http://dx.doi.org/10.1016/j.fm.2010.07.012>
- Costa, M. P., Balthazar, C. F., Rodrigues, B. L., Lazaro, C. A., Silva, A. C. O., Cruz, A. G. and Conte Junior, C. A. 2015. Determination of biogenic amines by high-performance liquid chromatography (HPLC-DAD) in probiotic cow's and goat's fermented milks and acceptance. *Food Science & Nutrition*, vol. 3, no. 3, p. 172-178. <http://dx.doi.org/10.1002/fsn3.200>
- Curiel, J. A., Ruiz-Capillas, C., de las Rivas, B., Carrascosa, A. V., Jiménez-Colmenero, F., Muñoz, R. 2011. Production of biogenic amines by lactic acid bacteria and enterobacteria isolated from fresh pork sausages packaged in different atmospheres and kept under refrigeration. *Meat Science*, vol. 88, no. 3, p. 368-373. <http://dx.doi.org/10.1016/j.meatsci.2011.01.011>
- De las Rivas B., Marcobal A., Carrascosa A., V., Muñoz R. 2006. PCR detection of foodborne bacteria producing the biogenic amines histamine, tyramine, putrescine and cadaverine. *Journal of Food Protection*, vol. 69, no. 10, p. 2509-2514. <https://doi.org/10.1021/jf049340k> PMID:15713028
- De Las Rivas, B., Marcobal, A. and Muñoz, R. 2006. Gene organization of the ornithine decarboxylase-encoding region in *Morganella morganii*. *Journal of Applied Microbiology*, vol. 102, no. 6, p. 1551-1560. <http://dx.doi.org/10.1111/j.1365-2672.2006.03188.x>
- De Las Rivas, B., Marcobal, A., Muñoz, R. 2005. Improved multiplex-PCR method for the simultaneous detection of food bacteria producing biogenic amines. *FEMS Microbiology Letters*, vol. 244, no. 2, p. 367-372. <https://doi.org/10.1016/j.femsle.2005.02.012>
- Fitzmaurice, J., Glennon, M., Duffy, G., Sheridan, J. J., Carroll, C., Maher, M. 2004. Application of real-time PCR and RT-PCR assays for the detection and quantitation of VT 1 and VT 2 toxin genes in *E. coli* O157:H7. *Molecular and Cellular Probes*, vol. 18, no. 2, p. 123-132. <http://dx.doi.org/10.1016/j.mcp.2003.10.004>
- Ladero, V., Calles-Enriquez, M., Fernandez, M., Alvarez, M. 2010. Toxicological effects of dietary biogenic amines. *Current Nutrition & Food Science*, vol. 6, p.145-156. <https://doi.org/10.2174/157340110791233256>
- Ladero V., Fernandez M., Cuesta I., Alvarez M. A. 2010. Quantitative detection and identification of tyramine-producing enterococci and lactobacilli in cheese by multiplex qPCR. *Food Microbiology*, vol. 27, no. 7, p. 933-939. <http://dx.doi.org/10.1016/j.fm.2010.05.026>
- Landete, J. M., de las Rivas, B., Marcobal, A., Munoz, R. 2005. Biogenic amines in wines from three Spanish regions. *Journal of Agricultural and Food Chemistry*, vol. 53, no. 4, p. 258-269. <http://pubs.acs.org/doi/full/10.1021/jf049340k>
- Lavizzari, T., Breccia, M., Bover-Cid, S., Vidal-Carou, M. C., Veciana-Nogués, M. T. 2010. Histamine, cadaverine, and putrescine produced in vitro by *Enterobacteriaceae* and *Pseudomonadaceae* isolated from spinach. *Journal of Food Protection*, vol. 73, no. 2, p. 385-389. <http://dx.doi.org/10.4315/0362-028X-73.2.385>
- Lorencova, E., Bunkova, L., Matoulkova, D., Drab, V., Pleva, P., Kuban, V., Bunka, F. 2012. Production of biogenic amines by lactic acid bacteria and bifidobacteria isolated from dairy products and beer. *International Journal of Food Science & Technology*, vol. 47, no. 10, p. 2086-2091. <http://dx.doi.org/10.1111/j.1365-2621.2012.03074.x>
- Mackay, I. M. 2007. *Real-time PCR in microbiology: from diagnosis to characterisation*. Norfolk, UK: Caister Academic, 454 p. ISBN 1904455182. <http://dx.doi.org/10.1002/elsc.200890009>
- Majjala, R. L. 1993. Formation of histamine and tyramine by some lactic acid bacteria in MRS-broth and modified decarboxylation agar. *Letters in Applied Microbiology*, vol. 17, no. 1, p. 40-43. <http://dx.doi.org/10.1111/j.1472-765X.1993.tb01431.x>
- Nannelli, F., Claisse, O., Gindreau, E., de Revel, G., Lonvaud-Funel, A., Lucas, P. M. 2008. Determination of lactic acid bacteria producing biogenic amines in wine by quantitative PCR methods. *Letters in Applied Microbiology*, vol. 47, no. 6, p. 594-599. <http://dx.doi.org/10.1111/j.1472-765X.2008.02472.x>
- Shalaby, A. R. 1996. Significance of biogenic amines to food safety and human health. *Food Research International*, vol. 29, no. 7, p. 675-690. [http://dx.doi.org/10.1016/S0963-9969\(96\)00066-X](http://dx.doi.org/10.1016/S0963-9969(96)00066-X)
- Santos, M. 1996. Biogenic amines: their importance in foods. *International Journal of Food Microbiology*, vol. 29, no. 2-3, p. 213-231. [http://dx.doi.org/10.1016/0168-1605\(95\)00032-1](http://dx.doi.org/10.1016/0168-1605(95)00032-1)
- Suzzi, G., Garnini, F. 2003. Biogenic amines in dry fermented sausages: a review. *International Journal of Food Microbiology*, vol. 88, no. 1, p. 41-54. [http://dx.doi.org/10.1016/S0168-1605\(03\)00080-1](http://dx.doi.org/10.1016/S0168-1605(03)00080-1)
- Pfaffl, M. W. 2001. A new mathematical model for relative quantification in real-time RT-PCR. *Nucleic Acids Research*, vol. 29, no. 9, p. 2002-2007. <https://doi.org/10.1093/nar/29.9.e45>
- Pons-Sánchez-Cascado, S., Bover-Cid, S., Veciana-Nogués, M. T., Vidal-Carou, M. C. 2005. Amino acid-decarboxylase activity of bacteria isolated from ice-preserved anchovies. *European Food Research and Technology*, vol. 220, no. 3, p. 312-315. <http://dx.doi.org/10.1007/s00217-004-1095-y>
- Postollec, F., Falentin, H., Pavan, S., Combrisson, J., Sohier, D. 2011. Recent advances in quantitative PCR (qPCR) applications in food microbiology. *Food Microbiology*, vol. 28, no. 5, p. 848-861. <http://dx.doi.org/10.1016/j.fm.2011.02.008>
- Thornton, B., Basu, C. 2011. Real-time PCR (qPCR) primer design using free online software education. *Biochemistry and Molecular Biology Education*, vol. 39, p. 145-154. <http://dx.doi.org/10.1002/bmb.20461>
- ROCHE, 2017. High Pure RNA Isolation Kit, [online] s.a. [cit.2017-01-17]. Available at: http://netdocs.roche.com/DDM/Effective/000000000001004022000453_000_12_005_Native.pdf
- Roche, 1999-2017. Transcriptor First Strand cDNA Synthesis Kit, [online] s.a. [cit. 2017-01-12]. Available at: <http://facstaff.bloomu.edu/gdavis/MoBio/Transcriptor%20full%20manual.pdf>
- Weigel L., M., Steward C., D., Tenover F., C. 1998. *gyrA* Mutations Associated with Fluoroquinolone Resistance in Eight Species of *Enterobacteriaceae*. *Antimicrobial Agents and Chemotherapy*, vol. 42, no. 10, p. 2661-2667. PMID:9756773
- Wilhelm, J., Pingoud, A. 2003. Real-time polymerase chain reaction. *ChemBioChem*, vol. 4, no. 11, p. 1120-1128. <http://dx.doi.org/10.1002/cbic.200300662>
- Wunderlichova, L. 2009. *Vývoj nových molekulárně biologických metod detekce putrescin produkujících bakterií* :

Dissertation theses. Zlín: Univerzita Tomáše Bati ve Zlíně, 123 p.

Wunderlichova, L., Bunkova, L., Koutny, M., Jancova, P., Bunka, F. 2014. Formation, Degradation, and Detoxification of Putrescine by Foodborne Bacteria: A Review. *Comprehensive Reviews in Food Science and Food Safety*, vol. 13, no. 5, p. 1541-4337. <http://dx.doi.org/10.1111/1541-4337.12099>

Yin, H., Cao, L., Qiu, G., Wang, D., Kellogg, L., Zhou, J., Liu, X., Dai, Z., Ding, J., Liu, X. 2008. Molecular diversity of 16S rRNA and *gyrB* genes in copper mines. *Archives of Microbiology*, vol 189, no. 2, p. 101-110. <https://doi.org/10.1007/s00203-007-0298-6>
[PMid:17957354](https://pubmed.ncbi.nlm.nih.gov/17957354/)

Acknowledgments:

The financial support from the Internal Grant of Tomas Bata University in Zlín (No. IGA/FT/2017/003) and the Grant

Agency of the Czech Republic (GAČR No. 17-09594S) are greatly acknowledged

Contact address:

Kristýna Maršáková, Tomas Bata University in Zlín, Faculty of Technology, Vavrečkova 275, 760 01, Zlín, Czech Republic, E-mail: marsalkova@ft.utb.cz

Khatantuul Purevdorj, Tomas Bata University in Zlín, Faculty of Technology, Vavrečkova 275, 760 01, Zlín, Czech Republic, E-mail: purevdorj@ft.utb.cz

Petra Jančová, Tomas Bata University in Zlín, Faculty of Technology, Vavrečkova 275, 760 01, Zlín, Czech Republic, E-mail: jancova@ft.utb.cz

Hana Pištěková, Tomas Bata University in Zlín, Faculty of Technology, Vavrečkova 275, 760 01, Zlín, Czech Republic, E-mail: h.pistekova@gmail.com

Leona Buňková, Tomas Bata University in Zlín, Faculty of Technology, Vavrečkova 275, 760 01, Zlín, Czech Republic, E-mail: bunkova@ft.utb.cz



EFFECT OF MILK ORIGIN ON PROTEOLYSIS AND ACCUMULATION OF BIOGENIC AMINE DURING RIPENING OF DUTCH-TYPE CHEESE

Vendula Pachlová, Zuzana Charousová, Tomáš Šopík

ABSTRACT

Dairy products from goat's milk are characterized by their distinctive aroma and their specific taste. However, the strong aroma can discourage some consumers. Properties of cheese can be modified by the combination of goat's and cow's milk. On the other hand, chemical diversity from different milk origin may affect the changes during ripening. The aim of the study was to compare the intensity of changes during ripening of model cheese samples produced with various ratios of goat's and cow's milk. The combinations 100:0 (100% goat's milk), 75:25, 50:50, 25:75 and 0:100 (100% cow's milk) were used for the manufacture of Dutch-type cheeses, which were ripened during a period of 84 days. Protein profile, free amino acid content and biogenic amine content were used for the description of cheese properties during storage. Cluster analysis showed different changes in the protein matrix of the examined samples. The results indicated that even low addition of cow's milk significantly affected the protein profile. However, the homology of protein profiles rose with the increasing ripening time. More intensive proteolysis occurred in the samples with predominance of goat's milk. Moreover, cheese samples produced only from goat's milk presented a significant increase in the amount of free amino acids after 14 days of ripening. The effect of milk origin on the production of biogenic amines was also examined. However, higher concentrations of biogenic amines were detected in samples manufactured from goat's milk. Tyramine, putrescine, histamine and phenylethylamine were detected during the storage of the samples. The total biogenic amine content exceeded 100 mg/kg in samples with predominance of goat's milk.

Keywords: goat's milk, cheese ripening, proteolysis, biogenic amine

INTRODUCTION

Dairy products from goat's milk are characterized by their distinctive aroma and their specific taste. For this phenomenon are mainly responsible fatty acids in higher concentration, such as capric acid, caprylic acid and caproic acid (Albenzio and Santilo 2011). Therefore, some consumers may find this specific strong aroma of goat's products unpleasant. Moreover, goat's milk is in comparison with cow's milk more expensive for the production of dairy products. Especially, in the case of ripened goat's cheeses, the production costs are several times higher than the cheese from cow's milk. The deficiencies mentioned above can be reduced by a combination of goat's and cow's milk. Furthermore, the flavor can be modified with the different milk composition. On the other hand, chemical diversity may affect the processes occurring during cheese ripening and thereby modify their properties. During the cheese ripening, the proteolysis is the most important process. The intensity of hydrolysis of the protein matrix of the cheese creates properties, especially a texture due to the weakening of the protein matrix (Pachlová et al., 2011).

Final products of proteolysis – free amino acids are considered as markers of ripening. These free amino acids can be subsequently converted to significant sensory active substances, while the desired flavors of ripened products are developed (Sousa et al., 2001). However, during cheese ripening decarboxylation of the free amino acids may simultaneously occur and biogenic amines concentration can be increased up to unhealthy for the consumer levels. The biogenic amines are classified as psychoactive and vasoactive substances which are responsible e.g. for the variation in blood pressure, headache, migraine, vomiting and respiratory problems. For instance, histamine, tyramine and phenylalanine contribute to these symptoms directly. Moreover, putrescine and cadaverine can act as intensifiers of toxic effects of other biogenic amines (Spano et al., 2010; Kalač, 2014).

For these reasons, the aim of the study was to describe the influence of goat's and cow's milk combinations on the properties of cheese during ripening and evaluate the content of selected biogenic amines.

MATERIAL AND METHODOLOGY

Samples

Model samples of Dutch-type cheese were produced in five different combinations of goat's and cow's milk 100:0 (100% goat's milk), 75:25, 50:50, 25:75 and 0:100 (100% cow's milk). Milk for cheese production was obtained from a small farm. Before the production of cheese, the milk was pasteurized (74 °C for 30 seconds). Products were wrapped in a shrink foil after salting. Model cheeses were ripened in the maturing chamber at 12 ±2 °C. Samplings were carried out on the 1, 14, 28, 56 and 84 days after production. The basic chemical analysis (dry matter content, pH and NaCl content), protein profile, free amino acid content and the content of biogenic amines were evaluated during maturation. Two parallel cheese blocks were analysed in each day of sampling.

Basic chemical analysis

Model samples of cheese were subjected to determination of dry matter content according to **ISO 5534:2004** norm and salt content (**Indra and Mizera 1992**) and pH value (pH meter, Eutech Instruments, The Netherlands). For the lyophilization of the samples was used the ALPHA 1-4 LCS (Christ, Osterode am Harz, Germany) at -40 °C and a pressure approximately 12 Pa. The lyophilized samples were stored at -70 °C and were used to determine the protein profile, free amino acids and biogenic amines. Three parallel assessment were carried out for each samples.

Protein profile

The preparation of samples for sodium dodecyl sulfate–polyacrylamide gel electrophoresis (SDS-PAGE) was performed according to the procedure published in **Lazarkova et al. (2010)**. The electrophoretic separation was carried out by means of buffer system according to **Laemmli (1970)** and a vertical electrophoresis apparatus (Bio-Rad Laboratories, Inc., Hercules, CA, USA). The visualisation was performed using Coomassie brilliant blue G25012 and the results were evaluated by means of Ultra Quant™ 6.0 software (Ultra-Lum. Inc., Claremont, CA, USA).

Free amino acid content

The determination of the concentrations of free amino acids was performed by means of chromatographic analysis, which was focused on the detection of the content of 30 amino acids and their derivatives (threonine, serine, asparagic acid, asparagine, glutamic acid, glutamine, proline, glycine, alanine, citrulline, valine, cysteine, methionine, cystathionine, isoleucine, leucine, tyrosine, phenylalanine, β-alanine, β-aminobutyric acid, γ-aminobutyric acid, ethanolamine, ornithine, lysine, histidine, 1-methyl-histidine, 3-methyl-histidine, arginine, amino adipic acid, γ-aminobutyric acid). Lyophilised samples of cheeses were used to determine the content of free amino acids. The extraction of free amino acids was performed by triple extraction according to **Pachlová et al. (2011)** using Li-buffer. This compound is composed of hydrochloric acid and lithium citrate, wherein pH of Li-buffer is 2.2 ±0.2. The resulting extract was analysed by ion-exchange liquid chromatography using Automatic

Amino-Acid Analyzer AAA 400 (Ingos, Prague, Czech Republic) with a column of 150 × 3.7 mm and Polymer AAA ion exchanger according to **Buňková et al. (2009)**. Each cheese sample was extracted twice. Each extract was analysed twice.

Biogenic amine analysis

Lyophilised cheese was used for the biogenic amine (BA) and polyamine (PA) analysis of the cheese samples. Triple extraction of BA and PA from the lyophilised samples was carried out using a perchloric acid solution (0.6 mol.L⁻¹). Three independent extractions were performed on each cheese sample. The filtrated extract (filter porosity 0.45 μm) was then used directly for the derivatisation and determination of BA/PA content (**Dadáková et al., 2009; Buňková et al., 2013**) that followed.

The quantities present for eight biogenic amines of histamine (HIM), tyramine (TYM), phenylethylamine (PHE), tryptamine (TRY), putrescine (PUT), cadaverine (CAD), spermine (SPE) and spermidine (SPD) were analysed via liquid chromatography (LabAlliance, USA and Agilent Technologies, Agilent, Santa Clara, California, USA) after derivatisation using dansyl chloride. The dansyl chloride sample derivatisation procedure was performed according to **Dadáková et al. (2009)**. 1,7-heptandiamine was used as the internal standard. Chromatographic separation (ZORBAX Eclipse XDB-C18, 50 × 3.0 mm, 1.8 μm; Agilent Technologies) and detection (spectrophotometric λ = 254 nm) were performed according to **Buňková et al. (2013)**. Each cheese sample was analysed 12 times (3 extractions, 2 derivatisations, 2 applications to the column).

Statistical analysis

The results of the determination of free amino acid content and content of biogenic amines were statistically evaluated by means of the Kruskal–Wallis test and Wilcoxon test. Unistat® 5.5 software (Unistat, London, UK) was used for the statistical evaluation. Cluster analysis was used to compare the results obtained by SDS-PAGE.

RESULTS AND DISCUSSION

After production of the model samples of cheeses made in various proportions of goat's and cow's milk, the dry matter content was measured (before salting). The observed data ranged in the average of 50.3 ±0.4% (w/w). Moreover, the pH value was measured and was 4.99 ±0.05% (w/w). From the 14th day of storage, the dry matter content increased due to the salting 51.9 ±0.6% (w/w), with an average concentration of NaCl 1.45 ±0.11% (w/w). During further storage there were no significant differences in the dry matter and the salt contents between the samples (data not shown).

Cluster analysis showed significant changes in the protein matrix in samples with different proteins of goat's and cow's milk origin are illustrated in Figure 1. We observed, that the sample made only from cow's milk (sample 0:100) formed separate cluster within 24 hours after manufacturing. The results also indicated that even low addition of cow's milk at the beginning of ripening significantly affected the protein profile. Similarity around

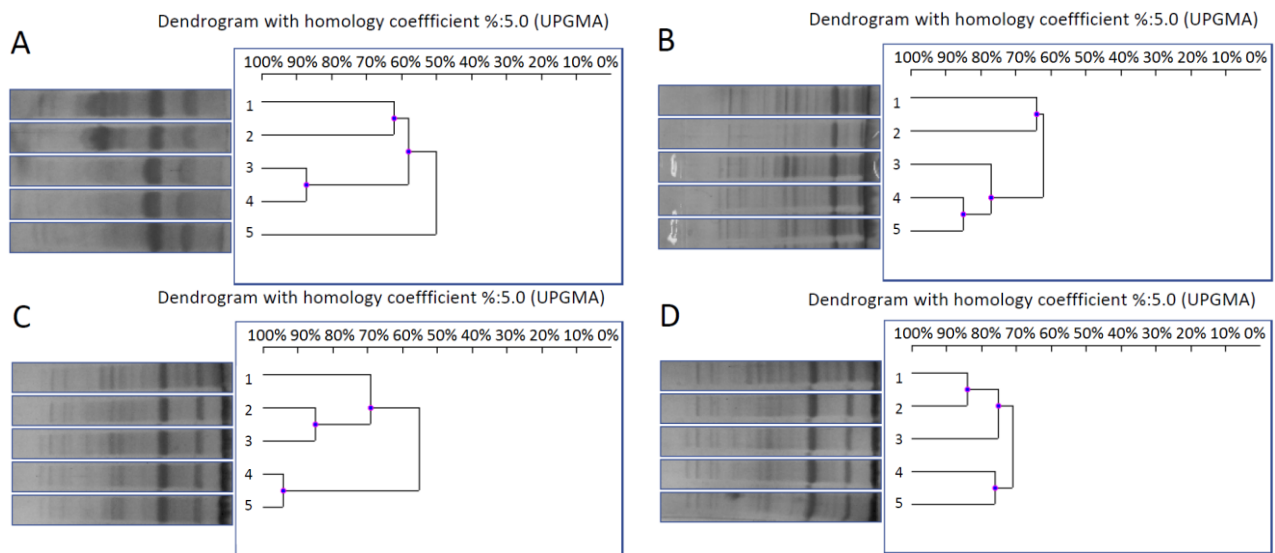

Figure 1 Protein profile of model cheese samples with different proportion of goat’s and cow’s milk (1 – 100:0; 2 – 75:25; 3 – 50:50 4 – 25:75; 5 – 0:100) during ripening (Part **A** – day 1, Part **B** – day 28; Part **C** – day 56; Part **D** – day 84).

87% between the samples was observed in cheeses made of 50:50 and 25:75 ratios (goat’s/cow’s milk). On the other hand, samples in ratio 100:0 and 75:25 showed the lowest similarity, 62%. The homology of the samples made purely of generic milks (100:0 and 0:100) was only 53%.

After 28 days of ripening, the similarity of the samples protein profile with predominance of cow’s milk began to show higher values. The protein profile of the samples 25:75 and 0:100 coincided 85% and after 56 days of ripening even reached 94% compliance. Whereas, the similarity of the sample from goat’s milk (100:0) in comparison with other combined samples after 28 days of ripening decreased from 64% to 66% (in the case of sample 0:100 was demonstrated 55% homology). With the increasing time of maturation, a rise in homology was

observed. After 84 days of ripening was reported 84% similarity between samples 100:0 and 75:25. Furthermore, protein profiles of samples 0:100 and 25:75 were equal to 76%. Protein profiles of cheese samples were influenced firstly by different chemical composition of goat’s and cow’s milk but probably also by varied microenvironmental conditions in cheese which affect activity of microorganisms naturally present or added as starter culture. Intracellular microbial endopeptidases and exopeptidases hydrolyze protein matrix during cheese ripening while amino acids are final products of proteolysis (Fontenle et al., 2017; Sousa et al., 2001). Chemical composition of cheese can play role in intensity of proteolysis. On other hand the results showed that with the increasing maturation time the protein profile of the

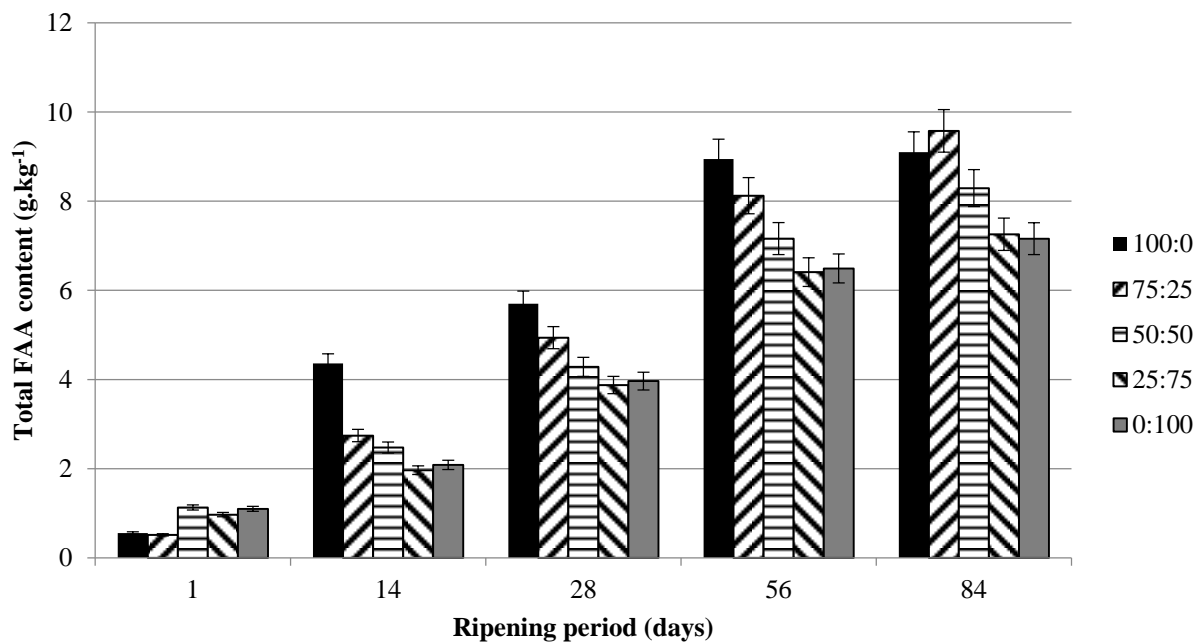

Figure 2 Total content of free amino acids in model samples of cheeses with different proportion of goat’s and cow’s milk during ripening.

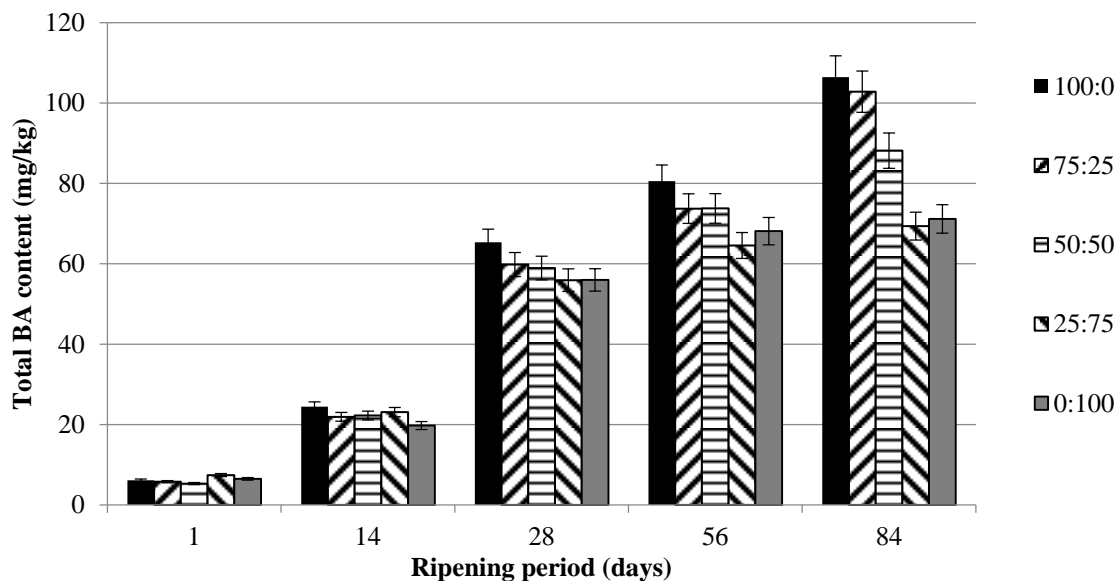

Figure 3 Total content of biogenic amines in model samples of cheeses with different proportion of goat's and cow's milk during ripening.

individual samples reached higher similarity.

Increase in the total content of free amino acids (Figure 2) was observed during ripening in all cheese samples. However, differences between individual batches were detected. The proteolysis was more intense in cheese with a predominance of goat's milk. Therefore, after 14 days of ripening the cheese samples made only from goat's milk contained up to twice the amount of free amino acids. This trend of higher amino acid content was observed in samples with a higher proportion of goat's milk to the end of the experiment (day 84 after manufacture). The effect of milk origin on the intensity of proteolysis was also confirmed by the development of free amino acids in cheese made from cow's milk (0:100). During the three month experiment, the lowest concentration of free amino acids was observed in cheese from cow's milk (0:100).

Through the conversion of free amino acids into sensory active substances, a variety of flavor and aroma compounds are developed in the ripened cheeses. The intensity of proteolysis and subsequently development of volatile compounds may be influenced by both external (e.g. temperature and aging time) and internal factors (e.g. activity of microorganisms, presence and activity of endogenous and exogenous enzymes, water activity, pH) (Bezzera et al., 2017; Combarros-Fuertes et al., 2016; Hickey et al., 2013). In terms of representation of endogenous enzymes milk of different species vary significantly. For instance, the goat's milk contains in comparison with cow's milk an increased representation of proteinase enzymes (Albenzio and Shantilal 2011). The activity of the present enzyme can be further regulated, inter alia the availability of substrate for specific enzymes (Sousa et al., 2001). These factors significantly affect the formation of long polypeptide chains differently and, ultimately, the content of free amino acids which can be converted into sensory active compounds.

The content of biogenic amines such as tyramine, putrescine, histamine, and phenylethylamine were monitored during storage. The results showed an increase in biogenic amine concentration depending on

the time of maturation in all batches of model samples. During the first 14 days of ripening, no significant differences between the samples were observed. After 28 days was observed a higher concentration of the sum of biogenic amines in the samples produced from the goat's milk in comparison with other samples as can be seen in Figure 3. Moreover, this trend was continuous until the end of the experiment. Higher content of biogenic amines in goat's cheese was detected also in Buňková et al. (2013).

During 84 days of ripening was observed an increase in the content of biogenic amines above $100 \text{ mg} \cdot \text{kg}^{-1}$ in the samples with a predominance of goat's milk (samples 100:0 and 75:0). Such high concentrations can be evaluated as a risk for the consumer, as they can cause unwanted psychoactive and vasoactive effects (Ten Brink et al., 1990; Silla Santos 1996).

Increased accumulation of biogenic amines in the samples with a predominance of goat's milk was attributable due to several factors. Firstly, the increased proteolysis and consequently preferable availability of amino acids as precursors for the formation of biogenic amines. Secondly, the raw milk was a probable source of microorganisms capable of producing biogenic amines in ripened cheeses (Combarros-Fuertes et al., 2016). Additionally, raw goat's and cow's milk may differ in microflora. Moreover, even though milk was subjected to heat treatment, some groups of microorganisms may survive pasteurisation and subsequently contribute to the changes during maturation (Quigley et al., 2013; Kološta et al., 2014).

CONCLUSION

Based on the results of the study it can be concluded, that the type of milk used has a significant influence on the intensity of changes during ripening. The differences in the intensity of proteolysis and biogenic amine content were observed in samples from goat's and cow's milk. However, with the increasing ripening period, the differences in protein profiles decreased. The most intense

proteolysis was observed in samples with a predominance of goat's milk. Moreover, with the rising content of cow's milk, the deceleration of proteolysis was observed. Higher concentrations of biogenic amines were detected in model cheese manufactured from predominant goat's milk.

REFERENCES

- Albenzio, M., Santillo, A. 2011. Biochemical characteristics of ewe and goat milk: Effect on the quality of dairy products. *Small Ruminant Research*, vol. 101, no. 1-3, p. 33-40. <http://dx.doi.org/10.1016/j.smallrumres.2011.09.023>
- Bezerra, T. K. A., Arcanjo, Araújo, A. R. R., Queiroz, A. L. M., Oliveira, M., E., G., Gomes, A., M., P., Madruga, M. S. 2017. Volatile profile in goat coalho cheese supplemented with probiotic lactic acid bacteria. *LWT - Food Science and Technology*, vol. 76, no. Part B, p. 209-215. <http://dx.doi.org/10.1016/j.lwt.2016.03.041>
- Buňková, L., Adamcová, G., Hudcová, K., Velichová, H., Pachlová, V., Lorencová, E., Buňka, F. 2013. Monitoring of biogenic amines in cheeses manufactured at small-scale farms and in fermented dairy products in the Czech Republic. *Food Chemistry*, vol. 141, no. 1, p. 548-551. <http://dx.doi.org/10.1016/j.foodchem.2013.03.036>
- Buňková, L., Buňka, F., Hlobilová, M., Vaňátková, Z., Nováková, D., Dráb, V. 2009. Tyramine production of technological important strains of *Lactobacillus*, *Lactococcus* and *Streptococcus*. *European Food Research and Technology*, vol. 229, p. 533-538. <http://dx.doi.org/10.1007/s00217-009-1075-3>
- Combarros-Fuertes, P., Fernández, D., Arenas, R., Diezhandino, I., Tornadijo, M. E., Fresno, J. M. 2016. Biogenic amines in Zamorano cheese: factors involved in their accumulation. *Journal of the Science of Food and Agriculture*, vol. 96, no. 1, p. 295-305. <http://dx.doi.org/10.1002/jsfa.7093>
- Dadáková, E., Křížek, P., Pelikánová, T. 2009. Determination of biogenic amines in foods using ultra-performance liquid chromatography (UPLC). *Food Chemistry*, vol. 116, no. 1, p. 365-370. <http://dx.doi.org/10.1016/j.foodchem.2009.02.018>
- Fontenele, M. A., Bastos, M. S. R., Dos Santos, K. M. O., Bemquerer, M. P., Do Egito, A. S. 2017. Peptide profile of Coalho cheese: A contribution for Protected Designation of Origin (PDO). *Food Chemistry*, vol. 219, 382-390. <http://dx.doi.org/10.1016/j.foodchem.2016.09.171>
- Hickey, D. K., Guinee, T. P., Hou, J., Wilkinson, M. G. 2013. Effects of variation in cheese composition and maturation on water activity in Cheddar cheese during ripening. *International Dairy Journal*, vol. 30, no. 1, p. 53-58. <http://dx.doi.org/10.1016/j.idairyj.2012.11.006>
- Indra, Z., Mizera, J. 1992. *Chemical control methods formilk processing* (Chemické kontrolní metody pro obor zpracování mléka). Praha, 273 p.
- ISO 2004. *Cheese and Processed Cheese – Determination of the Total Solids Content (Reference Method)*. Standard No. 5534: International Organization for Standardization, Geneva.
- Kalač, P. 2014. Health effects and occurrence of dietary polyamines: A review for the period 2005–mid 2013. *Food Chemistry*, vol. 161, p. 27-39. <http://dx.doi.org/10.1016/j.foodchem.2014.03.102>
- Kološta, M., Slottová, A., Drončovský, M., Klapáčová, L., Kmeť, V., Bujňáková, D., Lauková, A., Greif, G., Greifová, M., Tomáška, M. 2014. Characterisation of *Lactobacilli* from ewe's and goat's milk for their further processing re-utilisation. *Potravinářství*, vol. 8, no. 1, p. 130-134. <http://dx.doi.org/10.5219/354>
- Laemml, U. K. 1970. Cleavage of structural proteins during the assembly of the head of bacteriophage T4. *Nature*, vol. 227, p. 680-685. <http://dx.doi.org/10.1038/227680a0>
- Lazárková, Z., Buňka, F., Buňková, L., Holář, F., Kráčmar, S., Hrabě, J. 2011. The effect of different heat sterilization regimes on the quality of canned processed cheese. *Journal of Food Process Engineering*, vol. 34, no. 6, p. 1860-1878. <http://dx.doi.org/10.1111/j.1745-4530.2009.00376.x>
- Quigley, L., O'sullivan, O., Stanton, C., Beresford, T. P., Ross, R. P., Fitzgerald, G. F., Cotter, P. D. 2013. The complex microbiota of raw milk. *FEMS Microbiology Reviews*, vol. 37, no. 5, p. 664-698. <http://dx.doi.org/10.1111/1574-6976.12030>
- Pachlová, V., Buňka, F., Buňková, L., Weiserová, E., Budinský, P., Žaludek, M., Kráčmar, S. 2011. The effect of three different ripening/storage conditions on the distribution of selected parameters in individual parts of Dutch-type cheese. *International Journal of Food Science & Technology*, vol. 46, no. 1, p. 101-108. <http://dx.doi.org/10.1111/j.1365-2621.2010.02460.x>
- Silla Santos, M. H. 1996. Biogenic amines: their importance in food. *International Journal of Food Microbiology*, vol. 29, no. 2-3, p. 213-231. [http://dx.doi.org/10.1016/0168-1605\(95\)00032-1](http://dx.doi.org/10.1016/0168-1605(95)00032-1)
- Sousa, M. J., Ardö, Y., Mcsweeney, P. L. H. 2001. Advances in the study of proteolysis during cheese ripening. *International Dairy Journal*, vol. 11, no. 4-7, p. 327-345. [http://dx.doi.org/10.1016/S0958-6946\(01\)00062-0](http://dx.doi.org/10.1016/S0958-6946(01)00062-0)
- Spano, G., Russol, P., Lonvaud-Funel, A., Lucas, P., Alexandre, H., Grandvalet, C., Coton, E., Coton M., Barnavon, L., Bach, B., Rattray, F., Bunte, A., Magni, C., Ladero, V., Alvarez, M., Fernández, M., Lopez, P., De Palencia, P. F., Corbi, A., Trip, H., Lolkema, J. S. 2010. Biogenic amines in fermented foods. *European Journal of Clinical Nutrition*, vol. 64, p. 95-100. <http://dx.doi.org/10.1038/ejcn.2010.218>
- Ten Brink, B., Damink, C., Joosten, H. M. L. J., Huist In'T Veld, J. H. 1990. Occurrence and formation of biological active amines in foods. *International Journal of Food Microbiology*, vol. 11, no. 1, p. 73-84. [http://dx.doi.org/10.1016/0168-1605\(90\)90040-C](http://dx.doi.org/10.1016/0168-1605(90)90040-C)

Acknowledgments:

The financial support from the Ministry of Agriculture of the Czech Republic, the National Agency for Agriculture Research, project No. QK1710156 in the programme ZEMĚ and the Tomas Bata University in Zlin, Internal Grant Agencies (Project IGA/FT/2017/004).

Contact address:

Vendula Pachlová, Tomas Bata University in Zlin, Faculty of Technology, Department of Food Technology, nam. T. G. Masaryka 5555, 760 01 Zlin, Czech Republic, E-mail: pachlova@ft.utb.cz

Zuzana Charousová, Tomas Bata University in Zlin, Faculty of Technology, Department of Food Technology, nam. T. G. Masaryka 5555, 760 01 Zlin, Czech Republic, E-mail: charousovazuzana@seznam.cz

Tomáš Šopík, Tomas Bata University in Zlin, Faculty of Technology, Department of Food Technology, nam. T. G. Masaryka 5555, 760 01 Zlin, Czech Republic, E-mail: sopik@ft.utb.cz



QUALITY PARAMETERS OF CURD

Roman Pytel, Šárka Nedomová, Vojtěch Kumbár, Libor Kilián

ABSTRACT

The aim of this work was measurement of the curd firmness prepared by different volume of rennet solution and comparison of differences of curd firmness between these volumes. Further, it was observed the influence of different volumes of rennet up to the volume of whey release, curd firmness, dry matter of curd and dry matter of whey. The composition of milk was determined according ISO and Czech state standard. Dry matter content (%) was determined by gravimetry, in drying oven at 102 °C to constant weight (ISO 6731:2010), the protein content (%) by Kjeldahl's method (EN ISO 8968-1:2002), content of fat (%) by Gerber's acidobutyrometric method (ISO 2446:2008), content of lactose by polarimetry, titratable acidity by titration Soxhlet-Henkel method, pH and calcium content in milk ($\text{g}\cdot\text{L}^{-1}$) was determined by complexometric titration with flueroxone as an indicator according to Czech state standard No 57 0530. For coagulation was used microbial rennet CHY-MAX^{RM} 200. There were measured: curd firmness, rennet coagulation time, curd quality, volume of released whey, weight of curd, dry matter of curd and dry matter of whey. Different volumes of rennet solution had influence on curd firmness. Curd firmness (volume of rennet solution) had no significant influence on curd quality (five grade scale). Curd firmness had influence on volume of whey release (mL) out of the curd. With the increasing curd firmness κ increased the volume of whey released from the curd. The volume of rennet solution had an influence on weight of curd. Curd dry matter raised with higher volume of rennet solution. Volume of added rennet solution had no statistically significant effect on the change of whey dry matter.

Keywords: milk; curd firmness; volume of rennet; microbial rennet

INTRODUCTION

Milk coagulation properties are one of the most important technological properties, which include rennet coagulation time, time to curd firmness 20 mm and curd firmness 30 min after enzyme addition (Bittante, 2011).

The essential characteristic step in manufacture of all cheese varieties is coagulation of the casein component of the milk protein system to form a gel which entraps the fat, if present. Coagulation may be achieved by acidification to pH 4.6, acidification to about pH 5.2 in combination with heating to 90 °C or limited proteolysis by selected proteinases (Fox et al., 2004).

Gels are semisolid gelled structures with some shape retention and elasticity. In the lyogel the casein particles are oriented in three-dimensional honeycombed gel structure whose interstices are filled with water.

The structure of the gel is created during milk coagulation has a significant influence on all later operations such as whey discharge, the ripening process and hole formation (Spreer, 1998). The gel formation is accompanied by a number of physicochemical changes, including hydrolysis of κ -casein, increase in the concentration of the glycomacropeptide; aggregation of the sensitized para-casein micelles, increases in viscosity and

elasticity of the milk, and a decrease in the ratio of the viscous to elastic character of the milk (Fox et al., 2000).

Gel can be characteristic by various parameters. Important is structure, especially the coarseness of the network, which can be given as the pore size (distribution). The rheological properties are also essential. One mostly determines the elastic shear modulus or stiffness. This parameter is measured at very small strain. At larger strain, the proportionality between stress and strain is lost, and when the structure stress or strength of the material is reached, the test piece breaks; the fracture strain is also a relevant variable (Walstra et al., 2006).

Curd firmness is dependent on the coagulation temperature and milk quality, it is equally dependent on the amount and quality of rennet. Curd firmness rises to a certain limit from the moment of precipitation proportionally with time. The curd firmness is higher with shorter time of coagulation (Teplý et al., 1976). Good gel-forming properties are characterized by a relatively rapid coagulation time, high-curd firming rate and a high-curd firmness or strength after a given renneting time (Fox et al., 2000). The gel structure is affected by treatments of milk before renneting, as heating regime or the the

homogenization. These treatments influence milk and change their gelation behaviour (Donato and Guyomarc'h, 2009).

Milk coagulation properties are strongly affected by coagulation temperature, pH, CaCl₂ and concentration enzyme (Nájera et al., 2003). Clotting temperature between 30 – 35 °C gave gels with higher firmness (Lucey, 2002). Influence to formation of curd gel consistency, have content of calcium, especially the ionic form (Roginsky et al., 2003).

When is used microbial rennet for renneting, it is needed a longer time for coagulation compared with animal rennet. The curd produced using microbial rennet is softer. As well as, the structure of the curd prepared by various kinds of rennet is different (Teplý et al., 1976).

Optimal curds firmness is one of the main demands in cheesemaking. Soft curd in the cheesemaking is sticky, whey is poorly dripping. In the whey is leaving more milk components. On the other hand, solid curds had an influence to quality of the finally products (Teplý et al., 1976).

Fox et al. (2000) report, that for measure viscosity and curd firmness of the coagulum may be used various type of penetrometers and viscometers.

For the measured of firmness were used penetrometers, which are based on the principle of probe penetration through the test material (Burgess, 1978; Storry and Ford, 1982). The force needed to achieve a given depth or total depth of penetration. The more resistant material is, the greater power need for penetration or the smaller the penetration depth. Distinguish penetrometer with a constant load or constant speed (Krkošková, 1986).

The next method for measurement is determination curd firmness by tromboelastograph where is character of the curve typical for each type of rennet (Teplý et al., 1976).

López et al. (1999) used in their work rotational viscometers, but this type of viscometers provide only limited information about curd firming.

For determination rennet coagulation time and curd firming is used torsion viscometers (thromboelastography or lactodynamography). The most popular torsion viscometer is Formagraph. The Formagraph is an instrument which is able to monitoring of coagulation properties of milk. This test is based on the movement of small, stainless steel, loop pendulum immersed in linearly oscillating samples of coagulating milk. The forces, which are apply to the pendulums as a consequence of formation of a gel in the moving milk sample (McMahon and Brown, 1982).

The next method for predict optimal cutting time as measured by Formagraph is diffuse reflectance technique. The inflection point of sigmoidal phase of the diffuse reflectance curve was well correlated with the Formagraph measure of the rennet clotting time (Payne et al., 1993).

MATERIAL AND METHODOLOGY

This research was carried out in Biotechnology Pavilion M, financed by the OP VaVpI CZ.1.05/4.1.00/04.0135 project at the Department of Food Technology at Mendel University.

For this work was used raw milk of Holsteindairy cows from South Moravian region. Before analysis, milk was heated up to 40 °C and then cooled down to 20 °C for

better dispersion of the fat globules. The milk used for determination of rennet coagulation time and curd firmness was analysed for some basic laboratory parameters. It was determined: dry matter content (%) by gravimetry, by drying oven at 102 °C to constant weight (ISO 6731:2010), protein content (%) by Kjeldahl's method (EN ISO 8968-1:2002), content of fat (%) by Gerber's acidobutyrometric method (ISO 2446:2008), content of lactose by polarimetry, titratable acidity by titration Soxhlet-Henkel method, pH and calcium content in milk (g.L⁻¹) was determined by complexometric titration with flueroxone as an indicator according to Czech state standart No 57 0530 (1974).

In this work was used the proteolytic enzyme, which causes precipitation of milk protein. There was used microbial rennet CHY-MAX^{RM} 200 (CHR. HANSEN, Denmark; 197 IMCU.mL⁻¹; BB: 5/2017). Rennet solutions were prepared daily by diluting 15 mL of rennet CHY-MAX^{RM} 200 with 85 mL deionized water.

The 100 mL of milk was equilibrated at 35 °C, after equilibrated, it was added into samples of milk of 1 mL, 2 mL or 5 mL rennet solution. The experiment was repeated five times for every volume of added rennet. In each category were prepared five milk curd samples for measurement.

There was measured the time required for the first visible flakes (visual method for determination rennet coagulation time). The renneting milk was placed into a thermostat at 35 °C. After one hour in thermostat, samples of milk were evaluated according five grade scale of rennet curd quality by Kuchtík et al. (2008). Another measurement was the volume of whey, which was released from curd by syneresis. The curd was placed on a plate and there was measured firmness of curd by hand penetrometry FG-5N (SHITO, China). For penetration was used conical probe, which was permeated 1 cm into depth from surface. Each curd was measured five times. Here was measured the maximum value of hardness. The rate of penetration was constant. After penetration # was determined dry matter of curd and dry matter of whey by drying to constant weight.

The results were statistically processed by program MS EXCEL and STATISTICA version 12, by ANOVA test, especially Tukey's test ($p < 0.05$).

The aim of this work was measurement of the curd firmness, which was prepared by different volumes of rennet solution and comparing differences of curd firmness between these volumes. Further, there was observed the influence of different volumes of rennet to a volume of whey release, curd firmness, dry matter of curd and dry matter of whey.

RESULTS AND DISCUSSION

The milk used for this work had the following composition: dry matter 13.153 ± 0.166%, content of protein was in range from 3.45 to 3.81% by Kjeldahl's method. Pretto et al. (2011) showed that the average content of protein is 3.50%. The average content of fat in milk was 3.85 ± 0.29% by Gerber's acidobutyrometric method, which is slightly lower than content of fat (3.93%) by Pretto et al. (2011). Lactose content by polarimetry was in range from 4.65 to 4.81%. Calcium content determined by complexometric titration in milk was in range from 1.15 to 1.33 g.L⁻¹. Titratable acidity by titration

Table 1 Influence of volume rennet solution to curd firmness (mN).

Volume of rennet solution	Average	Standard deviation	Minimum	Maximum	Coefficient of variation (%)
1 mL	5.91 ^a	0.89	4.00	7.62	15.00
2 mL	7.51 ^b	1.73	5.04	13.78	22.99
5 mL	7.24 ^b	1.57	5.32	11.28	21.70

Note: ^{a, b} – different superscripts in a column indicate a statistically significant difference at $p < 0.05$.

Table 2 Influence of curd firmness (volume of rennet solution) to rennet coagulation time (s).

Curd firmness (Volume of rennet solution)	Average	Standard deviation	Minimum	Maximum	Coefficient of variation (%)
5.91mN (1 mL)	128.8 ^a	3.6	124.0	136.0	2.8
7.51 mN (2 mL)	71.5 ^b	3.4	57.0	75.0	4.7
7.24 mN (5 mL)	36.2 ^c	1.0	35.0	39.0	2.7

Note: ^{a, b, c} – different superscripts in a column indicate a statistically significant difference at $p < 0.05$.

Table 3 Influence of curd firmness (volume of rennet solution) to curd quality (five grade scale).

Curd firmness (Volume of rennet solution)	Average	Standard deviation	Minimum	Maximum	Coefficient of variation (%)
5.91mN (1 mL)	1.0 ^a	0.2	1.0	2.0	18.9
7.51 mN (2 mL)	1.0 ^a	0.0	1.0	1.0	0.0
7.24 mN (5 mL)	1.1 ^a	0.3	1.0	2.0	25.2

Note: ^a – different superscripts in a column indicate a statistically significant difference at $p < 0.05$.

Table 4 Influence of curd firmness (volume of rennet solution) on release whey (mL).

Curd firmness (Volume of rennet solution)	Average	Standard deviation	Minimum	Maximum	Coefficient of variation (%)
5.91mN (1 mL)	20.8 ^a	2.9	17.0	26.0	14.2
7.51 mN (2 mL)	24.5 ^b	3.0	19.0	32.0	12.3
7.24 mN (5 mL)	27.5 ^c	3.7	22.0	38.0	13.3

Note: ^{a, b, c} – different superscripts in a column indicate a statistically significant difference at $p < 0.05$.

Soxhlet-Henkel method was 6.66 ± 0.22 (°SH) and pH was 6.65 ± 0.04 .

Different volume of rennet solution had an influence on curd firmness (Table 1). 1 mL rennet solution gave a curd with firmness 5.91 mN. 2 mL of rennet solution gave a curd with firmness 7.51 mN, this value is higher than 5.91 mN. Addition of 5 mL rennet solution gave a curd with firmness 7.24 mN, which is slightly lower than the addition of 2 mL of rennet solution. Difference of curd firmness was statistically significant between 1 mL and 2 mL, 1 mL and 5 mL of rennet solution, but difference between 2 mL and 5 mL rennet solution was not statistically significant. **Teplý et al. (1976)** indicate that curd firmness is directly dependent on the concentration of the rennet. Equally, coagulation time was significantly affected by rennet concentration (**Sbodio et al., 2006**).

In the Table 2 are shown average results of rennet coagulation time for different curd firmnesses (volume of rennet solution). Rennet coagulation times for milk used in this work are 128.8 s for 1 mL of rennet solution, 71.5 s for 2 mL and 36.2 s for 5 mL of rennet solution. It follows, that with increasing volume of rennet solution, the rennet coagulation time is shorter. According **Bujko et al. (2011)**, rennet coagulation time is evaluated as “good”, because coagulation time is in range 110 – 140 s.

Curd firmness (volume of rennet solution) did not have any significant influence to curd quality, shown in Table 3,

evaluated by **Kuchtík et al. (2008)**. All curd was classified as very good and hard, keeping its shape after its removal from the container; whey was clear with yellow-greenish colour (1) or as good curd but a little softer, not keeping shape quite perfectly; whey is greenish (2). The curd quality is also affected by rennet, which is used for renneting (**Pytel et al., 2016**) and stage of lactation, which had significant effect on all milk properties and curd quality (**Kuchtík et al., 2008**).

Curd firmness had an influence on a volume of whey release (mL) from the curd (Table 4). With the increasing curd firmness increased the volume of released whey from the curd. The difference between groups was statistically significant ($p < 0.05$).

The curd was weighed after 1 min dripping and then was monitored the influence of curd firmness to curd weight (Table 5). Average weight of curd prepared by 1 mL of rennet solution had 70.30 g, while the average weight of curd prepared by 2 mL of rennet solution had 68.15 g. Between these groups, there was no statistically significant difference. The statistically significant difference was between the weight of curd prepared by 1 mL and 5 mL of rennet solution, which had an average weight 65.52 g. There is statistically significant difference between 2 mL and 5 mL of rennet solution.

In Table 6 are shown results where was monitored the influence curd firmness on curd dry matter. Curd dry

Table 6 Influence of curd firmness (volume of rennet solution) on curd dry matter (%).

Curd firmness (Volume of rennet solution)	Average	Standard deviation	Minimum	Maximum	Coefficient of variation (%)
5.91mN (1 mL)	15.645 ^a	1.655	14.276	21.205	10.577
7.51 mN (2 mL)	15.585 ^a	1.001	14.508	18.662	6.421
7.24 mN (5 mL)	16.004 ^b	1.367	14.077	19.628	8.540

Note: ^{a, b} – different superscripts in a column indicate a statistically significant difference at $p < 0.05$.

Table 7 Influence of curd firmness (volume of rennet solution) on whey dry matter (%).

Curd firmness (Volume of rennet solution)	Average	Standard deviation	Minimum	Maximum	Coefficient of variation (%)
5.91mN (1 mL)	7.557 ^a	0.174	7.230	7.886	2.304
7.51 mN (2 mL)	7.477 ^a	0.109	7.310	7.712	1.454
7.24 mN (5 mL)	7.312 ^a	0.109	7.105	7.548	1.497

Note: ^a – different superscripts in a column indicate a statistically significant difference at $p < 0.05$.

Table 5 Influence of curd firmness (volume of rennet solution) to weight of curd after 1 min dripping (g).

Curd firmness (Volume of rennet solution)	Average	Standard deviation	Minimum	Maximum	Coefficient of variation (%)
5.91mN (1 mL)	70.30 ^a	5.46	60.98	79.13	7.76
7.51 mN (2 mL)	68.15 ^{ab}	4.03	61.01	76.58	5.91
7.24 mN (5 mL)	65.52 ^b	5.98	52.82	77.23	9.12

Note: ^{a, b} – different superscripts in a column indicate a statistically significant difference at $p < 0.05$.

matter was a 15.645% for 5.91 mN, 15.858% for 7.51 mN and 16.004% for 7.24 mN. There was not statistically significant difference between 5.91 mN and 7.51 mN, but difference was between 5.91 mN and 7.24 mN.

In Table 7 is shown, that is not any relation between the volume of rennet solution and whey dry matter. Djurić et al. (2004) presented in their work that whey dry matter is 7.000%. This value is slightly lower than our results. There is any significant difference between adding 1 mL (dry matter 7.557%), 2mL (7.477%) or 5 mL (7.312%) of rennet solution to whey dry matter.

CONCLUSION

Different volume of rennet solution had influence on curd firmness. Difference of curd firmness was statistically significant between 1 mL and 2 mL, 1 mL and 5 mL of rennet solution, but difference between 2 mL and 5 mL rennet solution was not statistically significant. With a higher volume of adding rennet solution is the rennet coagulation time lower, but the highest curd firmness had the curd, which was prepared with an addition of 2 mL of rennet solution. Curd firmness (volume of rennet solution) had no significant influence to curd quality (five grade scale). All curd was classified as very good and hard, keeping its shape after its removal from the container; whey was clear with yellow-greenish colour (1) or as good as curd but a little softer, not keeping a shape quite perfectly; whey is greenish (2).

Curd firmness had an influence to a volume of whey release (mL) from the curd. With the increasing curd firmness was increase the volume of released whey from the curd. The difference between groups was statistically significant.

The statistically significant difference was between weight of curd prepared by 1mL and 5 ml of rennet

solution. There is not a statistically significant difference between 1 mL and 2 mL or 2 mL and 5 mL of rennet solution. Curd dry matter was higher with a higher volume of rennet solution. Volume of added rennet solution had no statistically significant effect to change of whey dry matter.

REFERENCES

- Bittante, G. 2011. Modeling rennet coagulation time and curd firmness of milk. *Journal of Dairy Science*, vol. 94, no. 12, p. 5821-5832. <https://doi.org/10.3168/jds.2011-4514>
- Bujko, J., Kocman, R., Žitný, J., Trakovická, A., Hrnčár, C. 2011. Analyse of trans of milk production in dairy cows. *Potravinarstvo*, vol. 5, no. 1, p. 5-9.
- Burgess, K. J. 1978. Measurement of the Firmness of Milk Coagulum. *Irish Journal of Food Science and Technology*, vol. 2, no. 2, p. 129-134. <https://dx.doi.org/10.5219/93>
- Czech state standart No 57 0530:1974. *Methods for testing of milk and milk products (Metody zkoušení mléka a tekutých mléčných výrobků)*.
- Djurić, M., Carić, M., Milanović, S., Tekić, M., Panić, P. 2004. Development of whey-based beverages. *European Food Research and Technology*, vol. 219, no. 4, p. 321-328.
- Donato, L., Guyomarc'h, F. 2009. Formation and properties of the whey protein/κ-casein complexes in heated skim milk – A review. *Dairy science & technology*, vol. 89, no. 1, p. 3-29. <https://doi.org/10.1051/dst:2008033>
- EN ISO 8968-1:2002. *Milk and milk products – Determination of nitrogen content. Part 1, Kjeldahl method and crude protein calculation*.
- Fox, F., McSweeney, P. L. H., Cohan, T. M., Guinee, T. P. 2004. *Cheese Chemistry, Physics and Microbiology*. 3rd ed., Oxford: Elsevier Ltd. 617 p. ISBN-13: 978-0122636523.
- Fox, P. F., Guinee, T. P., Cogan, T. M., McSweeney, P. L. H. 2000. *Fundamentals of cheese science*. Maryland: Aspen Publishers. 638 p. ISBN 0834212609.

- ISO 2446:2008. *Milk – Determination of fat content*.
ISO 6731:2010. *Milk, cream and evaporated milk – Determination of total solids content*.
- Krkošková, B. 1986. *Textúra potravín (Food texture)*. Bratislava : Alfa – Vydavateľstvo technickej a ekonomickej literatúry. 194 p.
- Kuchčík, J., Šustová, K., Urban, T., Zapletal, D. 2008. Effect of the stage of lactation on milk composition, its properties and the quality of rennet curdling in East Friesian ewes. *Czech Journal of Animal Science*, vol. 53, no. 2, p. 55-63.
- López, M. B., Jordán, M. J., Granados, M. V. Fernández, J. C., Castillo, M., Laencina, J. 1999. Viscosity changes during rennet coagulation of Murciano-Granadina goat milk. *International Journal of Dairy Technology*, vol. 52, no. 3, p. 102-106. <https://doi.org/10.1111/j.1471-0307.1999.tb02081.x>
- Lucey, J. A. 2002. Formation and physical properties of milk protein gels. *Journal of Dairy Science*, vol. 85, no. 2, p. 281-294. [https://doi.org/10.3168/jds.S0022-0302\(02\)74078-2](https://doi.org/10.3168/jds.S0022-0302(02)74078-2)
- McMahon, D. J., Brown, R. J. 1982. Evaluation of Formagraph for Comparing Rennet Solutions. *Journal of Dairy Science*, vol. 65, no. 8, p. 1639-1642. [https://doi.org/10.3168/jds.S0022-0302\(82\)82390-4](https://doi.org/10.3168/jds.S0022-0302(82)82390-4)
- Nájera, A. I., De Renobales, M., Barron, L. J. R. 2003. Effects of pH, temperature, CaCl₂ and enzyme concentrations on the rennet-clotting properties of milk: a multifactorial study. *Food Chemistry*, vol. 80, no. 3, p. 345-352. [https://doi.org/10.1016/S0308-8146\(02\)00270-4](https://doi.org/10.1016/S0308-8146(02)00270-4)
- Payne, F. A., Hicks, C. L., Shen, P. S. 1993. Predicting optimal cutting time of coagulating milk using diffuse reflectance. *Journal of Dairy Science*, vol. 76, no. 1, p. 48-61. [https://doi.org/10.3168/jds.S0022-0302\(93\)77322-1](https://doi.org/10.3168/jds.S0022-0302(93)77322-1)
- Pretto, D., Kaart, T., Vallas, M., Jõudu, I., Henno, M., Ancilotto, L., Cassandro, M., Pärna, E. 2011. Relationships between milk coagulation property trans analyzed with different methodologies. *Journal of Dairy Science*, vol. 94, no. 9, p. 4336-4346. <https://doi.org/10.3168/jds.2011-4267> PMID:21854906
- Pytel, R., Šustová, K., Kumbár, V., Nedomová, Š. 2016. A comparison of determination of the rennet coagulation properties of bovine milk. *Potravinárstvo*, vol.10, no. 1, p. 366-371. <https://doi.org/10.5219/604>
- Roginski, H., Fuquay, J. W., Fox, P. 2003. *Encyclopedia of Dairy Sciences: Volume 1*. New York : Academic Press, 557 p. ISBN-13: 0122272358.
- Sbodio, O. A., Tercero, E. J., Coutaz, R., Revelli, G. R. 2006. Effect of rennet and sodium chloride concentration on milk coagulation properties. *Ciencia y Tecnología Alimentaria*, vol. 5, no. 3, p. 182-188. <https://doi.org/10.1080/11358120609487690>
- Spreer, E. 1998. *Milk and dairy product technology*. New York : CRC Press. 483 p. ISBN 0-8247-0094-5.
- Storry, J. E., Ford, G. D. 1982. Development of coagulum firmness in renneted milk – a two-phase process. *Journal of Dairy Research*, vol. 49, no. 2, p. 343-346. <https://doi.org/10.1017/S0022029900022457>
- Teplý, M., Mašek, J., Havlová, J. 1976. *Syřidla živočišná a mikrobiální (Animal and microbial rennets)*. Praha : SNTL – Nakladatelství technické literatury. 287 p.
- Walstra, P., Wouters, J. T. M., Geurts, T. J. 2006. *Dairy science and technology*. 2nd ed. BocaRaton : CRC Press – Taylor & Francis. 782 p. ISBN-13:978-0-8247-2763-5.

Acknowledgments:

This work was supported by the project TP 2/2017 “Effect of additives on the rheological behaviour on foodstuffs and raw materials for their production” financed by IGA AF MENDELU.

Contact address:

Ing. Roman Pytel, Mendel University in Brno, Faculty of AgriSciences, Department of Food Technology, Zemědělská 1, 613 00 Brno, Czech Republic, E-mail: roman.pytel@mendelu.cz

doc. Ing. Šárka Nedomová, Ph.D., Mendel University in Brno, Faculty of AgriSciences, Department of Food Technology, Zemědělská 1, 613 00 Brno, Czech Republic, E-mail: snedomov@mendelu.cz

Ing. Vojtěch Kumbár, Ph.D., Mendel University in Brno, Faculty of AgriSciences, Department of Technology and Automobile Transport, Zemědělská 1, 613 00 Brno, Czech Republic, E-mail: vojtech.kumbar@mendelu.cz

Ing. Libor Kilián, Mendel University in Brno, Faculty of AgriSciences, Department of Food Technology, Zemědělská 1, 613 00 Brno, Czech Republic, E-mail: kilian3@seznam.cz



EFFECT OF PUMPKIN POWDER INCORPORATION ON COOKING AND SENSORY PARAMETERS OF PASTA

Lucia Minarovičová, Michaela Lauková, Zlatica Kohajdová, Jolana Karovičová, Veronika Kuchtová

ABSTRACT

Pasta is commonly consumed and low glycaemic cereal-based food with long shelf life, which is suitable food matrix for substitution with functional ingredients. Pumpkin powder can be considered as suitable component in pasta making. The effect of addition of pumpkin powder at different levels (5, 7.5, and 10%) on wheat dough rheology, cooking quality of pasta as well as on sensory properties was evaluated. Pumpkin powder included: 6.1% moisture, 8.2% protein, 0.7% crude fat, 2.3% ash, 27.4% total dietary fiber which is included soluble (10.2%) and insoluble (17.2%) dietary fiber. Farinograph properties of pumpkin powder incorporated dough showed increase in water absorption and dough development time while dough stability and mixing tolerance index were decreased. It was also observed that addition of pumpkin powder significantly altered cooking quality of pasta. Generally, pasta incorporated with pumpkin powder had shorter optimal cooking time. The shortest optimal time (5.9 min) was after addition of 10% of pumpkin powder compared with control pasta (7.0 min). From the results also concluded that addition of pumpkin powder significantly increased cooking loss. The highest cooking loss (6.6%) was after addition 10% pumpkin powder. Furthermore it could be stated that incorporation of pumpkin powder in pasta increased water absorption of pasta from 181.0% (control) to 211.2% (10% of pumpkin powder). From sensory evaluation resulted that pumpkin powder incorporated pasta were characterized by lower colour, flavor and grain taste. On the other hand vegetable taste and granular structure of pasta increased with higher addition level of pumpkin powder. Moreover, it was concluded that pasta with addition level 10% were the most acceptable for consumers.

Keywords: pumpkin powder; pasta; farinograph; cooking quality

INTRODUCTION

Pasta is a very popular food in several countries around the world (Tazart et al., 2016). It is favored by consumers for its ease of transportation, handling, cooking, and storage properties. In recent years pasta has become even more popular due to its nutritional properties, being regarded as a product “with low glycemic index” (Tudorica et al., 2002).

As it contains predominantly starch, many studies have attempted to improve the nutritional properties of pasta. These include supplementation with protein, dietary fibre, vitamins and minerals or substituting (partially or completely) the durum wheat semolina with nonconventional flours. A problem with the incorporation of such fibres into conventional pasta is that they can alter its sensory and cooking properties in an undesirable way (De Pilli et al., 2013). The consumption of vegetables and seeds-enriched pasta could be used to create potentially functional food that may help to reduce chronic diseases such as heart disease (Abdel-Moemin, 2016).

Pumpkin (*Cucurbita moschata*) is a gourd-like squash of the genus *Cucurbita* and the family Cucurbitaceae. It is an economically important species cultivated worldwide, has high production. Pumpkin has received considerable attention in recent years because of the nutritional and health benefits of the bioactive compounds obtainable from its seeds and fruits (Wang et al., 2012). This cultivar is extremely variable in their fruit and seeds morphology (Jacobo-Valenzuela et al., 2011). The flesh colour of ripe squash fruits can vary considerably from greenish yellow to dark orange and intense orange flesh is an especially attractive quality in winter squash. The carotenoid composition of *C. moschata* fruits includes α -carotene, β -carotene, lutein, violaxanthin, while the linear carotenoids such as phytoene and lycopene are absent or present only in trace amounts (Conti et al., 2015). The nutritional value of pumpkin fruits is high but varies from one species or cultivar to another. Thus, in the fresh mass of the fruit, total content of carotenoids, a major contributory factor in the high nutritional value of pumpkins, ranges from 2 to 10 mg 100 g⁻¹, the content of vitamins C and E accounting for

9 – 10 mg.100 g⁻¹ and 1.03⁻¹.06 mg.100 g⁻¹, respectively. Pumpkin fruit is also a valuable source of other vitamins, e.g., B6, K, thiamine, and riboflavin, as well as minerals, e.g., potassium, phosphorus, magnesium, iron, and selenium (Rakcejeva et al., 2011). In particular, pumpkin is a rich natural source of protein and dietary fiber (Choi et al., 2012) and has low energy content (about 17 Kcal.100 g⁻¹ of fresh pumpkin (Jacobo-Valenzuela et al., 2011). Pumpkin flesh is a delicious and fully appreciated additive in a diversity of products for children and adults. Pumpkin fruits mainly are being processed to obtain juice, pomade, pickles and dried products (Rakcejeva et al., 2011). Pumpkin can be processed into flour which has a longer shelf-life. Pumpkin flour is used because of its highly-desirable flavour, sweetness and deep yellow-orange colour. It has been reported to be used to supplement cereal flours in bakery products like cakes, cookies, bread, for soups, sauces, instant noodle and spice as well as a natural colouring agent in pasta and flour mixes (Bhat and Bhat, 2013).

The aim of this study was to evaluate the effect of pumpkin powder addition on rheological properties of wheat dough and cooking properties of pasta. Sensory evaluation of cooked pasta was also performed.

MATERIAL AND METHODOLOGY

Material

The pumpkin (*Cucurbita moschata*), wheat flour (Penam Slovakia, a.s., Slovak Republic) and other ingredients (eggs and salt) were purchased in local market.

Preparation of pumpkin powder (PP): clean pumpkins were peeled, cut into slices and seeds were removed. Sliced pumpkins were dried at room temperature for 7 days, ground and sieved to obtain powder particle size of 250 µm and packed in polyethylene bags.

Chemical composition

Proximate analysis including content of: moisture (AACC method 44-19.01), protein (AACC method 46-13.01), crude fat (AACC method 30-25.01) and ash (AACC method 08-01.01). Total dietary fiber (TDF), insoluble (IDF) and soluble dietary fiber (SDF) contents were evaluated by Enzymatic - gravimetric method (AOAC Method 985.29-1986).

Dough characteristics

Rheological parameters of dough were determined using Farinograph Brabender (Duisburg, Germany) according to method ISO 5530-1:2013. The measured parameters were: water absorption (WA), dough development time (DDT), dough stability (DS) and mixing tolerance index (MTI).

Pasta preparation

Pasta was prepared according to recipe described by Hrušková and Vítová (2007) using laboratory pasta maker Häussler LUNA (Heiligenkreuztal bei Riedlingen, Germany) and dried at laboratory temperature for 3 days. PP was used as flour replacement at level 5, 7.5 and 10%. Pasta without PP was also prepared as control sample. Dried pasta is shown in Figure 1.

Cooking properties of pasta

Qualitative parameters of pasta were determined according to methods Rosa-Sibakov et al. (2016). Optimal cooking time (OCT): Dried pasta (10 g) was cooked in distilled water (250 cm³) and OCT was indicated when the white core of the pasta disappeared when squeezed between two glass plates. Cooking loss (CL) was determined by weighing the residue (cooking water) after drying in an oven at 105°C for 2 h. Water absorption of pasta (PWA): cooked pasta were weighed soon after removing the excess water and dried in an oven at 105°C for 2 h. Moisture content of uncooked pasta samples was determined by drying 2 g of sample for 2 h at 105°C.

Sensory evaluation

Sensory evaluation of cooked pasta was carried out according to modified procedure reported by Abdel-Moemin (2016) using 5 – point hedonic scale (1 = dislike very much, 2 = dislike moderately, 3 = neutral, 4 = like moderately and 5 = like very much). The panel was made up of 13 trained judges. The pasta were cooked in boiling distilled water for the optimal time, cooled in tap water for 20 s and died before serving. The attributes evaluated were: shape, colour, flavour, taste (grainy, vegetable) firmness, stickiness and overall acceptability.

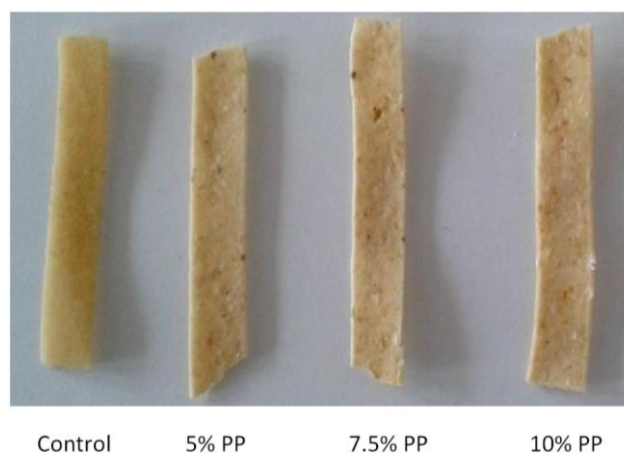

Figure 1 Dried pasta, PP - pumpkin powder.

Table 1 Proximate composition of pumpkin powder and wheat flour.

	Moisture (%)	Protein (%)	Fat (%)	Ash (%)	TDF (%)	IDF (%)	SDF (%)
WF	8.1 ±0.4	10.6 ±0.1	1.2 ±0.0	0.5 ±0.0	2.1 ±0.0	nd	nd
PP	6.1 ±0.1	8.2 ±0.1	0.7 ±0.0	2.3 ±0.0	27.4 ±0.7	17.2 ±0.1	10.2 ±0.1

Note: PP – pumpkin powder, TDF – total dietary fiber, IDF – insoluble dietary fiber, SDF – soluble dietary fiber, nd – not determined.

Statistical analysis

All measurement was carried out in triplicate and results were expressed as mean ±standard deviation. One way analysis of variance and Student's test were used to establish significant differences between mean values at significance level $p = 0.05$ using Microsoft Excel version 2010.

RESULTS AND DISCUSSION

The chemical composition of PP is shown in Table 1. The studies indicated, that PP contained 27.4% TDF, which is higher than 12.1% reported by **Saeleaw and Schleining, (2011)** in pumpkin flour and lower than 44.6% found by de **Escalada Pla et al. (2007)** in dried pumpkin pulp. Moreover, total dietary fiber included 10.2% soluble and 17.2% insoluble dietary fiber. The moisture and crude fat content, 6.1% and 0.7% were in agreement with 7.82 and 0.80% described by **Kim et al. (2016)** and **Saeleaw and Schleining (2011)** in pumpkin fiber and pumpkin flour. It was also observed that pumpkin powder contained 8.2% protein which is lower value than 15.69% described by **Usha et al. (2010)**. The ash content (2.3%) was similar than those reported by de **Escalada Pla et al. (2007)** in dried pumpkin pulp (2.1%).

Rheological properties of dough are very important indices for product development in terms of product quality and process efficiency (**Sivam et al., 2010**). The traditional instruments, which provide practical information for the cereal industry, measure the power input during dough development caused by a mixing action (farinograph, mixograph) and determine the extensional deformation of a prepared dough (extensigraph, alveograph) (**Rodriguez-Sandoval., 2012**). The effect of the addition of PP at different levels on rheological parameters of dough is shown in Table 2.

WA absorption is the amount of water required by a

given weight of flour to yield dough of a given consistency (**Shenoy and Prakash, 2002**). It was observed that addition of PP gradually increased the WA of wheat dough from 53.2% (control) to 56.3% (10% PP). The increase of water absorption could be explained by the important number of hydroxyl groups existing in the fiber structure, which allow more water interactions through hydrogen bonding (**Lauková et al., 2016**). Similar increase in WA was also described when carrot pomace powder (**Kohajdová et al., 2011**), sweet potato fiber (**Amal, 2015**), djulis flour (**Li et al., 2015**), wheat germ flour (**Sun et al., 2015**) were added in wheat dough.

DS is the difference in time between the time when the curve first intercepts the 500 Brabender unit line and the time when the curve leaves the 500 line (**Shenoy and Prakash, 2002**). Stability is related to the quality of the protein matrix, which is easily damaged by the incorporation of other ingredients, due to gluten dilution (**Sun et al., 2015**). Generally, it was concluded that PP incorporation in dough significantly decreased the DS compared to control (9.6 min). The low stability time during the dough mixing period is indicative of a weak gluten (**Rodriguez-Sandoval et al., 2012**). These observations were consistent with those determined by **Trejo-González et al. (2014)**, **Kohajdová et al. (2013)** and **El-Sharnouby et al. (2012)** when sweet potato flour, pea flour and mixture of wheat bran: date powder (1 :1) were added in wheat dough.

DDT is the time from addition of water to the development of dough's maximum consistency (**Shenoy and Prakash, 2002**). Time of dough development depends on the amount and quality of gluten, granularity of flour and the level of grinding and is determined primarily by the process of gluten hydration. The fibers need time to absorb water and, also compete with flour components for water. It is necessary some time to realize equilibrium of water between dough components. The hydration rate for

Table 2 Farinographic parameters of dough with addition of PP.

	WA (%)	DS (min)	DDT (min)	MTI (BU)
control	45.2 ±0.1	9.6 ±0.1	2.6 ±0.1	61.0 ±1.0
PP 5%	56.2 ±0.1*	9.3 ±0.1	2.5 ±0.1	105.0 ±5.0*
PP 7.5%	56.2 ±0.0*	9.2 ±0.2*	3.1 ±0.1*	60.0 ±2.0*
PP 10%	56.3 ±0.1*	5.6 ±0.1*	3.8 ±0.1*	30.3 ±0.6*

Note: PP – pumpkin powder, WA – water absorption, DS – dough stability, DDT- dough development time, MTI – mixing tolerance index, BU – brabender units, * denotes statistically significant difference at $p - 0.05$ level.

Table 3 Cooking parameters of pasta with addition of PP.

	OCT (min)	CL (%)	PWA (%)	Moisture (%)
control	7.0 ±0.0	4.5 ±0.2	181.0 ±1.5	6.6 ±0.0
PP 5%	6.2 ±0.0*	5.1 ±0.1*	203.6 ±3.8*	6.3 ±0.0*
PP 7.5%	6.0 ±0.0*	5.6 ±0.1*	207.8 ±1.2*	6.4 ±0.1*
PP 10%	5.9 ±0.0*	6.6 ±0.1*	211.2 ±8.2*	6.9 ±0.0*

Note: PP – pumpkin powder, OCT – optimal cooking time, PWA – pasta water absorption, * denotes statistically significant difference at $p - 0.05$ level.

every fibers is different and the time to fully hydrate in dough modify the development time of dough (Ognean et al., 2011). From the results concluded that addition of PP significantly increased the DDT. The highest DDT value was recorded at addition level 10% (3.8 min). Similar results were described after addition of potato fiber (Bojňanská et al., 2014), pea flour (Kohajdová et al., 2013), carrot pomace powder (Kohajdová et al., 2012) and mango peel powder (Ajila et al., 2008) to wheat dough.

MTI indicated a consistency difference in dough between the height at the peak and the height 5 min later (Li et al., 2015). It can be also noticed that MTI significantly decreased as the substitution level of PP increased. These results were in agreement with those found by Amal (2015) and Larrea et al. (2005) after addition of sweet potato powder and extruded orange pulp to wheat dough.

Cooking quality, which includes cooking loss, cooked weight, and texture of the cooked pasta, is the most important quality attribute (Ajila et al., 2010). Pasta quality depends mainly on the properties of flour raw materials, especially protein content and quality, and gluten properties; starch properties are of a lesser importance (Dziki and Laskowski, 2005). The cooking quality parameters of pasta are presented in Table 3.

The OCT was achieved when the centre of the pasta was fully hydrated (De Pilli et al., 2013). From the results concluded that substitution of wheat flour with PP in pasta significantly reduced OCT from 7.0 min (control) to 5.9 min (10% PP). These results were in agreement with those described by Petitot et al. (2010) and Kuchtová et al. (2016) after supplementation wheat flour in pasta with faba bean flour and pumpkin powder. Gluten is primarily responsible for the development of the starch-protein structure, which in turn is the primary determinant of pasta texture and cooking properties, so a dilution of these components will reduce the cooking time as observed (Rakhesh et al., 2014).

PWA is an indication of the quantity of water absorbed by the noodles during cooking, an important characteristic in determining the cooking quality of pasta (Li et al., 2015). It was observed that with addition of PP gradually increased PWA from 181.0% (control) to 211.2% (10%). These results were in agreement with those reported by

when faba starch (Rosa-Sibakov et al., 2016), pumpkin powder (Kuchtová et al., 2016), guar gum and carboxymethylcellulose (Aravind et al., 2012) were incorporated in pasta.

CL is defined as the amount of solids that dissolve in water during cooking and may be an indicator of noodle structural integrity during cooking (Li et al., 2015). As a result, the cooking water becomes cloudy and thick (Ajila et al., 2010). CL is a commonly used predictor of overall pasta cooking performance by both consumers and industry (Tudorica et al., 2002). The type of ingredients in the pasta mix influences the loss of solubles and solids during cooking, and it has been reported that a compact texture of the pasta often results in less cooking loss than the loose textured pasta (Krishnan et al., 2012). From the results concluded that addition of PP increased CL. The highest CL (6.6%) was after substitution of wheat flour by 10% PP. This increase in CL could be due to a disruption of the protein-starch matrix and the uneven distribution of water within the pasta matrix due to the competitive hydration tendency of the fiber, thus preventing starch swelling due to limited water availability (Tudorica et al., 2002). Similar increase in CL was reported when carrot pomace powder (Gull et al., 2015), broad bean flour (Tazart et al. 2016) and inulin (Bustos et al., 2011) were incorporated into pasta.

Also it was observed that moisture content in pasta significantly increased with increasing addition level of PP. The highest moisture content (6.9%) was found in pasta with addition of PP at level 10%. These results were in constituent with those found by Abdel-Moemin (2016) after incorporation palm kernels and purple carrot flour in pasta.

The external appearance of pasta and other attributes of sensory quality after cooking are the most important criteria of pasta quality evaluation (Dziki and Laskowski, 2005). Enrichment with DF not only influences the overall properties, but also significantly affects the sensory properties of the product (Kohajdová et al., 2011). The sensory parameters of pasta supplemented with PP are shown in Table 4 and Table 5.

From sensory evaluation it can be concluded that addition of PP in pasta decreased scores of flavour and grain taste while vegetable taste was significantly

Table 4 Sensory parameters of pasta with addition of PP.

	Shape	Colour	Flavour	Grain taste	Vegetable taste
control	4.9 ±0.2	4.4 ±0.2	4.7 ±0.2	4.6 ±0.2	1.0 ±0.0
PP 5%	4.7 ±0.2*	4.1 ±0.2*	4.3 ±0.2*	3.4 ±0.2*	2.0 ±0.1*
PP 7.5%	4.8 ±0.2*	4.2 ±0.2*	4.4 ±0.1*	3.9 ±0.1*	2.7 ±0.1*
PP 10%	4.9 ±0.2*	4.1 ±0.2*	4.5 ±0.2*	2.5 ±0.1*	3.0 ±0.1*

Note: PP – pumpkin powder, * denotes statistically significant difference at $p = 0.05$ level.

Table 5 Sensory parameters of pasta with addition of PP.

	Granular structure	Firmness	Stickiness	Overall acceptance (%)
control	3.3 ±0.1	4.2 ±0.1	3.4 ±0.2	95.4 ±4.3
PP 5%	3.4 ±0.1*	3.8 ±0.1*	3.1 ±0.1*	76.6 ±3.4*
PP 7.5%	3.5 ±0.1*	3.5 ±0.2*	3.3 ±0.1*	78.1 ±1.6*
PP 10%	3.8 ±0.1*	3.3 ±0.1*	3.5 ±0.1*	80.3 ±3.0*

Note: PP – pumpkin powder, * denotes statistically significant difference at $p = 0.05$ level.

increased. Moreover it was found that enrichment of pasta also affected the shape and stickiness. Pasta colour is a very important quality attribute that greatly influences consumer acceptance, and it is the only property that the consumer can evaluate when selecting a product in the market (Tazart et al., 2016). It was also found that addition of PP decreased the colour scores of pasta. The textural characteristics of pasta play an essential role in determining the final acceptance by consumers, who have shown a preference for pasta that retains texture characteristics not only with normal cooking time but also with overcooking (Tudorica et al., 2002). Addition of PP significantly decreased firmness and increased granular structure of pasta at all addition levels. The reduction in pasta firmness may be associated with the role of fiber supplements in disrupting the protein-starch matrix within the pasta microstructure (Tudorica et al., 2002). Sensory evaluation also revealed that most acceptable pasta was obtained at 10% addition level of PP.

CONCLUSION

The incorporation of pumpkin powder significantly affects the rheological parameters of wheat dough. It was observed that incorporation of pumpkin powder in wheat dough increased water absorption, prolonged dough development time and reduced dough stability and mixing tolerance index.

Addition of pumpkin powder caused shorter optimal cooking time, higher cooking loss, pasta water absorption and moisture of pasta.

From sensory evaluation resulted that pumpkin powder incorporated pasta were characterized by lower colour, flavor and grain taste. On the other hand vegetable taste and granular structure of pasta increased with higher addition level of pumpkin powder. Moreover, it was concluded that pasta with addition level 10% were the most acceptable for accessors.

REFERENCES

- AACC:2000. *Approved methods of american association of cereal chemists*, 10th ed. The Association St. Paul, MN. moisture (method 44-19.01), ash (method 08-01.01), protein (method 46-13.01), crude fat (method 30-25.01).
- Abdel-Moemin, A. R. 2016. Analysis of phenolic acids and anthocyanins of pasta-like product enriched with date kernels (*Phoenix dactylifera* L.) and purple carrots (*Daucus carota* L. sp. *sativus* var. *atrorubens*). *Journal of Food Measurement and Characterization*, no. 4, 14 p. <https://doi.org/10.1007/s11694-016-9329-9>
- Ajila, C. M., Aalami, M., Leelavathi, K., Rao, U. P. 2010. Mango peel powder: A potential source of antioxidant and dietary fiber in macaroni preparations. *Innovative Food Science & Emerging Technologies*, vol. 11, no.1, p. 219-224. <https://doi.org/10.1016/j.ifset.2009.10.004>
- Ajila, C. M., Leelavathi, K., Prasada Rao, U. J. S. 2008. Improvement of dietary fiber content and antioxidant properties in soft dough biscuits with the incorporation of mango peel powder. *Journal of Cereal Science*, vol. 48, no. 2, p. 319-326. <https://doi.org/10.1016/j.jcs.2007.10.001>
- Amal, A. M. 2015. Quality evaluation of wheat-sweet potato composite flours and their utilization in bread making. *International Journal of Advanced Research in Biological Sciences*, vol. 2, no. 11, p. 294-303.
- AOAC Method 985.29-1986:2003. *Total dietary fiber in foods. Enzymatic-gravimetric method.*
- Aravind, N., Sissons, M., Fellows, C. M. 2012. Effect of soluble fibre (guar gum and carboxymethylcellulose) addition on technological, sensory and structural properties of durum wheat spaghetti. *Food Chemistry*, vol. 131, no. 3, p. 893-900. <https://doi.org/10.1016/j.foodchem.2011.09.073>
- Bhat, M. A., Bhat, A. 2013. Study on Physico-Chemical Characteristics of Pumpkin Blended Cake. *Journal of Food Processing and Technology*, vol. 4, no. 9, p. 4. <https://doi.org/10.4172/2157-7110.1000262>
- Bojňanská, T., Tokár, M., Frančáková, H. 2014. Changes of the dough rheological properties influenced by addition of potato fibre. *Potravinarstvo*, vol. 8, no. 1, p. 161-166. <https://doi.org/10.5219/371>
- Bustos, M. C., Pérez, G. T., León, A. E. 2011. Effect of four types of dietary fibre on the technological quality of pasta. *Food Science And Technology International*, vol. 17, no. 3, p. 219-221. <https://doi.org/10.1177/1082013210382303>
- Contia, S., Villarib, G., Amicoa, E., Caruso, G. 2015. Effects of production system and transplanting time on yield, quality and antioxidant content of organic winter squash (*Cucurbita moschata* Duch.). *Scientia Horticulturae*, vol. 183, p. 136-143. <https://doi.org/10.1016/j.scienta.2014.12.003>
- de Escalada Plaa, M. F., Ponce, N. M., Stortz, C. A., Gerschenson, L. N., Rojas, A. M. 2007. Composition and functional properties of enriched fiber products obtained from pumpkin (*Cucurbita moschata* Duchesne ex Poirét). *LWT – Food Science and Technology*, vol. 40, no. 7, p. 1176-1185. <https://doi.org/10.1016/j.lwt.2006.08.006>
- De Pilli, T., Derossi, A., Severini, C. 2013. Cooking quality characterisation of ‘spaghetti’ based on soft wheat flour enriched with oat flour. *International Journal of Food Science and Technology*, vol. 48, no. 11, p. 2348-2355.
- Dziki, D., Laskowski, J. 2005. Evaluation of the cooking quality of spaghetti. *Polish Journal of Food Nutrition Science*, vol. 14/55, no. 2, p. 153-158.
- El-Sharnouby, G. A., Aleid, S. M., Al-Otaibi, M. M. 2012. Nutritional Quality of Biscuit Supplemented with Wheat Bran and Date Palm Fruits (*Phoenix dactylifera* L.). *Food and Nutrition Sciences*, vol. 3, no. 3, p. 322-328. <https://doi.org/10.4236/fns.2012.33047>
- Gull, A., Prasad, K., Kumar, P. 2015. Effect of millet flours and carrot pomace on cooking qualities, color and texture of developed pasta. *LWT-Food Science and Technology*, vol. 63, no. 1, p. 470-474. <https://doi.org/10.1016/j.lwt.2015.03.008>
- Hrušková, M., Vítová, M. 2007. Laboratorní těstářenský pokus (Laboratory Dough test). *Mlynářské noviny*, vol. 18, no. 2, p. 7-9.
- Choi, Y., Kim, H., Hwang, K., Song, D., Park, J., Lee, S., Choi, M., Coi, J., Kim, Ch. 2012. Effects of Pumpkin (*Cucurbita maxima* Duch.) Fiber on Physicochemical Properties and Sensory Characteristics of Chicken Frankfurters. *Korean Journal for Food Science of Animal Resources*, vol. 32, no. 2, p. 174-183. <https://doi.org/10.5851/kosfa.2012.32.2.174>
- ISO 5530-1:2013. *Wheat flour – Physical characteristic of doughs – Part 1: Determination of water absorption and rheological properties using a farinograph.*
- Jacobo-Valenzuela, N., Zazueta-Morales, J. J., Gallegos-Infante, J. A., Aguilar-Gutierrez, F., Camacho-Hernandez, I. L., Rocha-Guzman, N. E., Gonzales-Laredo, R. F. 2011. Chemical and Physicochemical Characterization of Winter Squash (*Cucurbita moschata* D.). *Notulae Botanicae Horti Agrobotanici Cluj-Napoca*, vol. 39, no. 1, p. 34-40.

- Kim, Ch., Kim, H., Hwang, K., Song, D., Ham, Y., Choi, J., Kim, Y., Choi, Y. 2016. Effects of Dietary Fiber Extracted from Pumpkin (*Cucurbita maxima Duch.*) on the Physico-Chemical and Sensory Characteristics of Reduced-Fat Frankfurters. *Korean Journal for Food Science of Animal Resources*, vol. 36, no. 3, p. 309-318. <https://doi.org/10.5851/kosfa.2016.36.3.309>
- Kohajdová, Z., Karovičová, J., Jurasová, M. 2012. Influence of Carrot Pomace Powder on the Rheological Characteristics of Wheat Flour Dough and on Wheat Rolls Quality. *Acta Scientiarum Polonorum, Technologia Alimentaria*, vol. 11, no. 4, p. 381-387.
- Kohajdová, Z., Karovičová, J., Jurasová, M., Kukurová, K. 2011b. Application of citrus dietary fibre preparations in biscuit production. *Journal of Food and Nutrition Research*, vol. 50, no. 3, p. 182-190.
- Kohajdová, Z., Karovičová, J., Magala, M. 2013. Rheological and qualitative characteristics of pea flour incorporated cracker biscuits. *Croatian Journal of Food Science and Technology*, vol. 5, no. 1, p. 11-17.
- Krishnan, J. G., Menon, R., Padmaja, G., Sajeev, M. S., Moorthy, S. N. 2012. Evaluation of nutritional and physico-mechanical characteristics of dietary fiber-enriched sweet potato pasta. *European Food Research and Technology*, vol. 234, no. 3, p. 467-476. <https://doi.org/10.1007/s00217-011-1657-8>
- Kuchtová, V., Kohajdová, Z., Karovičová, J., Mešterová, E. 2016. Use of pumpkin fiber for the preparation of pasta (Využitie tekvicovej vlákniny pri príprave cestovín). *Chemické Listy*, vol. 110, no. 11, p. 808-811.
- Larrea, M. A., Chang, Y. K., Martinez-Bustos, F. 2005. Some functional properties of extruded orange pulp and its effect on the quality of cookies. *LWT - Food Science and Technology*, vol. 38, no. 3, p. 213-220. <https://doi.org/10.1016/j.lwt.2004.05.014>
- Lauková, M., Kohajdová, Z., Karovičová, J. 2016. Effect of hydrated apple powder on dough rheology and cookies quality. *Potravinárstvo*, vol. 10, no. 1, p. 506-511. <https://doi.org/10.5219/597>
- Li, P., Lu, W., Hsieh, Ch., Li, T., Huang, D. 2015. Rheological Properties of Dough and Quality of Salted Noodles Supplemented with Djulis (*Chenopodium formosanum Koidz.*) Flour. *Journal of Agricultural Science*, vol. 7, no. 6, p. 84-92. <https://doi.org/10.5539/jas.v7n6p84>
- Ognean, C. F., Ognean, M., Darie, N. 2011. The Effect of Some Commercial Fibers on Dough Rheology. *Bulletin UASVM Agriculture*, vol. 68, no. 2, p. 372-377, ISSN 1843-5246.
- Petitot, M., Boyer, L., Minier, C., Micard, V. 2010. Fortification of pasta with split pea and faba bean flours: Pasta processing and quality evaluation. *Food Research International*, vol. 43, no. 2, p. 634-641. <https://doi.org/10.1016/j.foodres.2009.07.020>
- Rakcejeva, T., Galoburda, R., Cude, L., Strautniece, E. 2011. Use of dried pumpkins in wheat bread production. *Procedia Food Science*, vol. 1, p. 441-447. <https://doi.org/10.1016/j.profoo.2011.09.068>
- Rakesh, N., Fellows, C. M., Sissons, M. 2015. Evaluation of the technological and sensory properties of durum wheat spaghetti enriched with different dietary fibres. *Journal of the Science of Food and Agriculture*, vol. 95, no. 1, p. 2-11. <https://doi.org/10.1002/jsfa.6723>
- Rodriguez-Sandoval, E., Sandoval, G., Cortes-Rodríguez, M. 2012. Effect of Quinoa and Potato Flours on the Thermomechanical and Breadmaking Properties of Wheat Flour. *Brazilian Journal of Chemical Engineering*, vol. 29, no. 3, p. 503-510. <https://doi.org/10.1590/S0104-66322012000300007>
- Rosa-Sibakov, N., Heinio, R., Cassan, D., Holopainen-Mantila, U., Micard, V., Lantto, R., Sozer, N. 2016. Effect of bioprocessing and fractionation on the structural, textural and sensory properties of gluten-free faba bean pasta. *LWT – Food Science and Technology*, vol. 67, no. 4, p. 27-36. <https://doi.org/10.1016/j.lwt.2015.11.032>
- Saeleaw, M., Schleining, G. 2011. Composition, Physicochemical and Morphological Characterization of Pumpkin Flour. In: *Proceedings of the ICEF11 – 11th International Congress on Engineering and Food “ Food Process Engineering in a Changing World”*. Athens, Greece : National Technical University, p. 869-870. ISBN: 978-960-89789-3-5.
- Shenoy, A., Prakash, J. 2002. Wheat bran (*Triticum aestivum*): composition, functionality and incorporation in unleavened bread. *Journal of Food Quality*, vol. 25, no. 3, p. 197-211. <https://doi.org/10.1111/j.1745-4557.2002.tb01019.x>
- Sivam, A. S., Sun-Waterhouse, D., Quek, S., Perera C. O. 2010. Properties of Bread Dough with Added Fiber Polysaccharides and Phenolic Antioxidants: A Review. *Journal of Food Science*, vol. 75, no. 8, p. 163-174. <https://doi.org/10.1111/j.1750-3841.2010.01815.x>
- Sun, R., Zhang, Z., Hu, X., Xing, Q., Zhuo, W. 2015. Effect of wheat germ flour addition on wheat flour, dough and Chinese steamed bread properties. *Journal of Cereal Science*, vol. 64, p. 153-158. <https://doi.org/10.1016/j.jcs.2015.04.011>
- Tazart, K., Lamacchia, C., Zaidi, F., Haros, M. 2016. Nutrient composition and in vitro digestibility of fresh pasta enriched with Vicia faba. *Journal of Food Composition and Analysis*, vol. 47, no. 4, p. 8-15. <https://doi.org/10.1016/j.jfca.2015.12.007>
- Trejo-González, A. S., Loyo-González, A. G., Munguía-Mazariegos, M. R. 2014. Evaluation of bread made from composite wheat-sweet potato flours. *International Food Research Journal*, vol. 21, no. 4, p. 1683-1688.
- Tudorica, C. M., Kuri, V., Brennan, S. 2002. Nutritional and Physicochemical Characteristics of Dietary Fiber Enriched Pasta. *Journal of Agricultural and Food Chemistry*, vol. 50, no. 2, p. 347-356. <https://doi.org/10.1021/jf0106953>
- Usha, R., Lakshmi, M., Ranjani, M. 2010. Nutritional, Sensory and Physical Analysis of Pumpkin Flour Incorporated into Weaning Mix. *Malaysian Journal of Nutrition*, vol. 16, no. 3, p. 379-387. [PMid:22691991](https://doi.org/10.1016/j.jfca.2015.12.007)
- Wang, S., Huang, W., Liu, Ch., Wang, M., Ho, Ch., Huang, W., Hou, Ch., Chuang, H., Huang, Ch. 2012. Pumpkin (*Cucurbita moschata*) Fruit Extract Improves Physical Fatigue and Exercise Performance in Mice. *Molecules*, vol. 17, no. 10, p. 11864-11876. <https://doi.org/10.3390/molecules171011864>

Acknowledgments:

This work was supported by grant VEGA No. 1/0487/16.

Contact address:

Ing. Lucia Minarovičová, PhD., Slovak University of Technology in Bratislava, Faculty of Chemical and Food Technology, Institute of Food Science and Nutrition, Department of Food Technology, Radlinského 9, 812 37 Bratislava, Slovakia, E-mail: lucia.minarovicova@stuba.sk

Ing. Michaela Lauková, Slovak University of Technology in Bratislava, Faculty of Chemical and Food Technology, Institute of Food Science and Nutrition, Department of Food Technology, Radlinského 9, 812 37 Bratislava, Slovakia, E-mail: michaela.laukova@stuba.sk

Ing. Zlatica Kohajdová, PhD., Slovak University of Technology in Bratislava, Faculty of Chemical and Food Technology, Institute of Food Science and Nutrition, Department of Food Technology, Radlinského 9, 812 37 Bratislava, Slovakia, E-mail: zlatica.kohajdova@stuba.sk

doc. Ing. Jolana Karovičová, PhD., Slovak University of Technology in Bratislava, Faculty of Chemical and Food Technology, Institute of Food Science and Nutrition,

Department of Food Technology, Radlinského 9, 812 37 Bratislava, Slovakia, E-mail: jolana.karovicova@stuba.sk

Ing. Veronika Kuchtová, Slovak University of Technology in Bratislava, Faculty of Chemical and Food Technology, Institute of Food Science and Nutrition, Department of Food Technology, Radlinského 9, 812 37 Bratislava, Slovakia, E-mail: veronika.kuchtova@stuba.sk



AGING OF BEEF RUMPSTEAK ON SENSORY QUALITY, COLOR APPEARANCE AND TEXTURE PROPERTIES

Hana Šulcerová, Vladimír Sýkora, Šárka Nedomová, Michal Mihok

ABSTRACT

The aim of the work was to optimize the time of aging of beef – rumpsteak for culinary processing in relation to color, texture and sensory changes. The 8 weeks of dry-aging had an influence on color change by 18% and there was darkening of samples, darker meat linearly, without any variations. During dry-aging decreased softness and increased strength steaks. There was no significant effect of maturation and softness, it has only been affected by less than 5% ($p < 0.05$). The best evaluation was obtained after 7 weeks of aging in descriptors. The main point was in intensity and pleasantness of flavor and intensity and pleasantness and taste. On the other hand, juiciness and texture to bite was evaluated after 4 weeks of aging the best. As the softest sample in descriptor texture in bites it was four-week aging; as the hardest sample was observed in 8 week of dry-aging. Dry-aging affected ($p < 0.05$) the L^* value, the trend during dry-aging period had decreasing tendencies. On the other hand, in the course of decreasing lightness fluctuations was observed in lightness value L^* . Chromaticity value a^* displayed a negative significant ($p < 0.05$) correlation to weeks of dry-aging. Dry aging had a significant negative effect ($p < 0.05$) on the chromatic value b^* . The length of the dry-aging had significant statistical impact on the lightness and both chromatic coordinates. The length of dry-aging had paramount influence on the textural properties of rump steaks evaluated by instrument.

Keywords: beef meat dry-aging; sensory evaluation; CIELAB; consistency; color

INTRODUCTION

Consumers commonly use product appearance and color to select or refuse food processed products; muscle food products must also create and keep the desired color attributes. In fresh meat, color is the most important attribute that consumers use as purchase criterion (Mancini and Hunt 2005; Tapp et al., 2011; AMSA, 2012; Aroeira et al., 2017). Appearance and color depend on the content of heme pigments and muscle structure (Aroeira et al., 2017).

The color of muscle food is mainly influenced by myoglobin, the primary red pigment in meat. Nevertheless, ultimate perceived color is affected by many factors such as species, animal genetics, and nutritional background, postmortem changes in muscle (especially the dynamics of pH and meat temperature decline), inter- and intramuscular effects, postmortem storage temperatures and time, and a whole host of processing (including antimicrobial interventions), packaging, and display and lighting variables (AMSA, 2012).

Aging conditions influence the cellular mechanisms governing myoglobin redox chemistry and thus can affect color stability when aged beef is subsequently displayed

in retail (Suman et al., 2014; Aroeira et al., 2017). Color evaluation is an essential part of meat research, product development, and troubleshooting of processing problems. When done properly, both visual and instrumental appraisals of color are powerful and useful research tools for meat scientists (AMSA, 2012).

During post-mortem aging, substantial improvements in meat palatability attributes such as tenderness, flavor, and/or juiciness occur likely due to a structural breakdown of muscle by endogenous proteases (Kristensen and Purslow, 2001; Huff-Lonergan and Lonergan, 2005; Kemp et al., 2010; Kim et al., 2014). In general, aging can be progressed through either dry-aging (where beef carcasses or primal/sub-primal cuts are stored in a refrigerated temperature without protective packaging materials), or wet-aging (mostly wholesale primal/sub-primal cuts under vacuum packaging). Dry-aging is typically the aging of premium meat under critically controlled ambient conditions of temperature, relative humidity and airflow (Colle et al., 2016). These parameters need to be carefully balanced and monitored to inhibit microbial growth and minimise weight loss, while producing excellent eating quality resulting from

Table 1 Legend of rump steak analyses.

Samples	Date of slaughtery	Start of aging	Aging (weeks)	Age of animal (months)
0	2016-07-01	2016-07-04	0	19
2	2016-06-24	2016-06-27	2	21
3	2016-06-13	2016-06-16	3	22
4	2016-06-02	2016-06-06	4	29
5	2016-06-02	2016-06-03	5	29
6	2016-05-26	2016-05-31	6	22
7	2016-05-13	2016-05-17	7	32
8	2016-05-09	2016-05-11	8	22

tenderisation and enhanced flavor (Savell, 2008; Kim et al., 2016).

It has been established that several factors affect the instrumental color readings of meat samples (Tapp et al., 2011). Meat color changes affect physical properties of light, chemical composition of muscle, and aging process. Color of muscle food is evaluated by sensory assessors who can be affected of other incidental effects and final color is complex of several sensations (Sýkora et al., 2016). Nevertheless, assessors can better evaluated general color and other properties of muscle food effectively than instrumental equipment. Certain parameters are investigated in the instrumental measurement with specific background and all measured parameters are standardized. Sensory evaluation is good tool of simultaneously instrument measurement because some of parameters are better to evaluated by assessor e.g. general appearance and by instrument e.g. changes during dry-aging.

Dry-aging is a traditional process to store whole carcasses or unpackaged primals or sub-primals under a controlled environment (e.g. temperature, humidity, and air flow) for a certain period of time (Savell, 2008; Kim et al., 2016; Kim et al., 2017).

The aim of the work was to optimize the time of aging of beef – rumpsteak for culinary processing in relation to color, texture and sensory changes.

MATERIAL AND METHODOLOGY

Material

For all analyses there were used samples of round of beef from the middle part of rump (rumpsteak) (Table 1). For experiment samples were stored in condition of dry-aging in period of 8 weeks at the temperature 1 ± 0.5 °C and relative humidity 80 – 85%. Samples were sampling together, analyzed and evaluated in one day.

Methods

Color

Color of the rumps steaks samples were determined as reflectance values based on the $L^*a^*b^*$ system of CIE; using a spectrophotometer CM-3500d (Konica Minolta, Osaka, Japan) containing an integrated spectral component, at D65 illuminator, 10° observer, and SCE. Samples were measured in foil at least three scans were taken per steak. CIE $L^*a^*b^*$ values were recorded, which represent lightness, redness, yellowness, respectively. The recorded results from am Color Data Software SpectraMagic NX were calculated in statistical evaluation.

Texture properties

The texture properties of raw rumpsteak were measured by TIRATEST 27025 (TIRA Maschinenbau GmbH, Germany) – universal testing machine measuring of various materials for tensile, pressure, and bending resistance. Two methods with a 200 N compression load cell with a crosshead speed of 100 mm.min⁻¹ were used. The tenderness of the raw rumpsteak was determined through the application of the Meullenet–Owens razor shear (MORS) test (Cavitt et al., 2005; Meullenet et al., 2004) during which Razor Blade Shear Force (N) were recorded. The second method was the penetration with ball-end probe with diameter 10 mm to the depth 1 cm.

Sensory evaluation

Samples were prepared by chef specialist by rapid browning on all sides of the steak, subsequently baking at 180 °C in 5 minutes and 5 minutes “rest” before final filleting and served. There were not used any seasonings in samples preparation. Steaks were assessed by 12 assessors and were present randomly and without the time sequence of the aging. Results were recorded in the form without unstructured graphical segments, with endpoints word description (100 mm). There were evaluated following descriptors: flavor – pleasantness, flavor – intensity, texture on bite, juiciness, taste – pleasantness, taste – intensity.

Statistical evaluation

Panel data were collected by MS Excel and tested with one-way analysis of variance (ANOVA, Statistica 12.0) by means of Duncan’s test ($p < 0.05$) for multiple comparisons.

RESULTS AND DISCUSSION

Dry-aging affected ($p < 0.05$) the L^* value, the trend during dry-aging period had decreasing tendencies (Table 2). Dynamic changes during steaks dry-aging could lead to a series of alterations that may affect meat quality, especially its color. It is likely that the large concentration of solutes, especially heme pigments, in the intracellular medium cause by aging contributed to a greater absorption of light, and is thus responsible for the reduced lightness (Aroeira et al., 2017).

During dry-aging there were observed changes in L^* value. The initial L^* 40.52 ± 0.61 increased in the second week of aging to 44.82 ± 1.07 and this variability in L^* were observed in next four weeks. In the fourth week L^* 43.96 ± 0.76 slightly decreased to minimal L^* value

Table 2 Statistical correlation matrix of color properties with advance dry-aging.

Trait	Samples	Aging	L*(D65)	a*(D65)	b*(D65)	C*(D65)	h(D65)
Samples	1	0.989109	-0.435479	-0.649752	-0.653163	-0.66534	-0.36338
Aging		1	-0.396307	-0.644802	-0.639801	-0.657044	-0.340479
L*(D65)			1	0.588632	0.741479	0.665762	0.679673
a*(D65)				1	0.913198	0.985287	0.386172
b*(D65)					1	0.969383	0.725655
C*(D65)						1	0.53662
h(D65)							1

Table 3 Texture properties of raw rumpsteak (mean ±SD).

Samples	Razor Blade Shear Force (N)	Penetration Force (N)
0	5.91 ±2.51 ^c	2.47 ±0.93 ^a
2	2.22 ±0.90 ^a	1.82 ±0.69 ^a
3	2.95 ±1.68 ^{ab}	1.80 ±0.47 ^a
4	5.94 ±2.58 ^c	2.58 ±0.94 ^a
5	3.82 ±1.62 ^{ab}	2.42 ±1.15 ^a
6	3.02 ±1.63 ^{ab}	1.54 ±0.46 ^a
7	4.61 ±2.12 ^{bc}	3.86 ±2.15 ^b
8	2.07 ±0.45 ^a	1.92 ±0.55 ^a

a, b, c – means with different uppercase letters in column indicate a statistically significant difference ($p < 0.05$).

35.87 ±1.03 in seventh week of aging. And at the end of dry-aging in the eighth week L* value increased to 40.26 ±2.32. At the beginning and at the end of dry-aging there were investigated significant statistical correlation ($p < 0.05$) between samples and it correspondent their L* values 40.52 ±0.61, 40.26 ±2.32, respectively. The carried out results were confirmed by **Zakrys-Valiwander et al. (2011)**, who observed paramount statistical changes ($p < 0.05$) in value L* during fourteen days of aging of sirloin muscle beef steaks. On the other hand, **Colle et al. (2015)** observed no statistical differences across meat aging during 63 days in muscle beef *gluteus medius* and *longissimus lumborum*. During aging time, variably of lightness value L* increased and decreased; its changes may cause reallocated in the intracellular medium and the effects of the pigments concentration (**Farouk and Wieliczko, 2003; Aroeira et al., 2017**). Chromaticity value a* (indicating redness) displayed a negative significant ($p < 0.05$) correlation to weeks of dry-aging. There were observed three groups of redness value, significant ($p < 0.05$) statistical correlation were observed at samples at the beginning to fourth week of aging, except third week which was in between first and second

group of distribution of redness value a*. To the second group belonged next samples from fifth, sixth, and eighth week of ripening. In seventh week of dry-aging were determinated different values. There were lowest L* and different values a* and b* ($p < 0.05$) too. Both a* and b* values showed negative significant ($p < 0.05$) correlation in time of dry-aging (Table 2). The decreasing trends were observed in a* and b* from beginning of dry-aging till the third week and from the fourth till the seventh week ($p = 0.0000$, $r^2 = 0.4222$ and $p = 0.0000$, $r^2 = 0.4266$, respectively). The changing in values a* and b* corresponded to study of **Zakrys-Waliwander et al. (2011)** and **Colle et al. (2015)** what it contrary with result obtained by **Aroeira et al. (2017)** where a* and b* increased with time of aging.

The texture properties of dry-aging steaks measured by two methods are shown in Table 3. The Razor Blade Shear Force of rumpsteak ranged from 5.91 N (0 week of aging) to 2.07 N (8 week of aging). The penetration by ball-end probe ranged from 2.47 (0 week of aging) to 1.92 N (8 week of aging).

From the results of sensory analysis we can conclude, that the time of dry-aging had statistically significant

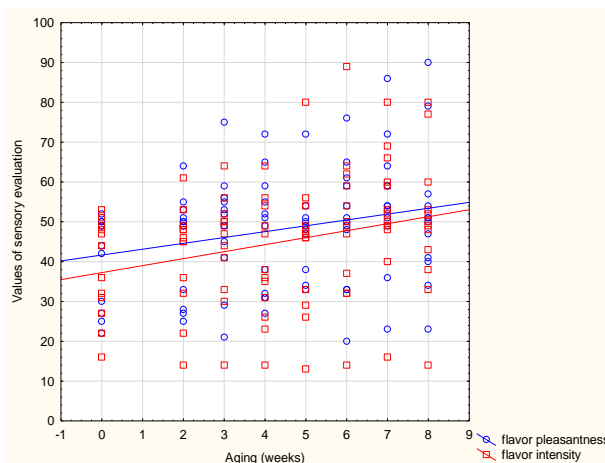

Figure 1 Linear regression plot of flavor pleasantness and flavor intensity.

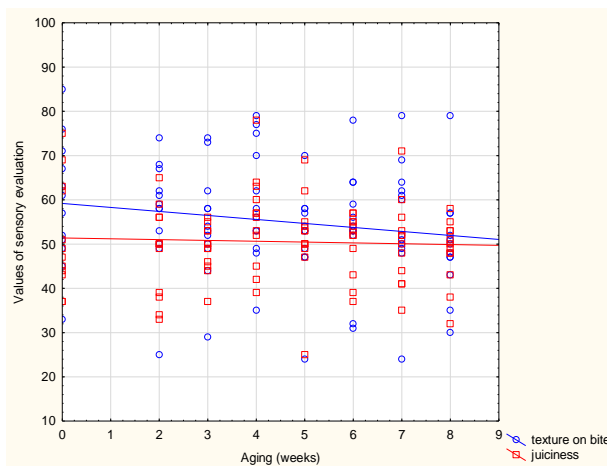

Figure 2 Linear regression plot of texture on bite and juiciness.

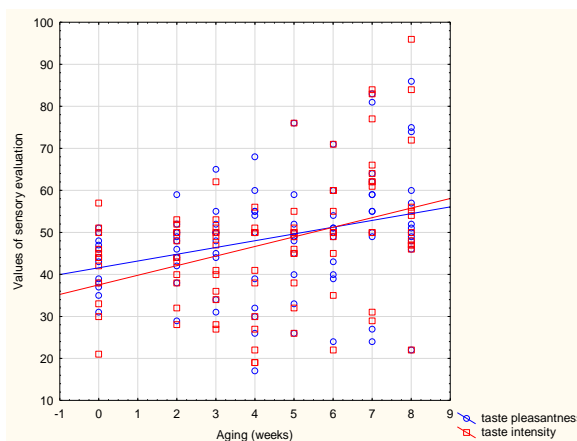

Figure 3 Linear regression plot of taste pleasantness and taste intensity.

effect ($p \leq 0.05$) for each monitored descriptors, except for the descriptor "texture in bite" (Table 4).

In the evaluation of flavor pleasantness it was created large homogenous group of six samples out of eight. A statistically significant difference was between the sample 0 and sample 7 (Tab. 2). From the results of linear regression ($p = 0.0133$; $r^2 = 0.0634$), we can conclude that the time of aging influence on pleasantness of flavor but on minimal range (6%). The assessors evaluated sample 7 as the best. Samples 0 and 2 were the worst.

The highest flavor intensity had sample no 7, after 7 weeks of dry-aging. The lowest intensity was registered at sample 0 and sample 4. Statistically significant differences were only between samples of ripening: samples 0 and 7 (Figure 1). There is dependence of the

dry-aging on the intensity of the flavor for 7 weeks with ($p = 0.0063$; $r^2 = 0.0768$).

As the softest sample in descriptor texture in bite it was four-week aging and as the hardest sample number 8. From linear regression is noticeable the effect the length of the ripening on texture in bite with descending process. It means, with the length of maturation is the steak tougher (the significance $p = 0.0842$; $r^2 = 0.0314$ is very low).

From the evaluation of juiciness there were no found statistically significant differences ($p \leq 0.05$). From the results of statistical evaluation we can detect zero impact on the length of the ripening on descriptor juiciness ($p = 0.6534$; $r^2 = 0.0022$). The highest juiciness was after 4 weeks of ripening (sample 4) and the lowest was after 8

Table 4 Determined values of the descriptors in the sensory evaluation and statistical evaluation (mean \pm SD).

Samples	Flavor pleasantness	Flavor intensity	Texture on bite	Juiciness	Taste pleasantness	Taste intensity
0	40.8 \pm 10.9 ^a	38.0 \pm 11.8 ^a	59.2 \pm 13.8 ^a	51.8 \pm 12.0 ^a	42.4 \pm 6.1 ^b	41.8 \pm 9.5 ^{a,b}
2	44.5 \pm 12.2 ^{a,b}	41.6 \pm 12.8 ^{a,b}	57.0 \pm 11.9 ^a	48.3 \pm 9.8 ^a	45.9 \pm 7.2 ^{a,b}	43.5 \pm 7.5 ^{a,b}
3	48.7 \pm 13.4 ^{a,b}	44.2 \pm 12.7 ^{a,b}	54.7 \pm 11.6 ^a	48.9 \pm 5.1 ^a	47.8 \pm 8.6 ^{a,b}	43.2 \pm 10.2 ^{a,b}
4	46.8 \pm 14.2 ^{a,b}	39.4 \pm 14.3 ^{a,b}	59.6 \pm 12.9 ^a	55.5 \pm 10.2 ^a	44.7 \pm 14.9 ^{a,b}	37.8 \pm 13.2 ^a
5	47.8 \pm 9.8 ^{a,b}	43.9 \pm 16.4 ^{a,b}	51.9 \pm 10.3 ^a	51.4 \pm 9.9 ^a	48.1 \pm 11.9 ^{a,b}	46.9 \pm 11.9 ^{a,b,c}
6	49.9 \pm 14.7 ^{a,b}	49.1 \pm 18.4 ^{a,b}	54.1 \pm 12.3 ^a	50.3 \pm 6.6 ^a	48.5 \pm 11.1 ^{a,b}	50.6 \pm 12.2 ^{b,c,d}
7	55.0 \pm 15.3 ^b	53.5 \pm 15.3 ^b	55.8 \pm 13.1 ^a	50.3 \pm 9.2 ^a	55.7 \pm 16.9 ^{a,b}	59.9 \pm 17.0 ^d
8	51.4 \pm 17.5 ^{a,b}	49.8 \pm 17.1 ^{a,b}	49.7 \pm 11.7 ^a	48.2 \pm 7.0 ^a	55.8 \pm 15.9 ^a	56.4 \pm 18.6 ^{c,d}

Note: ^{a, b, c, e} – means with different uppercase letters in column indicate a statistically significant difference ($p < 0.05$).

weeks of ripening (sample 8) (Figure 2).

The pleasantness of taste increased linearly with the time of aging ($p = 0.0021$; $r^2 = 0.0964$). There was also found a statistically significant difference between samples 0 and 8. The time of dry-aging affected pleasantness of taste of 10%. The best evaluated were samples 7 and 8 (the end of aging).

Another evaluated descriptors, which were influenced by the time of aging, was intensity of flavor. From the results of linear regression we can see a distinct increase in the intensity of taste with time of aging ($p = 0.00006$; $r^2 = 0.1582$) about 16%. The highest value was 7 weeks of aging (Figure 3).

Based on results of sensory analysis we can conclude, that as regards descriptors of aroma and taste, the sample 7 (7 weeks of aging) was the best and in terms of juiciness and texture the best one was evaluated the sample no 4 (4 weeks of aging).

Warren and Kastner (1992) found more intensified flavor characteristics such as beefier and more brown/roasted flavor by dry-aged beef samples compared to wet-aged or unaged beef. However, several other studies found no significant dry-aging impacts on palatability components of beef (**Laster et al., 2008**; **Smith et al., 2008**; **Dikeman et al., 2013**). There have been reports of the improvement of meat quality during long-term wet or dry aging. **Campbell et al. (2001)** reported that the tenderness, flavor intensity, and juiciness of lean beef stored for 16 or 21 days by dry aging were higher than those of beef stored for a few days. The softness of lean beef has been improved by wet aging for 28 days (**Dixon et al., 2012**). **Nishimura et al. (1988)** reported that the intramuscular connective tissue content decreases progressively by 28 days after slaughter. Furthermore, **Yanagihara et al. (1995)** showed in meat from Holsteins that qualities such as taste and tenderness improved during postmortem aging for 32 to 56 days; the taste worsened with further aging. Despite these studies, there are still few reports on quality improvement of highly marbled beef during aging. It is well known that beef should be generally stored for about 2 to 3 weeks at 2 to 4 °C to improve its tenderness and flavor after the post-slaughter rigor mortis has subsided (**Nishimura et al., 1988**; **Shimada et al., 1992**; **Campbell et al., 2001**; **Dixon et al., 2012**). However, highly marbled beef is sometimes stored longer, under specific regulated conditions, than conventional beef. For example, one brand of marbled beef, Tajima beef, is conditioned for several weeks at about 1 °C and 80% humidity, with an air stream over meat surface. Such regulated conditioning improves the quality of this highly marbled beef.

CONCLUSION

The best evaluation had the samples after 4 weeks of ripening when consumer prefers better textural properties instead significant taste attributes. The similar evaluation had the samples after 7 weeks of dry-aging. Significant changes in the values of $L^*a^*b^*$ were observed in seven week dry aging. After this time there are significant color appearance, flavor, and taste properties instead worse texture evaluation.

REFERENCES

- AMSA, 2012. Meat Color Measurement Guidelines. American Meat Science Association. Champaign, Illinois USA. [online] s.a. [cit.2017-01-28] Available at: <http://www.meatscience.org/publications-resources/printed-publications/amsa-meat-color-measurement-guidelines>.
- Aroeira, C. N., Filho, R. A. T., Fontes, P. R., Ramos, A. L. S., Gomide, L. A. M., Ladeira M. M., Ramos, E. M. 2017. Effect of freezing prior to aging on myoglobin redox forms and CIE color of beef from Nellore and Aberdeen Angus cattle. *Meat Science*, vol. 125, p. 16-21. <https://doi.org/10.1016/j.meatsci.2016.11.010>
- Campbell, R. E., Hunt, M. C., Levis, P., Chambers IV, E. 2001. Dry-aging effects on palatability of beef longissimus muscle. *Journal of Food Science*, vol. 66, no. 2, p. 196-199. <https://doi.org/10.1111/j.1365-2621.2001.tb11315.x>
- Cavitt, L. C., Meullenet, J. F., Xiong, R., Owens, C. M. 2005. The relationship of razor blade shear, Allo-Kramer shear, Warner-Bratzler shear and sensory tests to changes in tenderness of broiler breast fillets. *Journal of Muscle Foods*, vol. 16, no. 3, p. 223-242. <https://doi.org/10.1111/j.1745-4573.2005.00001.x>
- Colle, M. J., Richard, R. P., Killinger, K. M., Bohlscheid, J. C., Gray, A. R., Loucks, W. I., Day, R., N., Cochran, A. S., Nasados, J. A., Doumit, M. E. 2015. Influence of extended aging on beef quality characteristics and sensory perception of steaks from the gluteus medius and longissimus lumborum. *Meat Science*, vol. 110, p. 32-39. <https://doi.org/10.1016/j.meatsci.2015.06.013> PMID:26172241
- Dikeman, M. E., Obuz, E., Gök, V., Akkaya, L., Stroda, S. 2013. Effects of dry, vacuum, and special bag aging; USDA quality grade; and end-point temperature on yields and eating quality of beef Longissimus lumborum steaks. *Meat Science*, vol. 94, no. 2, p. 228-233. <https://doi.org/10.1016/j.meatsci.2013.02.002> PMID:23501255
- Dixon, C. L., Woerner, D. R., Tokach, R. J., Chapman, P. L., Engle, T., E., Tatum, J., D., Belk, K. E. 2012. Quantifying the aging response and nutrient composition for muscle of the beef round. *Journal of Animal Science*, vol. 90, no. 3, p. 996-1007. <https://doi.org/10.2527/jas.2011-4415> PMID:21984719
- Farouk, M. M., Wieliczko K. J. 2003. Effect of diet and fat content on the functional properties of thawed beef. *Meat Science*, vol. 64, no. 4, p. 451-458. [https://doi.org/10.1016/S0309-1740\(02\)00214-0](https://doi.org/10.1016/S0309-1740(02)00214-0)
- Huff-Lonergan, E., Lonergan, S. M. 2005. Mechanisms of water-holding capacity of meat: The role of postmortem biochemical and structural changes. *Meat Science*, vol. 71, no. 1, p. 194-204. <https://doi.org/10.1016/j.meatsci.2005.04.022> PMID:22064064
- Kemp, C. M., Sensky, P. L., Bardsley, R. G., Buttery, P. J., Parr, T. 2010. Tenderness – An enzymatic view. *Meat Science*, vol. 84, no. 2, p. 248-256. <https://doi.org/10.1016/j.meatsci.2009.06.008> PMID:20374783
- Kim, Y. H. B., Kemp, R., Samuelsson, L. M. 2016. Effects of dry-aging on meat quality attributes and metabolite profiles of beef loins. *Meat Science*, vol. 111, p. 168-176. <https://doi.org/10.1016/j.meatsci.2015.09.008> PMID:26437054
- Kim, Y. H. B., Meyers, K. B., Kim, H. W., Liceaga, A. M., Lemenager, R. P. 2017. Effects of stepwise dry/wet-aging and freezing on meat quality of beef loins. *Meat Science*, vol.

123, p. 57-63. <https://doi.org/10.1016/j.meatsci.2016.09.002>
[PMid:27627781](https://pubmed.ncbi.nlm.nih.gov/27627781/)

Kim, Y. H. B., Warner, R. D., Rosenwold, K. 2014. Influence of high pre-rigor temperature and fast pH fall on muscle proteins and meat quality: a review. *Animal Production Science*, vol. 54, p. 375-395. <https://doi.org/10.1071/AN13329>

Kristensen, L., Purslow, P. P. 2001. The effect of ageing on the water-holding capacity of pork: Role of cytoskeletal proteins. *Meat Science*, vol. 58, no. 1, p. 17-23. [https://doi.org/10.1016/S0309-1740\(00\)00125-X](https://doi.org/10.1016/S0309-1740(00)00125-X)

Laster, M. A., Smith, R. D., Nicholson, K. L., Nicholson, J. D. W., Miller, R. K., Griffin, D. B., Savell, J. W. 2008. Dry versus wet aging of beef: Retail cutting yields and consumer sensory attribute evaluations of steaks from ribeyes, strip loins, and top sirloins from two quality grade groups. *Meat Science*, vol. 80, no. 3, p. 795-804. <https://doi.org/10.1016/j.meatsci.2008.03.024>
[PMid:22063599](https://pubmed.ncbi.nlm.nih.gov/22063599/)

Mancini, R. A., Hunt, M. C. 2005. Current research in meat color. *Meat Science*, vol. 71, no. 1, p. 100-121. <https://doi.org/10.1016/j.meatsci.2005.03.003>
[PMid:22064056](https://pubmed.ncbi.nlm.nih.gov/22064056/)

Meullenet, J. F., Jonville, E., Grezes, D., Owens, C. M. 2004. Prediction of the texture of cooked poultry pectoralis major muscles by near-infrared reflectance analysis of raw meat. *Journal of Texture Studies*, vol. 35, no. 6, p. 573-585. <https://doi.org/10.1111/j.1745-4603.2004.35510.x>

Nishimura, T., Rhue, M. R., Okitani, A., Kato, H. 1988. Components contributing to the improvement of meat taste during storage. *Agricultural and Biological Chemistry*, vol. 52, no. 9, p. 2323-2330.

Savell, J. W. 2008. Dry-aging of beef. Executive summary, National Cattlemen's Beef Association, Centennial, CO. [online] s.a. [cit.2017-01-28] Available at: <http://www.beefresearch.org/CMDocs/BeefResearch/Dry%20Aging%20of%20Beef.pdf>.

Shimada, A., Watanuki, M., Tanisawa, Y., Hata, K. 1992. Changes in the taste of beef with aging. *Journal of Home Economics Japan*, vol. 43, p. 199-206.

Smith, R. D., Nicholson, K. L., Nicholson, J. D. W., Harris, K. B., Miller, R. K., Griffin, D. B., Savell, J. W. 2008. Dry versus wet aging of beef: Retail cutting yields and consumer palatability evaluations of steaks from US Choice and US Select short loins. *Meat Science*, vol. 79, no. 4, p. 631-639. <https://doi.org/10.1016/j.meatsci.2007.10.028>
[PMid:22063024](https://pubmed.ncbi.nlm.nih.gov/22063024/)

Suman, S. P., Hunt, M. C., Naira, M. N., Rentfrow, G. 2014. Improving beef color stability: Practical strategies and underlying mechanisms. *Meat Science*, vol. 98, no. 3, p. 490-504. <https://doi.org/10.1016/j.meatsci.2014.06.032>
[PMid:25041654](https://pubmed.ncbi.nlm.nih.gov/25041654/)

Sýkora, V., Šulcerová, H., Mihok, M., Pytel, R. 2016. Influence of type and shelf-life on two brands complementary food in color, vitamins, and sensory evaluation. *Potravinarstvo*, vol. 10, no. 1, p. 265-271. <https://doi.org/10.5219/618>

Tapp, W. H., Yancey, Y. W. S., Apple, J. K. 2011. How is the instrumental color of meat measured? *Meat Science*, vol. 89, no. 1, p. 1-5. <https://doi.org/10.1016/j.meatsci.2010.11.021>
[PMid:2154616](https://pubmed.ncbi.nlm.nih.gov/2154616/)

Warren, K. E., Kastner, C. L. 1992. A comparison of dry-aged and vacuum-aged beef strip loins. *Journal of Muscle Foods*, vol. 3, no. 2, p. 151-157. <https://doi.org/10.1111/j.1745-4573.1992.tb00471.x>

Yanagihara, K., Yano, Y., Nakamura, T., Nakai H. Tanabe, R. 1995. Changes in sensory, physical and chemical properties of beef loins during prolonged conditioning at chilled temperature. *Japanese Animal Science and Technology*, vol. 66, no. 2, p. 160-168. <https://doi.org/10.2508/chikusan.66.160>

Zakrys-Waliwander, P. I., O'Sullivan, M. G., Walsh, H., Allen, P., Kerry, J. P. 2011. Sensory comparison of commercial low and high oxygen modified atmosphere packed sirloin beef steaks. *Meat Science*, vol. 88, no. 1, p. 198-202. <https://doi.org/10.1016/j.meatsci.2010.12.027>
[PMid:21237577](https://pubmed.ncbi.nlm.nih.gov/21237577/)

Acknowledgments:

The results and outcomes were prepared using instrumentation funded from the Research and Development for Innovations Operational Programme, project CZ.1.05/4.1.00/04.0135 Teaching and Research Facilities for Biotechnological Disciplines and Extension of Infrastructure.

Contact address:

Ing. Hana Šulcerová, Ph.D., Mendel University in Brno, Faculty of AgriSciences, Department of Food Technology, Zemědělská 1, 613 00 Brno, Czech Republic, E-mail: hana.sulcerova@mendelu.cz

Mgr. Ing. Vladimír Sýkora, Mendel University in Brno, Faculty of AgriSciences, Department of Food Technology, Zemědělská 1, 613 00 Brno, Czech Republic, E-mail: vladimir.sykora@mendelu.cz

doc. Ing. Šárka Nedomová, Ph.D., Mendel University in Brno, Faculty of AgriSciences, Department of Food Technology, Zemědělská 1, 613 00 Brno, Czech Republic, E-mail: snedomov@mendelu.cz

Ing. Michal Mihok, Ph.D., Mikrofarma, s.r.o., Udolní 567/33, 602 00 Brno, Czech Republic, E-mail: michal.mihok@mikrofarma.cz



SOMATIC CELL COUNT IN MILK OF INDIVIDUAL LACAUNE EWES UNDER PRACTICAL CONDITIONS IN SLOVAKIA: POSSIBLE EFFECT ON MILK YIELD AND ITS COMPOSITION

Vladimír Tančín, Michal Uhrinčat', Lucia Mačuhová, Štefan Baranovič, Martina Vršková

ABSTRACT

The aim of this study was to describe the health status of udder through analysis of somatic cell count (SCC) in milk of Lacaune breed. The study was conducted at five Slovak farms. Milk yield recordings and milk samples were taken from March till August by certificated organisation for milk recording, where also milk analysis on SCC was processed. In total 1192 samples were analysed. Milk samples were divided into the five categories on the basis of SCC: $SCC < 0.2 \times 10^6$, between $0.2 - 0.4 \times 10^6$, $0.4 - 0.6 \times 10^6$, $0.6 - 1 \times 10^6$ and $> 10^6$ cells.mL⁻¹. Animals were divided into seven stages of lactation (first: 30-60 days of lactation and then each following 30 days a further group of lactation stage was considered). The Mixed model with Scheffe's analysis as a post hoc test was used. SCC on farm 3 was highest (5.80 ± 0.04 log SCC mL⁻¹) as compared with others farms ($p < 0.05$). Significant effect of farms on milk yield demonstrates different level of farm management. Between farm 1 and 3 the differences in milk yield per milking is more than double. Frequency of distribution of milk samples was 53.36%, 13.93%, 6.29%, 7.21% and 19.21% for different categories respectively. In category $> 10^6$ cells.mL⁻¹ the highest percentage was on farm 4 (33.57%) and lowest on farm 2 (8.06%) though more representative percentage was on farm 5 (12.05%) due to larger number of animals. The negative effect of high SCC on milk yield was observed in all farms. Data also revealed that main part of individual milk samples had SCC below 0.6×10^6 cells.mL⁻¹ which could be an important argument for future legislative establishment of limits for SCC in ewe's milk.

Keywords: Lacaune; somatic cell counts; milk yield

INTRODUCTION

Sheep milk production is currently the main breeding aim of many agricultural farms and privately-employed farmers in many countries. Milk plays thus a crucial role in the economy of cooperatives and farms. In Slovakia there is effort to increase the milk production by the importing dairy breeds especially Lacaune or use them to improve milk yield of traditionally bred sheep. Increasing of milk yield could be potential a risk for udder health especially if high producing breed is bred in less breeding systems. Recently on the basis of somatic cell counts in milk we showed higher percentage of health problems of udder in Lacaune or its crossing with Tsigai and Improved Valachian as compared with pure mentioned ones raised under to same conditions (Idriss et al., 2015).

At present the somatic cell count (SCC) is considered to be a basis for abnormal milk control programs for cows, goats and sheep (Bergonier-Berthelot, 2003; Zajac et al., 2016). Higher number of SCC reduced milk production and negatively affects other variables (lactose) and positive fat and protein contents (Olechnowicz et al.,

2009; Rupp et al., 2003). In spite of negative effect of SCC on milk production, in dairy ewes there is not legislative duty to analyse raw milk of ewes for SCC for the market purposes as it is in dairy cow well established. The trade with milk and milk product could be thus possible influenced by milk quality related to consumers' demands (Kubicová and Dobák, 2012).

Individual SCC (SCC) is a useful predictor of infected gland, though there is no accepted threshold that can permit to differentiate between "healthy" and "infected" udders in dairy ewes (Berthelot et al., 2006). Last mentioned authors reported the udder as healthy if individual SCC is lower than 0.5×10^6 cells.mL⁻¹, and infected if at least two individual SCC were higher than 1 or 1.2×10^6 cells.mL⁻¹, while at the flock level, if SCC exceeded 0.65×10^6 cells.mL⁻¹, they indicated up to 15% occurrence of mastitis. Recently in Tsigai ewes under practical conditions only 13% of ewes had over 0.6×10^6 cells.mL⁻¹ (Vršková et al., 2015). In another study with uninfected Valle del Belice ewes, 83.7% of the milk samples were below 0.5×10^6 cells.mL⁻¹ and only 2.6%

samples had SCC above 1×10^6 cells.mL⁻¹ (Riggio et al., 2013). On the base of field study the Pengov (2001) considered the threshold of 0.25×10^6 cells.mL⁻¹ beyond the assessment of udder health of ewes.

Increasing numbers of Lacaune in dairy practice is a good way for farmer to increase the milk production but on the other side it is important to evaluate the efficiency of implementation of this breed into dairy practice. One of the most important information is udder health. The hypothesis of the work was that SCC negatively influences milk yield and its composition. Further hypothesis was that SCC differs among farms. Therefore the aim of the study was to describe the actual health status of udder through analysis of milk on SCC in Lacaune under practical conditions and possible effect on milk yield and its composition.

MATERIAL AND METHODOLOGY

The study was performed in five ewes dairy farms in Slovakia in 2016. In all farms there was only Lacaune breed in their first to fourth lactations. Animals were machine milked two times a day. Because of missing values of age the parity effect was not studied. Before weaning the lambs, the ewes were fed in stable with hay and grass or alfalfa/clover silage. At the end of April and beginning on May the animals were on pasture additionally fed with concentrate intake in parlour during milking.

Milk yield recording and milk samples were taken during the period from March till August depending on the selected farm by certificated organisation for milk recording (Plemenárske služby, š. p. SR Bratislava). In Table 1 there are numbers of milk samples from different farms and period of sampling. In total 1192 samples were collected and analysed. Milk samples from each udder were transported to the certificated Central laboratory of Plemenárske služby š.p. Bratislava for milk analysis on SCC and milk composition (fat, protein, lactose).

Statistical methods

For statistical evaluation the ewes were divided into the five groups on the basis of their individual SCC in milk:

SCC < 0.2×10^6 cells.mL⁻¹, SCC between $0.2 - 0.4 \times 10^6$ cells.mL⁻¹, SCC between $0.4 - 0.6 \times 10^6$ cells.mL⁻¹, SCC between $0.6 - 1 \times 10^6$ cells.mL⁻¹, SCC > 10^6 cells.mL⁻¹. Also the effect of farms was involved into statistical evaluation (FARM). On the basis of date of lambing there was a possibility to divided animals into seven stages of lactation (first: 30-60 days of lactation and then each following 30 days a further group of lactation stage was considered) (STAGE).The statistical model using SAS (Mixed procedure; SAS/STAT 9.1, 2002-2003). can be written in the following form (1):

(1)

$$y_{ijkl} = \mu + FARM_i + HEALTH (FARM)_j + STAGE_k + u_l + e_{ijkl},$$

where y_{ijkl} = the measurements for milk yield, fat, protein, lactose and logSCC; μ = overall mean; $FARM_i$ = the fixed effects of five farms; $HEALTH (FARM)_j$ = fixed effect of health (five SCC categories) within five farms; $STAGE_k$ = fixed effect of stage of lactation (seven stages of lactation); u_l = random effect of ewe, $u_l \sim N(0, \sigma_e^2)$ and e_{ijkl} = random error, assuming $e_{ijkl} \sim N(0, I \sigma_e^2)$. Data are presented as LSmeans (Least squares means) ± standard error per milking.

RESULTS AND DISCUSSION

Basic statistic data of measured parameters were: milk yield 856 ±11.76 mL, fat 6.41 ±0.05%, protein 5.96 ±0.02%, lactose 4.62 ±0.01% and logx SCC 4.4 ±0.01 cells.mL⁻¹. The effect of farm on milk yield and its composition are presented in Table 2. LS Means of all parameters significantly were different among farms. The highest milk yield was found out on third farm (900.09 ±22.73 mL) and lowest on farm first (439.92 ±41.05 mL, $p < 0.05$). The fat content was significantly lowest on farm second (4.69 ±0.19%) as compared with others farms ($p < 0.05$). Significantly highest content of proteins was measured on fourth farm (6.44 ±0.07%) as compared with others farms ($p < 0.05$). Lactose content, though significant among farms, was numerically similar. On third farm there was highest SCC (5.80 ±0.04 logSCC mL⁻¹) as compared with others farms

Table 1 Numbers of experimental ewes on farms in each month.

	March	April	May	June	July	August	Total
First		13	26	31	31	31	132
Second			62				62
Third	42	57	59	62		63	283
Fourth		33	32	30	31		126
Fifth			261			328	589
Total	42	103	440	123	62	422	1192

Table 2. The effect of farm on milk yield and its composition and on somatic cell counts.

Farm	Milk yield		Milk composition (%)				logSCC			
	mL		Fat		Protein		Lactose		cells.mL ⁻¹	
	LS means	Std. Error	LS means	Std. Error	LS means	Std. Error	LS means	Std. Error	LS means	Std. Error
First	439.92 ^a	41.05	6.77 ^a	0.16	5.83 ^a	0.08	4.51 ^{ab}	0.04	5.50 ^a	0.06
second	565.97 ^a	50.15	4.69 ^b	0.19	5.92 ^a	0.09	4.61	0.04	5.39 ^{ad}	0.09
Third	900.09 ^b	22.73	6.41 ^a	0.09	6.00 ^a	0.04	4.64 ^c	0.02	5.80 ^c	0.04
Fourth	787.54 ^{bc}	37.44	6.87 ^{ac}	0.14	6.44 ^b	0.07	4.65	0.03	5.64 ^{bd}	0.06
Fifth	767.57 ^c	25.28	6.84 ^c	0.10	6.05 ^a	0.05	4.52 ^b	0.02	5.27 ^{cd}	0.04

Note: ^{a,b,c} LS Means in the same column with different letters are different ($p < 0.05$).

Table 3 The effect of somatic cell counts on milk yield and its composition within different farms.

Farm		SCC categories, x.10 ³ cells.mL ⁻¹									
		<200	200 – 400	400 – 600	600 – 1000	>1000					
First	Milk yield (mL)	543.53	42.30	465.33	69.96	430.52	119.66	396.05	364.16	65.28	
	Fat (%)	6.36	0.16	7.26	0.27	6.79	0.46	6.81	0.46	6.60	0.25
	Protein (%)	5.56	0.05	5.77	0.13	5.84	0.22	6.15	0.22	5.94	0.12
	Lactose (%)	4.60	0.04	4.55	0.06	4.62	0.10	4.52	0.10	4.29	0.06
Second	Milk yield (mL)	863.70	58.92	476.71	101.03	597.65	112.34	628.99	112.97	262.80	141.57
	Fat (%)	3.90	0.23	4.72	0.39	4.73	0.43	4.98	0.43	5.12	0.54
	Protein (%)	5.81	0.11	5.94	0.19	5.73	0.22	5.94	0.21	6.17	0.26
	Lactose (%)	4.86	0.05	4.71	0.09	4.68	0.10	4.51	0.10	4.27	0.12
Third	Milk yield (mL)	1030.02	32.68	855.30	45.94	843.72	71.39	875.93	56.96	895.99	31.46
	Fat (%)	5.93	0.13	6.62	0.18	6.67	0.27	6.23	0.22	6.58	0.12
	Protein (%)	5.86	0.06	6.4	0.08	6.09	0.13	6.06	0.10	5.99	0.06
	Lactose (%)	4.82 ^a	0.03	4.71	0.04	4.66	0.06	4.62	0.05	4.41 ^b	0.03
Fourth	Milk yield (mL)	817.56	48.24	887.16	68.08	692.18	91.93	794.52	112.26	746.27	63.12
	Fat (%)	6.65	0.19	6.81	0.26	7.19	0.35	6.47	0.43	7.26	0.24
	Protein (%)	6.14	0.09	6.38	0.13	6.68	0.17	6.26	0.21	6.72	0.12
	Lactose (%)	4.62	0.05	4.65	0.06	4.62	0.08	4.75	0.10	4.59	0.05
Fifth	Milk yield (mL)	852.24	21.57	795.92	44.08	809.40	64.64	754.33	59.13	625.96	42.40
	Fat (%)	6.62	0.08	6.71	0.17	6.90	0.25	7.4	0.23	6.90	0.16
	Protein (%)	5.96	0.04	5.92	0.08	6.09	0.12	6.10	0.11	6.17	0.08
	Lactose (%)	4.62	0.02	4.56	0.04	4.45	0.06	4.55	0.05	4.43	0.04

Note: ^{a,b} LS means in the same line with different letters are different ($p < 0.05$).

Table 4 The effect of stage of lactation on milk yield, milk composition and SCC.

Stage of lactation	Milk yield mL	Milk composition (%)						SCC cells.mL ⁻¹		
		Fat	Protein	Lactose	SCC	SCC				
30 – 60 days	962.09 ^a	49.33	5.28 ^a	0.18	5.25 ^a	0.09	4.87 ^a	0.04	5.51	0.10
60 – 90 days	1038.39 ^a	21.2	5.12 ^a	0.08	5.44 ^a	0.04	4.78 ^{ac}	0.02	5.54	0.04
90 – 120 days	844.82 ^b	27.53	5.81 ^c	0.11	5.72 ^b	0.05	4.69 ^{bc}	0.02	5.47	0.05
120 – 150 days	637.08 ^d	31.34	6.52 ^d	0.12	6.00 ^c	0.06	4.57 ^d	0.03	5.44	0.06
150 – 180 days	524.37 ^c	23.63	7.35 ^b	0.09	6.59 ^d	0.04	4.43 ^{ef}	0.02	5.46	0.05
180 – 210 days	460.41 ^{cd}	42.29	6.83 ^{bd}	0.16	6.60 ^d	0.08	4.49 ^{df}	0.04	5.56	0.08
>210 days	378.36 ^d	54.98	7.3 ^{bd}	0.21	6.63 ^d	0.10	4.27 ^e	0.05	5.66	0.11

Note: ^{a,b,c,d,e,f} LS means in the same column with different letters are different ($p < 0.05$).

($p < 0.05$). Significant effect of farms on milk yield demonstrates different level of farm management. Between first and third farm the differences in milk yield per milking is more than double. In our previous studies (Mačuhová et al. 2012; Tančin et al. 2011) the milk yield of LC was comparable to first or second farm. Oravcova et al. (2006) published from data obtained in our practical conditions daily milk yield 1.053 ± 0.475 kg in Lacaune breed. Fat content in milk with exception of second farm (unusually very low) and protein content were similar to data published by Rovai et al. (2015). In another study of Oravcova et al. (2007) $6.97 \pm 1.514\%$ fat and $5.62 \pm 0.692\%$ protein for Lacaune was found out.

The effect of SCC on milk yield and its composition within each involved farm is presented in Table 3. The numerically negative effect of high SCC on milk yield was observed almost in all farms. Especially in the farm third and fourth, with higher number of animals, there was seen high numerical decrease of milk yield between group SCC $< 0.2 \times 10^6$ cells.mL⁻¹ and SCC $> 10^6$ cells.mL⁻¹. We found out also numerical reduction of milk production in ewes with high SCC (Vršková et al., 2015), though it is shown on large number of ewes the significant reduction of milk yield with high SCC in milk was found out in Manchega ewes (Adrias et al., 2012), in Churra ewes (Gonzalo et al., 2002) and in line 05 dairy ewes

Table 5 Frequency of distribution (%) of milk samples in different SCC categories.

Farm	Somatic cell counts, categories x.10 ³ cells.mL ⁻¹				
	<200	200 – 400	400 – 600	600 – 1000	>1000
First	47.73	18.18	5.30	6.06	22.73
Second	50.00	16.13	12.90	12.90	8.06
Third	32.86	15.90	7.07	10.60	33.57
Fourth	39.68	20.63	11.11	6.35	22.22
Fifth	67.74	10.36	4.41	5.43	12.05
Total	53.36	13.93	6.29	7.21	19.21

Note: ^{a,b,c} LS Means in the same column with different letters are different ($p < 0.05$).

(Olechnowicz et al., 2009). Significant negative effect of high SCC on lactose content was calculated only in fourth farm though the lactose content numerically decreased in all farms with increasing SCC. SCC did not influence protein and fat content as published by Rovai et al. (2015). In our study with Tsigai ewes (Vršková et al., 2015) and in other work (Olechnowicz et al., 2009) there was found out significant increase of fat, protein and lactose content with increasing SCC in milk. Though not significant in this study we also confirm the decrease of lactose with high SCC in milk.

The stage of lactation significantly influenced all parameters except SCC (Table 4). Milk yield, fat and protein content affected by stage of lactation are in agreement with data Oravcova et al. (2006, 2007, 2015). Though not significant effect of stage of lactation ($p < 0.065$) we found out the highest values at the beginning and at the end of lactation indicating the most critical periods for udder health. In healthy ewes Arias et al. (2012) found significant increase of SCC during lactation but if they analysed the data in ewes with high SCC at beginning of lactation the SCC during lactation decreased.

Frequency of distribution of individual milk samples in different SCC categories is presented in Table 5. In the SCC category below 0.2×10^6 cells.mL⁻¹ was categorised 53.36 % of individual samples and in category over 10^6 cells.mL⁻¹ were almost 19.21% samples. In both mentioned categories there was seen clear effect of farm. The highest percentage of samples in SCC category below 0.2×10^6 cells.mL⁻¹ was found out in fifth farm (67.74%) and lowest on fourth farm (32.86%). In category over 10^6 cells.mL⁻¹ the highest percentage on fourth farm (33.57%) and lowest on second farm (8.06%) though more representative low percentage was on fifth farm (12.05%) due to larger number of animals (Table 1). In our study with different breeds the LC had lowest percentage of samples in low SCC categories and was similar to fourth farm (Idriss et al., 2015). Very high difference in the milk samples distribution in SCC categories indicates different level of effective breeding of LC breed under Slovakian practical conditions. Another factors negatively influence SCC in milk is high milk production (Tančin et al., 2016) as see in Table 5 at third farm. Therefore farmers aiming the increase milk yield should beware of possible increase of risk for mastitis. On the other side the percentage of samples in the category over 10^6 cells.mL⁻¹ is relative low (except farm third) which indicate that high SCC in ewe's milk is not probably physiological trait and deserve more attention to preventive mastitis programs implemented in dairy sheep practice. Therefore more study is needed to find out relationship between high SCC in milk and presence of microorganisms in udder.

CONCLUSION

The results of this study indicated that the SCC of individual milk samples could be important factor contributing to more effective management of the breeding systems. Data also revealed that main part of individual milk samples had SCC below 0.6×10^6 cells.mL⁻¹ which could be an important argument for future legislative establishment of limits for SCC in ewe's milk.

REFERENCES

- Arias, R., Oliete, B., Ramon, M., Arias, C., Gallego, R., Montoro, V., Gonzalo, C., Perez-Guzman, M. D. 2012. Long-term study of environmental effects on test-day somatic cell count and milk yield in Manchega sheep. *Small Ruminant Research*, vol. 106, no. 2-3, p. 92-97. <https://doi.org/10.1016/j.smallrumres.2012.03.019>
- Bergonier, D., De Cremoux, R., Rupp, R., Lagriffoul, G., Berthelot, X. 2003. Mastitis in dairy small ruminants. *Veterinary Research*, vol. 34, no. 5, p. 689-716. <https://doi.org/10.1051/vetres:2003030>
- Berthelot, X., Lagriffoul, G., Concorde, D., Barillet, F., Bergonier, D. 2006. Physiological and pathological thresholds of somatic cell counts in ewe milk. *Small Ruminant Research*, vol. 62, no. 1-2, p. 27-31. <https://doi.org/10.1016/j.smallrumres.2005.07.047>
- Gonzalo, C., Ariznabarreta, A., Carriedo, J. A., San Primitivo, F. 2002. Mammary pathogens and their relationship to somatic cell count and milk yield losses in dairy ewes. *Journal of Dairy Science*, vol. 85, no. 6, p. 1460-1467. [https://doi.org/10.3168/jds.S0022-0302\(02\)74214-8](https://doi.org/10.3168/jds.S0022-0302(02)74214-8)
- Idriss, Sh. E., Tančin, V., Margetín, M., Tančinová, D., Sláma, P., Havlíček, Z. 2015. The frequency of distribution of somatic cell count in dairy ewe's milk. *Journal of Microbiology, Biotechnology and Food Science*, vol. 4, special no. 3, p. 148-151.
- Kubicová, E., Dobák, D. 2012. The development and the level of milk consumption and milk product in SR and modeling of food demand of selected groups of households : monograph. Nitra : SPU, p. 88.
- Mačuhová, L., Tančin, V., Uhrinčať, M., Mačuhová, J. 2012. The level of udder emptying and milk flow stability in Tsigai, Improved Valachian, and Lacaune ewes during machine milking. *Czech Journal of Animal Science*, vol. 57, no. 5, p. 240-247.
- Olechnowicz, J., Jaśkowski, J. M., Antosik, P., Bukowska, D. 2009. Milk yield and composition in line 05 dairy ewes as related to somatic cell counts. *Journal of Animal and Feed Sciences*, vol. 18, no. 3, p. 420-428. <https://doi.org/10.22358/jafs/66417/2009>
- Oravcová, M., Margetín, M., Peškovičová, D., Daňo, J., Milerski, M., Hetény, L., Polák, P. 2006. Factors affecting milk yield and ewe's lactation curves estimated with test-day models. *Czech Journal of Animal Science*, vol. 51, no. 11, p. 483-490.
- Oravcová, M., Margetín, M., Peškovičová, D., Daňo, J., Milerski, M., Hetény, L., Polák, P. 2007. Factors affecting ewe's milk fat and protein content and relationships between milk yield and milk components. *Czech Journal of Animal Science*, vol. 52, no. 7, p. 189-198.
- Oravcová, M., Margetín, M., Tančin, V. 2015. The effect of stage of lactation on daily milk yield, and milk fat and protein content in Tsigai and Improved Valachian ewes. *Mljekarstvo*, vol. 65, no. 1, p. 48-56. <https://doi.org/10.15567/mljekarstvo.2015.0107>
- Pengov, A. 2001. The role of coagulase-negative *Staphylococcus* spp. and associated somatic cell count in the ovine mammary gland. *Journal of Dairy Science*, vol. 84, no. 3, p. 572-574. [https://doi.org/10.3168/jds.S0022-0302\(01\)74509-2](https://doi.org/10.3168/jds.S0022-0302(01)74509-2)
- Riggio, V., Pesce, L. L., Morreale, S., Portolano, B. 2013. Receiver-operating characteristic curves for somatic cell scores and California mastitis test in Valle del Belice dairy sheep. *The Veterinary Journal*, vol. 196, no. 3, p. 528-532. <https://doi.org/10.1016/j.tvjl.2012.11.010>

Rovai, M., Rusek, N., Caja, G., Saldo, J., Leitner, G. 2015. Effect of subclinical intramammary infection on milk quality in dairy sheep: I. Fresh-soft cheese produced from milk of uninfected and infected glands and from their blends. *Small Ruminant Research*, vol. 125, p. 127 to 136.

Rupp, R., Foucras, G. 2010. Genetics of Mastitis in Dairy Ruminants. In: Bishop, S. C., et al. *Breeding for Disease Resistance in Farm Animals*. 3rd ed. Midlothian, UK : University of Edinburgh, 368 p.
<https://doi.org/10.1079/9781845935559.0183>

Tančin, V., Bauer, M., Holko, I., Baranovič, Š. 2016. Etiology of mastitis in ewes and possible genetic and epigenetic factors involved. *Slovak Journal of Animal Science*, vol. 49, no. 2, p. 85-93.

Tančin, V., Mačuhová, L., Oravcová, M., Uhrinčať, M., Kulinová, K., Roychoudhury, S., Marnet P. G. 2011. Milkability assessment of Tsigai, Improved Valachian, Lacaune and F1 Crossbred ewes (Tsigai×Lacaune, Improved Valachian×Lacaune) throughout lactation. *Small Ruminant Research*, vol. 97, no. 1-3, p. 28-33.
<https://doi.org/10.1016/j.smallrumres.2011.01.007>

Vršková, V., Tančin, V., Kirchnerová, K., Sláma, P. 2015. Evaluation of daily milk production in tsigai ewes by somatic cell count. *Potravinarstvo*, vol. 9, no. 1, p. 206-210.
<https://doi.org/10.5219/439>

Zajac, P., Zubricka, S., Capla, J., Zelenakova, L. 2016. Fluorescence microscopy methods for the determination of somatic cell count in raw cow's milk. *Veterinarni Medicina*,

vol. 61, no. 11, p. 612-622.
<https://doi.org/10.17221/222/2015-VETMED>

Acknowledgments:

This study was supported by APVV 15-0072. Also we would like to thank very much organization Plemenárske služby š.p. Bratislava for excellent cooperation in research.

Contact address:

Vladimír Tančin, Slovak University of Agriculture, Faculty of Agrobiolgy and Food Resources, Department of veterinary science, Tr. A. Hlinku 2, 949 76 Nitra, Slovakia; NPPC-Research Institute for Animal Production Nitra, Hlohovecká 2, 95141 Lužianky Slovakia, E-mail: tancin@vuzv.sk

Michal Uhrinčať, NPPC-Research Institute for Animal Production Nitra, Hlohovecká 2, 95141 Lužianky, Slovakia, E-mail: uhrincat@vuzv.sk

Lucia Mačuhová, NPPC-Research Institute for Animal Production Nitra, Hlohovecká 2, 95141 Lužianky, Slovakia, E-mail: macuhova@vuzv.sk

Štefan Baranovič, University of Agriculture, Faculty of Agrobiolgy and Food Resources, Department of veterinary science, Tr. A. Hlinku 2, 949 76 Nitra Slovakia; E mail: stefan.baranovic@plusko.net

Martina Vršková, NPPC-Research Institute for Animal Production Nitra, Hlohovecká 2, 95141 Lužianky, Slovakia, E-mail: vrskova@vuzv.sk



EVALUATION OF RABBIT MEAT MICROBIOTA FROM THE VIEWPOINT OF MARKETING METHOD

Olga Cwiková, Roman Pytel

ABSTRACT

Microbiological analysis was performed on carcasses of rabbits coming from domestic slaughter, purchased at butcher shops, vacuum-packaged and purchased in supermarkets, as well as frozen. The total number of analysed rabbits was 20. For all samples the following microbiological parameters were determined: total microorganisms count (TAC), the count of lactic acid bacteria (LAB), psychrotrophic microorganisms, moulds and yeasts, as well as bacteria of the Enterobacteriaceae family. Total microorganisms count was the highest ($p < 0.05$) in rabbit meat from butcher shops ($5.34 \log \text{CFU.g}^{-1}$). The counts of lactic acid bacteria (LAB) in rabbit meat originating from domestic breeding was $2.58 \log \text{CFU.g}^{-1}$, in vacuum-packaged rabbits $3.18 \log \text{CFU.g}^{-1}$, in frozen rabbits $2.29 \log \text{CFU.g}^{-1}$, and in rabbit meat purchased from butcher shops $3.58 \log \text{CFU.g}^{-1}$. The highest count ($p < 0.05$) of Enterobacteriaceae was observed in samples from butcher shops, namely $2.91 \log \text{CFU.g}^{-1}$. In contrast the lowest count ($p < 0.05$) was in rabbit meat from home slaughtering at $1.47 \log \text{CFU.g}^{-1}$ and in frozen ones at $1.36 \log \text{CFU.g}^{-1}$. The lowest counts ($p < 0.05$) of moulds and yeasts were observed in rabbit meat from domestic slaughter, namely $1.12 \log \text{CFU.g}^{-1}$. The highest counts ($p < 0.05$) were in rabbit meat from butcher shops $2.97 \log \text{CFU.g}^{-1}$. The highest counts ($p < 0.05$) of psychrotrophic microorganisms were detected in rabbit meat from butcher shops, namely $4.98 \log \text{CFU.g}^{-1}$ and the lowest ones ($p < 0.05$) in the meat of domestically slaughtered rabbits at $2.52 \log \text{CFU.g}^{-1}$. In all monitored microbiological indicators, we have found differences ($p < 0.05$) in their counts on the surface and inside the muscle tissue, both on the front and rear parts of the rabbit carcass.

Keywords: rabbit; TAC; LAB; *Enterobacteriaceae*; psychrotrophic microorganisms; yeasts and moulds

INTRODUCTION

Safety and shelf life of meat is limited by microbial growth. Dominant organisms causing spoilage in carcasses of rabbits and packaged rabbit meat include Gram-negative bacteria, psychrotrophic bacteria, lactic acid bacteria, yeasts, and *Brochothrix thermosphacta* (Pereira and Ferreira, 2015). In aerobic conditions, most spoilage involves the genus *Pseudomonas*. However, in vacuum or in modified atmosphere its growth is suppressed (Corry, 2007; Kamenik and Chomát, 2013). According to Rodriguez-Calleja et al. (2004), the limiting factor for the shelf life of meat, is the count of microorganisms at 6 to 7 $\log \text{CFU.g}^{-1}$. Pereira and Ferreira (2015) reported the count to be higher, at 7.00 to 8.00 $\log \text{CFU.cm}^{-2}$.

Microbiological quality of rabbit meat can be affected by various factors, such as storage conditions and hygiene during the slaughtering (Koutsoumanis and Sofos, 2004). During the slaughtering, contamination of muscle tissue may be caused by a wide variety of microorganisms, particularly during evisceration, due to an increase in the count of microorganisms originating from the gastrointestinal tract (Nakyinsigea et al., 2015). Nutrition

also has a significant influence on the number of microorganisms, as some feed ingredients may adversely affect the rate of growth of microorganisms (Hernandez, 2008) and can extend the shelf life of rabbit meat (Vannini et al., 2003).

The objective of the work was to evaluate microbiota of rabbit meat and determine whether marketing method (packaging, storage) and a sampling site (surface, inside, front, rear parts of the rabbit carcass) have impact on the number of some microorganisms.

MATERIAL AND METHODOLOGY

Microbiological analysis was carried out on samples of rabbit meat derived from domestic slaughter (1 day after slaughtering), rabbit meat purchased from the butcher (3 days before Best before date), vacuum-packaged rabbit meat purchased in supermarkets (3 days before Best before date), and frozen rabbit meat (3 month before Best before date). The total number of analysed rabbits was 20. The samples were transported to the microbiological lab in a thermal bag at 4 °C to avoid violating the refrigeration regimen. The microbiological analysis was carried out in a

microbiological lab of the Department of Food Technology at Mendel University in Brno.

Samples were taken from four locations of a rabbit carcass:

- the surface of the front part (part above the last thoracic vertebra, including the front legs),
- inside the muscle tissue of the front part,
- the surface of the rear part (the part below the seventh lumbar vertebra, including the hind legs),
- inside the muscle tissue of the rear part.

For all samples, was determined the following microbiological parameters:

- Total microorganisms count (TAC) – 72 hours at 30 °C (ISO 4833-1, 2014).
- Lactic acid bacteria (LAB) – 72 hours at 30 °C (ISO 13721, 1998).
- Psychrotrophic microorganisms – 10 days at 6.5 °C (ISO 17410, 2003).
- Moulds and yeasts – 5 days at 25 °C (ISO 21527-1, 2009).
- *Enterobacteriaceae* family – 24 hours at 37 °C (ISO 21528-2, 2006).

Sampling and processing was carried out based on ISO 7218 (2007) and ISO 6887-1 (2003). All analyses were carried out during the shelf life of the given product.

The following methods were used for statistical evaluation: the calculation of basic statistical parameters (mean, standard deviation, standard deviation of the mean) and the simple sorting method of analysis of variance (ANOVA, Tukey's test). Evaluation was performed using the STATISTICA CZ programme, version 10.

RESULTS AND DISCUSSION

Microbiological quality of rabbit meat in terms of marketing method.

Total count of microorganisms (Figure 1)

The total microorganisms count was the highest ($p < 0.05$) in rabbit meat from butcher shops. Among the samples of vacuum-packaged rabbit meat, frozen meat, and home-slaughtered meat, there was no observed statistical difference ($p < 0.05$) in TAC.

The highest count of microorganisms detected in rabbit meat coming from butcher shops indicates either a failure of the refrigeration regimen during storage, or false data about the shelf life. TAC best describes the degree of microbial contamination of given food and we can guess by this the adherence to technology in the production, transport, and storage (Görner and Valík, 2004). The total microorganisms count in rabbit meat originating from domestic breeding was 3.17 log CFU.g⁻¹, in vacuum-packaged rabbit meat 3.97 log CFU.g⁻¹, in frozen rabbit meat 3.82 log CFU.g⁻¹ and in rabbit meat purchased from butcher shops 5.34 log CFU.g⁻¹. Rodríguez-Calleja et al. (2006) reported that the total count of bacteria in the rabbit meat usually ranges from 4.01 to 4.96 log CFU.g⁻¹. Nakyinsigea et al. (2015) and Lan et al. (2016) reported a higher TAC, immediately after slaughter at 4.7, respectively 4.6 log CFU.g⁻¹. After three days of storage, the TAC increased to 6.18 log CFU.g⁻¹, after five days to 6.78 log CFU.g⁻¹, and after seven days the microbial counts reached 7.83 log CFU.g⁻¹. In contrast, lower counts

found by Pereira and Ferreira (2015), ranged from 2.87 to 4.87 log CFU.g⁻¹.

The maximum permitted TAC value in rabbit meat intended for heat treatment is not currently regulated by the Czech legislation. The no longer valid Decree 132/2004 Sb. on the Microbiological Requirements for Foods, their Monitoring and Evaluation stated the TAC limit to be 106 CFU.g⁻¹ (6 log CFU.g⁻¹). All our analysed samples complied with this requirement.

Lactic acid bacteria (Figure 2)

The counts of lactic acid bacteria were the highest ($p < 0.05$) in rabbit meat originating from butcher shops and in vacuum-packaged rabbits. The counts of lactic acid bacteria in rabbit meat originating from domestic breeding were 2.58 log CFU.g⁻¹ in vacuum-packaged rabbit meat at 3.18 log CFU.g⁻¹, in frozen rabbit meat at 2.29 log CFU.g⁻¹ and in rabbit meat purchased from butcher shops at 3.58 log CFU.g⁻¹.

Lactic acid bacteria are the main organisms causing spoilage of rabbit meat in vacuum packaging (Rodríguez-Calleja et al., 2010), which corresponds with our results. We have detected a higher count of LAB in rabbit meat from butcher shops, which could be due to a prolonged storage. Pereira and Ferreira (2015) have also reported similar results for rabbit meat before packaging as they detected 2.21 to 3.71 log CFU.g⁻¹ of LAB.

Enterobacteriaceae (Figure 3)

The highest count ($p < 0.05$) of Enterobacteriaceae was recorded in samples of rabbit meat from butcher shops at 2.91 log CFU.g⁻¹. The lowest count ($p < 0.05$) was in meat of home-slaughtered rabbits at 1.47 log CFU.g⁻¹ and in frozen rabbits at 1.36 log CFU.g⁻¹. Pereira and Ferreira (2015) reported similar counts to ours, where before packaging rabbit meat they detected an average of 1.18 log CFU.g⁻¹ (<1.00 to 3.27 log CFU.g⁻¹) of Enterobacteriaceae.

Rodríguez-Calleja et al. (2005), observed higher counts after seven days of storage and recorded 2.80 log CFU.g⁻¹ of Enterobacteriaceae. This result corresponds to the count of Enterobacteriaceae identified in this experiment in rabbit meat coming from butcher shops. The reason why Enterobacteriaceae counts were higher may be due to poor hygienic handling of rabbit meat. This may have occurred during refrigeration, transport or packaging as the rabbit carcasses were packaged into plastic bags later at butcher shops. Poor sanitation of workers may have played certain role (Steinhauser et al., 2000), as Enterobacteriaceae are an indicator of improperly performed hygiene during the manufacturing process and during storage (Görner and Valík, 2004).

Moulds and yeasts (Figure 4)

It was observed the lowest counts ($p < 0.05$) of moulds and yeasts in rabbit meat originating from domestic slaughter at 1.12 log CFU.g⁻¹, the highest ($p < 0.05$) in the rabbit meat from butcher shops at 2.97 log CFU.g⁻¹. Since moulds and yeasts are capable of growing even under very unfavourable conditions, they are some of the common originators of food spoilage (Vilková et al., 2009). In contrast this results, Pereira and Ferreira (2015) have found higher counts of yeasts and moulds at 3.92 log CFU.g⁻¹ (<1.00 to 3.92), Chabela et al. (1999)

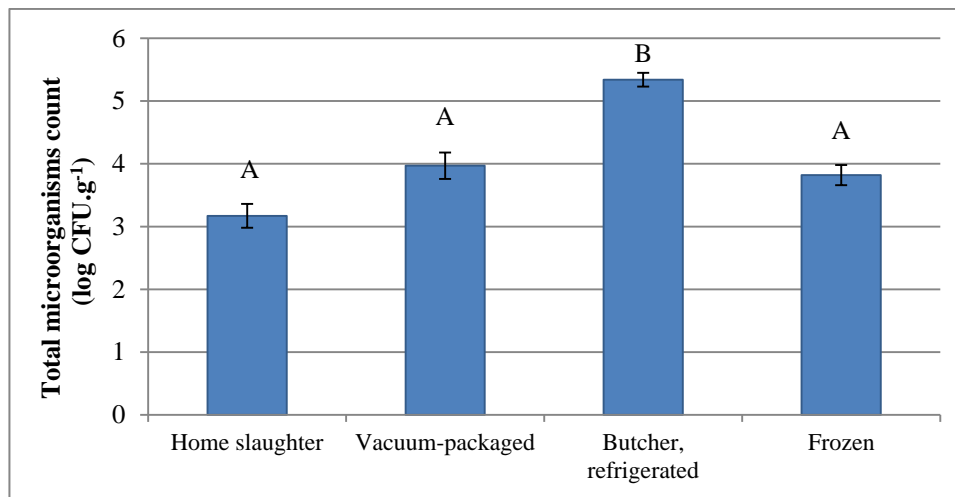

Figure 1 Comparison of the total count of microorganisms (log CFU.g⁻¹) in rabbit meat, (n = 5). Averages marked with different letters in the monitored factor (marketing method) are statistically different ($p < 0.05$).

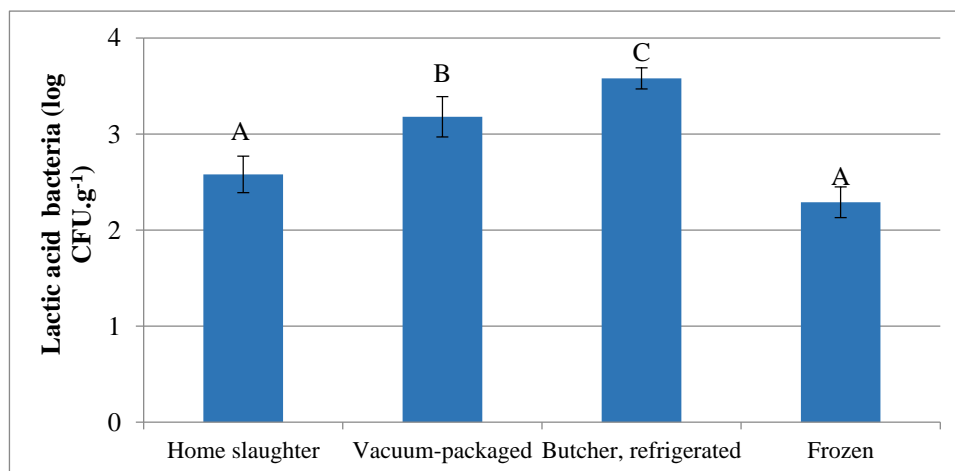

Figure 2 Comparison of the counts of lactic acid bacteria (log CFU.g⁻¹) in rabbit meat, (n = 5). Averages marked with different letters in the monitored factor (marketing method) are statistically different ($p < 0.05$).

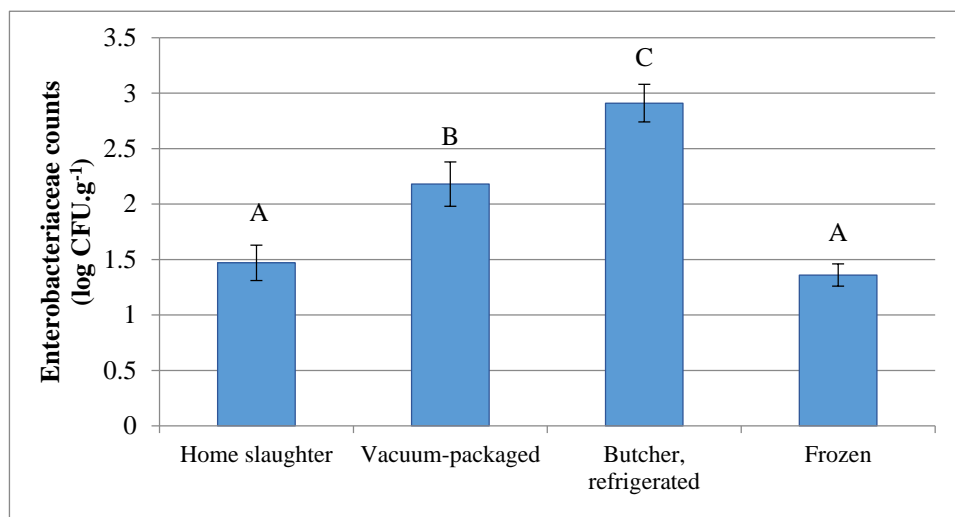

Figure 3 Comparison of *Enterobacteriaceae* counts (log CFU.g⁻¹) in rabbit meat (n = 5). Averages marked with different letters in the monitored factor (marketing method) are statistically different ($p < 0.05$).

found 3.76 log CFU.g⁻¹, but microbial analysis was carried out during a total of 14 days of storage.

Psychrotrophic microorganisms (Figure 5)

Figure 5 shows that the highest count ($p < 0.05$) of psychrotrophic microorganisms was detected in rabbit

meat originating from butcher shops at 4.98 log CFU.g⁻¹ and the lowest ($p < 0.05$) in the meat from domestic slaughter of rabbits at 2.52 log CFU.g⁻¹. **Pereira and Ferreira (2015)** have detected similar counts of psychrotrophic microorganisms between 2.46 and 5.25 log CFU.g⁻¹. After four days of storage their count, in

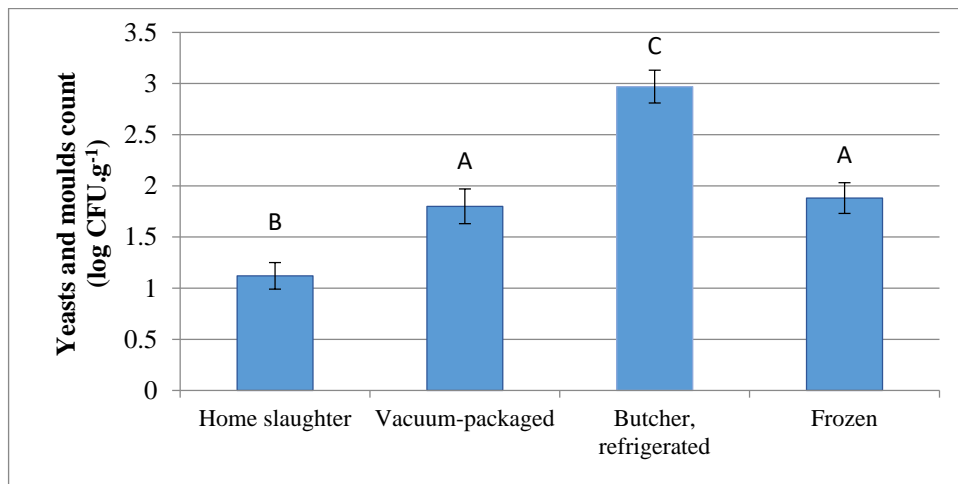

Figure 4 Count comparison of yeasts and moulds (log CFU.g⁻¹) in rabbit meat (n = 5). Averages marked with different letters in the monitored factor (marketing method) are statistically different ($p < 0.05$).

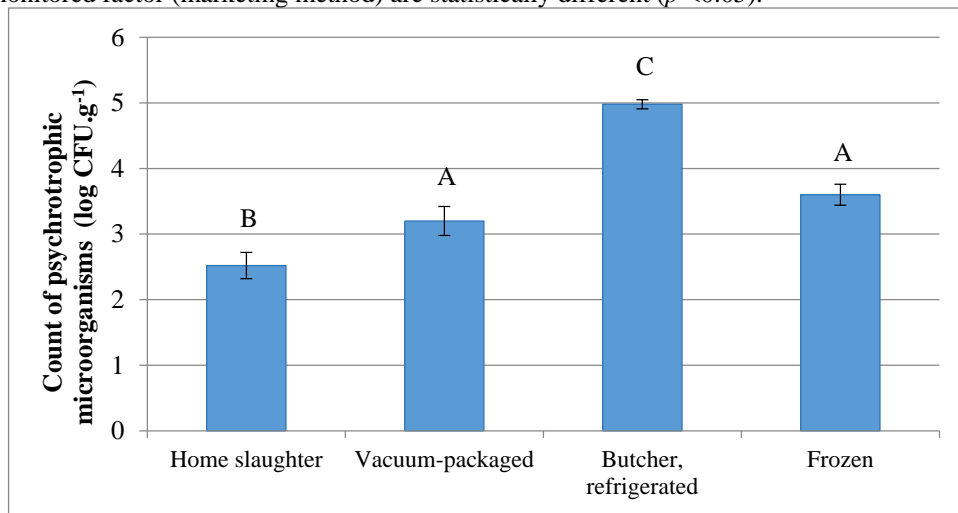

Figure 5 Comparison of counts of psychrotrophic microorganisms (log CFU.g⁻¹) in rabbit meat (n = 5). Averages marked with different letters in the monitored factor (marketing method) are statistically different ($p < 0.05$).

the above mentioned experiment, increased to between 2.8 and 6.3 log CFU.g⁻¹. Chabela et al. (1999) found lower psychrotrophic counts after 14 days of storage (3.13 log CFU.g⁻¹).

The above results suggest that the rabbit meat shelf life can be increased for example by refrigeration, modified atmosphere or irradiation (Berruga et al., 2005).

Non-irradiated rabbit meat samples were found to be contaminated with relatively high initial counts of aerobic mesophilic bacteria, psychrophilic bacteria, enterobacteriaceae and molds and yeasts as their mean counts reached 6.02, 5.89, 4.79 and 4.89 log CFU.g⁻¹, respectively. Irradiation at 3 kGy reduced the counts of microorganisms from 94 to 99.7% (Badr, 2004). Most

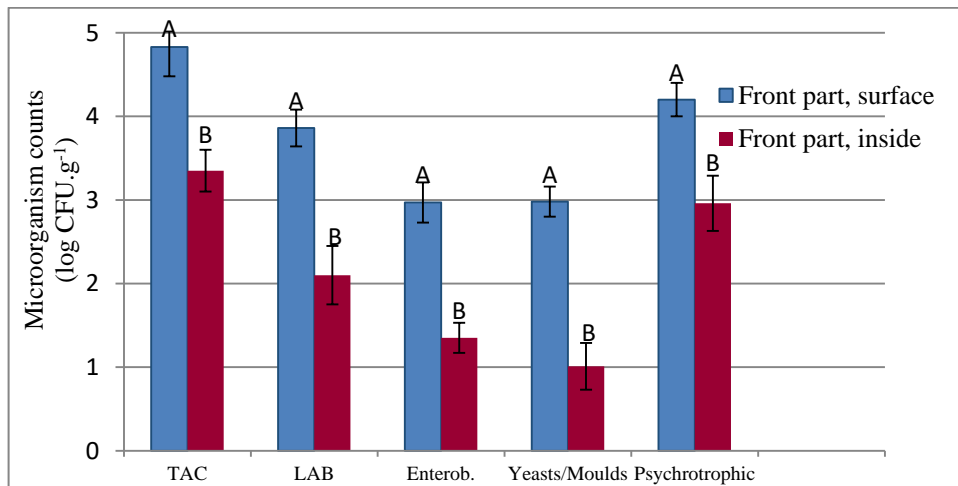

Figure 6 Comparison of microorganism counts (log CFU.g⁻¹) in rabbit meat (n = 20). Averages marked with different letters in the monitored factor (sampling site) are statistically different ($p < 0.05$).

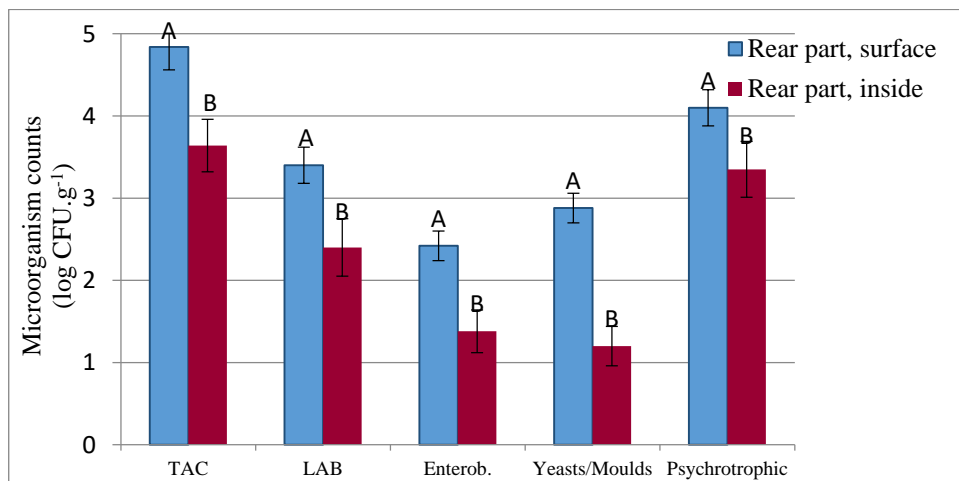

Figure 7 Comparison of microorganism counts (log CFU.g⁻¹) in rabbit meat (n = 20). Averages marked with different letters in the monitored factor (sampling site) are statistically different ($p < 0.05$).

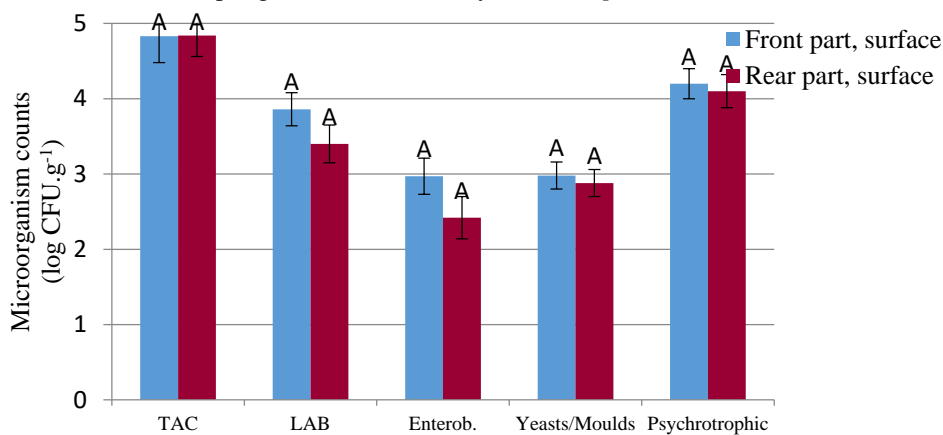

Figure 8 Comparison of microorganism counts (log CFU.g⁻¹) in rabbit meat (n = 20). Averages marked with different letters in the monitored factor (sampling site) are statistically different ($p < 0.05$).

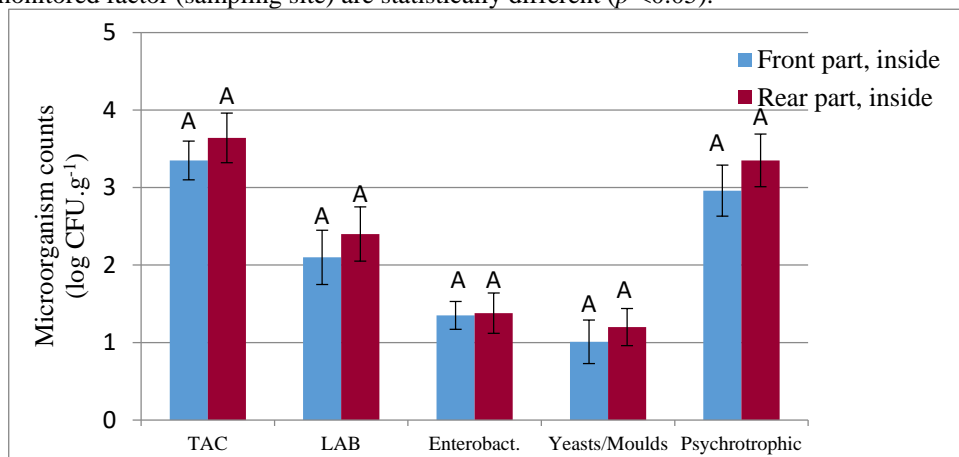

Figure 9 Comparison of microorganism counts (log CFU.g⁻¹) in rabbit meat (n = 20). Averages marked with different letters in the monitored factor (sampling site) are statistically different ($p < 0.05$).

important is, however, the compliance with the hygienic conditions during slaughter based on the HACCP principles (Kohler et al., 2008).

Comparison of the count of microorganisms on the surface and within the muscle tissue of the front and rear parts of the rabbit carcass

In all our monitored microbiological indicators, was found differences ($p < 0.05$) in their counts on the surface and within the muscle tissue, both in front of and rear parts of the rabbit carcass. In the front part of the carcass, the

difference between the surface and the inside was 1.50 log CFU.g⁻¹ on average (Figure 6).

The difference in the count of microorganisms between the surface and the inside of the rear part of the carcass averaged 1.20 log CFU.g⁻¹ (Figure 7). This may be due to secondary contamination of rabbit meat from the air, from used tools, from skin and fur of animals, from containers, packaging materials, and crates (Steinhauser et al., 2000). According to Szkucik and Pyz-Lukasik (2009), bacterial contamination of the carcass surface in compliance with hygiene standards ranges from 3 to 4 log CFU.g⁻¹.

We have found values that are higher; in the front part of the carcass at 4.83 log CFU.g⁻¹. At the rear part of the rabbit carcass it was 4.84 log CFU.g⁻¹ of mesophilic aerobic microorganisms. Lower aerobic total viable count of the haunch surface after slaughter found **Ludewig and Fehlhaber (2005)**, it was between log 3.77 and 3.80 CFU.g⁻¹.

Regarding the comparison of the microorganism counts in the rear and front parts of the rabbit carcass, both on the surface and inside the muscle tissue, was not recorded statistically significant difference in their counts at $p < 0.05$ (Figure 8 and Figure 9). **Abdel-Rahman et al. (2008)** also found no statistically significant difference in the count of microorganisms in the breast and thigh muscle parts, but they have studied chickens.

CONCLUSION

Based on these results, we can say that for maintaining the safety and quality of rabbit meat, it is most important to uphold rigorous hygiene not only during slaughter, but also during subsequent storage and handling. Although some ways of packaging and storage can to some extent prolong the shelf life and ensure satisfactory microbiological criteria, however, it always depends on the level of initial microbial contamination of meat. Therefore, in the context of the introduction of new EU legislation on food safety, rabbit slaughterhouses must apply control programs for safe and hygienic slaughtering conditions based on the principles of HACCP.

REFERENCES

- Abdel-Rahman, H. A., Yassein, M. A., Ahmed, A. M., Hayashidani, H., Elhelaly, A. E. 2008. Bacterial profile of frozen broiler chickens. *Suez Canal Veterinary Medicine Journal*, vol. 13, no. 1, p. 49-60.
- Badr, H. M. 2004. Use of irradiation to control foodborne pathogens and extend the refrigerated market life of rabbit meat. *Meat Science*, vol. 67, no. 4, p. 541-548. <https://doi.org/10.1016/j.meatsci.2003.11.018> PMID:22061802
- Berruga, M. L., Vergara, H., Linares, M. B. 2005. Control of microbial growth and rancidity in rabbit carcasses by modified atmosphere packaging. *Journal of the Science of Food and Agriculture*, vol. 85, no. 12, p. 1987-1991. <https://doi.org/10.1002/jsfa.2183>
- Corry, L. E. L. 2007. Spoilage organisms of red meat and poultry and eggs. In Mead, G. *Microbial Analysis of Red Meat, poultry and Eggs*. Sawston, Cambridge, UK : Woodhead Publishing p. 101-122. ISBN 978-1-84569-059-5. <https://doi.org/10.1533/9781845692513.101>
- Decree no. 132/2004 Sb. Ministry of Health of the Czech republic on the microbiological requirements for foods, to their monitoring and evaluation. *Collection of Laws, No. 42, 03/26/2004, p. 1738-1757. (Vyhláška Ministerstva zdravotnictví o mikrobiologických požadavcích na potraviny, způsobu jejich kontroly a hodnocení. Sběrka zákonů ČR, částka 42, 26/3/2004, p. 1738-1757.*
- Chabela, M. L. P., Serrano, G. M. R., Calderon, P. L., Guerrero, I. 1999. Microbial spoilage of meats offered for retail sale in Mexico City. *Meat Science*, vol. 51, no. 4, p. 279-282. [https://doi.org/10.1016/S0309-1740\(98\)00096-5](https://doi.org/10.1016/S0309-1740(98)00096-5)
- Görner, F., Valík, L. 2004. *Applied food microbiology. (Aplikovaná mikrobiológia potravín)*. Bratislava, Slovakia : Malé Centrum, PPA. 528 p. ISBN 80-967064-9-7.
- Hernández, P. 2008. Enhancement of nutritional quality and safety in rabbit meat. In: *Proceedings of 9th World Rabbit Congress*. Verona, Italy, p. 1287-1299.
- ISO 13721:1998. *Microbiology of food and animal feeding stuffs – Horizontal method for the enumeration of mesophilic lactic acid bacteria Colony-count technique at 30 degrees*.
- ISO 17410:2003. *Microbiology of food and animal feeding stuffs – Horizontal method for the enumeration of psychrotrophic microorganisms*.
- ISO 6887-2:2003. *Microbiology of food and animal feeding stuffs – Preparation of test samples, initial suspension and decimal dilutions for microbiological examination – Part 2: Specific rules for the preparation of meat and meat products*.
- ISO 21528-2:2006. *Microbiology of food and animal feeding stuffs – Horizontal method for the enumeration of Enterobacteriaceae, Colony-count technique*.
- ISO 7218:2007. *Microbiology of food and animal feeding stuffs-General requirements and guidance for microbiological examinations*.
- ISO 21527-1:2009. *Microbiology of food and animal feeding stuffs – Horizontal method for the enumeration of yeasts and moulds – Part 1: Colony count technique in products with water activity greater than 0.95*.
- ISO 4833-1:2014. *Microbiology of food and animal feeding stuffs – Horizontal method for the enumeration of microorganisms, Colony-count technique at 30 °C*.
- Koutsoumanis, K., Sofos, J. N. 2004. Microbial contamination W.K. in Devine, C. et al. *Encyclopedia of meat sciences*. 2nd ed. UK : Elsevier, p. 727-737. ISBN: 978-0-12-464970-5. <https://doi.org/10.1016/B0-12-464970-X/00070-2>
- Kameník, J., Chomát, P. 2013. „B“ as a package of meat and meat products („B“ jako balení masa a masných výrobků). *Maso*, vol. 24, no. 1, p. 8-13.
- Kohler, R., Krause, G., Bentin, L., Stephan, R., Zweifel, C. 2008. Shedding of food-borne pathogens and microbiological carcass contamination in rabbits at slaughter. *Veterinary microbiology*, vol. 132, no. 1-2, p. 149-157. <https://doi.org/10.1016/j.vetmic.2008.04.020> PMID:18514438
- Lan, Y., Shang, Y., Song, Y., Dong, Q. 2016. Changes in the quality of superchilled rabbit meat stored at different temperatures. *Meat Science*, vol. 117, p. 173-181. <https://doi.org/10.1016/j.meatsci.2016.02.017> PMID:26990070
- Ludewig, M., Fehlhaber, K. 2005. Investigation on the microbiological status of rabbit meat with respect to bacteria relevant to food hygiene. *Archiv für Lebensmittelhygiene*, vol. 56, no. 2, p. 28-32.
- Nakyinsigea, K., Sazilia, A. Q., Aghwana, Z. A., Zulkiflia, I., Gohc, Y. M., Abu Bakara, F., Saraha, S. A. 2015. Development of microbial spoilage and lipid and protein oxidation in rabbit meat. *Meat Science*, vol. 108, p. 125-131. <https://doi.org/10.1016/j.meatsci.2015.05.029> PMID:26115345
- Pereira, M., Malfeito-Ferreira, M. 2015. A simple method to evaluate the shelf life of refrigerated rabbit meat. *Food Control*, vol. 49, p. 70-74. <https://doi.org/10.1016/j.foodcont.2013.10.021>
- Rodríguez-Calleja, J. M., Santos, J. A., Otero, A. 2004. Microbiological quality of rabbit meat. *Journal of Food protection*, vol. 67, no. 5, p. 966-971. <https://doi.org/10.4315/0362-028X-67.5.966> PMID:15151235
- Rodríguez-Calleja, J. M., García-López, M. L., Santos, J. A., Otero, A. 2005. Development of the aerobic spoilage flora of chilled rabbit meat. *Meat Science*, vol. 70, no. 2, p. 389-

394. <https://doi.org/10.1016/j.meatsci.2005.01.009>

[PMid:22063497](#)

Rodríguez-Calleja, J. M., García-López, M. L., Santos, J. A., Otero, A. 2006. Rabbit meat as a source of bacterial foodborne pathogens. *Journal of Food Protection*, vol. 69, no. 5, p. 1106–1112. <https://doi.org/10.4315/0362-028X-69.5.1106>

[PMid:16715811](#)

Rodríguez-Calleja, J. M., Santos, J. A., Otero, A., García-López, M. L. 2010. Effect of vacuum and modified atmosphere packaging on the shelf life of rabbit meat. *Cyta – Journal of Food*, vol. 8, no. 2, p. 109-116. <https://doi.org/10.1080/19476330903205041>

Šilhánková, L. 2008. *Microbiology for food and biotechnology workers (Mikrobiologie pro potravináře a biotechnologie)*. Praha, Czech Republic : Nakladatelství Academia, 363 p., ISBN 8-85605-71-6.

Steinhauser, L. et al. 2000. *Hygiene and technology of meat (Hygiena a technologie masa)*, Brno, Czech Republic : LAST, 643 p. ISBN 80-900260-7-9.

Szkucik, K., Pyz-Łukasik, R. 2009. Quality health of rabbit meat (Jakość zdrowotna mięsa królików). *Medycyna Weterynaryjna*, vol. 65, no. 10, p. 665-669.

Vannini, L., Sado, S., Iucci, L., Ndagijimana, M., Guerzoni, M. E. 2003. The dietary use of linseed in growing rabbits: effects on microbial population and spoilage patterns of meat products. In: *Proceedings of 3rd Meeting Working Group 4 "Nutrition and pathology" and 5 "Meat quality and safety"*. Praha : Czech Republic, p. 32-33.

Vlková, E., Rada, V. Killer, J. 2009. *Food microbiology (Potravinářská mikrobiologie)*. Praha, Czech Republic : Česká zemědělská univerzita v Praze, 168 p. ISBN 978-80-213-1988-2.

Contact address:

MVDr. Olga Cwíková, Ph.D., Mendel University in Brno, Faculty of AgriSciences, Department of Food Technology, Zemědělská 1, 61300 Brno, Czech Republic, E-mail: cwikova@mendelu.cz

Ing. Roman Pytel, Mendel University in Brno, Faculty of AgriSciences, Department of Food Technology, Zemědělská 1, 613 00 Brno, Czech Republic, E-mail: roman.pytel@mendelu.cz



A COMPARATIVE STUDY OF *SUS SCROFA M. LONGISSIMUS DORSI* WITH DIFFERENT CHANGES IN QUALITY

Irina Chernukha, Liliya Fedulova, Anastasia Akhremko, Elena Kotenkova

ABSTRACT

The comparative study of *Sus scrofa* muscle tissue with different defects of quality was carried out. Such analysis methods as determination of water-binding capacity (WBC) and pH values, microstructural studies, proteome methods, mass spectrometric methods, high performance liquid chromatography (HPLC) and determine the concentration of cathepsin D, calpain 3 and myoglobin were applied in current study. DFD meat was characterized by high pH (6.2) and WBC (93.18%), while PSE – low pH (5.5) and WBC (79.19%). pH and WBC values in NOR pork was medium and averaged 5.9 and 92.05%, respectively. Microstructural studies revealed that fiber in exudative pork was the least and averaged 39.7 μm , normal pork was characterized by diameter of muscle of 45.5 μm , while DFD pork - 48.3 μm . Protein composition of *Sus scrofa* muscle tissues were also investigated by one-dimensional and two-dimensional electrophoresis. 6 protein fractions were identified by mass spectrometry and confirmed as potential biomarkers of pork quality defects in meat and processes meat product. It also has been shown that PSE pork contains 8 characteristic peptides, NOR – 14, DFD – 18. Cathepsin D, calpain 3 and myoglobin content were measured in pork of different categories. The highest content of cathepsin D, calpain 3 and myoglobin was noticed in PSE pork and averaged 82.16 \pm 3.30 $\text{ng}\cdot\text{mL}^{-1}$; 1.280 \pm 0.082 $\text{ng}\cdot\text{mL}^{-1}$; 3.973 \pm 0.506 $\text{ng}\cdot\text{mL}^{-1}$, respectively. Since the study was carried out on samples of meat 24 hours after slaughter, this work had the prospect to further study of meat with different defects of quality during long-term autolysis.

Keywords: muscle proteins; pork; PSE; DFD; electrophoresis

INTRODUCTION

Proteomic studies of *Sus scrofa* muscle tissues composition are of considerable interest for many reasons. The most important reason is pork predominant use in the production of meat and meat products in many countries (De Almeida and Bendixen, 2012). Moreover, this species is a quite good object for biomedical problems science studies. Therefore, proteomics of muscle tissue is important for determining the quality of raw materials (Kovalyov et al., 2013). To date, there are three main quality defect of meat: normal meat (NOR), meat with high ultimate pH (DFD – dark, firm, dry) and exudative meat (PSE – Pale, Soft, Exudative) with low pH values. Special attention is paid to exudative meat. Currently, exudative pork is spread in all countries and ranged from 5 to 40% of the total volume of pork. The main causes of exudative pork (PSE meat) are reduction in organism adaptation to increased load, nervous excitement of animals in pre-slaughter period as well as pigs overcrowding in the household (Kopeikina and Chudzickaya, 2005). *M. longissimus dorsi* are the most prone to exudative changes. It's changed in color and

structure faster than other; therefore samples of *M. longissimus dorsi* were object of the study.

Scientific hypothesis

The aim of the study was to investigate different meat types (PSE, DFD and NOR) in order to identify potential protein markers of quality defects as pork quality control parameters.

MATERIAL AND METHODOLOGY

The objects of study were the samples of *Sus scrofa M. longissimus dorsi* (OOO «Wepoz – trgovy dom», Rostov, Russiawith a various defects of quality (NOR, PSE, DFD). The samples were stored at temperature 2 \pm 2 $^{\circ}\text{C}$ in industrial refrigerator for 24 h before experiments.

The value of pH was measured by potentiometric method on pH-ionometer "Expert" in accordance with GOST R 51478-99 (ISO 2917-74) "Test method for the determination of hydrogen ion concentration (pH)".

The value of WBC was measured by Grau-Hamm method (press techniques). The moisture in the raw meat were determined by drying a sample with sand till constant weight at a temperature of (103 \pm 2) $^{\circ}\text{C}$ in accordance with

GOST R 51479-99 (ISO 1442-97) "Meat and meat products. The method of determination of moisture mass content".

Microstructural studies were carried out according to GOST 19496-1993 "Meat. The method of histological study". Samples were fixed in 15% neutral formalin solution for 48 h. After fixation samples were washed in running water, slices were prepared on freezing microtome-cryostat with thickness of 20 µm. Slices were stained with Ehrlich's hematoxylin followed by staining by 1% eosin solution. The examination of slises was carried out using a system of image analysis Motik (China) with the increase in 360 times.

One-dimensional (1D) electrophoresis was performed according to the method of Laemmli (Laemmli, 1970) under denaturing conditions in 12.5% polyacrylamide gel with the presence of SDS. The marker was used comprising of eleven standards (recombinant proteins) "Thremo" (USA).

Two-dimensional (2D) electrophoresis was performed according to the method of O'Farrell (O'Farrell, 1975) with isoelectric focusing in ampholine pH gradient (IEF-PAGE). The subsequent detection of the proteins was carried out by staining with Coomassie Brilliant Blue R-250. Identification of protein fractions was performed on DE after trypsinolysis by MALDI-TOF/MS and MS/MS mass spectrometry on Ultraflex MALDI-TOF mass spectrometer (Bruker, Germany) with UV laser (336 nm) in the positive ion mode in molecular weight range of 500-8000 Da with calibration according to known peaks of trypsin autolysis. Analysis of obtained tryptic peptides

mass spectra was performed using Peptide Fingerprint option in Mascot software (Matrix Science, USA) with MH+ mass determination accuracy of 0.01%; search was performed in databases of the National Center for Biotechnology Information, USA (NCBI).

Analysis of the peptide profile was carried out on a system of high performance liquid chromatography (HPLC) with t mass spectrometer (liquid chromatograph AGILENT 1200 C with a mass selective detector, AGILENT 6410, USA).

The concentration of cathepsin D, calpain 3 and myoglobin were measured by enzyme-linked immunosorbent assay (ELISA) on a microplate reader, ImmunoChem 2100 (High Technology INC, Walpole, MA USA) using a microplate, Thermo-Shaker Immunochem-2200 (High Technology INC, Walpole, MA USA) using commercial Elabscience Biotechnology Co., Ltd (China, Guangdong Science and Technology).

Statistic analysis

STATISTICA 10.0 software was used in this study for the statistical analyses. Significant differences were tested by using two-way analysis of variance (ANOVA), followed by Duncan's test. Differences with p-values less than 0.05 were considered as statistically significant.

RESULTS AND DISCUSSION

Samples of *Sus scrofa M. longissimus dorsi* were selected according to pH values, as this value largely reflected on mechanism of quality (PSE, DFD and NOR) defects

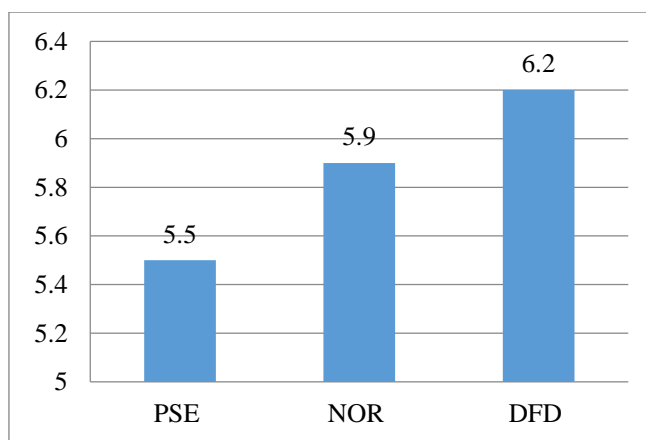

Figure 1 The values of pH in pork *M. longissimus. dorsi* (PSE, NOR, DFD).

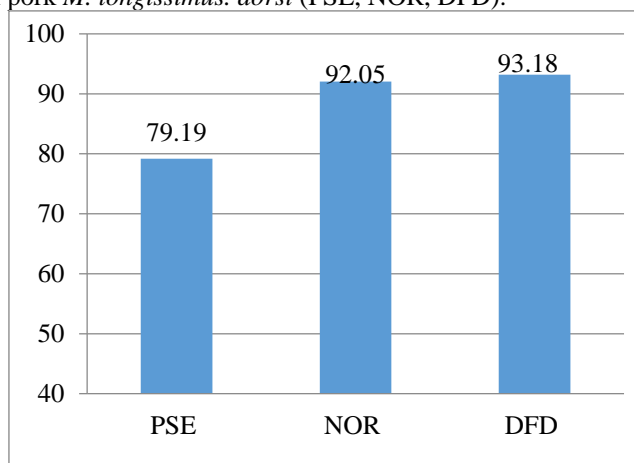

Figure 2 WBC, % to total humidity in pork *M. longissimus. dorsi* (PSE, NOR, DFD).

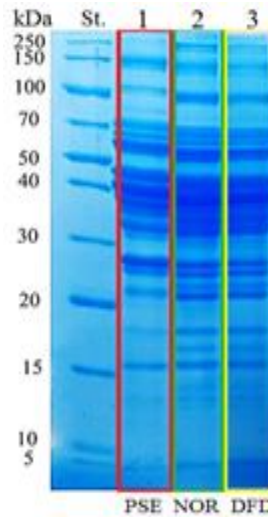

Figure 3 1D electrophoresis of pork *M. longissimus. dorsi* (PSE, NOR, DFD).

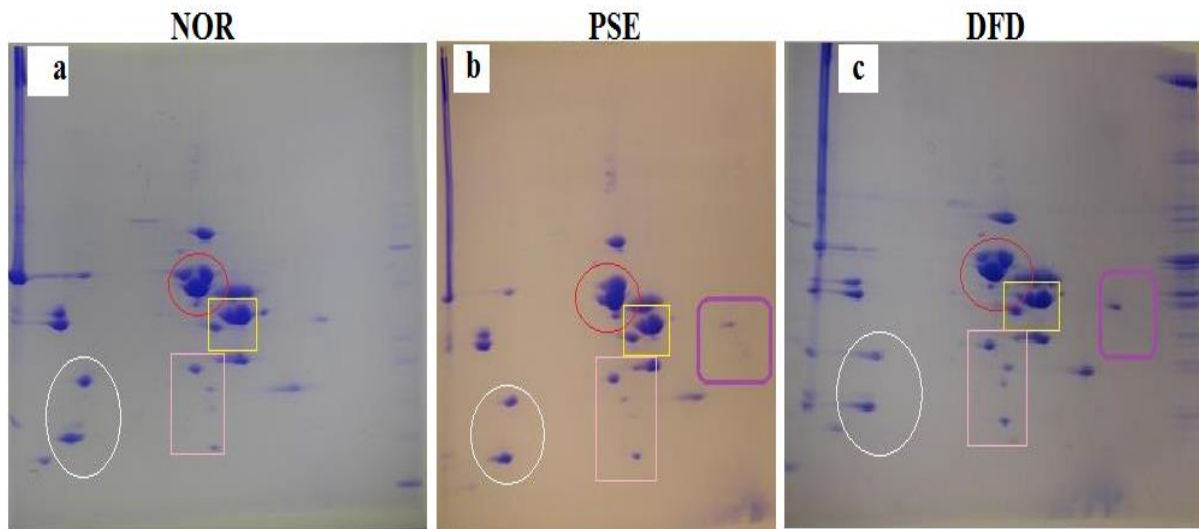

Figure 4 2D electrophoresis of pork *M. longissimus. dorsi* (PSE, NOR, DFD).

formation (Bazhov et al., 2013). Significant differences in pH values were determined between pork samples (Figure 1).

Nevertheless, 24 h after slaughter the pH value of meat samples corresponded to the norms for PSE-, NOR-, DFD-pork categories. These results were also correlated with means described in work Adzitey and Nurul (2011).

Water binding capacity (WBC) is parameter useful for characterization of meat quality. WBC was higher in DFD pork than in normal and exudative pork samples (Figure 2). Low WBC in PSE pork and high WBC in DFD pork were noticed in study of Poznyakovskiya et al. (2015).

According to microstructural studies, the smallest diameter of muscle fibers was noticed in exudative pork sample – a 39.7 μm . Obtained result corresponded to low WBC value. Diameter of muscle fibers in normal pork was 45.5 μm , while in DFD – 48.3 μm .

Proteomic study (1D electrophoresis) revealed noticeable differences in fractional composition of meat with various qualities, mainly in the range of from 15 kDa to 40 kDa. Thus, fractions intensity of meat with PSE characteristics was relatively less than in DFD and NOR meat (Figure 3). Revealed results correlated with the data observed

Poznyakovskiya et al. (2015) and Shipulin (2009), but noticed differences in treks were detected till 50kDa.

Proteomic analysis of *Sus scrofa* muscle tissue showed the presence of tissue-specific proteins nature (Figure 4, Table 1). Intensity of pyruvatekinase (58.0 kDa) reduced in meat with PSE characteristics compared with NOR, while in DFD meat this fraction was almost absent. Intensity of creatine kinase M-type (41.0 kDa) and glyceraldehyde-3-phosphate dehydrogenase (34.0 kDa) uniformly decreased from NOR till DFD. Adenylate kinase isoenzyme 1 isoform X2 (21,0 kDa) was most noticeable in PSE meat compared with NOR and DFD meat, while intensity of myosin regulatory light chain 2 and skeletal muscle isoform (15,0 kDa), on the contrary, was less. Luca et al. (2013) also identified such pork muscle proteins as creatine kinase M-type, adenylate kinase and alpha-enolase, but did not describe its intensity according to type of autolysis in pork.

The effect of autolysis on cathepsin D, calpain 3 and myoglobin levels in pork with different quality defects was also evaluated. It was shown that 24 h after the slaughter the highest content of cathepsin D was observed in PSE pork ($82.16 \pm 3.30 \text{ ng}\cdot\text{mL}^{-1}$) and was higher NOR and DFD by 22.2% ($p < 0.05$) and 41.4% ($p < 0.05$), respectively. Cathepsin D level in DFD pork was lower than in normal

Table 1 The results of mass spectrometric identification (MALDI-TOF/MS and MS/MS) of protein fractions in *Sus scrofa* samples with different post-mortem autolytic changes.

No.	Protein name; (Gene symbol)	S/M/C*	mM/pI** (experiment)	mM/pI** (calculation)
1	pyruvate kinase PKM isoform X6 (PKM2)	242/92/82	58.0/6.80	58.0/7.62
2	alpha-enolase (ATP5A1)	368/51/85	52.0/5.80	47.0/6.44
3	creatine kinase M-type (CKM)	234/66/	41.0/6.60	43.0/6.61
4	glyceraldehyde-3-phosphate dehydrogenase (GPDH)	399/60/82	34.0/7.30	35.8/8.51
5	adenylate kinase isoenzyme 1 isoform X2 (AK1)	264/32/83	21.0/6.70	21.6/8.38
6	myosin regulatory light chain 2, skeletal muscle isoform (HUMMLC2B)	452/47/88	15.0/4.65	19.0/4.90

Note:

*S/M/C – traditional identification indicators adopted in the English literature: Score – indicator of conformity or "scorecard"; Match peptides – the number of matched peptides; Coverage – % coverage of the entire amino acid sequence of the protein by identified peptides.

** mM/pI (experiment) – scores obtained as a result of electrophoretic mobility on the DE and mM/pI (calculation) – estimates made based on amino acid sequence data with consideration of signal peptide removal, but with no consideration of other post-synthetic modifications using the ExpASy Compute pI/Mw tool software.

Table 2 Cathepsin D, calpain 3 and myoglobin levels in pork *M. longissimus. dorsi* (PSE, NOR, DFD).

	Cathepsin D, $\mu\text{g}\cdot\text{mL}^{-1}$	Calpain 3, $\text{ng}\cdot\text{mL}^{-1}$	Myoglobin, $\text{ng}\cdot\text{mL}^{-1}$
PSE	82.16 \pm 3.30*,+	1.280 \pm 0.082+	3.973 \pm 0.506*
NOR	67.24 \pm 1.61+,#	1.135 \pm 0.042	2.306 \pm 0.152+,#
DFD	58.12 \pm 3.62*,#	1.014 \pm 0.059#	3.672 \pm 0.528*

Note:

* – Significant difference when compared with NOR meat ($p < 0.05$); # – Significant difference when compared with PSE meat ($p < 0.05$); + – Significant difference when compared with DFD meat ($p < 0.05$).

meat by 13.6% ($p < 0.05$) (Table 2). Flores and Toldra (2014) in their work published results concerning cathepsins and calpains activity. They observed that the activity of autolytic enzymes depended on pork type.

Analysis of peptide composition of PSE-, NOR-, DFD-pork categories showed that the least number of peptides was noticed in PSE pork, while the greatest number of low molecular weight compounds was revealed in DFD pork. Presumably, observed data is a result of high activity of proteolytic enzymes in PSE meat, which maintain a dynamic balance. The main differences between the types of meat were observed in areas of more than 1000 Da, in ranges 600-700Da and 900- 999Da. Moreover, PSE pork was characterized by absence of peptides with molecular weight more 1000Da. In all pork categories 28 constant peptides were found. By the way, 8 specific peptides were detected in exudative pork. 14 – in normal and 18 – in DFD.

CONCLUSION

The comparative study of *Sus scrofa* muscle tissue with different defects of quality was carried out. It was revealed that pH, water-binding capacity and microstructural studies were correlated. Thus, low pH value as well as low WBS corresponded to smaller muscle fiber diameter.

Proteins of *Sus scrofa* muscle tissue for all quality defects were separated and characterized, 6 fractions of them were identified. Moreover, 8 specific peptides were detected in

PSE pork, 14 – in NOR and 18 – in DFD. It was shown that the highest content of cathepsin D was observed in PSE pork (82.16 \pm 3.30 $\text{ng}\cdot\text{mL}^{-1}$) and was higher NOR and DFD by 22.2% ($p < 0.05$) and 41.4% ($p < 0.05$), respectively. Since the study was carried out on samples of meat 24 hours after slaughter, this work had the prospect to further study of meat with different defects of quality during long-term autolysis.

REFERENCES

- Adzitey, F., Nurul, H. 2011. Pale Soft Exudative (PSE) and Dark Firm Dry (DFD) Meats: Causes and measures to reduce these incidences. *International Food Research Journal*, vol. 18, p. 11-20.
- Barbut, S., Sosnicki, A.A., Lonergan, S. M., Knapp, T., Ciobanu, D. C., Gatcliffe, L. J., Huff-Lonergan, E., Wilson, E. W. 2008. Progress in reducing the pale, soft and exudative (PSE) problem in pork and poultry meat. *Meat science*, vol. 79, no. 1, p. 46-63. <https://doi.org/10.1016/j.meatsci.2007.07.031> PMID:22062597
- Bazhov, G. M., Kryshopt, E. A., Baranikov A. I. 2013. Technological characteristics of pork with PSE and DFD defects. *Scientific journal KubGAU*, vol. 89, p. 973-984.
- De Almeida, A. M., Bendixen, E. 2012. Pig proteomics: a review of a species in the crossroad between biomedical and food sciences. *Journal of Proteomics*, vol. 75, no. 14, p. 4296-4314. <https://doi.org/10.1016/j.jprot.2012.04.010> PMID:22543283

Flores, M., Toldra, F. 2014. Optimization of Muscle Enzyme Colorimetric Tests for Rapid Detection of Exudative Pork Meats. *Food Analytical Methods*. vol. 7, no. 9, p. 1903-1907. <https://doi.org/10.1007/s12161-014-9834-6>

Kopeikina, L. V., Chudzickaya, E. V. 2005. The study of quality and safety of pork. *Eastern Federal University. Economics and management*, no. 2, p. 54-60.

Kovalyov, L. I., Shishkin, S. S., Kovalyova, M. A., Ivanov, A. V., Vostrikova, N. L., Chernukha, I. M. 2013. Proteomic study of proteins in pork and meat products. *All about meat*, vol. 3, p. 32-34.

Laemmli, U. K. 1970. Cleavage of Structural Proteins during the Assembly of the Head of Bacteriophage T4. *Nature*, vol. 227, p. 680-685. <https://doi.org/10.1038/227680a0> PMID:5432063

Luca, A. D., Elia, G., Hamill, R., Mullen, A. M. 2013. 2D DIGE proteomic analysis of early post mortem muscle exudate highlights the importance of the stress response for improved water-holding capacity of fresh pork meat. *Journal of Proteomics*, vol. 13, no. 9, p. 1528-1544. <https://doi.org/10.1002/pmic.201200145> PMID:23456991

O'Farrell, P. H. 1975. High resolution two-dimensional electrophoresis of proteins. *The Journal of Biological Chemistry*, vol. 250, no. 10, p. 4007-4021.

Poznyakovskiy, V. M., Gorlov, I. F., Tikhonov, S. L., Shelepov, V. G. 2015. About the quality of meat with PSE and DFD properties. *Foods and Raw Materials*, vol. 3, no. 1, p. 104-110. <https://doi.org/10.12737/11244>

UniProtKB, 2002-2016. Protein Knowledgebase [online] s.a. [cit. 2017-01-17] Available at: <http://www.uniprot.org>.

Shipulin, V. I. 2009. *Principles of the development of alternative variants of rational technologies of meat products of new generation with adapted food additives*, Avt. diss. Dr. technical sciences, Stavropol, Russia. p. 44.

Acknowledgments:

This work was supported by the Russian Science Foundation (project No. 16-16-10073).

Contact address:

Irina M. Chernukha, The V. M. Gorbatov All-Russian Meat Research Institute, Experimental-clinical research laboratory of bioactive substances of animal origin, 109316, Talalikhina st., 26, Moscow, Russia, E-mail:imcher@inbox.ru

Liliya V. Fedulova, The V. M. Gorbatov All-Russian Meat Research Institute, Experimental-clinical research laboratory of bioactive substances of animal origin, 109316, Talalikhina st., 26, Moscow, Russia, E-mail:fedulova@vniimp.ru

Anastasia G. Akhremko, The V. M. Gorbatov All-Russian Meat Research Institute, Experimental-clinical research laboratory of bioactive substances of animal origin, 109316, Talalikhina st., 26, Moscow, Russia, E-mail: ahremko94@gmail.com

Elena A. Kotenkova, The V. M. Gorbatov All-Russian Meat Research Institute, Experimental-clinical research laboratory of bioactive substances of animal origin, 109316, Talalikhina st., 26, Moscow, Russia, E-mail:lazovlena@yandex.ru



SPECIES OF GENERA *BOTRYTIS*, *FUSARIUM* AND *RHIZOPUS* ON GRAPES OF THE SLOVAK ORIGIN

Dana Tančinová, Zuzana Mašková, Ľubormír Rybárik, Viera Michalová

ABSTRACT

Our research was focused to identify the *Botrytis*, *Fusarium* and *Rhizopus* species from grapes of the Slovak origin. A further goal of the project was to characterize the toxinogenic potential of chosen strains of species *Fusarium*. 50 samples of grapes, harvested in years 2011, 2012 and 2013 from various wine-growing regions were analyzed in this study. For the isolation of species the direct plating method was used: a) surface-sterilized berries (using 1% freshly pre-prepared chlorine) b) berries and c) damaged berries on DRBC (Dichloran Rose Bengal Chloramphenicol agar). For each analysis were used 50 berries (or all damaged berries from sample). The cultivation was carried at $25 \pm 1^\circ\text{C}$, for 5 to 7 days in dark. After incubation, the colonies of *Botrytis*, *Fusarium* and *Rhizopus* were transferred to identification media and after incubation strains were identified to species level. Thirteen species of fusaria (*F. acuminatum*, *F. avenaceum*, *F. culmorum*, *F. equiseti*, *F. graminearum*, *F. oxysporum*, *F. proliferatum*, *F. semitectum*, *F. solani*, *F. sporotrichioides*, *F. subglutinans*, *F. tricinctum* and *F. verticillioides*) were identified. Frequency of fusaria isolation was 92%. *Botrytis cinerea* was determined from 86% samples and *Rhizopus* from 94%. Chosen strains of species of genus *Fusarium* were able to produce following mycotoxins: deoxynivalenol, T-2 toxin, HT-2 toxin and diacetoxyscirpenol in *in vitro* conditions as determined by thin-layer chromatography. Thirty-two (68%) of tested isolates of *Fusarium* species were able to produce at least one mycotoxin.

Keywords: *Botrytis*; *Fusarium*; *Rhizopus*; grapes; trichothecenes

INTRODUCTION

Grapes have a complex microbial ecology including filamentous fungi, yeasts and bacteria with different physiological characteristics and effects upon wine production (Barata et al., 2012). Moulds commonly isolated from grapes are *Alternaria*, *Cladosporium* and *Botrytis cinerea*, the latter causing bunch rot. Pathogenic and opportunistic species of *Fusarium*, *Penicillium* and *Aspergillus* can also colonize inducing grape disease (Oliveri and Catara, 2011).

The concern about filamentous fungi in the vineyard has traditionally been linked to spoilage of grapes due to fungal growth. The main fungus responsible for grape rot is *Botrytis cinerea*, a pathogen that damages the berries and had a detrimental effect on the organoleptic properties (Serra et al., 2006). *Botrytis* is a common genus in the temperate zones, where it occurs mainly as a pathogen on a variety of plant crops. Vegetable and small berry fruits are particularly susceptible. Invasion may occur before maturity or postharvest, both in transport and in storage. Onions and other allium species and grapes are the most susceptible crops. In the latter, it is notable that the disease is sometimes encouraged. Grapes affected by *Botrytis*, in

this circumstance called “the noble rot”, are used in the production of certain high quality sweet wines in France, Germany, Australia and other countries (Pitt and Hocking, 2009).

Rhizopus stolonifer is one of the most common and fastest-growing species in the *Zygomycota* phylum. Disease caused by this fungus is known as soft rot, black mould and *Rhizopus* rot (Bautista-Baños et al., 2014). *Rhizopus* rot is common on soft fruits, more abundant in warm, humid climates than in cool climate viticulture. In several fruits and crops such as strawberry, tomato, cucumber and table grapes *Rhizopus* rot causes soft rot during transport and storage (Kassemeyer and Berkelmann-Löhnertz, 2009).

Fusarium species are renowned for their role as plant pathogens, causing a wide range of diseases such as vascular wilts, root and stem rots, pre- and post-emergence blight and many others (Pitt and Hocking, 2009).

Our research was focused to identify the *Botrytis*, *Fusarium* and *Rhizopus* species from grapes of the Slovak origin. A further goal of the project was to identify the toxinogenic potential of chosen strains of species *Fusarium*.

MATERIAL AND METHODOLOGY

Samples

Fifty samples of wine grapes, harvested in years 2011, 2012 and 2013 from various wine-growing regions of Slovakia, from small and medium-sized vineyards were analysed.

Slovak wine region is characterized as a territory of the Slovak Republic, where grapes are grown. It is divided

into 6 viticulturally regions, which are divided into 40 wine area and 690 wine-growing villages. The samples which were analysed were taken from all viticulturally regions (Table 1).

White and red grape varieties were analysed. White grape: Chardonnay (4), Grüner Veltliner (5), Müller Thurgau (1), Riesling (3), Velsch Riesling (7), Pálava (1), Pinot blanc (2), Pinot gris (2), Sauvignon (2), Tramin (2), Zala gyöngye (1) and grape using for special Tokay vine

Table 1 List of analysed samples of grapes and their origin.

Number of sample	Town or willage	Wine-growing area	Vineyard region	Variety
1.	Báb	Šintavský	Nitra	Chardonnay
2.	Nitra	Nitriansky	Nitra	Velsch Riesling
3.	Oponice	Radošínský	Nitra	Chardonnay
4.	Beladice	Zlatomoravecký	Nitra	Velsch Riesling
5.	Vinodol	Vrábeľský	Nitra	Chardonnay
6.	Komjatice	Žitavský	Nitra	Riesling
7.	Čaka	Želiezovský	Nitra	Velsch Riesling
8.	Nová Dedina	Tekovský	Nitra	Grüner Veltliner
9.	Brhlovce	Pukanecký	Nitra	Pinot Blanc
10.	Hontianske Moravce	Hontiansky	Central Slovak	Konkordia
11.	Gbelce	Strekovský	Southern Slovak	Velsch Riesling
12.	Mužla	Štúrovský	Southern Slovak	Velsch Riesling
13.	Pribeta	Hurbanovský	Southern Slovak	Riesling
14.	Veľký Krtíš	Modrokamenský	Central Slovak	Pinot Gris
15.	Veľký Krtíš	Modrokamenský	Central Slovak	Pinot Noir
16.	Veľký Krtíš	Modrokamenský	Central Slovak	Sauvignon
17.	Modra	Modranský	Small Carpathian	Pinor Blanc
18.	Zeleneč	Trnavský	Small Carpathian	Cabernet Sauvignon
19.	Báb	Šintavský	Nitra	Tramin
20.	Báb	Šintavský	Nitra	Blaufrankise
21.	Svätý Martin	Senecký	Small Carpathian	André
22.	Doľany	Dolanský	Small Carpathian	Pinot Noir
23.	Doľné Orešany	Orešanský	Small Carpathian	Blaufrankise
24.	Dvorníky	Hlohovecký	Small Carpathian	Sauvignon
25.	Pezinok	Pezinský	Small Carpathian	Blaufrankise
26.	Moravany nad Váhom	Vrbovský	Small Carpathian	Grüner Veltliner
27.	Vinica	Vinický	Central Slovak	Blaufrankise
28.	Šahy	Ipel'ský	Central Slovak	Zala gyöngye
29.	Sebechleby	Hontiansky	Central Slovak	Saint Laurent
30.	Gajary	Záhorský	Small Carpathian	André
31.	Skalica	Skalický	Small Carpathian	Blaufrankise
32.	Zeleneč	Trnavský	Small Carpathian	Cabernet Sauvignon
33.	Nové Zámky	Palárikovský	Southern Slovak	Grüner Veltliner
34.	Abrahám	Galanstký	Southern Slovak	Velsch Riesling
35.	Čamovce	Fil'akovský	Central Slovak	Pálava
36.	Rimavská Sobota	Gemerský	Central Slovak	Blaufrankise
37.	Kráľ	Tornaľský	Central Slovak	Müller Thurgau
38.	Orechová	Sobranecký	Eastern Slovak	Pinot Gris
39.	Vinné	Michalovský	Eastern Slovak	Grüner Veltliner
40.	Streda na Bodrogom	Kráľovsko-chlmecký	Eastern Slovak	Tramin
41.	Hrušov	Moldavský	Eastern Slovak	Alibernet
42.	Viničky	Tokajský	Tokaj	Furmint
43.	Viničky	Tokajský	Tokaj	Lipovina
44.	Viničky	Tokajský	Tokaj	White Frontignan
45.	Bratislava - Rača	Bratislavský	Small Carpathian	Riesling
46.	Bratislava - Rača	Bratislavský	Small Carpathian	Blaufrankise
47.	Stupava	Stupavský	Small Carpathian	Grüner Veltliner
48.	Nesvady	Komárňanský	Southern Slovak	Velsch Riesling
49.	Veľký Meder	Dunajsko-Stredský	Southern Slovak	Chardonnay
50.	Šamorín	Šamorínsky	Southern Slovak	Blaufrankise

Table 2 Preparation of the chromatographic plates before visualisation of the diacetoxyscirpenol (DAS), deoxynivalenol (DON), HT-2 toxin (HT-2) and T-2 toxin (T-2) and the manifestation of visualization.

Mycotoxin	Chromatographic plate preparation	Visualisation under UV light with a wavelength of 366 nm
DAS, DON	<ul style="list-style-type: none"> • application of 20% AlCl₃ in 60% ethanol • heating-up 	light blue fluorescent spot
HT-2, T-2	<ul style="list-style-type: none"> • application of 20% H₂SO₄ in water • heating-up for 8 min. at 130 °C 	green-blue fluorescent spot

Furmit (1), White Frontignan (1) and Lipovina (1). Red grape: Alibernet (1 sample), André (2 samples), Blaufrankise (8), Cabernet Sauvignon (2), Konkordia (1), Pinot noir (2), Saint Laurent (1). Informations about analysed samples are shown in Table 1. Samples (3 kg) were collected at the time of technological ripeness. Picked grapes were stored at 4 ± 1 °C and analysed within 24 h after harvest.

Mycological analysis

For the isolation of *Botrytis* sp., *Fusarium* sp. and *Rhizopus* sp. was used the method of direct plating berries: surface-sterilized berries, non-sterilized and damaged berries on DRBC (Dichloran Rose Bengal Chloramphenicol agar) (Biolife, Italia) according Samson et al. (2002).

The endogenous mycobiota was determined by the method of direct placing of superficially sterilized berries on agar plates (Samson et al., 2002). More than 50 pieces of undamaged berries from each sample were superficially sterilized (using 1% freshly pre-prepared chlorine). Sterilization was carried out for 2 minutes. Berries were rinsed 3 times with sterile distilled water and dried on sterile filter paper. Exactly 50 berries from each sample

were placed on DRBC plates (Samson et al., 2002). The total mycobiota (non-sterilized berries) was determined by the method of direct placing of grape berries on DBRC plates, also. Only the undamaged berries were used for analysis. For determination fungal colonization of damaged berries all berries (from 7 to 15 berries from sample) with some evident defect were used. Berries from each sample were placed on DRBC plates.

Cultivation lasted from 5 to 7 days in darkness at 25 ± 1 °C (in the all cases).

Grown micromycetes were classified into the genera and then isolated by reinoculation on the identification nutrient media and identified through macroscopic and microscopic observation in accordance with accepted mycological keys and publications.

Identification of *Fusarium* species

Potato Dextrose agar (PDA) (Samson et al., 2002) was used for observation of colony characteristics. “Synthetischer nährstoffarmer agar” (SNA) (Samson et al., 2002) was used for micromorphological features. Cultures were incubated at the room temperature and natural light. Species identification was done after 10 days according to Leslie and Summerell (2006), Nelson et al.



Figure 1 *Botrytis cinerea*

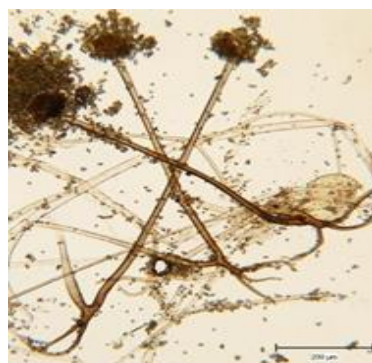

Figure 2 *Rhizopus stolonifer*

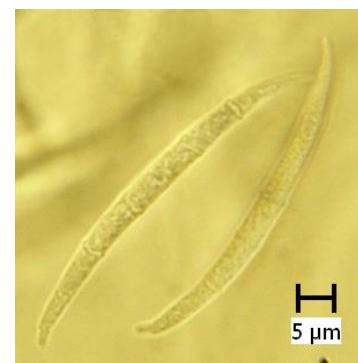

Figure 3 *Fusarium proliferatum* (macroconidia)



Figure 4 *Fusarium proliferatum* (conidiophores and microconidia)



Figure 5 *Fusarium sporotrichioides* (microconidia and mesoconidia)



Figure 6 *Fusarium solani*

(1983), Pitt and Hocking (2009) and Samson et al. (2002, 2010).

CYA (Czapek yeast extract agar) (Samson et al., 2002) and MEA (Malt extract agar) (Biomark, India) were used for species identification of *Botrytis*. Species identification was done after 10 days cultivation at 20 ± 1 °C according to Samson et al. (2002, 2010) and Pitt and Hocking (2009).

Obtained results were evaluated and expressed in isolation frequency (Fr) at the species level. The isolation frequency (%) was defined as the percentage of samples within which the species occurred at least once. These values were calculated according to González et al. (1996) as follows:

$$Fr (\%) = (ns / N) \times 100$$

Where: ns = number of samples with a species; N = total number of samples.

Mycotoxins screening by a modified agar plug method

For the determination of toxigenity a modified agar plug method using thin-layer chromatography according to the Samson et al. (2002), modified by Labuda and Tančínová (2006) was used. A total of 47 randomly selected strains of the *F. acuminatum*, *F. culmorum*, *F. equiseti*, *F. graminearum*, *F. oxysporum*, *F. proliferatum*, *F. semitectum*, *F. sporotrichioides* (the most important species according to their occurrence), *F. tricinctum* and *F. verticillioides* were re-inoculated on

YES (yeasts extract agar) (Samson et al., 2002), cultured in the dark at a temperature of 25 ± 1 °C from 7 to 14 days and then tested for the ability to produce mycotoxins deoxynivalenol (DON), diacetoxyscirpenol (DAS), HT-2 toxin (HT-2) and T-2 toxin (T-2). From the grown colonies squares of the approximate size 2 x 2 cm were cut and put them in small chunks to Eppendorf tube with 1 ml of extraction reagent chloroform : methanol, 2 : 1 (for DON) and acetonitrile (Fischer, Slovakia) : water, 50 : 50 (for DAS, HT-2, T-2). After a 5 minute mixing the extract was applied to the chromatographic plate (Alugram®SIL G, Macherey – Nagel, Germany). Subsequently, developing solution toluene : acetone : methanol (5 : 3 : 2) (Centralchem, Slovakia) were used. Before visualisation, chromatographic plates were processed as is given in Table 2. Mycotoxins were confirmed by comparison with standards (Merck, Germany) under UV light with a wavelength of 366 nm.

RESULTS AND DISCUSSION

Botrytis cinerea and *Erysiphe necator* are among the most relevant fungi in viticulture (Lopez Pinar et al., 2016). *Botrytis cinerea* (Figure 1) was identified in 86% of samples in our research (Table 3, 4). Significant difference was observed in the number of isolates from Tokaj viticulturally region. From 3 samples from this region were isolated 257 isolates and only 187 isolates from 47 samples from other regions. The grapes from Tokaj viticulturally region are used for production of typical

Table 3 List of the isolated moulds of genera *Botrytis*, *Fusarium* and *Rhizopus* from wine grapes berries of the Slovak origin, isolated from berries, berries superficially sterilized and damaged berries.

Isolated species	Number of positive samples	Number of isolates	Isolation frequency (%)
<i>Botrytis cinerea</i>	1, 2, 3, 5, 6, 7, 8, 9, 11, 12, 13, 14, 15, 16, 18, 19, 20, 21, 22, 23, 24, 25, 26, 27, 31, 32, 33, 35, 36, 37, 38, 39, 40, 41, 42*, 43*, 44*, 45, 46, 47, 48, 49, 50	183 +257*	86
<i>F. acuminatum</i>	18, 24, 25, 32, 35, 40	18	12
<i>F. avenaceum</i>	6, 9, 12, 19, 24, 31, 37, 41	26	16
<i>F. culmorum</i>	9	13	2
<i>F. equiseti</i>	1, 3, 4, 5, 6, 13, 20, 28, 33, 40, 46, 50	42	24
<i>F. graminearum</i>	1, 3, 5, 19, 20, 28, 30, 48	21	16
<i>F. oxysporum</i>	7, 11, 12, 16, 17, 19, 20, 28, 30, 39, 48	43	22
<i>F. proliferatum</i>	11, 22, 23, 26, 27, 28, 29, 30, 31, 32, 33, 34, 35, 37, 39, 40, 41, 44*, 49	97 +1*	38
<i>F. semitectum</i>	8, 10, 18, 20, 24, 26, 34, 46	12	16
<i>F. solani</i>	18, 24, 31, 47	46	8
<i>F. sporotrichioides</i>	3, 5, 7, 8, 10, 11, 14, 15, 19, 25, 27, 28, 30, 31, 32, 33, 34, 40, 41, 45, 46, 47, 48, 49, 50	63	50
<i>F. subglutinans</i>	1, 7, 20, 29	27	8
<i>F. tricinctum</i>	4, 8, 12, 22, 29, 50	38	12
<i>F. verticillioides</i>	4, 12, 22, 29, 50	9	10
<i>F. sp.</i>	1, 3, 4, 5, 6, 7, 8, 9, 10, 11, 12, 13, 14, 15, 19, 20, 21, 23, 24, 25, 26, 27, 28, 29, 30, 31, 32, 33, 34, 35, 36, 37, 39, 40, 41, 44*, 46, 47, 48, 49, 50	48	82
<i>Fusarium together</i>	1, 3, 4, 5, 6, 7, 8, 9, 10, 11, 12, 13, 14, 15, 16, 17, 19, 20, 21, 22, 23, 24, 25, 26, 27, 28, 29, 30, 31, 32, 33, 34, 35, 36, 37, 38, 39, 40, 41, 44*, 45, 46, 47, 48, 49, 50	504	92
<i>Rhizopus</i>	1, 2, 3, 5, 7, 8, 9, 10, 11, 12, 13, 14, 15, 16, 17, 18, 19, 20, 21, 22, 23, 24, 25, 26, 27, 28, 29, 30, 31, 32, 33, 34, 35, 36, 37, 38, 39, 40, 41, 43*, 44*, 45, 46, 47, 48, 49, 50	356 +17*	94

Note: * – samples and isolates from Tokaj viticulturally region.

Table 4 Species of *Botrytis*, *Fusarium* and *Rhizopus* isolated from berries of the Slovak origin determined by using plate direct method on DRBC agar from 50 samples.

Species	Superficially sterilized berries	Berries without sterilization	Damaged berries
<i>Botrytis cinerea</i>	183 +257*	354 +334*	210 +79*
<i>F. acuminatum</i>	4	10	4
<i>F. avenaceum</i>	16	9	1
<i>F. culmorum</i>	7	4	2
<i>F. equiseti</i>	41	1	
<i>F. graminearum</i>	5	13	3
<i>F. oxysporum</i>	18 +1*	22	2
<i>F. proliferatum</i>	14	63	21
<i>F. semitectum</i>	3	8	1
<i>F. solani</i>	39	7	
<i>F. sporotrichioides</i>	3	49	11
<i>F. subglutinans</i>	21	2	4
<i>F. tricinctum</i>	35	3	
<i>F. verticillioides</i>	4	4	1
<i>Fusarium</i> sp.	16	25	7
<i>Rhizopus stolonifer</i>	89	217	67

Note: *F.* – *Fusarium*, * - isolates from Tokaj viticulturally region.

Table 5 Potential ability of *Fusarium* species isolates to produce mycotoxins in *in vitro* conditions, tested by TLC method.

Species	Number of tested isolates	Number of isolates without the production of mycotoxins	Mycotoxins			
			DAS	DON	HT-2 toxin	T-2 toxin
<i>F. acuminatum</i>	1	1	0			
<i>F. culmorum</i>	1	1				
<i>F. equiseti</i>	2	1		1		
<i>F. graminearum</i>	2	0	2		2	2
<i>F. oxysporum</i>	1	0			1	1
<i>F. proliferatum</i>	15	10	2		1	3
<i>F. semitectum</i>	2	1			1	1
<i>F. sporotrichioides</i>	20	0	8		11	15
<i>F. tricinctum</i>	1	0	1			
<i>F. verticillioides</i>	2	1	1			

Note: *F.* – *Fusarium*, TLC – thin layer chromatography, DON – deoxynivalenol, DAS – diacetoxyscirpenol.

sweet wine – Tokaj. It was confirmed by high incidence of isolates of *Botrytis cinerea* in the grapes from this region. “Noble rot” is a historic term indicating the *Botrytis cinerea* stage of development in grapes that has a positive impact on the overall quality of particular wines that include the famous sweet white wines (Tosi et al., 2012). On the other hand, an uncontrolled growth of the pathogen in the vineyard causes losses in wine production. Undesirable effects of *Botrytis* growth then decrease the quality and quantity of grapes available for winemaking. As a result of the damaging infection, the wine making process is complicated by the formation of a haze of white wines and oxidative browning of red wines (Perutka et al., 2016). According to Tournas and Katsoudas (2005) *Botrytis cinerea* is one of the most common fungi spoiling grapes and Felšöciová et al. (2015) reported occurrence of genus *Botrytis* in 71% of samples of grapes from Small Carpatian area.

R. stolonifer (Table 3, Table 4 and Figure 2) was identified in 94% of samples in our research. Isolates of *R. stolonifer* were detected in undamaged grape berries, and during storage or transport can be source of soft rot. *R.*

stolonifer develops on mature berries in the field, during storage at temperatures above 8 °C and during shelf-life. It was isolated from naturally contaminated soils throughout the year, and from fruits. The airborne spore population increased in vineyards at the time of fruit maturation and was related to the proximity of stone-fruit orchards. The size of this population was highly correlated with disease incidence and thus may be a satisfactory tool for disease prediction. Intact young berries were more resistant than mature ones to *Rhizopus* inoculation, in both the vineyard and in the laboratory (Lisker et al., 1996).

Thirteen species of fusaria (*F. acuminatum*, *F. avenaceum*, *F. culmorum*, *F. equiseti*, *F. graminearum*, *F. oxysporum*, *F. proliferatum* (Figure 2 and Figure 3), *F. semitectum*, *F. solani* (Figure 5), *F. sporotrichioides* (Figure 4), *F. subglutinans* *F. tricinctum* and *F. verticillioides*) were identified (Table 3 and Table 4) (48 isolates were not determinate to the species level). Serra et al. (2005) shown that *Fusarium* strains were primarily detected at the early maturation stages of grapes, with and without surface disinfection. Isolation frequency of *Fusarium* was very high – 92%. Isolates were detected

from superficially sterilized berries (227 isolates), berries without sterilization (220) and damaged berries (57). Occurrence of species of genus *Fusarium* reported: Bellí et al. (2006) from Spanish regions, Serra et al. (2006) from Portuguese vineyards, Magnoli et al. (2003) from Mendoza (region of Argentina), Tournas and Katsoudas (2005) from local supermarkets in the Washington DC area, Chunmei et al. (2013) from Shaanxi province (China), Lorenzini and Zapparoli (2015) and Lorenzini et al. (2016) from Northern Italy, too. According to these authors, species of *Fusarium* are not classified like dominant mycobiota of grapes.

Mycotoxins are abiotic hazards produced by certain fungi that can grow on a variety of crops (Marin et al., 20013). Mycotoxin risk in the grape product chain is primarily due to ochratoxin A occurrence in wine and dried vine fruits (Somma et al., 2012). The regulation levels in food products are established at 10 µg.kg⁻¹ in dry grapes (EC No. 472/2002), 2 µg.kg⁻¹ in must and wine (EC No. 123/2005). Ochratoxin A is a secondary metabolite produced by filamentous fungi of the two genera *Aspergillus* and *Penicillium* present in a wide variety of foodstuffs (Amézqueta et al., 2012; Vega et al., 2012). These two genera are main genera responsible for mycotoxin production in grapes (Serra et al., 2006).

Species of genus *Fusarium* are important producers of mycotoxins, too. Serra et al. (2005) reported that species described as producers of mycotoxins represented 8.0% of the grape mycobiota, distributed as follows: potential producers of aflatoxins (0.3%), ochratoxin A (6.0%), patulin (0.5%) and trichothecenes (1.2%). Selected isolates (47) of ten species were tested for their ability to produce relevant mycotoxins - trichothecenes in *in vitro* condition, by means of thin-layer chromatography. The results are presented in Table 5. Thirty-two (68%) of tested isolates were able produce at least one mycotoxin. All isolates of *F. sporotrichioides* were able to produce some mycotoxin in *in vitro* conditions. Isolates of potential producers of mycotoxins can produce more than one mycotoxin. 11 isolates of *F. sporotrichioides* produced T-2 toxin and HT-2 toxin, 4 isolates T-2 toxin, HT-2 toxin and diacetoxyscirpenol. *F. graminearum* (2 tested isolates) produced T-2 toxin, HT-2 toxin and diacetoxyscirpenol.

CONCLUSION

From 2500 surface-sterilized berries, 2500 berries without sterilization and 550 damaged berries (50 samples) wine grape berries were isolated 440 strains of *Botrytis cinerea*, 504 strains of *Fusarium* spp. and 373 strains of *Rhizopus stolonifer*. Significant difference was observed in the number of strains of *Botrytis cinerea* from Tokaj viticulturally region (3 samples – 257 strains) to another samples (47 samples – 183 strains). Chosen strains of species of genus *Fusarium* were able to produce following mycotoxins: deoxynivalenol, T-2 toxin, HT-2 toxin and diacetoxyscirpenol in *in vitro* conditions by means of thin-layer chromatography. In another research would be advisable to follow occurrence of these mycotoxins in grapes, must, wine and another products from grapes.

REFERENCES

- Amézqueta, S., Schorr-Galindo, S., Murillo-Arbizu, M., González-Peñas, E. 2012. OTA-producing fungi in foodstuffs: A review. *Food Control*, vol. 26, no. 2, p. 259-268. <https://doi.org/10.1016/j.foodcont.2012.01.042>
- Barata, A., Malfeito-Ferreira, M., Loureiro, V. 2012. The microbial ecology of wine grape berries. *International Journal of Food Microbiology*, vol. 153, no. 3, p. 243-259. <https://doi.org/10.1016/j.ijfoodmicro.2011.11.025>
- Bautista-Baños, S., Bosquez-Molina, E., Barrera-Necha, L. L. 2014. *Rhizopus stolonifer* (soft rot). In Bautista-Baños, S. *Postharvest Decay*. Amsterdam, Netherland : Elsevier, p. 1-44. <https://doi.org/10.1016/B978-0-12-411552-1.00001-6>
- Bellí, N., Bau, M., Marin, S., Abarca, M. L. Ramos, A. J., Bragulat, M. R. 2006. Mycobiota and ochratoxin A producing fungi from Spanish wine grapes. *International Journal of Food Microbiology*, vol. 111, suppl. no. 1, p. S40-S45.
- Chunmei, J., Junling, S., Qi'an, H., Yanlin, L. 2013. Occurrence of toxin-producing fungi in intact and rotten table and wine grapes and related influencing factors. *Food Control*, vol. 31, no. 1, p. 5-13. <https://doi.org/10.1016/j.foodcont.2012.09.015>
- Commission Regulation (EC) No. 472/2002 of 12 March 2002 amending Regulation (EC) No. 466/2001 setting maximum levels for certain contaminants in foodstuffs.
- Commission Regulation (EC) No. 123/2005 of 26 January 2005 amending Regulation (EC) No. 466/2001 as regards ochratoxin A.
- Felšöciová, S., Tančinová, D., Rybárik, E., Mašková, Z., Kačániová, M. 2015. Mycobiota of Slovak wine grapes with emphasis on *Aspergillus* and *Penicillium* species in the Small Carpatian area. *Potravinárstvo*, vol. 9, no. 1, p. 501-508. <https://dx.doi.org/10.5219/529>
- González, H. H. L., Pacin, A., Resnik, S. L., Martinez, E. J. 1996. Deoxynivalenol and contaminant mycoflora in freshly harvested Argentinean wheat in 1993. *Mycopathologia*, vol. 135, no. 2, p. 129-134. <https://doi.org/10.1007/BF00436463>
- Kassemeyer, H. H., Berkelmann-Löhnertz, B. 2009. Fungi of grapes. In König, H. et al. *Biology of Microorganisms on Grapes, in Must and in Wine*. Berlin, Germany : Heidelberg : Springer – Verlag, p. 61-87. https://doi.org/10.1007/978-3-540-85463-0_4
- Labuda, R., Tančinová, D. 2006. Fungi recovered from Slovakian poultry feed mixtures and their toxinogenicity. *Annals of Agricultural and Environmental Medicine*, vol. 13, no. 2, 193-200. [PMid:17195991](https://pubmed.ncbi.nlm.nih.gov/17195991/)
- Leslie, J. F., Summerell, B. A. 2006. *The Fusarium Laboratory Manual*. Australia : Blackwell Publishing, 388 p. ISBN 978-0-8138-1919-8. <https://doi.org/10.1046/j.1365-3059.1996.d01-10.x>
- Lisker, N., Keren-Shacham, Z., Sarig, P., Zutkhi, Y., Ben-Aire, R. 1996. The biology and pathology of the fungus *Rhizopus stolonifer*, cause of black mould disease of table grapes in Israel. *Plant Pathology*, vol. 45, no. 6, p. 1099-1109. <http://dx.doi.org/10.1046/j.1365-3059.1996.d01-10.x>
- Lopez Pinar, A., Rauhut, D., Ruehl, E., Buettner, A. 2016. Effects of *Botrytis cinerea* and *Erysiphe necator* fungi on the aroma character of grape must: A comparative approach. *Food Chemistry*, vol. 207, p. 251-260. <https://doi.org/10.1016/j.foodchem.2016.03.110> [PMid:27080903](https://pubmed.ncbi.nlm.nih.gov/27080903/)
- Lorenzini, M., Zapparoli, G. 2015. Occurrence and Infection of *Cladosporium*, *Fusarium*, *Epicoccum* and

- Aureobasidium* in withered rotten grapes during post-harvest dehydration. *Antonie van Leeuwenhoek*, vol. 108, no. 5, p. 1171-1180. <https://doi.org/10.1007/s10482-015-0570-8> PMID:26459338
- Lorenzini, M., Cappello, M. S., Logrieco, A., Zapparoli, G. 2016. Polymorphism and phylogenetic species delimitation in filamentous fungi from predominant mycobiota in withered grapes. *International Journal of Food Microbiology*, vol. 238, p. 56-62. <https://doi.org/10.1016/j.ijfoodmicro.2016.08.039> PMID:27591387
- Magnoli, C., Violante, M., Combina, M., Palacio, G., Dalcerro, A. 2003. Mycoflora and ochratoxin-producing strains of *Aspergillus* section *Nigri* in wine grapes in Argentina. *Letters in Applied Microbiology*, vol. 37, no. 2, p. 179-184. <https://doi.org/10.1046/j.1472-765X.2003.01376.x>
- Marin, S., Ramos, A. J., Cano-Sancho, G., Sanchis, V. 2013. Mycotoxins: Occurrence, toxicology, and exposure assessment. *Food and Chemical Toxicology*, vol. 60, p. 218-237. <https://doi.org/10.1016/j.fct.2013.07.047>
- Nelson, P. E., Toussoun, T. A., Marasas, W. F. O. 1983. *Fusarium species. An illustrated manual for identification*. USA : The Pennsylvania State University. 193 p. ISBN 0-271-00349-9.
- Oliveri, C., Catara, V. 2011. Mycoflora and biodiversity of black *Aspergilli* in vineyard eco-systems. In Grillo, O. et al. *The Dynamical Processes of Biodiversity – Case Studies of Evolution and Spatial Distribution*. Rijeka, Croatia : InTech, p. 259-276. ISBN 978-953-307-772-7. <https://doi.org/10.5772/24611>
- Perutka, Z., Šufeisl, M., Strnad, M., Šebela, M. 2016. Protein profiling of a white wine produced from grapes damaged by *Botrytis cinerea*. *New Biotechnology*, vol. 33, p. 180. <https://doi.org/10.1016/j.nbt.2016.06.1346>
- Pitt, J. I., Hocking, A. D. 2009. *Fungi and food spoilage*. 3rd ed. London, New York : Springer Science & Business Media, LLC, 519 p. ISBN 978 0-387-92206-5. <https://doi.org/10.1016/j.ijfoodmicro.2010.08.005>
- Samson, R. A., Houbraken, U., Thrane, U., Frisvad, J. C., Andersen, B. 2010. *Food and Indoor Fungi*. Utrecht, Netherlands : CBS-KNAW Fungal Biodiversity Centre, 390 p. ISBN 978-90-70351-82-3.
- Samson, R. A., Hoekstra, E. S., Frisvad, J. C., Filtenborg, O. 2002. Introduction to food- and airborne fungi. Utrecht, Netherlands : Centraalbureau voor Schimmelcultures. 389 p. ISBN 90-70351-42-0. <https://doi.org/10.5580/104b>
- Serra, R., Braga, A., Venâncio, A. 2005. Mycotoxin-producing and other fungi isolated from grapes for wine production, with particular emphasis on ochratoxin A. *Research in Microbiology*, vol. 156, no. 4, p. 515-521. <http://dx.doi.org/10.1016/j.resmic.2004.12.005>
- Serra, R., Lourenço, A., Alípio, P., Venâncio, A. 2006. Influence of the region of origin on the mycobiota of grapes with emphasis on *Aspergillus* and *Penicillium* species. *Mycological research*, vol. 110, no. 8, p. 971-978. <https://doi.org/10.1016/j.mycres.2006.05.010>
- Somma, S., Perrone, G., Logrieco, A. 2012. Diversity of black *Aspergilli* and mycotoxin risk in grape, wine and dried vine fruits. *Phytopathologia*, vol. 51, no. 1, p. 131-147.
- Tosi, E., Fedrizzi, B., Azzolini, M., Finato, F., Simonato, B., Zapparoli, G. 2012. Effects of noble rot on must composition and aroma profile of Amarone wine produced by the traditional grape withering protocol. *Food Chemistry*, vol. 130, no. 2, p. 370-375. <https://doi.org/10.1016/j.foodchem.2011.07.053>
- Tourmas, V. H., Katsoudas, E. 2005. Mould and yeast flora in fresh berries, grapes and citrus fruits. *International Journal of Food Microbiology*, vol. 105, no. 1, p. 11-17. <https://doi.org/10.1016/j.ijfoodmicro.2005.05.002>
- Vega, M., Ríos, G., von Baer, D., Mardones, C., Tessini, C., Herlitz, E., Saelzer, R., Ruiz, M. A. 2012. Ochratoxin A occurrence in wines produced by Chile. *Food Control*, vol. 28, no. 1, p. 147-150. <https://doi.org/10.1016/j.foodcont.2012.04.032>

Acknowledgments:

This work was supported by Research Center AgroBioTech built in accordance with the project Building Research Centre „AgroBioTech" ITMS 26220220180 and KEGA 015SPU-4/2015.

Contact address:

Dana Tančinová, Slovak University of Agriculture, Faculty of Biotechnology and Food Sciences, Department of Microbiology, Tr. A. Hlinku 2, 949 76 Nitra, Slovakia, E-mail: dana.tancinova@uniag.sk

Zuzana Mašková, Slovak University of Agriculture, Faculty of Biotechnology and Food Sciences, Department of Microbiology, Tr. A. Hlinku 2, 949 76 Nitra, Slovakia, E-mail: zuzana.maskova@uniag.sk

Ľubomír Rybárik, Báb 49, 951 34 Báb, Slovakia, E-mail: alcedo1245@gmail.com

Viera Michalová, Slovak University of Agriculture, Faculty of Biotechnology and Food Sciences, Department of Microbiology, Tr. A. Hlinku 2, 949 76 Nitra, Slovakia, E-mail: x.michalova@is.uniag.sk



EFFECT OF COCOA FAT CONTENT ON WETTING AND SURFACE ENERGY OF CHOCOLATE

Lubomír Lapčík, Barbora Lapčíková, Hana Žižková, Li Peng, Viera Vojteková

ABSTRACT

The aim of this study was the quantification of the effect of the cocoa fat content on the wetting characteristics and surface free energy of different chocolate compositions. On the market, there are many different types of chocolate products which differ both in the sensory and physico-chemical properties together with their raw material compositions and the contents of the individual components. This paper focuses on differences in the use of different types of fats – cocoa butter, milk fat, equivalents or cocoa butter substitutes in chocolate products. Studied samples (prepared at Carla, Ltd. Company) were followed by static contact angles of wetting measurements and by calculated surface free energies. There were investigated the effects of fat content and used fat types of the chocolate products on their final wettabilities and resulting surface free energies. There was found a linear dependence between total fat content and the surface free energy, which was gradually increasing with increasing fat content. Additionally, there were performed TG DTG and NIR spectrometry measurements of the tested materials with the aim to determine the melting point of studied fats used, as well as to determine and identify individual fat components of chocolate products which may affect the resulting value of surface free energy.

Keywords: chocolate; cocoa fat; surface energy; wetting

INTRODUCTION

Chocolate is unique as a food in that fact which is solid at normal room temperatures however it melts easily in the mouth. Since the properties of the main fat component, cocoa butter, is essentially solid at temperatures below 25 °C when it holds all the solid sugar and cocoa particles together. However, this fat is almost entirely liquid at body temperature, enabling the particles to flow past one another, thus the chocolate becomes a smooth liquid by heating in the mouth.

The first known cocoa plantations were established by the Maya in the lowlands of south Yucatan about 600 AD. Cocoa trees were being grown by the Aztecs of Mexico and the Incas of Peru when the Europeans discovered the Central America. The beans were highly prized and used as money as well as to produce a drink known as chocolatl.

In 1828 Van Houten developed the cocoa press which was quite remarkable, as his entire factory was manually operated at the time (Becket, 2008). The cocoa bean cotyledons (known as cocoa nibs) were pressed to produce a hard “cake” with about half the fat removed. This was milled into a powder, which could be used to produce a much less fatty drink. In order to make this powder disperse better in the hot water or milk, the Dutch treated the cocoa beans during the roasting process with an alkali liquid. This has subsequently become known as the Dutching process. By changing the type of alkalis-

agent, it also became possible to adjust the colour of the cocoa powder.

Almost twenty years after the invention of the press in 1847, the first British factory to produce a plain eating chocolate was established in Bristol in the UK by Joseph Fry. Unlike Van Houten, Fry used the recently developed steam engines to power his factory. In order for the chocolate to feel smooth on the tongue when it melts in the mouth, the solid non-fat particles must be smaller than 30 µm. The chocolates made by Fry and Peter were ground using granite rollers, but still had a gritty texture. This was because of the presence of some large particles and some groups of particles joined together to form agglomerates, also because the fat was not coating the particles very well. In addition, the chocolate tended to taste bitter because of the presence of some acidic chemicals.

In 1880 Rodolphe Lindt, in his factory in Berne in Switzerland, invented a machine which produced a smoother, better tasting chocolate (Becket, 2008). This machine was known as a conche, because its shape was similar to the shell with that name. It consisted of a granite trough, with a roller, normally constructed of the same material, which pushed the warm liquid chocolate backwards and forwards for several days. This broke up the agglomerates and some of the larger particles and coated them all with fat. Meanwhile, moisture and some

acidic chemicals were evaporated into the air, producing a smoother, less astringent tasting chocolate.

When two or more fats are mixed together, it is important that the final chocolate sets at a suitable rate and more importantly, that it has the correct texture and melting properties in the mouth.

Cocoa butter equivalents to be able to be added to cocoa butter without having a eutectic effect, the vegetable fat must crystallise in the same way as cocoa butter. Cocoa butter contains palmitic, stearic and oleic acids on a glycerol backbone. The fat manufacturer has therefore to obtain these different fractions from different sources and then blend them. The palmitic oleic acids are the easiest to find as they are a major component of palm oil, which is obtained from the palm (*Eleaeis guineensis*) widely grown in Malaysia.

Chocolate and cocoa products are a rich source of flavonoids, where 100 g of unsweetened cocoa powder can contain up to 250 mg of flavonols (Godočiková et al., 2016).

Chocolate production technological procedures, the composition of the base chocolate matter and the storage conditions (generally thermal history) are affecting the final product quality e.g. by formation of blooming defects (Macháľková et al., 2015). A wide range of technological processes (e.g. cleaning, dyeing or gluing) depends on “how well” the liquid wets the surface of solid material. The term wetting and non-wetting as employed in various practical situations tend to be defined in terms of the effect desired. Usually, however, wetting means that the contact angle between a liquid and a solid is zero or so close to zero that the liquid spreads over the solid easily, and non-wetting means that the angle is greater than 90°, so that liquid tends to ball up and run off the surface easily. Contact angle of wetting is a result of the balance of three vectors acting on the three-phase line among solid, liquid and vapour, namely solid surface energy γ_{sv} , liquid surface energy γ_{lv} , and solid-liquid tension γ_{sl} . This exhibits an equilibrium contact angle that can be expressed by Young’s equation (Gajdošíková, Lapčíková & Lapčík, 2011):

$$\gamma_{SG} = \gamma_{SL} + \gamma_{LG} \cdot \cos\theta \quad (1)$$

where γ_{SG} and γ_{LG} are the surface tension of a solid and the surface tension of a liquid in the equilibrium with the liquid vapour, respectively, γ_{SL} interfacial tension between the liquid and solid, and θ is the equilibrium contact angle. It is to be pointed out that γ_{SG} is not the surface tension of the solid (γ_S in vacuum); the difference in between is referred as the spreading pressure π_e :

$$\pi_e = \gamma_S - \gamma_{SG} \quad (2)$$

An assumption was made to neglect the vapour adsorption for low surface tension solids, e.g. polymers, $\gamma_S = \gamma_{SG}$.

According to the Fowkes, the surface energy is separated into its components:

$$\gamma = \gamma^C + \gamma^I + \gamma^D + \gamma^{AB} + \gamma^H + \dots \quad (3)$$

where $\gamma^D, \gamma^P, \gamma^H, \gamma^I$ and γ^{AB} are the contributions from London disperse forces, polar (Keesom forces, hydrogen-bonding forces, induction (Debye) forces, and acid-base interactions, respectively. Based on these assumptions, the following equation has been proposed, which is applicable to systems in which only dispersion forces are common to both phases:

$$\gamma_{12} = \gamma_1 + \gamma_2 - 2\sqrt{\gamma_1^D \cdot \gamma_2^D} \quad (4)$$

where subscripts 1 and 2 represent phases 1 and 2, respectively. Applying Equation (4) to a solid-liquid interface in given:

$$\gamma_{SL} = \gamma_S + \gamma_L - 2\sqrt{\gamma_S^D \cdot \gamma_L^D} \quad (5)$$

If π_e is assumed to be small and $\gamma_{LV} \approx \gamma_L$, γ_S can be eliminated by combining Equation (5) and Equation (1):

$$\cos\theta = 1 - 2\sqrt{\frac{\gamma_{SV}^D \gamma_{LV}^D}{\gamma_{LV}}} \quad (6)$$

Then the value of $\sqrt{\gamma_{SV}^D}$ can be calculated from the slope of $\cos\theta$ plotted as a function of $\sqrt{\gamma_{LV}^D / \gamma_{LV}}$. The most recent approach was given by van Oss, Chaudhury and Good (vOCG) (Gajdošíková et al., 2011). According to this method, the surface tension of solid is equal to a sum of two components: γ_S^{LW} , connected with Lifthitz-van der Waals (LW) interactions, and γ_S^{AB} , connected with acid-base (AB) interactions. The dispersion (London), orientation (Keeson), and induction (Debye) forces, being dipolar forces, present the same type dependence on distance and are usually treated with the same combining rules. All these interactions are generally named by the van der Waals contribution (LW). However, the donor-acceptor contribution to the work of adhesion (currently termed acid-base contribution) is associated with the transfer of electrons between an electron donor and an electron acceptor.

$$\gamma_S = \gamma_S^{LW} + \gamma_S^{AB} \quad (7)$$

$$\gamma^{AB} = 2 \cdot \sqrt{\gamma^+ \cdot \gamma^-} \quad (8)$$

where γ_S^+ and γ_S^- are components corresponding to the interactions of the Lewis acid (donor) and base (acceptor), respectively. Hence, the calculation of γ_S consists in the

Table 1 Material compositions of dark chocolates under study.

Sample labelling	Cocoa dry matter content (w. %)	Cocoa butter content (w. %)
Dark basic	44.0 ±1.5	28
Dark 35%	49.0 ±1.5	35
Dark 40%	53.0 ±1.5	40
Dark 45%	57.0 ±1.5	45

Table 2 Material compositions of milk chocolates under study.

Sample labelling	Cocoa dry matter content (w. %)	Cocoa butter content (w. %)	Milk dry matter content (w. %)
Milk basic	32.0 ±1.5	27	3.99
Milk 30%	35.0 ±1.5	30	3.82
Milk 33%	37.0 ±1.5	33	3.66
Milk 36%	40.0 ±1.5	36	3.50

determination of three unknown components: γ_s^{LW} , γ_s^+ and γ_s^- , it is required performing contact angle measurements using different liquids, two of them being polar and one non-polar. Combining Equations 7 and 8 with Young’s equation is given (Gajdošíková et al., 2011):

$$(1 + \cos\theta)\gamma_l = 2\left(\sqrt{\gamma_l^{LW}\gamma_s^{LW}} + \sqrt{\gamma_l^+\gamma_s^-} - \sqrt{\gamma_l^-\gamma_s^+}\right) \quad (9)$$

The vOCG approach to the evaluation of acid-base properties of solid surfaces by contact measurements is undoubtedly the most important development of present-day interface science.

MATERIAL AND METHODOLOGY

Chocolate samples were prepared in CARLA Ltd. (Czech Republic). For dark chocolate preparation, the following raw material compositions were used: sugar, cocoa butter, cocoa mass, dried whey, milk fat, natural cocoa, emulgator (soya lecithine) and flavors. For milk chocolate preparation the following raw material compositions were used: sugar, cocoa butter, cocoa mass, dried whole milk, dried skimmed milk, dried whey, lactose, emulgator (soya lecithine) and flavors.

The magnitude of the contact angle θ , between the liquid and solid can be determined by various methods. The selection of the method to be used depends on the character of the studied sample system, as well as on the accuracy required. The two most common methods are: a static measurement of sessile drop by See System with CCD camera and a dynamic Wilhelmy plate method. The static contact angle of wetting was measured by a sessile drop resting on a flat solid surface using a video camera equipped and interfaced to a computer with image-analysis

software to determine the tangent value precisely on the captured image. De-ionised distilled water (conductivity of $0.07 \times 10^{-4} \text{ S.m}^{-1}$) (Watek Demiwa 3ROS, Czech Republic), glycerol (98%, Sigma-Aldrich, USA), diiodomethane (Sigma Aldrich, USA) and ethylene glycol (98%, Sigma-Aldrich, USA) were used as testing liquids for the determination of dispersive and polar components of surface energy as well as for Lifshitz-van der Waals contributions.

Thermogravimetry (TG) and differential thermal analysis (DTA) experiments were performed on simultaneous DTA-TG apparatus (Shimadzu DTG 60, Japan). Throughout the experiment, the sample temperature and weight-heat flow changes were continuously monitored. The measurements were performed at heat flow rate of $10^\circ\text{C}/\text{min}$ in the static air atmosphere at the temperature range from 30°C to 300°C .

Near infra red spectra (NIR) were recorded on ParticuLAB NIR spectrometer (Harrer & Kassen, Germany).

All measurements were done at least in four replicates, each measurement was repeated at least $5 \times$. Data were analysed using one way analysis of variance (ANOVA) method (Microsoft Excel, USA). These analysis allowed to detect the significance of the effect of fat content addition as well as of type of the fat used on contact angles of wetting results. For all tested samples combinations the observed differences were of high statistical significance ($p \leq 0.05$).

RESULTS AND DISCUSSION

Process of the migration of the cocoa butter fat to the surface of chocolate known as “blooming” is strongly affecting overall perception of the final chocolate product by the customers e.g. by the color changes and the creation of the non-uniform color patterns at the chocolate bar

Table 3. Obtained values of the contact angles of wetting for dark chocolates under study as observed for different wetting liquids.

Sample	Mean contact angle of wetting θ_s (°)			
	Water	Glycerol	Ethylene glycol	Diiodomethane
Dark basic	87.3 ±1.5	95.5 ±0.6	75.2 ±1.3	51.2 ±1.5
Dark 35%	81.7 ±1.2	89.4 ±1.8	77.3 ±1.3	57.6 ±2.6
Dark 40%	88.5 ±1.8	93.3 ±2.1	80.0 ±2.5	56.0 ±1.9
Dark 45%	93.8 ±2.3	93.7 ±3.2	79.3 ±1.7	53.0 ±2.3

Table 4. Obtained values of the contact angles of wetting for milk chocolates under study as observed for different wetting liquids.

Sample	Mean contact angle of wetting θ_s (°)			
	Water	Glycerol	Ethylene glycol	Diiodomethane
Milk basic	94.6 ±2.4	89.3 ±2.2	76.6 ±1.2	50.7 ±2.3
Milk 30%	99.8 ±0.9	98.0 ±1.9	73.8 ±1.0	52.6 ±1.6
Milk 33%	91.2 ±1.9	102.4 ±2.5	81.0 ±1.6	47.6 ±2.0
Milk 36%	93.2 ±1.2	90.8 ±1.7	71.8 ±1.6	48.7 ±2.5

Table 5. Results of the calculated surface energies (γ_s) and their standard deviations according to the model Wu - equation of state as observed for tested dark chocolates.

Dark basic				Dark 35%			
Liquid	γ_s	γ_{s-}	γ_{s+}	Liquid	γ_s	γ_{s-}	γ_{s+}
Water	19.95	1.53	1.54	Water	23.85	0.90	1.51
Glycerol	13.09	0.41	0.38	Glycerol	16.35	0.81	2.05
Ethylene glycol	18.94	0.65	1.23	Ethylene glycol	17.85	0.76	0.97
Diiodomethane	33.63	1.62	0.81	Diiodomethane	29.96	1.85	2.02
Dark 40%				Dark 45%			
Liquid	γ_s	γ_{s-}	γ_{s+}	Liquid	γ_s	γ_{s-}	γ_{s+}
Water	19.16	0.94	2.32	Water	15.89	2.12	1.35
Glycerol	14.19	1.79	1.24	Glycerol	14.02	1.77	2.17
Ethylene glycol	16.56	1.30	1.68	Ethylene glycol	16.89	0.99	1.00
Diiodomethane	30.89	1.53	1.37	Diiodomethane	32.58	1.60	2.39

Table 6. Results of the calculated surface energies (γ_s) and their standard deviations according to the model Wu - equation of state as observed for tested milk chocolates.

Milk basic				Milk 30%			
Liquid	γ_s	γ_{s-}	γ_{s+}	Liquid	γ_s	γ_{s-}	γ_{s+}
Water	15.38	1.70	1.66	Water	12.52	0.79	0.42
Glycerol	16.39	1.55	1.98	Glycerol	11.96	1.35	1.34
Ethylene glycol	18.20	0.88	0.74	Ethylene glycol	19.65	0.97	0.35
Diiodomethane	33.90	1.80	2.04	Diiodomethane	32.79	0.94	1.46
Milk 33%				Milk 36 %			
Liquid	γ_s	γ_{s-}	γ_{s+}	Liquid	γ_s	γ_{s-}	γ_{s+}
Water	17.47	1.45	1.96	Water	16.21	0.66	1.43
Glycerol	9.87	1.38	1.28	Glycerol	15.54	0.97	1.61
Ethylene glycol	16.04	1.29	0.91	Ethylene glycol	20.65	1.03	1.43
Diiodomethane	35.62	1.52	1.66	Diiodomethane	35.00	1.51	1.91

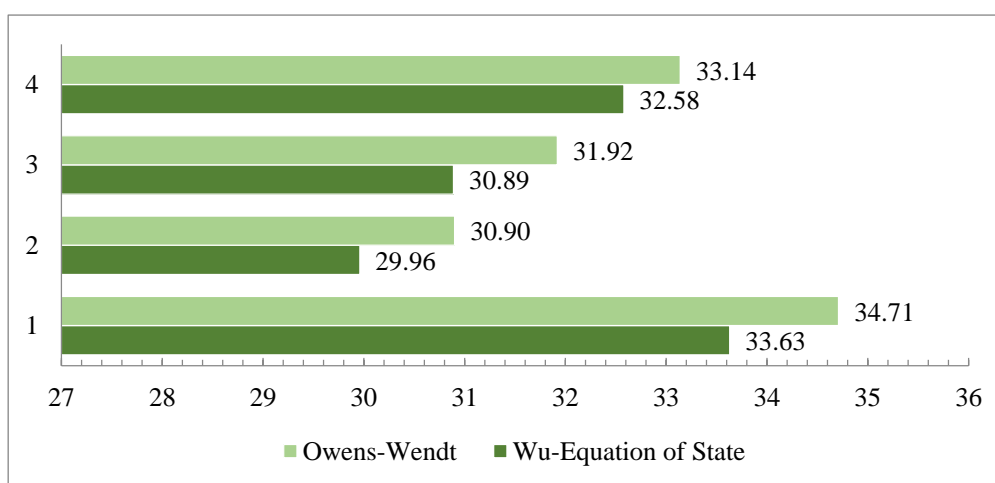

Figure 1. Results of the calculated total surface energies ($\text{mJ}\cdot\text{m}^{-2}$) of studied dark chocolates: 1 – Dark basic. 2 – Dark 35%. 3 – Dark 40%. 4 – Dark 45%.

surface. This phenomenon is strongly dependent on fat composition and the storage conditions (Briones and Aguilera 2005). It was found, that the mechanism of

bloom development is a complex process involving both the phase separation associated with the growth of xenomorphic fat crystals (Kinta and Hatta, 2005). As a

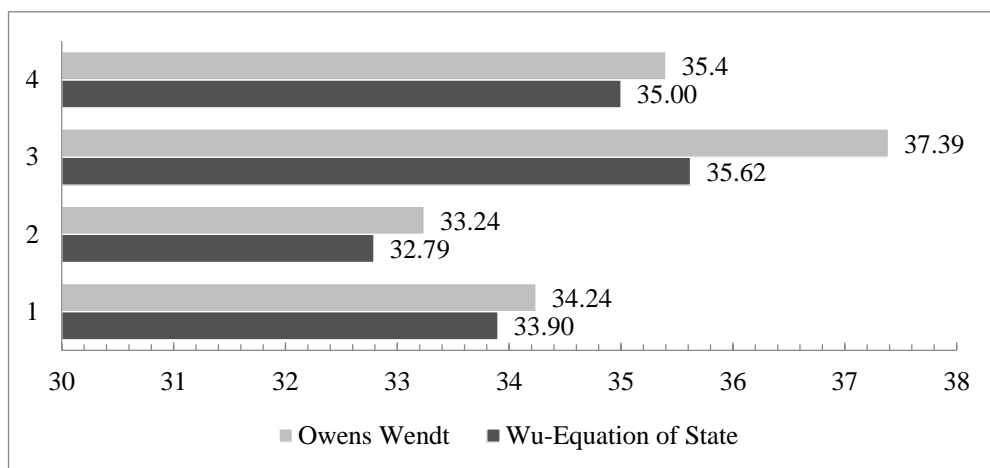

Figure 2. Results of the calculated total surface energies (mJ.m⁻²) of studied milk chocolates: 1 – Milk basic. 2 – Milk 30%. 3 – Milk 33%. 4 – Milk 36%.

Table 7 Results of the thermal analysis of the tested chocolates.

Sample	Heat of fusion (J.g ⁻¹)	T _m (°C)
Dark basic	-16.19	34.63
Milk basic	-22.32	33.60
Dark 35%	-29.61	34.62
Milk 36%	-33.51	33.78

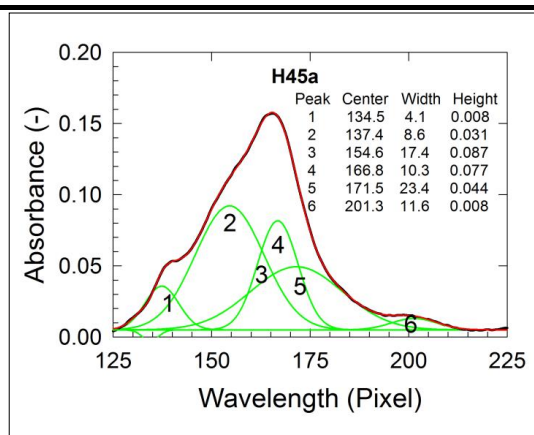

Figure 3. NIR spectrum of Dark 45 % chocolate and its components.

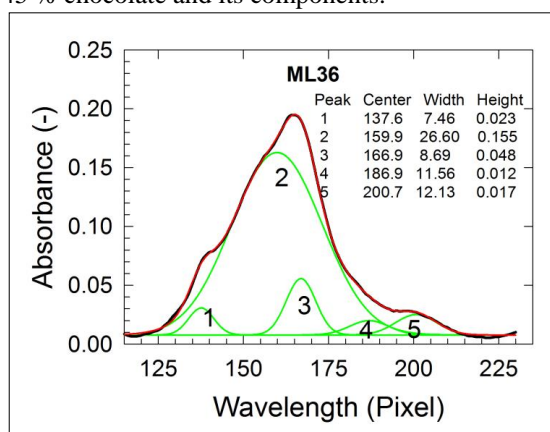

Figure 4. NIR spectrum of Milk 36 % chocolate and its components.

result of the above mentioned phenomena, the resulting surface heterogeneity will be strongly affected and of diverse fassion (Lapčík et al., 2016).

The results of the contact angle of wetting measurements are given in Tables 3 and Table 4. As mentioned in the introduction, surface of the chocolate bar is predominantly hydrophobic due to the presence of the cocoa butter in the

matter. That is why the best wetting was observed for diiodomethane as reflected in the obtained contact angles of wetting ranged approximately from 48 to 51° for milk chocolate, and from 51 to 53° for dark chocolate. The highest magnitudes of the contact angles were obtained for glycerole. Calculated surface energies and their componenets are shown in Table 5 and Table 6. Milk

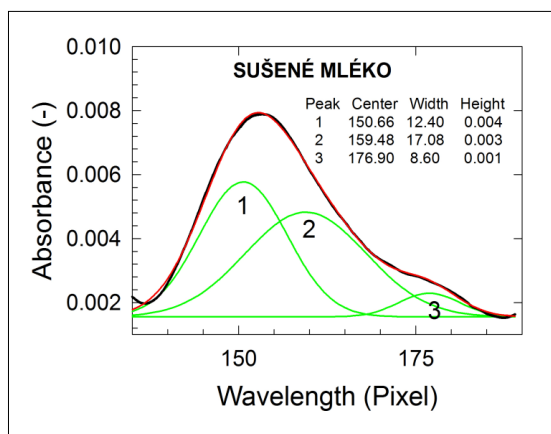

Figure 5. NIR spectrum of powdered skimmed milk and its components.

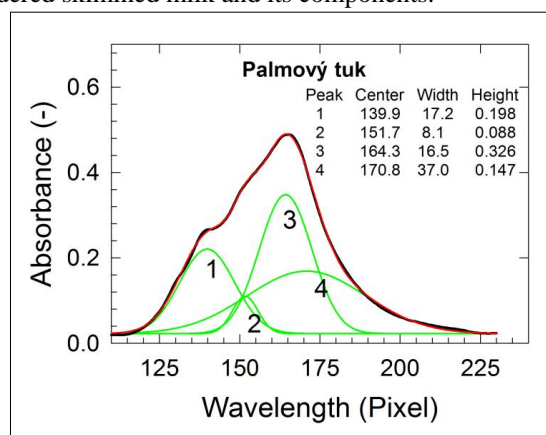

Figure 6. NIR spectrum of pure palm fat and its components.

chocolates contain milk components (milk fat) in comparison with dark chocolates. As studied earlier (Lapčík et al. 2015), milk components are more of hydrophilic nature in comparison with the cocoa ones, that is why their inclusion into the chocolate material composition is increasing their surface energy. This fact is clearly visible from data given in Table 5 and Table 6 and Figure 1 and Figure 2. Exact knowledge of the surface energy and its components for individual chocolate products is a key parameter affecting proper selection of the mould material used for the chocolate bars production. This is due to the fact, that the surface energy of the mould material is a key determining factor of chocolate-mould interaction and has a significant influence on the adhesion of cocoa butter and dark chocolate to the mould (Keijbets et al., 2009). It was found, that the clean demould material should have a surface energy below 30 mJ.m^{-2} and an electron donor component of the surface energy of approximately 15 mJ.m^{-2} . Interestingly, the plotting of the thermodynamic work of adhesion vs. total surface energy is linear function implying the fact, that these two thermodynamic parameters are strongly correlated.

For determination of the melting points of the tested chocolates composition, the thermal analysis was performed by means of thermal gravimetry and differential thermal analysis (TG DTA). Obtained results are summarized in Table 7. Observed melting enthalpies were lower for dark chocolates about -29.61 J.g^{-1} at melting temperature of $34.62 \text{ }^\circ\text{C}$ in comparison to milk chocolates,

where the heat of fusion was found to be -33.51 J.g^{-1} as observed at $33.78 \text{ }^\circ\text{C}$.

For evaluation of the composition of tested chocolates, a NIR spectra were recorded and their absorption bands were deconvoluted to the individual components. As shown in Figures 3 and 4 for an illustration, this technique allows in detail analysis and quantification of individual absorption spectral bands. For interpretation of the observed absorption bands, the palm fat and powder skimmed milk were measured as well as shown in Figure 5 and Figure 6.

CONCLUSION

It was found in this study, that the surface energy of the chocolates is sensitive on basic components composition ratio as well as by the thermal history of the tested chocolate bars. It was confirmed, that the addition of the cocoa fat as well is increasing the dispersive components of the surface energy. In contrary to the latter, the addition of the powdered skimmed milk is increasing the polar components of the surface energy. There was used NIR spectrometry for evaluation of the composition by means of the deconvolution of the individual absorption bands. Thermal analysis show effect of the composition on heats of fusion of the melting point transition, where polar milk components were increasing heat of fusion.

REFERENCES

Beckett, S. T. 2008. *The science of chocolate*. 2nd ed. Cambridge, UK : RSC Publishing. 240 p. ISBN 0854049703.

Briones, V., Aguilera, J. M. 2005. Image analysis of changes in surface color of chocolate. *Food Research International*, vol. 38, no. 1, p. 87-94. [doi:http://dx.doi.org/10.1016/j.foodres.2004.09.002](http://dx.doi.org/10.1016/j.foodres.2004.09.002)

Gajdošíková, R., Lapčíková, B., Lapčík, L. 2011. Surface phenomena and wetting of porous solids. *Physical Chemistry*, vol. 6, no. 3, p. 146-162.

Godočiková, L., Ivanišová, E., Árvay, J., Petrová, J., Kačániová, M. 2016. The comparison of biological activity of chocolates made by different technological procedures. *Potravinárstvo*, vol. 10, no. 1, p. 316-322. [doi:http://dx.doi.org/10.5219/628](http://dx.doi.org/10.5219/628)

Keijbets, E. L., Chen, J., Dickinson, E., Vieira, J. 2009. Surface energy investigation of chocolate adhesion to solid mould materials. *Journal of Food Engineering*, vol. 92, no. 2, p. 217-225. [doi:http://dx.doi.org/10.1016/j.jfoodeng.2008.11.008](http://dx.doi.org/10.1016/j.jfoodeng.2008.11.008)

Kinta, Y., Hatta, T. 2005. Composition and structure of fat bloom in untempered chocolate. *Journal of Food Science*, vol. 70, no. 7, p. S450-S452.

Lapčík, L., Lapčíková, B., Otyepková, E., Otyepka, M., Vlček, J., Buňka, F., Salek R. N. 2015. Surface energy analysis (SEA) and rheology of powder milk dairy products. *Food Chemistry*, vol. 174, p. 25-30. [doi:http://dx.doi.org/10.1016/j.foodchem.2014.11.017](http://dx.doi.org/10.1016/j.foodchem.2014.11.017)

Lapčík, L., Otyepka, K., Otyepková, E., Lapčíková, B., Gabriel, R., Gavenda, A., Prudilová, B. 2016. Surface heterogeneity: Information from inverse gas chromatography and application to model pharmaceutical substances. *Current Opinion in Colloid & Interface Science*, vol. 24, p. 64-71. [doi:http://dx.doi.org/10.1016/j.cocis.2016.06.010](http://dx.doi.org/10.1016/j.cocis.2016.06.010)

Machálková, L., Hřivna, L., Nedomová, Š., Jůzl, M. 2015. The effect of storage temperature on the quality and formation of blooming defects in chocolate confectionery. *Potravinárstvo*, vol. 9, no. 1, p. 39-47. [doi:http://dx.doi.org/10.5219/425](http://dx.doi.org/10.5219/425)

Acknowledgments:

This work was financially supported by the national budget of the Czech Republic within the research project of the Tomas Bata University in Zlín Internal Grant Agency (grant No.: IGA/FT/2017/004).

Contact address:

Lubomír Lapčík. Department of Food Technology, Faculty of Technology. Tomas Bata University in Zlín, Vavrečkova 275, 762 72 Zlín, Czech Republic, E-mail: lapcik@ft.utb.cz

Barbora Lapčíková. Department of Food Technology, Faculty of Technology. Tomas Bata University in Zlín, Vavrečkova 275, 762 72 Zlín, Czech Republic, E-mail: lapcikova@ft.utb.cz

Helena Žižková. Department of Food Technology, Faculty of Technology, Tomas Bata University in Zlín. Vavrečkova 275, 762 72 Zlín, Czech Republic, E-mail: zizkova@ft.utb.cz

Li Peng. Department of Food Technology, Faculty of Technology, Tomas Bata University in Zlín, Vavrečkova 275, 762 72 Zlín, Czech Republic, E-mail: llippe@hotmail.com.

Viera Vojteková. Institute of chemistry, Pavol Jozef Safarik University in Košice, Moyzesova 11, 040 01 Košice, Slovakia, E-mail: viera.vojtekova@upjs.sk



DEMONSTRATION OF PHYSICAL PHENOMENAS AND SCAVENGING ACTIVITY FROM D-PSICOSE AND METHIONINE MAILLARD REACTION PRODUCTS

Arum Tiyas Suminar, Ahmad Ni'matullah Al-Baarri, Anang Mohamad Legowo

ABSTRACT

Maillard reaction has been well understood as a non-enzymatic reaction between reducing sugars and amino acids to generate the Maillard reaction products (MRPs). This study is aimed to demonstrate the browning intensity, color development, spectra measurements, scavenging activity, and the correlation between browning intensity and scavenging activity of the MRPs generated from D-Psicose and Methionine (Psi-Met) at 50°C. The browning intensity of MRPs was investigated based on the absorbance using spectrophotometer at 420 nm, the color development was observed using digital colorimeter to gained $L^*a^*b^*$ value then calculated as browning index, the spectra development was analyzed using spectrophotometer at 190 – 750 nm, and the scavenging activity was determined with ABTS method using spectrophotometer at 734 nm. The browning intensity, color development, and scavenging activity were improved along with the increase in heating process. Based on spectra analysis, MRPs from Psi-Met was initially detected at 21 h and Psi at 24 h of heating treatment, which indicating that Psi-Met have faster and better reaction than Psi during heating process. Positive non-linear and significant correlation between browning intensity and scavenging activity were assigned. This finding may provide beneficial information of D-psicose and MRPs to the next scientific research and to the food industries which applies MRPs in their products.

Keywords: Maillard reaction products; scavenging activity; browning; D-psicose; methionine

INTRODUCTION

Maillard reaction has been well understood as a non-enzymatic reaction between reducing sugars and amino acids to generate the Maillard reaction products (MRPs). A temperature has been stated as important key for producing MRPs. It has been recognized that significant increase of MRPs were obtained after an increase of temperature from 50 to 60 °C (Alvarenga et al., 2014), thus resulting the conclusion that MRPs was temperature-dependent products. In the other hand, Maillard reaction was relied on the pH of medium. It was stated that increase in pH medium might enhance the reaction of Maillard (Ajandouz and Puigserver, 1999). In several food industries, Maillard reaction products were desirable process to generate the flavour, colour, and antioxidant activity (Phisut and Jirapon, 2013; Hwang et al., 2011). Therefore, several factors in the reaction, which are reactants type and concentration, temperature, heating time, pH, and humidity (Lamberts et al., 2008; Hwang et al., 2011) could not be disregarded. In the case of reactants, aldoses have been well studied as more reactive component with amino acids than ketoses, as well as

pentoses was more reactive than hexoses (Hwang et al., 2011; Phisut and Jirapon, 2013).

D-psicose (Psi) is one of ketohexose which may be produced by the enzymatic reaction using D-tagatose 3-epimerase from D-fructose (Fru) (Kim et al., 2006; Sun et al., 2004). Psi has been categorized as rare sugars since it is scarcely found in nature. Though D-psicose has 70% of the sweetness of sucrose, the reactivity to proteins may produce foods with excellent antioxidant activity and good rheological properties (Oshima et al., 2014; Puangmanee et al., 2008; Sun et al., 2006). While, methionine is an essential amino acid that usually used in the food industry to produce aroma compounds such as cooked potatoes, coffee, or roasted meat, that may lead to contribute to produce MRPs when it has interactions with reducing sugars through thermal conditions (Pfeifer and Kroh, 2010). The previous study from Pfeifer and Kroh (2010) also stated that methionine has great effect on the formation of specific R-dicarbonyl compounds in Maillard reaction.

The non-enzymatic browning reaction derived from methionine and D-glucose has been evaluated previously (Ajandouz and Puigserver, 1999), but based on our

knowledge, few document was found on Maillard reaction products from methionine and D-psicose. The previous research studied browning color intensity of the D-psicose and non-polar amino acids mixtures at high temperature but none was found when the mixture was applied in minimum/low temperature. Therefore, the objectives of this present study is to demonstrate the MRPs generated from Psi and Met at low temperature and our scientific hypothesis is the MRPs of Psi-Met will might have better scavenging activity and physical phenomenas than heated product of Psi. We investigated the browning intensity, color development, spectra measurements, ABTS radical scavenging activity, and the correlation between browning intensity and scavenging activity of MRPs produced by heating process.

MATERIAL AND METHODOLOGY

Materials

Rare sugar of D-psicose and D-fructose were obtained from Kagawa Rare Sugar Research Center, Japan. Methionine (with the purity index 99%) was obtained from Cheil Jedang Indonesia, Co. Ltd. ABTS or 2,2'-azino-bis(3-ethylbenzthiazoline-6-sulfonic acid) was purchased from AppliChem, Germany (Lot No.2X001714). Unless otherwise specified, all other chemicals were reagent grade.

Methodology

Preparation of MRPs model

The preparation method of MRPs model has been adopted from **Yu et al. (2012)** with some modifications. The D-psicose (Psi) as a control and 1 : 1 D-psicose-Methionine (Psi-Met) were dissolved in 500 mL of 10 mM carbonate buffer (pH 9) solution. Two hundred microliter was transferred to 1.5 mL microtube prior to application for heat treatment. The sample was subjected to 48 h heating process at 50 ± 1.0 °C RH 60% using the controlled dry oven. Measurements were performed every three hour in duplicate with three individual replicates of sample on hour 0 up to 24. The applied heating process was 50 °C for 48 hours using controlled dry oven. After heating treatment, the dried sample were cooled immediately in the air for 1 min, and then kept at 4 °C. Prior to measurement, samples were diluted with 200 µL of 10 mM phosphate buffer (pH 7).

Browning intensity

The browning intensity of the MRPs was measured according to the method of **Ajandouz et al. (2001)**. The MRPs samples of Psi-Met and heated product of Psi after heating process were diluted with phosphate buffer until 200 µL in microtube. Browning intensity of the samples were recorded by the MRPs absorbance at 420 nm on a spectrophotometer (UV-1280; Shimadzu, Kyoto, Japan) using a 1 cm path length cell after diluted with distilled water.

Color development

The MRPs samples of Psi-Met and heated product of Psi after heating were diluted with phosphate buffer until 200 µL in microtube. The color changes of MRPs were determined using a digital colorimeter (TES-135A; USA)

to obtain the $L^*a^*b^*$ values. The instrument was calibrated with a standard white before measurement, then the browning index was calculated using the equation (2) (**Alvarenga et al., 2014**).

$$x = \frac{a + 1.75(L)}{5.645(L) + a - 3.012(b)} \quad (1)$$

$$BI = \frac{100(x-0.31)}{0.172} \quad (2)$$

L, a, and b are the values from digital colorimeter, x is the value obtained from equation (1), and BI is the browning index.

Spectroscopic measurements

The MRPs samples of Psi-Met and heated product of Psi after heating were diluted with phosphate buffer until 200 µL in microtube. The samples were measured for emission spectrum (190 – 750 nm) using spectrophotometer (UV-1280; Shimadzu, Kyoto, Japan). This spectroscopic measurement method has been adopted from **Jing and Kitts (2004)**.

ABTS radical scavenging activity

The antioxidant activity of the MRPs was detected using ABTS procedure according to the method of **Hwang et al. (2011)**, with minor modifications. The 7 mM ABTS was diluted with 10 mM phosphate buffer (pH 7.4). These 5 mL of ABTS solution was added with 88 µL of 140 mM potassium persulfate. These mixtures were incubated for 16 hours in the dark condition at room temperature, to reach a final absorbance of 0.7 ± 0.02 at 734 nm. Then, 1 : 9 of MRPs samples mixed with 90% ethanol and ABTS stock solution were loaded in spectrophotometer (UV-1280; Shimadzu, Kyoto, Japan). The percentage inhibition of the MRPs scavenging activity from **Hwang et al. (2011)** was calculated in equation (3).

$$y = \frac{A_0 - A_1}{A_0} \times 100 \quad (3)$$

A₀ is the absorbance with blanko and A₁ is the absorbance with the sample.

The correlation between browning intensity and scavenging activity

The browning intensity and the scavenging activity were analyzed for R² value and linearity by regression analysis. Values of R² should be in a range 0 to 1 and it is close to 1, the positive correlation between browning intensity and scavenging activity should be occurred. This correlation analysis method has been adopted from **Alvarenga et al. (2014)**.

Data analysis

The results were reported in figures. The physical phenomenas and scavenging activity of MRPs were analyzed using descriptive analysis, and the significance of correlation between browning intensity and scavenging activity was analyzed using Graphpad Prism version 6.0. This study was adopted from **Nilsson et al. (2004)** who stated that the significant correlation should be if p value <0.0001.

RESULTS AND DISCUSSION

Browning intensity

The browning of the Maillard reaction model systems was investigated based on the absorbance at 420 nm as a common indicator of MRPs generation (Morales and Jimenez-Perez, 2001). The browning intensity of MRPs on Psi-Met and heated product of Psi as its control are shown in Figure 1. The heating process increased the absorbance of all samples. The previous work on browning conducted by Oshima et al. (2014) showed that the increase in browning intensity was linear with the reaction heating process.

The browning intensity of Psi-Met was higher than Psi, starting from early reaction until final reaction process. This may be explained by the influence of the type of reducing sugar and amino acid involved in the reaction (Laroque et al., 2008). D-psicose has been known as a ketohexose which has good reactivity with amino acids (Brands et al., 2000), while methionine was found to be a

reactive essential amino acid (Ajandouz and Puigserver, 1999). Maillard reaction involving amino acid and sugar resulted in the formation of new compounds, as indicated by browning intensity in our study. A newly formed compound shifted the color into brown (Oh et al., 2016).

It has been understood that pH is an important factor influencing MRPs formation in the model system and it showed conspicuous effects when the model system was applied at pH 8.0 – 10.0 (Ajandouz and Puigserver, 1999). Therefore, the reaction between Psi-Met was applied on pH 9.0 were resulting a greater increase in browning than those from Psi, especially entering the advanced Maillard reaction stage at 36 h. The applied pH at 7.0 in model system showed the negligible differences between Psi-Met and Psi (data not shown). This finding was in agreement with the study from Benjakul et al. (2005), who reported that MRPs derived from an amino acid–sugar complex could be formed more easily in basic pH.

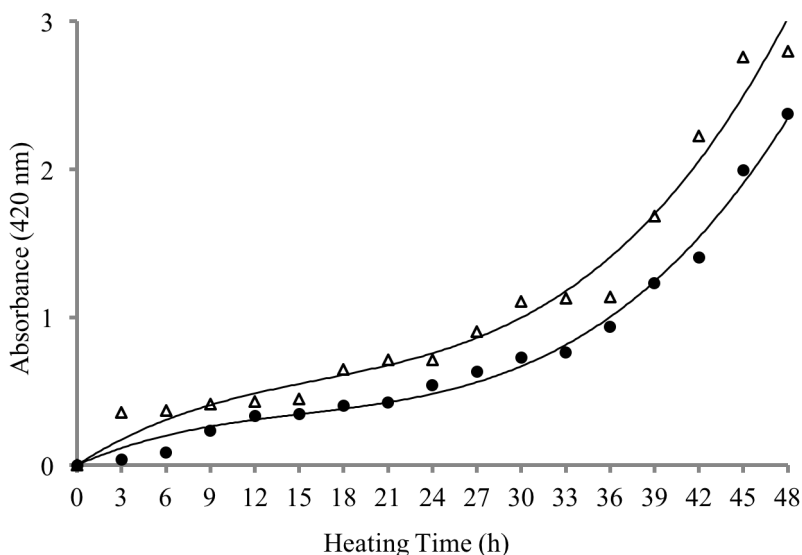

Figure 1 Browning intensity of rare sugar Psi (●) and Psi-Met (Δ) model systems when was heated at 50 °C. The absorbance at 420 nm were measured every 3 h for 48 h.

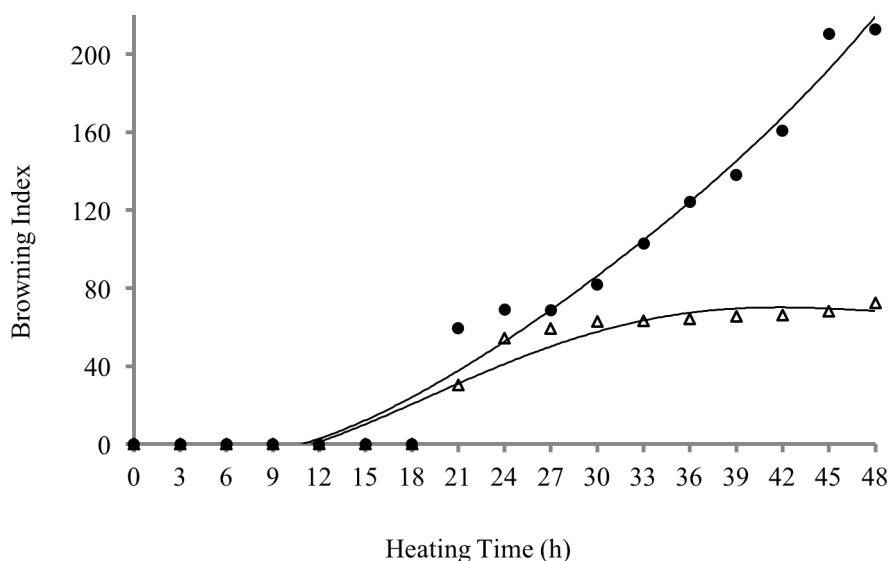

Figure 2 Browning index of rare sugar Psi (●) and Psi-Met (Δ) model systems when was heated at 50 °C. Data were obtained from the equation (2) using L*a*b* values from digital colorimeter.

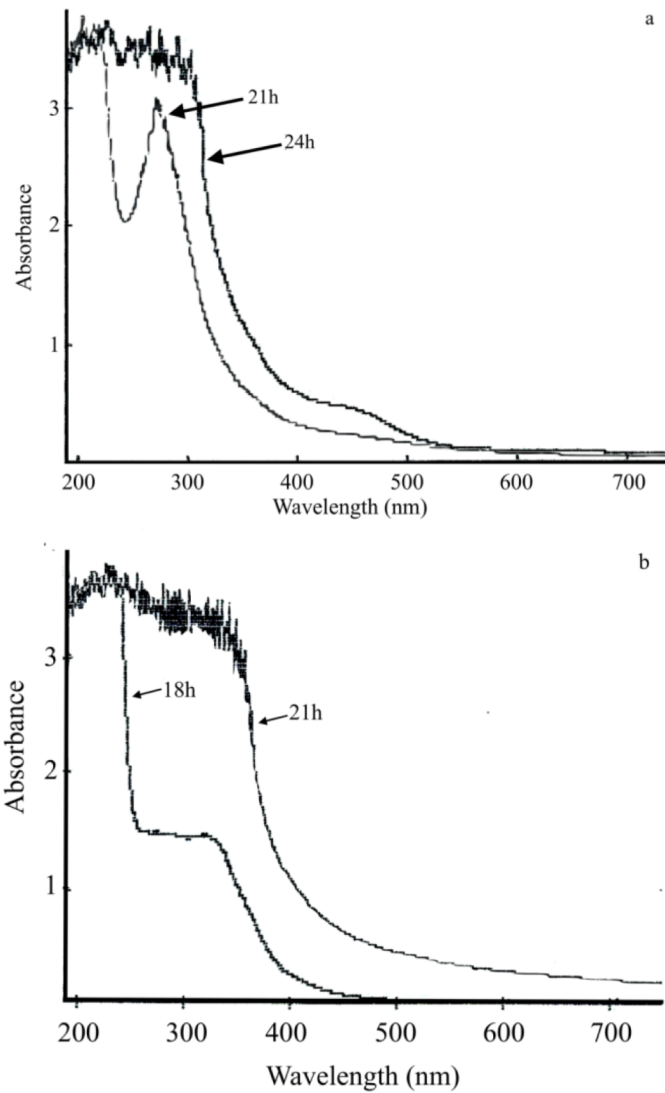

Figure 3 Development of emission spectra 190 – 750 nm of Psi (a) and Psi-Met (b) when was heated at 50 °C for 48 h. The curves for Psi was generated from the heating time 21 and 24th while the curve of Psi-Met was generated from the heating time 18 and 21st.

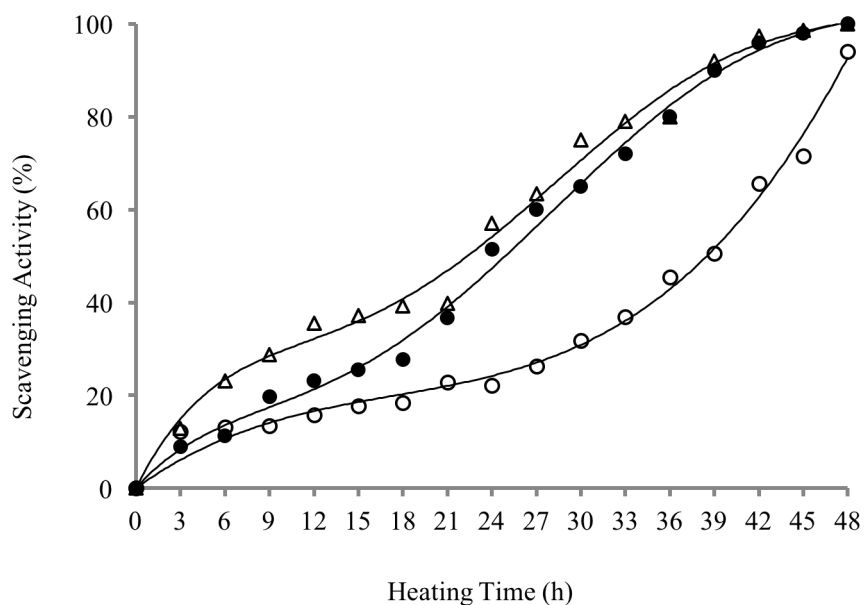

Figure 4 The scavenging activity of Psi (•), Psi-Met (Δ) and Fru-Met (o) model systems when was heated at 50 °C. The scavenging activity were analyzed every 3 h for 48 h by using ABTS method with the wavelength set at 734 nm.

Color development

L*a*b* value is known color development parameter to assess the progress of the Maillard reaction using colorimetry (Morales and van Boekel, 1999; Alvarenga et al., 2014). L* value has been known to indicate the darkness (-) and lightness (+) of the solutions; while a* determines the greenness (-) and the redness (+) of samples; and b* shows blue (on its negative) and yellow (on its positive values). Based on L*a*b* value, the browning index could be determined. Browning index values are the elaborated those tristimulus value using calculation at equation (1) and equation (2). The browning index of Psi and Psi-Met is shown in Figure 2.

As described in Figure 2, the rate of browning index values incline over time indicating that browning index was influenced by duration of heating. The incline of browning index was continued up to 48 h. Nonetheless, Psi had a larger influence on the browning index than Psi-Met. Samples of Psi-Met incubated at 48 h were equally in

browning index as compared to the Psi samples at 27 h.

Browning index gave a remarkable value at 21 h and reached the highest value at 48 h. It suggests that as the longer of the heating process gained, the browning index increased and the development of color as well, therefore the browning index has shown as a good indicator in color development of the MRPs (Alvarenga et al., 2014). This result is related to the study from Bosch et al. (2007), who reported that the browning index increased as the time rose, and at 48 h of heating process were generated the highest browning index value. In addition, the browning index of Psi is entirely two-three times higher than Psi-Met. According to Alvarenga et al. (2014), it was caused by caramelization effect in Psi. Laroque et al. (2008) revealed that browning index cannot be attributed to the sugar caramelization because sugars heated alone failed to generate compounds absorbing at 420 nm.

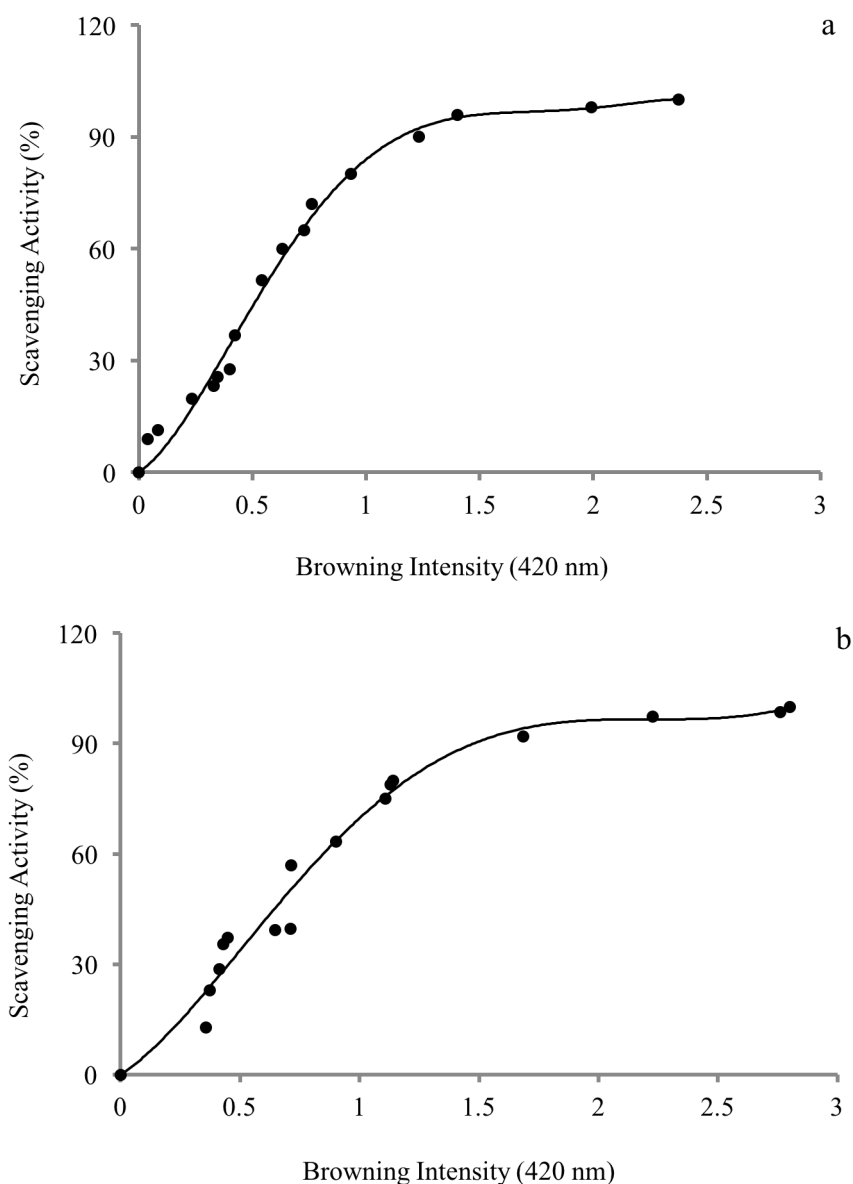

Figure 5 Positive non-linear and significant correlation between browning intensity and scavenging activity of Psi (a) whereas R2 value at 0.9464, *p*-value at <0.0001, and Psi-Met (b) whereas R2 value at 0.9475, *p*-value at <0.0001. Analysis was conducted using GraphPad Prism analysis.

Spectroscopic characteristics of Psi and Psi-Met MRPs

The absorbance range (190 to 750 nm) to investigate the spectroscopic characteristics of Psi and Psi-Met has been associated from the early study (Jing and Kitts, 2004), who observed a similar spectral pattern with a strong absorbance between 250 and 700 nm from sugar–Lys MRPs. The result of spectrum measurement is shown in Figure 3. The MRPs of Psi-Met model was produced characteristically different spectral patterns during the heating process than Psi model. These spectra measurements of MRPs solutions created by the heating process, allowed the detection of changes related to subsequent stages of the Maillard reaction (Jing and Kitts, 2004).

The spectral analysis was done at every three hour (data not presented). The peak obtained from Psi-Met model (Figure 3b) start to changed remarkably at 21 h, while the peak obtained from Psi (Figure 3a) start to change remarkably at 24 h. It defined that the MRPs derived from Psi-Met was produced faster than heated product obtained from Psi. Yet fully, as all the reaction continued to increase, the spectrum change develops as well and reached the highest point at 48 h.

ABTS radical scavenging activity

Antioxidants are specific substances that oxidize themselves and protect other sensitive bioactive food components from destruction. It also restricts and stabilizes the activity of free radicals become less active forms (Bajcan et al., 2016). This antioxidant potency can be analyzed by the scavenging activity. The scavenging activity of this research was observed using ABTS method based on Hwang et al. (2011) at 734 nm spectrophotometer. The scavenging activity can be known from the spectrophotometer then calculated using equation (3). Regarding to the previous result of browning intensity, the development of browning intensity may led the antioxidant activity of MRPs increased as well (Yu et al., 2012; Chen and Kitts, 2008). The scavenging activity of Psi-Met and Psi are shown in Figure 4. The MRPs from Psi-Met was entirely higher than Psi during the whole heating process. It was caused by reducing sugar that react more easily with amino acid in heating condition and produce antioxidant activity. It is in the same agreement with the previous study from Benjakul et al. (2005) who stated that an amino acid with reducing sugar could be formed more easily. It was further indicated that the potential effect of Psi-Met is better than Psi in the antioxidant activity of the Maillard reaction products. In the previous study also noted that the proteins with D-psicose created the remarkable antioxidant capacity compared with alimentary sugars (Sun et al., 2004).

The result also showed that the scavenging activity of Psi was comparable to Psi-Met indicating the strong antioxidant potency of the Psi during the heating process. It might be explained by caramelization effect (Alvarenga et al., 2014). Further study about Maillard reaction on D-fructose and methionine (Fru-Met) showed a slow increase during heating process indicating Psi generated higher antioxidant activity than MRPs product of Fru-Met. This result in line with Zeng et al. (2011) revealed that the

MRPs from D-psicose have better performance than MRPs from D-fructose in the radical-scavenging activity of ABTS. At the advanced stage of Maillard reaction, D-psicose have higher reactivity than D-fructose, since D-fructose is characterised by a much less accessible carbonyl function, which is become the main explanation of its less reactivity (Laroque et al., 2008).

The Correlation between browning intensity and scavenging activity

In this research, we attempted to study the relationship between browning intensity and scavenging activity of Psi and Psi-Met. This correlation analysis has been adopted from Alvarenga et al. (2014), who found a positive lineal correlation ($R^2 = 0.743$) between available amino groups and browning index of glycoprotein samples in Maillard reaction condition. The correlation results of Psi and Psi-Met are shown in Figure 5a and 5b. Both of these correlations shown that the browning intensity and scavenging activity increased as the time increased. A positive non-linear correlation between browning intensity and scavenging activity was found at R^2 value of Psi and Psi-Met: 0.9464 and 0.9475, respectively.

The significance correlation between browning intensity and scavenging activity of Psi and Psi-Met were analyzed as well using GraphPad Prism version 6.0. Both of these results suggested that browning intensity was significantly correlated to scavenging activity ($p < 0.0001$).

CONCLUSION

During the Maillard process to derive MRPs, Psi-Met were showing the better reaction than Psi. The browning intensity, color development, and scavenging activity were improved according to the heating process increased. The MRPs product derived from Psi-Met was able to produce at 21 h proven by spectra measurement. The correlation between browning intensity and scavenging activity were assigned significantly positive non-linear correlation and significant correlation. Essentially, the MRPs derived from Psi-Met have better scavenging activity and physical phenomenas than heated product of Psi. This finding may provide beneficial information of D-psicose to the food industries which applies MRPs in their products.

REFERENCES

- Ajandouz, E. H., Puigserver, A. 1999. Nonenzymatic browning reaction of essential amino acids: effect of pH on caramelization and Maillard reaction kinetics. *Journal of Agricultural and Food Chemistry*, vol. 47, no. 5, p. 1786-1793. <https://doi.org/10.1021/jf980928z>
 PMID:10552453
- Ajandouz, E. H., Tchiakpe, L. S., Ore, F. D., Benajiba, A., Puigserver, A. 2001. Effects of pH on caramelization and Maillard reaction kinetics in fructose-lysine model systems. *Journal of Food Science*, vol. 66, no. 7, p. 926-931. <https://doi.org/10.1111/j.1365-2621.2001.tb08213.x>
- Alvarenga, M. S. M., Rodriguez, E. Y. M., Amezcuita, L. E. G., Olivas, G. I., Flores, P. B. Z., Muniz, C. H. A., Sepulveda, D. R. 2014. Effect of Maillard reaction conditions on the degree of glycation and functional properties of whey protein isolate maltodextrin conjugates. *Food Hydrocolloids*, vol. 38, p. 110-118. <https://doi.org/10.1016/j.foodhyd.2013.11.006>

- Bajcan, D., Vollmannova, A., Simansky, V., Bystricka, J., Trebichalsky, P., Arvay, J., Czako, P. 2016. Antioxidant activity, phenolic content and colour of the Slovak cabernet sauvignon wines. *Potravinarstvo*, vol. 10, no. 1, p. 89-94. <https://doi.org/10.5219/534>
- Benjakul, S., Lertittikul, W., Bauer, F. 2005. Antioxidant activity of Maillard reaction products from a porcine plasma protein-sugar model system. *Food Chemistry*, vol. 93, no. 2, p. 189-196. <https://doi.org/10.1016/j.foodchem.2004.10.019>
- Bosch, L., Alegria, A., Farre, R., Clemente, G. 2007. Fluorescence and color as markers for the Maillard reaction in milk-cereal based infant foods during storage. *Food Chemistry*, vol. 105, no. 3, p. 1135-1143. <https://doi.org/10.1016/j.foodchem.2007.02.016>
- Brands, C. M., Alink, G. M., Boekel, M. J. S., Jongen, W. M. F. 2000. Mutagenicity of heated sugar-casein systems: effect of the Maillard reaction. *Journal of Agricultural and Food Chemistry*, vol. 48, no. 6, p. 2271-2275. <https://doi.org/10.1021/jf9907586>
PMid:10888535
- Chen, X. M., Kitts, D. D. 2008. Antioxidant activity and chemical properties of crude and fractionated Maillard reaction products derived from four sugar-amino acid Maillard reaction model systems. *Annals of the New York Academy of Sciences*, vol. 1126, p. 220-224. <https://doi.org/10.1196/annals.1433.028>
- Hwang, I. G., Kim, H. Y., Woo, K. S., Lee, J., Jeong, H. S. 2011. Biological activities of Maillard reaction products (MRPs) in a sugar-amino acid model system. *Food Chemistry*, vol. 126, no. 1, p. 221-227. <https://doi.org/10.1016/j.foodchem.2010.10.103>
- Jing, H., Kitts, D. D. 2004. Antioxidant activity of sugar-lysine Maillard reaction products in cell free and cell culture systems. *Archives of Biochemistry and Biophysics*, vol. 429, no. 2, p. 154-163. <https://doi.org/10.1016/j.abb.2004.06.019>
- Kim, K., Kim, H., Oh, D., Cha, S., Rhee, S. 2006. Crystal structure of D-psicose 3-epimerase from agrobacterium tumefaciens and its complex with true substrate D-fructose: A pivotal role of metal in catalysis, an active site for the non-phosphorylated substrate, and its conformational changes. *Journal of Molecular Biology*, vol. 361, no. 5, p. 920-931. <https://doi.org/10.1016/j.jmb.2006.06.069>
PMid:16876192
- Lambert, L., Rombouts, I., Delcour, J. A. 2008. Study of nonenzymatic browning in α -amino acid and γ -aminobutyric acid/sugar model systems. *Food Chemistry*, vol. 111, no. 3, p. 738-744. <https://doi.org/10.1016/j.foodchem.2008.04.051>
- Laroque, D., Inisan, C., Berger, B., Vouland, E., Dufosse, L., Guerdard, F. 2008. Kinetic study on the Maillard reaction. Consideration of sugar reactivity. *Food Chemistry*, vol. 111, no. 4, p. 1032-1042. <https://doi.org/10.1016/j.foodchem.2008.05.033>
- Morales, F. J., van Boekel, M. A. J. S. 1999. A study on advanced Maillard reaction in heated casein/sugar solutions: colour formation. *International Dairy Journal*, vol. 8, no. 10-11, p. 907-915. [https://doi.org/10.1016/S0958-6946\(99\)00014-X](https://doi.org/10.1016/S0958-6946(99)00014-X)
- Morales, F. J., Jimenez-Perez, S. 2001. Free radical scavenging capacity on Maillard reaction products as related to color and fluorescence. *Food Chemistry*, vol. 72, no. 1, p. 119-125. [https://doi.org/10.1016/S0308-8146\(00\)00239-9](https://doi.org/10.1016/S0308-8146(00)00239-9)
- Nilsson, M., Stenberg, M., Fred, A. H., Holst, J. J. Bjorek, I. M. E. 2004. Glycemia and insulinemia in healthy subjects after lactose-equivalent meals of milk and other food proteins: the role of plasma amino acids and incretins. *The American Journal of Clinical Nutrition*, vol. 80, no. 5, p. 1246-1253. <https://doi.org/10.1093/ajcn/80.5.1246>
PMid:15531672
- Oh, N. S., Lee, J. Y., Lee, H. A., Joung, J. Y., Shin, Y. K., Kim, S. H., Kim, Y., Lee, K. W. 2016. Chemical characteristics and enhanced hepatoprotective activities of Maillard reaction products derived from milk protein-sugar system. *Journal of Dairy Science*, vol. 99, no. 2, p. 1-12. <https://doi.org/10.3168/jds.2015-10009>
- Oshima, H., Ozaki, Y., Kitakubo, Y., Hayakawa, S. 2014. Decrease in the D-psicose content of processed foods fortified with a rare sugar. *Food Science and Technology Research*, vol. 20, no. 2, p. 415-421. <https://doi.org/10.3136/fstr.20.415>
- Oshima, H., Kimura, I., Kitakubo, Y., Hayakawa, S., Izumori, K. 2014. Factors affecting psicose formation in food products during cooking. *Food Science and Technology Research*, vol. 20, no. 2, p. 423-430.
- Pfeifer, Y. V., Kroh, L. W. 2010. Investigation of reactive α -Dicarbonyl compounds generated from the Maillard reactions of L-Methionine with reducing sugars via their stable quinoxaline derivatives. *Journal of Agricultural and Food Chemistry*, vol. 58, no. 14, p. 8293-8299. <https://doi.org/10.1021/jf1008988>
- Phisut, N., Jiraporn, B. 2013. Characteristics and antioxidant activity of Maillard reaction products derived from chitosan-sugar solution. *International Food Research Journal*, vol. 20, no. 3, p. 1077-1085.
- Puangmanee, S., Hayakawa, S., Sun, Y., Ogawa, M. 2008. Application of whey protein isolate glycated with rare sugars to ice cream. *Food Science and Technology Research*, vol. 14, no. 5, p. 457-466.
- Sun, Y., Hayakawa, S., Izumori, K. 2004. Modification of ovalbumin with a rare ketoheose through the Maillard reaction: effect on protein structure and gel properties. *Journal of Agricultural and Food Chemistry*, vol. 52, no. 5, p. 1293-1299. <https://doi.org/10.1021/jf030428s>
- Sun, Y., Hayakawa, S., Izumori, K. 2004. Antioxidative activity and gelling rheological properties of dried egg white glycated with a rare ketoheose through the maillard reaction. *Journal of Food Science*, vol. 69, no. 6, p. 427-434. <https://doi.org/10.1111/j.1365-2621.2004.tb10984.x>
- Sun, Y., Hayakawa, S., Ogawa, M., Izumori, K. 2007. Antioxidant properties of custard pudding dessert containing rare hexose, D-psicose. *Food Control*, vol. 18, no. 3, p. 220-227. <https://doi.org/10.1016/j.foodcont.2005.09.019>
- Yu, X., Zhao, M., Hu, J., Zeng, S., Bai, X. 2012. Correspondence analysis of antioxidant activity and UV-Vis absorbance of Maillard reaction products as related to reactants. *LWT-Food Science and Technology*, vol. 46, no. 1, p. 1-9. <https://doi.org/10.1016/j.lwt.2011.11.010>
- Zeng, Y., Zhang, X., Guan, Y., Sun, Y. 2011. Characteristics and antioxidant activity of Maillard reaction products from psicose-lysine and fructose-lysine model systems. *Journal of Food Science*, vol. 76, no. 3, p. 398-403. <https://doi.org/10.1111/j.1750-3841.2011.02072.x>
PMid:21535806

Acknowledgments:

The authors wish to thank Ministry of Research, Technology, and Higher Education of Indonesia for entirely supporting this research. The authors also would like to thank Shigeru Hayakawa and Masahiro Ogawa for providing rare sugar D-psicose and D-fructose.

Contact address:

Arum Tiyas Suminar. Diponegoro University, Faculty of Animal and Agricultural Sciences, Food Technology

Department, Semarang, Indonesia 50275, E-mail:
arumtiyas.sa@gmail.com

Ahmad Ni'matullah Al-Baarri, Ph.D. Diponegoro
University, Faculty of Animal and Agricultural Sciences,
Food Technology Department, Semarang, Indonesia
50275, E-mail: albari@undip.ac.id

Prof. Anang Mohamad Legowo, Ph.D. Diponegoro
University, Faculty of Animal and Agricultural Sciences,
Food Technology Department, Semarang, Indonesia
50275, E-mail: anang_ml@yahoo.com



POSSIBLE CONSEQUENCES OF THE SUCROSE REPLACEMENT BY A FRUCTOSE-GLUCOSE SYRUP

Judit Süli, Ingrid Hamarová, Anna Sobeková

ABSTRACT

The fructose-glucose syrup is currently used instead of sucrose in bakery products for economic and technological reasons. The authors investigated the extent to which this change affects the formation of non-enzymatic browning products (Advanced Glycation End – AGE-Products and melanoidins). Formation of these products in model systems – mixtures of various sugars (sucrose, fructose, glucose – concentration 6%) with glycine (concentration 0.7%) or/and lysine (concentration 0.3%), heat-treated 60 – 100 °C for 15, 30, 45 and 60 min, was studied. The formation of AGE products and melanoidins was determined on the basis of absorption at 294 nm (AGE-products) and 420 nm (melanoidins), respectively. The results pointed out notable difference in the AGE-products and also melanoidins formation for a variety of sugars. The reactivity of sucrose was low even at 100 °C/60 min. Fructose and glucose originated a significantly increasing of the non-enzymatic browning products formation. The reactivity of fructose was in the caramelisation and also in Maillard reactions the highest in any combination of composition. Lysine is the most reactive amino acid which takes part in Maillard reactions even if it is bound to protein. The non-enzymatic browning reactions result in the formation of non-digestible cross-linked proteins. Lysine is also the limiting essential amino acid of most cereals. Due to the lysine properties, reduction in protein quality is the most important nutritional effect of Maillard reactions in food. The sucrose replacement by fructose-glucose syrup in bakery products leads to more extensive non-enzymatic browning reactions, i.e. caramelisation and also Maillard reactions, while changes are in the Maillard reaction more pronounced.

Keywords: non-enzymatic browning reaction; sucrose; high fructose corn syrup; caramelisation; Maillard reaction

INTRODUCTION

Sucrose is one of the oldest sweeteners and flavour ingredients (Rippe and Angelopoulos, 2013). Global trends in the sucrose consumption slightly decrease (Sitárová, 2011). On the other hand, the consumption of soft drinks, sweet stuff, and other goodies significantly increases. Food producers look for sucrose alternatives for economic and technological reasons. Currently, mainly high fructose-glucose syrup from corn (high fructose corn syrup – HFCS) competes to traditional sucrose (Figure 1).

HFCS is used not only in the production of soft drinks but also in the production of confectionery, bakery, and dairy products. HFCS can be produced with various proportions of glucose and fructose (Lo et al., 2008). The most commonly used types of these syrups are HFCS-42 (42% fructose), and HFCS-55 (55% fructose), a composition similar to the composition of sucrose (50% fructose and 50% glucose), or HFCS-90 containing 90% fructose. The advantage for food manufacturers is that the monosaccharides in HFCS provide improved taste, stability, freshness, texture, colour, and consistency of food, as compared to sucrose (Moeller et al., 2009).

Handling the HFCS is much easier because of lower glucose and fructose solution viscosity compared to viscosity of the sucrose solution at the same concentration (Johnson et al., 2009; Nordic Sugar, 2015).

Fructose affects human health directly and indirectly. The *direct health effects* of fructose represent the subject of many scientific studies. Fructose promotes the accumulation of fat in the abdomen and abdominal organs (abdominal obesity) and increases production of triglycerides, phospholipids, and cholesterol in the liver from non-fat sources (hepatic lipogenesis) (Hu and Malik, 2010). These processes may lead to hepatic steatosis (Akram and Hamid, 2013). Fructose contributes to the production of uric acid which may adversely affect the development of gout (Bray, 2013). Compared with other caloric sweeteners, high intake of fructose (e.g., in the form of HFCS) increases the risk of obesity (Gaby, 2005; Moeller et al., 2009) and is related to the metabolic syndrome (abdominal obesity, impaired glucose tolerance associated with insulin resistance and hyperinsulinaemia, hyperlipoproteinaemia characterized by low HDL,

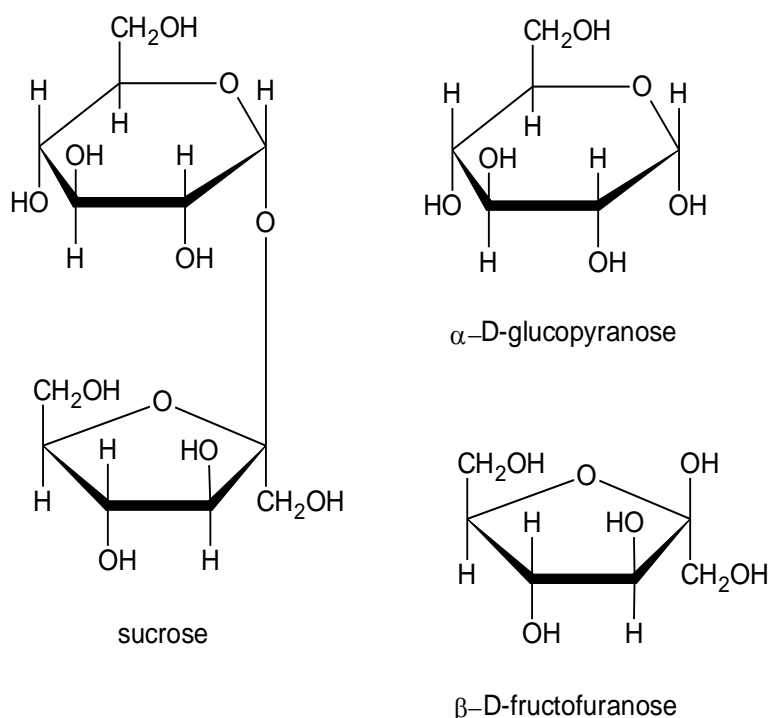

Figure 1 Structure of sucrose (β -D-fructofuranosyl-(2 \rightarrow 1)- α -D-glucopyranoside) and components of HFCS (β -D-fructofuranose and α -D-glucopyranose).

elevated triglycerides levels, hypertension) (Akram and Hamid, 2013).

The indirect effect of free monosaccharides is connected with their higher reactivity during food processing when compared with sucrose. Reducing sugars undergo non-enzymatic browning reactions with proteins and amino acids at higher temperature directly, while the non-reducing sucrose must be at first hydrolysed to monosaccharides (Dills, 1993). The intermediates and products of these reactions are responsible for essential sensory attributes of thermally processed food products, contributing to their flavour, aroma, texture, and colour. Their antioxidant properties also contribute to the increased food stability (Velíšek, 2014). On the other hand, a lot of carcinogenic, toxic and mutagenic compounds are formed there (Brands et al., 2000; Sumaya-Martinez et al., 2005). Acrylamide is one of the most important toxic substance predominantly formed in food characterized by high content of starch (Vičáková and Vieriková, 2010).

Non-enzymatic browning reactions depend on many parameters, such as temperature, time of heating, water activity, pH, source of reactants, and concentration of the reactants (Rystov et al., 2011). The sugar degradation reactions in the absence of amino groups (caramelisation) lead to formation of brown pigments. In the presence of nitrogen-containing compounds, Maillard reactions take place to form Maillard products (MRPs). They are colourless (Advanced Glycation End Products – AGE-products) in the first phase of the reactions, and subsequently brown pigments (melanoidins) are formed.

Scientific hypothesis

In the present study, the effect of temperature, time of heating, and type of reactants on MRPs (AGE-products and melanoidins) formation was investigated in the sugar solutions (sucrose, fructose and glucose syrup) –

caramelisation reactions, and in blend of these sugars with glycine and lysine – Maillard reactions.

MATERIAL AND METHODOLOGY

Chemicals

- *Fructose syrup* (VUC Services Ltd., Czech Republic); content of fructose 99.8%; content of glucose <0.1%; (*Fru*)
- *Glucose syrup C*Sweet D 02767* (Cargill Inc., USA); content of glucose 75%; content of water 25%; (*Glc*)
- *Sucrose (Suc)*, *Glycine (Gly)*, *Lysine (Lys)*, *NaHCO₃* (Merck Germany); all reagents were of analytical grade
- *Deionized water* adjusted to pH 7.4 with NaHCO₃.

Samples preparation

During caramelisation and Maillard reactions, the formation of AGE-products and terminal melanoidins was observed in model systems. Tested samples were aqueous mixtures of sugar (Suc, Fru and Glc) with glycine and/or lysine. The final content of components in the reaction mixture was 6% (w/w) for the sugar, 0.7% (w/w) for glycine, and 0.3% (w/w) for lysine. Composition of reaction mixture is imitating the content of the components in sweet bakery products.

The following combinations were studied:

- Sugar (*Suc*; *Fru*; *Glc*);
- Sugar + Glycine (*Sugar* + *G*);
- Sugar + Lysine (*Sugar* + *L*);
- Sugar + Glycine + Lysine (*Sugar* + *G* + *L*).

All samples were heated at 60 °C, 70 °C, 80 °C, 90 °C and 100 °C for 15, 30, 45 and 60 min in boiling glass tubes and then immediately cooled in ice.

Determination of AGE-products and melanoidins

Samples were measured spectrophotometrically at 294 nm (AGE-products) and 420 nm (melanoidins), respectively, according to Yu et al. (2012), using an UV spectrophotometer (λ -Helios, G. B.). When necessary, appropriate dilutions were made in order to obtain required optical density.

Results are expressed as:

$$\Delta A = A_{\text{sample}} - A_0$$

A_{sample} – the absorbance of the heated solution
 A_0 – the absorbance of the control (25 °C/0 min)

Statistical analysis

All model systems were prepared in triplicate. Data were expressed as the mean \pm standard deviation (SD) and represent three independent analyses. Statistical significance of sucrose replacement was examined using the Student’s paired t-test. A $p < 0.05$ (*) and $p < 0.01$ (**) was considered statistically significant.

RESULTS AND DISCUSSION

The effect of temperature, time of heating, and composition of reaction mixture was investigated in this study. The content of sugars in model system was calculated according to usual recipes for cakes. The content of amino acids has gone out from the average content of glycine and lysine in proteins of common cereals. Our results showed that the temperature and time of heating significantly affect the formation of MRPs in the caramelisation and in the Maillard reactions. Formation of these products was proportional to the temperature and time of heating. In the samples containing reducing sugars (Fru, Glc) in the *caramelisation reactions* already a 15 min exposure to 100 °C resulted in the formation of AGE-products (Figure 2). AGE-products start to form already at 80 °C in a fructose sample and at 90 °C in

glucose during the caramelisation reactions in the samples heated for 60 min. Formation of melanoidins was very low under these conditions (maximum value $\Delta A = 0.18$). Fructose seems to be the most reactive sugar.

Heat treatment of samples, mixtures of sugar and amino acids results in *Maillard reactions*. Levels of AGE-products (294 nm) and melanoidins (420 nm) have not significantly changed after glycine addition when compared to caramelisation reactions (Figure 3 and Figure 4; Sugar versus Sugar + Gly). However, ΔA values rose enormously in the presence of lysine for fructose and glucose. Larger differences among the samples were observed in the formation of melanoidins. The most of AGE products and melanoidins were formed in samples with fructose or glucose syrup (Figure 3 and Figure 4; Fru versus Suc, Glc versus Suc).

The non-enzymatic browning reactions and the oxidation reactions are the most important and the most extensive reactions during food storage and processing mostly at high temperatures (Delgado-Andrade et al., 2010). The main components participating in these changes are the carbohydrates, particularly reducing mono- and oligosaccharides or polysaccharides undergoing hydrolysis upon food processing (e.g. starch). The saccharides (especially reducing sugars) are susceptible to caramelisation reactions. Their products are brown pigments – melanoidins. The reactions of carbonyl compounds (carbohydrates or their derivatives) with compounds containing free amino group (amino acids, peptides, proteins) is a special type of non-enzymatic browning reactions known as the Maillard reactions (MR). The chemistry of the Maillard reactions is very complex and their mechanism is still not fully understood. Products of these reactions (Maillard reaction products – MRPs) are important for their organoleptic characteristics and modify the nutritional value of food. Their antioxidant properties support the food stability (Markowicz-Bastos et al., 2012). However, the MR have also been associated with the formation of potentially harmful compounds and

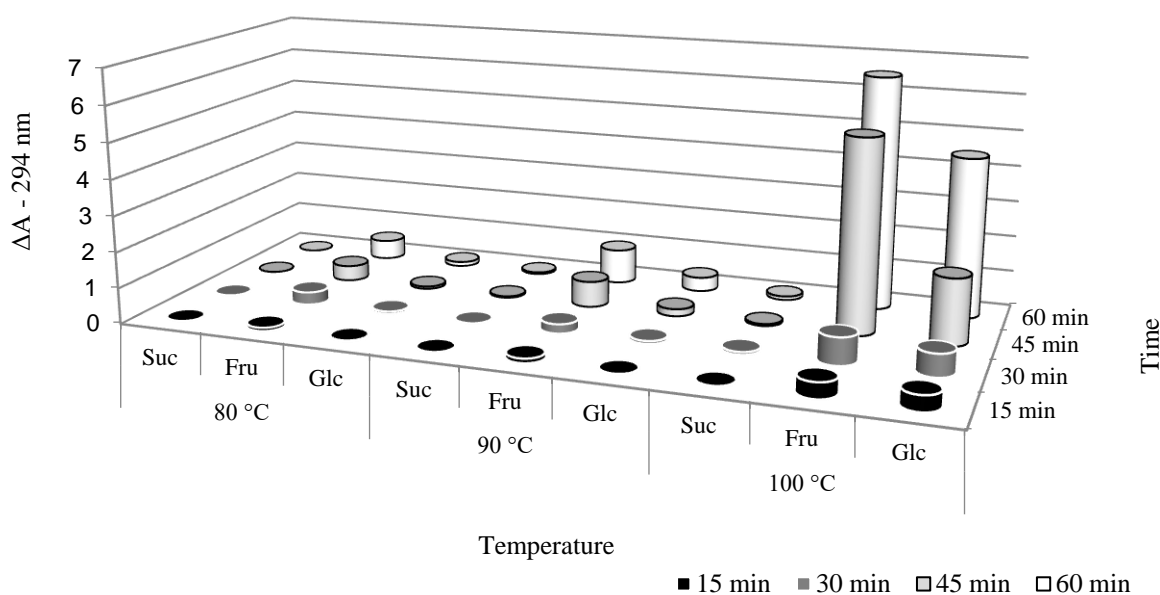

Figure 2 Formation of AGE-products in the caramelisation reactions of various sugars heated at 80, 90, and 100 °C for 15, 30, 45, and 60 min.

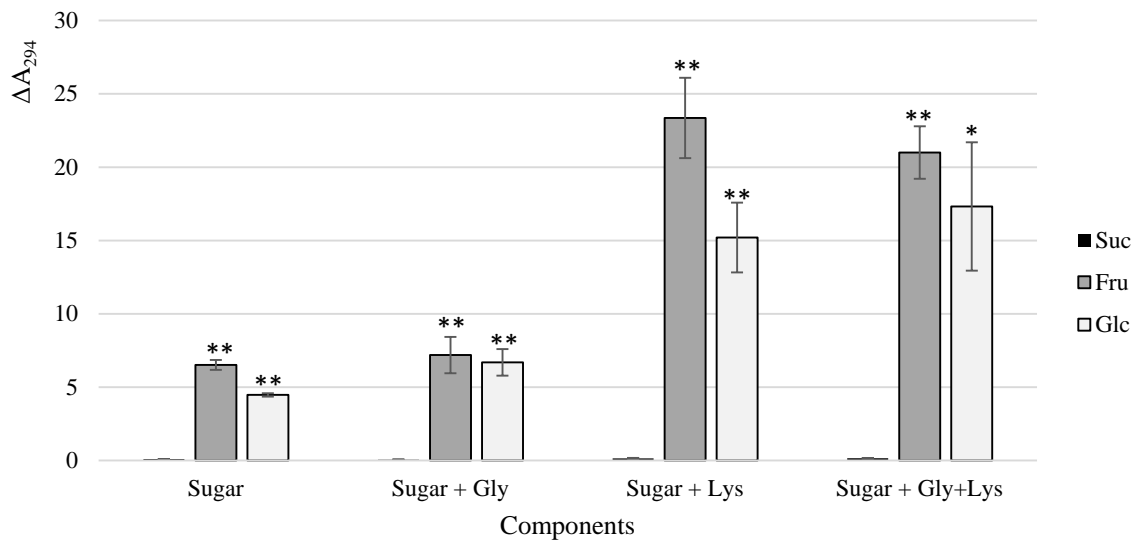

Figure 3 Formation of AGE-products (294 nm) in the reaction mixtures of different composition heated at 100 °C for 60 min.

Note: Results are expressed as mean ±SD (n = 3). Statistical significance of sucrose replacement was tested by Student's t-test **p* <0.05; ***p* <0.01.

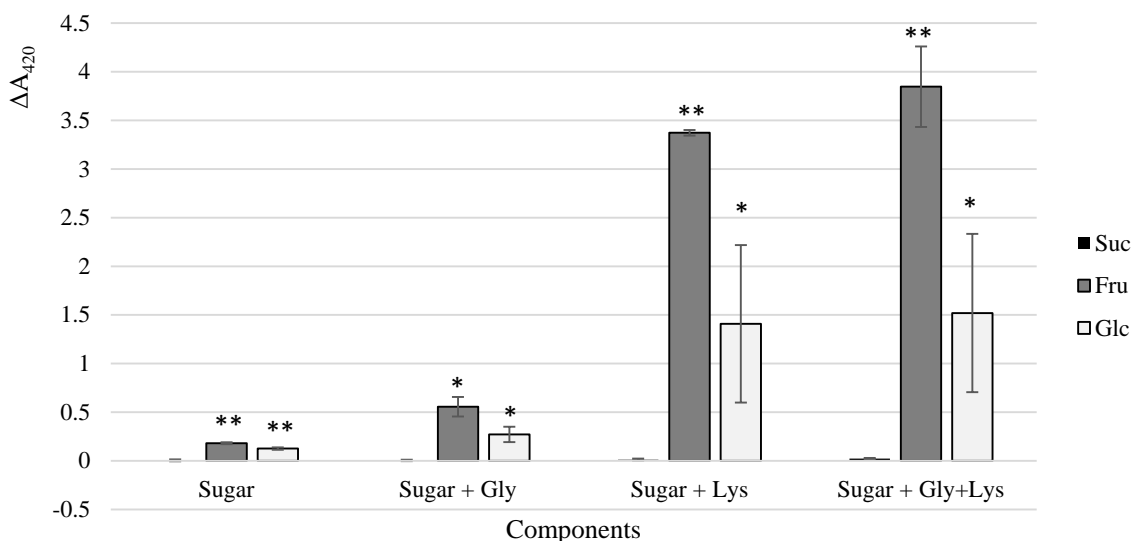

Figure 4 Formation of melanoidins (420 nm) in the reaction mixtures of different composition heated at 100 °C for 60 min.

Note: Results are expressed as mean ±SD (n = 3). Statistical significance of sucrose replacement was tested by Student's t-test **p* <0.05; ***p* <0.01.

reduction of the bioavailability of proteins and amino acids (Purlis, 2010; Jiang et al., 2013). The most reactive amino acid in MR is lysine in both forms, the ε-amino group of free amino acid and the lysyl residues in proteins (Velíšek, 2014). Protein nutritional impairment, the consequence of the destruction of essential amino acids or decrease of their bioavailability, is one of the oldest known nutritional implications of these reactions (Markowicz-Bastos et al., 2012). The Maillard reactions result in a decrease in protein quality and nutritional value of food due to the loss of amino acids or their binding to unavailable complexes and the decreased protein digestibility (Nagai et al., 2014). This is particularly important for bakery products, because the lysine is limiting amino acid of cereals and cereal products

(Sarwar, 1985). Deficient lysine can represent a considerable problem for vegetarians consuming relatively high amount of cereals. Limitation of the Maillard reactions during the food processing or cooking is therefore required.

High-fructose corn syrup (HFCS) has been used in the food industry since the 1970's of last century as its production is cheap, easy to handle, and have a slightly sweeter-perceived than similar dose of sucrose. Sucrose is a disaccharide consisting of the glucose molecule linked with the fructose molecule. HFCS is a liquid blend of these two monosaccharides. Glucose and fructose molecules float in a solution rather than being bound to each other. Sucrose, as a non-reducing sugar, is considerably less reactive than free glucose or fructose. Reducing sugars are

capable of forming an open chain structure and expose the carbonyl group. Sucrose has to be at first hydrolysed to glucose and fructose which can subsequently enter these reactions (Rippe and Angelopoulos, 2013). Percentages of acyclic forms and electrophilicity of the carbonyl group are important factors affecting the reaction rates of individual sugars. Open chain structure of fructose occurs more frequently than that of glucose and, as a consequence, the higher reactivity of fructose can be expected in the Maillard reactions (Velíšek, 2014). The suggestions of scientists regarding the higher reactivity of fructose are not uniform because of lower electrophilicity of ketoses (Yamada et al., 1994; Naranjo et al., 1998; Yeboah et al., 1999).

Many studies and statistics show that the use of HFCS in the food industry is related to increased incidence of obesity (Bray et al., 2004). Increased intake of fructose in a food is connected with obesity, dyslipidaemia, insulin resistance, hypertension, atherosclerosis, vascular diseases, Alzheimer's disease, and renal diseases (Tappy and Lê, 2010; Nagai et al., 2012; Rippe and Angelopoulos, 2013).

Our results showed that the temperature and time of heating significantly affect the formation of the caramelisation and also the Maillard reactions products. Formation of the products was proportional to the temperature and time of heating. The formation of AGE-products was already observed at 70 °C (Fru, Glc). Melanoidins were formed only at higher temperatures (90 – 100 °C) for prolonged exposure. MRPs were hardly formed when sucrose was used. The most significant changes occur at 100 °C/60 min for all studied samples. The changes in the samples, as the consequence of Maillard reactions, were markedly more extensive than those of the caramelisation reactions. Formation of MRPs in Maillard reactions requires lower temperature and shorter time of heating, as compared with the caramelisation reactions. Intensive caramelisation takes place at 120 °C or more (Velíšek, 2014). To observe the beginning of the MRPs formation, the temperatures of up to 100 °C were tested in our model experiments. In food processing, higher temperatures are used. Considering the fact that such significant differences between the reducing sugars and non-reducing sucrose were observed at 100 °C, what changes can be expected at higher temperatures?

Our results confirmed high reactivity of lysine. The addition of glycine alone (without lysine) induced only minor MRPs formation, as compared with caramelisation reactions. Reactivity of sucrose in non-enzymatic browning reactions was very low. Bakery products prepared with sucrose will contain significantly less toxic Maillard products than products prepared with fructose and glucose syrup. Particularly high level of MRPs was observed using fructose syrup. HFCS in human diet is the main source of reactive dicarbonyl compounds (Lo et al., 2008). Increased intake of AGE-products and melanoidins through bakery products could represent another negative effect of HFCS (Bray et al., 2004; Tappy and Lê, 2010; Bray, 2013).

Healthy human organism can generally compensate the increased intake of harmful substances. But how long can a human stay healthy? What may accelerate pathological

processes in the body? The generation receiving an increased amount of MRPs through the bakery products prepared with fructose syrup all their lives has not yet reached the age when health problems usually start to develop.

Type 2 diabetes is a disease typical for elderly persons. Intake of higher amount of Maillard products may be potentially dangerous for their organisms. May it affect the rate of their aging? And may it affect aging of healthy people? Answers to these questions are still unknown. In the meantime, we must confront unethical advertisement of “quickly available energy” and the prevalence of producers' interests over interests of consumers.

CONCLUSION

Sucrose is a low reactive sugar in terms of non-enzymatic browning reactions. Bakery products with sucrose contain significantly less toxic Maillard products than those prepared with fructose-glucose syrup. Extremely increased levels of Maillard products have been observed when fructose syrup was used. Increased intake of AGE products and melanoidins via bakery products may be considered as another undesirable effect of fructose syrup usage. However, producers prefer low costs and technological advantages of fructose-glucose syrup to potential dangerous effect on human health.

REFERENCES

- Akram, M., Hamid, A. 2013. Mini review on fructose metabolism. *Obesity Research & Clinical Practice*, vol. 7, no. 2, p. 89-94. <https://doi.org/10.1016/j.orcp.2012.11.002>
- Brands, M. C., Alink, G. M., van Boekel, M. A., Jongen, W. M. 2000. Mutagenicity of heated sugar-casein systems: effect of the Maillard reaction. *Journal of Agricultural and Food Chemistry*, vol. 48, no. 6, p. 2271-2275. <https://doi.org/10.1021/jf9907586>
- Bray, G. A., Nielsen, S. J., Popkin, B. M. 2004. Consumption of high-fructose corn syrup in beverages may play a role in the epidemic of obesity. *American Journal of Clinical Nutrition*, vol. 79, no. 4, p. 537-543. [PMid:15051594](https://pubmed.ncbi.nlm.nih.gov/15051594/)
- Bray, G. A. 2013. Energy and fructose from beverages sweetened with sugar or high-fructose corn syrup pose a health risk for some people. *Advances in Nutrition*, vol. 4, p. 220-225. <https://doi.org/10.3945/an.112.002816>
- Delgado-Andrade, C., Seiquer, I., Haro, A., Castellano, R., Pilar Navarro, M. 2010. Development of the Maillard reaction in foods cooked by different techniques. Intake of Maillard-derived compounds. *Food Chemistry*, vol. 122, no. 1, p. 145-153. <https://doi.org/10.1016/j.foodchem.2010.02.031>
- Dills, W. L. Jr. 1993. Protein fructosylation: fructose and Maillard reaction. *American Journal of Clinical Nutrition*, vol. 58, no. 5 Suppl., p. 779S-787S. [PMid:8213610](https://pubmed.ncbi.nlm.nih.gov/8213610/)
- Gaby, A. R. 2005. Adverse effects of dietary fructose. *Alternative Medicine Review*, vol. 10, no. 4, p. 294-306. [PMid:16366738](https://pubmed.ncbi.nlm.nih.gov/16366738/)
- Hu, F. B., Malik, V. S. 2010. Sugar-sweetened beverages and risk of obesity and type 2 diabetes: epidemiologic evidence. *Physiology & Behaviour*, vol. 100, no. 1, p. 47-54. <https://doi.org/10.1016/j.physbeh.2010.01.036>
- Jiang, Z., Rai, D. K., O'Connor, P. M., Brodkorb, A. 2013. Heat-induced Maillard reaction of the tripeptide IPP and ribose: Structural characterization and implication on bioactivity. *Food Research International*, vol. 50, no. 1, p. 266-274. <https://doi.org/10.1016/j.foodres.2012.09.028>

- Johnson, R., Padmaja, G., Moorthy, S. N. 2009. Comparative production of glucose and high fructose syrup from cassava and sweet potato roots by direct conversion techniques. *Innovative Food Science and Emerging Technologies*, vol. 10, no. 4, p. 616-620. <https://doi.org/10.1016/j.ifset.2009.04.001>
- Lo, Ch. Y., Li, S. L., Wang, Y., Tan, D., Pan, M. H., Sang, S., Ho, Ch. T. 2008. Reactive dicarbonyl compounds and 5-(hydroxymethyl)-2-furfural in carbonated beverages containing high fructose corn syrup. *Food Chemistry*, vol. 107, no. 3, p. 1099-1105. <https://doi.org/10.1016/j.foodchem.2007.09.028>
- Markowicz Bastos, D., Monaro, É., Siguemoto, É., Séfora M. 2012. Maillard reaction products in processed food: pros and cons. In Valdez, B. *Food Industrial Processes – Methods and Equipment*. Rijeka, Croatia : InTech., p. 281-300. ISBN 978-953-307-905-9. <https://doi.org/10.5772/31925>
- Moeller, S. M., Fryhofer, S. A., Osbahr, A. J., Robinowitz, C. B. 2009. The effects of high fructose syrup. *Journal of the American College of Nutrition*, vol. 28, no. 6, p. 619-626. <https://doi.org/10.1080/07315724.2009.10719794>
- Nagai, R., Jinno, M., Ichihashi, M., Koyama, H., Yamamoto, Y., Yonei, Y. 2012. Advanced glycation end products and their receptors as risk factors for aging. *Anti-Aging Medicine*, vol. 9, no. 4, p. 108-113.
- Nagai, R., Shirakawa, J., Fujiwara, Y., Ohno, R., Moroishi, N., Sakata, N., Nagai, M. 2014. Detection of AGEs as markers for carbohydrate metabolism and protein denaturation. *Journal of Clinical Biochemistry and Nutrition*, vol. 55, no. 1, p. 1-6. <https://doi.org/10.3164/jcbtn.13-112>
- Naranjo, G. B., Malec, L. S., Vigo, M. S. 1998. Reducing sugars effect on available lysine loss of casein by moderate heat treatment. *Food Chemistry*, vol. 62, no. 3, p. 309-313. [https://doi.org/10.1016/S0308-8146\(97\)00176-3](https://doi.org/10.1016/S0308-8146(97)00176-3)
- Nordic Sugar. The functional properties of sugar – on a technical level [online] s.a. [cit. 2016-12-01]. Available at: http://www.nordicsugar.com/fileadmin/Nordic_Sugar/Brochures_factsheet_policies_news/Download_center/Functional_properties_of_sugar_on_a_technical_level/Functional_prop_on_tech_level_uk.pdf.
- Purlis, E. 2010. Browning development in bakery products – A review. *Journal of Food Engineering*, vol. 99, no. 3, p. 239-249. <https://doi.org/10.1016/j.jfoodeng.2010.03.008>
- Rippe, J. M., Angelopoulos, T. J. 2013. Sucrose, high-fructose corn syrup, and fructose, their metabolism and potential health effects: what do we really know? *Advances in Nutrition*, vol. 4, p. 236-245. <https://doi.org/10.3945/an.112.002824>
- Rystov, L., Chadwyk, R., Krock, K., Wang, T. 2011. Simultaneous determination of Maillard reaction impurities in mepantone tablets using HPLC with charged aerosol detector. *Journal of Pharmaceutical and Biomedical Analysis*, vol. 56, no. 5, p. 887-894. <https://doi.org/10.1016/j.jpba.2011.07.010>
- Sarwar, G. 1985. Differences between digestibilities of protein and first limiting amino acid in some plant products. In Lásztity, R. et al. *Amino acid composition and biological value of cereal proteins*. Dordrecht, Holland : D. Reidel Publishing Company, p. 295-304. e-ISBN-13: 978-94-009-5307-9.
- Sitárová, T. 2011. *Food Consumption in the Slovak Republic* (in Slovak). Bratislava : Statistical Office of the Slovak Republic. ISBN: 978-80-8121-376-2.
- Sumaya-Martinez, M. T., Thomas, S., Linard, B., Binet, A., Guerard, F. 2005. Effect of Maillard reaction conditions on browning and antiradical activity of sugar-tuna stomach hydrolysate model system. *Food Research International*, vol. 38, no. 8-9, p. 1045-1050. <https://doi.org/10.1016/j.jpba.2011.07.010>
- Tappy, L., Lê, K. A. 2010. Metabolic effects of fructose and the worldwide increase in obesity. *Physiological Reviews*, vol. 90, no. 1, p. 23-46. <https://doi.org/10.1152/physrev.00019.2009>
- Velíšek, J. 2014. *The Chemistry of Food*. Chichester, UK : John Wiley & Sons. ISBN 978-1-118-38381-0.
- Vlčáková, M., Vieriková, M. 2010. Determination of acrylamide in food by gas and liquid chromatography-mass spectrometry. *Potravinárstvo*, vol. 4, no. 3, p. 63-68. <https://doi.org/10.5219/61>
- Yamada, H., Miyata, S., Igaki, N., Yatabe, H., Miyauchi, Y., Ohara, T., Sakai, M., Shoda, H., Oimomi, M., Kasuga, M. 1994. Increase in 3-Deoxyglucosone Levels in Diabetic Rat Plasma. Specific in vivo determination of intermediate in advanced Maillard reaction. *The Journal of Biological Chemistry*, vol. 269, no. 32, p. 20275-20280. PMID:8051120
- Yeboah, F. K., Alli, I., Yaylayan, V. A. 1999. Reactivities of D-glucose and D-fructose during glycation of bovine serum albumin. *Journal of Agricultural and Food Chemistry*, vol. 47, no. 8, p. 3164-3172. <https://doi.org/10.1021/jf981289v>
- Yu, X., Zhao, M., Hu, J., Zeng, S., Bai, X. 2012. Correspondence analysis of antioxidant activity and UV-Vis absorbance of Maillard reaction products as related to reactants. *LWT – Food Science and Technology*, vol. 46, no. 1, p. 1-9. <https://doi.org/10.1016/j.lwt.2011.11.010>

Acknowledgments:

This study was supported by project VEGA 1/0176/16 (Slovak Republic).

Contact address:

Judit Süli, University of Veterinary Medicine and Pharmacy in Košice, Department of Chemistry, Biochemistry and Biophysics, Institute of Medical Chemistry, Komenského 73, 041 81 Košice Slovakia, E-mail: judit.suli@uvlf.sk

Ingrid Hamarová, University of Veterinary Medicine and Pharmacy in Košice, Department of Chemistry, Biochemistry and Biophysics, Institute of Medical Chemistry, Komenského 73, 041 81 Košice Slovakia, E-mail: inga.hamarova@gmail.com

Anna Sobeková, University of Veterinary Medicine and Pharmacy in Košice, Department of Chemistry, Biochemistry and Biophysics, Institute of Medical Chemistry, Komenského 73, 041 81 Košice Slovakia, E-mail: anna.sobekova@uvlf.sk

THE EFFECT OF DHA OMEGA-3 FEEDING IN THE HIGH YIELDING HOLSTEIN HERD

Juraj Karcol, Radovan Kasarda, Milan Šimko, Ondrej Hanušovský

ABSTRACT

The aim of this study was to analyse the effect of supplementary feeding of DHA (Docosahexaenoic Acid) rich algae product (Algae S™ Alltech Inc.) on production of milk, fat and protein as well as on reproduction of high yielding Holstein dairy herd. Field trial was set up on Top 10 dairy farm in western part of Slovakia, under commercial conditions. The data of high yielding dairy cows, separated in two groups of 30 (control) and 29 (trial) animals, were recorded for period of 3 subsequent months from October to December 2015. Animals were fed once a day Total Mixed Ration based diet with different feed mixture composition in trial group (+100 g Algae S™ Alltech Inc. per cow and day). Performance data were collected in accordance with official milk recording system of Breeding Services of Slovak Republic s. e. and milk samples were collected once per month according to the A4 standard methodology. The control group showed higher level of milk production compared to trial. Our study indicated that the feeding of algae caused milk fat depression and generally lower protein content in milk. Significant impact of algae feeding was found also for the level of urea in milk. In addition, the supplementary feeding of DHA may represent effective strategy to increase the percentage of pregnancies per inseminations in lactating dairy cows.

Keywords: cattle; algae; calving rate; milk production

INTRODUCTION

The dairy cow industry has changed dramatically over the past decades. Per-cow milk yields have increased markedly as a combined result of improvements in animal management, nutrition, and genetics. A prerequisite for good lactation performance during a cow's life span is the production of offspring at regular intervals. Good feeding strategies (composition, quantity, palatability, availability, and the access of the feed) are also important (Leroy et al., 2013). Nitrayová et al. (2014) and Francáková et al. (2015) studied fatty acids composition in different sources of plant seeds used for human nutrition and production of vegetable oil. Because corn and soybean are staple food crops for humans, their common use as the main source of dietary energy and protein for food-producing animals directly competes with their allocation for human consumption (Lum et al., 2013). The metabolic demands for increasing milk production are significant and represent a major challenge to ensure optimum production while also facilitating reproduction. Dietary nutrients and nutrients from body tissues are directed to milk production. During this same time, the uterus, ovary, and hypothalamus/pituitary glands undergo a process of recovery and rebuilding for the establishment of subsequent pregnancy (Thatcher et al., 2006, 2011).

Recent understandings of the role of fats in metabolism open new opportunities for improving production, health, and reproduction in cattle. Increasing evidence of positive effects of feeding fats during transition on fertility and the adaptation to lactation (Rodney et al., 2015) exists. Fertility could be enhanced by feeding n-3 diet due to the effect of n-3 PUFA on the concentration of prostaglandin F2 alpha (PGF2α) in the uterus, thus potentially facilitating embryo implantation and reducing embryo mortality (Mattos et al., 2004). Diet enriched in n-3 PUFA increased the number of the pre-ovulatory follicles (Ambrose et al., 2006) and small follicles too (Zachut et al., 2010). The essential fatty acids are the critical components of fats and one very important fatty acid is the omega-3 derivative, docosahexaenoic acid (DHA). The glucogenic diet was not successful in altering the milk fatty acid composition. On the other hand, direct rumen supplementation of 43.0 g of algae/kg of DM had dramatic effects on DMI and milk yield. Dietary supply of DHA-enriched microalgae resulted in an altered milk fatty acid composition. A modified milk fatty acid composition upon algae feeding was associated with decreased milk fat content when algae were supplemented with the diet. Good management during the transition period, in particular nutritional strategies, can reduce the effects of metabolic stress and improve production and reproduction (De Veth

et al., 2009). The decrease in fertility of the lactating dairy cow is multi-factorial and often associated with high milk production (Lucy, 2001; Bernal-Santos et al., 2003). In recent years studies have examined the effects of feeding algal meal, high in DHA, on feed intake, enteric methane production and milk parameters (Boeckaert et al., 2008; Stamey et al., 2012; Moate et al., 2013). Study of Childs et al. (2008) showed little difference in the effect of dietary n-3 or n-6 PUFA supplementation on range of reproductive parameters; however increased concentrations of PGFM have been found which could be beneficial for the formulation of post-calving diets of dairy cows. It has been demonstrated that feeding algal meal may inhibit voluntary dry matter intake and reduce milk fat concentrations (Moate et al., 2013). Study of Angulo et al. (2012) observed that addition of algae for 10 weeks to the diet of dairy cows induced expression of lipogenic gene (SCD1, FASN) and reduction of the SREBF1 transcription factor gene expression in the mammary gland. Feeding rumen-protected marine algae to dairy cows enriched milk and butter with DHA (Glover et al., 2012).

The aim of the study was to confirm the effect of supplementary feeding of DHA rich algae product (Algae STM Alltech Inc.) on production of milk, fat and protein as well as on reproduction of high yielding Holstein dairy herd.

MATERIAL AND METHODOLOGY

Field trial was set up on top 10 dairy farms in western part of Slovakia, under commercial conditions. It was performed in period of 3 subsequent months from October to December 2015. The analysed Holstein herd consisted of 400 cows, housed in free cubicles with straw bedding. Only first lactation high yielding dairy cows separated into the two groups of 30 (control) and 29 (trial) cows were included in study. Groups were consistent according the stage of production and reproduction cycle. Animals were fed once a day tmr based diet. The composition and nutritional parameters of fed tmr are shown in table 1 and 2. Both groups were fed using concentrate mixture with the same composition with only difference in algae/dha omega 3 feed supplement (algae stm alltech inc.), with

dosage of 100 g per cow and day in trial group (Table 3).

The impact of algae feeding has been studied in relation to the milk production performance and calving rate as one of the most important reproduction parameters. Performance data were collected in accordance with official milk recording made on farm by Breeding Services of Slovak Republic s. e. Milking was performed three times a day. Performance recording and milk sample collection was made once per month according the of A4 standard methodology.

Statistic analysis

Collected data on daily milk production in kg, fat and protein content as well as urea were analysed using software SAS EG v 5.1 (SAS Institute Inc., 2012). The significance of differences between groups of analysed parameters were tested by parametric statistic using Student two-sample t-test.

RESULTS AND DISCUSSION

Control and trial group were selected from first lactation cows to be consistent in stage of lactation (no significant difference between both groups in DIM), level of lactation (no significant difference in milk production, fat and protein content (Table 4, pre-trial)) and state of reproduction (postpartum cows). The significant difference ($p > 0.05$) has been observed only in level of urea in milk $-2.71 \text{ mg} \cdot 100 \text{ mL}^{-1}$ in trial group (Table 1). Slight higher (+1.34 kg) milk production in control group compared to the trial has been observed in October 2015. In contrary, the protein content was lower in control group (-0.13%). Observed differences were non-significant, while highly significant differences were observed in levels of fat (+0.98%) and urea (+10.71 $\text{mg} \cdot \text{mL}^{-1}$) in favour of control group.

In November 2015 significant depression of milk production (-2.91 kg) was observed in trial group. Highly significant decrease of fat content (-0.67%, Table 2) and urea level (-7.60 $\text{mg} \cdot \text{mL}^{-1}$) was found also in trial group. Protein content stayed almost untouched (diff. 0.02%).

Similarly, lower level of milk production was observed in December 2015, as well as the protein content (0.07%) in trial group, but the difference was non-significant.

Table 1 Composition of fed TMR.

Component	Control group	Trial group
Maize silage (%)	41.09	41.02
Alfalfa silage (%)	29.88	29.83
Feed mixture (%)	13.15	13.30
High moisture corn (%)	9.34	9.32
Gurmit (%)	5.60	5.59
Alfalfa hay (%)	0.56	0.56
Feed straw (%)	0.37	0.37

Table 2 Nutritional parameters of fed TMR.

Nutrient	Control group	Trial group
Dry matter (kg)	25.35	25.55
NEL (MJ)	160.90	160.26
Starch (%)	28.19	27.91
Fiber (%)	19.46	19.25
Crude protein (%)	16.80	16.57
Fats (%)	4.22	4.16

Table 3 Composition of supplementary feed concentrate mixture in both groups.

Component	Control group	Trial group
Algae (%)	-	1.40
Sunflower meal (%)	35.54	34.55
Barley seed (%)	28.43	27.64
Sunflower cake (%)	18.48	17.96
Megalac (%)	4.98	4.84
Rumagen (%)	4.98	4.84
Bicarbonate (%)	2.84	2.76
Vitamix (%)	2.13	2.07
Limestone (%)	1.42	2.76
Feed salt (%)	1.21	1.17

Table 4 Average production of milk and content of fat, protein and urea in milk during the trial in control (C) and trial (T) group.

Period	Group	Milk (kg ±SD)	Fat (% ±SD)	Protein (% ±SD)	Urea (mg.100mL ⁻¹ ±SD)
Pre-Trial	C	27.56 ±5.04	3.10 ±0.63	3.04 ±0.26	27.77 ±5.79
	T	27.48 ±4.22	3.08 ±0.64	2.97 ±0.25	30.48 ±4.82
October 2015	C	31.92 ±6.83	3.75 ±0.73	3.27 ±0.28	27.26 ±7.82
	T	30.58 ±4.89	2.77 ±0.70	3.41 ±0.33	17.43 ±4.74
November 2015	C	29.30 ±4.93	3.01 ±0.74	3.32 ±0.27	29.18 ±5.84
	T	26.39 ±4.05	2.35 ±0.68	3.31 ±0.27	21.87 ±5.46
December 2015	C	31.43 ±5.97	3.37 ±0.61	3.41 ±0.28	28.19 ±5.33
	T	31.34 ±5.67	2.92 ±0.74	3.34 ±0.25	21.88 ±6.21

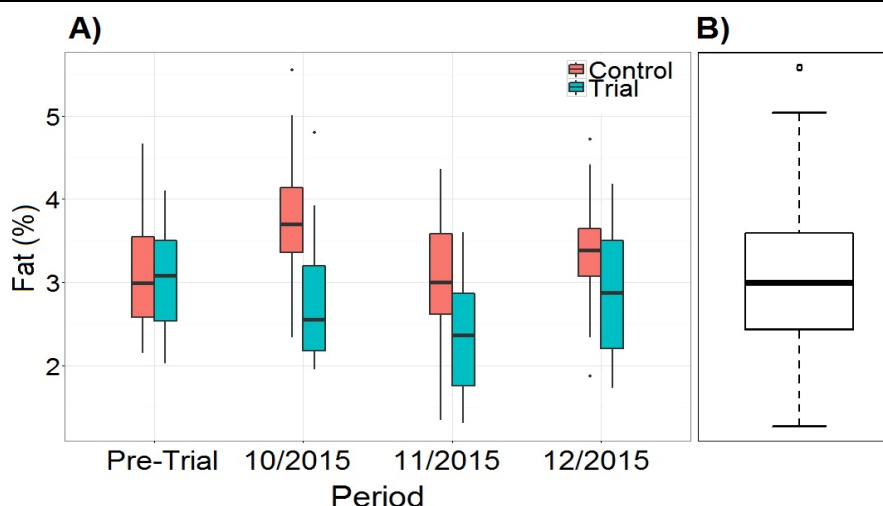

Figure 1 Differences of milk urea level (mg.100mL⁻¹) in the trial and control group during whole entire period.

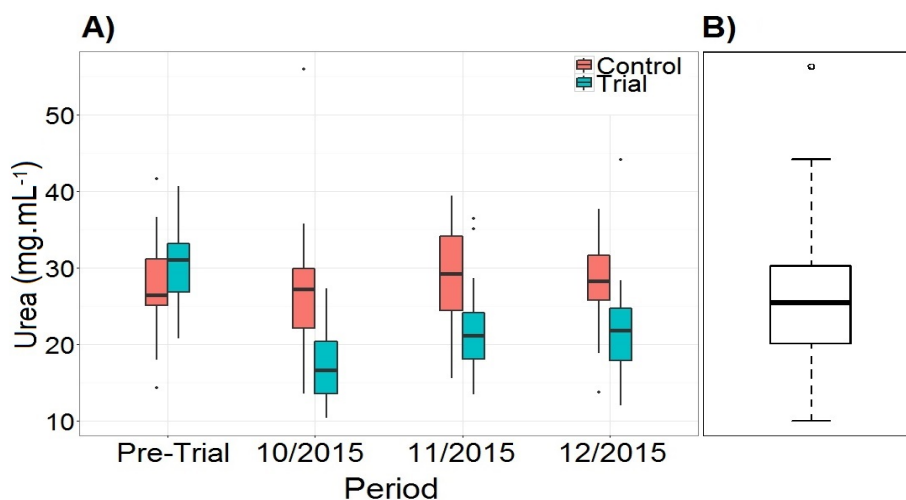

Figure 2 Differences of fat content (%) in the trial and control group during whole entire period.

Statistically significant depression in trial group was found for fat content (0.45%). Highly significant lower urea level was observed in trial group in December 2015 (6.22 mg.mL⁻¹).

After trial period of 3 months, calving rate was calculated as ratio of pregnant cows in the particular group. In the control group half of the cows, whereas in the trial group 68.97% of cows stayed pregnant.

According to observed results, diets with higher concentration of n-3 PUFA cause lower levels of urea in milk. **Thanh and Suksombat (2015)** detected tendency of lower concentration of Urea N in milk after feeding of linseed, sunflower and fish oils in different rations. In comparison with control group the amount of Urea N in milk after feeding of linseed and fish oils lower 1:1 (-2.51mg.100 mL⁻¹), sunflower and fish oils 1:1 (-2.58mg.100 mL⁻¹) and mix of oils (linseed, sunflower and fish oils) 1:1:1 (-2.27 mg.100 mL⁻¹) was lower.

Higher intake of n-3 PUFA caused lower milk production (from -0.39 to -1.39 kg.day⁻¹) in comparison with control group (**Thanh and Suksombat, 2015**). In contrary, **Bragaglio et al. (2015)** found higher milk yield +1.9 kg.day⁻¹ in trial group of animals supplemented with DHA. Then statistically significant decrease in milk protein content from -0.03% to -0.09% was found (**Thanh and Suksombat, 2015**). Complex of lipids in diets depressed protein (-0.08%) and fat concentration (-0.56%) in milk (**Bodkowski et al., 2016**). In group of animals with higher concentration of DHA higher fat (+1.27%) and the same milk protein content was found (**Bragaglio et al., 2015**). Diet enriched on n-3 PUFA reduced milk fat concentration from -0.34% to -1.05% (**Thanh and Suksombat, 2015**). The milk fat depression is caused by change of ruminal biohydrogenation which leads to the production of different various rumen intermediates and suppress the gene expression of lipogenic enzymes according to **Bauman and Griinari (2001)**.

Our results confirmed that supplementing dairy cow diets with fats containing PUFAs may improve reproductive functions through positive effects on the endocrine system, ovum, embryo, and synthesis of prostaglandins. Significant difference in calving rate (18.97%) was observed between control and trial group. The n-3 fatty acids are likely to improve the survival rate of embryos in cattle. According to study of **Zwyrzykowska and Kupczynski (2016)** the feeding of n-3 PUFA diet tended to increase the number of large follicles and decrease the non-fertilization and/or early embryo mortality rate. Nevertheless, the conception rate at 35 and 90 day after insemination was not affected by diet (**Elis et al., 2016**). Feeding n-6 PUFA after calving to the first estrous cycle and shifting to n-3 PUFA after the first estrous cycle might be a nutritional strategy to improve reproductive performance and increase the percentage of pregnancies per all inseminations in lactating dairy cows (**Dirandeh et al., 2012**).

CONCLUSION

The addition of DHA rich algae product (Algae STM Alltech Inc.) had effect on milk production, urea N concentration in milk, milk fat content and pregnant ratio of high yielding Holstein cows. Significant difference ($p > 0.05$) has been observed in level of urea in milk in

favour of trial group. In the control group in comparison with trial group lower milk production was found. The feeding of algae caused milk fat depression ($p < 0.05$) and generally lower protein content in milk ($p > 0.05$). Moreover, the results confirmed fact that supplementing dairy cow diets with fats containing PUFAs may improve reproductive functions and can represent effective strategy to increase the percentage of pregnancies per inseminations in lactating dairy cows.

REFERENCES

- Ambrose, D. J., Kastelic, J. P., Corbett, R., Pitney, P. A., Petit, H. V., Small, J. A., Zalkovic, P. 2006. Lower Pregnancy Losses in Lactating Dairy Cows Fed a Diet Enriched in α -Linolenic Acid. *Journal of Dairy Science*, vol. 89, no. 8, p. 3066-3074. [https://doi.org/10.3168/jds.S0022-0302\(06\)72581-4](https://doi.org/10.3168/jds.S0022-0302(06)72581-4)
- Angulo, J., Mahecha, L., Nuernberg, K., Nuernberg, G., Dannenberger, D., Olivera, M., Boutinaud, M., Leroux, C., Albrecht, E., BernardL. 2012. Effects of polyunsaturated fatty acids from plant oils and algae on milk fat yield and composition are associated with mammary lipogenic and SREBF1 gene expression. *Animal*, vol. 6, no. 12, p. 1961-1972. <https://doi.org/10.1017/S1751731112000845> PMID:22717104
- Bauman, D., Griinari, J. 2001. Regulation and nutritional manipulation of milk fat: low-fat milk syndrome. *Livestock Production Science*, vol. 70, no. 1-2, p. 15-29. [https://doi.org/10.1016/S0301-6226\(01\)00195-6](https://doi.org/10.1016/S0301-6226(01)00195-6)
- Bernal-Santos, G., Perfield, J. W. 2nd, Barbano, D. M., Bauman, D. E., Overton, T. R. 2003. Production Responses of Dairy Cows to Dietary Supplementation with Conjugated Linoleic Acid (CLA) during the Transition Period and Early Lactation. *Journal of Dairy Science*, vol. 86, no. 10, p. 3218-3228. [https://doi.org/10.3168/jds.S0022-0302\(03\)73925-3](https://doi.org/10.3168/jds.S0022-0302(03)73925-3)
- Bodkowski, R., Czyż, K., Kupczyński, R., Patkowska-Sokoła, B., Nowakowski, P., Wiliczekiewicz, A. 2016. Lipid complex effect on fatty acid profile and chemical composition of cow milk and cheese. *Journal of Dairy Science*, vol. 99, no. 1, p. 57-67. <https://doi.org/10.3168/jds.2015-9321> PMID:26506539
- Boeckeaert, C, Vlaeminck, B., Dijkstra J., Issa-Zacharia, A., Van Nespen, T., Van Straalen, W., Fievez, V. 2008. Effect of Dietary Starch or Micro Algae Supplementation on Rumen Fermentation and Milk Fatty Acid Composition of Dairy Cows. *Journal of Dairy Science*, vol. 9, no. 12, p. 4714-4727. <https://doi.org/10.3168/jds.2008-1178> PMID:19038948
- Bragaglio, A., Braghieri, A., Napolitano, F., De Rosa, G., Riviezz, A. M., Surianello, F., Pacelli, C. 2015. Omega-3 supplementation, milk quality and cow immune-competence. *Italian Journal of Agronomy*, vol. 10, no. 1, p. 9. <https://doi.org/10.4081/ija.2015.611>
- De Veth, M., Bauman, D., Koch, W., Mann, G., Pfeiffer, A., Butler, W. 2009. Efficacy of conjugated linoleic acid for improving reproduction: A multi-study analysis in early-lactation dairy cows. *Journal of Dairy Science*, vol. 92, no. 6, p. 2662-2669. <https://doi.org/10.3168/jds.2008-1845> PMID:19447999
- Dirandeh, E., Towhidi, A., Zeinoaldini, S., Ganjkanlou, M., Ansari Pirsaraei, Z., Fouladi-Nashta, A. 2012. Effects of different polyunsaturated fatty acid supplementations during the postpartum periods of early lactating dairy cows on milk yield, metabolic responses, and reproductive performances. *Journal of Animal Science*, vol. 91, no. 2, p. 713-721.

<https://doi.org/10.2527/jas.2012-5359>

PMid:23148256

Elis, S., Freret, S., Desmarchais, A., Maillard, V., Cognié, J., Briant, E., Dupont, J. 2016. Effect of a long chain n-3 PUFA-enriched diet on production and reproduction variables in Holstein dairy cows. *Animal Reproduction Science*, vol. 164, p. 121-132.

<https://doi.org/10.1016/j.anireprosci.2015.11.020>

PMid:26651949

Frančáková, H., Ivanišová, E., Dráb, Š., Krajčovič, T., Tokár, M., Mareček, J., Musilová, J. 2015. Composition of fatty acids in selected vegetable oils. *Potravinarstvo*, vol. 9, no. 1, p. 538-542. <https://doi.org/10.5219/556>

Glover, K. E., Budge, S., Rose, M., Rupasinghe, H. P., Maclaren, L., Green-Johnson, J., Fredeen, A. H. 2012. Effect of feeding fresh forage and marine algae on the fatty acid composition and oxidation of milk and butter. *Journal of Dairy Science*, vol. 95, no. 6, p. 2797-2809.

<https://doi.org/10.3168/jds.2011-4736>

PMid:22612917

Childs, S., Lynch, C. O., Hennessy, A. A., Stanton, C., Wathes, D. C., Sreenan, J. M., Diskin, M. G., Kenny, D. A. 2008. Effect of dietary enrichment with either n-3 or n-6 fatty acids on systemic metabolite and hormone concentration and ovarian function in heifers. *Animal*, vol. 2, no. 6, p. 883-893.

<https://doi.org/10.1017/S1751731108002115>

PMid:22443668

Leroy, J. L. M. R., Sturme, R. G., Van Hoeck, V., De Bie, J., McKeegan, P. J., Bols, P. E. J. 2013. Dietary lipid supplementation on cow reproductive performance and oocyte and embryo viability: a real benefit? *Animal Reproduction Science*, vol. 10, no. 3, p. 258-267.

Lucy, M. C. 2001. Reproductive Loss in High-Producing Dairy Cattle: Where Will It End? *Journal of Dairy Science*, vol. 84, no. 6, p. 1277-1293.

[https://doi.org/10.3168/jds.S0022-0302\(01\)70158-0](https://doi.org/10.3168/jds.S0022-0302(01)70158-0)

Lum, K. K., Kim, J., Lei, X. G. 2013. Dual potential of microalgae as a sustainable biofuel feedstock and animal feed. *Journal of Animal Science and Biotechnology*, vol. 4, no. 1, p. 53.

<https://doi.org/10.1186/2049-1891-4-53>

PMid:24359607

Mattos, R., Staples, C. R., Artech, A., Wiltbank, M. C., Diaz, F. J., Jenkins, T. C., Thatcher, W. W. 2004. The Effects of Feeding Fish Oil on Uterine Secretion of PGF₂α, Milk Composition, and Metabolic Status of Periparturient Holstein Cows. *Journal of Dairy Science*, vol. 87, no. 4, p. 921-932.

[https://doi.org/10.3168/jds.S0022-0302\(04\)73236-1](https://doi.org/10.3168/jds.S0022-0302(04)73236-1)

Moate P. J., Williams, S. R., Hannah, M. C., Eckard, R. J., Auld, M. J., Ribaux B. E., Jacobs, J. L., Wales, W. J. 2013. Effects of feeding algal meal high in docosahexaenoic acid on feed intake, milk production, and methane emissions in dairy cows. *Journal of Dairy Science*, vol. 96, no. 5, p. 3177-3188.

<https://doi.org/10.3168/jds.2012-6168>

PMid:23498011

Nitrayová, S., Brestenský, M., Heger, J., Patráš, P., Rafay, J., Sirotkin, A. 2014. Amino acids and fatty acids profile of chia (*Salvia Hispanica* L.) And flax (*Linum Usitatissimum* L.) seed. *Potravinarstvo*, vol. 8, no. 1, p. 72-76.

<https://doi.org/10.5219/332>

Rodney, R. M., Celi, P., Scott, W., Breinhild, K., Lean, I. J. 2015. Effects of dietary fat on fertility of dairy cattle: A meta-analysis and meta-regression. *Journal of Dairy Science*, vol.

98, no. 8, p. 5601-5620. <https://doi.org/10.3168/jds.2015-9528>

PMid:26094218

SAS Institute Inc. 2012. Administering SAS® Enterprise Guide® 5.1. Cary, NC: SAS Institute Inc.

Stamey, J. A., Shepherd, D. M., de Veth, M. J., Corl, B. A. 2012. Use of algae or algal oil rich in n-3 fatty acids as a feed supplement for dairy cattle. *Journal of Dairy Science*, vol. 95, no. 9, p. 5269-5275. <https://doi.org/10.3168/jds.2012-5412>

PMid:22916931

Thanh, L. P., Suksombat, W. 2015. Milk Yield, Composition, and Fatty Acid Profile in Dairy Cows Fed a High-concentrate Diet Blended with Oil Mixtures Rich in Polyunsaturated Fatty Acids. *Asian Australas. Journal of Animal Science*, vol. 28, no. 6, p. 796-806.

<https://doi.org/10.5713/ajas.14.0810>

PMid:25925057

Thatcher, W., Bilby, T., Bartolome, J., Silvestre, F., Staples, C., Santos, J. 2006. Strategies for improving fertility in the modern dairy cow. *Theriogenology*, vol. 65, no. 1, p. 30-44.

<https://doi.org/10.1016/j.theriogenology.2005.10.004>

PMid:16280156

Thatcher, W., Santos, J. E. P., Staples, Ch. R. 2011. Dietary manipulations to improve embryonic survival in cattle. *Theriogenology*, vol. 76, no. 9, p. 1619-1631.

<https://doi.org/10.1016/j.theriogenology.2011.06.005>

PMid:21924473

Zachut, M., Dekel, I., Lehrer, H., Arieli, A., Arav, A., Livshitz, L., Moallem, U. 2010. Effects of dietary fats differing in n-6:n-3 ratio fed to high-yielding dairy cows on fatty acid composition of ovarian compartments, follicular status, and oocyte quality. *Journal of Dairy Science*, vol. 93, no. 2, p. 529-545. <https://doi.org/10.3168/jds.2009-2167>

PMid:20105525

Zwyrzykowska, A., Kupczynski, R. 2014. Application of dietary fish oil in dairy cow reproduction. *Turkish Journal of Veterinary and Animal Science*, vol. 38, no. 6, p. 618-624. <https://doi.org/10.3906/vet-1404-57>

Acknowledgments:

The project was supported by the Slovak National Scientific Grant Agency VEGA, Grant No. 1/0723/15.

Contact address:

Juraj Karcol, Karcol Dairy Consulting, Parkové nábrežie 5, 949 01 Nitra, the Slovak Republic, E-mail: karcoljuraj@stonline.sk

Radovan Kasarda, Slovak University of Agriculture, Faculty Agrobiolgy and Food Resources, Department of Animal Genetics and Breeding Biology, Tr. A. Hlinku 2, 949 76 Nitra, Slovakia, E-mail: radovan.kasarda@uniag.sk

Milan Šimko, Slovak University of Agriculture in Nitra, Faculty of Agrobiolgy and Food Resources, Department of Animal Nutrition, Tr. A. Hlinku 2, 949 76 Nitra, Slovakia, E-mail: milan.simko@uniag.sk

Ondrej Hanušovský, Slovak University of Agriculture in Nitra, Faculty of Agrobiolgy and Food Resources, Department of Animal Nutrition, Tr. A. Hlinku 2, 949 76 Nitra, Slovakia, E-mail: xhanusovsky@is.uniag.sk



EFFECTS OF FLORAL HONEY AND PRESSED FLAX SEEDS ON INTENSITY OF YOGURT AROMA, SWEETNESS AND SOUR TASTE OF YOGURTS DURING STORAGE

Zuzana Remeňová, Margita Čanigová, Miroslav Kročko, Viera Ducková, Andrea Šimková

ABSTRACT

The aim of this study was to evaluate chosen sensory properties of yogurts without any additions of honey and pressed flax seeds (K) and with the different addition of floral honey (1, 3 and 5%) and with the same addition (0.5%) of pressed flax seeds (PA, PB and PC) during storage. These samples were analysed during 14 days of storage at cooling temperature (6 ± 1 °C). Sensory properties – intensity of yogurt aroma, sweetness and sour taste were evaluated. Sensory evaluation was carried out in the 1st, 7th and 14th day following the yogurts production. The control samples had the most significant yogurt aroma this sample had also the highest sour taste and the lowest sweet taste throughout the storage. In all of analysed samples, the sourest taste was observed 14th day of storage. The sweet taste of yogurts with honey addition increased compared to control samples however the sweetest taste of samples with addition of honey was 1st day following the yogurt production. Optimum sweetness was determined with the samples of yogurts containing 5% of floral honey. Floral honey added into the yogurts has positive effect on their sensory properties. The pressed flax seeds have no effect on sensory properties of yogurts. The enrichment of yogurts with honey and pressed flax seeds is high recommended because they have a lot of beneficial nutritional properties and improve the sensory quality of the final product.

Keywords: Yogurt; floral honey; pressed flax seeds; sensory properties

INTRODUCTION

Yogurt is fermented dairy product procured through of the action lactic acid bacteria *Streptococcus thermophilus* and *Lactobacillus delbrueckii* subsp. *bulgaricus*. Lactic acid is produced in the process of fermentation of lactose by yogurt culture. Lactic acid acts on milk protein, it forms the characteristic structure and sensory properties of yogurt. The content of milk fat in yogurts directly influences the final hardness of the gel structure. The reason for less desirable structure, taste and flavour can be the low content of milk fat in yogurts (Serafeimidou et al., 2013; Caleja et al., 2016; Yu et al., 2016).

The presence of a high number of lactic acid bacteria may causes therapeutic effects of yogurt on health, such as digestion enhancement, appetite enhancement, anticarcinogenic activity, and decrease of cholesterol. In addition, yogurt contains many proteins, minerals and vitamins, for instance, riboflavin, vitamins B₆ and B₁₂ and calcium (O'Sullivan et al., 2016; Yu et al., 2016).

Williams et al. (2015) found that the consumers of dairy products have higher intakes of protein, calcium, magnesium, phosphorus, and vitamin D, which all have a provable benefit for bone health. Dairy products such as yogurts can help to prevent the lower risk of emergence of

hypertension, coronary heart disease, type 2 diabetes mellitus, and obesity. Calcium in dairy products may increase weight loss in obese but only when energy intake is restricted and calcium intake is increased from inadequate to adequate level.

The ambition to provide nutritive rich food foodstuffs with appetizing flavour increased with the development of technologies and the growing competition. The flavour of yogurts may increase its demand by consumers. The flavor and structure of yogurts may vary depending on the type of milk and culture, fermentation process and temperature. The flavour of yogurts is characterful but also popular. The sweeteners, flavourings and other ingredients are added in order to modify the flavour of yogurts (Routray and Mishra, 2011). Yogurts with honey and pressed flax seeds are not widely available in trade network.

According to the definition set by Codex Alimentarius "Honey is the natural sweet substance produced by honey bees from the nectar of plants or from secretions of living parts of plants or excretions of plant sucking insects on the living parts of plants, which the bees collect, transform by combining with specific substances of their own, deposit, dehydrate, store and leave in the honey comb to ripen and mature" (Codex Stan, 2001). Honey is the nutritionally

valuable substance, which contains a mixture of fructose and glucose (65%), water (18%), proteins, organic and amino acids, lipids, vitamins, minerals, enzymes, phenolic acids, flavonoids and pollen grains. The type of flower, honey bees, climate, weather conditions, zone, as well as processing, manipulation, packaging and storage have an impact on properties of honey such as the composition, flavour, aroma and colour. Many substances found in honey, for instance flavonoids, phenolic acids, ascorbic acid, some enzymes, carotenoids, organic acids, have antioxidant properties, which are effective in lowering the risk of cancer, heart disease, inflammation, asthma and cataract. Ripe honey is considered to be relatively sterile foodstuff. High sugar content, low water activity and hydrogen peroxide and some other components of honey have antibacterial effects against pathogenic bacteria, antifungal, antiviral, antitumor activities and some of them have the positive effects on the wound healing and various skin diseases. Honey is incorporated into food products, because it improves their taste and increases their nutritional value (Kňazovická et al., 2015; Solayman et al., 2015; Yousuf et al., 2016; Kadri et al., 2017).

Flax (*Linum usitatissimum* L.) is deemed as multipurpose plant because the fibers are processed to manufacture of textiles and the seeds are pressed to extract linseed oil. Linseeds are the source of oil with the content of omega-3 fatty acids, which are interesting for human nutrition, cosmetic and pharmaceutical industry. Linseeds contain many bioactive substances, so have a positive effect on prevention against cardiovascular diseases, hypertension and cholesterol levels. During of pressing of the linseed is created the seedcake as by-product. It contains nutritional valuable compounds which have antimicrobial, antifungal, antitumor and anti-inflammatory activities. Linseeds in one of their many forms may be incorporating into bakery products, pasta or dairy products (Edel et al., 2015; Zuk et al., 2015).

Addition of natural products into some food products affects their taste, aroma and structure, so sensory quality plays a key role for food acceptance. Taste and aroma are characteristic properties of food, which determine consumer acceptance of products. Taste sensation is dependent on the taste receptor cells located in the mouth. The sensation can be described as sweet, salty, sour, bitter, and umami. The sensation aroma is the result of the interaction of the volatile food components with the olfactory receptors. Before any new food innovation, sensory evaluation with using different sensory analysers is encouraged (Routray and Mishra, 2011).

The aim of this study was to evaluate chosen sensory properties of yogurts with addition of pressed flax seeds and honey and compare them with a control samples without any additions of pressed flax seeds and honey.

MATERIAL AND METHODOLOGY

Yogurts were made and assessed in Department of Evaluation and Processing of Animal Products, Slovak University of Agriculture in Nitra. Semi-skimmed milk with fat content of 1.5% obtained from trade network was used for yogurts production. The milk was heated on a temperature 40 – 42 °C, mixed with skimmed milk powder and then again heated on 80 – 82°C during two minutes. Then the cooled milk was inoculated with yogurt culture

(Laktoflora[®], Milcom a. s., Czech Republic) and inoculated milk was dosed into sealable glasses. This product was marked as control sample (K). To all experimental samples (PA, PB, PC) were added 0.5% of pressed flax seeds Raciol 4A (Šumperk, Czech Republic). These experimental samples of yogurts were divided to three groups: first group of samples (PA) additionally contain of 1% of honey, second groups of samples (PB) additionally contain of 3% of honey and third groups of samples (PC) additionally contain of 5% of honey. The fermentation of milk was carried out at temperature 42 – 43 °C during three hours. The final products were stored at 6 ± 1 °C during 14 days.

Sensory properties – intensity of yogurt aroma, sweetness and sour taste, were evaluated. Sensory analysis was performed by four-member committee of assessors who evaluated selected parameters by five point scale. Evaluation was carried out in the 1st, 7th and 14th day following the yogurts production. Experiment was carried out at three times.

The data were analysed using software Microsoft Office Excel 2007. The results were represented by graph. Each experiment was evaluated at least three times and the resulting curve was calculated as the mean value of these evaluations. Obtained results were processed by variation-statistical methods in ANOVA. The differences between groups were considered significant at $p < 0.05$.

RESULTS AND DISCUSSION

The flavour of dairy products is characterized by numerous volatile bacterial metabolites, some of which are by-products of fermentation. Lactic acid is one of the major compounds significantly contributing to yogurts flavour. The aromatic components, such as acetaldehyde, acetone, acetoin, diacetyl, acetic acid, formic, butanoic and propanoic acid have significant influence on the final yogurt flavour (Pinto et al., 2009; Routray and Mishra, 2011). The most intensive yogurt aroma during the storage period was found in samples of control yogurts (K) while the lowest intensive of yogurt aroma during the storage period was determined in the samples of yogurts with highest addition of honey (PC) (Figure 1). The differences among control sample and PC sample in yogurt aroma were statistically significant ($p < 0.05$). These findings may be probably caused by the strong characteristic aroma of honey, which suppresses the characterful aroma of yogurts samples. No undesirable aroma was detected in all of analysed samples during storage.

The most intensive sour taste was observed in the samples of yogurts without honey addition (K). The sour taste decreased gradually with increased addition of honey (Figure 2). The samples with the highest addition of honey had the lowest intensity of sour taste (PC). Statistically significant differences ($p < 0.05$) were found between control sample and PC sample in sour taste. The highest intensity of sour taste in all analysed samples of yogurts was observed after 14 days of storage.

Mercan and Akin (2016) reported that one reason of flavourings or sweeteners addition is increase its flavour because yogurts have a sour taste. They found that, yogurts with honey addition had higher sweetness than the control samples. The aroma and sweetness points decreased in all of yogurts with pine honey during storage. The addition of

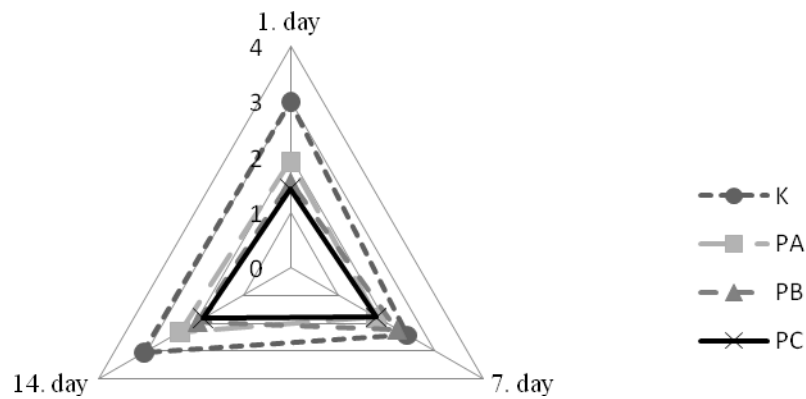

Figure 1 Sensory evaluation of yogurt aroma in yogurts stored at 6 ± 1 °C during 14 day.

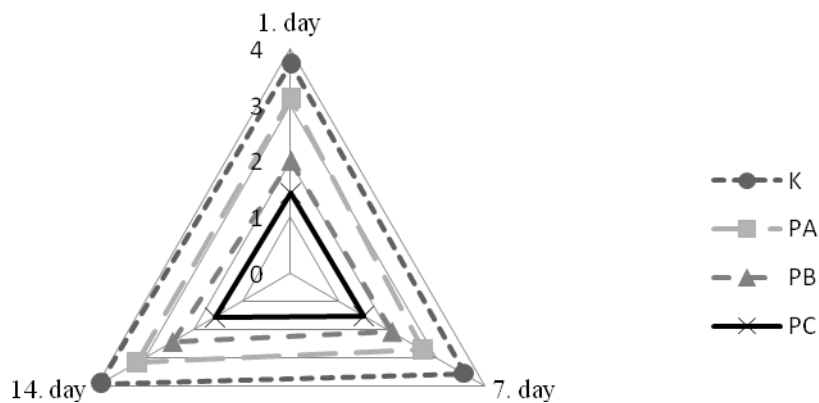

Figure 2 Sensory evaluation of sour taste in yogurts stored at 6 ± 1 °C during 14 day.

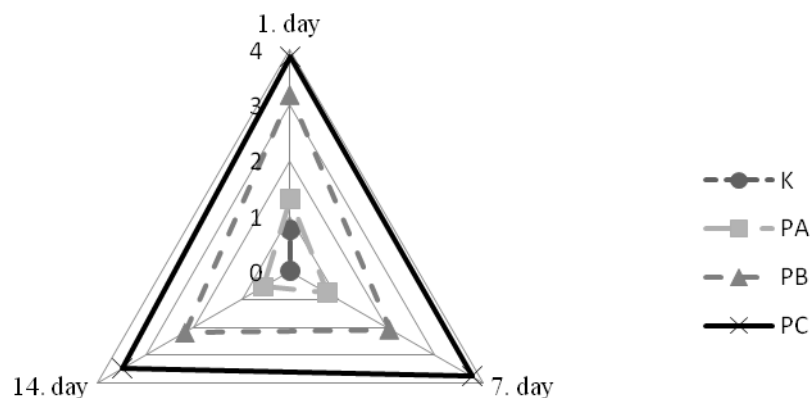

Figure 3 Sensory evaluation of sweet taste in yogurts stored at 6 ± 1 °C during 14 days.

pine honey had no negative effect on sensory properties. Pine honey has no incisive aroma or taste, has a low tendency to crystallize and also a significant antioxidant activity.

Popa and Ustunol (2011) prepared the low-fat strawberry yogurt with five alternative sweeteners in the dose 7%: sucrose, high-fructose corn syrup, sage, alfalfa,

and sourwood honeys. Sage honey is light with the predominant sweet taste, clover-like flavour and floral aftertaste. Alfalfa honey is white with a mild taste and its aroma is similar beeswax. Sourwood honey has a sweet, spicy, anise aroma and taste. They found that the taste of the sucrose-sweetened samples were rated higher than the next samples with the addition of sage honey, high-

fructose corn syrup, alfalfa, and sourwood honey, respectively. Sourwood honey was least preferred sweetener and the main reason was probably an anise flavour.

The sweetest taste had the samples with the highest addition of honey (PC), while the lowest sweet taste had the samples without honey addition (K) (Figure 3). The differences between PC sample and control sample in sweet taste were statistically significant ($p < 0.05$). The sweetest taste of all analysed samples was determined at the first day after yogurts production. The sweet taste of all samples with honey addition decreased during storage. The control samples had no sweet taste as early as after 7 days of storage.

Varga (2006) studied 1, 3 and 5% presence of acacia honey in yogurt during storage at 4 °C and found that the samples of yogurt containing of honey 3% had optimum sweetness. The samples with the lowest concentration of acacia honey (1%) were weak in flavour and the samples with 5% were too sweet and too strong in honey flavour.

Sert et al. (2010) studied the effect of sunflower honey addition (2, 4 and 6%) on the properties of yogurt during storage at 4 °C. The flavour intensity of yogurt with the lowest concentration of honey was similar to control samples without honey addition. The sample with 6% honey addition had the highest sweetness. Finally, the optimal addition of honey was determined as 4% sunflower honey.

It was found that in all of analysed samples were not any undesirable tastes. The pressed flax seeds had no effect on sensory properties of yogurts.

In general, the scores for overall acceptability of yogurt containing added floral honey and pressed flax seeds were greater ($p < 0.05$) than those for yogurt without added honey and pressed flax seeds.

The comparable findings of sensory evaluation of goat yogurts with addition of honey were found by **Machado et al. (2017)**.

CONCLUSION

The aim of this study was to determine whether the addition of pressed flax seeds and honey has effect on chosen sensory properties of yogurts. Yogurts with occurrence of pressed flax seeds and honey produced in our experiments and stored at 6 °C were positively perceived by assessors till 14th day of storage. The control samples had the most intensity of yogurt aroma, the sourest taste and the lowest sweet taste during the storage. The sweetest taste had the sample with the highest addition of honey. The sweet taste of all analysed samples decreased in the storage period. No undesirable aroma and taste were found in all of analysed samples. This research has shown that honey added into the yogurts has positive effects on their sensory properties. The pressed flax seeds have no effect on sensory properties of yogurts however they increase nutritional value of yogurts. Optimum sweetness was determined with the samples containing 5% honey.

Yogurt with addition of pressed flax seed and honey can have beneficial effects on human body. These products may be more attractive for consumers, because many consumers are interested in healthy lifestyle and also want to eat delicious food.

REFERENCES

- Caleja, C., Barros, L., Antonio, A. L., Carocho, M., Oliveira, M. B. P. P., Ferreira, I. C. F. R. 2016. Fortification of yogurts with different antioxidant preservatives: A comparative study between natural and synthetic additives. *Food Chemistry*, vol. 210, p. 262-268. <https://doi.org/10.1016/j.foodchem.2016.04.114> PMID:27211646
- Codex Standard:2001. *Codex Standard for Honey 12-1981. Adopted in 1981. Revisions 1987 and 2001.*
- Edel, A. L., Aliani, M., Pierce, G. N. 2015. Stability of bioactives in flaxseed and flaxseed-fortified foods. *Food Research International*, vol. 77, part 2, p. 140-155. <https://doi.org/10.1016/j.foodres.2015.07.035>
- Kadri, S. M., Zaluski, R., Orsi, R. D. O. 2017. Nutritional and mineral contents of honey extracted by centrifugation and pressed processes. *Food Chemistry*, vol. 218, p. 237-241. <https://doi.org/10.1016/j.foodchem.2016.09.071> PMID:27719904
- Kňazovická, V., Bačiková, A., Bányiová, R., Tkáčová, J., Čanigová, M., Haščík, P. 2015. Honey characteristics after extraction and half-year storage. *Potravinarstvo*, vol. 9, no. 1, p. 543-549. <https://dx.doi.org/10.5219/560>
- Machado, T. A. D. G., Gomes De Oliveira, M. E., Campos, M. I. F., Antonino De Assis, P. O., Leite De Souza, E., Madruga, M. S., Pacheco, M. T. B., Pintado, M. M. E., Queiroga, R. C. R. E. 2017. Impact of honey on quality characteristics of goat yogurt containing probiotic *Lactobacillus acidophilus*. *LWT - Food Science and Technology*, vol. 80, p. 221-229. <https://doi.org/10.1016/j.lwt.2017.02.013>
- Mercan, E., Akin, N. 2016. Effect of different levels of pine honey addition on physicochemical, microbiological and sensory properties of set-type yoghurt. *International Journal of Dairy Technology*, vol. 70, no. 2, p. 245-252. <https://doi.org/10.1111/1471-0307.12332>
- O'sullivan, A. M., O'grady, M. N., O'callaghan, Y. C., Smyth, T. J., O'brien, N. M., Kerry, J. P. 2016. Seaweed extracts as potential functional ingredients in yogurt. *Innovative Food Science & Emerging Technologies*, vol. 37, part B, p. 293-299.
- Pinto, S., Clemente, M. D. G., De Abreu, L. R. 2009. Behaviour of volatile compounds during the shelf life of yoghurt. *International Journal of Dairy Technology*, vol. 62, no. 2, p. 215-223. <https://doi.org/10.1111/j.1471-0307.2009.00476.x>
- Popa, D., Ustunol, Z. 2011. Sensory attributes of low-fat strawberry yoghurt as influenced by honey from different floral sources, sucrose and high-fructose corn sweetener. *International Journal of Dairy Technology*, vol. 64, no. 3, p. 451-454. <https://doi.org/10.1111/j.1471-0307.2011.00694.x>
- Routray, W., Mishra, H. N. 2011. Scientific and Technical Aspects of Yogurt Aroma and Taste: A Review. *Comprehensive Reviews in Food Science and Food Safety*, vol. 10, no. 4, p. 208-220. <https://doi.org/10.1111/j.1541-4337.2011.00151.x>
- Serafeimidou, A., Zlatanov, S., Kritikos, G., Tourianis, A. 2013. Change of fatty acid profile, including conjugated linoleic acid (CLA) content, during refrigerated storage of yogurt made of cow and sheep milk. *Journal of Food Composition and Analysis*, vol. 31, no. 1, p. 24-30. <https://doi.org/10.1016/j.jfca.2013.02.011>
- Sert, D., Akin, N., Dertli, E. 2010. Effects of sunflower honey on the physicochemical, microbiological and sensory characteristics in set type yoghurt during refrigerated storage.

International Journal of Dairy Technology, vol. 64, no. 1, p. 99-107. <https://doi.org/10.1111/j.1471-0307.2010.00635.x>

Solayman, Islam, A., Paul, S., Ali, Y., Khalil, I., Alam, N., Gan, S. H. 2015. Physicochemical Properties, Minerals, Trace Elements, and Heavy Metals in Honey of Different Origins: A Comprehensive Review. *Comprehensive Reviews in Food Science and Food Safety*, vol. 15, no. 1, p. 219-233.

Varga, L. 2006. Effect of acacia (*Robinia pseudo-acacia* L.) honey on the characteristic microflora of yogurt during refrigerated storage. *International Journal of Food Microbiology*, vol. 108, no. 2, p. 272-275. <https://doi.org/10.1016/j.ijfoodmicro.2005.11.014>
PMid:16478638

Williams, E. B., Hooper, B., Spiro, A., Stanner, S. 2015. The contribution of yogurt to nutrient intakes across the life course. *Nutrition Bulletin*, vol. 40, no. 1, p. 9-32. <https://doi.org/10.1111/nbu.12130>

Yousuf, F. A., Mehmood, M. H., Malik, A., Siddiqui, R., Khan, N. A. 2016. Antiacanthamoebic properties of natural and marketed honey in Pakistan. *Asian Pacific Journal of Tropical Biomedicine*, vol. 6, no. 11, p. 967-972. <https://doi.org/10.1016/j.apjtb.2016.05.010>

Yu, H., Wang, L., McCarthy, K. L. 2016. Characterization of yogurts made with milk solids nonfat by rheological behavior and nuclear magnetic resonance spectroscopy. *Journal of Food and Drug Analysis*, vol. 24, no. 4, p. 804-812. <https://doi.org/10.1016/j.jfda.2016.04.002>

Zuk, M., Richter, D., Matuła, J., Szopa, J. 2015. Linseed, the multipurpose plant. *Industrial Crops and Products*, vol. 75, part B, p. 165-177.

Contact address:

Zuzana Remeňová, Slovak University of Agriculture in Nitra, Faculty of Biotechnology and Food Sciences, Department of Animal Products Evaluation and Processing, Tr. A. Hlinku 2, 949 76 Nitra, Slovakia, E-mail: xremenovaz@uniag.sk

Margita Čanigová, Slovak University of Agriculture in Nitra, Faculty of Biotechnology and Food Sciences, Department of Animal Products Evaluation and Processing, Tr. A. Hlinku 2, 949 76 Nitra, Slovakia, E-mail: margita.canigova@uniag.sk

Miroslav Kročko, Slovak University of Agriculture in Nitra, Faculty of Biotechnology and Food Sciences, Department of Animal Products Evaluation and Processing, Tr. A. Hlinku 2, 949 76 Nitra, Slovakia, E-mail: mirokrocko@yahoo.com

Viera Ducková, Slovak University of Agriculture in Nitra, Faculty of Biotechnology and Food Sciences, Department of Animal Products Evaluation and Processing, Tr. A. Hlinku 2, 949 76 Nitra, Slovakia, E-mail: viera.duckova@uniag.sk

Andrea Šimková, Slovak University of Agriculture in Nitra, Faculty of Biotechnology and Food Sciences, Department of Animal Products Evaluation and Processing, Tr. A. Hlinku 2, 949 76 Nitra, Slovakia, E-mail: andrea.simkova@uniag.sk



PREPARATION OF MALTS FOR PRODUCTION OF SPECIAL BEERS

Hana Kábelová-Ficová, Stanislav Kráčmar, Tomáš Gregor, Miroslav Fišera, Jozef Golian, Vlastimil Kubáň, Tomáš Šopík

ABSTRACT

The article deals with production of various malts intended for manufacture of special types of beer. The malts were used to brew samples of beer with alcoholic strength ranging between 8 – 12% EPM. The above range of original wort content was chosen due to its suitability for sensory evaluation and properties; in stronger types of beer, (more than 12% EPM), nature of the beverage can be drown by mashy flavour. In the experimental samples, the actual residual extract oscillated between 4.0 – 6.5%. The content of ethanol corresponded to the degree of fermentation and thereby also to the residual actual extract in balance equilibrium specifying that higher residual extract corresponds to lower content of alcohol by volume. It ranged between 2.5 – 5.0%. The sample 1 contained the highest amount of ethanol by mass (3.9%) and the sample 13 showed the lowest one (1.9%); alike trend of ethanol content by volume was revealed (5 and 2.44%, respectively). The highest content of actual and apparent extract was found in the sample 2 (6.6 and 5.2%, respectively); the sample 13 showed the lowest levels (4.0 and 3.1%, respectively). The original wort extract content averaged 9.9% in most of the samples; the sample 1 showed distinctly higher value (12.6%) and, on the contrary, the sample 13 demonstrated the lowest one (7.4%). The highest relative density was revealed in the sample 2 (1.02%) and the lowest one in the sample 13 (1.01%). Considering differences in osmotic pressure, the sample 1 exhibited the highest value (1045 mOs) and the sample 13 the lowest one (551 mOs). The highest level of fermentation was found in the sample 19 (61.7%), the lowest one was proved in the sample 19 (44.0%). Sensory analysis corresponded to originality and characteristics of each sample. The sample of beer made from spring barley was evaluated to be the best one.

Keywords: kinds of malts; beers; specialty malts; malt production; brewing

INTRODUCTION

Differences between individual beers are given by production related factors such as ingredients used, technological aspects of brewing process, and fermentation procedures applied. Small and restaurant breweries can manufacture specialty types of beer and approach thus production of the traditional formerly brewed beers (Basařová et al., 2010).

Basařová et al. (2010) also report Pilsner light and the Munich malts to be the most widely used malts worldwide; the former malts are used in production of light beers and the latter ones are utilized in manufacture of dark beers. Besides the above malts, other special malts emphasizing some typical qualitative features and characteristics of basic types of beer or distinguishing certain specific beers from the common light and dark ones are produced, too.

Because of the product quality and also due to technological aspects, the malt from one barley (or other grain crops) variety or from two genetically related varieties must be used in beer brewing (Briggs, 1998;

Basařová et al., 2010; Křížanová et al., 2010; PIVOBIERALE, 2011).

In malt making, the spring barley is considered to be the most commonly used cereal. The properties of barley varieties significantly influence quality of both malt and beer.

Malt supplies the main portion of extractive substances and it, together with technological procedures applied, influences redox capacity of beer, which plays an important role in beer resistance against formation of non-biological turbidity and in targeted sensory stability of beer.

Purity, properties of used varieties of cereals, homogeneity, and the level of malt modification represent the most significant characteristics of malt. Optimum progress of manufacturing technology steps and development of fundamental analytical and sensory characteristics of beer are determined by quality of malt. Malt yield plays no less important role (Briggs and Hough, 1981; Briggs, 1998; Basařová et al., 2010; Ganbaatar et al., 2015).

Specialty malts differ from the common ones, mainly barley malts, in a series of characteristics such as enzyme activity, colour, odour, acidity, or redox capacity. They are used in production of special beers. Specialty malts are also added to malts substitutes or they modify selected characteristics of beer wort produced from common malt. Their addition to common malts results primarily in modification of sensory properties like flavour, colour, foam or aroma (Briggs, 1998).

The following types of malts rank among the specialty malts: caramel, colouring, smoked, melanoidin, diastatic, acidic (proteolytic) malts and malts enhancing the redox capacity of beers.

Brewing water, a basic ingredient, is required to show drinking water quality. Its composition influences critically the quality of the product. Moreover, all the processes taking places in brewing are affected by water characteristics like by content of particular ions, especially during mashing and hops boiling (Briggs and Hough, 1981; Kosař and Procházka, 2000).

Chládek (2007) reports, that both the industrially produced beers and the homemade ones cannot be brewed without using proper strains of yeast.

For production of specialty beers like Ales and others, the foreign manufacturers mostly use the top-fermenting yeast (*Saccharomyces cerevisiae*, var. *cerevisiae*) that is surfaced by the evolved carbon dioxide where it forms cover or film called “kreuzen”. Fermentation is implemented at 20 – 24 °C.

In the Czech and Slovak Republic, mainly bottom-fermenting yeast (*Saccharomyces carlsbergensis*) is used in brewing industry. It is utilized for the production of Pilsner type beers and lagers. During beer production, fermentation takes place at 8 – 14 °C. After its completion, the yeasts fall downward to the fermentation tank bottom.

In brewing, an irreplaceable role is played by hops and hops products that impart Czech beers typical bitterness and also aroma distinguishing beer from other alcoholic or non-alcoholic beverages. Moreover, hops also influence the production process and other qualitative features of beer. Only female plants are used in brewing industry; they form hop cones that are considered essential ingredients for beer brewing (Basařová et al., 2010).

Polyphenolic substances, hop oils and hop resins represent the main hops components which are essential

for brewing technology. Due to their high reactivity, the polyphenols are considered to be crucial for beer brewing. In the completed beer, they act as stabilizers and protect hop resins against oxidation (Hough et al., 1982; Kosař and Procházka, 2000; Basařová et al., 2010; Ganbaatar et al., 2015).

Basařová et al. (2010) reports that throughout the history, the determining characteristics of beers have been developing dependent on technological conditions and procedures employed. Transparency, turbidity, foam, bitterness, character of bitterness, bite, and colour represent the most distinct properties of beer.

The aim of the study was to produce specialty malts and, moreover, using the microproduction method, we intended to brew 19 samples of specialty beers obtained by combination of specialty malts and various types of hops.

MATERIAL AND METHODOLOGY

The Pilsner and colouring malt was purchased from the Sladovna BERNARD, a.s. (Bernard Malt-House, joint-stock company), Czech Republic. The smoked malt was obtained from the SLADOVNA, spol. s r.o. (SLADOVNA, Ltd) company, Bruntál, Czech Republic. Production of specialty malts from various cereals such as winter or spring barley, corn, rye, and oats was implemented in the micro-malt house of the Mendel University in Brno, Czech Republic.

The grains (1000 g) of the cereals were stored in steel samplers and placed into soaking boxes with the water level overlap of 2 – 3 cm. The cereals were soaked with water for 48 hours in three 6-hour cycles with 10-hour air breaks. All the soaking procedures were implemented at 12 – 14 °C. The grains underwent germination in water for 6 days at 12 – 13 °C; the temperature of grain was 13 – 14 °C. Kilning was implemented for 1 day at gradually increasing temperature; it was carried out under a sieve (45 – 77 °C) and above a sieve (50 – 79 °C). Using a sieve, hand removal of sprouts from dry germinated malt was done one week after kilning. The following types of hops were purchased from the ARIX s.r.o. (Arix, Ltd) company: Žatecký poloraný červeňák, Premiant, Kazbek, Agnus, and Perle. For micro-production of specialty beers, a liquid preparation containing the RIBM 95 – Lager Yeast strain was used. It is a traditional strain originating in

Table 1 Combinations of malts and hops used in brewing samples of special beers.

sample	malt	hop	beer	EPM%	sample	malt	hop	beer	EPM%
1	MP	PRE+ZPC	LA	12.6	11	MP+MR*	PRE+KAZ	DR	8.9
2	MWB	AGN+ZPC	LA	11.3	12	MP+MM*	AGN+KAZ	DR	8.8
3	MSB	PRE+KAZ	DR	10.9	13	MP+MM*	PRE+KAZ	LI	7.4
4	MP+MM*	ZPC	DR	10.3	14	MP+MO*	AGN	DR	10.2
5	MP+MM*	PER	DR	8.6	15	MP+MO*	PRE+KAZ	DR	8.0
6	MP+MR*	ZPC	DR	10.9	16	MP+MO*	ZPC	DR	10.5
7	MP+MR*	PER	DR	9.3	17	MP+MO*	PER	DR	8.4
8	MP+MR*	KAZ	LA	11.7	18	MP+MO*	KAZ	DR	10.1
9	MP+MR*	PRE+ZPC	DR	10.3	19	MP+MO*	PRE+ZPC	DR	8.7
10	MP+MR*	AGN	DR	10.9					

Note: Malt: Pilsner – MP; winter barley – MWB; spring barley – MSB; maize – MM; rye – MR; oat – MO; *dosage 1:1; Hop: Premiant – PRE; Žatecký poloraný červeňák – ZPC; Agnus – AGN; Kazbek – KAZ; Perle – PER; Beer: lager – LA; draft – DR; light – LI.

Germany; one litre of the above product is able to ferment 130 litres of wort.

Combinations of malts and hops used in special beer brewing are shown in Table 1.

Micro-brewing of special beers

In the process of micro-brewing, four-litre batches were produced. A particular type of malt was ground and, subsequently, the malt was weighed out (180 g per one litre of water, all types of beer). In production of beers from corn, barley and oats malt, one half of the batch was replaced with the Pilsner malt containing glumes that served as a filtration layer during percolation.

The single infusion method performed in one vessel was employed. The use of infusion mashing resulted in dissolution and cleavage of malt extract substances carried out by long-term effect of malt enzymes. No mechanical and heat processing via wort boiling, which is employed in decoction method, was used (Basařová, 2011).

Identical temperatures and types of production process were employed with all the mashes produced; thereby, brewing technology reflected the quality of the processed ingredients. The production process was characterized with the following parameters: acid-rest temperature (35 °C); protein-rest temperature (50 °C); lower saccharification temperature (62 °C); higher saccharification temperature (72 °C), and mash out temperature (80 °C).

After completion of mashing, the boiling vessel was cooled and subsequently the product was subjected to percolation and wort rinsing. Percolation was done using both a cloth and a glume layer.

The hop was divided into three parts: the first portion was used at the beginning of hops boiling, the next portion after 40 minutes and the last one 10 minutes before the end of boiling.

On the day of boiling, the wort was inoculated with bottom-fermenting yeasts and stored at 10 °C. It was mostly kept in one storage room for three days and, subsequently, it was transferred into another one and stored at 5 °C. The main fermentation took seven days. For final fermentation, PET bottles were used; satiation of the beer with carbon dioxide could have been checked by touching the bottles.

For the proper course of final fermentation, wort (20 mL, produced from 100 g of malt per one litre of water, 3 g of ŽPČ hops) was added to each bottle. Finalization of the beer fermentation (5 °C) took one month, before both sensory and chemical analyses were implemented.

Chemical analysis was carried out using Fermentoflash device (Funke-Dr.N.Gerber Labortechnik GmbH Berlin, Germany) (FERMENTOFLASH, 2014).

A panel of five specialists (one woman, four men) evaluated sensory characteristics of the brewed beers at Mendel University in Brno.

Statistical methods

The data were statistically analysed by means of the statistical programme Unistat v 5.5.05 (©Copyright 1984 – 2003 UNISTAT Ltd., London, England), using analysis of variance (ANOVA).

RESULTS AND DISCUSSION

Table 2 specifies distinct parameters of individual beer samples such as average content of mass alcohol, alcohol by volume, actual extract, apparent extract, original wort extract, relative density and fermentation in%, and osmotic pressure in mOs.

The amount of malts used for micro-production of beer samples reflected alcoholic strength of the beers (8 – 12% EPM); the above principle was applied in all the samples with the exception of the sample 1 (Table 1). The above concentration of original wort was selected with the respect to sensory analysis; the character of stronger beers (above 12% EPM) can be drowned by mashy flavour. The content of ethanol corresponded to the degree of fermentation and thereby also to the residual actual extract in balance equilibrium specifying that higher residual extract corresponds to lower content of alcohol by volume. It ranged between 2.5 – 5.0%. Comparing beers obtained by micro-production, sample 1 contained the highest amount of ethanol by mass (3.9%) and the sample 13 showed the lowest one (1.9%); alike trend of ethanol percentage by volume was revealed in the above samples (5.0 and 2.4%, respectively). The highest content of actual or apparent extract was found in the sample 2 (6.6 and 5.2%, respectively); the sample 13 showed the lowest levels (4.0 and 3.1%, respectively).

The original wort extract content averaged 9.9% in most of the samples; the sample 1 showed distinctly higher value (12.6%) and, on the contrary, the sample 13 demonstrated the lowest one (7.4%). The highest relative density was revealed in the sample 2 (1.02%) and the lowest one in the sample 13 (1.01%). Considering differences in osmotic pressure, the sample 1 exhibited the highest value (1045 mOs) and the sample 13 the lowest one (551 mOs). The highest level of fermentation was found in the sample 1 (61.7%), the lowest one was proved in the sample 19 (44.0%).

Ethanol represents the primary volatile component of beer; its amount is given by original wort concentration and by fermentation degree. Beverages classified as 10% beers contain 2.8 – 3.5% of alcohol by mass and lagers labelled 12% include 3.5 – 4.2% of alcohol by mass (Kosař and Procházka, 2000; Márová et al., 2001; Gorjanovic et al., 2010; Knorr et al., 2016). The 10% beer samples 2 – 4, 6 – 11, and 14 showed the above proportion of alcohol by mass.

Kosař and Procházka (2000) report 80% fermentation as the ideal level to be achieved; no sample brewed within the experiment reached the above fermentation degree. Fermentation could have been influenced by many factors such as ingredients, technological procedures, hygienic conditions, yeast strain, unsatisfactory aeration of wort and yeasts, optimum fermentation and final-fermentation time, temperatures applied, etc. (Křižanová et al., 2010; Gorjanovic et al., 2010; Ganbaatar et al., 2015; Knorr et al., 2016).

In sensory analysis, the foam showed stability for 260 s in average; it was classified as thick foam with the height of 45 mm. Medium amount of carbon dioxide was released and turbidity was found when transparenance was evaluated.

Table 2 Average content of Mass alcohol; Alcohol by volume; Actual extract; Apparent extract; Original wort extract; Relative density and Fermentation in%, Osmotic pressure in mOs in 19 samples of beer brewed within the experiment (mean \pm S.D.).

		1	2	3	4	5
Mass alcohol	%	3.9 \pm 0.11	2.7 \pm 0.15	2.9 \pm 0.21	2.8 \pm 0.08	2.0 \pm 0.15
Alcohol by volume	%	0.5 \pm 0.21	3.5 \pm 0.19	3.8 \pm 0.09	3.6 \pm 0.11	2.6 \pm 0.31
Actual extract	%	5.2 \pm 0.17	6.6 \pm 0.21	5.6 \pm 0.19	5.1 \pm 0.13	5.0 \pm 0.10
Apparent extract	%	3.3 \pm 0.09	5.2 \pm 0.10	4.2 \pm 0.11	3.8 \pm 0.09	3.9 \pm 0.22
Original wort extract	%	12.6 \pm 0.26	11.3 \pm 0.44	11.0 \pm 0.30	10.3 \pm 0.06	8.6 \pm 0.43
Relative density	%	1.01 \pm 0.01	1.02 \pm 0.01	1.02 \pm 0.01	1.01 \pm 0.01	1.01 \pm 0.01
Fermentation	%	61.7 \pm 1.06	46.9 \pm 1.22	52.9 \pm 1.16	54.4 \pm 1.36	47.1 \pm 1.56
Osmotic pressure (mOs)		1045.0 \pm 2.15	805.0 \pm 2.45	834.0 \pm 2.35	798.0 \pm 1.22	612.0 \pm 2.45
		6	7	8	9	10
Mass alcohol	%	3.1 \pm 0.09	2.5 \pm 0.11	3.3 \pm 0.13	2.9 \pm 0.15	3.1 \pm 0.10
Alcohol by volume	%	4.0 \pm 0.15	3.2 \pm 0.23	4.2 \pm 0.28	3.8 \pm 0.27	4.0 \pm 0.22
Actual extract	%	5.1 \pm 0.17	4.8 \pm 0.19	5.6 \pm 0.13	4.8 \pm 0.07	5.2 \pm 0.11
Apparent extract	%	3.6 \pm 0.19	3.6 \pm 0.19	4.0 \pm 0.22	3.4 \pm 0.11	3.4 \pm 0.15
Original wort extract	%	11.0 \pm 0.31	9.3 \pm 0.41	11.7 \pm 0.16	10.3 \pm 0.21	11.0 \pm 0.20
Relative density	%	1.01 \pm 0.01	1.01 \pm 0.01	1.01 \pm 0.01	1.01 \pm 0.01	1.01 \pm 0.01
Fermentation	%	57.1 \pm 1.36	52.7 \pm 1.16	55.8 \pm 1.25	56.7 \pm 1.31	56.1 \pm 1.11
Osmotic pressure (mOs)		870.0 \pm 3.01	706.0 \pm 2.45	913.0 \pm 2.01	818.0 \pm 2.45	861.0 \pm 2.01
		11	12	13	14	15
Mass alcohol	%	2.3 \pm 0.15	2.1 \pm 0.18	1.9 \pm 0.11	2.9 \pm 0.10	2.1 \pm 0.09
Alcohol by volume	%	3.0 \pm 0.31	2.7 \pm 0.41	2.4 \pm 0.25	3.7 \pm 0.28	2.7 \pm 0.29
Actual extract	%	4.6 \pm 0.15	5.1 \pm 0.19	4.0 \pm 0.11	4.9 \pm 0.19	4.2 \pm 0.19
Apparent extract	%	3.5 \pm 0.15	4.1 \pm 0.18	3.1 \pm 0.09	3.5 \pm 0.11	3.2 \pm 0.18
Original wort extract	%	8.9 \pm 0.37	8.8 \pm 0.16	7.4 \pm 0.36	10.2 \pm 0.15	8.0 \pm 0.16
Relative density	%	1.01 \pm 0.01	1.01 \pm 0.01	1.01 \pm 0.01	1.01 \pm 0.01	1.01 \pm 0.01
Fermentation	%	52.4 \pm 2.06	46.9 \pm 1.86	53.5 \pm 1.22	56.0 \pm 1.46	51.6 \pm 1.12
Osmotic pressure (mOs)		669.0 \pm 2.44	625.0 \pm 2.20	551.0 \pm 2.45	805.0 \pm 2.75	599.0 \pm 2.66
		16	17	18	19	
Mass alcohol	%	2.7 \pm 0.21	2.1 \pm 0.31	2.4 \pm 0.11	1.9 \pm 0.09	
Alcohol by volume	%	3.5 \pm 0.25	2.7 \pm 0.25	3.1 \pm 0.35	2.5 \pm 0.31	
Actual extract	%	5.6 \pm 0.18	4.6 \pm 0.07	5.9 \pm 0.11	5.3 \pm 0.09	
Apparent extract	%	4.3 \pm 0.11	3.6 \pm 0.19	4.7 \pm 0.17	4.3 \pm 0.13	
Original wort extract	%	10.5 \pm 0.29	8.4 \pm 0.15	10.1 \pm 0.18	8.7 \pm 0.36	
Relative density	%	1.02 \pm 0.01	1.01 \pm 0.01	1.02 \pm 0.01	1.01 \pm 0.01	
Fermentation	%	50.9 \pm 1.33	49.2 \pm 1.28	46.7 \pm 1.49	44.0 \pm 1.34	
Osmotic pressure (mOs)		778.0 \pm 2.75	611.0 \pm 2.29	715.0 \pm 2.35	599.0 \pm 2.05	

CONCLUSION

Alcoholic strength of brewed beers ranged between 8 – 12% EPM. The actual residual extract oscillated between 4.0 – 6.5%. The content of ethanol corresponded to the degree of fermentation and thereby also to the residual actual extract in balance equilibrium specifying that higher residual extract corresponds to lower content of alcohol by volume. It ranged between 2.5 – 5.0%.

The sample 1 contained the highest amount of ethanol by mass (3.9%) and the sample 13 showed the lowest one (1.9%); alike trend of ethanol content by volume was revealed in the above samples (5.0 and 2.4%, respectively). The highest content of actual and apparent extract was found in the sample 2 (6.6 and 5.2%, respectively); the sample 13 showed the lowest levels (4.0 and 3.1%, respectively). The original wort extract content averaged 9.9% in most of the samples; the sample 1 showed distinctly higher value (12.6%) and, on the

contrary, the sample 13 demonstrated the lowest one (7.4%).

The highest density measured was 1.02% and the lowest one 1.01%. The sample 1 reached the highest degree of fermentation (61.7%) and the lowest degree was detected in the sample 19 (44.0% only). Considering differences in osmotic pressure, the sample 1 exhibited the highest value (1045 mOs) and the sample 13 the lowest one (551 mOs).

REFERENCES

- Basařová, G. 2010. *Pivovarství: teorie a praxe výroby piva (Brewing: theory and practice of beer production)*. Praha, Czech republic : Vydavatelství VŠCHT. 904 p. ISBN 978-80-7080-734-7.
- Basařová, G. 2011 *České pivo (Czech beer)*. 3rd ed. Praha, Czech Republic : Havlíček Brain Team. 328 p. ISBN 978-80-87109-25-0.

Briggs, D. E. 1998. *Malts and malting*. New York, USA : Blackie Academic. 796 p. ISBN 0412298007.

Briggs, D., Hough, J. 1981. *Malting and Brewing Science: Malt and Sweet Wort*. Berlin, Germany : Springer Science & Business Media. 914 p. ISBN 9780412165801.

FERMENTOFLASH, 2011. FermentoFlash [online] s.a. [cit. 2014-04-06]. Available at: http://funkegerber.de/FunkeGerber_Flyer_FermentoFlash_d_e_screen.pdf.

Ganbaatar, Ch., Kubáň, V., Kráčmar, S., Valášek, P., Fišera, M., Hoza, I. 2015. Liquid chromatographic determination of polyphenols in Czech beers during brewing process. *Potravinárstvo*, vol. 9, no. 1, p. 24-30. <https://doi.org/10.5219/421>

Gorjanovic, S. Z., Novakovic, M. M., Potkonjak, N. I., Leskosek-Cukalovic, I., Suznjevic, D. Z. 2010. Application of a Novel Antioxidative Assay in Beer Analysis and Brewing Process Monitoring. *Journal of Agricultural and Food Chemistry*, vol. 58, no. 2, p. 744-751. <https://doi.org/10.1021/jf903091n>

Chládek, L. 2007. *Pivovarnictví (Brewing)*. Praha, Czech Republic : Grada. 207 p. ISBN 978-80-247-1616-9.

Knorr, V., Weiser, H., Kohler, P. 2016. Production of gluten-free beer by peptidase treatment. *European Food Research and Technology*, vol. 242, no. 7, p. 1129-1140. <https://doi.org/10.1007/s00217-015-2617-5>

Kosař, K., Procházková, S. 2000. *Technologie výroby sladu a piva*. Praha, Czech Republic : Výzkumný ústav pivovarský a sladařský. 398 p. ISBN 80-902658-6-3.

Křížanová, K., Psota, V., Slezniak, L., Žofajová, A., Gubiš, J. 2010. Spring Barley Breeding for Malting Quality. *Potravinárstvo*, vol. 4, no. 2, p. 39-44. <https://doi.org/10.5219/50>

Márová I., Pařilová K., Friedl Z., Obruča S., Duroňová K. 2001. Analysis of Phenolic Compounds in Lager Beers of Different Origin: A Contribution to Potential Determination of the Authenticity of Czech Beer. *Chromatographia*, vol. 73, (Suppl. 1), p. S83-S95. <https://doi.org/10.1007/s10337-011-1916-7>

PIVOBIERALE, 2011. Pivo, Bier & Ale [online] s.a. [cit. 2014-04-06]. Available at: <http://www.pivobierale.cz/starsicisla/012011-2/>.

Zýbrt, V. 2005. *Velká kniha piva: vše o pivu (Velká kniha piva: vše o pivu)* Olomouc, Czech Republic : Rubico. 288 p. ISBN 80-7346-054-8.

Acknowledgments:

This work was supported by the VEGA No. 12345 grant and by the IGA UTB 2017-004 grant awarded by the internal grant agency of the Tomas Bata University in Zlín.

Contact address:

Hana Kábelová-Ficová, University of South Bohemia in České Budějovice, Department of Agricultural Products Quality, Studentská 1668, 370 05, České Budějovice, Czech Republic, E-mail: h.kabelova@seznam.cz

Stanislav Kráčmar, College of Business and Hotel Management, Department of Gastronomy, Bosonožská 9, 625 00 Brno, Czech Republic, E-mail: kracmar@hotskolabrno.cz

Tomáš Gregor, Mendel University in Brno, Department of Food technology, Zemědělská 1, 613 00 Brno, Czech Republic, E-mail: gregor@mendelu.cz

Miroslav Fišera, College of Business and Hotel Management, Department of Gastronomy, Bosonožská 9, 625 00 Brno, Czech Republic, E-mail: fishera@hotskolabrno.cz

Jozef Golian, Slovak University of Agriculture, Faculty of Biotechnology and Food Sciences, Department of Hygiene and Food Safety, Tr. A. Hlinku 2, 949 76 Nitra, Slovakia, E-mail: jozef.golian@uniag.sk

Vlastimil Kubáň, Tomas Bata University in Zlín, Faculty of Technology, Department of Food Technology, Vavrečkova 275, 762 72 Zlín, Czech Republic, E-mail: kuban@ft.utb.cz

Tomáš Šopík, Tomas Bata University in Zlín, Faculty of Technology, Department of Food Technology, Vavrečkova 275, 762 72 Zlín, Czech Republic, E-mail: sopik@ft.utb.cz

ELECTRONIC NOSE IN EDIBLE INSECTS AREA

*Martin Adámek, Anna Adámková, Marie Borkovcová, Jiří Mlček, Martina Bednářová,
Lenka Kouřimská, Josef Skácel, Michal Řezníček*

ABSTRACT

Edible insect is appraised by many cultures as delicious and nutritionally beneficial food. In western countries this commodity is not fully appreciated, and the worries about edible insect food safety prevail. Electronic noses can become a simple and cheap way of securing the health safety of food, and they can also become a tool for evaluating the quality of certain commodities. This research is a pilot project of using an electronic nose in edible insect culinary treatment, and this manuscript describes the phases of edible insect culinary treatment and methods of distinguishing mealworm (*Tenebrio molitor*) and giant mealworm (*Zophobas morio*) using simple electronic nose. These species were measured in the live stage, after killing with boiling water, after drying and after inserting into the chocolate. The sensing device was based on the Arduino Mega platform with the ability to store the recorded data on the SD memory card, and with the possibility to communicate via internet. Data analysis shows that even a simple, cheap and portable electronic nose can distinguish between the different steps of culinary treatment (native samples, dried samples, samples enriched with chocolate for cooking) and selected species. Another benefit of the electronic nose could be its future introduction into the control mechanisms of food security systems (e.g. HACCP).

Keywords: e-nose; edible insect; mealworm; giant mealworm; Arduino

INTRODUCTION

Edible insect is appraised by many cultures as delicious and nutritionally beneficial food. On the contrary, in the western countries, edible insect is treated with disgust, being associated more with dirt than with food (Yen, 2009; Looy, Dunkel, and Wood, 2014). Despite the many benefits (suitable nutritional values, low ecological burden and low economic cost) this commodity is not yet fully appreciated in western countries (Tan et al., 2015; Adámková et al., 2016). For this reason, insect in these countries is used mainly as menu enrichment, delicacy, sought after mainly because of its sensory properties (Borkovcová et al., 2009). Taste of edible insect is plentiful, depends mainly on the environment and food. Another aspect that influences the edible insect sensory attributes is the culinary processing, during which insect takes the taste of the added ingredients. Majority of insect species is almost without taste due to exoskeleton. Taste and smell of insect are made by the pheromones on the body surface, therefore it is not recommended to wash the insect prior to the eating (Ramos-Elorduy, 1998).

Although the sense of smell is one of the oldest human senses (Hanboonsong, 2010; Ramos-Elorduy et al., 1997), it can be insensitive on this account and smell perception can be strongly subjective. Odour perception is based on a series of chemical reactions that occur upon

contact with the gas molecules with smell receptors, which induces the flow of electrical signals through the neurons that are processed by the brain. In humans, the surface of the olfactory mucose membrane creates an area of about 5 cm², where 1000 different types of olfactory receptors are scattered. On the contrary, the olfactory mucosal surface of dog occupies an area up to 170 cm², which proves their superior sense of smell. Humans can distinguish a maximum of 4000 different compounds. To be able to distinguish differences in intensity of the odour, it is necessary to increase the intensity by at least 30%. The sense of smell have the strongest effect on the mental state of a human of all his senses. In higher concentrations, odors can even cause various health problems (nausea, headache), or conversely, a pleasure feeling (Carlsson and Kalinová, 2005; The eNose Company, 2016).

Humans are able to distinguish many smells and perceive their different intensities. However, the sense of smell is often insufficient, and it is necessary to use other methods for separating and increasing the concentration of odors, which are noticed by human (olfactometry). The other groups are tools that monitor the concentration of each aroma completely independently of the human sense of smell – electronic noses (The eNose Company, 2016; Gopal, 2015). These devices are usually equipped with several semiconductor gas sensors, each one sensitive only

to a certain type of gas or group of gases. They also contain a database of reference samples which serves for the evaluation of the measured samples. First, you need to "teach" the electronic nose the different smells. More accurate devices may further combine different methods of measuring the concentration of substances in the gas. Electronic noses may be useful not only as a part of safety systems (detection of flammable, hazardous substances for humans), and environmental protection (determination of air pollution), but also in health care, and especially in the food industry (Carlsson and Kalinová, 2005; Gopal, 2015).

In the food industry, a scent that satisfies consumers is one of the most important sensory properties (Haščík et al., 2013). To assess it, knowledgeable people in the field of sensory perception are used (Kinclová, Jarošová and Tremlová, 2004). However, layman evaluates the smell only subjectively, based on his experience and preferences. People commonly use the sense of smell to assess the quality of the food (consumer connects fresh food with a pleasant smell and a deteriorating food with unpleasant smells - odour). However, this form of assessment is not exact, so it is preferable to use a more precise method based on electronic sensors and computer processing – an electronic nose. Using the electronic nose can prevent economic losses and health complications due to spoiled food poisoning.

The aim of this work was to test edible insect samples using simple and cheap prototype of electronic nose, in order to evaluate its ability to identify insect species and stage of processing through simple culinary treatment.

MATERIAL AND METHODOLOGY

Insect

Larvae of mealworm (*Tenebrio molitor*) and giant mealworm (*Zophobas morio*) were used for the analysis. Samples were bought in pet store Krmiva Hostivice.

Insect processing

The insect was raised in optimal condition for development of each species. Both species were fed with brans and a mixture of chopped vegetables and fruits. Prior

to the analysis larvae in the last and penultimate instar development (the full length of the body just before pupation) were collected from breeding for subsequent culinary processing and measurement.

Measurement of gas concentrations

Measurement of gas concentrations was done using the experimental prototype of electronic nose (Figure 1), constructed as a simple, cheap and mobile device. The tool itself was based on the Arduino Mega platform controlled by ATmega1280 microcontroller with the ability to store the recorded data on the SD memory card, and with the possibility to communicate with the web server. The measuring cell was equipped with sensors based on the chemo-resistive principle. It uses MQ-6 sensor (Zhengzhou Winsen Electronics Technology Co., Ltd, Zhengzhou, China), which is sensitive especially to the propane or isobutane (300 – 10000 ppm) and less sensitive to alcohol. Other sensors are MQ-3 (Zhengzhou Winsen Electronics Technology Co., Ltd, Zhengzhou, China), which is very sensitive to alcohol (25 – 500 ppm) and MQ-8 sensor (Zhengzhou Winsen Electronics Technology Co., Ltd, Zhengzhou, China), used to detect hydrogen (100 – 1000 ppm). This device should only compare its measurements among themselves for final data evaluation, and precise measurement of absolute concentration of each gas molecules within the smell was not taken into account. Therefore, we used the plugging recommended by the manufacturer, without subsequent calibration for evaluating the absolute gas concentration. US voltage [V] from the individual sensors was converted to a digital value $d [-]$ (voltage of 0V and 5V corresponds to a digital level 0 and 1023) using the internal 10-bit A/D microcontroller converters. These values were then mathematically processed.

Insect culinary processing and smell evaluation

Measurements were done in several stages. After starving for 24 hours the first measurement was done. Subsequently, the insect was killed with boiling water (100 °C) and the second measurement was carried out.

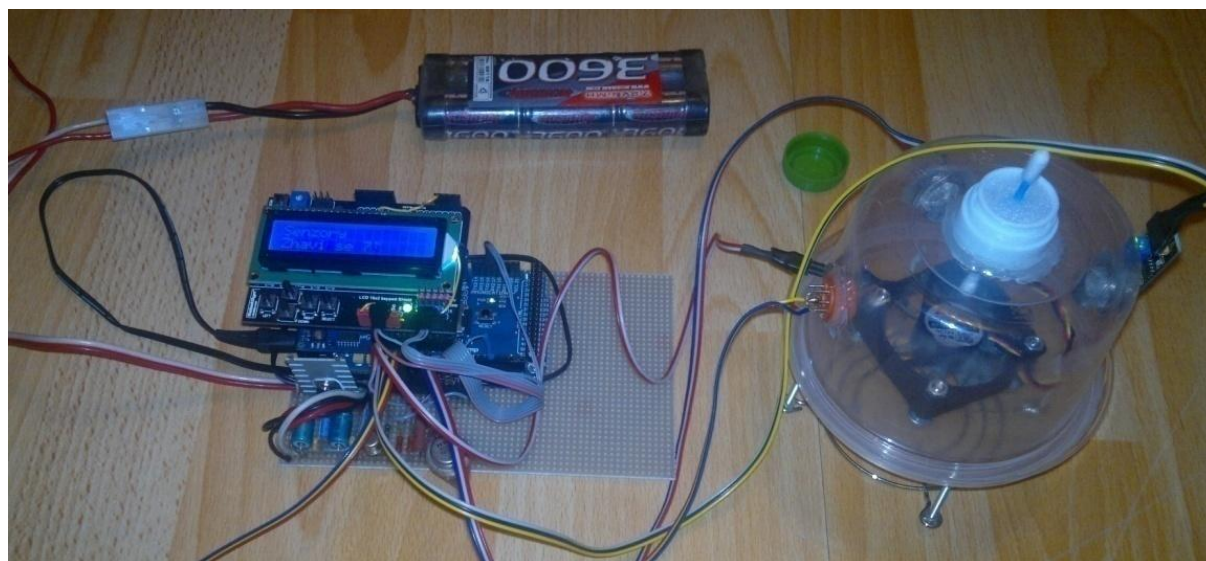

Figure 1 Experimental prototype of electronic nose.

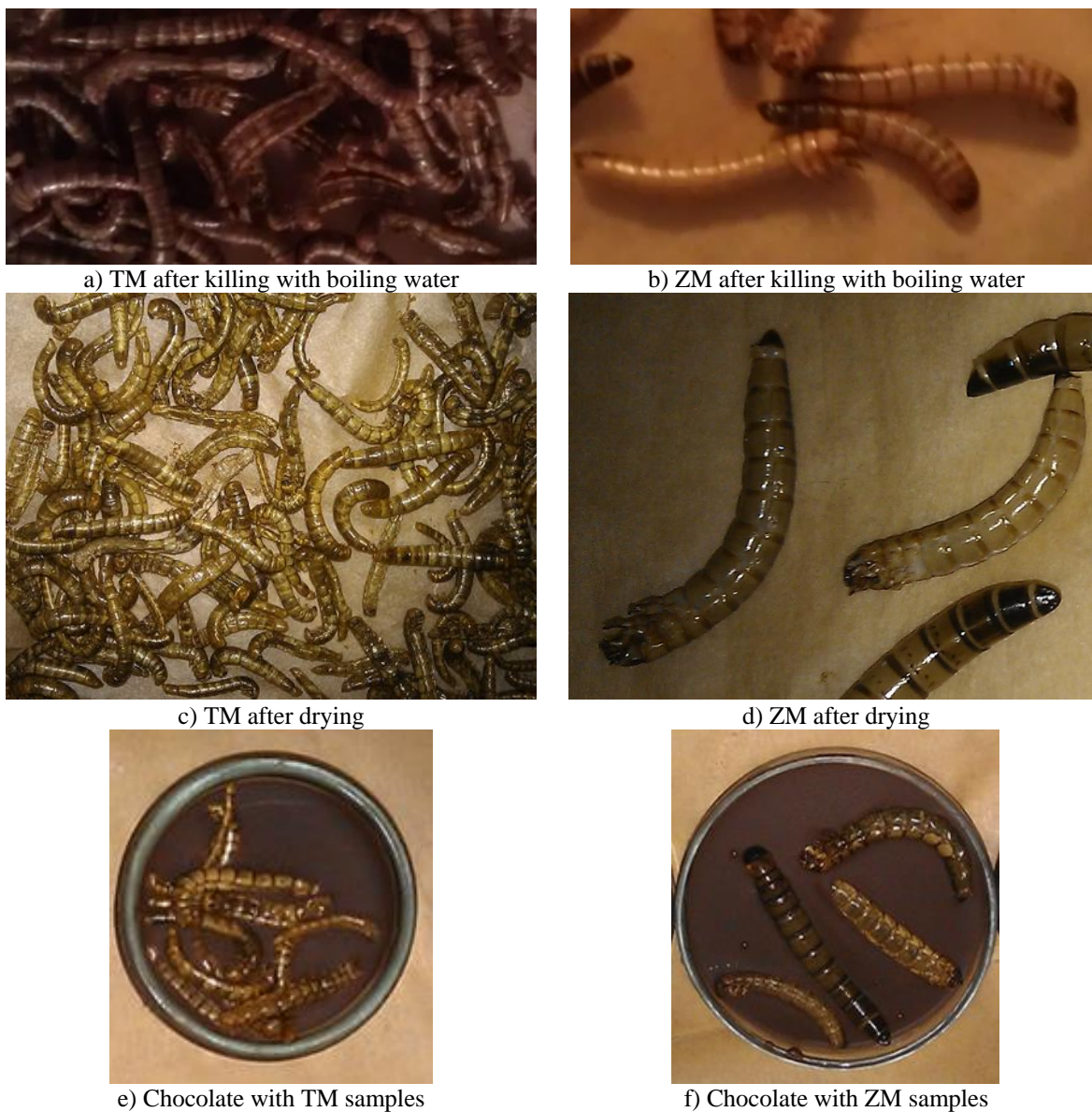

Figure 2 Insect samples after each processing phase.

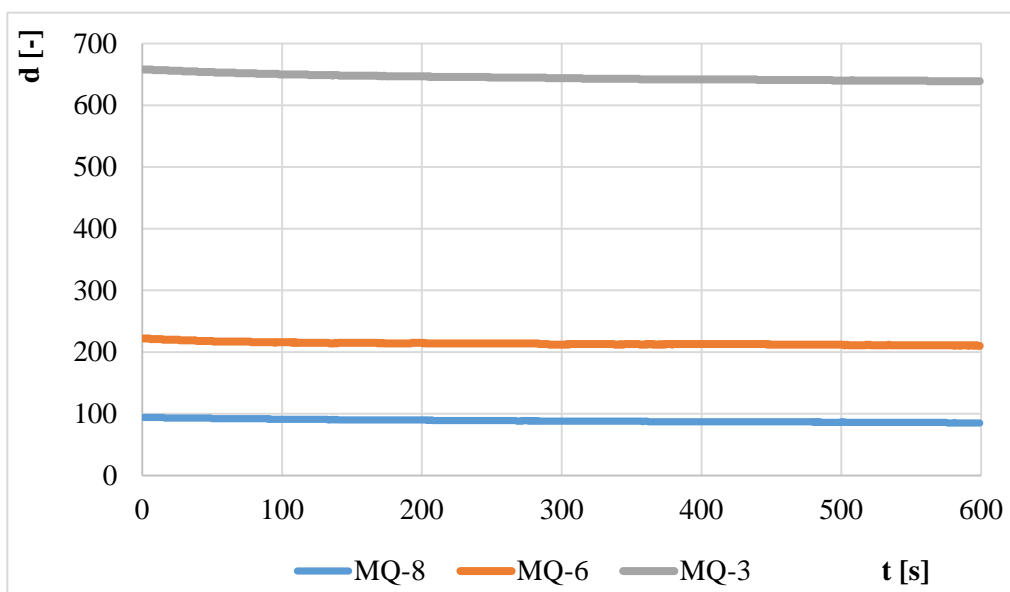

Figure 3 Example of time dependence of data for each of the sensors MQ-8, MQ-6 and MQ-3 in samples of dried larvae of the giant mealworm (*Zophobas morio*).

Table 1 Mean values for each sensor and phase of culinary processing.

mealworm (<i>Tenebrio molitor</i>)				giant mealworm (<i>Zophobas morio</i>)			
Sample	MQ-8	MQ-6	MQ-3	Sample	MQ-8	MQ-6	MQ-3
live larvae				live larvae			
1	74.4	186.2	590.3	1	72.1	188.3	598.2
2	77.8	200.5	628.6	2	71.9	186.1	593.4
3	74.2	195.1	617.2	3	73.0	184.4	589.5
M	75.5	193.9	612.0	M	72.4	186.3	593.7
±SD	2.0	7.2	19.7	±SD	0.6	2.0	4.3
larvae killed with boiling water				larvae killed with boiling water			
1	100.2	281.5	679.3	1	98.3	287.7	661.3
2	84.0	219.6	640.5	2	91.6	220.5	628.9
3	72.5	199.3	617.5	3	75.5	191.9	599.1
M	85.6	233.5	645.7	M	88.5	233.4	629.7
±SD	13.9	42.8	31.3	±SD	11.7	49.2	31.1
dried larvae				dried larvae			
1	66.9	172.6	579.6	1	84.1	210.8	635.4
2	66.0	172.7	574.8	2	82.7	217.2	639.0
3	66.7	175.2	565.0	3	88.7	213.8	645.2
M	66.5	173.5	573.2	M	85.2	213.9	639.9
±SD	0.5	1.4	7.4	±SD	3.1	3.2	5.0
larvae in chocolate				larvae in chocolate			
1	96.4	267.0	806.1	1	97.2	263.2	800.9
2	93.6	257.6	789.4	2	103.0	263.9	799.5
3	97.9	261.2	799.4	3	97.2	257.0	785.9
M	95.9	261.9	798.3	M	99.1	261.4	795.4
±SD	2.2	4.8	8.4	±SD	3.4	3.8	8.3

After drying at 105 °C for 120 minutes, the third measurement was done. The last measurement was performed after inserting the dried larvae into a bowl and pouring with chocolate for cooking (Nestlé Czech Ltd., Praha). Samples after each processing phase are shown in Figure 2.

Statistical analysis

Each measurement was carried out three times. Data was processed and evaluated using the applications Excel 2013 (Microsoft Corporation, USA) and Gnuplot 5.0: an interactive plotting program (Williams and Kelley, 2016).

RESULTS AND DISCUSSION

The results presented are data from first available measurements of insect properties in different stages of culinary processing gained using the simple electronic nose. Available literature did not present any comparable data.

The data obtained for each of the sensors MQ-8, MQ-6 and MQ-3 was used to create curves to show the dependency on measured time. Time of measurement was set to 600 s. Example of time dependence is shown in Figure 3.

Each curve was used to obtain basic statistical quantities: mean, standard deviation, minimum and maximum. Mean values were inserted into Table 1 and into a 3D graph

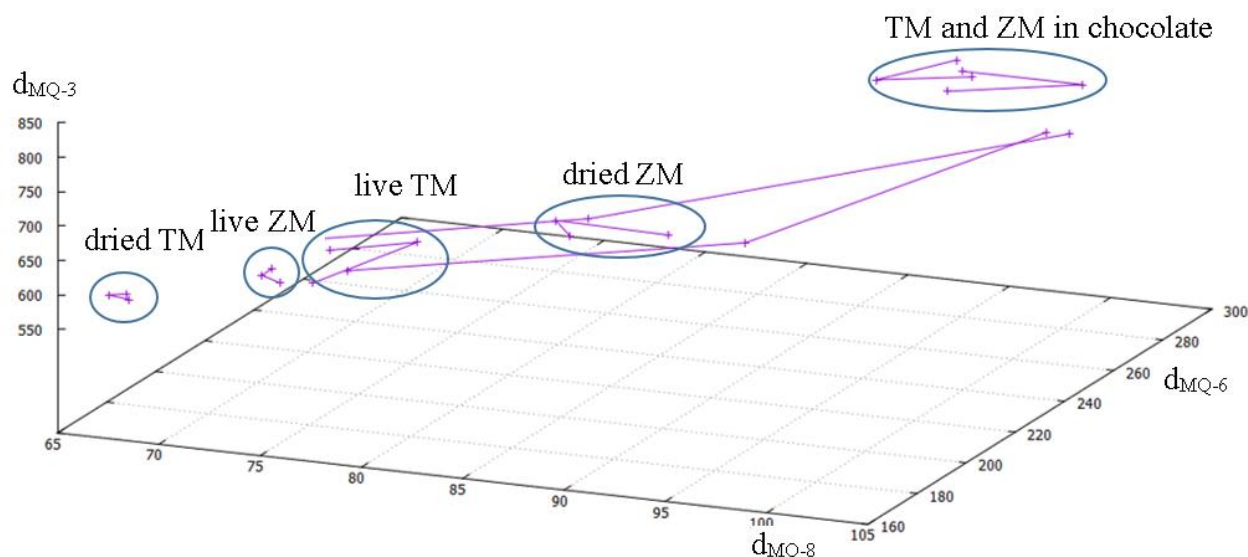

Figure 4 Measured spots graph.

using the GnuPlot application.

The results of our analyses suggest that even the simple electronic nose can recognize the species of edible insects and phase of its culinary processing. Figure 4 shows a graph of measured values (smell) monitored by the each gas sensor for mealworm (*Tenebrio molitor*) and giant mealworm (*Zophobas morio*) after starving – in the native state, after killing (boiling water 100 °C), after drying (105 °C) and after pouring with chocolate for cooking. In the graph we can distinguish different parts (smells) for larvae in the native state, dried samples and larvae in chocolate for cooking. Values for samples in chocolate are very similar in each species. The difference between species is clear in native and dried samples. Values for samples after killing with boiling water are scattered through the graph. This may be due to elevated temperature and humidity, to which the sensors are sensitive and which were not measured and corrected.

It is supposed that by detecting the scent it will be possible not only to evaluate the danger of spoiled food that can cause foodborne illness, but also the various stages of technological preparation and species. This could be used to document the screening of foods to avoid their potential spoiling. The information obtained may serve as a basis for exclusion of food from the food chain. In the case of breeding of edible insects, this may also serve as a primary screening, not only of the species, but also to evaluate the amount of dead individuals in the rearing box.

Using the electronic nose for monitoring the scents of insects is examined in other areas, e.g. the control of volatile substances released from cotton bolls in response to feeding by stink bugs (Degenhardt, Greene and Khalilian, 2012; Henderson et al., 2010). The other area is the control of the degree of insect infestation in wheat, when Zhang and Wang (2007) proved it is possible to evaluate the food aging and insect infestation in wheat using the commercial E-nose (PEN2) comprising 10 metal-oxide semiconductor (MOS) sensors. Similarly Wu et al. (2013) proved the possibility to detect the presence of red flour beetle (*Tribolium castaneum*) using the electronic nose in wheat with certain humidity, however, their electronic nose did not detect the presence of rusty grain beetle (*Cryptolestes ferrugineus*). Also evaluation of rice infestation by *Nilaparvata lugens* was carried out using electronic nose (Zhou and Wang, 2011). Electronic nose can be used to precisely set up the bait used in boll weevil eradication programs (Suh, Ding and Lan, 2011). Available literature also mentions and demonstrates the possibility of using the electronic nose as an effective tool to monitor the red palm weevil pest (*Rhynchophorus ferrugineus* Olivier) (Rizzolo et al., 2015). Electronic nose also enables the identification of species and sex of stink bugs (Lan et al., 2008).

CONCLUSION

This research dealt with the comparison of the smells of mealworm (*Tenebrio molitor*) and super worm (*Zophobas morio*) larvae; using simple, cheap and mobile device based on the Arduino Mega platform. Although the device is simple, it enables measuring and detection of different stages of edible insect culinary processing. Considering the food safety, electronic nose can be used to monitor the processing of edible insect and to distinguish each species

of edible insect in certain phases of culinary processing. Electronic noses can be the source of data used as input for HACCP, applied from agricultural primary production, through culinary processing and selling to the final consumer (protection of the consumer's health).

REFERENCES

- Adámková, A., Kouřimská, L., Borkovcová, M., Kulma, M., Mlček, J. 2016. Nutritional values of edible coleoptera (*Tenebrio molitor*, *Zophobas morio* and *Alphitobius diaperinus*) reared in the Czech Republic. *Potravinárstvo*, vol. 10, no. 1, p. 663-671. <https://doi.org/10.5219/609>
- Borkovcová, M., Bednářová, M., Fišer, V., Ocknecht, P. 2009. *The food variegation by insects (Kuchyně hmyzem zpestřená 1)*. Brno, Czech Republic : Lynx. 135 p. ISBN 978-80-86787-37-4.
- Carlsson, M. A., Kalinová, B. 2005. Disclosed mystery of olfaction (Tajemství čichu poodhaleno). *Vesmír*, vol. 84, no. 3, p. 148-155.
- Degenhardt, D. C., Greene, J. K., Khalilian, A. 2012. Temporal Dynamics and Electronic Nose Detection of Stink Bug-Induced Volatile Emissions from Cotton Bolls. *Psyche A Journal of Entomology*, vol. 2012, p. 9. <https://doi.org/10.1155/2012/236762>
- Gopal, D. 2015. Electronic Nose 'Smells' Rotting Food! [online] 2015-11-17 [cit. 2016-04-17]. Available at: <http://www.youngzine.org/article/electronic-nose-smells-rottingfood>.
- Hanboonsong, Y. 2010. Edible insects and associated food habits in Thailand. In *Forest insects as food: humans bite back, Proceedings of a workshop on Asia-Pacific resources and their potential for development*. Bangkok, Thailand : FAO Regional Office for Asia and the Pacific, p. 173-182. ISBN 978-92-5-106488-7.
- Haščík, P., Elimam, I. O. E., Garlík, J., Bobko, M., Kročko, M. 2013. Sensory evaluation of broiler meat after addition Slovak bee pollen in their feed mixture. *Potravinárstvo*, vol. 7, no. 1, p. 107-110. <https://doi.org/10.5219/280>
- Henderson, W. G., Khalilian, A., Han, Y. J., Greene, J. K., Degenhardt, D. C. 2010. Detecting stink bugs/damage in cotton utilizing a portable electronic nose. *Computers and Electronics in Agriculture*, vol. 70, no. 1, p. 157-162. <http://dx.doi.org/10.1016/j.compag.2009.09.019>
- Kinclová, V., Jarošová, A., Tremlová, B. 2004. Sensory analysis of food (Senzorická analýza potravín). *Veterinářství* vol. 54, no. 6, p. 362-364.
- Lan, Y., Zheng, X., Westbrook, J. K., Lopez, J., Lacey, R., Hoffmann, W. C., 2008. Identification of Stink Bugs Using an Electronic Nose. *Journal of Bionic Engineering*, vol. 5, suppl., p. 172-180.
- Looy, H., Dunkel, F. V., Wood, J. R. 2014. How then shall we eat? Insect-eating attitudes and sustainable foodways. *Agriculture and Human Values*, vol. 31, no. 1, p. 131-141. <https://doi.org/10.1007/s10460-013-9450-x>
- Ramos-Elorduy, J., Moreno, J. M. P., Prado, E. E., Perez, M. A., Otero, J. L., de Guevara, O. L. 1997. Nutritional Value of Edible Insects from the State of Oaxaca, Mexico. *Journal of Food Composition and Analysis*, vol. 10, no. 2, p. 142-157. <https://doi.org/10.1006/jfca.1997.0530>
- Ramos-Elorduy, J. 1998. *Creepy Crawly Cuisine: The Gourmet Guide to Edible Insects*. Rochester, Vermont : Park Street Press, 160 p. ISBN-13: 978-0892817474.
- Rizzolo, A., Bianchi, G., Lucido, P., Cangelosi, B., Pozzi, L., Villa, G., Clematis, F., Pasini, C., Curir, P. 2015. Electronic nose for the early detection of red palm weevil (*Rhynchophorus ferrugineus* Olivier) infestation in palms:

Preliminary results. In *Proceedings of the Second International Symposium on Horticulture in Europe, ISHS Acta Horticulturae 1099*. Leuven : International Society for Horticultural Science (ISHS), pp. 347-356. ISBN 978-94-62610-96-5.

Suh, Ch. P. C., Ding, N., Lan, Y. 2011. Using an Electronic Nose to Rapidly Assess Grandlure Content in Boll Weevil Pheromone Lures. *Journal of Bionic Engineering*, vol. 8, no. 4, p. 449-454. [https://doi.org/10.1016/S1672-6529\(11\)60050-4](https://doi.org/10.1016/S1672-6529(11)60050-4)

Tan, H. S. G., Fischer, A. R. H., Tinch, P., Stieger, M., Steenbekkers, L. P. A., van Trijp, H. C. M. 2015. Insects as food: exploring cultural exposure and individual experience as determinants of acceptance. *Food Quality and Preference*, vol. 42, p. 78-89. <https://doi.org/10.1016/j.foodqual.2015.01.013>

The eNose Company, 2016. *eNose Technology* [online] s.a. [cit. 2016-04-17] Available at: <http://www.enose.nl/rd/technology/>.

Wu, J., Jayas, D. S., Zhang, Q., White, N. D. G., York, R. K. 2013. Feasibility of the application of electronic nose technology to detect insect infestation in wheat. *Canadian Biosystems Engineering / Le Genie des biosystems au Canada*, vol. 55, p. 3.1-3.9. <https://doi.org/10.7451/CBE.2013.55.3.1>

Yen, A. L. 2009. Edible insects: Traditional knowledge or western phobia? *Entomological Research*, vol. 39, no. 5, p. 289-298. <https://doi.org/10.1111/j.1748-5967.2009.00239.x>

Zhang, H., Wang, J. 2007. Detection of age and insect damage incurred by wheat, with an electronic nose. *Journal of Stored Products Research*, vol. 43, no. 4, p. 489-495. <https://doi.org/10.1016/j.jspr.2007.01.004>

Zhou, B., Wang, J., 2011. Use of electronic nose technology for identifying rice infestation by *Nilaparvata lugens*. *Sensors and Actuators B: Chemical*, vol. 160, no. 1, p. 15-21. <https://doi.org/10.1016/j.snb.2011.07.002>

Acknowledgments:

The article was supported by project no. FEKT-S-17-3934 Utilization of novel findings in micro and nanotechnologies for complex electronic circuits and sensor applications.

Contact address:

Martin Adáček, Brno University of Technology, Faculty of Electrical Engineering and Communication, Department of Microelectronics, Technická 3058/10, 616 00 Brno, Czech Republic, E-mail: adacek@feec.vutbr.cz

Anna Adámková, Czech University of Life Sciences Prague, Faculty of Agrobiolgy, Food and Natural Resources, Department of Quality of Agricultural Products, Kamýcká 129, 165 21 Prague 6 – Suchdol, Czech Republic, E-mail: adamkova@af.czu.cz

Marie Borkovcová, Mendel University in Brno, Faculty of Agronomy, Department of Zoology, Fisheries, Hydrobiology and Agriculture, Zemědělská 1, 613 00 Brno, Czech Republic, E-mail: marie.borkovcova@mendelu.cz

Jiří Mlček, Tomas Bata University in Zlin, Faculty of Technology, Department of Food Analysis and Chemistry, Vavreckova 275, 760 01 Zlin, Czech Republic, E-mail: mlcek@ft.utb.cz

Martina Bednářová, Mendel University in Brno, Department of Information Technology, Zemědělská 1, 613 00 Brno, Czech Republic, E-mail: bednarova@mendelu.cz

Lenka Kourimská, Czech University of Life Sciences Prague, Faculty of Agrobiolgy, Food and Natural Resources, Department of Quality of Agricultural Products, Department of Microbiology, Nutrition and Dietetics, Kamýcká 129, 165 21 Prague 6 – Suchdol, Czech Republic, E-mail: kourimska@af.czu.cz

Josef Skácel, Brno University of Technology, Faculty of Electrical Engineering and Communication, Department of Microelectronics, Technická 3058/10, 616 00 Brno, Czech Republic, E-mail: xskace09@stud.feec.vutbr.cz

Michal Řezníček, Faculty of Electrical Engineering and Communication, Department of Microelectronics, Technická 3058/10, 616 00 Brno, Czech Republic, E-mail: reznicek@feec.vutbr.cz



COMPARATIVE STUDY ON NATURAL PLANT ANTIBIOTICS – VEGETABLE AND THEIR CONSUMPTION AMONG COLLEGE STUDENTS

Tünde Juríková, Ildikó Viczayová, Alžbeta Hegedúsová, Jiří Mlček, József Kontra, Lukáš Snopek

ABSTRACT

The research study is aimed at evaluation of natural plant antibiotics utilization among college students (554) with different subject study (Pre-school and elementary education, Biology, Regional Tourism, Horticulture, Physical education) from 3 countries – Slovak Republic, Czech Republic and Hungary. The attention has been focused on natural antibiotics in plants - vegetables (garlic, onion and horse radish) and the frequency of their consumption among college students. From the research results there is evident that majority of students had basic knowledge about natural plant antibiotics (85% of respondents) and they utilize them in everyday life (60.3%). The prevailing number of students utilizes synthetic antibiotics only rarely – once a year (33.4%) or never (37.5%). From achieved results about exact plants (garlic, onion and horse radish) consumption, the majority of respondents consume garlic once a week (42.2%); on the daily base the highest usage was noticed in the group of Slovak students with the subject of Physical education (32.1%) that could be considered as statistically different in comparison with the rest of groups. On the contrary, the lowest garlic consumption was noticed for students of biology (23.5%) and only small amount of students (3.6%) claimed that they have never included garlic into their diet. As for the onion, the majority of respondents (42.10%) also consume this commodity once a week; everyday consumption was noticed again especially between Slovak students with the subject of Physical education (32.1%) and Horticulture (31.1%). The results of these groups significantly differed from results of other groups. Third studied vegetable, horse-radish, it has never been consumed by Slovak students of Pre-school and elementary education in Slovak language (47.9%) that has been significantly distinguishable from another groups. Also Hungarian students of Physical education consume this commodity rarely (30.6%) – only once a year. Major part of students (46%) consumes horse-radish once a month. Czech students of Horticulture prefer consummation of horse-radish only once a month (76.8%). The lowest utilization was noticed in groups MU/ H (76.8%) consumed this commodity only monthly. Similarly, students of UP/ PE (30.6%) consumed horse radish only once a year that was significantly lower value in comparison with the rest of evaluated groups.

Keywords: natural plant antibiotics; garlic; onion; horse-radish; consumption; college students

INTRODUCTION

The second half of the 20th century has brought the revival of traditional medicine as an alternative form of human health care. The worldwide increasing tendency of microbial resistance to classic antibiotics led researchers to investigate the potential antimicrobial activities of plants (vegetables, fruits, herbs and honey) (Cowan, 1999; Mahalingan et al., 2011; Nascimento et al., 2000; Valle et al., 2015; Kačániová et al., 2011; Fatrcová-Šramková et al., 2013).

Hundreds of plant extracts have showed antibacterial activity in vitro (Martin and Ernst, 2003) but this could not be translated into in vivo studies in humans in all cases. Thus results of antibacterial activity in plants could be in doubts. However, scientific research proved that

plant antibiotics might be reasonable natural alternatives for treating drug-resistance bacteria (Buhner, 2012). Moreover, herbal antibiotics could not only kill bacteria but also viruses and yeast and might strengthen the immune system (Juríková et al., 2016).

To the most known plants with natural antibiotics belong vegetables such as garlic, onion or horse-radish. Garlic and generally genus *Allium* has been labelled as leading plants for usage in the treatment of health problems with resistant microorganisms. Extracts and essential oils of these plants have shown wide antimicrobial activity (Jakubcova et al., 2014). The researches proved an antibacterial effect of garlic (*Allium sativum*), onion (*Allium cepa*), leek (*Allium porrum*), Chinese chives (*Allium tuberosum*) and chives (*Allium schoenoprasum*) against *G. +S. aureus*, *L.*

monocytogenes and G – S. typhimurium and C. jejuni and against oral pathogenic Streptococcus mutans and S. sobrinus (Kim, 1997; Elnima et al., 1993), but there is no effect against Helicobacter pylori infections (Ayidin et al., 1997; Graham et al., 2004; Mnayer et al., 2014).

Aqueous and hydroalcoholic extracts (40%) of garlic have been effective against S. aureus strain and isolated Streptococcus oralis and S. mitis (Silva and Fernandez, 2010). Study of Betoni et al. (2016) showed antibacterial activity of methanol extracts (70%) of garlic leaves against S. aureus.

The main antimicrobial agent in onion is quercetin and allicin (thio-2-propene-1-sulfinic acid-5-allyl-esters). Quercetin binds to the bacteria DNA gyrase while allicin inhibits certain thiol containing enzymes in the microorganisms by the rapid reaction of thiosulfonates (Park et al., 2008).

The antimicrobial activity of isothiocyanates extracted from horseradish root were investigated against oral microorganisms: 6 strains of facultative anaerobic bacteria, S. mutans, S. sobrinus, L. casei, S. aureus, E. faecalis and Aggregatibacter actinomycetemcomitans; yeast C. albicans, and 3 strains of anaerobic bacteria, F. nucleatum, Prevotella nigrescens and C. perfringens. Isothiocyanates isolated from horseradish root was effective against 4 strains of antibiotic-resistant bacteria, methicillin-resistant S. aureus (MRSA), vancomycin-resistant S. aureus (VRSA), multidrug-resistant Acinetobacter baumannii (MRAB), and multidrug-resistant P. aeruginosa (MRPA), and 3 pathogenic bacteria, S. aureus, A. baumannii, and P. aeruginosa (Kim et al., 2015).

Our comparative research has dealt with an investigation of utilization of some vegetables with natural antibiotics, in contrary to synthetic antibiotics, in students' life. The consumption of the most common and widely utilized natural antibiotics in vegetables (garlic, onion and horseradish) has been evaluated in the group involving 554 college students. For this type of study the questionnaire method was chosen as the most relevant. Furthermore, the differences between field of study and university country have been taken into account too.

MATERIAL AND METHODOLOGY

Research respond group involved 554 college students (337 women, 217 men) from 3 countries: Slovak Republic,

Czech Republic and Hungary. Selected students of three Slovak universities (Constantine the Philosopher University, Slovak University of Agriculture, Comenius University), one Czech university (Mendel University in Brno) and one Hungarian university (University of Pécs) had wide range of study program fields – Pre-school and elementary education, Horticulture, Physical education (Sport Education), Biology, Regional Tourism. The exact sorting of students groups with numbers are given in Table 1.

Students were asked on consumption of natural and synthetic antibiotic generally. In the research our attention was then focused on the consumption of selected vegetables containing natural antibiotics (garlic, onion, and horse-radish) with evaluation of their usage frequency.

The statistical evaluation was provided with the program STATISTICA 6.0 by a method of ANOVA and post-hoc tests Tamhane and Dunett T 3 on two levels of probability – 99% and 95%.

RESULTS AND DISCUSSION

The evaluation of natural and synthetic antibiotics consumption among college students

First question of the questionnaire was aimed on the knowledge of college students about natural antibiotics and their utilization in their common life. The results of research are summarized in Figure 1 – 2.

The results showed that the majority of students had basic knowledge about natural antibiotics (85%) and utilize them in their life (60.3% of respondents) what could be mentioned as positive fact. Our results are in accordance with a research of Juríková et al. (2015) that mapped the consumption of natural antibiotics among college students in Slovakia (Nitra).

By contrast synthetic antibiotics use among college students has been noticed mainly once a year (33.4%) or never (37.5%). In the previously mentioned research of Juríková et al. (2015) there was shown higher number of college students utilizing synthetic antibiotics, the most often it was several times a year.

The evaluation of garlic consumption among college students

Garlic was consumed on everyday base by 32.1% college students of Comenius University with the field of study

Table 1 Overview of respondents – college students, according to university and their field of study.

University/Abbreviation	Field of study	Number of students	Group number
Constantine the Philosopher University CPU	PEES – Pre-school and elementary education in Slovak language	48	8
	PEEH – Pre-school and elementary education in Hungarian language	95	3
	BI – Biology	47	5
	RT – Regional Tourism	50	6
Mendel University in Brno MU	H – Horticulture	112	7
Slovak University of Agriculture SUA	H – Horticulture	45	1
University of Pécs UP	PE – Physical education	134	4
Comenius University CU	PE – Physical education	53	2

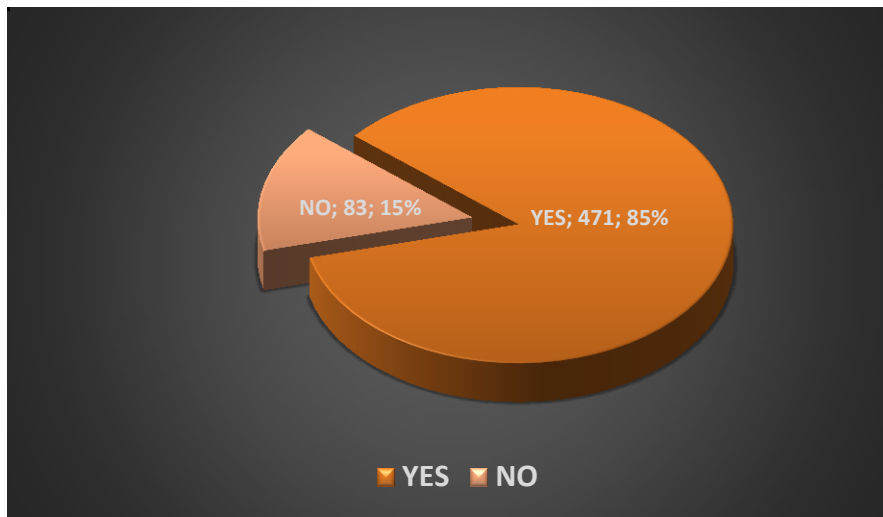

Figure 1 The evaluation of basic knowledge about natural antibiotics.

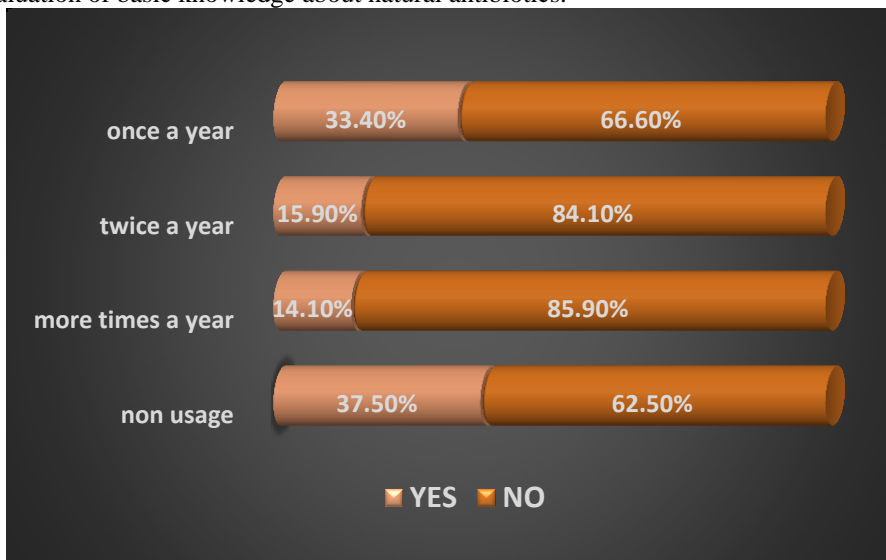

Figure 2 The frequency of utilization of synthetic antibiotics.

program PE as seen in Figure 3. This result can be considered as statistically significantly different in comparison with some other groups of students, CPU/PEEH 0 % ($p < 0.001$), UP/PE 8.2% ($p < 0.01$), CPU/BI 0% ($p < 0.001$), CPU/RT 2% ($p < 0.01$), MU/H 0% ($p < 0.001$) and CPU/PEES 2.1% ($p < 0.01$).

Statistically significant differences were proved also between the results for groups UP/PE 8.2% and CPU/PEEH 0% ($p < 0.01$), CPU/BI 0% ($p < 0.01$), MU/H 0% ($p < 0.05$). The highest consumption of garlic once a week was noticed in the group MU/H 82.1%. This value statistically differed with SUA/H 20.0% ($p < 0.001$),

CU/PE 67.9% ($p < 0.001$), CPU/PEEH 32.6% ($p < 0.001$), UP/PE 61.9% ($p < 0.001$), CPU/BI 17.6% ($p < 0.001$), CPU/RT 38.0% ($p < 0.001$), MU/H 82.1% ($p < 0.001$) and CPU/PEES 31.3% ($p < 0.001$).

As shown on Figure 5, garlic was consumed twice a week by respondents from the groups SUA/H 31.6%, CPU/PEEH 24.6%, UP/ PE and CPU/PEES 31.3%. College students from the group MU/H (9.8%) took statistically significantly less amount of garlic with the frequency twice a week than respondents from groups CPU/PEEH ($p < 0.01$) and UP/PE ($p < 0.05$).

The most evident statistically significant differences in

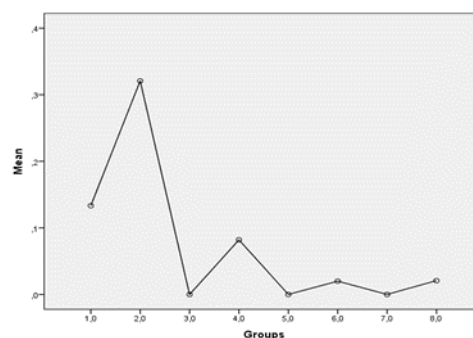

Figure 3 Consumption of garlic every day.

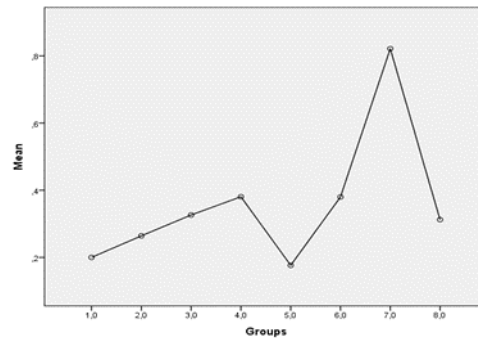

Figure 4 Consumption of garlic once a week.

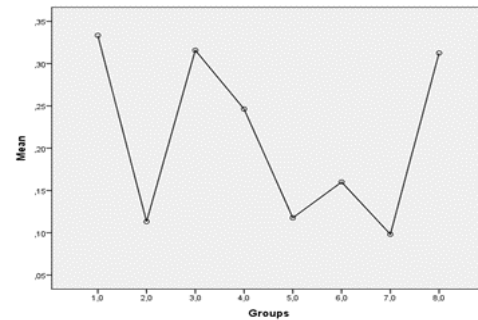

Figure 5 Consumption of garlic twice a week.

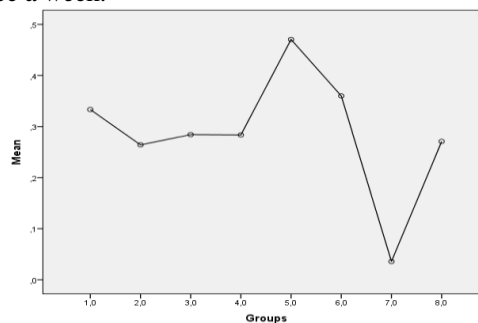

Figure 6 Consumption of garlic monthly.

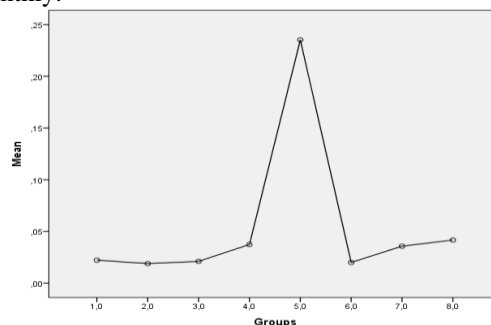

Figure 7 Consumption of garlic once a year.

monthly consumption of garlic (Figure 6) were proved between groups MU/H 3.6% and respondents from SUA/H 33.3% ($p < 0.01$), 26.4% CU/PE ($p < 0.01$), CPU/PEEH and UP/PE 28.4% ($p < 0.01$), 47.1% CPU/BI ($p < 0.05$), 36.0% CPU/RT ($p < 0.01$) and 27.1% CPU/PEES ($p < 0.05$). Our results are in accord with research study of Juríková et al. (2015) mapping the garlic consumption among college students in Nitra.

As we can see on the Figure 7, 23.5% asked students from the group CPU/BI consumed garlic only once a year. Otherwise, consumption once a year was lowest in the case of respondents from groups SU/AH 1.9%, CU/PE 2.1%, CPU/PEEH 3.7%, CU/PE 2%, CPU/RT 3.6% and MU/H 4.2% together with CPU/PEES. The low consumption of

garlic in case of CPU/PEEH is in accord with the results of study Juríková et al. (2016) in which the mentioned group displayed the lowest consumption of vegetable – once a day. The differences between groups can not be considered as statistically significant. It is also interesting finding that students at secondary schools preferred to consume garlic only during illnesses (Juríková et al., 2016). The lower consumption of garlic in fresh form can be explained by taste disturbance and body odour after consumption as it has been mentioned by Graham et al. (1994).

The evaluation of onion consumption among college students

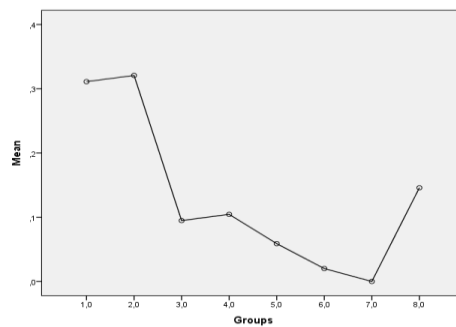

Figure 8 The everyday consumption of onion.

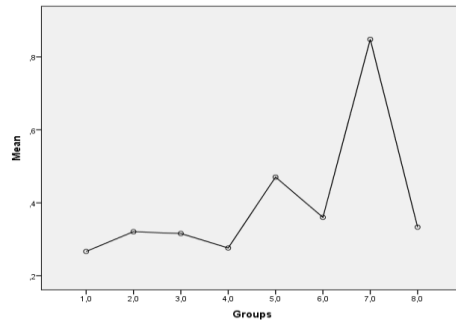

Figure 9 Consumption of onion once a week.

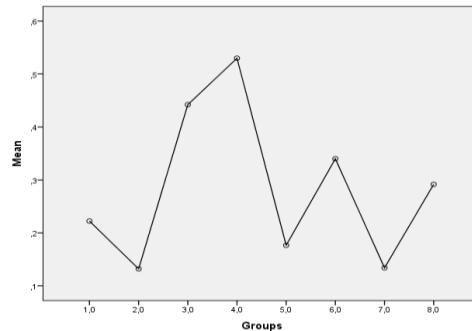

Figure 10 Consumption of garlic once a year.

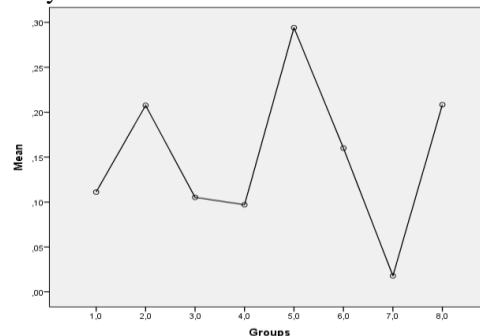

Figure 11 The everyday consumption of onion.

The highest consumption of onion on everyday base 32.1% was characteristic for the students of CU/PE and as well as SUA/H 31.1% (Figure 8). On the contrary, non consumption of onion with frequency everyday was typical for respondents from groups MU/H, the difference between groups can be evaluated as statistically significant ($p < 0.001$). Statistically significant difference was proved also between UP/PE 10.4% and MU/H 9.8% ($p < 0.01$). On the basis of responses of students the highest consumption of onion was noticed in the consumption of onion once a week especially in the group of students MU/H 84.8%. The mentioned group statistically significantly differed from SUA/H 26.7% ($p < 0.001$), CU/PE 32.1% ($p < 0.001$), CPU/PEEH 31.6% ($p < 0.001$), CPU/RT 36% ($p < 0.001$) and CPU/PEES ($p < 0.001$) (Figure 9). The relatively high

everyday consumption of onion is on contrary with the study of Juríková et al. (2016) in which student groups of CPU/PEEH and CPU/PEE S consumed the lowest amount of vegetable.

Twice a week consumed onion in the highest amount the respondents from the groups UP/PE 53% and CPU/PEEH 44.2%. On the contrary, the lowest consumption was typical for CU/PE 13.2%, CPU/BI 17.6% and MU/H 13.4%. Statistically significant differences were notified between the UP/PE and SUA/H ($p < 0.01$), CU/PE ($p < 0.001$), and MU/H ($p < 0.001$) (Figure 10 – 11). Our results are in accord with results of Juríková et al. (2016) in which students at secondary schools preferred to consume onion 2 – 3 times a week.

Frequency consumption of monthly was noticed in the lowest frequency in MU/H 1.8% that significantly differed from CU/PE 20.8% ($p < 0.05$). The highest value of consumption was noticed in CPU/BI 29.4% and

The evaluation of horse radish consumption among college students

Generally, everyday consumption of horse radish can be considered as a very low with the highest frequency

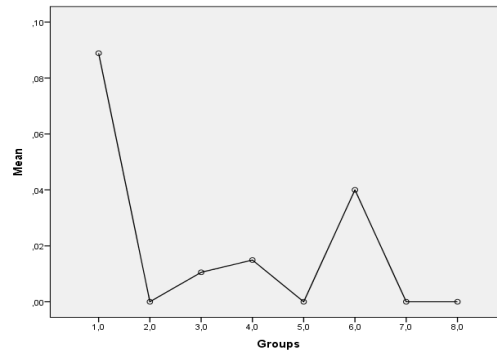

Figure 12 Consumption of onion once a week.

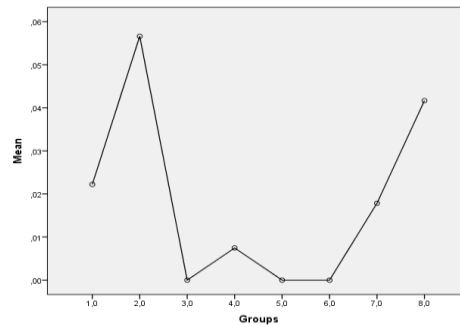

Figure 13 Everyday consumption of horse radish.

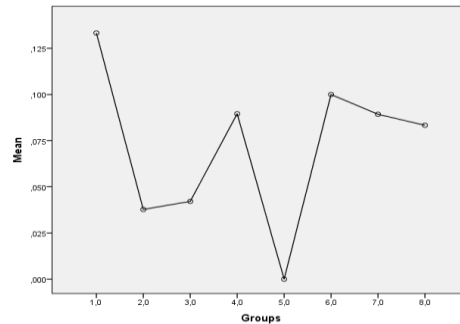

Figure 14 Consumption of horse radish once a week.

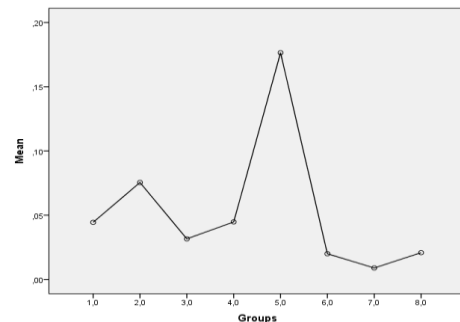

Figure 15 Consumption of horse radish twice a week.

CU/PEES. Differences between the rest of groups can not be considered as statistically significant. Our results are corresponded with research of Juríková et al. (2015).

As we can see on Figure 12, the frequency of consumption of onion once a year represented the lowest values and the differences between groups were not be statistically significant ($p > 0.05$).

CU/PE 5.7% and 4.2% CPU/PEES but the differences between groups can to be considered as statistically significant. The achieved results are in contrary with research study of Juríková et al. (2016) investigated more frequent consumption among college students in Nitra. On contrary, lower consumption of horse radish has been investigated among students from secondary school as it has been proved by another study of Juríková et al. (2016). Horse radish consumed once a week no

respondents from the group CPU/ BI that statistically significantly differed from the groups UP/PE 9% ($p < 0.05$) and MU/H 8.9% ($p < 0.05$). All differences between the rest of groups can not be considered as statistically significant ($p > 0.05$) (Figure 13 – 14).

The highest frequency of horse radish consumption twice a week was noticed in group of students CPU/ BI 17.6%, the lowest in MU/ H 0.9%. All differences between the assayed groups of students can not be evaluated as statistically significant ($p > 0.05$). Monthly usage of horse radish was evaluated as the most frequent preference of students especially in groups MU/ H 78.6%. Statistically significant differences between students was noticed between the MU/H and SUA/H 42.2% ($p < 0.01$), CU/PE 39.6% ($p < 0.001$), CPU/PEEH 42.1% ($p < 0.001$), UP/PE 38.1% ($p < 0.001$), CPU/RT 36% and CPU/PEES ($p < 0.001$) (Figure 15 – 16).

As we can see, the highest percentage of horse radish consumption once a year was noticed in case of students CU/PE 30.6%. In group MU/H was the consumption of horse radish significantly lower in comparison with the groups CPU/ PEEH 23.2% ($p < 0.05$) and UP/PE 30.6% ($p < 0.001$). The relatively high amount of consumed horse radish in group CPU/ PEEH is on contrary with results of study Juríková et al. (2016). The differences between another groups of students can not be noticed as statistically significant ($p > 0.05$) (Figure 17).

CONCLUSION

As a positive fact of our questionnaire (554 respondents) is the fact that the majority of college students (85%) had the basic knowledge about natural antibiotics and moreover they used them in everyday life (60.3%). The prevailing number of students utilize synthetic antibiotics only once a year (33.4%) or never (37.5%). The most common usage of natural antibiotics among students is the consumption of garlic once a week (42.2%); the highest consumption was noticed in the group of Slovak students with the main college subject of Physical education (32.1%). On the contrary, the lowest garlic utilization was noticed for students of biology (23.5%). Also onion is consumed by the majority of respondents (42.10%) once a week. Everyday consumption was noticed for students of CU/PE (32.1%) and SUA/H (31.1%) that significantly differed from other groups of students. The biggest group of students (46%) consume horse radish monthly. The lowest consumption was noticed in case of UP/PE student group (30.6%) that consume horse radish only once a year.

REFERENCES

Al-Daihan, S., Al-Faham, M., Al-shawi, N., Almayman, R., Brnawi, A., Zargar, S., Bhat, R. S. 2013. Antibacterial activity and phytochemical screening of some medicinal plants commonly used in Saudi Arabia against selected pathogenic microorganisms. *Journal of King Saud University – Science*, vol. 25, no. 2, p. 115-120. <https://doi.org/10.1016/j.jksus.2012.11.003>

Aydin, A., Ersoz, G., Tekesin, O., Akcicek, E., Tuncyurek, M., Batur, Y. 1997. Does garlic oil have a role in the treatment of *Helicobacter pylori* infection? *Turkish Journal of Gastroenterology*, vol. 8, p. 181-184.

Betoni, J. E., Mantovani, R. P., Barbosa, L. N., Stasi, L. C., Fernandez, Jr. A. 2006. Synergism between plant extract and

antimicrobial drugs used on *Staphylococcus aureus* diseases. *Mem Inst Oswaldo Cruz.*, vol. 10, no. 4, p. 387-390. <https://doi.org/10.1590/S0074-02762006000400007>

Buhner, S. H. 2012. *Herbal antibiotics*. 2nd ed. North Adams : Storey Publishing, 480 p. ISBN 978-1-60342-987.

Cowan, M. M. 1999. Plant products as antimicrobial agents. *Clinical Microbiology Reviews*, vol. 12, no. 4, p. 564-582. [PMCid:PMC88925](https://doi.org/10.1128/CMR.12.4.564-582)

Graham, D. Y., Anderson, S. Y., Lang, T. 1994. Garlic or jalapeno peppers for the treatment of *Helicobacter pylori* infection. *American Journal of Gastroenterology*, vol. 94, no. 5., p. 1200-1202. <https://doi.org/10.1111/j.1572-0241.1999.01066.x>

Elnima, E. I., Ahmed, S. A., Mekkawi, A. G., Mossa, J. S. 1983. The antimicrobial activity of garlic and onion extracts. *Die Pharmazie*, vol. 38, no. 11, p. 747-748.

Fatrcová-Šramková, K., Nôžková, J., Kačaniová, M., Máriássyová, M., Rovná, K., Stričík, M. 2013. Antioxidant and antimicrobial properties of monofloral bee pollen. *Journal of Environmental Science and Health, Part B*, vol. 48, no. 2, p. 133-138. <https://doi.org/10.1080/03601234.2013.727664>

Hara, O. M., Keifer, D., Farrel, K., Kemper, K. 1998. A review of 12 commonly used medicinal herbs. *Archives of Family Medicine*, vol. 7, no. 6, p. 523-536. <https://doi.org/10.1001/archfami.7.6.523>

Jakubcova, Z., Zeman, L., Mares, P., Mlcek, J., Jurikova, T., Dostalova, L., Mrazkova, E., Mrkvicova, E., Balla, S., Sochor, J. 2014. Effect of chamomile supplements to feeding doses on antimicrobial parameters in poultry. *Potravinárstvo*, vol. 8, no. 1, p. 228-232. <https://doi.org/10.5219/383>

Juríková, T., Viczayová, I., Mlček, J., Sochor, J., Balla, Š., Baroň, M. 2016. Fruit and vegetable intake among college students in Nitra – comparative study. *Potravinárstvo*, vol. 10, no. 1, p. 475-480. <https://doi.org/10.5219/639>

Juríková, T., Viczayová, I., Matejovičová, B. et al. 2015. *The evaluation of selected aspects of life style of college students*. 1st ed., Nitra : Constantine the Philosopher University, 194 p. ISBN 978-80-558-0930-4. [PMCid:PMC4632771](https://doi.org/10.1001/archfami.7.6.523)

Juríková, T., Viczayová, I., Benčuriková, E. et al. 2016. *The evaluation of herbal antibiotics consumption among college students*. 1st ed., Nitra : Constantine the Philosopher University, 186 p. ISBN 978-80-558-1083-6.

Juríková, T., Tóthová, N., Viczayová, I., Hegedúsová, A., Balla, Š., Spáčilová, Z. 2016. Evaluation of Fruit and Vegetable Consumption as Natural Antibiotics in Secondary Schools in the District of Lučenec (Vyhodnotenie konzumácie ovocia a zeleniny ako prírodných antibiotík u stredoškôľakov v okrese Lučenec). *Záhradníctvo*, SPU : Nitra, p. 18-126. ISBN 978-80-552-1538-9.

Káčaniová, M., Fatrcová-Šramková, K., Nôžková, J., Melich, M., Kadasi-Horáková, M., Knazovicka, V., Felsöciová, S., Kunová, S., Máriássyová, M. 2010. Antiradical activity of natural honeys and antifungal effect against *Penicillium* genera. *Journal of Environmental Science and Health, Part B*, vol. 46, no. 1, p. 92-96. <https://doi.org/10.1080/03601234.2011.534416>

Kim, J. H., 1997. Anti-bacterial action of onion (*Allium cepa* L.) extracts against oral pathogenic bacteria. *The Journal of Nihon University School of Dentistry*, vol. 39, no. 3, p. 136-141. <https://doi.org/10.2334/josnusd1959.39.136>

Kim, H. Y., Sarinnart, P., Shik, S. 2015. Antibacterial activities of isothiocyanates extracted from horseradish (*Armoracia rusticana*) root against Antibiotic-resistant

bacteria. *Food Science and Biotechnology*, vol. 24, no. 3, p. 1029-1034. <https://doi.org/10.1007/s10068-015-0131-y>

Mahalingam, R., Bharathidasan, R., Ambikapathy, V., Panneerselvam, A. 2011. Studies on antibacterial activity of some medicinal plant against Human pathogenic Micro Organism. *Asian Journal of Plant Science and Research*, vol. 1, no. 3, p. 86-90.

Martin, K. W., Ernst, E. 2003. Herbal medicines for treatment of bacterial infections, review of controlled clinical trials. *Journal of Antimicrobial Chemotherapy*, vol. 51, no. 2, p. 241-246. <https://doi.org/10.1093/jac/dkg087>

Nascimento, G. G. F., Locatelli, J., Freitas, P. C., Silva, G. L. 2000. Antibacterial activity of plant extracts and phytochemicals on antibiotic-resistant bacteria. *Brazilian Journal of Microbiology*, vol. 31, no. 1, p. 247-256. <https://doi.org/10.1590/S1517-83822000000400003>

Park, H. W. L., Choi, K. D., Shin, I. S. 2013. Antimicrobial activity of isothiocyanates (ITCs) extracted from horseradish (*Armoracia rusticana*) root against oral microorganisms. *Biocontrol Science*, vol. 18, no. 3, p. 163-168. <https://doi.org/10.4265/bio.18.163>

Silva, N. C. C., Fernandes, J. 2010. Biological properties of medicinal plants: a review of their antimicrobial activity. *The Journal of Venomous Animals and Toxins including Tropical Diseases*, vol. 16, no. 3, p. 402-413. <https://doi.org/10.1590/S1678-91992010000300006>

Valle, D. L., Andrade, J. I., Puzon, J. J. M., Cabrera, E. C., Rivera, W. L. 2015. Antibacterial activities of ethanol extracts of Philippine medicinal plants against multidrug-resistant bacteria. *Asian pacific journal of tropical biomedicine*, vol. 5, no. 7, p. 532-540. <https://doi.org/10.1016/j.apjtb.2015.04.005>

Acknowledgments:

This work was supported by grant IGA/FT/2017/006 and VEGA 1/0083/16.

Contact address:

doc. RNDr. Tünde Juríková, PhD., Institute for Teacher Training, Faculty of Central European Studies, Constantine the Philosopher University in Nitra, Drážovská 4, 949 74 Nitra, Slovakia, E-mail: tjurikova@ukf.sk

PaedDr. Ildikó Viczayová, PhD., Institute for Teacher Training, Faculty of Central European Studies, Constantine the Philosopher University in Nitra, Drážovská 4, 949 74 Nitra, Slovakia, E-mail: iviczayova@ukf.sk

prof. RNDr. Alžbeta Hegedúsová, PhD., Slovak University of Agriculture in Nitra, Faculty of Horticulture and Landscape Engineering, Department of Vegetable Production, Tulipánová 1117/7, 949 76 Nitra, E-mail: alzbeta.hegedusova@uniag.sk

doc. Ing. Jiří Mlček, Ph.D., Tomas Bata University in Zlín, Faculty of Technology, Department of Food Analysis and Chemistry, nám. T. G. Masaryka 5555, 760 01 Zlín, Czech Republic, E-mail: mlcek@ft.utb.cz

doc. József Kontra, PhD., University of Kaposvár, Faculty of Pedagogy, Department of Psychology, Új Tanügyi Épület 122, Hungary, E-mail: kontra.jozsef@ke.hu

Ing. Lukáš Snopek, Tomas Bata University in Zlín, Faculty of Technology, Department of Food Analysis and Chemistry, nám. T. G. Masaryka 5555, 760 01 Zlín, Czech Republic, E-mail: lsnopek@ft.utb.cz

WELFARE OF THE MEALWORM (*TENEBRIO MOLITOR*) BREEDING WITH REGARD TO NUTRITION VALUE AND FOOD SAFETY

Anna Adámková, Martin Adámek, Jiří Mlček, Marie Borkovcová, Martina Bednářová, Lenka Kouřimská, Josef Skácel, Eva Vítová

ABSTRACT

Livestock welfare is an important condition for obtaining high-quality and safe food. According to the legislation edible insects are classified as livestock; and for this reason it is necessary to comply with the edible insect welfare conditions. This article focuses on selected welfare conditions for mealworm (*Tenebrio molitor*) breeding, with special focus on the fat content influenced by different breeding temperature (17 °C, 23 °C and 28 °C). Maximum fat content 24.56% was observed at 23 °C. To obtain maximum fat content this appears to be the optimal breeding temperature. Another evaluated aspect was the nutritional stress and a way of killing, and their impact on fat content, which showed to decrease with the nutrient stress. The most decline was detected towards the end of the observation period. The analysis showed that in terms of preservation of the fat content, the best way is killing by freezing, due to the metabolism slowdown. We also analysed the content of heavy metals in a mealworm larvae using cyclic voltammetry with subsequent evaluation. In the measured sample concentrations of heavy metals did not exceed the maximum allowable concentration of heavy metals in this commodity. From this point of view mealworm appears to be a safe food.

Keywords: welfare; *Tenebrio molitor*; nutritional stress; way of killing; heavy metal

INTRODUCTION

Animal welfare is a condition, when the animal organism tries to deal with the surrounding (Broom, 1986). Welfare is defined as a state of fulfilment of all material and immaterial conditions, which are prerequisites for the health of the animal, and are also in accordance with its environment (Angelovičová and Poláčková, 2015; Doležal, Bílek and Dolejš, 2004). Webster (2016) described the five freedoms of animal welfare. It is freedom from hunger, thirst, discomfort, pain, injury, disease, fear and distress, and the expression of normal behaviour (van Huis et al., 2013). According to the Regulation (EC) No. 1069/2009 insect breeding is considered as breeding of common livestock. Because of this it is necessary to follow the rules of insect welfare as well as with other livestock. That's why Eisemann et al. (1984) suggested, that insect should be given the benefit of the doubt (van Huis et al., 2013).

Among the species with the greatest potential as food and feed within the European Union are mealworm (*Tenebrio molitor*), giant mealworm (*Zophobas atratus*), lesser mealworm (*Alphitobus diaperinus*), greater wax moth (*Galleria mellonella*), silkworm (*Bombyx mori*), house cricket (*Acheta domestica*) and African migratory locust (*Locusta migratoria migratorioides*) (EFSA, 2015).

Mealworm (*Tenebrio molitor*) in general belongs to the food pests (Schroeckenstein, Meier-Davis and Bush, 1990; Wang, Liao and Chen, 2012), however, thanks to its nutritional values, easy breeding and minimal environmental burden it has a potential to become a fully-fledged source of protein and fat for mankind (Wang, Liao and Chen, 2012). Nutritionally, it is important in terms of protein and fat, and there is a presumption of good use in the food industry (Park et al., 2014). Another mealworm benefit could be biodegradation of organic waste to proteins (Veldkamp et al., 2012). Based on the above advantages, possibilities for rearing this species in space are being explored (Katayama et al., 2008).

From the economical point of view, mealworm breeding is cheap and fast (Wang, Liao and Chen, 2012). According to Li, Zhao and Liu (2013) its life cycle is short, egg stage lasts 3 – 9 days, larval stage 26 – 76 days and pupal stage 5 – 17 days. Rearing usually takes place in breeding tanks with feed at the bottom (often cereal meal, milk powder and bone meal) (Hůrka, 2005). Growth rate and size of individuals is affected by several factors, including temperature, humidity, light intensity, composition of the feed and density of specimens within the breeding tanks (Wu et al., 2009).

One of the main factors influencing the growth speed is the temperature (Xu et al., 2012). With growing

temperature the live cycle shortens. In 20 °C the length of the life cycle was 97 days, and in 32 °C only 60 days (Xu et al, 2012). However, with growing temperature the weight of pupae and adult specimens tends to decrease from certain temperature level (Kim et al., 2015).

Another factor is the insect feed. Suitable feed is necessary for maintaining good health and optimal specimen performance (Dussutour et al., 2016). However, freely living animals do not necessarily have the access to the feed that reflects their nutritive needs. The influence of the nutritional composition of feed on the nutritional value of insects had been investigated (Li, Zhao and Liu, 2013). Nutritive stress or small breeding space leads to cannibalism (Wu et al., 2009) and decreases the breeding yield. Killing is carried out in different ways, most commonly by freezing, direct grinding, or cooling and subsequent killing by boiling. Methods of killing insects, however, should be chosen so as to avoid insect suffering (van Huis, 2013). Prior to the slaughter, dead individuals must be sorted out.

Due to inadequate safety review of edible insects as a novel food for humans in the EU, it is necessary not only to know the rules of breeding and provide sufficient welfare, but also to know the effect of eating insects to human health and safety risks (EFSA, 2015). EFSA (2015) draws attention to the lack of safety reviews of the insect consumption and various risks, including the contents of heavy metals (mainly Cd, Pb, Hg, and As) and calls for setting limits for safe consumption.

This article focuses on the impact of nutrient stress as a welfare aspect, and ways of killing on the nutritional value (fat content) of the final product. Furthermore, the article deals with the safety of edible insects in terms of the content of heavy metals (Cd and Pb), which have a significant impact on human health.

MATERIAL AND METHODOLOGY

Material

Insect

Larvae of mealworm (*Tenebrio molitor*) were used for the analysis (Figure 1). Samples were bought in the pet supplies store Krmiva Hostovice.



Figure 1 Larvae of mealworm (*Tenebrio molitor*)

Feed

Wheat brans with the following nutritional values were used as feed (values for 100 g of product): Energy: 1210 kJ / 292kcal, Fat 5.3 g, of which saturated fatty acids 0.88 g, carbohydrates 24.9 g, of which sugars 2.2 g, fibre 40.2 g a protein 16.2 g, salt 0.1 g. Company: Country Life, s.r.o., Beroun 1.

Chemicals

- Petrol ether 40/65, p.a., CAS No.: [8032-32-4], Ing. Petr Švec – PENTA s.r.o., Praha,
- HNO₃ 65%, p.a., CAS No.: [7697-37-2], Ing. Petr Švec – PENTA s.r.o., Praha,
- H₂O₂ 30%, p. a., CAS No.: [7722-84-1], Ing. Petr Švec – PENTA s.r.o., Praha,
- CdCl₂ p. a. – Mr. 183,32, CAS No.: [10108-64-2], Fluka analytical, Sigma Aldrich,
- PbCl₂ p. a. – Mr. 278,11, Lachema, n. p., Brno, CZ,
- Deionized water – 18.2 MOhm cm, Milli-Q, Millipore.

All chemicals were of analytical reagent grade or equivalent analytical purity.

Methods

Insect processing

In the first experiment, mealworm larvae were divided into three experimental groups. These experimental groups were placed in a plastic boxes in a thermostat (HS 62A, Chirana) by rearing temperature of 17 °C, 23 °C and 28 °C. The groups were fed ad libitum. Before analysis, larvae in the last and penultimate instar development (the full length of the body just before pupation) were collected from breeding. Subsequently the larvae were left to starve for 24 hours and then killed with boiling water (100 °C). The prepared samples were dried at 105 °C, homogenized and stored in a cold storage box at 4 – 7 °C until analysis.

For the second experiment, two groups of mealworms were bred in room temperature 22 °C ± 2 °C and divided by the nutrient stress. The first group was fed wheat brans ad libitum during the whole test. The other group was in nutritional stress, which means without feed for 27 and 39 days. Before analysis, larvae in the last and penultimate

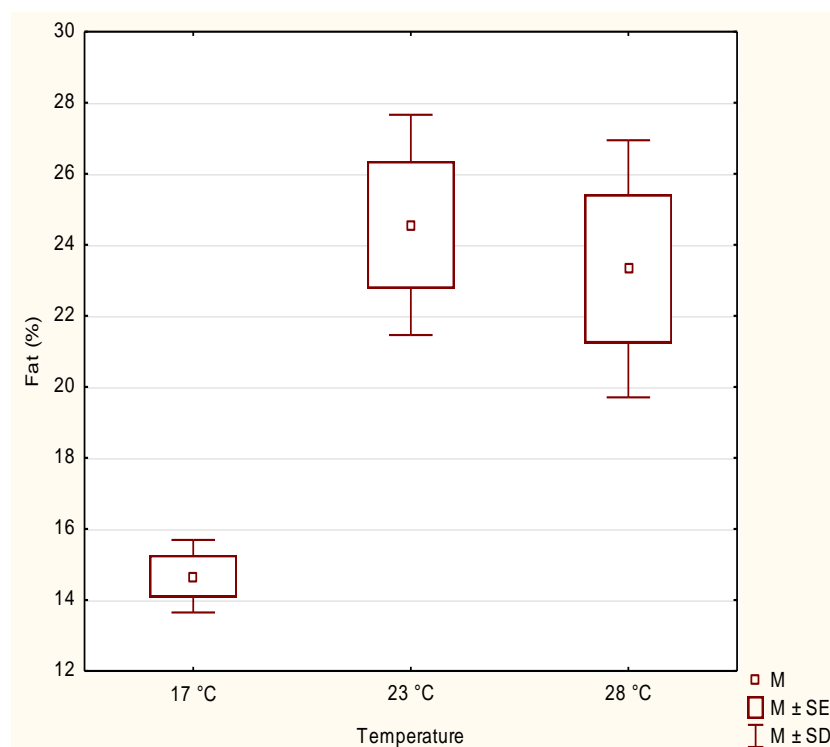

Figure 2 Fat content in mealworm (*Tenebrio molitor*) -dependency on the breeding temperature (boxplot).

Table 1 Fat content in mealworm (*Tenebrio molitor*) and its dependency on the breeding temperature.

Sample	Fat (%)
TM 17 °C	14.67
TM 23 °C	24.56
TM 28 °C	23.32

instar development (the full length of the body just before pupation) were collected from breeding. Subsequently the larvae were left to starve for 24 hours. Each group was then divided into two sub-groups. The first sub-group was killed by freezing (-18 °C) in the freezer and the second one was killed by boiling water (100 °C). Dead larvae were dried at 105 °C, homogenized and stored in a cold storage box at 4 – 7 °C until analysis.

Fat content determination

The fat content determination was performed by extraction using Soxhlet method (Soxhlet, 1879) on the Gerhardt Soxtherm SOX414 (C. Gerhardt GmbH & Co. KG, Germany). Approximately 5 g of dried and homogenized samples (with the accuracy of 0.0001 g) were put into extraction thimbles and extracted with 150 ml of petroleum ether via cold water extraction (program: 70 °C for 120 minutes). The extraction flask was then dried at 103 °C and weighed until a constant sample weight was attained.

Heavy metals content

0.1 g of homogenized sample was put into a vial, and then 2 mL HNO₃ with 65% concentration was added. Metals were being extracted for 24 hours at room temperature and then heated to reach the temperature 110 °C for 1 hour. Subsequently, 200 µL 30% H₂O₂ was added and the sample was kept warm for another 30 minutes. After cooling the sample was diluted 5 times with deionized water (v/v) (18.2 MOhm cm, Milli-Q,

Millipore). Prior to the analysis the sample was diluted 10 times using an acetate buffer (v/v).

Detection of selected metals (Cd, Pb) was carried out using cyclic voltammetry within the range $U = <-1000; +400 > mV$ with scanning speed 10 mV s⁻¹. Accumulation time was $t_{cond} = 45 s$ with potential $E_{cond} = -1000 mV$. To evaluate metals, analytic electrochemical station µAUTOLAB, Type III/ FRA 2 was used with NOVA 1.11 application. Ag/AgCl Reference Electrode Metrohm AG, Switzerland was used as a reference electrode. Pt Rod Electrode Metrohm AG, Switzerland, was used as auxiliary electrode. Working electrode was created using the thick layer method on a ceramic substrate (Al₂O₃). Sensor size was 25.4 mm × 7.25 mm × 625 µm. The silver duct outcome was created by ESL 9562-G paste (ESL Electroscience, England). Working electrode with 3 mm diameter was created using DuPont 7102 paste (DuPont, USA). ESL 4917 paste (ESL Electroscience, England) was used to create the protective cover layer. Measured characteristics were derived and analysed in Excel 2013 (Microsoft Corporation, USA).

Statistical analysis

Data obtained from chemical analysis was processed using MS Excel (Microsoft Corporation, USA), to calculate basic percentage of fat content. These data was then processed using the Statistica 12 (StatSoft, Inc., USA) application.

RESULTS AND DISCUSSION

Breeding temperature is one of the most important factors affecting the development speed (Xu et al., 2012). In our study, we examined the fat content dependency on the temperature (17 °C, 23 °C and 28 °C). Table 1 and Figure 2 show that the fat content at 17 °C is lower than at 23 °C, but further increase of the temperature to 28 °C did not lead to greater change. These are, however, the initial results, which will be further verified.

While different studies show the general influence of temperature on the edible insect nutritional value, available sources do not state any specific dependence of nutritional values on the breeding temperature (Ooninx and van der Poel, 2011). Xu et al. (2012) investigated the optimum temperature for breeding mealworm (*Tenebrio molitor*) and compared five different temperatures (20 °C, 23 °C, 26 °C, 29 °C a 32 °C). Their results showed that the mealworm development gets faster with growing temperature. Also the numbers of laid eggs grew (max. at 29 °C) (Xu et al., 2012), however, the weight of pupa and adult decreased (Kim et al., 2015). The change in weight and size of specimens in different temperatures can suggest the change of their nutritive value. Role of nutrition is to provide the needed nutrients into the body via the feed, in order to preserve life, growth, reproduction, good health and performance. The body can relieve the lack of food (nutritional stress) by drawing energy from adipose tissue, mineral saturation from skeletons, nitrogenous substances saturation or more economical excretion of certain elements. The depletion of certain nutrient without refilling may result in death of the individual. Lack of fats reduces the viability, slows

growth, reduces reproduction, performance and leads to diseases; long-term deficiency has lethal effects (Horniaková et al., 2010). To observe the effect of nutritional stress, insect was divided into two experimental groups. The first one was fed ad libitum; the other was in nutritional stress by starving for 27 and 39 days. In the second group the cannibalism occurred more often, as also mentioned by Erens et al. (2012). Subsequently, both groups of starving insects were divided into sub-group killed by freezing (-18 °C) and boiling water (100 °C). The results of the fat content show that with the length of starving the fat content decreases (see Figure 3). A difference was detected between the groups for both ways of killing. This trend became more significant towards the end of the experiment. It's supposed that the reason is decreasing of the fat deposits in insect bodies due to their consumption by basal metabolism (Nation, 2015).

Changes in fat content in insect bodies as well as insect behaviour were observed also by (Dussutour, 2016) in ants. Decrease of the fat content was detected after reducing the nutrient concentration in the diet, when the ratio of proteins to carbohydrates was increased, and when the ants were starving. Regression model shows that the fat content was determined almost exclusively by the carbohydrate intake. There was also a change in the fat content among various castes (Dussutour, 2016). However, nutritional stress can be caused not only by the lack of feed as a whole, but also by the lack of a specific nutrient. For example Simpson a Raubenheimer (2012) state that excessive consumption of carbohydrates leads to obesity when feed is low in protein with ratio to carbohydrates, while the lack of carbohydrates in the diet leads to a lack of energy.

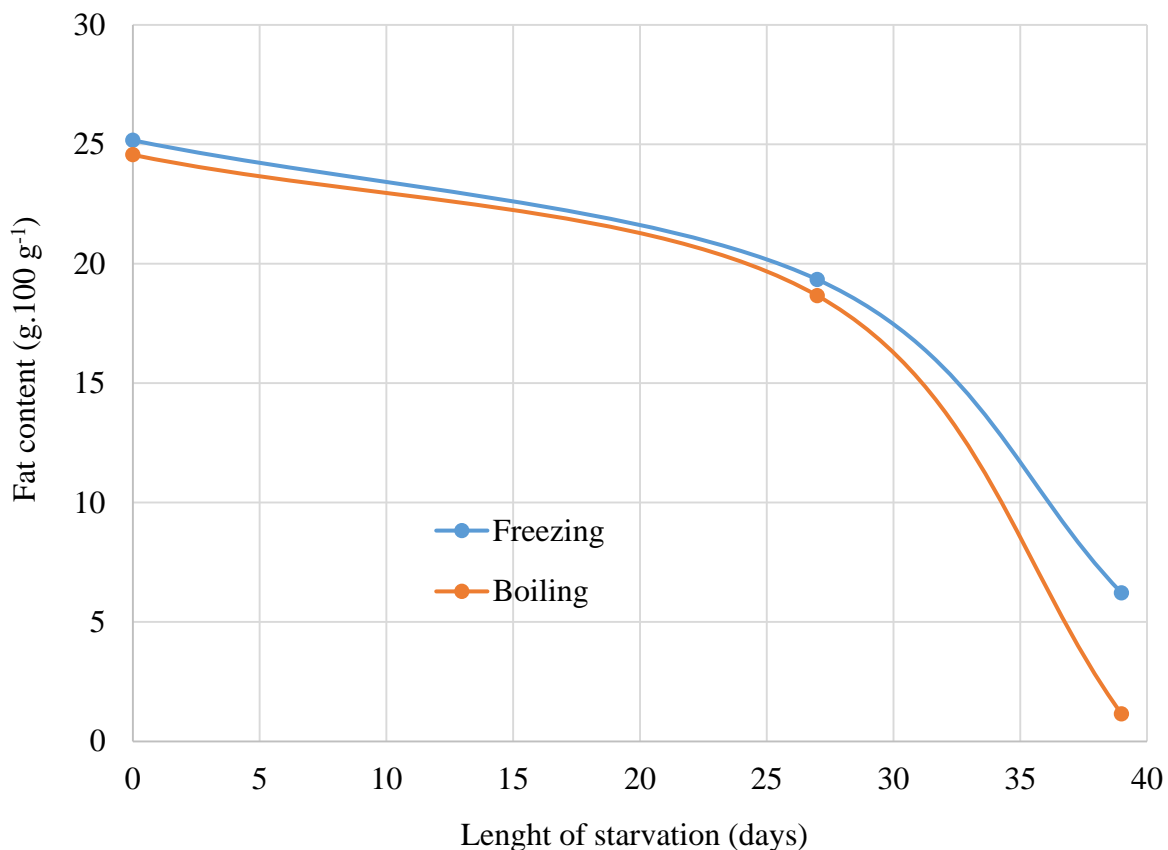

Figure 3 Mealworm (*Tenebrio molitor*) fat content dependency on the length of starvation and the way of killing.

Some ways of killing insect, described by Erens et al. (2012), are considered humane, but as he states, some processors reject them for financial reasons. Benefit of freezing, for example, is that by putting insect into the freezer, its metabolism slows down (hibernation), until it freezes. Freezing should be carried out quickly to prevent tissue damage (Drdák, 1989). Considering the nutritional stress, there was no difference between the ways of killing. However, Figure 3 shows that the group killed by freezing had a higher fat content than the group killed by boiling water. We suppose that the loss of fat in the second group may be caused by fat extraction into the boiling water. When using the fat for protection from the cold and freeze, the losses were smaller than with boiling. Heavy metal concentration in food and feed for animal breeding is an important topic of health safety and has an impact on the consumers' health (Chovancová et al., 2014; Lukáčová et al., 2014). In our research we focused on the detection of cadmium and lead in edible insect using carbon electrode created with the technology of thick layers. After creating the calibration curves the cadmium and lead concentration was evaluated in mealworm larvae (*Tenebrio molitor*) in last and penultimate instar development, bred in 23 °C and fed by wheat brans ad libitum. Both cadmium and lead concentration was below the limit of detectability of the used sensor (detection limit is 2 µg.L⁻¹ for lead and 3 µg.L⁻¹ for cadmium). The sensor can be used to detect the levels of cadmium and lead, stated as a maximum limit in Regulation (EC) No. 1881/2006 (Pb 0.5 mg.kg⁻¹ that is 2.41 µg.L⁻¹ and Cd 4.46 µg.L⁻¹). Although these are initial results, gained with using sensor with detection limits slightly below the maximum allowable concentration in this commodity, the content of cadmium and lead seems to be safe for using insect as human food.

Poma (2017) evaluated nine mineral elements in his study. In mealworm (*Tenebrio molitor*) the content he detected was: Cd 0.06 mg.kg⁻¹ and content of Pb was lower than the detection limit. The level of heavy metals evaluated in this study was lower than requested by the Regulation (EC) No. 1881/2006 and lower or comparable with other commodities of animal origin.

CONCLUSION

Our work was focused on the impact of welfare on the nutritional value and safety of the mealworm (*Tenebrio molitor*), as a potential food source. As an analysis of fat content indicates, breeding temperature – as one of the welfare factors – significantly affects the fat content. Other evaluated welfare factor was nutritional stress, while the experimental group loaded with nutritional stress had lower fat content. It can be concluded, that nutritional deprivation affects not only the animal welfare, but also nutritional yield with a further impact on the economic aspects of breeding. For commercially raised livestock the moment of death is an important part of animal welfare, having an impact on the nutritional value and quality of the meat obtained. The way of killing also influenced the nutritional values of mealworm larvae in our study. From the viewpoint of fat yield, killing by freezing can be recommended.

Although the question of heavy metals content is not part of welfare, it is an important aspect of the food safety.

Based on our study, we can conclude that heavy metal content of the analysed species was lower than the maximum permitted levels of heavy metals in food. From this point of view, the consumption of mealworm larvae is safe.

REFERENCES

- Angelovičová, M., Polačková, D. 2015. Assessment of welfare and egg production of laying hens Moravia SSL in small-scale breeding. *Potravinárstvo*, vol. 9, no. 1, p. 365-374. <https://doi.org/10.5219/514>
- Broom, D. M., 1986. Indicators of poor welfare. *British Veterinary Journal*, vol. 142, no. 6, p. 524-526. [https://doi.org/10.1016/0007-1935\(86\)90109-0](https://doi.org/10.1016/0007-1935(86)90109-0)
- Doležal, O., Bílek, M., Dolejš, J. 2004. *Principles of welfare and new EU standards in cattle breeding (Zásady welfare a nové standardy EU v chovu skotu)*. Praha, Czech Republic : Výzkumný ústav živočišné výroby. 70 p. ISBN: 9788086454511.
- Drdák, M. 1989. *Technológia rastlinných neúdržných potravín. (Technology of plant perishable food)* Bratislava, Slovakia : ALFA. 301 p. ISBN 80-05-00121-5.
- Dussutour, A., Poissonnier, L. A., Buhl, J., Simpson, S. J. 2016. Resistance to nutritional stress in ants: when being fat is advantageous. *Journal of Experimental Biology*, vol. 219, p. 824-833. <https://doi.org/10.1242/jeb.136234>
- EFSA, 2015. Risk profile related to production and consumption of insects as food and feed. *EFSA Journal*, vol. 13, no. 10, 60 p. <https://doi.org/10.2903/j.efsa.2015.4257>
- Eisemann, C. H., Jorgensen, W. K., Merritt, D. J, Rice, M. J., Cribb, B. W, Webb, P. D., Zalucki, M. P. 1984. Do insects feel pain? A biological view. *Experientia*, vol. 40, no. 2, p. 164-167. <https://doi.org/10.1007/BF01963580>
- Erens, J., van Es, S., Haverkort, F., Kapsomenou, E., Luijben, A. 2012. *A bug's life: largescale insect rearing in relation to animal welfare* [online] s.a. [cit. 2017-02-28]. Available at: <http://venik.nl/site/wp-content/uploads/2013/06/Rapport-Large-scale-insect-rearing-in-relation-to-animal-welfare.pdf>.
- Horniaková, E., Bíro, D., Pajtaš, M., Gálik, B., Šimko, M., Juráček M., Rolinec M. 2010. *Basics of nutrition (Základy výživy)* 1st ed. Nitra, Slovakia : Slovenská poľnohospodárska univerzita, 137 p. ISBN 978-80-552-0446-8.
- Hůrka, K. 2005. *Beetles of Czech and Slovak Republic (Brouci České a Slovenské republiky)*. 1st ed. Zlín, Czech Republic : Kloubourek. 390 p. ISBN 8086447111.
- Chovancová, H., Omelka, R., Boboňová, I., Formicki, G., Toman, R., Martiniaková, M. 2014. Bone adaptation to simultaneous cadmium and diazinon toxicity in adult male rats. *Potravinárstvo*, vol. 8, no. 1, p. 107-113. DOI: <https://doi.org/10.5219/343>
- Katayama, N., Ishikawa, Y., Takaoki, M., Yamashita, M., Nakayama, S., Kiguchi, K., Kok, R., Wada, H., Mitsuhashi, J. 2008. Entomophagy: A key to space agriculture. *Advances in Space Research*, vol. 41, no. 5, p. 701-705. <https://doi.org/10.1016/j.asr.2007.01.027>
- Kim, S. Y., Park, J. B., Lee, Y. B., Yoon, H. J., Lee, Y., Kim N. J. 2015. Growth characteristics of mealworm *Tenebrio molitor*, *Journal of Sericultural and Entomological Science*, vol. 53, no. 1, p. 1-5. <https://doi.org/10.7852/jses.2015.53.1.1>
- Li, L. Y., Zhao, Z. R., Liu, H. 2013. Feasibility of feeding yellow mealworm (*Tenebrio molitor* L.) in bioregenerative life support systems as a source of animal protein for humans. *Acta Astronautica*, vol. 92, no. 1, p. 103-109. <https://doi.org/10.1016/j.actaastro.2012.03.012>

- Lukáčová, A., Golian, J., Massányi, P., Formicki, G. 2014. Lead concentration in meat and meat products of different origin. *Potravinářstvo*, vol. 8, no. 1, p. 43-47. <https://doi.org/10.5219/334>
- Nation, J. L. 2015. *Insect Physiology and Biochemistry*. 3rd ed. Boca Raton, FL, USA : CRC Press. 690 p. ISBN 1482247607, 9781482247602.
- Oonincx, D. G. A. B., van der Poel, A. F. B. 2011. Effects of diet on the chemical composition of migratory locusts (*Locustamigratoria*). *Zoo Biology*, vol. 30, no. 1, p. 9-16. <https://doi.org/10.1002/zoo.20308>
- Park, J. B., Choi, W. H., Kim, S. H., Jin, H. J., Han, Y. S., Lee, Y. S., Kim, N. J. 2015. Developmental characteristics of *Tenebrio molitor* larvae (*Coloptera: Tenebrionidae*) in different instars. *International Journal of Industrial Entomology*, vol. 28, no. 1, p. 5-9. <https://doi.org/10.7852/ijie.2014.28.1.5>
- Poma, G., Cuykx, M., Amato, E., Calaprince., Focant, J. F., Covaci, A. 2017. Evaluation of hazardous chemicals in edible insects and insect-based food intended for human consumption. *Food and Chemical Toxicology*, vol. 100, p. 70-79. <https://doi.org/10.1016/j.fct.2016.12.006>
- Regulation (EC) No. 1069/2009 of the European Parliament and of the Council laying down health rules as regards animal by-products and derived products not intended for human consumption and repealing Regulation (EC) No. 1774/2002 (Animal by-products Regulation). OJ L 300, 21.10.2009, p. 1-33.
- Regulation (EC) No. 1881/2006 setting maximum levels for certain contaminants in foodstuffs.. OJ L 364/5, 20.12.2006, p. 5-24.
- Schroekenstein, D. C., Meier-Davis, S., Bush, R. K. 1990. Occupational sensitivity to *Tenebrio molitor* Linnaeus (yellow mealworm). *Journal of Allergy and Clinical Immunology*, vol. 86, no. 2, p. 182-188. [https://doi.org/10.1016/S0091-6749\(05\)80064-8](https://doi.org/10.1016/S0091-6749(05)80064-8)
- Simpson, S. J., Raubenheimer, D. 2012. *The nature of nutrition: a unifying framework from animal adaptation to human obesity*. New Jersey, NY : Princeton University Press. 239 p. ISBN 9780691145655. <https://doi.org/10.1515/9781400842803>
- Soxhlet, F. 1879. Die gewichts analytische Bestimmung des Milch fettes. *Dingler's Polytechnisches Journal*, vol. 232, p. 461-465.
- van Huis, A., van Itterbeeck, J., Klunder, H., Mertens, E., Halloran, A., Muir, G., Vantomme, P. 2013. *Edible insects: Future prospects for food and feed security*. Rome, Italy : FAO UN, Forestry Department, 201 p.
- Veldkamp, T., van Duinkerken, G., van Huis, A., Lakemond, C. M. M., Ottevanger, E., Bosh, G., van Boekel, T. 2012. *Insects as a sustainable feed ingredient in a pig poultry diets: a feasibility study*. Lelystad : Wageningen UR Livestock Research, 48 p.
- Wang, H. C., Liao, H. Y., Chen, H. L. 2012. *Tenebrio* small-scale ecological farming feasibility study. In *Advanced Materials Research, International Conference on Energy, Environment and Sustainable Development (ICEESD 2011)*. Stafa-Zurich, Switzerland : TRANS TECH PUBLICATIONS LTD. pp 267-270. ISBN:978-3-03785-267-5.
- Webster, J. 2016. Animal Welfare: Freedoms, Dominions and "A Life Worth Living". *Animals*, vol. 6, no. 35, p. 1-6. <https://doi.org/10.3390/ani6060035>
- Wu, S. X., Lin, M. T., Li, M. Y., Tang, X. K. 2009. Determination of some important technique parameters in the course of breeding *Tenebrio molitor*. *Journal of Economic Animal*, vol. 13, no. 1, p. 28-31.
- Xu, S. C., Gu, M. Z., Liu, X. W., Yang, L. L. 2012. Experimental Population Life Table of *Tenebrio molitor* at Different Temperatures. *Journal of Henan Agricultural Sciences*, vol. 3., p. 024.

Acknowledgments:

The article was supported by project no. FEKT-S-17-3934 Utilization of novel findings in micro and nanotechnologies for complex electronic circuits and sensor applications.

Contact address:

Anna Adámková, Czech University of Life Sciences Prague, Faculty of Agrobiolgy, Food and Natural Resources, Department of Quality of Agricultural Products, Kamýcká 129, 165 21 Prague 6 – Suchdol, Czech Republic, E-mail: adamkova@af.czu.cz

Martin Adámek, Brno University of Technology, Faculty of Electrical Engineering and Communication, Department of Microelectronics, Technická 3058/10, 616 00 Brno, Czech Republic, E-mail: adamek@feec.vutbr.cz

Jiří Mlček, Tomas Bata University in Zlin, Faculty of Technology, Department of Food Analysis and Chemistry, Vavreckova 275, 760 01 Zlin, Czech Republic, E-mail: mlcek@ft.utb.cz

Marie Borkovcová, Mendel University in Brno, Faculty of Agronomy, Department of Zoology, Fisheries, Hydrobiology and Agriculture, Zemědělská 1, 613 00 Brno, Czech Republic, E-mail: marie.borkovcova@mendelu.cz

Martina Bednářová, Mendel University in Brno, Department of Information Technology, Zemědělská 1, 613 00 Brno, Czech Republic, E-mail: bednarova@mendelu.cz

Lenka Kouřimská, Czech University of Life Sciences Prague, Faculty of Agrobiolgy, Food and Natural Resources, Department of Quality of Agricultural Products, Department of Microbiology, Nutrition and Dietetics, Kamýcká 129, 165 21 Prague 6 – Suchdol, Czech Republic, E-mail: kourimska@af.czu.cz

Josef Skácel, Brno University of Technology, Faculty of Electrical Engineering and Communication, Department of Microelectronics, Technická 3058/10, 616 00 Brno, Czech Republic, E-mail: xskace09@stud.feec.vutbr.cz

Eva Vítová, Brno University of Technology, Faculty of Chemistry, MRC-laboratory of biotechnology and biomaterials research, Purkyňova 118, 612 00 Brno, Czech Republic, E-mail: vitova@fch.vut.cz



EFFECT OF FEEDING OF PREFERMENTED BIOPRODUCT CONTAINING GAMMA-LINOLENIC ACID AND BETA-CAROTENE ON SELECTED PARAMETERS OF BROILER CHICKEN MEAT QUALITY

Ján Mačanga, Peter Popelka, Beáta Koréneková, Iveta Maskal'ová, Tatiana Klemková, Adriána Fečkaninová, Martin Mellen, Dana Marcincáková, Milan Čertík, Slavomír Marcincák

ABSTRACT

The aim of the work was to evaluate the effect of addition of prefermented bioproduct with a increased content of polyunsaturated fatty acids (especially gamma-linolenic acid) and beta-carotene into commercial feed on the selected qualitative parameters. The chemical composition, the color, the loss of water, the pH and the concentration of lactic acid of the meat of broiler chickens (COBB 500) were monitored. Bioproduct was prepared from corn scrap, which was fermented using the lower filamentous fungus *Umbelopsis isabellina* CCF2412. The prepared material was mixed into the commercial compound feed intended for broiler chickens at a ratio of 10%, and was fed from the 11th day of age of the chickens until the time of slaughter. The obtained results were compared with the results of control group, which was represented by broiler chickens fed only with a commercial compound feed. Feeding of bioproduct, in terms of chemical composition, affected mainly the fat content in breast and thigh meat, which was lower in the experimental group. Meat color (measured by colorimetric assay) was not affected and differences were significant only at a value a^* , which was higher in the experimental group. Statistically significant differences in the water losses of meat were not recorded, but the feeding of bioproduct affected the pH of the meat, and also the concentration of lactic acid and both parameters were higher in the meat of control group.

Keywords: bioproduct; gamma-linolenic acid; beta-carotene; broiler chicken; meat quality

INTRODUCTION

A current world trend in human nutrition is the increased demand for human diets containing health beneficial essential polyunsaturated fatty acids (PUFAs) that are not produced by the body and must be obtained through animal feeding. The enrichment of broiler chicken meat with PUFAs is a means of increasing PUFAs consumption in European diets because population intake of broiler chicken meat is high (Rymer et al., 2010). The fatty acid composition of broiler chicken meat can be significantly influenced by feeding (Zelenka et al., 2008), for example by adding a suitable source of PUFAs in the feed (Zuidhof et al., 2009).

Since, PUFAs are one of the main focuses of nutritional-lipid industry; several strategies for their biotechnological production have been developed. One of the promising alternatives of PUFAs production is based on the cultivations of filamentous fungi (order *Mucorales* and *Mortierellales*) in process of solid state fermentation (SSF). The attractiveness of these cultivations is the use of readily available substrates based on waste products from agricultural and industrial production, such as rice bran,

wheat bran, oat flakes, and malted draff, peeled or pearled barley (Čertík and Adamechová, 2009). Application of filamentous fungi in SSF process using agricultural waste product and by-products leads to formation of bioproducts enriched with PUFAs and other biologically active compounds, which can be directly used as feed supplements (Bellou et al., 2016) to modify the fatty acids profile in poultry (Bača et al., 2014).

However, meat with higher levels of PUFAs has a negative impact on sensory properties and lower nutritional value due to rapid oxidation of the fat. Appropriate system of combination of PUFAs and antioxidants can prevent such losses in meat quality. One possibility is the production of bioproduct using less filamentous fungal strain *Umbelopsis isabellina* CCF2412. Thus prepared organic product is characterized by increased amounts of PUFAs, and in addition also contains beta-carotene, which acts as an antioxidant (Klemková et al., 2013).

There are an insufficient amount of studies dealing with feeding the prefermented bioproduct to broilers and with its effect on meat quality. Therefore, the aim of this study

was to assess effect of feeding of 10% of prefermented bioproduct enriched with γ -linolenic acid (GLA) and contained beta-carotene on the quality indicators of produced meat.

MATERIAL AND METHODOLOGY

The experiment was carried out in accordance with the "European Directive on the the protection of animals used for scientific purposes" (2010/63/EU) and with the consent of the State Veterinary and Food Administration of the Slovak Republic no. 3090/13-221 in the premises of Clinic for birds and exotic animals of The University of Veterinary Medicine and Pharmacy in Košice (Slovak Republic).

Animals, diets and management

A total of 80 broiler chickens of meat type hybrid COBB 500 were used in this study. One-day-old chicks were randomly divided into two groups of 40 birds (control and experimental group).

Chickens were reared on deep litter (wood shavings). Temperature and lightning regimes were in accordance with standards for the fattening of broiler chickens (COBB Broiler Management Guide, 2013). During the entire fattening period the broiler chickens had free access to water and feed. Fattening period lasted 39 days and the conventional feed mixtures (Tajba, a.s., Čaňa, Slovak republic), which are used in broiler farms, were fed in both groups. Chickens of the control group were fed only with conventional feed mixtures (Br1, Br2, Br3 and Br4).

Chickens of the experimental group were fed in the same regime and prefermented feed (bioproduct), enriched with GLA and beta-carotene, was administered from the 11th day of fattening. Bioproduct was mixed with the feed in amount of 10% (it means that 10% of conventional feed mixture was replaced by bioproduct).

Clinical health status was continuously monitored. After completion of the fattening period the animals were stunned and killed by cervical dislocation and bled. The carcasses were plucked and eviscerated. Thigh and breast muscles were removed from the carcasses, subsequently packaged in polyethylene bags and stored in a refrigerator at 4 °C until analysis.

Preparation of prefermented bioproduct

Prefermented bioproduct was prepared by the method of fungal solid-state fermentation according to Čertík et al. (2006). Fungal strain *Umbelopsis isabellina* CCF2412 and

corn scraps as a substrate were used for preparation of bioproduct. *Umbelopsis isabellina* CCF2412 was obtained from the Culture Collection of Fungi (CCF) (Department of Botany, Charles University, Prague, Czech Republic).

The resulting bioproduct contained in average 3.0 g.kg⁻¹ of GLA, and 3.2 mg.kg⁻¹ of beta-carotene. Chemical composition of bioproduct, final commercial diet (Br4) and final experimental diet (Br4 +10% bioproduct) is shown in Table 1.

Analysis of muscle

Chemical composition of muscle

Dry matter was determined by oven-drying at 105 °C (AOAC, 2005). Kjeltec Auto, type 1030 analyser (Tecator Co., Hoganas, Sweden) was used to determine the crude protein content. Lipids were isolated in ground samples with petroleum ether in Soxhlet apparatus (LTHS 500, Brnenská Druteva v.d., Czech Republic) and determined gravimetrically.

Color of muscle

The color measurements were carried out using a colorimeter (Chroma meter CR-410, Konica Minolta, Japan) for objective measure of CIE Lab values (L* relative lightness, a* relative redness and b* relative yellowness). Before each measurement, the apparatus was standardized against a white tile. The color values of the breast muscle were measured 24 hours after slaughter and after seven-day storage under chilling conditions (4 °C).

Drip and cook loss of water

For drip loss measurement, breast muscles were packaged in polyethylene bags immediately after deboning, then were weighed and stored in a refrigerator at 4 °C for 24 hours. After 24 hours, samples were weighed again and drip loss was calculated.

Breast and thigh muscles were packed into polyethylene bags and cooked in water bath until internal temperature reached 74 °C. The bags were removed from the water bath and then released liquid was poured off and weighed. Cooking loss was calculated as released liquid × 100/weight before cooking.

Determination of pH

Muscle samples (50 g) were homogenized for 10 min. Then 10 g were used for extraction by distilled water (100 mL) and filtrated. The water extract was used for analysis of pH values by a digital pH meter (inoLab pH720, WTW, Weilheim, Germany) with glass electrode.

Table 1 Chemical composition of bioproduct and final diet (Br4 – control group; Br4 +10% bioproduct – experimental group) used from the 29. day of experiment.

	Bioproduct	Final diet	
		Control group	Experimental group
Crude protein (g.kg ⁻¹)	102.70	195.90	175.80
Total fat (g.kg ⁻¹)	80.40	59.40	67.40
Crude fiber (g.kg ⁻¹)	59.80	46.80	48.10
NDF (g.kg ⁻¹)	249.10	136.60	148.50
ADF (g.kg ⁻¹)	85.90	63.20	65.50
ME (MJ.kg ⁻¹)	12.35	13.41	13.20

Note: NDF = neutral detergent fiber; ADF = acid detergent fiber; ME = metabolized energy.

Table 2 Chemical composition (%) of breast and thigh muscle of broiler chickens.

	Breast muscle		Thigh muscle	
	Control group	Experimental group	Control group	Experimental group
Dry matter	27.9 ±1.4	26.3 ±0.3	32.3 ±1.6*	28.3 ±1.3
Fat	3.5 ±1.0	2.6 ±0.9	12.0 ±2.7	8.3 ±1.4
Total protein	23.3 ±0.1*	22.9 ±0.2	19.9 ±0.7	19.8 ±0.2

Note: n = 10; values in lines (expressed individually for breast and thigh muscle) marked with * are significantly different (* = $p < 0.05$).

Determination of lactic acid

The determination of lactic acid was performed from the water extract that was used for the pH measurements. One ml of water extract was transferred into 10 mL volumetric flasks and filled with distilled water and immediately analyzed by electrophoretic analyser (Type EA102) with a conductive detector (Villa Labeco, Slovak Republic) according to Mačanga et al. (2011). The electrophoretic separation system consisted of a leading electrolyte: 10 mM HCl, β-alanine and 0.1% methylhydroxyethylcellulose (pH 3.2) and terminating electrolyte: 5 mM caproic acid and 5 mM hydroxymethylaminomethane. The direct currents used in pre-separation and analytical columns were 250 μA and 50μA. The results of analysis were evaluated by the computer programme ITPP pro 32 and expressed in g.100 g⁻¹ of muscle.

Statistical evaluation

All the data were analyzed statistically using GraphPad Prism Software, Version 4.00 (Graphpad Prism, 2003). In evaluating the results, Student's t test was used because only two groups (control and experimental) were compared. Statistical significant differences are illustrated in the tables by star marks (* means $p < 0.05$).

RESULTS AND DISCUSSION

Addition of bioproduct produced by solid-state fermentation into commercial broiler feed influenced the chemical composition of the conventional feed mixtures (Table 1) with an impact on the chemical composition of broiler chicken meat (Table 2). Breast and thigh muscles of broiler chickens from the experimental group consisted of slightly lower content of proteins compared to control group. It could be caused by the fact that the diet of the chickens from the experimental group had lower amount of crude protein. On the other hand, experimental diet had higher percentage of fat, but the amount of fat in the muscles of chickens from the experimental group was lower compared to control group. Differences were also recorded in amount of dry matter. Higher values of the dry matter were measured in the muscles of the control group.

Statistically more significant differences were found in the thigh muscle ($p < 0.05$).

Similar results of the breast and thigh muscle chemical composition (except percentage of fat) of broiler chickens COBB 500 were described by Haščík et al. (2011). Percentages of fat (breast muscle: 1.28 ±0.26; thigh muscle: 9.40 ±1.23) recorded by these authors are lower than our results.

Based on these results, it has been expected that addition of solid-state prefermented bioproduct into commercial feed mixture had impact not only on chemical composition, mainly amount of fat, but also influence its deposit in organism. However, the higher content of fat was in the feed used in the experimental group, the muscles of this group contained lower percentage of fat, what can be explained by higher deposit of abdominal fat in these chickens. The correctness of this hypothesis could be also confirmed by our results published in the work Mačanga et al. (2016), where is stated, that broiler chickens fed with the bioproduct had on average 37.9 g of abdominal fat compared to chickens of the control group with 29.7 g of abdominal fat.

There are very little information about the effect of feeding product produced by solid-state fermentation on final quality of broiler meat. Comparison of the obtained results with other studies is not possible. However, modification of feedstuff can influence produced broiler meat (Aziza et al., 2010; Krejčí-Treu et al., 2010; Haščík et al. 2012; Bača et al., 2014; Ahmed et al., 2015; Vilarrasa et al., 2015; Elkin et al., 2016). The chemical composition of the produced meat, especially fat component was affected by these modifications.

The color of the meat is another parameter that may be influenced by feed. According to results of Šťastník et al. (2017) the color of broiler breast muscle was changed after feeding the feed mixtures contained wheats with different grain colour.

Results of our color measurement of breast muscle, expressed in CIE Lab values are presented in Table 3. Addition of prefermented bioproduct into the commercial feed mixtures did not affect L* values of breast meat. L* values measured 24 hours after slaughter were almost the

Table 3 The effect of bioproduct on the L*, a* and b* values of broiler breast muscles.

	1 st day		7 th day	
	Control group	Experimental group	Control group	Experimental group
L*	59.5 ±1.6	59.6 ±2.3	58.6 ±2.0	55.1 ±4.6
a*	11.9 ±1.3	13.5 ±0.6*	10.5 ±1.4	11.5 ±2.4
b*	13.7 ±2.1	11.5 ±1.5	16.1 ±2.4	14.2 ±2.3

Note: n = 10; values in lines (expressed individually for 1st and 7th day) marked with * are significantly different (* = $p < 0.05$).

Table 4 The effect of bioproduct on the drip and cook loss of water (%).

	Drip loss		Cook loss	
	Control group	Experimental group	Control group	Experimental group
Breast muscle	0.5 ±0.1	0.6 ±0.4	33.8 ±9.8	22.4 ±2.5
Thigh muscle	-	-	21.5 ±2.5	22.9 ±0.8

Note: n = 10

Table 5 Values of pH and lactic acid concentration (g.100g⁻¹) of breast and thigh muscles.

	Day of the analysis	Breast muscle		Thigh muscle	
		Control group	Experimental group	Control group	Experimental group
pH	1 st day	5.93 ±0.02*	5.83 ±0.02	6.28 ±0.03*	5.97 ±0.03
	7 th day	5.96 ±0.03*	5.88 ±0.01	6.31 ±0.01*	6.11 ±0.02
Lactic acid	1 st day	1.770 ±0.104	1.332 ±0.285	1.468 ±0.256	1.195 ±0.176
	7 th day	1.437 ±0.212	1.535 ±0.207	1.288 ±0.219	1.279 ±0.407

Note: n = 10; values in lines (expressed individually for breast and thigh muscle) marked with * are significantly different (* = $p < 0.05$).

same in the both groups. On the other hand, differences were recorded in a* and b* values. Value a* was significantly higher ($p < 0.05$) in the breast muscle of experimental group and value b* was lower in this group. After 7-day storage in the refrigerator, L*, a* and b* values of the breast muscles packed in the polyethylene bags were changed. In the both groups, L* and a* values slightly decreased and in b* values increasing was recorded. Differences between control and experimental group were almost the same as those found 24 hours after slaughter.

Color of the muscle of broiler chickens is influenced by a lot of factors, such as age, diet, time of storage and so on (Karaoglu et al., 2006). Authors described that L* value correlates also with pH value of muscle. It means that as pH increases, the L* value decreases. The same correlation was obtained in our work. Differences between control and experimental group in a* and b* values could be caused also by the presence of beta-carotene in the experimental diet.

Drip loss and cook loss of water from muscles were not negatively affected by the bioproduct (Table 4). Drip loss from breast muscles of both groups were almost the equal. After the cooking, loss of water from thigh muscles of control and experimental group were comparable. Cook loss from breast muscles were slightly different, but without statistical significance. Anyway, breast muscles of the control group lost more water after cooking than breast of the experimental group.

By comparing the values of pH (Table 5) in the samples of breast and thigh muscles of both groups, statistically significant differences were found ($p < 0.05$). Muscles of the control group had higher pH values 24 hours after slaughter and also after seven-day storage in refrigerator.

Differences were recorded also in the concentrations of lactic acid (Table 5). During first 24 hours after slaughter, higher concentration of lactic acid was measured in the samples of muscles of the control group ($p > 0.05$). During the seven-day storage, the dynamics of lactic acid in the muscles of control and experimental group were different. In the muscles of the control group, decreasing of lactic acid concentration was recorded, while in the muscles of

experimental group, lactic acid concentration was increased.

One of the most critical factors affecting the quality of the meat after slaughter is the process of its maturation. The muscles fibres are subjected to biochemical changes called the ripening process, which is an energy-demanding process. The energy is provided by the enzymatic degradation of muscle glycogen to the lactic acid, following decrease of pH in the muscle (Dalle Zotte, 2002; Čuboň et al., 2004). Higher values of lactic acid concentration measured after slaughter in the muscles of control group could mean more intensive breakdown of glycogen in the time before slaughter. But, on the other hand, pH values measured in these muscles were not so decreased, and were higher in comparison to experimental group. The pH of muscles is influenced mainly, but not only, by lactic acid concentration. All the metabolic processes in muscles after death are inter-linked and should be considered simultaneously.

Values of pH, L* and loss of water from muscles are correlated. Higher L* values of breast muscle may indicate the qualitative deviation like PSE (pale, soft, exudative) described in pork. Van Laack et al. (2000) described that pale breast muscle had L* value 60.0. Value of pH of this muscle was 5.7 and drip loss 1.34%. On the other hand, normal breast muscle had these values: L* 55.1; pH 5.96 and drip loss 0.87%. Similar values for pale breast muscle are described by Woelfel et al. (2002), when L* was 60.4; pH 5.76; drip loss 4.38% and cook loss 26.39%. On the other hand, Qiao et al. (2002) described that L* value of normal breast muscles was 62.07 and pH 5.96. Breast muscle marked as lighter-than-normal had L* value 64.34 and pH value 5.82.

L* values obtained in our work could suggest that muscles had qualitative deviation, but on the base of pH values and results of water losses, it is not so.

CONCLUSION

Based on the obtained results, we can conclude that replacing of 10% of the commercial feed by prefermented bioproduct, which is produced from waste of agricultural

production, did not adversely affect the monitored qualitative parameters of broiler chicken meat.

REFERENCES

- Ahmed, S. T., Islam, Md. M., Bostami, A. B. M. R., Mun, H. S., Kim, Y. J., Yang, Ch. J. 2015. Meat composition, fatty acid profile and oxidative stability of meat from broilers supplemented with pomegranate (*Punica granatum* L.) by-products. *Food Chemistry*, vol. 188, p. 481-488. <https://doi.org/10.1016/j.foodchem.2015.04.140> PMID:26041221
- AOAC International. 2005. *Official methods of analysis of the Association of Analytical Chemists International, 18th ed.* AOAC International, Gaithersburg, MD.
- Aziza, A. E., Quezad, N., Cherian, G. 2010. Feeding Camelina sativa meal to meat type chickens: Effect on production performance and tissue fatty acid composition. *Journal of Applied Poultry Research*, vol 19, no. 2, p. 157-168. <https://doi.org/10.3382/japr.2009-00100>
- Bača, M., Marcinčák, S., Čertík, M., Popelka, P., Marcinčáková, D., Guothová, L., Molnár, L., Klemková, T., Maskaľová, I. 2014. Effect of adding prefermented cereal product containing gamma-linolenic acid to broiler feed on production indicators and fatty acid profile of chicken breast. *Acta Veterinaria Brno*, vol. 83, p. 379-384. <https://doi.org/10.2754/avb201483040379>
- Bellou, S., Triantaphyllidou, I. E., Aggeli, D., Elazzazy, A. M., Baeshen, M. N., Aggelis, G. 2016. Microbial oils as food additives: recent approaches for improving microbial oil production and its polyunsaturated fatty acid content. *Current Opinion in Biotechnology*, vol. 37, p. 24-35. <https://doi.org/10.1016/j.copbio.2015.09.005> PMID:26431717
- Čertík, M., Adamechová, Z. 2009. Cereal-based bioproducts containing polyunsaturated fatty acids. *Lipid Technology*, vol. 21, no. 11-12, p. 250-253. <https://doi.org/10.1002/lite.200900058>
- Čertík, M., Sláviková, L., Masrnová, S., Šajbidor, J. 2006. Enhancement of Nutritional Value of Cereals with γ -Linolenic Acid by Fungal Solid-State Fermentations. *Food Technology & Biotechnology*, vol. 44, no. 1, p. 75-82.
- COBB Broiler Management Guide. 2013. [online] s.a. [cit. 2017-03-09] Available at: <http://cobb-vantress.com>.
- Čuboň, J., Haščík, P., Mojto, J., Kačániová, M., Vagač, V., Košťalová, D., Pavličová, S. 2004. Effect of sodium lactate on microbiological, physical and sensory characteristics of beef. *Acta Fytotechnica et Zootechnica*, vol. 3, p. 62-66.
- Dalle Zotte, A. 2002. Perception of rabbitmeat quality and major factors influencing the rabbit carcass and meat quality. *Livestock Production Science*, vol. 75, no. 1, p. 11-32. [https://doi.org/10.1016/S0301-6226\(01\)00308-6](https://doi.org/10.1016/S0301-6226(01)00308-6)
- Directive 2010/63/EU of The European Parliament and of The Council of 22 September 2010 on the protection of animals used for scientific purposes. *Official Journal of the European Union L276*, p. 33-79.
- Elkin, R. G., Ying, Y., Fan, Y., Harvatine, K. J. 2016. Influence of feeding stearidonic acid (18:4n-3)-enriched soybean oil, as compared to conventional soybean oil, on tissue deposition of very long-chain omega-3 fatty acids in meat-type chickens. *Animal Feed Science and Technology*, vol. 217, p. 1-12. <https://doi.org/10.1016/j.anifeedsci.2016.04.019>
- Haščík, P., Elimam, I. O. E., Garlík, J., Kačániová, M., Bobko, M., Kňazovická, V., Vavrišinová, K., Arpášová, H., Bučko, O. 2012. Chemical composition of muscle after pollen application in nutrition of broiler chickens. *Potravinárstvo*, vol. 6, no. 2, p. 26-32. <https://doi.org/10.5219/190>
- Haščík, P., Kačániová, M., Bobko, M., Pochop, J., Mihok, M., Arpášová, H. 2011. Effect of probiotic preparation for chemical composition of meat cocks different combinations of hybrid chicks. *Acta Universitatis Agriculturae et Silviculturae Mendelianae Brunensis*, 2011, vol. 59, no. 5, p. 83-94. <https://doi.org/10.11118/actaun201159050083>
- Karaoğlu, M., Aksu, M. İ., Esenbuga, N., Macit, M., Durdağ, H. 2006. pH and colour characteristics of carcasses of broilers fed with dietary probiotics and slaughtered at different ages. *Asian Australasian Journal of Animal Sciences*, vol. 19, no. 4, p. 605-610. <https://doi.org/10.5713/ajas.2006.605>
- Klemková, T., Basil, E., Kubatová, A., Čertík, M. 2013. Biosynthesis of gamma-linolenic acid and beta-carotene by Zygomycetes fungi. *Biotechnology Journal*, vol. 8, no. 7, p. 794-800. <https://doi.org/10.1002/biot.201200099> PMID:23625863
- Krejčí-Treu, T., Straková, E., Suchý, P., Herzig, I. 2010. Effect of Vegetable Oil Fortified Feeds on the Content of Fatty Acids in Breast and Thigh Muscles in Broiler Chickens. *Acta Veterinaria Brno*, vol. 79, p. 21-28. <https://doi.org/10.2754/avb201079S9S021>
- Mačanga, J., Čertík, M., Jevinová, P., Marcinčáková, D., Reitznerová, A., Kovalík, P., Marcinčák, S. 2016. Effect of substitution of commercial feed by bio feed on the quality of broiler chickens meat (Účinnok substitúcie komerčného krmiva biokrmivom na kvalitu mäsa brojlerových kurčiat). In *Lazarove dni výživy a veterinárnej dietiky XII*. Košice : UVLF, pp. 219-222. ISBN 978-80-8077-497-4.
- Mačanga, J., Koréneková, B., Nagy, J., Marcinčák, S., Popelka, P., Kožárová, I., Korének, M. 2011. Post-mortem changes in the concentration of lactic acid, phosphates and pH in the muscles of wild rabbits (*Oryctolagus cuniculus*) according to the perimortal situation. *Meat Science*, vol. 88, no. 4, p. 701-704. <https://doi.org/10.1016/j.meatsci.2011.02.032> PMID:21454023
- Qiao, M., Fletcher, D. L., Northcutt, J. K., Smith, D. P. 2002. The Relationship Between Raw Broiler Breast Meat Color and Composition. *Poultry Science*, vol. 81, no. 3, p. 422-427. <https://doi.org/10.1093/ps/81.3.422> PMID:11902421
- Rymer, C., Gibbs, R. A., Givens, D. I. 2010. Comparison of algal and fish sources on the oxidative stability of poultry meat and its enrichment with omega-3 polyunsaturated fatty acids. *Poultry Science*, vol. 89, no. 1, p. 150-159. <https://doi.org/10.3382/ps.2009-00232> PMID:20008813
- Šťastník, O., Karásek, F., Jůzl, M., Mrkvicová, E., Pavlata, L., Nedomová, Š., Trojan, V., Vyhnaněk, T., Doležal, P., Martinek, P. 2017. The effect of feeding wheat varieties with different grain pigmentation on growth performance, texture, colour and meat sensory traits of broiler chickens. *Potravinárstvo*, vol. 11, no. 1, p. 145-150. <https://doi.org/10.5219/753>
- Van Laack, R. L. J. M., Liu, C. H., Smith, M. O., Loveday, H. D. 2000. Characteristics of Pale, Soft, Exudative Broiler Breast Meat. *Poultry Science*, vol. 79, no. 7, p. 1057-1061. <https://doi.org/10.1093/ps/79.7.1057> PMID:10901210
- Vilarrasa, E., Guardiola, F., Codony, R., Esteve-Garcia, E., Barroeta, A. C. 2015. Use of combinations of re-esterified oils, differing in their degree of saturation, in broiler chicken diets. *Poultry Science*, vol. 94, no. 7, p. 1539-1548.

<https://doi.org/10.3382/ps/pev140>

[PMid:26015593](https://pubmed.ncbi.nlm.nih.gov/26015593/)

Woelfel, R. L., Owens, C. M., Hirschler, E. M., Martinez-Dawson, R., Sams, A. R. 2002. The Characterization and Incidence of Pale, Soft, and Exudative Broiler Meatin a Commercial Processing Plant. *Poultry Science*, vol. 81, no. 4, p. 579-584. <https://doi.org/10.1093/ps/81.4.579>

[PMid:11989759](https://pubmed.ncbi.nlm.nih.gov/11989759/)

Zelenka, J., Jarošová, A., Schneiderová, D. 2008. Influence of n-3 and n-6 polyunsaturated fatty acids on sensory characteristics of chicken meat. *Czech Journal of Animal Science*, vol. 53, no. 7, p. 299-305.

Zuidhof, M. J., Betti, M., Korver, D. R., Hernandez, F. I., Schneider, B. L., Carney, V. L., Renema R. A. 2009. Omega-3-enriched broiler meat: 1. Optimization of a production system. *Poultry Science*, vol. 88, no. 5, p. 1108-1120. [PMid:19359702](https://pubmed.ncbi.nlm.nih.gov/19359702/)

Acknowledgments:

This work was supported by the Slovak Research and Development Agency under the contract No. APVV-14-0397 and by grant VEGA 1/0574/15 from Ministry of Education.

Contact address:

Ján Mačanga, University of Veterinary Medicine and Pharmacy in Košice, Department of Food Hygiene and Technology, Komenského 73, 041 81 Košice, Slovakia, E-mail: jan.macanga@uvlf.sk

Peter Popelka, University of Veterinary Medicine and Pharmacy in Košice, Department of Food Hygiene and Technology, Komenského 73, 041 81 Košice, Slovakia, E-mail: peter.popelka@uvlf.sk

Beáta Koréneková, University of Veterinary Medicine and Pharmacy in Košice, Department of Food Hygiene and

Technology, Komenského 73, 041 81 Košice, Slovakia, E-mail: beata.korenekova@uvlf.sk

Iveta Maskaľová, University of Veterinary Medicine and Pharmacy in Košice, Institute of nutrition, dietetics and feed production, Komenského 73, 041 81 Košice, Slovakia, E-mail: iveta.maskalova@uvlf.sk

Tatiana Klemková, Slovak University of Technology, Institute of Biotechnology, Faculty of Chemical and Food Technology, Radlinského 9, 812 37 Bratislava, Slovakia, E-mail: tatiana.klempova@stuba.sk

Adriána Fečkaninová, University of Veterinary Medicine and Pharmacy in Košice, Department of Food Hygiene and Technology, Komenského 73, 041 81 Košice, Slovakia, E-mail: adriana.feckaninova@gmail.com

Martin Mellen, Slovak University of Agriculture in Nitra, Department of Food Hygiene and Safety, Faculty of Biotechnology and Food Sciences, Trieda Andreja Hlinku 609/2, 949 76 Nitra-Chrenová, Slovakia, E-mail: martin.mellen@gmail.com

Dana Marcincáková, University of Veterinary Medicine and Pharmacy in Košice, Department of Pharmacology and Toxicology, Komenského 73, 041 81 Košice, Slovakia, E-mail: marcincakova@uvlf.sk

Milan Čertík, Slovak University of Technology, Institute of Biotechnology, Faculty of Chemical and Food Technology, Radlinského 9, 812 37 Bratislava, Slovakia, E-mail: milan.certik@stuba.sk

Slavomír Marcincák, University of Veterinary Medicine and Pharmacy in Košice, Department of Food Hygiene and Technology, Komenského 73, 041 81 Košice, Slovakia, E-mail: slavomir.marcincak@uvlf.sk



COMPARATIVE STUDY OF HONEY CONSUMPTION IN SLOVAKIA AND RUSSIA

Snezhanna Guziy, Peter Šedík, Elena Horská

ABSTRACT

The current situation on the food market is influenced by various diet trends including eating healthy products. The honey consumption has an increasing tendency because more and more consumers consider honey as a healthy alternative to a refined sugar. The aim of this research paper was to identify consumption patterns regarding honey in terms of annual consumption, its frequency, volume of honey per purchase, consumption structure by family members and factors affecting consumers at honey purchase. The primary data was obtained from a questionnaire survey, which was conducted in Slovakia on the sample of 316 respondents as well as in Russia on the sample of 309 respondents. For a deeper analyses several assumptions were formulated where dependencies between demographic factors (age, education and income,) and annual consumption by using Chi-Square Test of Independence and Cramer'V coefficient, as well as, differences in factors affecting consumers at honey purchase by using Friedman test have been statistically tested. Based on the results it was found out that, the majority of Slovak consumers make honey reserves and prefer to buy 1 kg per purchase while the majority of Russian consumers purchase honey if necessary and prefer to buy 0.5 or 2 – 5 kg per purchase. Honey is generally consumed by all family members in both countries. The most important factors for Slovak consumers was the country of origin (2.59) followed by taste (3.51), type (3.97) and price (4.18), while the least important factors were the size of packaging (6.70) and the design of packaging (6.80). For Russian consumers the most important factors were the type (2.97), design of packaging (3.13), price (3.28) and taste (3.61) while the least important factors were the size of packaging (6.98), brand (6.50) and the country of origin (6.50). The majority of consumers in both countries consume from 2 to 5 kg annually and the only significant dependence was confirmed in case of respondents' age. The annual consumption of young generation is lower in comparison to older generations.

Keywords: honey; consumption; purchase; Slovakia; Russia

INTRODUCTION

Honey is the most popular and important bee product. In general, honey is defined as a sweet substance from nectar or honeydew, which honeybees collect, transform with their enzymes and store in honeycomb (Veselý et al., 2013). Furthermore, honey has been considered as one of the most energetic and sweetest food in the nature. The first tangible evidence of its gathering is dated to 25 000 years ago (Crittenden, 2011).

According to Marghitas et al. (2010) honey can be classified as a complex food regarding to standards for nutrients, as natural and healthy product. It contains simple sugars, flavonoids, organics and amino acids, vitamins and minerals. In terms of simple sugars, honey contains several sugars: monosaccharides (fructose – glucose) and disaccharides (saccharose). The structure depends on region and botanical sources (Matsuda and Sabato, 2004). Another source claims that honey is considered as an antioxidant-rich natural product, which contains

flavonoids, ascorbic acid or phenolic components. The particular antioxidant effectiveness depends on type of honey, however we can state that darker honey is more effective (Johnston et al., 2005).

According to Gannabathula et al. (2017) honey has been used as traditional remedy for pressure sores, wounds and burns due to its healing effects. Due to the low water content, honey has high antimicrobial properties, which disable growth of microorganisms in it (Rall et al., 2003). Moreover, when it is consumed in rational amount it can optimise glycogen production in liver. Consuming honey during training, working and before going to bed contributes to better sleep (Fessenden and McInnes, 2008).

Based on the results of a Romanian research, the main motivation for consuming honey is eating healthy. This global trend causes an increase in honey consumption. Firstly, honey was perceived as local product and medicine and nowadays consumers' motivation is connected with

seeking safe and healthy products (Pocoland Ilea, 2011). According to another research, factors such medical condition, price and high quality affect consumer purchasing behaviour. The essential factors are appropriate pricing, high quality and health benefits (Yeow, et al., 2013). Trends in eating healthy food cause an increase in honey consumption, however consumers still suffer from the lack of information about the qualitative properties of honey (Cosmina et al., 2016).

Consumption habits are closely associated with consumer behaviour on food market where various factors influence consumers on a daily basis. Consumers' decision-making on the food market is influenced by food trends, eating habits or consumption patterns (Nagyová, 2012). Consumer decisions can be influenced by several factors such as brand, origin, awards and type. Furthermore, consumer perceptions towards food products have changed. They started to take into consideration not only product price but also better food quality. (Kapsdorferová, 2010; Kozelová et al., 2014; Mokřý et al., 2016). Consumers can differ from each other. For example, consumers living in countryside can be characterised by high level of own food supply regarding both plant-based and animal products while consumers living in urban areas rely on supermarkets (Nagyová, 2005). In addition, it is very important to understand that by modifying consumers' attitudes towards food consumption of certain products we can decrease diseases connected with unhealthy diet. (Kubicová, 2008) as well as support sustainable consumption which is defined as an effective way of consuming products including environmental and ethical aspects (Gálová, Berčík and Vilhanová, 2012).

The aim of this research paper is to identify consumption patterns regarding honey, as well as, examine selected factors affecting consumption and consumer purchasing behaviour in Slovakia and Russia.

MATERIAL AND METHODOLOGY

For the purpose of our research, we conducted a questionnaire survey in two countries - Slovakia and Russia in order to compare the obtained data. Russia was chosen mainly due to the rich history and traditions in apicultural sector as well as because of the fact that one of the authors has studied there.

In terms of the survey in Slovakia, we realized it online via survio.com using social media and emails. Within a time period of January – February 2016 we obtained a sample of 316 respondents. According to the structure of respondents 31.96 % were men and 68.04% were women. By age they were divided into three categories: 18 – 25 years (28.48%), 26 – 35 years (32.59%) and 36 – 45 years (38.93%). By education the sample consists of secondary (11.71%), vocational (25.95%), unfinished higher (15.51%) and higher education (46.83%). In case of income they were divided into four categories: 0 – 300 € (19.3%), 301 – 500 € (25%), 501 – 1,000 € (43.99%) and more than 1,000 € (11.71%).

In terms of the survey in Russia, we realized it at Russian agricultural exhibition "Golden Autumn" in Moscow within two days of October 9 – 10, 2015. We also used an online questionnaire via survio.com using social media. We obtained a sample of 309 respondents. According to

the structure of respondents 40.45% were men and 59.55% were women. By age they were divided into three categories: 18 – 25 years (34.63%), 26 – 35 years (30.10%) and 36 – 45 years (35.27%). By education the sample consists of secondary (5.83%), vocational (9.39%), unfinished higher (10.68%) and higher education (74.10%). In case of income they were divided into four categories: 0 – 15,000 RUB (24.6%), 15,001 – 25,000 RUB (16.83%), 25,001 – 50,000 RUB (36.25%) and more than 50 000 RUB (22.32%).

We used the exchange rate 1 € = 68.5882 RUB, actual on 23.10.2015 according to National Bank of Slovakia.

We formulated several assumptions, same for both investigated countries:

Assumption n.1 - we assume the differences among factors affecting respondents at honey purchase.

Assumption n.2 – we assume the dependence between honey consumption and consumers' age

Assumption n.3 – we assume the dependence between honey consumption and consumers' education

Assumption n.4 – we assume the dependence between honey consumption and consumers' income

Assumption n.5 – we assume the dependence between honey consumption and country.

Obtained data were analysed in the statistical program – SAS Enterprise Guide 5.1 and we applied these statistical methods:

- Chi-Square Test of Independence
- Friedman test
- Cramer'V coefficient

RESULTS AND DISCUSSION

In the first question, we focused on a consumption structure of honey in families and we can observe that in Slovakia as well as in Russia the majority of consumers answered that honey is consumed by all family members (Figure 1). Nevertheless, if we compare the percentage rate we can state that in category "whole family" honey is more consumed in Slovakia (87.34%) than in Russia (65.37%). According to the Figure 2, we can conclude that Slovak consumers mostly prefer to buy 1 kg (38.29%) per one purchase or make adequate honey reserves by buying 2 – 5 kg (25%), whereas Russian consumers prioritize either 0.5 kg (27.51%) or 2 – 5 kg (26.54%). The authors Ismaiel et al. (2014) obtained the same results of their market survey in Saudi Arabia and they stated that the most frequent package size of honey is 1 kg container. This size is common not only for locally produced honey but also for imported honey sold in the market.

Figure 3 shows the frequency of honey purchase and we can see that Slovak consumers prefer to make honey reserves (42.72%), while the majority of Russian consumers purchase honey if it is necessary (59.55%).

The next research connected with honey consumption was conducted by Ćirić et al. (2015) in the province of Vojvodina. The majority of consumers purchase honey once in three months (42%), once a month (29%) and once in six months (23%). Krystallis et al. (2007) Honey seems to be rather usual food component in Romanian diet, since more than one-third of respondents consume it at least

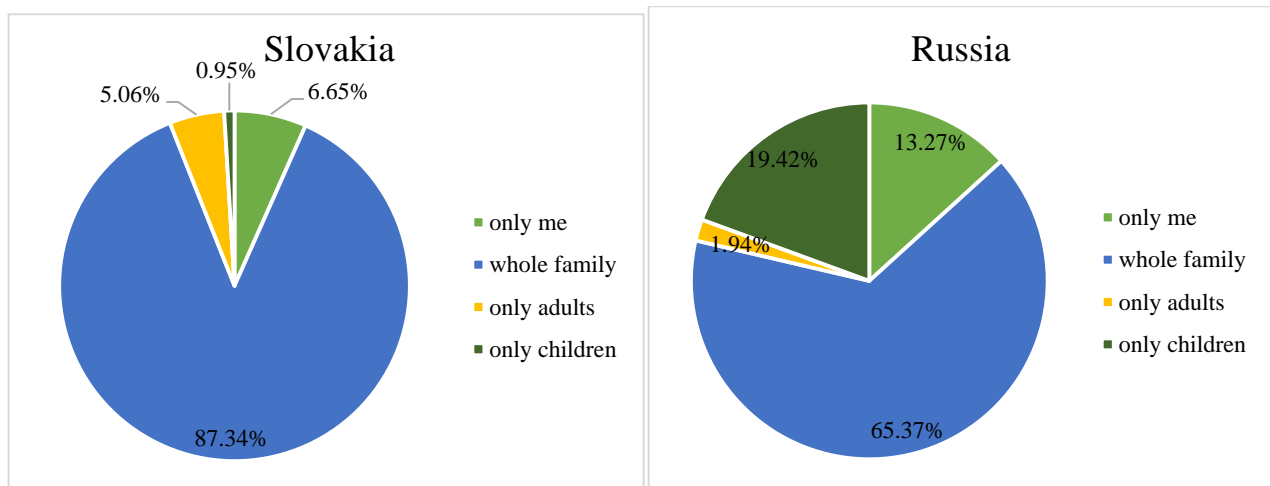

Figure 1 Honey consumption by family members.

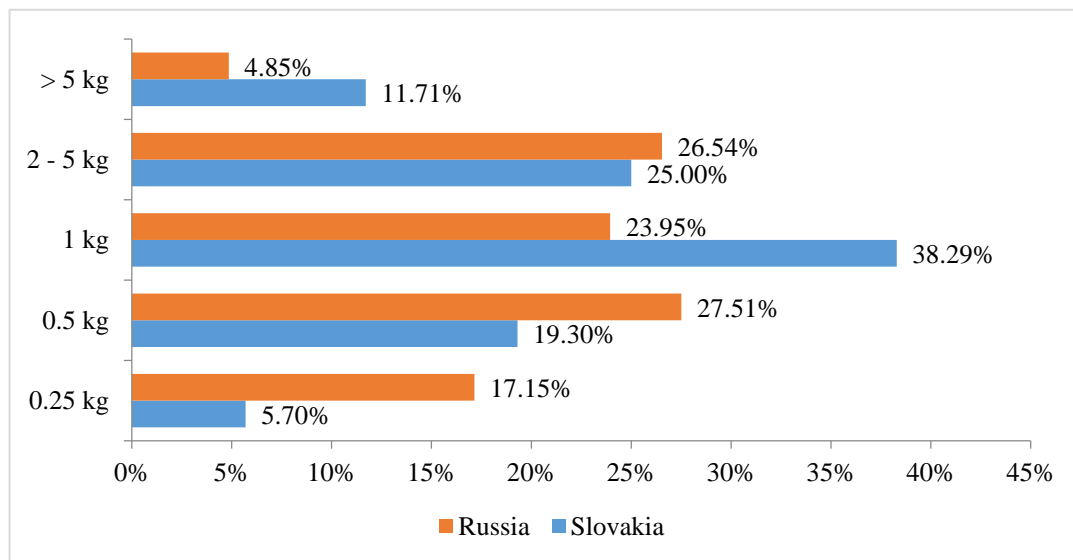

Figure 2 Volume of honey per one purchase.

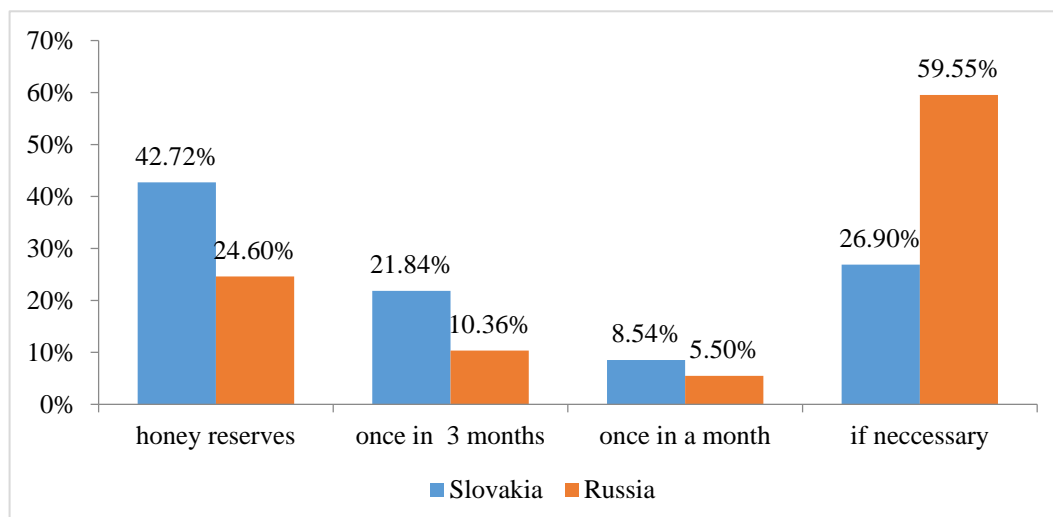

Figure 3 Frequency of honey purchase.

once per week, with an additional 42.7% consuming it at least once per month. However, more consumers claim their intake has fallen rather than increased.

Consumer behaviour involves several factors, which can influence consumers' purchasing decisions. In case of honey purchase, it can be factors such as price, country of

origin, brand, taste, design of packaging, size of packaging, place of selling, quality and type.

According to Table 1, where respondents had to make an order arrangement from 1 (the most important) to 9 (the least important), we can conclude that for Slovak consumers the most important factor was the country of

Table 1 Factors affecting respondents at honey purchase.

Factors	Average number of points	
	Slovakia	Russia
Price	4.18	3.28
Country of origin	2.59	6.50
Brand	5.55	6.50
Taste	3.51	3.61
Design of packaging	6.80	3.13
Size of packaging	6.70	6.98
Place of selling	6.28	5.68
Quality	5.50	6.35
Type	3.97	2.97

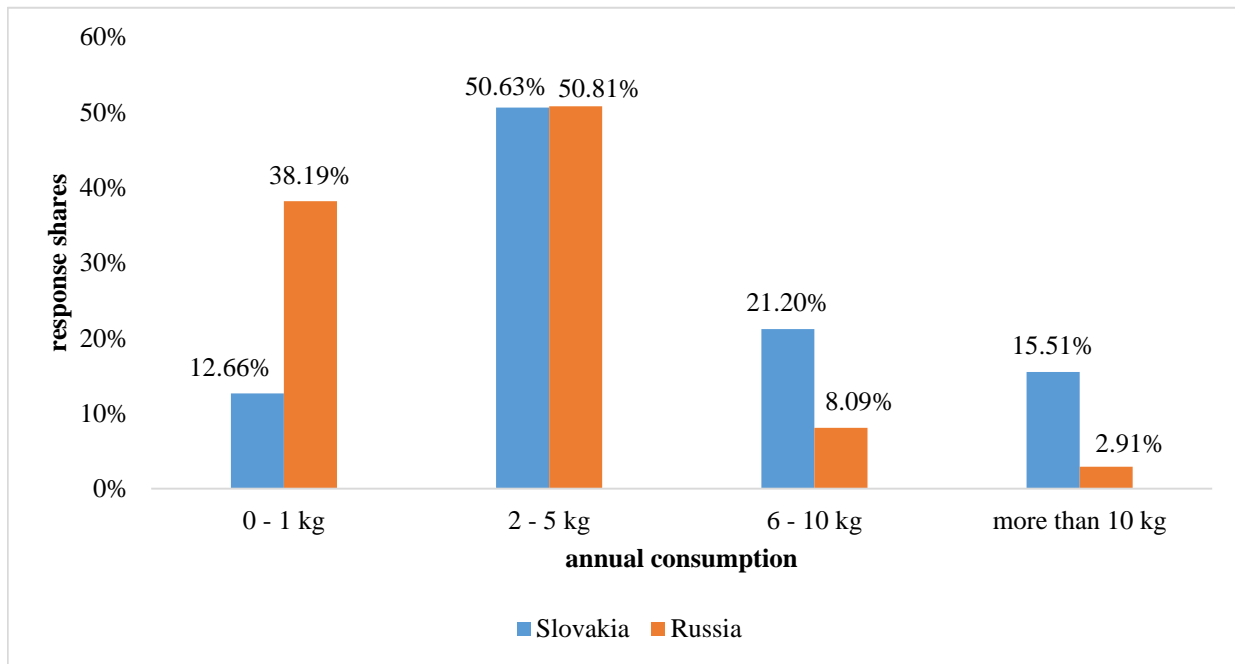

Figure 4 Annual consumption of honey in Slovakia and Russia.

origin (2.59) followed by taste (3.51), type (3.97) and price (4.18). Many consumers are aware of honey adulteration related to the imported honey of unknown origin. The least important factors were the size of packaging (6.70) and the design of packaging (6.80). Slovak honey consumers are not interested in special packaging, they simply prefer glass material and are used to buy 1 kg package. For Russian consumers the most important factor was type (2.97) followed by the design of packaging (3.13), price (3.28) and taste (3.61). The least important factors were the size of packaging (6.98), brand (6.50) and the country of origin (6.50). Consumers do not care about honey origin because the majority of honey sold in the market is produced by Russian beekeepers. If we compare preferences of Slovak and Russian honey consumers we can conclude that in both cases factors such as price, type and taste were the most influential and the least influential factor was the size of packaging.

In addition, we examined preferences of these factors by using Friedman test and formulated hypothesis:

H0: importance of factors for consumers are the same, there does not exist any preferences.

H1: there exists differences in preferences between at least one pair of factors.

In terms of Slovak consumers, we found out:

$$F = 764,2633 > \chi_{\text{tab}}^2 = 15,50731$$

Testing criteria F is higher than the critical value, therefore we reject null hypothesis and conclude that there exist different preferences in given factors.

In terms of Russian consumers, we found out:

$$F = 948,504 > \chi_{\text{tab}}^2 = 15,50731$$

Testing criteria F is higher than the table value χ^2 , therefore we reject null hypothesis and conclude that there exist different preferences in given factors.

A similar market survey was done in Ireland by **Murphy et al. (2000)** who found out that the most essential factor during a honey purchase was price (26%). The next factor was texture (25%) followed by packaging (19%), scale of production (17%) and the least essential factor was colour (13%). Price and texture together represented 50% of the importance of consumers and price was twice as essential as colour. Another consumer research was conducted by **Batt and Liu (2012)** in Western Australia on the sample of 645 respondents. The main factors affecting consumers' decisions during purchase of honey are: appropriate price (68%), taste (14%), quality (12%) and packaging

Table 2 Results of Chi-Square Test of Independence for Slovakia.

	p-value	correlation	Cramer's V coefficient
age	0.0034	yes	0.1579
education	0.3707	no	-
income	0.2684	no	-

Table 3 Results of Chi-Square Test of Independence for Russia.

	p-value	correlation	Cramer's V coefficient
age	0.0062	yes	0.1525
education	0.8435	no	-
income	0.1265	no	-

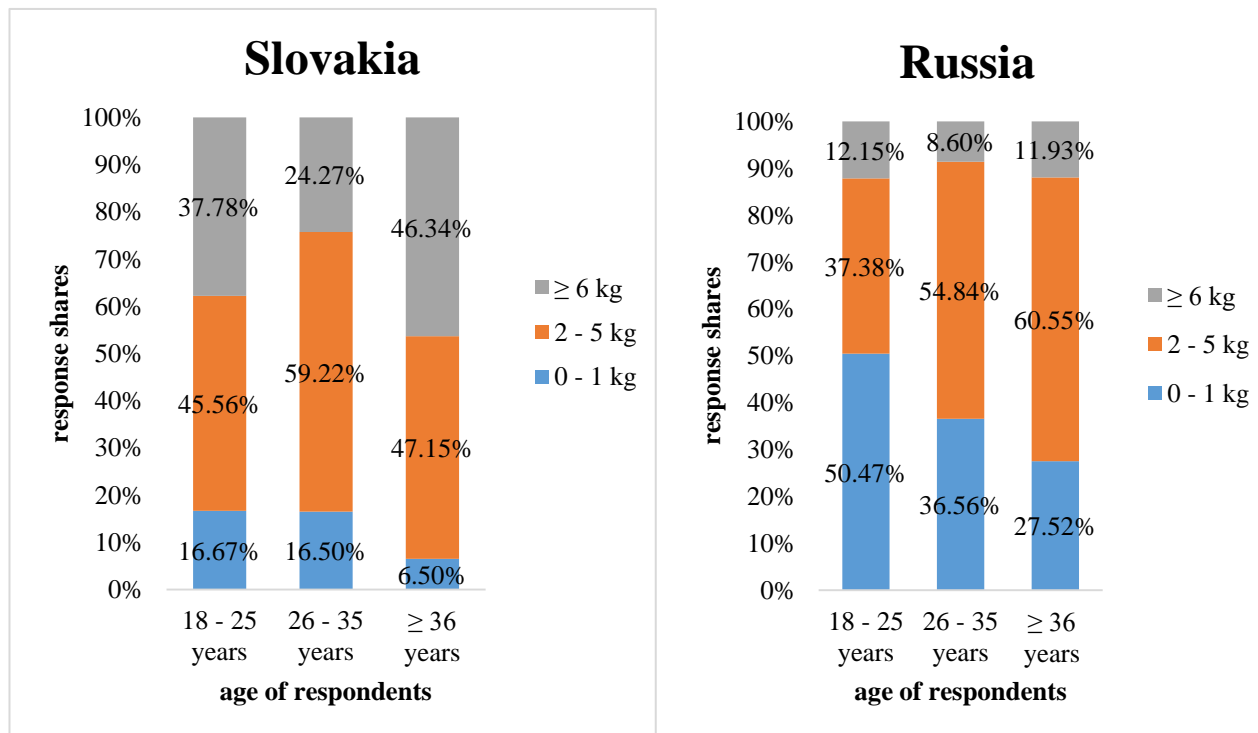

Figure 5 Influence of age on honey consumption per year in Slovakia and Russia.

(11%).The research, conducted in Romania and Ireland by **Pocol and Marghitas (2008)**, proved that texture of honey which can be considered as a sign of certain quality and depends on a honey type is essential for consumers. Another aspect was the country of origin where consumers preferred domestic honey rather than imported one mainly due to higher risk of adulteration and doubtful origin. According to the survey in Russia, the most important factors during the purchase of honey was price (41%), quality (32.5%) and type (14.3%) (**Роздольская et. al., 2015**). Nevertheless, the questionnaire survey done in the Democratic Republic of Congo showed that enormous impact on consumer preferences towards honey had price, colour and packaging (**Gyau et al., 2014**).

In addition, **Roman et al. (2013)** utter that packaging design of honey does not influence consumers, however the majority of them require cleanliness together with hygiene of the packaging.

Regarding annual consumption (Figure 4) it is obvious that in both countries around 50% of respondents consume 2 – 5 kg of honey per year. Slovak honey consumers tend to eat more kilograms: 6 – 10 kg (21.20%) and more than 10 kg (15.51%) while Russian consumers tend to eat less: 0 – 1 kg (38.19%). For statistical confirmation, we applied

Chi-Square Test of Independence and formulated hypothesis as follows:

H0: Assumes that there is no association between honey consumption and country

H1: Assumes that there is an association between honey consumption and country

We found out that

$$\chi^2 = 85,22713 > \chi_{tab}^2 = 7,814728$$

The test statistic is greater than critical value, therefore we reject null hypothesis (H0) and accept alternative hypothesis (H1). It means that there are associations between honey consumption and country, in other words, honey consumption differs between the countries.

A similar survey on annual honey consumption was conducted in Romania, where 25.8% of respondents consume maximum 500 g per year, 22% consume from 500 g to 1 kg per year and finally around 20% consume more than 2 kg per year. Moreover, consumers with higher education tend to consume more. In terms of honey

consumption structure within family, the results showed that the majority of respondents answered that all members of the family consume honey (Pocol and Marghitas, 2007). Another Romanian survey found out that consumers purchased approximately 3 kg/year on average. The honey consumption is higher in case of employers and entrepreneurs than in case of employees. In general, the consumption frequency of honey is high (Pocol and Bolboaca, 2013).

In addition, we statistically tested the dependencies between annual honey consumption and demographic factors (education, income and age). In order to obtain results that are more precise, we have merged in annual consumption these two categories: more than 10 kg and 6 – 10 kg.

We used SAS Enterprise Guide 5.1 and calculated Chi-Square Test of Independence at the significant level $\alpha = 0.01$. In terms of education and income, we found out that there is no dependence, the p -value is greater than 0.01 while in terms of age, the p -value is lower than 0.01, the dependence exists.

In Slovakia the p -value for income was 0.2684, for education it was 0.3707 and for age it was 0.0034 (Table 2). In Russia the p -value for income was 0.1265, for education it was 0.8435 and for age it was 0.0062 (Table 3). For measuring the intensity of dependencies, we applied Cramér's in SAS Enterprise Guide 5.1 shown again in (Table 2 and Table 3) and in both cases dependence is weak.

Furthermore, we examined annual consumption of honey according to the respondents' age and we can observe that in both countries older generations have higher consumption of honey than younger generation (Figure 5).

In order to support our results, we will provide several results from researches regarding honey consumption. For instance Pocol (2012) states that if we take into consideration socio-demographic aspects, education and occupation have essential impact on honey consumption.

Schifani et al. (2016) From socio-demographic factors only income had a significant impact on consumer preferences towards local honey. Furthermore, there was an identification of consumption patterns, where older consumers eat honey for its therapeutic value. They usually gain information about the honey usage from Romanian magazine "Medicina naturista". Young generation consume honey due to learned behaviour during their childhood. (Pocol and Marghitas, 2008).

The study regarding honey consumption in Romania and Hungary revealed a certain impact of demographic factors on consumption patterns. The key factors were education and age. Furthermore, an association between honey and perception of a certain health benefits was proven (Pocol and Ványi, 2012).

Another supporting statement comes from Pidek (2001) who claims that young generations are consuming honey in very low quantities, therefore honey should be advertised among this segment. Another consumer research was conducted in the Czech Republic, where they studied association between honey consumption and demographic factors (gender, age, permanent residence and income). The only dependence was proven between age and consumption. The rest factors had insignificant influence. The segment of young consumers should be educated by

parents during their childhood or by lectures at elementary and secondary schools in order to create a certain habit of consuming honey (Šanová et al., 2015). According to consumption research in Romania, age of respondents has an impact on the overall honey consumption. Young respondents (18 – 30 years) eat small quantity of honey, while middle aged (32 – 45 years) respondents have a normal consumption of honey. Respondents with the age range 46 – 60 years eat the largest amounts of honey in comparison to others (Pocol and Teselios, 2012). Again the same author found out that older generation (46 – 60 years) consume honey with high frequency while middle aged consumers (31 – 45 years) and younger generation (18 – 30 years) consume honey with medium frequency (Pocol, 2011).

CONCLUSION

Based on the results of our research we can conclude that honey is consumed by all family members in both countries. However, the majority of Slovak consumers make honey reserves and prefer to buy 1 kg per purchase while the majority of Russian consumers purchase honey if necessary and prefer to buy 0.5 or 2 – 5 kg per purchase. Main factors affecting respondents at honey purchase for Slovak consumers were the country of origin, taste, type and price while for Russian consumers the main factors were type, design of packaging, price and taste. In both countries the least important factor was the size of packaging. In terms of annual consumption we can state that the majority of respondents in both countries consume from 2 – 5 kg of honey per year, however we statistically proved that there are differences in consumption volume between the countries. Furthermore, we examined a dependency between annual consumption and demographical factors – age, education and income. Based on the test, we can conclude that only the age had statistically significant influence on consumers' consumption of honey. All in all, young generation tend to consume less honey per year than older generation, therefore we suggest to educate this segment in the future in order to increase the annual consumption of this commodity.

REFERENCES

- Batt, P. J., Liu, A. 2012. Consumer behaviour towards honey products in Western Australia. *British Food Journal*, vol. 114, no. 2-3, p. 285-297. <https://doi.org/10.1108/00070701211202449>
- Bodnar, K., Nagy, E., Makra, L. 2016. Planning of a honey based product's introduction to the market. *Lucrari Stiintifice*, vol. 18, no. 2, p. 27-30.
- Ćirić, M., Ignjatijević, S.; Cvijanović, D. 2015. Research of honey consumers' behaviour in province of Vojvodina. *Economics of Agriculture*, vol. 62, no. 3, p. 627-644.
- Cosmina, M., Galenti, G., Marangon, F., Troiano, S. 2016. Attitudes towards honey among Italian consumers: A choice experiment approach. *Appetite*, vol. 99, p. 52-58. <https://doi.org/10.1016/j.appet.2015.12.018> PMID:26719101
- Crittenden, N. A. 2011. The importance of honey consumption in Human Evolution. *Food and Foodways: Explorations in the History and Culture of Human Nourishment*, vol. 19, no. 4, p. 257-273.

- Fessenden, R., McInnes, M. 2008. *The honey revolution: Restoring the health of future generations*. USA, Texas : World Class Emprise, LLC. p. 240. ISBN 13: 978-0-9792162-1-3.
- Gálová, J., Berčík, J., Vilhanová, L. 2012. Sustainable marketing in the practice of selected brands. *Marketing in Practise of Agro-Food Sector*, p. 16-30.
- Gannabathula S., Krissansen, G. W., Bisson-Rowe, L., Skinner, M., Steinhorn, G., Schlothauer, R. 2017. Correlation of immunostimulatory activities of honey with their contents of identified bioactives. *Food chemistry*, vol. 221, p. 39-46. <https://doi.org/10.1016/j.foodchem.2016.10.038> PMID:27979219
- Gyau, A. Akalakou, C., Degrande, A., Biloso, A. 2014. Determinants of consumer preferences for honey in the Democratic Republic of Congo. *Journal of food products marketing*, vol. 20, no. 5, p. 476-490. <https://doi.org/10.1080/10454446.2013.807405>
- Ismail, A. Z. S., Al-Ghamdi, S. A. K. A. A., Adgaba, S. 2014. Qualitative Factors Affecting the Price and Demand of Honey in Saudi Arabia. *Australian Journal of Basic and Applied Sciences*, vol. 8, no. 10, p. 199-206. <https://doi.org/10.4236/jns.2014.517186>
- Johnston, J. E., Sepe, H. A., Miano, C. L., Brannan, R. G., Alderton, A. L. 2005. Honey Inhibits Lipid Oxidation in Ready-to-Eat Ground Beef Patties. *Meat Science*, vol. 70, no. 4, p. 627-631. <https://doi.org/10.1016/j.meatsci.2005.02.011> PMID:22063889
- Kapsdorferová, Z. 2008. *Manažment kvality (Quality management)*. 1st ed. Nitra, Slovakia : SPU. 120 p. ISBN 978-80-552-0115-3.
- Kozelová, D., Matejková, E., Fikselová, M., Dékányová, J. 2014. Analysis of consumer behaviour at chocolate purchase. *Potravinárstvo*, vol. 8, no. 1, p. 62-66. <https://doi.org/10.5219/325>
- Krystallis, A., Petrovici, D., Arvanitoyannis, I. 2007. From Commodities to the Consumption of Quality Foods in Eastern European Context. *Journal of East-West Business*, vol. 12, no. 4, p. 5-37. https://doi.org/10.1300/J097v12n04_02
- Kubicová, E. 2008. *Development of consumer demand for food (Vývoj spotrebiteľského dopytu po potravinách)*. Nitra, Slovakia : SPU. 85 p. ISBN 978-80-552-0092-7.
- Marghitas, L. A., Dezmirean, D. S., Pocol, C. B., Ilea, M., Bobis, O., Gergen, I. 2010. The development of a biochemical profile of acacia honey by identifying biochemical determinants of its quality. *Notulae Botanicae Horti Agrobotanici Cluj-Napoca*, vol. 38, no. 2, p.9-13.
- Matsuda, A. H., Sabato, S. F. 2004. Effect of Irradiation on Brazilian Honey's Consistency and Their Acceptability. *Radiation Physics and Chemistry*, vol. 71, no. 1-2, p. 107-110. <https://doi.org/10.1016/j.radphyschem.2004.03.068>
- Mokrý, S., Birčiaková, N., Slováčková, T., Stávková, J., Nagyová, L. 2016. Perception of wine labels by generation Z: Eye-tracking experiment. *Potravinárstvo*, vol. 10, no. 1, p. 524-531.
- Murphy, M., Cowan, C., Henchion, M., O'Reilly, S. 2000. Irish consumer preferences for honey: a conjoint approach. *British foodjournal*. vol. 102, no. 8, p. 585-598. <https://doi.org/10.1108/00070700010348424>
- Nagyová, L. 2005. *Consumer behavior on the regional food market (Spotrebiteľské správanie na regionálnom trhu potravín)*. In: Riešenie vybraných manažerských a marketingových problémov v agropotravinárstve. Nitra : SPU. p. 119. ISBN 80-8069-510-5.
- Nagyová, L. 2012. *Trends in consumer behavior on the food market in Slovakia (Trendy v spotrebiteľskom správaní na trhu potravín v SR)*. Nitra, Slovakia : SPU. 83 p. ISBN 978-80-552-0899-2.
- Pidek, A. 2001. Youth preferences in honey consumption. *Journal of apicultural science*, vol. 45, p. 115-119.
- Pocol, C. B. 2012. Consumer preferences for different honey varieties in the North West Region of Romania. *Agronomy Series of Scientific Research*, vol. 55, no. 2, p. 263-266.
- Pocol, C. B. 2011. Modelling the honey consumption behaviour in Romania by using socio-demographic determinants. *African Journal of Agriculture Research*. vol. 6, no. 17, p. 4069-4080.
- Pocol, C. B., Bolboacă, S. D. 2013. Perceptions and trends related to the consumption of honey: A case study of North-West Romania. *International Journal of Consumer Studies*, vol. 37, no. 6, p. 642-649. <https://doi.org/10.1111/ijcs.12046>
- Pocol, C. B., Ilea, M. 2011. The development of local products in Romania: A case study of honey. *Lucrări Științifice, Universitatea de Științe Agricole Și Medicină Veterinară a Banatului, Timisoara, Seria I, Management Agricol*, vol. 13, no.2, p. 153-160.
- Pocol, C. B., Marghitas, L. A. 2006. Factors that influence supply and demand for bee products. *Buletin USAMV-CN*, vol. 62, p. 133-136.
- Pocol, C. B., Marghitas, L. A. 2007. Market study about honey consumption in Romania. *Buletin USAMV-CN*, vol. 64, no. 1-2.
- Pocol, C. B., Marghitas L. A. 2008. A comparison between the segmentation of honey market in Romania and Ireland. *Bulletin UASVM*, vol. 65, no. 2, p. 279-282.
- Pocol, C. B., Teselios C. M. 2012. Socio-economic determinants of honey consumption in Romania. *Journal of Food, Agriculture & Environmen*, vol.10, no. 2, p. 18-21.
- Pocol, C. B., Ványi G. A. 2012. A comparison between Hungarian and Romanian consumption. *Bulletin UASVM*, vol. 69, no. 2, p. 244-252.
- Pocol, C. B., Marghitas, L. A., 2008. Qualitative exploration of honey among consumer segments by using the focus group method. *Bulletin of University Of Agricultural Sciences And Veterinary Medicine Cluj Napocaculture*. vol. 65, no. 2, p. 460.
- Rall, V. L. M., Bombo, A. J., Carvalho, L. R., Silva, M. G. 2003. Honey Consumption in the State of Sao Paulo: A Risk to Human Health? *Anaerobe*, vol. 9, no. 6, p. 299-303. [https://doi.org/10.1016/S1075-9964\(03\)00121-5](https://doi.org/10.1016/S1075-9964(03)00121-5)
- Roman, A., Popiela-Pleban, E., Kozak, M., Roman, K. 2013. Factors influencing consumer behavior relating to the purchase of honey part 2. product quality and packaging. *Journal of apicultural science*, vol. 57, no. 2, p. 175-185. <https://doi.org/10.2478/jas-2013-0027>
- Schifani, G., Romeo, P., Schimmenti, E., Columba, P., Migliore, G. 2016. Conventions of quality in consumer preference towards local honey in Southern Italy. *Calitatea: Acces la Success*, vol. 17, no. 153, p. 92-97.
- Šanová, P. 2015. Pilot analysis of key factors in honey consumption. In *Agrarian perspectives XXIV: Global agribusiness and the rural economy*. Prague, Czech Republic : Czech University Life Science, pp. 416-424. ISBN 78-80-213-2581-4.
- Veselý, V. 2013. *Apiculture (Včelárství)*. 3rd ed. Praha, Czech Republic : Nakladatelství Brázda. 272 p. ISBN 978-80-209-0399-0.
- Wu, S., Fooks, J. R., Messer, K. D., Delaney, D. 2015. Consumer demand for local honey. *Applied Economics*. vol. 47, no. 41, p. 4377-4394. <https://doi.org/10.1080/00036846.2015.1030564>

Yeow, S. H. C., Chun, S. T. S., Yeow, J. A. Tan, K. S. 2013. Consumer Purchase Intentions and Honey Related Products. *Journal of Marketing Research & Case Studies*, vol. 2013, p. 1-15. <https://doi.org/10.5171/2013.197440>

Rozdolskaya I. V., Grishkova, N. S; Yakovleva, L. R. 2015. Marketing Study of Honey Buyers' Preferences – The Belgorod Oblast Honey Market As A Case Study (Маркетинговые исследования покупательского предпочтения на мед на примере рынка меда Белгородской области). *Fundamental research*, no. 7, p. 193-201.

Acknowledgments:

The paper is part of the research project KEGA 038SPU-4/2016 "Using of new technologies and interdisciplinary associations in consumer studies" conducted at the Department of Marketing and Trade at the Faculty of

Economics and Management of the Slovak University of Agriculture in Nitra.

Contact address:

Assoc. Prof. Snezhanna Guziy, PhD., Russian Timiryazev State Agrarian University, Faculty of Economics, Department of Marketing, Timiryazevskaya str., 49, Moscow, Russia, 127550, E-mail: guziy@rgau-msha.ru

Ing. Peter Šedík, Slovak University of Agriculture, Faculty of Economics and Management, Department of Marketing and Trade, Tr. A. Hlinku 2, 949 76 Nitra Slovakia, E-mail: sedik.peter@gmail.com

prof. Dr. Ing. Elena Horská, Slovak University of Agriculture, Faculty of Economics and Management, Department of Marketing and Trade, Tr. A. Hlinku 2, 949 76 Nitra, Slovakia, E-mail: elena.horska@gmail.com



APPROACHES TO THE DETERMINATION OF ANTIOXIDANT ACTIVITY OF EXTRACTS FROM BEE BREAD AND SAFFLOWER LEAVES AND FLOWERS

Nataliia Hudz, Raisa Ivanova, Ján Brindza, Olga Grygorieva, Zuzana Schubertová, Eva Ivanišová

ABSTRACT

The main objective of this study was to develop approaches for the determination of total antioxidant activity of natural products (bee bread and safflower extracts) using DPPH radical scavenging assay. Considering that analytical procedures and results related to this assay and reported by many authors are significantly differed between each other and depend on many factors (the nature of tested extracts, the nature of solvents for extraction, a reaction time of DPPH with a sample, DPPH solvents and concentration, ratio between DPPH and an extract, etc.), the methodology of the evaluation of antioxidant capacity of different origin extracts by DPPH radical scavenging assay was developed. Ascorbic acid (AA) was used as standard antioxidant and the correlation between the percentage of DPPH scavenging and AA concentration was determined at two different initial absorbances of DPPH solution. Average concentration of AA which inhibited 50% of DPPH radicals (IC_{50}) was equal to $156.0 - 171.26 \mu\text{g}\cdot\text{mL}^{-1}$. The reaction kinetics of DPPH inhibition by bee bread and safflower extracts was described by the curves of the dependence of the total antioxidant activity on time with squared correlation coefficients (R^2) in the range of 0.89 – 0.98. The reaction times for these extracts were from 40 to 70 min at the correct ratio of volumes between the tested extracts and a DPPH solution. These studies demonstrated that the extracts obtained from bee bread of 2016 year of pollen collection had significantly higher the total antioxidant activity compared with the extracts of bee bread of pollen collection of 2015 considering the ratio of bee bread and the solvent in the extracts and volume of the extract for the procedure. This fact is explained not only botanical origin but also the time of the storage of bee bread before the preparation of extracts. There was not found significant differences in the total antioxidant activity of extracts from flowers of safflower sown in fall and in spring. Antioxidant activity of the extracts from leaves of spring sown safflower was higher compared with the total antioxidant activity of the extracts from fall sown plants. Ascorbic acid equivalents of the tested extracts could be ranged as follows: bee bread of 2016 pollen collection > bee bread of 2015 pollen collection > leaves of safflower spring sown > flowers of safflower spring sown > flowers of safflower fall sown > leaves of safflower fall sown.

Keywords: bee bread; safflower; antioxidant activity; DPPH; phenolic compounds

INTRODUCTION

Herbal preparations and food of plant origin are considered to be the most promising sources of antioxidants. In the initial stages of the development of herbal preparations or food herbal products, especially from nonpharmacopeia plant material, the determination of the sum of such analytical markers as phenolic compounds, provitamins (carotenoids) and vitamins (vitamin C, vitamin E (tocopherols)), microelements with changeable valence (manganese, iron, selenium etc.), amino acids and enzymes, having antioxidant properties, unsaturated acids could generally define biological value including nutritional properties of these products. Se, Cu and Zn are considered antioxidant nutrients (Salem et al., 2011; Yu et al., 2013; Markievicz-Žukovska et al.,

2013; Ivanisova et al., 2015; Rzepecka-Stojko et al., 2015; Zuluaga et al., 2015). Crude extracts of fruits, herbs, vegetables, cereals and other plant materials rich in phenolics are increasingly being used in the food, pharmaceutical and cosmetics industry for their antioxidative properties and health benefits (Salem et al., 2011; Baba and Malik, 2015).

According to the nature all antioxidants are divided into two large groups: hydrophilic and hydrophobic. The hydrophilic antioxidants (vitamin C, phenolic acids and others) are reacted with oxidants in the cytoplasm of the cell, inside cell organelles, and in extracellular fluid, while the lipophilic antioxidants (carotenoids, tocopherols, flavonoids, etc.) protect cell membranes from lipid peroxidation. Bee pollen collected from willow, pear and

apple trees, and from dandelion has the highest content of ascorbic acid (Rzepecka-Stojko et al., 2015). Antioxidant properties are closely related to chemical structure of phenolic compounds, especially with the number of hydroxyl groups on the aromatic ring and conjugated double bonds (Rzepecka-Stojko et al., 2015; Zuluaga et al., 2015). The high phenolic and flavonoid content is responsible for the bioactivity of crude extracts. Flavonoids are highly effective scavengers of most oxidizing molecules, including singlet oxygen, suppress reactive oxygen formation, chelate trace elements involved in free-radical production, scavenge reactive species and up-regulate and protect antioxidant defenses (Baba and Malik, 2015). The presence of a double bond between C2 and C3 in the C-ring in a flavonoid structure influences antioxidative properties. A carbonyl group at the C4 position enables the compounds to scavenge hydroxyl radicals. This group is presented in flavons, flavonols, flavanons, and isoflavons. The ability to scavenge hydroxyl radical increases with the number of hydroxyl groups present in the B-ring, especially at the positions C3' and C4'. The presence of hydroxyl groups at the C5 and C7 positions in the A-ring, C3' and C4' in the B-ring, as well as C3 in the C-ring enhances the inhibition of lipid peroxidation (Rzepecka-Stojko et al., 2015).

Among natural sources of antioxidants are bee pollen, bee bread, leaves and flowers of safflower (Salem et al., 2011; Yu et al., 2013; Ivanišova et al., 2015; Kušoğlu and Kahraman, 2015; Rzepecka-Stojko et al., 2015; Bogdanov, 2016; čeksteryte et al., 2016).

According to different authors, content of phenolic compounds amounts to 3.0 – 5.0% (including phenolic acids 0.19% and flavonoids 0.25 – 1.4%) (Rzepecka-Stojko et al., 2015), 1.05 – 1.68% (Markievicz-Žukovska et al., 2013) in bee pollen and 0.25 – 1.37%, in particular flavonoids 0.19 – 0.45%, (Zuluaga et al., 2015), 2.12 ± 0.008% (Čeksteryte et al., 2016), 1.35 – 2.54% (Ivanisova et al., 2015) in bee bread.

Polyphenols are components of safflower and bee pollen that determine their antioxidative activity as they scavenge free radicals and chelate metal ions. Flavonoids are the largest group of phenolic compounds, which have antioxidant, antimicrobial, antitumor, antiinflammatory activities, regulate free-radical reactions in the body. The pollen flavonoids quercetin, rutin and chrysin demonstrated a chemopreventive activity by increasing apoptosis. Flavonoids in plants constitute the antioxidant system, in which various antioxidants restore each other and exhibit a synergistic effect (Silva et al., 2014; Barene et al., 2015; Rzepecka-Stojko et al., 2015; Zuluaga et al., 2015; Bogdanov, 2016). The content of polyphenols in bee bread extracts can strongly vary depending on the botanic origin of the raw material, the time and location of collection of bee bread, drying and/or storage conditions and extraction conditions as well (nature of a solvent, its concentration, ratio raw material-solvent, a method of extraction, etc.) (Markievicz-Žukovska et al., 2013; Rzepecka-Stojko et al., 2015; Zuluaga et al., 2015; Bogdanov, 2016; čeksteryte et al., 2016). Among phenol compounds of bee bread were identified p-coumaric acid and trace amounts of ferulic and caffeic acids, and flavonoids kaempferol, apigenin, chrysin, isorhamnetin, naringenin and quercetin (Markievicz-Žukovska et al.,

2013; Čeksteryte et al., 2016). According to Čeksteryte et al. (2016) flavonoids in the form of glycosides were not found in bee bread.

Bee bread is a fermented mixture of plant pollen, honey, and bee saliva that worker bees use as food for the larvae, and for young bees to produce royal jelly. Pollen collected by bees is mixed with a small amount of honey and saliva and packed into the cells of the honeycomb where it undergoes a chemical change (lactic fermentation) (Brovarkij et al., 2010; Brindza et al., 2013; Markievicz-Žukovska et al., 2013; Eswaran and Bhargava, 2014; Zuluaga et al., 2015). As a rule, biochemical composition of pollen changes in the process of fermentation: concentration of proteins reduces because of degradation to amino acids, contents of lactic acid and carbohydrates increase, and fats decrease. As concentration of lactic acid increases, pH of suspension of bee bread is lower (3.8 – 4.3) compared with pollen (approximately 6.3) (Barene et al., 2015; Zuluaga et al., 2015). Bioactive properties and content of compounds in bee bread are associated mainly with its botanical origin. Bee bread contains a wide variety of compounds. More than 200 compounds were identified in extracts of bee bread samples. Among them are phenolic antioxidants (phenolic acids and flavonoids), unsaturated fatty acids (α -linolenic, linoleic, oleic and 11, 14, 17-eicosatrienoic acids), carbohydrates, free amino acids, C21 – C35 alkanes, unsaturated alcohols, carbohydrate acids, vitamins (B1, B2, B6, pantothenic acid, folic acid), carotenoids, microelements, lipids (1.65 – 5.50%), proteins (19.1 – 27.3%) (Markievicz-Žukovska et al., 2013; Eswaran and Bhargava, 2014; Barene et al., 2015; Hudz et al., 2015; Ivanišova et al., 2015; Rzepecka-Stojko et al., 2015; Zuluaga et al., 2015; Bogdanov, 2016; čeksteryte et al., 2016; Gálik et al., 2016; Hudz et al., 2016). Such a fact as a precipitation in our investigations at the change of a solvent for dilution of extracts of bee bread does indicate the diversity of biologically active substances in it (Hudz et al., 2016). Therefore, it is necessary to pay attention on the choice of reagents during development of analytical procedures of the determination of antioxidant activity and contents of flavonoids of bee bread extracts with the purpose of avoiding precipitation during a reaction in these analytical procedures.

Safflower (*Carthamus tinctorius* L.) plants are valuable agronomic species for their multipurpose usage: the presence of red and yellow pigments as food colorants (Jadhav and Joshi, 2015); as the source of phenolic substances as natural antioxidants (Yu et al., 2013; Kušoğlu and Kahraman, 2015) and vegetable oil as source of alphanatocopherol (Zubkov et al., 2014; Matthaus et al., 2015). Flowers and seeds are extensively used in traditional herbal medicine in Asian countries (China, Korea, and Japan) for treating various diseases such as gynecological, cardiovascular and cerebrovascular ones (Yu et al., 2013; Gautam et al., 2014; Zhou et al., 2014). Pharmacological effects of safflower are due to its ability to accumulate the biologically active secondary metabolites, especially phenolic compounds, in different parts of plant (Lee et al., 2002; Salem et al., 2011; Zhang et al., 2016). Using the secondary metabolites from flowers and seeds of safflower some new pharmaceutical

preparations were obtained (Kharisova, 2014). More than 200 compounds were isolated from different parts of *C. tinctorius* L. (Asgarpanah and Kazemivash, 2013; Zhou et al., 2014) and identified as flavonols and flavanones (Zhao et al., 2005), chalcone flavonoids (Salem et al., 2011; Yue et al., 2013) and their glycosides (Zhou et al., 2006). The accumulation of secondary metabolites in safflower depends on eco-geographical area and various technological approaches of plant cultivation (Treutter, 2010), and in particular on the time of sowing. It is well-known that safflower seeds can be sown in the fall or in the spring because of its low temperatures tolerance. Petrie et al. (2010) reported that fall seeding resulted in earlier flowering and maturity and increased yield compared to spring seeding. However, the comparative studies of biologically active secondary metabolites accumulation in safflower of different time of sowing and their antioxidant activity were not carried out enough yet. The DPPH scavenging radicals assay procedures reported by many authors are significantly differed by their performing. Among such differences are time and kinetics of the reaction between DPPH and bioactive constituents of tested extracts, solvents and concentration of DPPH, used wavelength in the procedure (Yu et al., 2013; Carmona-Jiménez et al., 2014; Fadda et al., 2014; Nicklisch and Waite, 2014). As Fadda et al. (2014) have reported the reaction of DPPH with lemon juice is completed in 3 min; 87 and 98 min are necessary for green tea infusion and pomegranate juice, respectively; 283 min are needed for rosemary essential oil. Yu et al. (2013) incubated reaction mixtures of safflower extracts with DPPH during 4 min and measured their absorbance at wavelength of 490 nm. While Salem et al. (2011) and Kuşoğlu and Kahraman (2015) employed the analytical procedure which established an incubation period of 30 min the absorbance read at 517 nm. However, they used the different ratio of an extract to volume of DPPH (Salem et al., 2011; Kuşoğlu and Kahraman, 2015). Different modifications and optimizations of DPPH assay are performed with the purpose of their adaptation to tested samples or are the invention of researchers. Therefore, it is not easy to compare results of different scientists.

Total antioxidant activity of extracts of bee bread and leaves and flowers of safflower may serve an important marker on the initial stages of the DPPH assay development, including stage of their extracts obtaining (choice of an optimal solvent for extraction, duration of extraction, the type of extraction, the time of collection of bee bread etc.). Therefore, the main objective of this study to develop approaches for determination of the total antioxidant activity of extracts from bee bread as well as leaves and flowers of safflower sown in fall and spring by means of DPPH and evaluate the differences in antioxidant activities of the tested extracts.

MATERIAL AND METHODOLOGY

Biological material

Bee bread was obtained from Mykolajev and Poltava regions of Ukraine. Samples were collected in the summer (July) of 2015 and May – June of 2016. Three samples of bee bread were collected in Mykolajev region and one sample in Poltava region. Leaves and flowers of safflower

were collected in July 2016 in Chisinau area of the Republic of Moldova. Leaves and flowers were collected from at least 10 safflower plants of fall as well as spring sowing. The extracts were prepared from medium sample of identical plant material in 5 replicates.

Chemicals

The chemicals such as 1,1-Diphenyl-2-picrylhydrazyl (DPPH), methanol, ethanol, ascorbic acid were analytical grade and were purchased from Reachem (Slovakia), Sigma Aldrich (USA) and Ukraine (ascorbic acid).

Ethanol extraction

Some bee bread samples in the amount 2.5 g were extracted with 50 mL of 50% ethanol for 9 days, or in the amount 10.0 g were extracted with 100 mL of 50% ethanol for 21 days. The process of the preparation of bee bread extracts is described in Table 1. Supernatants were decanted and filtered through filter paper and stored in fridge (2 – 8 °C).

1, 7-11 batches of extracts were prepared from bee bread samples collected in Mykolajev region and 3 batch was prepared from bee bread collected in Poltava region. 7, 8, 9 and 10, 11, respectively, were prepared from different granules of the same example.

The extraction from leaves and flower of safflower was performed by maceration procedure using 70% aqueous ethanol. Ratio between the fresh plant material and ethanol solution was 1 : 10 for leaves and 1: 20 for flowers. After 7 days of extraction, the extracts were filtered through paper filter and stored at 4 – 6 °C.

Potentiometric determination of pH

Values of pH of bee bread samples was determined by pH meter WTW 3110 (Germany) previously calibrated with buffers pH = 4.01 and pH 6.86. 2% suspensions of three samples of bee bread were used for determination of their value of pH.

DPPH free radical scavenging assay

Total antioxidant activity of samples was measured using 2,2-diphenyl-1-picrylhydrazyl ($C_{18}H_{12}N_5O_6$) (DPPH) according to modified analytical procedure (Baba and Malik, 2015). The extracts or their appropriate dilutions of bee bread (0.05 mL) were mixed with 1.95 mL of DPPH solution (0.0025 g DPPH in 100 mL 50% methanol) and incubated in the darkness for 60 – 70 min. Every 10 min the absorbance of the reaction mixtures was determined using the UV/Vis spectrophotometer (Genesys 20, USA) at 515 nm. The blank of a sample consisted of 0.05 mL of the corresponding extract or its appropriate dilution and 1.95 mL of 50% methanol. The blank of DPPH solution consisted of 0.05 mL of 50% ethanol and 1.95 mL of 50% methanol.

This analytical procedure was tested on leaves and flowers of safflower in the same way with one exception: initial extracts (0.05 mL) were mixed with 1.95 mL of DPPH solution. For positive control 0.05 mL solutions with different concentration of ascorbic acid were mixed with 1.95 mL of DPPH solution (at two different absorbances of DPPH solution).

Table 1 Preparation of the extracts of bee bread.

Number of batch of extract	Date of collection of bee pollen	Ratio of bee bread to 50% ethanol	Dates of extraction	Time of maceration
1	15/07/2015	10 g : 100 mL	19/04/2016 – 10/05/2016	21 day
3	03/07/2015	10 g : 100 mL	19/04/2016 – 10/05/2016	21 day
7	10/06/2016	2.5 g : 50 mL	28/09/2016 – 07/10/2016	9 days
8	10/06/2016	2.5 g : 50 mL	28/09/2016 – 07/10/2016	9 days
9	10/06/2016	2.5 g : 50 mL	28/09/2016 – 07/10/2016	9 days
10	23/05/2016	2.5 g : 50 mL	28/09/2016 – 07/10/2016	9 days
11	23/05/2016	2.5 g : 50 mL	28/09/2016 – 07/10/2016	9 days

All the tests were performed in triplicate. The radical scavenging activity of a tested extract or its dilution was calculated as follows:

$$\%inhibition = \frac{[A(DPPH) - A(extract)] \times 100}{A(DPPH)}$$

where: A (DPPH) – the absorbance of a solution DPPH; A (extract) – the absorbance of a sample or its dilution. Every 10 min absorbances of the solution DPPH and the tested sample were measured.

Ascorbic acid (AA) was used as standard antioxidant, its calibration curves were determined in the range of concentrations from 0.04 to 0.4 mg.mL⁻¹ at the different initial absorbances (Figure 1). The squared coefficients of correlation of the linear equation for these curves were 0.9371 and 0.9755 that permitted to express the obtained results of the total antioxidant activity of the tested extracts in equivalents of ascorbic acid. Concentration of AA which inhibited 50% of DPPH radicals (IC₅₀) was equal to 163.5 ± 7.5 µg.mL⁻¹.

RESULTS AND DISCUSSION

Values of pH of the three suspensions were in the range of 4.09 – 4.17 (4.19, 4.17, 4.09). Our results were in conformity to **Barene et al. (2015)** data 4.01 – 4.23 (in general not less than 3.7), **Ivanisova et al. (2015)** data (3.8 – 4.3) and the data of **Ukrainian standard 7074:2009 (2010)** 3.5 – 5.0. It seems that the limits of Ukrainian standard are too wide. It is suppose that bee bread with pH higher than 4.3 can be of poor quality because of low content of lactic acid.

One of the methods for assessing the total antioxidant activity is determination of the absorption of the solution of DPPH, dissolved in methanol or ethanol of certain concentration in water, without addition of a sample (a herbal product) and with the addition of this sample at specific intervals of time.

The reduction of a DPPH absorbance with compounds with antioxidant properties (compounds containing hydrogen) changes purple color of a reaction mixture into slightly purple or even pale or yellowish depending on the content of antioxidants in a sample and their nature. The reduce of staining intensity is controlled by change in the absorbance of the reaction mixture at 515 nm over time. According to the literature, DPPH has an absorption maximum at 514 – 517 nm. Fixing a reduce of a color intensity of a reaction mixture is carried out by various authors at various time intervals: from 4 – 15 minutes to 1 hours (**Meda et al., 2005; Yu et al., 2013; Eswaran and**

Bhargava, 2014; Ivanišova et al., 2015; Čeksteryte et al., 2016).

Assay of the total antioxidant activity foresees the selection of appropriate conditions for every extract. As evidenced by the literature data, modifications of this analytical procedure involve a solvent selection for DPPH, concentration of DPPH in solution, ratio of the volume of an extract to a DPPH solution, time of interaction of an extract with DPPH, the wavelength at which absorbance of the reaction mixture is measured, the pH of the reaction medium, the composition of a blank, methods of calculating an antioxidant activity, presence or absence of a positive control, the nature of the antioxidant in the positive control (**Meda et al., 2005; Ivanišova et al., 2015; Čeksteryte et al., 2016).**

Fifty percent ethanol was chosen as a solvent for the extraction from point of view of the extraction of both hydrophilic and hydrophobic compounds from bee bread simultaneously. In addition to this, some literature data confirm that aqueous and 50% ethanolic extracts have higher antiradical scavenging activity compared to 90% ethanol (**Eswaran and Bhargava, 2014).** The studies have been started with the selection of the methanol concentration for dissolution of DPPH. The studies conducted on two native extracts of bee bread demonstrated the dependence of radical scavenging activity on methanol concentration in solvent for DPPH.

As below provided results show (Figure 2), the total antioxidant activity of bee bread extract of batch 1 in the presence of 100% methanol is lower. In addition to it, the obvious visible precipitation was observed for batch 1 using 100% methanol as a solvent of DPPH. It is supposed that 100% methanol as a solvent of DPPH precipitates more hydrophilic substances with antioxidant activity. This assumption is agreed with literature dates that one of the major drawbacks of measuring antioxidant activity by means of DPPH is missing a large contribution of antioxidant activity from proteins and other hydrophilic antioxidants because they are precipitated by methanol (**Nicklisch and Waite, 2014).** Among more hydrophilic antioxidants could be flavonoids in the form of glycosides with 3 monosaccharide remnants or proteins. These flavonoids are soluble in water but not soluble in strong alcohols (**Anonym, 2009).**

The next stage of the elaboration of the analytical procedure of total antioxidant activity measuring by means of DPPH was to select the volume of a sample for the determination of the reliable total antioxidant activity of extracts.

Figure 3 demonstrates that if the concentration of antioxidants is too high, then DPPH is reduced very fast.

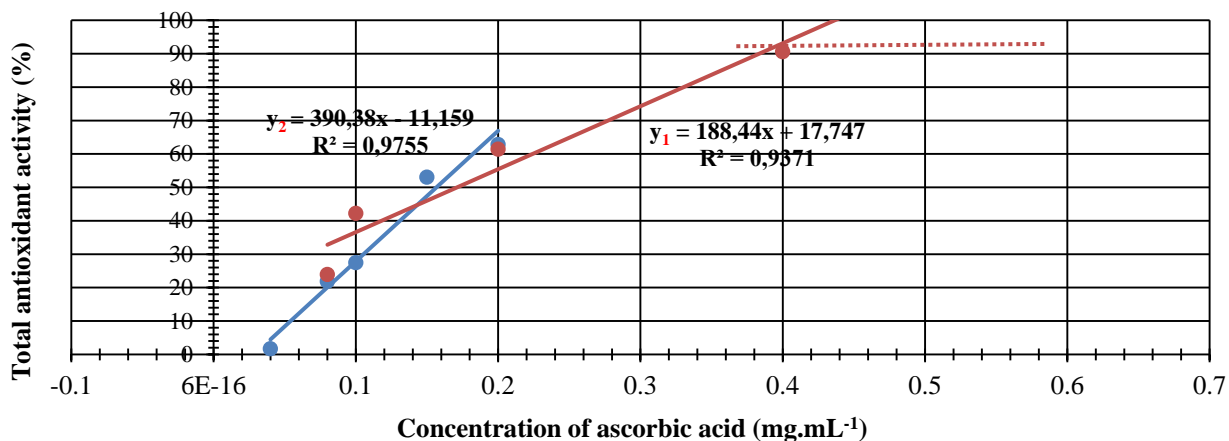

Figure 1 Dependence of the total antioxidant activity on concentration of ascorbic acid: 1 – curve at the initial absorbance of DPPH 0.603 ($R^2 = 0.9371$); 2 – curve at the initial absorbance of DPPH 0.520 ($R^2 = 0.9755$).

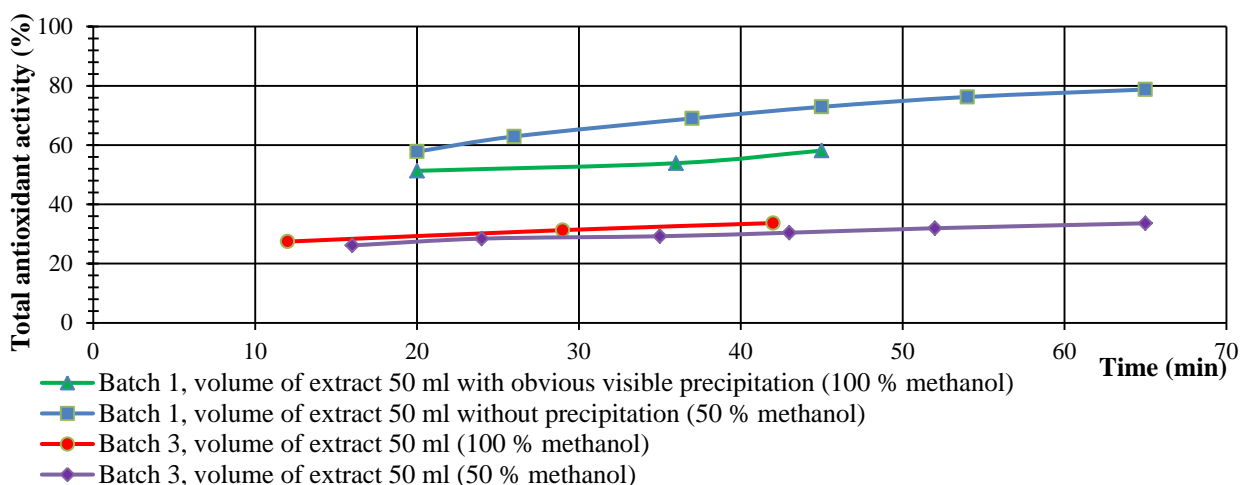

Figure 2 The dependence of the antioxidant activity of two extracts of bee bread on the concentration of methanol in DPPH solution.

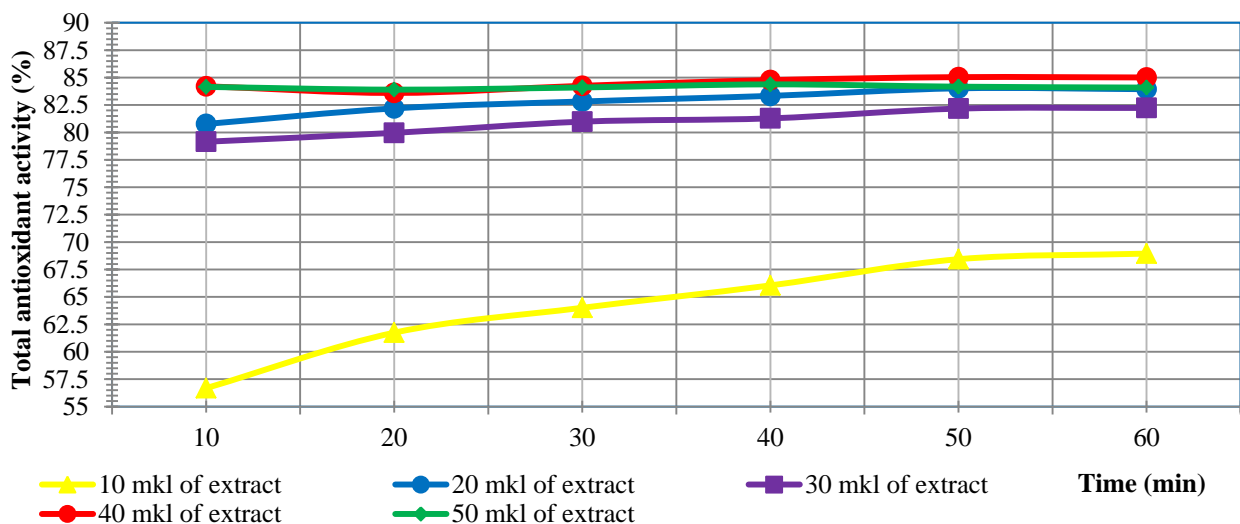

Figure 3 The dependence of the total antioxidant activity on the volume of the native bee bread extract (the initial absorption of DPPH was approximately 0.500).

In that case, the kinetic curves of antioxidant activity changes on time are more parallel to axis X (time) and what is more the total antioxidant activity is equal 80 – 85% and does not depend on the volume of the extract (20 – 50 mkl). These studies were conducted for batch 7. The same situation was observed for positive

control: at too high ascorbic acid concentration ($0.4 - 0.6 \text{ mg.mL}^{-1}$) the part of kinetic curve of antioxidant activity change on AA concentration is parallel to axis of concentration.

Another stage of our study was to check antioxidant activity of bee bread extracts using 0.0025% DPPH

solution with date of its storage for 24 hours. These studies showed that absorption of a DPPH solution was reduced with the time of its storage and the total antioxidant activity of extracts dilutions increased, respectively (Figure 4). In these studies the following regularity was observed: the less the absorption of a DPPH solution the more the total antioxidant activity of a sample was.

Figure 4 shows that antioxidant activity of the extract dilution of batch 8 is significantly higher at the less initial absorption of DPPH 0.471 (80.51%) compared with 64.25 – 68.64% at the initial absorption of DPPH 0.587 – 0.592. There is the same situation with batch 9. On the base of obtained results, it is concluded that it is possible to compare results of measuring the total antioxidant activity only at the same values of the initial absorption of a DPPH solution. Consequently, the total antioxidant activity of batch 8 is higher than that of batch 7 if we take into consideration the initial absorption of DPPH 0.466 and 0.471, respectively. Similarly, the total antioxidant activity of batch 9 is higher than that of batch 8 if we take into consideration the initial absorption of DPPH 0.576 and 0.587 or 0.592, respectively.

One more stage of the development of analytical procedure of measuring the total antioxidant activity was approbation of the developed procedure for assay of the total antioxidant activity of safflower leaves and flowers extracts. The results are presented in Figure 5.

The reaction kinetics of DPPH inhibition by safflower extracts is good described by the curves of the dependence on time with squared correlation coefficient in the range of $R^2 = 0.89 - 0.98$. The reaction times for these extracts were in the range from 40 to 60 min. As figure 4 indicates that total antioxidant activity of the extract from leaves of spring sown safflower is much higher compared with flowers spring sown safflower. It is explained by the ratio between the fresh plant material and ethanol: 1: 10 for leaves and 1: 20 for flowers. Content of AA equivalents in the extract from leaves of spring sown safflower was higher, but no significantly, than that in the extract from leaves of fall sown plants. Content of AA equivalents in the extract from flowers of spring sown safflower was similar with that in the extract from flowers of fall sown plants. Considering that the antioxidant activity is predetermined by accumulation of secondary metabolites

on plants, the obtained data correlated with the content of total polyphenols and flavonoid glycosides, in safflower plants of spring and fall sown (Ivanova et al., 2016). The total phenolic content in flower extracts collected from plant sown in fall and in spring was similar ($0.25 \pm 0.02 \text{ mg.mL}^{-1}$). Leaves of spring sown safflower contained the total polyphenols as well as the flavonoid glycosides more by 20 – 30% than leaves of fall sown plants.

Despite fact that the ratio between fresh plant materials and ethanol is 1: 10 for leaves compared to flowers 1:20, the total antioxidant activity of the extract from leaves of spring sown safflower is only higher 1.67 times compared with flowers spring sown safflower. The same situation is observed with the extracts from leaves and flowers of fall sown safflower ($71.46 : 42.41 = 1.68$) (Table 2). Ascorbic acid equivalent of antioxidant activities of tested extracts could be ranged following: leaves of safflower spring sown \geq flowers of safflower spring sown \geq flowers of safflower fall sown $>$ leaves of safflower fall sown. The present study revealed that the extract from leaves of safflower sown in spring possessed the greatest antioxidant activity in ascorbic acid equivalent.

In these studies we also observed the following regularity: the less the absorption of negative control was the higher the total antioxidant activity of extract from leaves or flowers of fall sown safflower was (Table 2). For comparison, the total antioxidant activity of extract from flowers of fall sown safflower was 34.54% at the initial absorbance of DPPH 0.587 and, respectively, 42.41% at the initial absorbance of DPPH 0.466.

Table 2 also shows that samples of bee bread extracts of samples 7, 8, 9, 10 and 11 had significantly higher total antioxidant activity compared with batches 1 and 3 considering the ratio of bee bread and the solvent in the extracts and volume of the extract for the procedure. This fact can be explained not only botanical origin but also the time of the storage of bee bread before the preparation of extracts. Considering the same ratio 1:10 of raw material and the solvent in the tested extracts of bee bread and safflower and the same initial absorbance of DPPH (0.589 – 0.612), the results of the total antioxidant activity and AA equivalents are comparable for the extracts from leaves of spring sown safflower (67.14%), flowers of

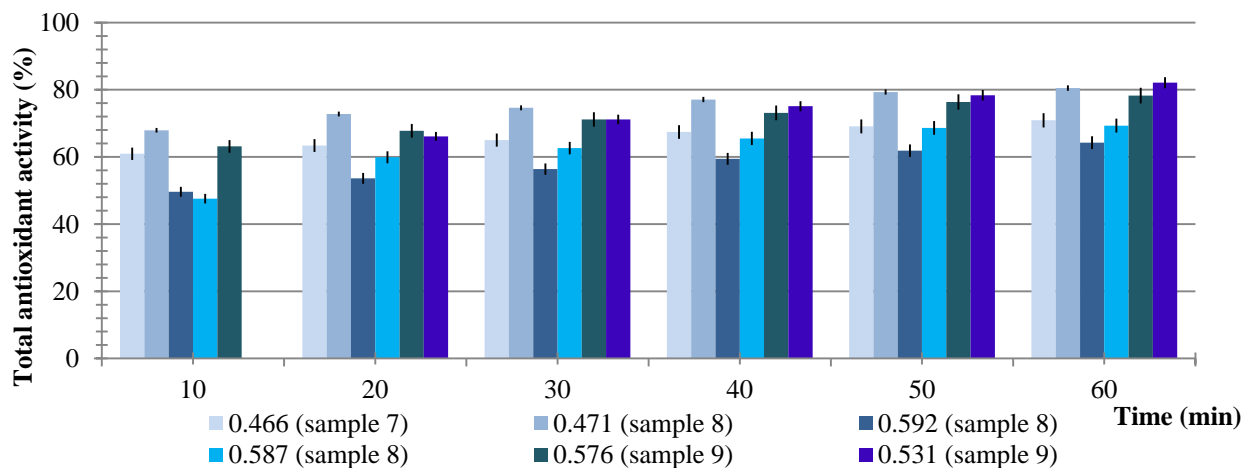

Figure 4 The dependence of the total antioxidant activity of the extracts dilutions on the initial absorption of DPPH solutions.

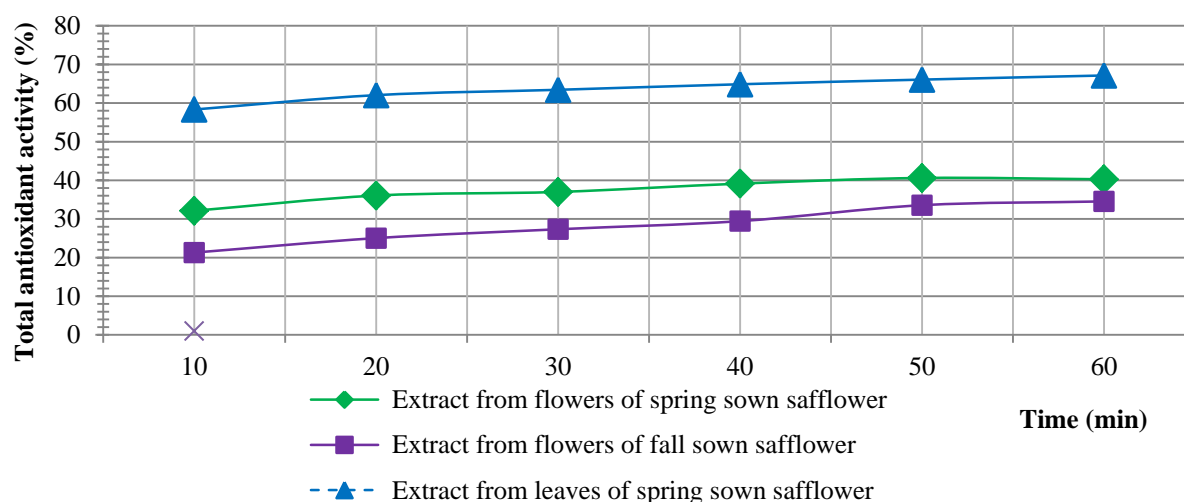

Figure 5 The dependence of the total antioxidant activity of the safflower extracts on the time.

Table 2 The generalized table of the measure of the total antioxidant activity of the extracts of bee bread and safflower.

Number of sample	Volume of extract (mL)	Volume of dilution of an extract 1:5 (mL)	Total antioxidant Activity (%)	The initial absorbance of DPPH	Content of ascorbic acid equivalents, mg in 1 mL a extract	Average content of ascorbic acid equivalents, mg in 1 g of raw material
Bee bread						
1	0.05	-	82.39	0.589	0.34 ¹	0.033
			78.76	0.612	0.32 ¹	
3	0.05	-	35.88	0.589	0.10 ¹	0.009
			33.61	0.612	0.08 ¹	
7	-	0.05	70.91	0.466	1.05 ²	0.210
			80.51	0.471	1.17 ²	
8	-	0.05	64.25	0.592	1.25 ¹	0.250
			68.64	0.587	1.35 ¹	
9	-	0.05	78.26	0.576	1.60 ¹	0.280
			82.10	0.531	1.20 ¹	
10	-	0.05	45.15	0.638	0.75 ¹	0.150
			46.89	0.604	0.75 ¹	
11	-	0.05	47.33	0.638	0.80 ¹	0.155
Safflower						
flowers of spring sown safflower	0.05	-	40.27	0.576	0.12 ¹	0.024
flowers of fall sown safflower	0.05	-	34.54	0.587	0.09 ^{1*}	0.022
			42.41	0.466	0.13 ^{2*}	
leaves of spring sown safflower	0.05	-	67.14	0.592	0.26 ¹	0.026
			71.46	0.471	0.21 ^{2*}	
leaves of fall sown safflower	0.05	-	65.34	0.511	0.20 ^{2*}	0.020
			63.18	0.513	0.19 ^{2*}	

Note: * – average $0.11 \text{ mg.mL}^{-1} (0.09 + 0.13)/2$; ** – average $0.20 \text{ mg.mL}^{-1} (0.21 + 0.20 + 0.19)/3$.

1 – calculations were conducted using $y_1 = 188.44x + 17.747$; 2 – calculations were conducted using $y_2 = 390.38x + 11.159$.

spring sown safflower (40.27%), flowers of fall sown safflower (34.54 – 42.41%), and bee bread of batch 1 (82.39 – 78.76%) and 3 (33.61 – 35.88%).

The results of AA equivalents in 1 mL of an extract for all the safflower extracts occupy the intermediate place between ones for the two batches of bee bread 1 and 3. Table 2 also demonstrates that the extracts prepared from

granules of the same example of bee bread have insignificant distinguished results. The slight difference could be explained by pollen collection from different flowers in the same time and analysis deviation as well.

CONCLUSION

In conclusion, the results of this investigation confirm that bee bread and safflower are sources rich in compounds with antioxidant properties. The best results were observed for the samples of bee bread with a shorter time of storage. The further studies will be directed on the establishment of correlation of the total antioxidant activity and total phenolic contents and flavonoids.

REFERENCES

Asgarpanah, J., Kazemivash, N. 2013. Phytochemistry, pharmacology and medicinal properties of *Carthamus tinctorius* L. *Chinese Journal of Integrative Medicine*, vol. 19, no. 2, p.153-159. <https://doi.org/10.1007/s11655-013-1354-5> PMID:23371463

Baba, S. A., Malik, S. A. 2015. Determination of total phenolic and flavonoids content, antimicrobial and antioxidant activity of a root extract of *Arisaema jacquemontii*. *Journal of Taibah University for Science*, vol. 9, no 4, p. 449-454. <https://doi.org/10.1016/j.jtusci.2014.11.001>

Barene, I., Daberte, I., Siksná, S. 2015. Investigation of bee bread and development of its dosage forms. *Medicinos teorija ir praktika*, vol 21, no 1, p. 16-22.

Bogdanov, S. 2016. Pollen: Production, Nutrition and Health: A Review [online] s. a. [cit. 2017-02-01]. Available at: <http://www.bee-hexagon.net>.

Čeksterytė, V., Kurtinaitienė, B., Venskutonis, P. R., Pukalskas, A., Kazemavičiūtė R., Balžekas, J. 2016. Evaluation of antioxidant activity and flavonoid composition in differently preserved bee products. *Czech Journal of Food Science*, vol. 34, no. 2, p. 133-142. <https://doi.org/10.17221/312/2015-CJFS>

Brindza, J., Brovarskyi, V. 2013. *Pollen and bee pollen of some plant species*. Kyiv : Korsunskiy vidavnychiy dim Vsesvit, 137 p. ISBN 978-80-552-1073-5.

Brovarskij, V., Brindza, J. 2010. *Včelí obnůžkový pel'*. 1st ed. Kyjev : FOP I. S. Maidachenko, 290 p. ISBN 978-966-8302-31-2.

Eswaran, V. U., Bhargava, H. R. 2014. Chemical analysis and anti-microbial activity of Karnataka bee bread of apis species. *World Applied Sciences Journal*, vol. 32, no 3, p. 379-385.

Carmona-Jiménez, Y., García-Moreno, M. V., Igartuburu, J. M., Garcia Barroso, C. 2014. Simplification of the DPPH assay for estimating the antioxidant activity of wine and wine by-products. *Food Chemistry*, vol. 165, p. 198-204. <https://doi.org/10.1016/j.foodchem.2014.05.106> PMID:25038667

Fadda, A., Serra, M., Molinu, M. G., Azara, E., Barberis, A., Sanna, D. 2014. Reaction time and DPPH concentration influence antioxidant activity and kinetic parameters of bioactive molecules and plant extracts in the reaction with the DPPH radical. *Journal of Food Composition and Analysis*, vol. 35, no. 2, p. 112-119. <https://doi.org/10.1016/j.jfca.2014.06.006>

Gálik, B., Bíro, D., Šimko, M., Juráček, M., Capcarová, M., Kolesárová A., Rolínek, M., Toman, R., Kanka, T. 2016. The effect of dietary bee pollen intake on growth performance and biochemical indicators of rats. *Acta Veterinaria Brno*, vol. 85, no 1, p. 99-104. <https://doi.org/10.2754/avb201685010099>

Gautam, S., Bhagyawant, S. S., Srivastava, N. 2014. Detailed study on therapeutic properties, uses and pharmacological applications of safflower (*Carthamus tinctorius* L.). *International Journal of Ayurveda and Pharma Research*, vol. 2, no 3, p. 5-16.

Hudz, N. I., Ivanova, R. A., Šimkova, J. 2016. Study of antioxidant activity as a stage in the development of herbal preparations. In *Modern achievements of pharmaceutical technology and biotechnology: Scientific proceedings*. Kharkow, Ukraine, pp.182-185.

Hudz N., Rehletska A., Filipiska A., Vorobets N. 2015. Problems of standartization of bee pollen and bee bread as bioactive components. *Scientific Bulletin of National University of life and Environmental Sciences of Ukraine. Set "Technology of production and processing of livestock products"*, vol. 223, p. 96-103.

Ivanišová, E., Kačániová, M., Frančáková, H., Petrová, J., Hutková, J., Brovarskyi, V., Velychko, S., Adamchuk, L., Schubertová, Z., Musilová, J. 2015. Bee bread – perspective source of bioactive compounds for future. *Potravinárstvo*, vol. 9, no 1, p. 592-598. <https://doi.org/10.5219/558>

Ivanova, P., Casian, I., Casian, A. 2016. Secondary metabolites accumulation in safflower of fall and spring sowing in the Republic of Moldova. In *Sustainable utilisation of plant genetic resources for agriculture and food*. Piestany, Slovak Republic : National Agricultural and Food Centre, p. 68. ISBN 978-80-89417-69-8.

Kharisova, A. V. 2014. *Pharmacognostical investigation of safflower (Carthamus tinctorius L.)* : dissertation theses. Russia : University of Samara. 360 p.

Kuşoğlu, E., Kahraman, S. 2015. Total phenolic content and radical scavenging activity of *Carthamus tinctorius* L. *International Journal of Electronics, Mechanical and Mechatronics Engineering*. vol. 5, no 2, p. 943-947.

Lee, J. Y., Chang, E. J., Kim, H. J., Park, J. H., Choi, S. W. 2002. Antioxidative flavonoids from leaves of *Carthamus tinctorius*. *Archives of Pharmacal Research*, vol. 25, no 3, p. 313-319.

Matthaus, B., Ozcan, M. M., Al Juhaimi, F. Y. 2015. Fatty acid composition and tocopherol profiles of safflower (*Carthamus tinctorius* L.) seed oils. *Natural Product Research*, vol. 29, no 2, p. 193-196. <https://doi.org/10.1080/14786419.2014.971316> PMID:25329876

Markievicz-Žukovska, R., Naliwajko, S. K., Bartosiuk, E., Moskwa, J., Isidorov, V., Soroczyńska, J., Borawska M. 2013. Chemical composition and antioxidant activity of bee bread, and its influence on the glioblastoma cell line (U87MG). *Journal of Apicultural Science*, vol. 57, no 2, p. 147-157.

Meda, A., Lamien, C. E., Romito, M., Millogo, J., Nacoulma, O. G. 2005. Determination of the total phenolic, flavonoid and proline contents in Burkina Fasan honey, as well as their radical scavenging activity. *Food Chemistry*, vol. 91, no. 3, p. 571-577. <https://doi.org/10.1016/j.foodchem.2004.10.006>

Nicklisch, S. C. T., Waite, J. H. 2014. Optimized DPPH assay in a detergent-based buffer system for measuring antioxidant activity of proteins. *MethodsX*, vol. 1, p. 233-238. <https://doi.org/10.1016/j.mex.2014.10.004>

Petrie, S., Machado, D., Johnson, R., Prichett, L., Rhinhart, K., Tuck, B. 2010. Adaptation and yield of spring and fall sown safflower in Northeastern Oregon. Columbia Basin Agricultural Research Center Dryland Research Report 101. Oregon State University, USA. [online] s.a. [cit. 2017-02-19] Available at: http://cbarc.aes.oregonstate.edu/sites/default/files/adaptation_and_yield_of_spring_and_fall_sown_safflower_in_northeastern_oregon.pdf.

Anonym, 2009. Phytochemical analysis of plant raw material containing flavonoids. Chapter: Chemical analysis of medicinal plants. 2009. Methodological Guide in Pharmacognosy. Irkutsk, 67 p.

Rzepecka-Stojko, A., Stojko, J., Kurek-Górecka, A., Gorecki, M., Kabala-Dzik, A., Kubina, R., Mozdziej, A., Buszman, E. 2015. Polyphenols from bee pollen: structure, absorption, metabolism and biological activity. *Molecules*, vol. 20, no 12, p. 21732-21749. <https://doi.org/10.3390/molecules201219800> PMID:26690100

Salem, N., Msaada, K., Hamdaoui, G., Limam, F., Marzouk, B. 2011. Variation in phenolic composition and antioxidant activity during flower development of safflower (*Carthamus tinctorius* L.). *Journal of Agricultural and Food Chemistry*, vol. 59, no 9, p. 4455-4463. <https://doi.org/10.1021/jf1049936> PMID:21434653

Silva, G. R., Natividade, T. B., Camara, C. A., Silva, E. M. S., Assis Ribeiro dos Santos, F., Silva, T. M. S. 2014. Identification of sugar, amino acids and minerals from the pollen of Janaira Stingless Bees (*Melipona subnitida*). *Food and Nutrition Sciences*, vol. 5, no 11, p. 1015-1021. <https://doi.org/10.4236/fns.2014.51112>

Treutter, D. 2010. Managing phenol contents in crop plants by phytochemical farming and breeding – visions and constraints. *International Journal of Molecular Science*, vol. 11, p. 807-857. <https://doi.org/10.3390/ijms11030807> PMID:20479987

Yu, S. Y., Lee, Y. J., Kim, J. D., Kang, S. N., Lee, S. K., Jang, J. Y., Lee, H. K., Lim J. H., Lee, O. H. 2013. Phenolic composition, antioxidant activity and anti-adipogenic effect of hot water extract from safflower (*Carthamus tinctorius* L.) seed. *Nutrients*, vol. 5, no 12, p. 4894-4907. <https://doi.org/10.3390/nu5124894> PMID:24288028

Yue, S., Tang, Y., Li, S., Duan, J. A. 2013. Chemical and biological properties of quinochalcone C-glycosides from the florets of *Carthamus tinctorius*. *Molecules*, vol. 18, no. 12, p.15220-15254. <https://doi.org/10.3390/molecules181215220> PMID:24335575

Ukrainian standard 7074:2009. 2010. Kyiv, p. 1-11 p.

Zhao, M., Ito, Y., Tu, P. 2005. Isolation of a novel flavanone 6-glucoside from the flowers of *Carthamus tinctorium* (Honghua) by high-speed counter-current chromatography. *Journal of Chromatography A*, vol. 1090, no. 1-2, p. 193-196. <https://doi.org/10.1016/j.chroma.2005.07.010> PMID:16196150

Zhang, L. L., Tian, K., Tang, Z. H., Chen, X. J., Bian, Z. X., Wang, Y. T., Lu, J. J. 2016. Phytochemistry and Pharmacology of *Carthamus tinctorius* L. *The American Journal of Chinese Medicine*, vol. 44, no 2, p. 197-226. <https://doi.org/10.1142/S0192415X16500130> PMID:27080938

Zhou, X., Tang, L., Xu, Y., Zhou, X., Wang, Z. 2014. Towards a better understanding of medicinal uses of *Carthamus tinctorius* L. in traditional Chinese medicine: a phytochemical and pharmacological review. *Ethnopharmacol.*, vol. 151, no 1, p. 27-43. <https://doi.org/10.1016/j.jep.2013.10.050> PMID:24212075

Zhou, Y. Z., Ma, H. Y., Chen, H., Qiao, L., Yao, Y., Cao J. Q., Pei Y. H. 2006. New acetylenic glucosides from

Carthamus tinctorius. *Chemical and Pharmaceutical Bulletin*, vol. 54, no 10, p. 1455-1456. <https://doi.org/10.1248/cpb.54.1455>

Zubkov, V. V., Milyokhin, A. V., Kurkin, V. A., Kharisova, A. V., Platonov, I. A., Pavlova, L. V. 2014. Prospects of safflower seeds oil in food and pharmaceutical industry. *Bulletin of the Samara Scientific Center*, vol. 16, no 53, p. 1135-1139.

Zuluaga, C. M., Serrato, J. M., Quicazan, M. C. 2015. Chemical, Nutritional and Bioactive Characterization of Colombian Bee-Bread. *Chemical Engineering Transactions*, vol. 43, p. 175-180.

Acknowledgments:

The publication was prepared with the active participation of researchers from international network AGROBIONET, as a part of international program "Agricultural biodiversity to improve nutrition, health and quality of life" within the project ITEBIO-ITMS 26220220115 „Support of technologies innovation for special bio-food products for human healthy nutrition“.

Natalia Hudz (51600967) and Raisa Ivanova (51600341) are thanking to the International Visegrad Scholarship Fund for the realization of research at Institute of Biodiversity Conservation and Biosafety. Experimental activities were realized in laboratories of excellent Center for the conservation and use of agrobiodiversity at the Faculty of Agrobiological and Food Resources, Slovak Agricultural University in Nitra.

Contact address:

Mgr. Nataliia Hudz, PhD., Danylo Halytsky Lviv National Medical University, Department of Drug Technology and Biopharmaceutics, Pekarska, 69, 79010, Lviv, Ukraine, E-mail: natali_gudz@ukr.net

Mgr. Raisa Ivanova, PhD., Institute of Genetics, Physiology and Plant Protection, Academy of Sciences of Moldova, 20 Padurii Street, Chisinau MD-2002, Republic of Moldova, E-mail: ivanova_raisa@yahoo.com

Doc. Ing. Ján Brindza, PhD., Slovak University of Agriculture in Nitra, Faculty of Agrobiological and Food Resources, Institute of Biological Conservation and biosafety, Trieda Andreja Hlinku 2, 949 76 Nitra, Slovakia, E-mail: Jan.Brindza@uniag.sk

Mgr. Olga Grygorieva, PhD., M. M. Gryshko National Botanical Garden of Ukraine National Academy of Sciences, Timiryazevska 1, 01014 Kyiv, Ukraine, E-mail: ogrygorieva@mail.ru

Ing. Zuzana Schubertová, PhD., Slovak University of Agriculture in Nitra, Faculty of Agrobiological and Food Resources, Institute of Biological Conservation and biosafety, Trieda Andreja Hlinku 2, 949 76 Nitra, Slovakia, E-mail: zuzana.schubertoval@uniag.sk

Ing. Eva Ivanišová PhD., Slovak University of Agriculture in Nitra, Faculty of Biotechnology and Food Resources, Department of Plant Storage and Processing, Trieda Andreja Hlinku 2, 949 76 Nitra, Slovakia, E-mail: eva.ivanisova@uniag.sk



WINTER SQUASH (*CUCURBITA MOSCHATA* DUCH) FRUIT AS A SOURCE OF BIOLOGICALLY ACTIVE COMPONENTS AFTER ITS THERMAL TREATMENT

Andrea Mendelová, Ľubomír Mendel, Martina Fikselová, Ján Mareček, Alena Vollmannová

ABSTRACT

To one of the most valuable pumpkin fruit belongs winter squash (*Cucurbita moschata* Duch). The aim of this work was to assess the quality of *C. moschata* fruit and to assess the dynamics of compositional changes after the heat treatment of the pulp. We used six varieties Liscia, Orange, Hannah, UG 201 F1, Waltham, Serpentine. In the samples were analyzed carbohydrate content (glucose, fructose and sucrose), total polyphenols, total carotenoids and antioxidant activity. The fresh pulp and pulp after the heat treatment were observed. Content of carbohydrates was determined by FTIR infrared spectroscopy. Content of total carotenoids, polyphenols and antioxidant activity was determined by spectrophotometry. As the dominant sugar was found to be sucrose. The lowest content of all carbohydrates was found in the variety Serpentine. Fructose content ranged from 7.59 to 12.32 g.100 g⁻¹ dry matter, glucose content from 7.23 to 9.79 g.100 g⁻¹ dry matter and sucrose content 38.67 to 55.94 g.100 g⁻¹ dry matter. After processing there was found a decrease in the sucrose and the slight increase in glucose and fructose content. Total carotenoid content in fruits ranged from 39.01 to 97.67 g mg.100 g⁻¹ dry matter, the content of total polyphenols from 443.98 to 565.44 mg GAE.100 g⁻¹ dry matter and antioxidant activity from 680.18 to 851.87 mg AA.100 g⁻¹ dry matter. After the heat treatment, there was found some decrease in total carotenoids, polyphenols and antioxidant activity as well.

Keywords: winter squash; total carotenoid; total polyphenols; antioxidant activity

INTRODUCTION

Recently, it is increasing interest about the use of less known vegetable species as potential sources of raw materials and biologically active substances for agricultural, pharmaceutical and food applications. New sources of agricultural raw materials are the subject of research, which would positively affect nutritional trends and reduce the frequency of lifestyle disease occurrence. Such vegetables include *Cucurbita moschata* Duch (Kim et al., 2012). Pumpkins are considered to be the one of the possible alternative foods in developing countries (Agbagwa and Ndukwu, 2004). By FAOSTAT (2014) on the average world production of pumpkins are mostly involved Asia (61.6%), Europe (16.3%), America (11.7%), Africa (8.9%) and Oceania (1.4%).

The pumpkin of the *Cucurbitaceae* family is widely grown and consumed in many countries around the world (Jun et al., 2006). Some varieties such as *C. moschata*, *C. maxima* and *C. pepo*, range in colour from intense yellow to orange and have revealed high levels of carotenoids, mainly α and β -carotene, β -cryptoxanthin, lutein and zeaxanthin (Boiteux et al., 2007; Rodriguez-Amaya et al., 2008). This vegetable plant was very popular due to its usefulness in providing health (Kim et al., 2012). The

major factors of nutritional and medicinal value of pumpkin fruit are high total content of carotenoids with >80% of β -carotene (Azevedo-Meleiro and Rodriguez-Amaya, 2007; Kurz et al., 2008) as well as pectin and polysaccharides, minerals (potassium, phosphorus, magnesium, iron, and selenium), vitamins (C, E, K, thiamine (B1) and riboflavin (B2), piridoxine (B6)), dietary fiber, phenolic compounds (flavonoids, phenolic acids) and other substances beneficial to human health (Sharma and Rao, 2013; Nawirska-Olszanska et al., 2014; Zhou et al., 2014). Because of the high content of carbohydrates and fibre, this vegetable plant has been implemented as a valuable source of dietary fibre. It may decrease the serum cholesterol level, the risk of coronary heart disease, and hypertension (Hussain et al., 2010). The seed which is known to have high amount of zinc, has been used in treating the early stages of prostate problem (Pandya and Rao, 2010).

Conserving and processing of pumpkin is reported as a common way of pumpkin processing: processing into jams, puree, juice pickles and dried products and it is also used as a base for soups and desserts (Provesi et al., 2012; Assous et al., 2014). Podsedek (2007) report that during the cooking of vegetables, bioactive substances are

degraded and there is absorption of water, which results in the dilution of the active ingredients.

The aim of this work was to compare the quality of selected varieties of winter squash and assessing the impact of heat treatment on the dynamics of changes in carbohydrates, total carotenoids, polyphenols and antioxidant activity.

MATERIAL AND METHODOLOGY

We used six varieties of winter squash: Liscia, Orange, Hannah, UG 201 F1, Waltham, Serpentine, which were cultivated as a part of research of the Department of Vegetable Production at the Faculty of Horticulture and Landscape Engineering, SUA Nitra. Area is situated at an altitude of 144 m n. m. In terms of climatic conditions it belongs to the agro-climatic very warm macro-region, which is characterized by the sum of average temperatures for the main growing season (TS 10) higher than 3000 °C, with an average annual temperature of 9 to 10.2 °C, an average annual rainfall is 595 mm and an average annual amount of sunshine 2079 hours; agro-climatic sub-region is very dry with indication of irrigation in the summer months more than 150 mm and agro-climatic district of mostly mild winter ($T_{\min} > -18$ °C) (Špánik et al., 2008). In terms of soil characteristics, soil is a glue fluvisol formed on alluvial sediments.

Studied varieties belong to the group of medium early to medium-late with maturing from mid-September. Hannah variety, UG 201 F1, Liscia and Waltham have pear-shaped fruits with solid orange pulp. Varieties Serpentine and Orange have softer pulp, more fibrous. Variety Orange has regular pear shape and deep orange pulp, variety Serpentine has clubbed shape and orange color flesh. Fruit harvest was performed at the stage of technical maturity when the fruits were colored and had a solid, hard skin. The average samples for analysis of monitored indicators from various parts of the fruit, free from skins and seeds were homogenized to homogeneous mass. The samples were then analyzed in the fresh matter and exposed to the effect of heat treatment in a water bath at 90 °C for 15 minutes.

Total carotenoid content expressed as beta-carotene was analyzed at a wavelength of 445 nm spectrophotometrically (VIS spectrophotometer UV Jenway Model 6405 UV / VIS). Sample (1 g) was disrupted with sea sand and extracted with acetone until complete discoloration. Petroleum-ether was added and then water, in purpose to separation of phases. After the separation the petroleum-ether-carotenoid phase was obtained and the absorbance was measured (ČSN 560053, 1986).

Polyphenolic compounds were determined by spectrophotometry at the wavelength of 700 nm by the method of Folin-Ciocalteu (Singleton and Rossi, 1965) and expressed as gallic acid equivalent. The method is based on the reaction of Folin-Ciocalteu reagent with polyphenols, with formation of blue color. The intensity of the color is proportional to the content of polyphenols. The sample was extracted into water (at speed 200 min⁻¹ for 24 h). The prescribed amount of filtrate is then mixed with the Folin-Ciocalteu agent and sodium carbonate to form a blue color.

The antioxidant activity was determined by the FOMO method (Prieto et al., 1999). The principle of the method

is the reduction of Mo (VI) to Mo (V) by the effect of reducing compounds in the presence of phosphorus. Resulting is green phosphomolybdate complex, the intensity of the color is measured spectrophotometrically at the wavelength 695 nm. The reducing ability of the compounds is expressed as the amount of ascorbic acid (AA) that is required to achieve the same reduction effect. The prepared extract in an amount of 1 ml was mixed with 2.8 ml of potassium dihydrogen phosphate, 6 ml sulfuric acid, 0.4 ml of ammonium molybdate and 0.8 mL of water. The solution was put in a water bath at 90 °C for 2 hours. After cooling it was analyzed spectrophotometrically.

Determination of selected carbohydrates was performed at Alpha Bruker Optik GMBH analyzer. The device works on the principle of FTIR infrared spectroscopy. The fruit juice was centrifuged and subsequently analyzed.

The results were processed by statistical program Statistica. The differences among the samples were observed by the Tukey HSD test.

RESULTS AND DISCUSSION

Loy (2004) reported that the pumpkin contains up to 70% carbohydrates in the dry matter after harvest. While in the immature fruit prevails starch by approx. 58%, in the ripe fruit its content decreases and the dominant are simple sugars and sucrose. In our work among the observed carbohydrates the highest content was determined to be in sucrose, which is 5 – 7 times higher than the glucose and fructose (Table 1). The highest sucrose content was found in variety Liscia (55.94 g.100 g⁻¹ DM) and the lowest in variety Serpentine (38.67 g.100 g⁻¹ DM). Variety Serpentine showed among the varieties the lowest content of all carbohydrates observed. The highest fructose content we found at variety Hannah (12.32 g.100 g⁻¹ DM) and glucose content was the highest in variety Orange (9.79 g.100 g⁻¹ DM).

Content of carbohydrates in fruits of winter squash, varieties Bokor and Kelenting was observed by Suranto et al. (2015). The fresh matter of Bokor variety contained 88.2% water, 9.16% carbohydrates, 1.45% proteins, 0.24% fat and 0.94% minerals. Kelenting variety was characterized by higher carbohydrate content, 10.88%. Our monitored varieties of winter squash contained water by 93.5% in the variety Serpentine to 89.2% in Waltham variety. Carbohydrates expressed per fresh matter ranged from 3.77% (Serpentine) to 7.82% (Liscia), varieties with higher carbohydrates were Liscia, Waltham and UG 205 F1.

Atef et al. (2012) investigated the carbohydrate content in different kinds of fruit and vegetable juices. In the pumpkin juice they found 5.94% carbohydrates, 11.68% in orange juice, in carrot juice 8.48% and in lemon juice 9.19%. They also compared the carbohydrate content in the pumpkin and apricot puree and its content was higher in the apricot puree, where the authors state 11.26%, while in the pumpkin puree 7.09%. Content of carbohydrates in the pumpkin puree is comparable with our results.

Iacuzzo and Dalla Costa (2009) reported the carbohydrate content in the fruit of winter squash in the amount of 6.3 to 8.7 mg. 100 g⁻¹ FW. Conti et al. (2015) compared the carbohydrate content in the fruit cultivated under field conditions and under greenhouse. Evaluation was performed in northern Italy and variety Waltham was

Table 1 Content of saccharides in the pulp of winter squash fruit.

Variety	fructose		glucose		sucrose		dry matter %
	g.100 g ⁻¹	g.100 g ⁻¹	g.100 g ⁻¹	g.100 g ⁻¹	g.100 g ⁻¹	g.100 g ⁻¹	
	FM	DM	FM	DM	FM	DM	
Serpentine	0.79	7.59 ^a	0.47	7.23 ^a	2.51	38.67 ^a	8.4
Waltham	1.05	9.69 ^b	0.99	9.23 ^e	5.41	50.09 ^c	13.3
Orange	0.96	10.18 ^c	0.92	9.79 ^f	4.42	46.99 ^b	12.0
Liscia	1.09	10.41 ^d	0.86	8.16 ^c	5.87	55.94 ^f	13.6
UG 205 F1	1.12	10.57 ^e	0.93	8.74 ^d	5.58	52.64 ^d	12.5
Hannah	0.85	12.32 ^f	0.53	7.73 ^b	3.81	55.27 ^e	8.6

Note: Means marked with the same letter are not statistically significantly different at $p \leq 0.05$.

used. They found that under field conditions glucose and fructose were more synthesized compared to greenhouse. The difference in sucrose content in fruits was less visible. The glucose content in fruits from outdoor (field) cultivation was 6.64 g. 100 g⁻¹ DW, fructose content was 5.23 g.100 g⁻¹ DW and sucrose content 39.56 mg. 100 g⁻¹, which are the results in lower amount compared to variety Waltham in our work.

After the heat treatment of the pumpkin pulp, we found a decrease in the sucrose content, an increase in glucose and fructose content (Table 2). All changes that occurred by heat treatment based on the results of multifactor analysis of variance were statistically significant (Table 3).

As reported several authors fruits of winter squash are characterized by the presence of the contents of various bioactive substances, in particular carotenoids. **Murkovic et al. (2002)** state that in pumpkin pulp, β -carotene, α -carotene and lutein are present. **Azevedo-Meleiro and Rodriguez-Amaya (2007)** investigated the dominant carotenoids in three species of the genus Cucurbita. *Cucurbita moschata* contains β - and α -carotene, in hybrid varieties was found lutein as well. *Cucurbita pepo* and *Cucurbita maxima* showed especially lutein and β -carotene content. **Provesi et al. (2011)** reported that beside dominant β - and α -carotenes in fruits as minor are represented lutein, violaxanthine, ζ -carotene.

Content of total carotenoids expressed as β -carotene was observed in our samples from 4.10 mg.100 g⁻¹ FM in variety Liscia to 9.18 mg.100 g⁻¹ in Orange variety. Converting this content per dry matter, we found that among all samples are statistically significant differences, the highest value is confirmed by variety Orange (97.67 mg.100 g⁻¹ DM) and the lowest in variety Liscia (39.01 mg.100 g⁻¹ DM). Higher content of total carotenoids we found in the sample Hannah (92.42 mg.100 g⁻¹ DM) and low in the sample UG 205 F1 (56.55 mg.100 g⁻¹ DM) (Table 4).

In studies of **Andrejiová et al. (2014)** the content of total carotenoids in pumpkin pulp of variety Orange was detected 15.10 mg.100 g⁻¹ FW and in variety Liscia 9.33 mg.100 g⁻¹ FW. They state that after 6 months of storage, the total content of carotenoids increased, and ranged from 14.27 to 31.87 mg.100 g⁻¹.

Kurz et al. (2008) observed the content of carotenoids in fruits of pumpkins cultivated in Germany and found that α -carotene content was from 0.058 to 1.06 g mg.100g⁻¹ and β - carotene content ranged from 0.90 to 1.14 mg.100g⁻¹. **Murkovic et al. (2002)** observed the content of carotenoids cultivated in Austria and the highest carotenoid content was determined in variety Long Island Cheese, 5.9 mg.100 g⁻¹ FW of α -carotene, 7.0 mg.100 g⁻¹ of β -carotene and 0.14 g mg.100 g⁻¹ lutein. **Jaswir et al.**

Table 2 Content of saccharides in the pulp of winter squash fruit after heat treatment.

Variety	glucose		fructose		sucrose	
	g.100 g ⁻¹	g.100 g ⁻¹	g.100 g ⁻¹	g.100 g ⁻¹	g.100 g ⁻¹	g.100 g ⁻¹
	FM	DM	FM	DM	FM	DM
Hannah	0.84	9.80	1.26	14.69	3.97	46.12
UG 205 F1	1.21	9.68	1.57	12.13	5.74	45.95
Liscia	1.25	9.16	1.43	10.52	6.07	44.63
Waltham	1.35	10.18	1.41	10.60	5.34	40.18
Orange	1.22	10.14	1.29	10.78	4.65	38.72
Serpentine	0.82	9.76	0.79	9.41	2.73	32.460

Table 3 The average content of carbohydrates (g.100 g⁻¹ DM) in fresh pulp and after heat treatment in winter squash and homogeneous groups based on the multifactor analysis.

Saccharide	form	number of measurements	mean	Homogeneous group
fructose	fresh	18	10.12	a
	heat treatment	18	11.35	b
glucose	fresh	18	84.79	a
	heat treatment	18	97.88	b
sucrose	fresh	18	49.93	b
	heat treatment	18	41.34	a

Note: Means marked with the same letter are not statistically significantly different at $p \leq 0.05$

Table 4 Total carotenoids, polyphenols and antioxidant activity in pulp of winter squash fruit.

Variety	Total carotenoids		Total polyphenols		Antioxidant activity	
	mg.100 g ⁻¹	mg.100 g ⁻¹	mg GAE.100 g ⁻¹	mg GAE.100 g ⁻¹	mg AA.100 g ⁻¹	mg AA.100 g ⁻¹
	FM	DM	FM	DM	FM	DM
Liscia	4.10	39.01 ^a	46.61	443.98 ^a	85.71	816.34 ^c
Orange	9.18	97.67 ^f	42.01	446.93 ^a	63.93	680.18 ^a
UG 205 F1	5.99	56.55 ^b	48.45	457.11 ^b	87.98	829.96 ^{cd}
Waltham	8.07	74.76 ^d	50.02	463.21 ^c	92.00	851.87 ^d
Serpentine	4.33	66.57 ^c	32.50	499.98 ^d	46.90	721.58 ^b
Hannah	6.38	92.42 ^e	39.01	565.44 ^e	56.34	816.49 ^c

Note: Means marked with the same letter are not statistically significantly different at $p \leq 0.05$

GAE – gallic acid equivalent, AA – ascorbic acid equivalent.

(2014) monitored the content of β -carotene in winter squash cultivated in Malaysia area harvested at different times during the year. The highest carotenoid content was found in fruits harvested in February, the lowest content in the fruit harvested in November, mean content was found in June. The β -carotene content in fruits grown in Malaysia ranged from 1.52 to 4.14 mg.100 g⁻¹ fresh matter, which is comparable with our results.

Similarly high levels of total carotenoids are given by **Jacobo-Valenzuela et al. (2011)**, who analyzed the fruits grown in Mexico and state that the average content of total carotenoids in variety Cehualca was 2.67 mg.100 g⁻¹. Content of total carotenoids in variety Menina Brasileira harvested in Brazil evaluated **Provesi et al. (2012)** and determined the content 3.77 mg.100 g⁻¹. **Iacuzzo and Dalla Costa (2009)** observed carotenoids in varieties Red Kury, Tan Chesse and Kabosha grown in southern Italy. Content of carotenoids detected in the amount of 7.6 mg.100 g⁻¹ FM was found to be in variety Red Kury and low levels 1.1 to 1.5 mg.100 g⁻¹ in varieties Kabosha and Tan Chesse.

After the heat treatment, the amount of total carotenoids decreased (Table 5). Based on the results of multifactor analysis of variance, we found that this difference was statistically significant. The average decrease of total carotenoids after heat treatment was 37.19%.

Azizah et al. (2009) performed the experiment with a short heat treatment of pumpkin in boiling water at 100 °C and frying at 170 °C for 1 – 6 minutes. At cooking they found that by the prolongation of the time the β -carotene content of the pulp decreases, but at frying by the extension of the time up to 6 minutes, the β -carotene content was getting higher. They explain their results by using of a frying oil that leads to better solubility of the carotenoids. They also show better bioavailability of carotenoids due to the degradation of cellulose during the heat treatment.

Provesi et al. (2011) report that under the heat treatment there is a reduction of carotenoid content in the pumpkin puree, retention of the content of carotenoids as a whole can be up to 75%, this result corresponds with our results. Authors state that the decrease occurs primarily in the content of xanthophylls, which contain in the structure one or two molecules of oxygen and can be due to the heat treatment completely degraded (especially xanthophylls, which can be completely degraded. This group of carotenoids has one or more oxygen groups in its structure, has lower stability during processing and storage). High

stability during processing showed α -carotene and all-trans- β -carotene.

Zdunić et al. (2016) processed the pumpkin into various food products, such as pumpkin jam, pumpkin sweet wine or pumpkin juice. They show that during processing in each product, the decrease of the content of total carotenoids is observed. The smallest decrease only 30% was recorded in the production of pumpkin jam, while a significant decrease occurred in the processing of pumpkin into sweet wine and the juice, where the carotenoid content decreased by 70%. Also **Caili et al. (2006)** report that the decrease in carotenoids in pumpkin products is greatly affected mainly by technological process of production and especially by the use of heat treatments. **Provesi and Amante (2015)** state that processing of the pumpkin can cause oxidation or isomerisation of carotenoids, which affect the biological activity and color of the products. The most important factors leading to the loss of carotenoids include the temperature, contact with oxygen and light.

Content of polyphenolic compounds and antioxidant activity are the parameters, between which there is usually a strong correlation dependence (**Zdunić et al., 2016**). **Zdunić et al. (2016)** observed the identification of phenolic compounds in winter squash and in the fruit they described seven compounds. As dominant were protocatechuic acid and chlorogenic acid. **Dragovic-Uzelac et al. (2005)** reported the presence of chlorogenic acid in fruits of *C. pepo*, *C. maxima* and *C. moschata*. **Zdunić et al. (2016)** indicate the presence of hesperidin in the fruit, that occurs mainly in citrus fruits and has strong antioxidant, anti-inflammatory and anti-cancer activity (**Manthey et al., 2001; Wilmsen et al., 2005**). Eriodictyol 7-neohesperidoside is also another group of polyphenolic compounds, which in winter squash was detected by **Zdunić et al. (2016)** and is considered as a powerful antioxidant. In small amounts they reported the presence of salicylic acid, p-hydroxybenzoic acid and p-coumaric.

The total content of polyphenolic substances in our samples ranged from 443.98 mg GAE.100 g⁻¹ to 565.44 mg GAE.100 g⁻¹. The results of antioxidant activity ranged in our samples from 680.18 mg AA.100 g⁻¹ to 851.89 mg AA.100 g⁻¹. The lowest content of total polyphenols we found in varieties Liscia and Orange, between them no statistically significant difference was detected. Liscia variety is also characterized by low content of carotenoids, in contrast to the variety Orange, that by the content of carotenoids dominated among evaluated varieties. The highest polyphenol content we found at variety Hannah, that is variety belonging to the

Table 5 Content of total carotenoids, polyphenols and antioxidant activity in pulp of winter squash fruit after heat treatment.

Variety	Total carotenoids		Total polyphenols		Antioxidant activity	
	mg.100 g ⁻¹	mg.100 g ⁻¹	mg GAE.100 g ⁻¹	mg GAE.100 g ⁻¹	mg AA.100 g ⁻¹	mg AA.100 g ⁻¹
	FM	DM	FM	DM	FM	DM
Liscia	3.93	28.90	42.53	312.76	87.03	639.92
Orange	7.18	59.81	34.71	289.24	78.47	653.94
UG 205 F1	5.58	44.63	40.10	320.81	87.02	696.58
Waltham	6.5	48.85	49.24	370.23	87.16	655.31
Serpentine	2.82	33.58	18.19	216.56	47.47	565.09
Hannah	3.72	43.26	23.55	273.81	59.98	697.46

GAE- gallic acid equivalent, AA- ascorbic acid equivalent.

Table 6 The average content of total carotenoids, polyphenols and antioxidant activity in pulp of winter squash fruit and after heat treatment and homogeneous groups based on the multifactor analysis.

Parameter	form	number of measurements	mean	Homogeneous group
total carotenoids	fresh	18	71.16	a
	heat treatment	18	43.17	b
total polyphenols	fresh	18	479.44	a
	heat treatment	18	297.23	b
antioxidant activity	fresh	18	786.07	a
	heat treatment	18	651.39	b

Note: Means marked with the same letter are not statistically significantly different at $p \leq 0.05$.

higher contents of carotenoids as well. The highest antioxidant activity reached variety Waltham (851.87 mg AA.100 g⁻¹) and the lowest variety Orange (680.18 mg AA.100 g⁻¹). Waltham variety was one of the varieties with higher contents of total carotenoids and total polyphenols. Variety Orange showed one the lowest content of total polyphenols as well.

Polyphenol content in pumpkin cultivated in Malaysia evaluated **Azizah et al. (2009)** and in fresh matter they report it >90 mg.100 g⁻¹, which is higher than we found in our work. **Zdunić et al. (2016)** state the polyphenol content in pumpkin grown in Serbia to be 90.59 mg.100 g⁻¹ FW, which is higher than we found in our work. **Nawirska-Olzańska et al. (2011)** performed an experiment in the Experimental Station of Wrocław University of Environmental and Life Sciences in Psary and total polyphenol content detected in winter squash was 23.64 mg.100 g⁻¹, compared to our results it is lower result.

After the heat treatment in all varieties some decrease in the total polyphenol content and antioxidant activity was recorded as well. These changes based on the results of the Multi-factorial analysis of variance, similarly as in the case of total carotenoids, were statistically significant. The most significant change in the content of total polyphenols occurred in variety Serpentine, the polyphenol content decreased by 56.69%. Good stability of the total polyphenols showed variety Waltham, it maintained up to 79.93% of the original content.

The stability of total polyphenols by different methods of heat treatment in winter squash monitored **Azizah et al. (2009)**. Comparing the impact of cooking and frying on the polyphenol content they state that for both types of processing its content is decreasing, and there is no difference between the impact of cooking and frying. The longer is the material affected by both ways, the more decrease can be seen. **Zdunić et al. (2016)** investigated changes in polyphenol content after production of pumpkin wine, jam, and juice, and they have found that

the greatest decreases are occurring in the production of pumpkin juice when from the original content 90.59 mg.100 g⁻¹ in the product is maintained only approximately 10% of the initial quantity of total polyphenols. The smallest change occurred in the production of pumpkin jam

CONCLUSION

Winter squash belongs to the less widespread and unusual vegetables in Slovakia. In the world, especially in South America and Asia, it is one of the crops with a long history of cultivation due to the good climatic conditions of the locations, high biological potential of the crop itself and application in nutrition. The aim of the work was to compare the quality of selected types of winter squash in terms of carbohydrate content, total carotenoids and polyphenols and antioxidant activity and assessment of the changes that occur after heat treatment. Studied varieties were characterized by relatively high carbohydrate content. From the observed carbohydrates in fruits dominated sucrose, which was present in an amount of 28.67 g.100 g⁻¹ DM to 55.27 g.100 g⁻¹ DM. After heat treatment of pumpkin pulp sucrose content decreased and glucose and fructose content increased. Total carotenoids ranged from 39.01 g mg.100 g⁻¹ DM to 97.67 mg.100 g⁻¹ DM, the highest content we found in Orange variety. Heat treatment in the pulp was the reason of decreased content of carotenoids. The same effect showed heat treatment on the total polyphenols and antioxidant activity. Total polyphenols in fruits was detected from 443.98 mg GAE.100 g⁻¹ DM to 565.44 mg GAE.100 g⁻¹ DM. The highest content of total polyphenols we found in variety Hannah. The antioxidant activity of observed varieties ranged from 680.18 mg AA.100 g⁻¹ DM to 851.87 mg AA.100 g⁻¹ DM. The highest antioxidant activity showed variety Waltham.

REFERENCES

- Abou-Zaid Atef; A. M., Nadir, A. S., Ramadan, M. T. 2012. Studies on Sheets Properties made from Juice and Puree of Pumpkin and Some other Fruit Blends. *Journal of Applied Sciences Research*, vol. 8, no. 5, p. 2632-2369.
- Agbagwa, I. O., Ndukwu. B. C. 2004. The value of morpho-anatomical feature in the systematics of *Cucurbita landraces* (*Cucurbitaceae*) species in Nigeria. *African Journal of Biotechnology*, vol. 3, no. 10, p. 541-546. <https://doi.org/10.5897/AJB2004.000-2106>
- Andrejiová, A., Hegedúsová, A., Šlosar, M., Barátová S. 2016. Dynamics of Selected Bioactive Substances Changes in *Cucurbita Moschata* Duch. Ex Poir. After Storage and Different Methods of Technological Processing. *Acta Universitatis Agriculturae et Silviculturae Mendelianae Brunensis*, vol. 64, no. 2, p. 387-393. <https://doi.org/10.11118/actaun201664020387>
- Assous, M. T. M., Soheir Saad, E. M., Dyab, A. S. 2014. Enhancement of quality attributes of canned pumpkin and pineapple. *Annals of Agricultural Sciences*, vol. 59, no. 1, p. 9-15. <https://doi.org/10.1016/j.aosas.2014.06.002>
- Azevedo-Meleiro, C. H., Rodriguez-Amaya, D. B. 2007. Qualitative and quantitative differences in carotenoid composition among *Cucurbita moschata*, *Cucurbita maxima*, and *Cucurbita pepo*. *Journal of Agricultural and Food chemistry*, vol. 55, no. 10, p. 4027-4033. <https://doi.org/10.1021/jf063413d> PMID:17444652
- Azizah, A. H., Wee, K. C., Azizah, O., Azizah, M. 2009. Effect of boiling and stir frying on total phenolics, carotenoids and radical scavenging activity of pumpkin (*Cucurbita moschato*). *International Food Research Journal*, vol. 16, p. 45-51.
- Boiteux, L. S., Nascimento, W. M., Fonseca, M. E. N., Lana, M. M., Reis, A., Mendonça, J. L., Lopes J. F., Reifschneider, F. J. B. 2007. 'Brasileirinha': cultivar de abóbora (*Cucurbita moschata*) de frutos bicolores com valor ornamental e aptidão para consumo verde. *Horticultura Brasileira*, vol. 25, no. 1, p. 103-106. <https://doi.org/10.1590/S0102-05362007000100020>
- Caili, F., Huan, S., Quanhong, L. 2006. A review on pharmacological activities and utilization technologies of pumpkin. *Plant Foods Human Nutrition*, vol. 61, no. 2, p. 73-80. <https://doi.org/10.1007/s11130-006-0016-6> PMID:16758316
- Conti, S., Gerardo, V., Enrico, A., Gianluca, C. 2015. Effects of production system and transplanting time on yield, quality and antioxidant content of organic winter squash (*Cucurbita moschata* Duch.). *Scientia Horticulturae*, vol. 183, p. 136-143. <https://doi.org/10.1016/j.scienta.2014.12.003>
- Dragovic-Uzelac, V., Delonga, K., Levaj, B., Djakovic, S., Pospisil, J. 2005. Phenolic profiles of raw apricots, pumpkins, and their purees in the evaluation of apricot nectar and jam authenticity. *Journal of Agricultural and Food chemistry*, vol. 53, no. 12, p. 4836-4842. <https://doi.org/10.1021/jf040494+> PMID:15941324
- FAOSTAT, 2014. Agricultural data [online] s.a. [2017-02-12] Available at: <http://www.fao.org/faostat/en/#home>.
- Hussain, J., Rehman, N. U., Khan, A. L., Hamayun, M., Shinwari, Z. K. 2010. Proximate and essential nutrients evaluation of selected vegetables species from Kohat region, Pakistan. *Pakistan Journal of Botany*, vol. 42, no. 4, p. 2847-2855.
- Iacuzzo, F., Dalla Costa, L. 2009. Yield performance, quality characteristics and fruit storability of winter squash cultivars in sub-humid areas. *Scientia Horticulturae*, vol. 120, no. 3, p. 330-305. <https://doi.org/10.1016/j.scienta.2008.11.026>
- Jacobo-Valenzuela, N. O., Zazueta-Morales, J. J., Gallegos-Iñfante, J. A., Aguilar-Gutiérrez, F., Camacho-Hernández, I. L., Rocha-Guzmán, N. E., González-Laredo, R. R. 2011. Chemical and Physicochemical Characterization of Winter Squash (*Cucurbita moschata* D.). *Notulae Botanicae Horti Agrobotanici Cluj-Napoca*, vol. 39, no. 1, p. 34-40.
- Jun, H., Lee, C. H., Song, G. S., Kim, Y. S. 2006. Characterization of the pectic polysaccharides from pumpkin peel. *LWT – Food Science and Technology*, vol. 39, no. 5, p. 554-561. <https://doi.org/10.1016/j.lwt.2005.03.004>
- Kim, M. Y., Kim, E. J., Kim, Y. N., Choi, C., Lee, B. H. 2012. Comparison of the chemical compositions and nutritive values of various pumpkin (*Cucurbitaceae*) species and parts. *Nutrition Research Practice*, vol. 6, no. 1, p. 21-27. <https://doi.org/10.4162/nrp.2012.6.1.21> PMID:22413037
- Kurz, C., Carle, R., Schieber, A. 2008. HPLC-DAD-MS characterisation of carotenoids from apricots and pumpkins for the evaluation of fruit product authenticity. *Food Chemistry*, vol. 110, no. 2, p. 522-530. <https://doi.org/10.1016/j.foodchem.2008.02.022> PMID:26049248
- Loy, J. B. 2004. Morpho-physiological aspects of productivity and quality in squash and pumpkins (*Cucurbita* spp). *Critical Reviews in Plant Science*, vol. 23, no. 4, p. 337-363. <https://doi.org/10.1080/07352680490490733>
- Manthey, J. A., Grohmann, K., Guthrie, N. 2001. Biological properties of citrus flavonoids pertaining to cancer and inflammation. *Current Medicinal Chemistry*, vol. 8, no. 2, p. 135-153. <https://doi.org/10.2174/0929867013373723> PMID:11172671
- Murkovic, M., Mülleler, U. Neunteufl, H. 2002. Carotenoid content in different varieties of pumpkins. *Journal of Food Composition and Analysis*, vol. 15, no. 6, p. 633-638. <https://doi.org/10.1006/jfca.2002.1052>
- Nawirska-Olszańska, A., Biesiada, A., Sokol-Letowska, A., Kucharska, A. Z. 2011. Content of bioactive compounds and antioxidant capacity of pumpkin puree enriched with Japanese quince, cornelian cherry, strawberry and apples. *Acta Scientiarum Polonorum, Technologia Alimentaria*, vol. 10, no. 1, p. 51-60. PMID:22232528
- Nawirska-Olszańska, A., Biesiada, A., Sokol-Letowska, A., Kucharska, A. Z. 2014. Characteristics of organic acids in the fruit of different pumpkin species. *Food Chemistry*, vol. 148, pp. 415-419. <https://doi.org/10.1016/j.foodchem.2013.10.080> PMID:24262577
- Pandya, J. B., Rao, T. V. R. 2010. Analysis of certain biochemical changes associated with growth and ripening of *Cucurbita moschata* Duch. fruit in relation to its seed development. *Prajna - Journal of Pure and Applied Science*, vol. 18, p. 34-39.
- Podsedek, A. 2007. Natural antioxidants and antioxidant capacity of Brassica vegetables: A review. *Lebensmittel-Wissenschaft und Technologie*, vol. 40, no.1, p. 1-11. <https://doi.org/10.1016/j.lwt.2005.07.023>
- Prieto, P., Pineda, M., Aguilar, M. 1999. Spectrophotometric quantitation of antioxidant capacity through the formation of a phosphomolybdenum complex: specific application to the determination of vitamin E. *Analytical Biochemistry*, vol. 269, no. 2, p. 337-341. <https://doi.org/10.1006/abio.1999.4019> PMID:10222007
- Provesi, J. G., Dias, C. O., Amnte, E. R. 2011: Changes in carotenoids during processing and storage of pumpkin puree.

Food Chemistry, vol. 128, no. 1, p. 195-202.

<https://doi.org/10.1016/j.foodchem.2011.03.027>

PMid:25214348

Provesi, J. G., Dias, C. O., Mello Castanho Amboni, R. D., Amante, E. R. 2012. Characterisation and stability of quality indices on storage of pumpkin (*Cucurbita moschata* and *Cucurbita maxima*) purees. *International Journal Food Science and Technology*, vol. 47, no. 1, p. 67-74. <https://doi.org/10.1111/j.1365-2621.2011.02808.x>

Provesi, J. G., Amante, E. R. 2015. Carotenoids and Impact of Processing Treatments and Storage. In: Preedy, V. *Processing and Impact on Active Components in Food*. London, UK : Academic press, p. 71-80. ISBN: 978-0-12-404699-3. <https://doi.org/10.1016/B978-0-12-404699-3.00009-3>

Radovich, T. 2010. *Farm and forestry production and marketing profile for pumpkin and squash (Cucurbita spp)*. USA : Permanent Agriculture Resource (PAR). 14 p.

Rodriguez-Amaya, D. B., Kimura, M., Godoy, H. T., Amaya-Farfan, J. 2008. Updated Brazilian database on food carotenoids: Factors affecting carotenoids composition. *Journal of Food Composition and Analysis*, vol. 21, no. 6, p. 445-463. <https://doi.org/10.1016/j.jfca.2008.04.001>

Sharma, S., Rao, T. V. R. 2013. Nutritional quality characteristics of pumpkin fruit as revealed by its biochemical analysis. *International Food Research Journal*, vol. 20, no. 5, p. 2309-2316.

Singleton, V. L., Rossi, J. A. 1965. Colorimetry of total phenolics with phosphomolybdic –phosphotungstic acid reagents. *American Journal of Enology and Agriculture*, vol. 14, no. 3. p.144-158.

ČSN 56 0053. *Stanovení karoténů (provitaminů A) (Determination of carotens (provitamine A))*. Praha, Czech Republic : ÚNN, 1986, 5 p.

Suranto, T., Tediato, T., Purwanto, E., Setyono, P., Mahadjoeno, E. 2015. The relationship between altitudes and the contents of protein, carbohydrates, lipids of pumpkin (*Cucurbita moschata*). *Agrivita*, vol. 37, no. 1, p. 59-67. <https://doi.org/10.17503/Agrivita-2015-37-1-p059-066>

Špáňik, F., Šiška, B. 2008. *Biometeorológia*. 3rd ed. Nitra : SPU. 227 p. ISBN 978-80-552-0068-2.

Wilmsen, P. K., Spada, D. S., Salvador, M. 2005. Antioxidant activity of the flavonoid hesperidin in chemical and biological systems. *Journal Agricultural Food Chemistry*. vol. 53, no. 12, p. 4757-4761.

<https://doi.org/10.1021/jf0502000>

PMid:15941311

Zdunić, G. M., Menković, N. R., Jadranin, M. B., Novaković, M. M., Šavikin, K. P., Živković, J. 2016. Phenolic compounds and carotenoids in pumpkin fruit and related traditional products. *Hemijska Industrija*, vol. 70, no. 4, p. 429-433. <https://doi.org/10.2298/HEMIND150219049Z>

Zhou, C. L., Liu, W., Zhao, J., Yuan, C., Song, Y., Chen, D., Ni, Y. Y., Li, Q. H. 2014. The effect of high hydrostatic pressure on the microbiological quality and physical-chemical characteristics of pumpkin (*Cucurbita maxima* Duch.) during refrigerated storage. *Innovative Food Science & Emerging Technologie*, vol. 21, p. 24-34. <https://doi.org/10.1016/j.ifset.2013.11.002>

Acknowledgments:

This work was supported by grant VEGA No. 1/0308/14 and VEGA No 1/0280/17.

Contact address:

Ing. Andrea Mendelová, PhD., Slovak University of Agriculture in Nitra, Department of Plant Processing and Storage, A. Hlinku 2, 949 76 Nitra, Slovak Republic, E-mail: andrea.mendelova@uniag.sk

Ing. Ľubomír Mendel, PhD., National Agricultural and Food Centre, Plant Production Research Center Piešťany, Bratislavská 122, 921 68 Piešťany, Slovak Republic, E-mail: mendel@vurv.sk

doc. Ing. Martina Fikselová, PhD., Slovak University of Agriculture, Faculty of Biotechnology and Food Sciences, Department of Hygiene and Food Safety, Tr. A. Hlinku 2, 949 76 Nitra Slovakia, E-mail: martina.fikselova@uniag.sk

doc. Ing. Ján Mareček, PhD., Slovak University of Agriculture in Nitra, Department of Plant Processing and Storage, A. Hlinku 2, 949 76 Nitra, Slovak Republic, E-mail: jan.marecek@uniag

prof. RNDr. Alena Vollmannová, PhD., Slovak University of Agriculture, Faculty of Biotechnology and Food Sciences, Department of Chemistry, Tr. A. Hlinku 2, 949 76 Nitra Slovakia, E-mail: alena.vollmannova@uniag.sk



MYCOBIOTA OF SLOVAK WINE GRAPES WITH EMPHASIS ON *ASPERGILLUS* AND *PENICILLIUM* SPECIES IN THE SOUTH SLOVAK WINE REGION

Soňa Felšöciová, Dana Tančinová, Lubomír Rybárik, Zuzana Mašková

ABSTRACT

The Southern Slovak wine growing region is warmest part of Slovakia and is suitable for cultivating the grapes for production of wines at high quality. From the eight vineyards were collected 8 samples of wine grapes (white 7, blue 1) during harvesting 2011, 2012 and 2013. The aim of this work was to gain more knowledge about mycobiota on grapes originating from Slovakia, to identify *Aspergillus* and *Penicillium* species according to their morphology and evaluate the presence of secondary metabolites (also including intracellular and extracellular mycotoxins) produced in *in vitro* conditions by thin layer chromatography method from fresh grape berries. Fifty wine grapes per bunch (approximately 7 – 8 berries per plate) that showed no symptoms were randomly selected on Dichloran Rose Bengal Chloramphenicol agar medium. The plates were then incubated aerobically at 25 ±1 °C for 5 to 7 days in the dark. Of these samples were identified 17 genera. One hundred percent of samples were colonies by the genus *Penicillium* and 75% by the genus *Aspergillus*. During the survey, 135 isolates belonging to 9 *Penicillium* species (*P. aurantiogriseum*, *P. canescens*, *P. citrinum*, *P. crustosum*, *P. decumbens*, *P. expansum*, *P. funiculosum*, *P. chrysogenum* and *P. purpurogenum*) and 26 isolates belonging to 3 *Aspergillus* species (*A. clavatus*, *A. flavus* and *A. section Nigri*) were isolated and identified from exogenous contamination. The main occurring penicillium species of the samples were *P. expansum* (37.5% Fr), followed *P. citrinum*, *P. chrysogenum* and *P. crustosum* (25% Fr). The main occurring aspergillus species of the samples were *A. section Nigri* (62.5%). Eight potentially toxigenic species were tested for their toxigenic ability. It was confirmed the production of various mycotoxins such as aflatoxin B₁, citrinin, patulin, cyclopiazonic acid, penitrem A and roquefortin C. Out of 34 strains, 56% produced at least one mycotoxin.

Keywords: wine grapes; mycobiota; *Aspergillus* spp.; *Penicillium* spp.; mycotoxin

INTRODUCTION

Fruits contain high levels of sugars and other nutrients, and they possess an ideal water activity for microbial growth, their low pH makes them particularly susceptible to fungal spoilage. The grape microbial ecosystem is composed of highly diverse microorganisms, including fungi (Rousseaux et al., 2014). Grape health status is the main factor affecting the microbial ecology of grapes, increasing both microbial numbers and species diversity (Barata et al., 2012). Climate change (warmer weather, heat waves, higher levels of precipitation and drought) may affect the distribution of fungal population, including those present on grapes, thereby also affecting the presence of mycotoxins or off-flavours in wine (Paterson and Lima, 2011). Generally fungi have been detected in vineyards and on grapes from setting. Many species of fungi can colonize grapes during the withering process, and the most important of these for enhancing wine quality

is *Botrytis cinerea* (Lorenzini et al., 2012). *Botrytis cinerea* is widely recognized as the causal agent of gray mold and also generates off-flavors (Steel et al., 2013). However, grape rotting and spoilage can be caused by a variety of fungal species, including *Penicillium*, *Aspergillus*, *Alternaria*, *Cladosporium* and *Rhizopus*. *Aspergillus* and *Alternaria*, followed by *Penicillium*, are the most frequently reported genera on grapes. The genus *Penicillium* seems to be more frequent in temperate and cold climates, such as those in northern Europe, whereas *Aspergillus* is more frequently associated with warmer and wetter regions (Serra et al., 2006). *Aspergillus* spp. are ubiquitous saprophytes present in soils around the world, particularly in tropical and subtropical regions. *Aspergillus* section *Nigri* are the most important mycotoxigenic (ochratoxigenic) fungi present on grapes (5 – 83% infected berries) (García-Cela et al., 2015). Grape aspergilli increase gradually, reaching their maximum values at the

beginning of veraison and ripening (Battilani and Pietri, 2002). As *Aspergillus* species are not considered primary pathogens, various grape damage, such as attack by other fungi or mechanical injury, dramatically increases the risk of fungal infection by these species (Serra et al., 2006). Some vineyard fungal species are capable of producing toxic secondary metabolites (mycotoxins) in infected tissue, which may contaminate grapes and grape products such as wine, grape juice and dried vine fruit. The mycotoxins of greatest significance include aflatoxins, citrinin, patulin, ochratoxin A (OTA) and fumonisin B₂ (Susca et al., 2010). However, of the above mentioned mycotoxins, maximum levels for grape products, juices and/or wine are established for OTA. Only a few species produce OTA among the *Aspergillus niger* aggregate, *A. carbonarius*, *A. japonicas*, *A. ochraceus* (only occasionally isolated from grape) (Serra et al., 2005). *Penicillium verrucosum*, which is more frequently found on cereals is known to produce OTA and citrinin, is rarely found on grapes (Rousseaux et al., 2014). We focus particularly on descriptions of the fungal microbiota on grapes and species of genera *Aspergillus* and *Penicillium* responsible for the production of mycotoxins and off-flavors.

MATERIAL AND METHODOLOGY

Study area

Slovakia is a country located in Central Europe with climate conditions similar to those of the neighboring winemaking countries: the Czech Republic, Hungary, and Austria. Winemaking is concentrated in the southern part of the country, primarily on the southern, south-eastern, and southwestern slopes of the Carpathians Mountains, which take up approximately two thirds of Slovakia's total area. Slovakia's wine growing territory is divided into six regions. South Slovak wine growing region is situated north from river Danube, belongs to continental climate zone. It is warmest part of Slovakia and the vineyards are planted on loess uplands, silty clay soils with good water holding, which are suitable for growing of red grape varieties. The average air temperature in the period from May to September range from 13 °C to 23 °C, the average temperature in growing season is 18.5 °C. Higher average temperatures are contributing to production of saccharides substances in grapes, which will reflect in superior fullness of wine. Higher temperature allows to cultivate the grapes for production of wines at high quality and wines with attribute with average natural content of sugar around 23 °NM. Altogether 8 Slovakian vineyards were studied (Gbelce, Mužla, Pribeta, Nové Zámky, Abrahám, Nesvady, Veľký Meder and Šamorín) during a 3-year period (2011 – 2013) in South Slovak wine growing region.

Samples

Eight samples of 5 different grape varieties – 7 of white grape varieties (3 x Welschriesling, 2 x Riesling, 1x Green Veltliner, 1x Chardonnay) and 1 of blue grape variety Blue Frankish were involved in the study. Samples were collected in autumn of 2011 – 2013, in the maturation stage harvest. Three kilograms of samples were collected

at the time of technological ripeness. Picked grapes were stored at 4 ±1 °C and analyzed within 24 h after harvest.

Mycological analysis of grapes

A total of 50 berries (7 – 8 berries per bunch) from each sample were plated in Dichloran Rose Bengal Chloramphenicol agar medium (DRBC) and incubated at 25 ±1 °C in the dark for one week. We used conventional identification techniques, such as macroscopic and microscopic observations, with guidelines by Pitt and Hocking (2009) facilitating the identification of isolated microorganisms. Different media were used for the taxonomic identification of obtained fungi according to that used for standard strains. Specifically, *Penicillium* and *Aspergillus* strains were identified down to the species level first using Malt extract agar (MEA) (Pitt and Hocking, 2009), Czapek yeast extract agar (CYA) (Samson et al., 2002a), Czapek yeast extract with 20% sucrose agar (CY20S) (Pitt and Hocking, 2009), Yeast extract agar (YES) (Samson et al., 2010), Creatine-Sucrose agar (CREA) (Samson et al., 2010) and identified to species level according to the manuals of Samson et al. (2002a), Samson and Frisvad (2004), Pitt and Hocking (2009). The berries from the vineyards sampled were generally in good condition without visible damage.

The obtained results were evaluated and expressed according to isolation frequency (Fr) and relative density (RD). The isolation frequency (%) is defined as the percentage of samples within which the species or genus occurred at least once. The relative density (%) is defined as the percentage of isolates of the species or genus, occurring in the analyzed sample (Guatam et al., 2009). These values were calculated according to González et al. (1999) as follows:

$$\text{Fr (\%)} = (\text{ns} / \text{N}) \times 100; \text{RD (\%)} = (\text{ni} / \text{Ni}) \times 100$$

Where: ns – number of samples with a species or genus; N – total number of samples; ni – number of isolates of a species or genus; Ni – total number of isolated fungi.

Toxinogenity analysis

Toxinogenity of selected isolates was screened in in vitro conditions by means of thin layer chromatography (TLC) according to Samson et al. (2002b), modified by Labuda and Tančinová (2006). Extracellular metabolites – citrinin, patulin, griseofulvin, ochratoxin A, aflatoxin B₁, G₁ were carried out on YES agar and intracellular roquefortin C, penitrem A and cyclopiazonic acid on CYA agar. A few pieces of mycelium with approximate size 5 x 5 mm were cut from colonies and placed in an Eppendorf tube with 500 µL of chloroform:methanol – 2 : 1 (Reachem, Slovak Republic). The content of the tubes was stirred for 5 min by Vortex Geni[®] 2 (MO BIO Laboratories, Inc. – Carlsbad, CA, USA). The volume 30 µL of liquid phase of extracts along with 10 µL standards (Sigma, Germany) was applied on TLC plate (Alugram[®] SIL G, Macherey – Nagel, Germany). The plate was put into TEF solvent (toluene:ethyl acetate:formic acid – 5 : 4 : 1, toluene – Mikrochem, Slovak Republic; ethyl acetate and formic acid – Slavus, Slovak Republic). After elution the plate was air-dried. Identification of the metabolites

was done by comparison with metabolite standards. Roquefortin C was visible after spraying with Ce(SO₄)₂ x 4 H₂O as an orange spot. Penitrem A after spraying with 20% AlCl₃ in 60% ethanol and heating at 130 °C for 8 min as a dark blue spot. Cyclopiazonic acid was visible directly in daylight after spraying with the Ehrlich reagent as a violet-tailed spot. Patulin by spraying with 0.5% methylbenzothiazolone hydrochloride (MBTH), (Merck, Germany) in methanol and heating at 130 °C for 8 min and then detectable as a yellow-orange spot. Directly under UV light with a wavelength of 365 nm was visualized citrinin as a yellow-green-tailed spot, griseofulvin as a blue spot, ochratoxin A as a blue-green spot and aflatoxin B1 as a blue spot and aflatoxin G1 as a green-blue spot.

RESULTS AND DISCUSSION

A total of 1377 isolates of microscopic fungi were obtained. The most abundant moulds belong to the genera *Alternaria*, *Cladosporium* and *Penicillium*. They were found with 100% frequency. The higher frequency was detected in *Fusarium* (100%), *Epicoccum*, *Rhizopus* (87.5%), *Botrytis*, *Aspergillus* (75%) and *Mucor* (62.5%) but with lesser relative density. Table 1 lists the fungal isolated from grape berries at harvest time from 2011 to 2013.

Varga et al. (2007) examined the mycobiota of grape berries from 25 Hungarian and Czech vineyards. Most of the fungi isolated from Hungarian grapes belonged to genera *Aspergillus*, *Penicillium*, *Botrytis*, *Alternaria*, *Trichoderma* and *Cladosporium*. From the Czech grapes

were isolated *Alternaria*, *Cladosporium*, *Penicillium*, *Rhizopus*, *Epicoccum* and *Aspergillus*. Our mycobiota were very similar. No ochratoxigenic microfungi (*Aspergillus carbonarius*, other black aspergilli, *Aspergillus ochraceus*, *Penicillium verrucosum* or *Penicillium nordicum*) were identified in grapes sampled in Hungarian or Czech vineyards. From two different agroclimatic regions in Spain were sampled in 2011 and 2012 in order to determinate the grape mycobiota (García-Cela et al., 2015). The most common mycobiota isolated in both years were *Alternaria*, *Cladosporium* and *Penicillium*. Colonies belonging to *Aureobasidium*, *Botrytis*, *Eurotium*, *Epicoccum*, *Fusarium*, *Mucor* and *Trichoderma* were occasionally observed in the samples.

Mikušová et al. (2010) identified the fungi in the grape samples in three out of the six most important Slovakia wine making areas – Small Carpathian, Nitrian and South Slovakian in the harvest year 2008. The following genera of fungi were identified in the range of 1 – 4%: *Cladosporium*, *Epicoccum*, *Rhizopus*, *Ulocladium*, *Trichoderma* and *Trichothecium*. The genera *Aspergillus* (11.4%), *Fusarium* (11.4%), *Penicillium* (29.7%), and *Alternaria alternata* (14.8%) were considered to be predominant among the toxigenic fungi. Also, according to our results belonged the mention genera to the most frequent, but the percentage incidence was much higher and ranges from 75% to 100%. According to the results of Mikušová et al. (2010) relative density was lower and did not exceed 2%, and in our case reached the limit to 34.3%.

Rousseaux et al. (2014) summarized the various genera

Table 1 Fungi identified in Slovak wine grapes from 2011 to 2013 by the direct plating method.

Fungal taxa	No.	Fr (%)	RD (%)
<i>Alternaria</i>	472	100	34.3
<i>Aspergillus</i>	26	75	1.9
<i>Aureobasidium</i>	1	12.5	<1
<i>Botrytis</i>	106	75	7.7
<i>Cladosporium</i>	363	100	26.4
<i>Epicoccum</i>	40	87.5	2.9
<i>Fusarium</i>	55	100	4.0
<i>Gibberella</i>	2	12.5	<1
<i>Harzia</i>	3	12.5	<1
<i>Mucor</i>	11	62.5	<1
<i>Paecilomyces</i>	1	12.5	<1
<i>Penicillium</i>	135	100	9.8
<i>Phoma</i>	7	37.5	<1
<i>Rhizopus</i>	41	87.5	2.9
<i>Sordaria</i>	5	37.5	<1
<i>Trichoderma</i>	6	25	<1
<i>Ulocladium</i>	6	25	<1
<i>Mycelia sterilia</i>	97	87.5	7.0
Total isolates	1377		

Note: No. – number of isolates, Fr – isolation frequency, RD – relative density.

Table 2 *Aspergillus* species identified in Slovak wine grapes from 2011 to 2013 by the direct plating method.

<i>Aspergillus</i> species	No.	Fr (%)	RD (%)
<i>A. clavatus</i>	1	12.5	3.8
<i>A. flavus</i>	3	25	11.5
<i>A. section Nigri</i>	21	62.5	80.8
<i>A. sp.</i>	1	12.5	3.8
Total isolates	26		

Note: No. – number of isolates, Fr – isolation frequency, RD – relative density.

of filamentous microscopic fungi on grapes from different countries of the world. From these studies which were not carried out in the same vineyard and year and on the same variety seven of the genera of filamentous fungi identified by conventional or molecular techniques (excluding *B. cinerea*) were predominated among isolates: *Alternaria*, *Acremonium*, *Aspergillus*, *Cladosporium*, *Fusarium*, *Penicillium* and *Rhizopus*. The percentages of the total microflora accounted for by these seven predominant genera varied considerably between vineyards (geographic location): *Alternaria* (2.8% – 80%), *Acremonium* (0.3% – 0.8%), *Aspergillus* (1% – 79.7%), *Cladosporium* (4.4% – 92.2%), *Fusarium* (0.5% – 18%), *Penicillium* (2.3% – 31%) and *Rhizopus* (0.8% – 2.4%). *Acremonium* was not detected in our samples, however *Alternaria* was the most frequently isolated genus (100% Fr, 34.3% RD).

The *Aspergillus* and *Penicillium* strains were isolated and identified to species level. The isolation rates for *Aspergillus* from the berries were 75% but the relative densities were low (19%, Table 1). Table 2 shows the number of isolates, isolation frequency (%) and relative density (%) of *Aspergillus* spp.

From the 26 *Aspergillus* strains identified, the species of *Aspergillus* section *Nigri* were the predominant in mycobiota, because they were the most frequent (62.5%) of the isolates and relative density among species was maximum again for *A.* section *Nigri* (80.8%). The molds belonging to the species *Aspergillus niger* and *Alternaria alternata* are common grape pathogens (Diguta et al., 2011).

Rousseaux et al. (2014) introduced, that thirty-six species of *Aspergillus* have been isolated from grapes in vineyards around the world. In our case it was 3 species. *Aspergillus carbonarius* and *A. niger* aggregates belong to section *Nigri* (black aspergilli) are the species most frequently isolated, accounting for 50 – 98.5% of all *Aspergillus* strains isolated (Rousseaux et al., 2014). They have also been identified as the principal producers of OTA and *A. carbonarius* are responsible for OTA contamination worldwide (Somma et al., 2012). Felšöciová et al. (2015) from Small Carpathian winemaking region during the years 2011 and 2013 identified 6 different *Aspergillus* species from the 37 *Aspergillus* strains. The species of *Aspergillus* section *Nigri* were also the predominant in mycobiota (64% Fr). The species of *A. clavatus* and *A. flavus* were the other most important species recorded with high isolation frequency (21% Fr).

Table 3 lists selected *Penicillium* strains isolated from grape berries. A total of 135 isolates belonging to genus *Penicillium*, were obtained.

The spectrum of identified species includes 9 species. The most frequent species were *P. expansum* (37.5%), *P. citrinum*, *P. crustosum* and *P. chrysogenum* (25%, each). Relative density among species was maximum for *P. expansum* (28.1%), *P. funiculosum* (11.1%) and *P. citrinum* (8.1%). *Penicillium expansum* is a pathogen on fruits and it has been isolated from a wide range of fruits including apples, pears, tomatoes, strawberries, grapes and others (Pitt and Hocking, 2009). *Penicillium expansum* has been shown to be able to produce geosmin. Geosmin is the principal molecule responsible for earthy, moldy, damp earth and red beet root odors in grape must and wine (Darriet et al., 2000). The molds belonging to the species *P. expansum* and *P. crustosum* are common grape pathogens (Diguta et al., 2011). The type of infecting moulds influenced the concentration of total polyphenol and anthocyanin as well as colour intensity. *Penicillium expansum* and *P. crustosum* greatly affected these parameters (Lorenzini et al., 2012). The most common sources of *Penicillium citrinum* are cereals, fermented and cured meats, wine grapes, dried vine fruits, coffee beans, dried beans, peppercorns, because of its mesophilic nature, distribution is world wide (Pitt and Hocking, 2009). The species *P. brevicompactum*, *P. crustosum*, *P. chrysogenum*, *P. expansum*, *P. palitans* and *P. polonicum* were identified by Santini et al. (2014) from three winemaking regions of Slovakia – Small Carpathian, Nitrian and South Slovakian during the years 2008 and 2009. We found wide spectrum of *Penicillium* spp. but without *P. brevicompactum*, *P. palitans* and *P. polonicum*. Felšöciová et al. (2015) from Small Carpathian winemaking region during the years 2011 and 2013 identified 13 different *Penicillium* species from the 251 *Penicillium* strains. The most frequent were *Penicillium chrysogenum* (64%), *P. crustosum* (12%) and *P. griseofulvum* (8%) of the isolates. Isolation frequency among species was maximum for *P. chrysogenum* (36%), *P. crustosum* (29%), *P. expansum* and *P. griseofulvum* (21%, each). García-Cela et al. (2015) isolated from Spanish grape samples in 2011 these species *P. angulare*, *P. aurantiogriseum*, *P. crustosum*, *P. erythromellis*, *P. expansum*, *P. glabrum*, *P. northofagi*, *P. oxalicum*, *P. purpurogenum*, *P. ramulosum*, *P. simile*, *P. vasconiae*, *P. westlingii* and *Talaromyces trachyspermus*, while in 2012 *P. brevicompactum*, *P. citrinum*, *P. glabrum*,

Table 3 *Penicillium* species identified in Slovak wine grapes from 2011 to 2013 by the direct plating method.

<i>Penicillium</i> species	No.	Fr (%)	RD (%)
<i>P. aurantiogriseum</i>	10	12.5	7.4
<i>P. canescens</i>	2	12.5	1.5
<i>P. citrinum</i>	11	25	8.1
<i>P. crustosum</i>	16	25	1.2
<i>P. decumbens</i>	2	12.5	1.5
<i>P. expansum</i>	38	37.5	28.1
<i>P. funiculosum</i>	15	12.5	11.1
<i>P. chrysogenum</i>	10	25	7.0
<i>P. purpurogenum</i>	4	12.5	3.0
<i>P. sp.</i>	27	62.5	20.0
Total isolates	135		

Note: No. – number of isolates, Fr – isolation frequency, RD – relative density.

P. griseofulvum, *P. mariae-crucis*, *P. minioluteum*, *P. olsonii*, *P. oxalicum*, *P. pinophilum*, *P. purpurogenum*, *P. sizovae* and *Talaromyces* sp. were identified. Ochratoxigenic *Penicillium* species were not found. We isolated from these species only *P. aurantiogriseum*, *P. citrinum*, *P. crustosum*, *P. expansum* and *P. purpurogenum*. Fifty-nine different species of *Penicillium* have been isolated from grapes in vineyards around the world (Rousseaux et al., 2014). A predominant species of *Penicillium* isolated from grapes differs between vineyards and vintages. For example, *Penicillium chrysogenum* is the species most frequently isolated in Argentina (Magnoli et al., 2003), which is one of the most frequently isolated in our grapes. *Penicillium chrysogenum* occasionally caused spoilage in stored grapes and is not known as a pathogen. It is a ubiquitous fungus and occupies a very range of habitats. (Pitt and Hocking, 2009). *Penicillium brevicompactum* has been identified as the *Penicillium* species most frequently isolated from French and Portuguese vineyards (Sage et al., 2002; Serra et al., 2005, 2006). However, other studies have identified *Penicillium expansum* as the species most frequently isolated from Portuguese (Abrunhosa et al., 2001) and French (La Guerche et al., 2005) vineyards. Diguta et al. (2011) identified *P. spinulosum* as the most frequently isolated species of *Penicillium*, followed by *P. expansum* and *P. minioluteum*, for the 2008 vintage, in Burgundy. In our samples *P. spinulosum* and *P. minioluteum* were not detected. La Guerche et al. (2005) identified *P. expansum* as the predominant species isolated from Bordeaux vineyards. Thus, the distribution of *Penicillium* species, which may generate organoleptic defects, depends on both vineyard and vintage.

Mycotoxins are toxic secondary metabolites detected in various foods (cereals, vegetables, fruits) and drinks (beer, wine) following the development of certain fungi, especially *Aspergillus* spp., *Penicillium* spp., *Fusarium* spp. and *Trichothecium roseum* (Scott, 2012).

In total 34 isolates representing 8 potentially toxigenic species were tested for their toxigenic ability (Table 4). Out of 34 strains, 56% produced at least one mycotoxin as revealed by the method used here.

Aspergillus flavus produced aflatoxin B1 and cyclopiazonic acid (CPA, 1 out of 3 strains screened, each) but did not produce aflatoxin G1. Aflatoxins, including aflatoxin B1 are the most frequently studied of the other mycotoxins, due largely to their highly hepatotoxic nature. In Portugal, 27 aflatoxin B1-producing strains have been

isolated from grapes (Serra et al., 2005), 43% of *Aspergillus flavus* isolates from grapes in Lebanon and 23% of *A. flavus* isolates from grapes in Tunisia have been shown to produce this aflatoxin (El Khoury et al., 2008; Melki Ben Fredj et al., 2009).

Ochratoxin A production was tested in 5 strains belonging to *Aspergillus* section *Nigri*. Among them, the production of ochratoxin A was not confirmed. *Penicillium verrucosum* and *P. nordicum*, the only confirmed *Penicillium* species that are able to produce OTA, were not isolated. Ochratoxin A is the main mycotoxin found in the human food chain, it has been shown to be nephrotoxic, hepatotoxic, teratogenic and carcinogenic to animals and, probably, also to humans (Creppy, 1999). Wine is now considered to be the second major source of human exposure to OTA, after cereals. OTA is produced principally by several species of the genera *Aspergillus* (*A. ochraceus*, *A. carbonarius*, *A. niger*) and *Penicillium*. An ability to produce OTA has been reported for 25 – 100% of the *A. carbonarius* strains isolated from grapes and for 0 – 77% of isolates from the *A. niger* aggregate. Thus, the high abundance of *A. niger* aggregate on grapes is not always correlated with a high level of OTA production (Rousseaux et al., 2014).

Positive toxigenity was detected in *A. clavatus* on patulin. Patulin inhibits the fermenting yeast *Saccharomyces cerevisiae*, it is partially degraded by the addition of sulfur dioxide and completely degraded during alcoholic fermentation (Díaz et al., 2011). It is therefore unlikely to be present in wine.

The genus *Penicillium*, in particular, has been associated with the production of secondary metabolites (including mycotoxins) in food and fruits (Pitt and Hocking, 2009). Considering the 18 total strains examined, the 94.4% of them produced roquefortine C. Felšöciová et al. (2015) tested 68 strains on roquefortine C from Small Carpathian winemaking region from exogenous mycobiota which all were positive, too. *Penicillium citrinum* is the main producer of citrinin, a mycotoxin of moderate toxicity (Pitt and Hocking, 2009). The metabolite citrinin, a characteristic yellow-lemon pigment, was produced by all strains of *P. citrinum* under laboratory conditions. Only two strains of *P. expansum* produced this mycotoxin on YES. Citrinin is not degraded during alcoholic fermentation and may be present in very small amounts in wine. However, wine contamination is unlikely, due to the low abundance of citrinin producing species on grapes (Pitt and Hocking, 2009).

Table 4 Toxinogenity of selected strains, isolated from exogenous mycobiota of wine grapes.

Species	AFB ₁	AFG ₁	OTA	C	G	P	CPA	PA	RC
<i>A. flavus</i>	1*/3**	0/3					1/3		
<i>A. clavatus</i>						1/1			
<i>A. section Nigri</i>			0/5						
<i>P. canescens</i>					0/2			0/2	
<i>P. citrinum</i>				5/5					
<i>P. crustosum</i>								4/4	4/4
<i>P. expansum</i>				2/8		3/8			7/8
<i>P. chrysogenum</i>									6/6

Note: * – number of isolates with ability to produce mycotoxin, ** – number of tested isolates, AFB₁ – aflatoxin B₁, AFG₁ – aflatoxin G₁, OTA – ochratoxin A, C – citrinin, G – griseofulvin, P – patulin, CPA – cyclopiazonic acid, PA – penitrem A, RC – roquefortin C.

Penicillium canescens did not produce griseofulvin. *Penicillium crustosum* is the major producer of penitrem A, a powerful neurotoxin and it has been implicated in a tremor syndrome in humans (Pitt and Hocking, 2009). Penitrem A, an intracellular mycotoxin, were produced by all strains of *P. crustosum*. According to Frisvad et al. (2006) all isolates of *P. crustosum* produce penitrem A at high levels. Interestingly, this metabolite was not produced by any of the strains of *P. canescens*. Penitrem A is produced only at high moisture levels, above about 0.92 aw, with an optimum around 0.995 aw. This probably explains the relatively low number of reports of poisoning from a very toxic compound produced by a very common fungus (Pitt and Hocking, 2009).

Penicillium expansum, an important producer of citrinin and patulin can cause patulin contamination in must obtained from grapes (Samson and Frisvad, 2004). Its presence in grapes has been associated with moldy berries, even if patulin is degraded to some extent during the fermentation process (Abrunhosa et al., 2001).

CONCLUSION

Grapes were analyzed by plating methods from South Slovak wine-growing region at the harvest time between 2011 and 2013. From the 1377 strains detected and identified from exogenous mycobiota, the most frequent genera were *Alternaria*, *Cladosporium* and *Penicillium*. Potentially toxigenic *Aspergillus* and *Penicillium* species were tested for their toxigenic ability by thin layer chromatography. Out of 34 exogenous strains representing 8 potentially toxigenic species, 56% produced at least one mycotoxin. Potential producers of ochratoxin A *Aspergillus* section *Nigri* and roquefortin C *Penicillium* *expansum* were the most frequent mycotoxigenic species isolated from grapes. In line with the results on OTA content of Slovak grapes, it appears that the mycotoxin does not present a significant hazard to consumers.

REFERENCES

Abrunhosa, L., Paterson, R. R. M., Kozakiewicz, Z., Lima, N., Venancio, A. 2001. Mycotoxin production from fungi isolated from grapes. *Letters in Applied Microbiology*, vol. 32, no. 4, p. 240-242. <https://doi.org/10.1046/j.1472-765X.2001.00897.x>
 PMid:11298933

Barata, A., Malfeito-Ferreira, M., Loureiro, V. 2012. The microbial ecology of wine grape berries. *International Journal of Food Microbiology*, vol. 153, no. 3, p. 243-259. <https://doi.org/10.1016/j.ijfoodmicro.2011.11.025>
 PMid:22189021

Battilani, P., Pietri, A. 2002. Ochratoxin A in grapes and wine. *European Journal of Plant Pathology*, vol. 108, no. 7, p. 639-643. <https://doi.org/10.1023/A:1020693410428>

Creppy, E. E. 1999. Human ochratoxicosis. *Journal of Toxicology Toxin Reviews*, vol. 18, no. 3, p. 273-293. <https://doi.org/10.3109/1556954999009258>

Darriet, P., Pons, M., Lamy, S., Dubourdieu, D. 2000. Identification and quantification of geosmin, a powerful earthy odorant contaminating wines. *Journal of Agricultural and Food Chemistry*, vol. 48, no. 10, p. 4835-4838. <https://doi.org/10.1021/jf0007683>
 PMid:11052742

Díaz, G. A., Yañez, L., Latorre, B. A. 2011. Low occurrence of patulin-producing strains of *Penicillium* in

grapes and patulin degradation during winemaking in Chile. *American Journal of Enology and Viticulture December*, vol. 62, no. 4, p. 542-546.

Diguta, C. F., Vincent, B., Guilloux-Benatier, M., Alexandre, H., Rousseaux, S. 2011. PCR ITS-RFLP: a useful method for identifying filamentous fungi isolates on grapes. *Food Microbiology*, vol. 28, no. 6, p. 1145-1154. <https://doi.org/10.1016/j.fm.2011.03.006>
 PMid:21645813

El Khoury, A., Rizk, T., Lteif, R., Azouri, H., Delia, M. L., Lebrhi, A. 2008. Fungal contamination and aflatoxin B₁ and ochratoxin A in Lebanese winegrapes and musts. *Food and Chemical Toxicology*, vol. 46, no. 6, p. 2244-2250. <https://doi.org/10.1016/j.fct.2008.02.026>
 PMid:18430504

Felšöciová, S., Tančinová, D., Rybárik, L., Mašková, Z., Kačániová, M. 2015. Mycobiota of Slovak wine grapes with emphasis on *Aspergillus* and *Penicillium* species in the small Carpathian area. *Potravinárstvo*, vol. 9, no. 1, p. 501-508. <https://doi.org/10.5219/529>

Frisvad, J. C., Thrane, U., Samson, R. A., Pitt, J. I. 2006. Important mycotoxins and the fungi which produce them. *Advances in Experimental Medicine and Biology*, vol. 571, p. 3-31. https://doi.org/10.1007/0-387-28391-9_1
 PMid:16408591

García-Cela, E., Crespo-Sempere, A., Gil-Serna, J., Porqueres, A., Marin, S. 2015. Fungal diversity, incidence and mycotoxin contamination in grapes from two agro-climatic Spanish regions with emphasis on *Aspergillus* species. *Journal of the Science of Food and Agriculture*, vol. 95, no. 8, p. 1716-29. <https://doi.org/10.1002/jsfa.6876>
 PMid:25131651

Gautam, A., Sharma, S., Bhadauria, R. 2009. Detection of toxigenic fungi and mycotoxins in medicinally important powdered herbal drugs. *The Internet Journal of Microbiology*, vol. 7, no. 2, p. 1-8.

González, H. H. L., Martínez, E. J., Pacin, A., Resnik, S. L. 1999. Relationship between *Fusarium graminearum* and *Alternaria alternata* contamination and deoxinivalenol occurrence on Argentinian durum wheat. *Mycopathologia*, vol. 144, no. 2, p. 97-102. <https://doi.org/10.1023/A:1007020822134>

La Guerche, S., Chamont, S., Blancard, D., Dubourdieu, D., Darriet P. 2005. Origin of (-)-geosmin of grapes: on the complementary action of two fungi, *Botrytis cinerea* and *Penicillium expansum*. *Antonie van Leeuwenhoek*, vol. 88, no. 2, p. 131-139. <https://doi.org/10.1007/s10482-005-3872-4>
 PMid:16096689

Labuda, R., Tančinová, D. 2006. Fungi recovered from Slovakian poultry feed mixtures and their toxinogenicity. *Annals of Agricultural and Environmental Medicine*, vol. 13, no. 2, p. 193-200. <https://doi.org/10.1007/s10482-005-3872-4>
 PMid:17195991

Lorenzini, M., Azzolini, M., Tosi, E., Zapparoli, G. 2012. Postharvest grape infection on *Botrytis cinerea* and its interactions with other moulds under withering conditions to produce noble-rotten grapes. *Journal of Applied Microbiology*, vol. 114, no. 3, p. 762-770. <https://doi.org/10.1111/jam.12075>
 PMid:23163324

Magnoli, C., Violante, M., Combina, M., Palacio, G., Dalcero, A. 2003. Mycoflora and ochratoxin-producing strains of *Aspergillus* section *Nigri* in wine grapes in Argentina. *Letters in Applied Microbiology*, vol. 37, no. 2, p. 179-184. <https://doi.org/10.1046/j.1472-765X.2003.01376.x>
 PMid:12859664

- Melki Ben Fredj, S., Chebil, S., Mliki, A. 2009. Isolation and characterization of ochratoxin A and aflatoxin B₁ producing fungi infecting grapevines cultivated in Tunisia. *African Journal of Microbiology Research*, vol. 3, no. 9, p. 523-527.
- Mikušová, P., Ritieni, A., Santini, A., Juhasová, G., Šrobárová, A. 2010. Contamination by moulds of grape berries in Slovakia. *Food Additives & Contaminants: Part A*, vol. 27, no. 5, p. 738-747. <https://doi.org/10.1080/19440040903571754> PMID:20349371
- Paterson, R. R. M., Lima, N. 2011. Further mycotoxin effects from climate change. *Food Research International*, vol. 44, no. 9, p. 2555-2566. <https://doi.org/10.1016/j.foodres.2011.05.038>
- Pitt, J. I., Hocking, A. D. 2009. *Fungi and Food Spoilage*. 3rd ed. London : Springer. 519 p. ISBN 978-0-387-92206-5. <https://doi.org/10.1007/978-0-387-92207-2>
- Rousseaux, S., Diguta, C. F., Radoi-Matei, F., Alexandre, H., Guilloux-Bénatier, M. 2014. Non-botrytis grape-rotting fungi responsible for earthy and moldy off-flavors and mycotoxins. *Food Microbiology*, vol. 38, p. 104-121. <https://doi.org/10.1016/j.fm.2013.08.013> PMID:24290633
- Sage, L., Krivoboc, S., Delbos, E., Seigle-Murandi, F., Creppy, E. E. 2002. Fungal flora and ochratoxin A production in grapes and musts from France. *Journal of Agriculture and Food Chemistry*, vol. 50, no. 5, p. 1306-1311. <https://doi.org/10.1021/jf011015z> PMID:11853522
- Samson, R. A., Frisvad, J. C. 2004. *Polyphasic taxonomy of Penicillium subgenus Penicillium: new taxonomic schemes and mycotoxins and other extrolites*. Utrecht : Centraalbureau voor Schimmelcultures. 260 p. ISBN 90-70351-53-6.
- Samson, R. A., Hoekstra, E. S., Frisvad, J. C., Filtenborg, O. 2002a. *Introduction to food- and airborne fungi*. 6th revised ed. (with some corrections). Utrecht, Netherland : Centraalbureau voor Schimmelcultures. 389 p. ISBN 90-70351-42-0.
- Samson, R. A., Hoekstra, E. S., Lund, F., Filtenborg, O., Frisvad, J. C. 2002b. Method for the detection, isolation and characterisation of food-borne fungi. In Samson, R. A. et al. *Introduction to food and airborne fungi*. Utrecht, Netherland : Centraalbureau voor Schimmelcultures, p. 283-297. ISBN 9070351420.
- Samson, R. A., Houbraken, J., Thrane, U., Frisvad, J. C., Andersen, B. 2010. *Food and Indoor Fungi*. Utrecht, Netherland : CBS – KNAW Fungal Biodiversity Centre. 390 p. ISBN 978-90-70351-82-3.
- Santini, A., Mikušová, P., Sulyok, M., Krška, R., Labuda, R., Šrobárová, A. 2014. *Penicillium* strains isolated from Slovak grape berries taxonomy assessment by secondary metabolite profile. *Mycotoxin Research*, vol. 30, no. 4, p. 213-220. <https://doi.org/10.1007/s12550-014-0205-3> PMID:25109845
- Scott, P. M. 2012. Recent research on fumonisins: a review. *Food Additives and Contaminants: Part A: Chemistry, Analysis, Control, Exposure and Risk Assessment*, vol. 29, no. 2, p. 242-248. <https://doi.org/10.1080/19440049.2010.546000> PMID:21337235
- Serra, R., Braga, A., Venâncio, A. 2005. Mycotoxin-producing and other fungi isolated from grapes for wine production, with particular emphasis on ochratoxin A. *Research in Microbiology*, vol. 156, no. 4, p. 515-521. <https://doi.org/10.1016/j.resmic.2004.12.005> PMID:158624
- Serra, R., Lourenço, A., Alipio, P., Venâncio, A. 2006. Influence of the region of origin on the mycobiota of grapes with emphasis on *Aspergillus* and *Penicillium* species. *Mycological Research*, vol. 110, no. 8, p. 971-978. <https://doi.org/10.1016/j.mycres.2006.05.010> PMID:16891107
- Somma, S., Perrone, G., Logrieco, A. 2012. Diversity of black *Aspergilli* and mycotoxin risks in grape, wine and dried vine fruits. *Phytopathologia Mediterranea*, vol. 51, no. 1, p. 131-147.
- Steel, C. C., Blackman, J. W., Schmidtke, M., 2013. Grapevine Bunch Rots: Impacts on wine composition, quality and potential procedures for the removal of wine faults. *Journal of Agricultural and Food Chemistry*, vol. 61, no. 22, p. 5189-5206. <https://doi.org/10.1021/jf400641r> PMID:23675852
- Susca, A., Proctor, R. H., Mulè, G., Stea, G., Ritieni, A., Logrieco, A., Moretti, A. 2010. Correlation of mycotoxin fumonisin B₂ production and presence of the fumonisin biosynthetic gene fum8 in *Aspergillus niger* from grape. *Journal of Agricultural and Food Chemistry*, vol. 58, no. 6, p. 9266-9272. <https://doi.org/10.1021/jf101591x> PMID:20666454
- Varga, J., Konc, Z., Kocsubé, S., Kozakiewicz, Z. 2007. Mycobiota of grapes collected in Hungarian and Czech vineyards in 2004. *Acta Alimentaria*, vol. 36, no. 3, p. 329-341. <https://doi.org/10.1556/AAlim.2007.0016>

Acknowledgments:

This paper was co-funded under project KEGA 015 SPU - 4/2015. This work was supported by Research Center AgroBioTech built in accordance with the project Building Research Centre „AgroBioTech“ ITMS 26220220180.

Contact address:

Soňa Felšöciová, Slovak University of Agriculture, Faculty of Biotechnology and Food Sciences, Department of Microbiology, Tr. A. Hlinku 2, 949 76 Nitra, Slovakia, E-mail: sona.felsociova@uniag.sk

Dana Tančinová, Slovak University of Agriculture, Faculty of Biotechnology and Food Sciences, Department of Microbiology, Tr. A. Hlinku 2, 949 76 Nitra, Slovakia, E-mail: dana.tancinova@uniag.sk

Ľubomír Rybárik, Báb 49, 951 34 Báb Slovakia, E-mail: alcedo1245@gmail.com

Zuzana Mašková, Slovak University of Agriculture, Faculty of Biotechnology and Food Sciences, Department of Microbiology, Tr. A. Hlinku 2, 949 76 Nitra, Slovakia, E-mail: zuzana.maskova@uniag.sk



CO-ADMINISTRATION OF AMYGDALIN AND DEOXYNIVALENOL DISRUPTED REGULATORY PROTEINS LINKED TO PROLIFERATION OF PORCINE OVARIAN CELLS IN VITRO

Marek Halenár, Marína Medved'ová, Simona Baldovská,
Katarína Michalcová, Adriana Kolesárová

ABSTRACT

Deoxynivalenol (DON) represents one of the most prevalent trichothecene mycotoxin produced by *Fusarium* species, causing economic and health impacts. On the other hand, amygdalin has been demonstrated to possess both prophylactic and curative properties, thus it has been used as a traditional drug because of its wide range of medicinal benefits, including curing or preventing cancer, relieving fever, suppressing cough, and quenching thirst. The aim of this *in vitro* study was to evaluate potential effects of natural product amygdalin combined with mycotoxin deoxynivalenol (DON) on the key regulators of cell proliferation and apoptosis in porcine ovarian granulosa cells. Ovarian granulosa cells were incubated for 24h with amygdalin (1, 10, 100, 1000, 10 000 $\mu\text{g}\cdot\text{mL}^{-1}$) combined with deoxynivalenol (1 $\mu\text{g}\cdot\text{mL}^{-1}$), while the control group remained untreated. The presence of proliferative (cyclin B1, PCNA) and apoptotic markers (caspase-3) in porcine ovarian granulosa cells after amygdalin treatment (1, 10, 100, 1000, 10 000 $\mu\text{g}\cdot\text{mL}^{-1}$) combined with deoxynivalenol (1 $\mu\text{g}\cdot\text{mL}^{-1}$) was detected by immunocytochemistry. The presence of proliferative (cyclin B1, PCNA) and apoptotic markers (caspase-3) in porcine ovarian granulosa cells was detected by immunocytochemistry. Co-administration of amygdalin plus DON significantly ($p < 0.05$) increased the number of granulosa cells containing cyclin B1 and PCNA at all tested concentrations, when compared to control. However, percentage of granulosa cells containing major apoptotic marker caspase-3 did not differ after co-administration of amygdalin and DON. In summary, results from this *in vitro* study indicate that co-exposure of amygdalin and deoxynivalenol may act to stimulate proliferation-associated peptides in porcine ovarian granulosa cells, and thus alter cell proliferation and normal follicular development.

Keywords: amygdalin; deoxynivalenol; ovarian cell; proliferation; apoptosis

INTRODUCTION

Mycotoxins are a group of toxic secondary metabolites produced by molds and frequently enter the food chain as food contaminants (Vejdovszky et al., 2016). Deoxynivalenol (DON) represents one of the most prevalent trichothecene mycotoxin produced by *Fusarium* species responsible of *Fusarium* head blight. Due to a high prevalence of this disease, type B trichothecenes are the most common contaminants of cereal grains in temperate regions of the world (Alassane-Kpembi et al., 2015). They are commonly found on cereals grown in the temperate regions of Europe, America and Asia. The extent of infection is dependent on weather conditions, Good Agricultural Practice and storage conditions of cereal crops (Larsen et al., 2004). A large scale data survey indicates that DON and its metabolites 15-ADON and 3-ADON are present in 57%, 20% and 8%, respectively of food samples collected in the European Union (Alassane-Kpembi et al., 2015). They represent a unique class of mycotoxins that do not only exert toxicity in animal but also are virulence factors in plant disease,

which make them one of the major groups causing significant economic and health impacts (Desjardins, 2009). Intoxications following consumption of foodstuffs contaminated with trichothecenes have occurred in both humans and animals with large numbers of people and livestock being affected. Some countries have already established legislative limits in cereals for DON, the most abundant trichothecene, and the European Commission has proposed EU regulatory limits for DON in various raw cereals and their refined products (Larsen et al. 2004).

At the molecular level, trichothecenes display multiple inhibitory effects on primary metabolism of eukaryotic cells including inhibition of protein as well as DNA and RNA synthesis, and their activity may eventually produce harmful levels of oxidative stress due to generation of free radicals (Arunachalam and Doohan 2013). Thus organs and biological functions involving actively dividing cells appear more sensitive to this class of mycotoxins (Parent-Massin, 2004; Pestka et al., 2004). Mycotoxins as contaminants of animal feed can impair growth and/or reproductive efficiency. This is especially prominent in

prepubertal gilts (Dänicke, 2002). The adverse health effects of trichothecenes include emesis, nausea, anorexia, growth retardation, hemorrhagic lesions, neuroendocrine changes and immunosuppression (Larsen et al., 2004; Pestka et al., 2004; Alassane-Kpembi et al., 2015).

On the other hand, amygdalin as a natural plant compound belongs to the cyanogenic glycosides abundantly present in diverse plants, especially in the rosaceous plant seeds such as bitter almonds, apricots and peaches etc. (Chang et al., 2006, Lee and Moon 2016). This bioactive substance is composed of glucose, benzaldehyde, which induces an analgesic action, and hydrocyanic acid, which is an anti-neoplastic compound (Fukuda et al., 2003; Chang et al., 2006). Amygdalin has been demonstrated to possess both prophylactic and curative anticancer properties, thus it has been used as a traditional drug because of its wide range of medicinal benefits, including curing or preventing cancer, relieving fever, suppressing cough, and quenching thirst (Moertel et al., 1982; Oyewole and Olayinka 2009; Zhou et al., 2012). In addition, the pharmacological activity of amygdalin also include anti-inflammatory, anti-atherogenic and anti-asthmatic effects (Song and Xu, 2014). However, the use of the drug was discouraged when it was demonstrated that amygdalin is metabolized in the body to release significant amount of cyanide thus leading to cyanide poisoning (Chandler et al., 1984; Bromley et al., 2005). β -glucosidase, one of the enzymes that catalyzes the release of cyanide from amygdalin, is present in the human small intestine and is also found in a variety of common foods (Strugala et al., 1995; Deng et al., 2002). Side effects of amygdalin ingestion in humans mirror symptoms of cyanide poisoning which includes nausea, vomiting, headache, dizziness, bluish colouration of the skin, liver damage, hypotension, nerve damage, fever, mental confusion, coma and death (Howard-Reuben and Miller 1984). Considering that amygdalin has been frequently used as alternative therapy, modulatory and chemopreventive potential of amygdalin has not been sufficiently studied yet.

Pig is considered an illustrative case of dual-purpose target and model species that benefits agricultural and biomedical research. In addition, because of its similarity, the pig can be regarded as a good model of extrapolation to human (Alassane-Kpembi et al., 2015).

The aim of this *in vitro* study was to evaluate potential effects of natural product amygdalin combined with mycotoxin deoxynivalenol on the key regulators of cell proliferation and apoptosis in porcine ovarian granulosa cells.

MATERIAL AND METHODOLOGY

Preparation, culture and processing of granulosa cells from ovaries

Ovaries of pre-pubertal gilts ($n = 12$ per experiment) were obtained after slaughter at a local abattoir. Porcine ovaries were obtained from healthy Slovakian White gilts without visible reproductive abnormalities. The ovaries were transported to the laboratory in containers at 4°C and washed with sterile physiological solution. The follicular fluid was aspirated from 3 – 5 mm follicles. The granulosa cells (GCs) were isolated by centrifugation for 10 min at

200 x g followed by washing in sterile DMEM/F12 1 : 1 medium (BioWhittaker™, Verviers, Belgium) and resuspended in the same medium supplemented with 10% fetal calf serum (BioWhittaker™, Verviers, Belgium) and 1% antibiotic–antimycotic solution (Sigma, St.Louis, Mo, USA) at a final concentration of 10^6 cells.mL⁻¹ (as quantified by a haemocytometer). Portions of the cell suspension were dispensed to Lab-Tek 16 – well chamber slides (Nunc Inc., International, Naperville, USA, 100 μ L per well). The well plates were incubated at 37 °C and 5% CO₂ in humidified air until a 75% confluent monolayer was formed, at this point, the medium was renewed and ovarian GCs were incubated with the same supplements (DMEM/F12 1:1 medium, 10% fetal calf serum, with 1% antibiotic-antimycotic solution), without (control) or with amygdalin (1, 10, 100, 1000, 10 000 μ g.mL⁻¹) ($\geq 99\%$ purity, from apricot kernels, Sigma-Aldrich, St. Louis, Mo, USA) in combination with DON (1 μ g.mL⁻¹) (Romer Labs Division Holding GmbH, Tulln, Austria) for 24 h. After 24 h of culture the media from wells were removed and the wells from chamber slides were washed in ice-cold phosphate-buffered saline (PBS) (pH 7.5). Cells were fixed for 1h at room temperature in 4% paraformaldehyde.

Immunocytochemistry

Signaling substances within GCs plated on chamber slides were detected using immunocytochemistry method. The ImmunoCruz Staining System and primary mouse monoclonal antibodies against cyclin B1, Proliferating cell nuclear antigen (PCNA) and caspase-3 (Santa Cruz Biotechnology Inc., Santa Cruz, CA, USA) were used as directed by the manufacturer. Visualisation of the primary antibody binding sites were achieved with a secondary rabbit polyclonal antibody against mouse IGs, labelled with horseradish peroxidase (Sevac, Prague, Czech Republic; dilution 1 : 1000) and diaminobenzidine (DAB) reagent. Chamber slides stained with peroxidase/DAB reagent were mounted with Glycergel (DAKO, Carpinteria, CA, USA) mounting medium.

Statistical analysis

The proportions of cells containing specific immunoreactivity were calculated from inspection of at least 1000 cells per chamber. The data are presented as means of values obtained from three separate experiments performed on separate days using separate pools of ovaries from 10 – 12 animals. The significance of differences between the control and experimental groups was evaluated by One-Way ANOVA (Dunnett's multiple comparison test) using the statistical software GraphPad Prism 3.01 (GraphPad Software Inc., San Diego, CA, USA). The data are expressed as means \pm SEM. Differences were compared for statistical significance at the p -level less than 0.05 ($p < 0.05$).

RESULTS

The percentage of porcine ovarian granulosa cells (GCs) containing proliferative and apoptotic markers (cyclin B1, PCNA, caspase-3) after co-administration of amygdalin (1, 10, 100, 1000, 10 000 μ g.mL⁻¹) plus deoxynivalenol (1 μ g.mL⁻¹) was determined by immunocytochemistry.

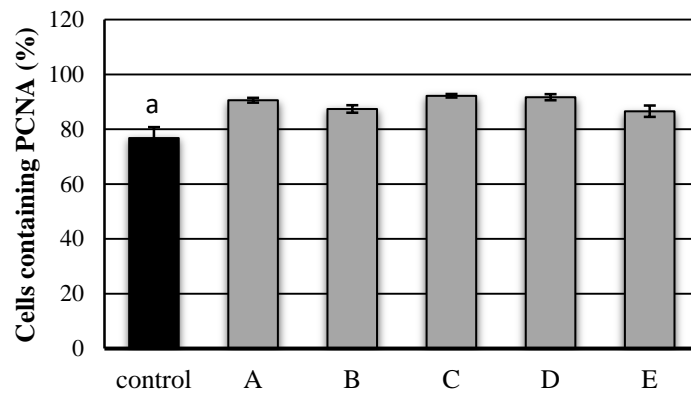

Figure 1 The percentage of granulosa cells containing PCNA (Proliferating cell nuclear antigen) after amygdalin addition combined with deoxynivalenol. The control group represents cells incubated without amygdalin and deoxynivalenol; experimental groups – A: 1 $\mu\text{g.mL}^{-1}$ amygdalin +1 $\mu\text{g.mL}^{-1}$ DON; B: 10 $\mu\text{g.mL}^{-1}$ amygdalin +1 $\mu\text{g.mL}^{-1}$ DON; C: 100 $\mu\text{g.mL}^{-1}$ amygdalin +1 $\mu\text{g.mL}^{-1}$ DON; D: 1000 $\mu\text{g.mL}^{-1}$ amygdalin +1 $\mu\text{g.mL}^{-1}$ DON; E: 10 000 $\mu\text{g.mL}^{-1}$ amygdalin +1 $\mu\text{g.mL}^{-1}$ DON. Signs *a, b* denote value significantly ($p < 0.05$) different from control group. Significance of differences between the groups was evaluated by One-way ANOVA (Dunnnett’s multiple comparison test). The data are expressed as means \pm SEM. Immunocytochemistry.

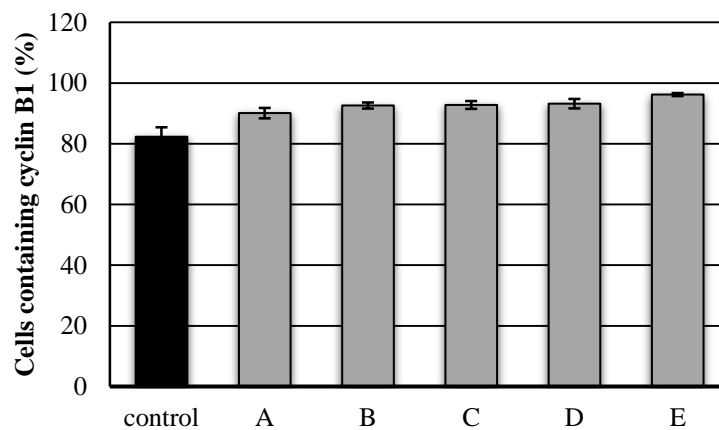

Figure 2 The percentage of granulosa cells containing cyclin B1 after amygdalin addition combined with deoxynivalenol. The control group represents cells incubated without amygdalin and deoxynivalenol; experimental groups – A: 1 $\mu\text{g.mL}^{-1}$ amygdalin +1 $\mu\text{g.mL}^{-1}$ DON; B: 10 $\mu\text{g.mL}^{-1}$ amygdalin +1 $\mu\text{g.mL}^{-1}$ DON; C: 100 $\mu\text{g.mL}^{-1}$ amygdalin +1 $\mu\text{g.mL}^{-1}$ DON; D: 1000 $\mu\text{g.mL}^{-1}$ amygdalin +1 $\mu\text{g.mL}^{-1}$ DON; E: 10 000 $\mu\text{g.mL}^{-1}$ amygdalin +1 $\mu\text{g.mL}^{-1}$ DON. Signs *a, b* denote value significantly ($p < 0.05$) different from control group. Significance of differences between the groups was evaluated by One-way ANOVA (Dunnnett’s multiple comparison test). The data are expressed as means \pm SEM. Immunocytochemistry.

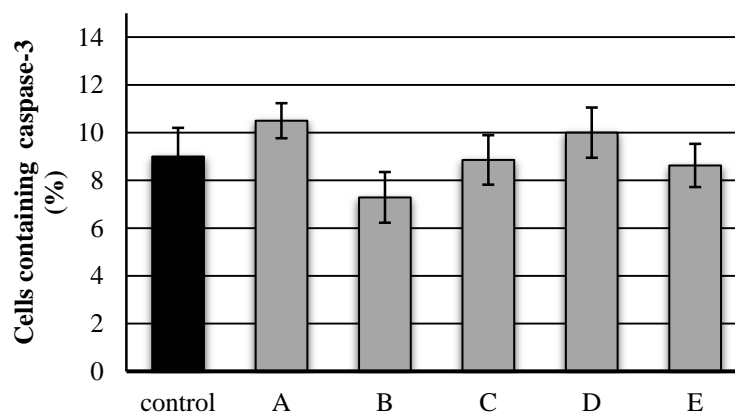

Figure 3 The percentage of granulosa cells containing caspase-3 after amygdalin addition combined with deoxynivalenol. The control group represents cells incubated without amygdalin and deoxynivalenol; experimental groups – A: 1 $\mu\text{g.mL}^{-1}$ amygdalin +1 $\mu\text{g.mL}^{-1}$ DON; B: 10 $\mu\text{g.mL}^{-1}$ amygdalin +1 $\mu\text{g.mL}^{-1}$ DON; C: 100 $\mu\text{g.mL}^{-1}$ amygdalin +1 $\mu\text{g.mL}^{-1}$ DON; D: 1000 $\mu\text{g.mL}^{-1}$ amygdalin +1 $\mu\text{g.mL}^{-1}$ DON; E: 10 000 $\mu\text{g.mL}^{-1}$ amygdalin +1 $\mu\text{g.mL}^{-1}$ DON. Significance of differences between the groups was evaluated by One-way ANOVA (Dunnnett’s multiple comparison test). The data are expressed as means \pm SEM. Immunocytochemistry.

Significant ($p < 0.05$) differences in the percentage of GCs containing cyclin B1 as well PCNA after amygdalin and deoxynivalenol (DON) treatment were observed, when compared to control untreated cells. Combination of amygdalin and DON induced significant ($p < 0.05$) increase in the number of cyclin B1 (Figure 1) and PCNA-positive (Figure 2) granulosa cells at all used concentrations. Moreover, the percentage of GCs with cyclin B1 peptide was higher along with increasing amygdalin plus DON concentrations. On the other hand, number of granulosa cells containing major apoptotic marker caspase-3 was not influenced by co-administration of amygdalin and DON (Figure 3).

DISCUSSION

Numerous studies demonstrated that granulosa cells play a fundamental role in the process of normal folliculogenesis, oocyte growth and development (Spicer et al., 2001; Petro et al., 2012; Rawan et al., 2015). Recently, specific *Fusarium* mycotoxins may directly interfere with cell proliferation and hormone production in porcine ovaries (Ranzenigo et al., 2008; Caloni et al., 2009; Medvedova et al., 2011; Cortinovis et al., 2014). Critical cellular kinases involved in signal transduction related to cell proliferation, differentiation and apoptosis are impaired by deoxynivalenol (Pestka and Smolinsky 2005). The ability of these mycotoxins to alter granulosa cell proliferation may compromise normal follicle development and oocyte function because granulosa cells provide essential nutrients to the oocyte (Petro et al., 2012).

To assess cell proliferation in porcine ovarian granulosa cells after co-exposure to amygdalin and deoxynivalenol, selected proliferation – associated peptides (cyclin B1 and PCNA) were evaluated in our experiments. Co-exposure of amygdalin and deoxynivalenol at all doses tested significantly increased number of granulosa cells containing both proliferative markers, cyclin B1 and PCNA. Proliferating cell nuclear antigen and cyclin B1 represent the fundamental peptides related to cell cycle, which are involved in the process of ovarian cell proliferation, growth and development (Naryzhny and Lee 2001; Tomanek and Chronowska 2006; Kolesarova et al., 2008, 2015).

Our previous study revealed dose-dependent response of porcine ovarian GCs to amygdalin alone or in combination with deoxynivalenol (Halénar et al., 2015). The presence of amygdalin alone induced a significant stimulation of 17β -estradiol release, but not progesterone, by porcine GCs at the highest used dose ($10\,000\ \mu\text{g}\cdot\text{mL}^{-1}$). However, combination of amygdalin with DON increased progesterone and 17β -estradiol release in dose-dependent manner. Therefore, these data suggest that amygdalin is shown to be potential regulator of 17β -estradiol but not progesterone in porcine ovarian GCs. Stimulatory effect of amygdalin combined with DON on progesterone secretion was clearly due to DON addition, not by amygdalin. Report of Kolesarova et al. (2012) has suggested protective actions of the natural substance resveratrol in mycotoxin induced reproductive toxicity in vitro. Their results showed stimulatory effects of resveratrol, DON and their combination on the release of progesterone by ovarian granulosa cells in dose-dependent manner.

Moreover, resveratrol effectively reduced the stimulatory action of DON on steroid hormone production.

Recent studies demonstrated the effect of various natural substances with protective (Kolesárova et al., 2012; Halénar et al., 2015) or toxic (Ranzenigo et al., 2008; Maruniakova et al., 2014) potential on the cellular processes in ovarian cells. Confirming previous results (Medvedova et al., 2011), porcine GCs exposure to DON had stimulatory effect on proliferative markers depending on concentrations of DON. Higher concentrations of DON increased significantly percentage of cyclin B1 as well PCNA positive cells when compared to control. On the other hand, Ranzenigo et al. (2008) demonstrated an inhibitory effect of DON on the proliferation of porcine granulosa cell in vitro. Examination of Maruniakova et al. (2014) indicates modulatory impacts of trichothecene mycotoxins, T-2 and HT-2 toxin, combined with insulin-like growth factor I (IGF-I) on the steroid hormone secretion in porcine ovarian granulosa cells in vitro.

Previous studies related to amygdalin have primarily focused on its purification, anti-tumor mechanism, determination in plants, as well as on toxicity caused by the release of cyanide (Rauws et al., 1982; Yildirim and Askin 2010; Zhou et al., 2012). An in vitro study of Makarevic et al. (2014) demonstrated that amygdalin was able to block the bladder cancer cell growth by down-modulating cell cycle regulating proteins cyclin A and cyclin dependent kinase 2. Additionally, amygdalin acted on the cdk1-cyclin B axis in PC3 cells after 2 weeks but not after 24 h, implying a time dependent mode of action (Makarevic et al., 2016). Histological analysis of rabbit femoral bones after intramuscular application of amygdalin was observed by Kovacova et al. (2016). Their results showed a significantly lower value of primary osteons' vascular canals and secondary osteons in bone microstructure of experimental rabbits. However, Tusimova et al. (2016) demonstrated no obvious impact of amygdalin application on the energy profile of rabbits in vivo.

As a central substance in death receptor pathway of the apoptosis, caspase-3 plays a key role in mediating nuclear apoptosis and is required for some typical nuclear and other morphological changes (Porter and Janicke 1999; Denault and Salvesen 2008). The present study revealed that the presence of caspase-3 in granulosa cells was not influenced by co-administration of amygdalin and deoxynivalenol, compared to untreated control cells. These findings are in accordance with results of Medvedova et al. (2011), who observed no substantial effect of DON on the expression of caspase-3 in porcine ovarian GCs. Conversely, previous report of Zhu et al. (2012) demonstrated the increase of caspase-3 accumulation in porcine granulosa cells after addition of other mycotoxin - zearalenone, and triggered a caspase-3-dependent apoptotic process.

Combinatory effects of isoflavone genistein with mycotoxin zearalenone on endometrial adenocarcinoma cell line were studied by Vejdovszky et al. (2016). Authors observed significant increase in alkaline phosphatase activity and cellular protein amounts after addition of both tested substances, suggesting slight proliferative effects and biphasic dose-response.

Taken all together, till obtained results suggest dose and species dependent effects of several natural substances on the cellular processes in ovaries, such as proliferation and programmed cell death - apoptosis.

CONCLUSION

In conclusion, results from this in vitro study indicate that co-exposure of amygdalin and deoxynivalenol may act to stimulate proliferation-associated peptides in porcine ovarian granulosa cells, and thus alter cell proliferation and normal follicular development. Considering the lack of information about the potential effects of natural products on the reproductive function in animals further research should be addressed.

REFERENCES

Alassane-Kpembé, I., Puel, O., Oswald, I. P. 2015. Toxicological interactions between the mycotoxins deoxynivalenol, nivalenol and their acetylated derivatives in intestinal epithelial cells. *Archives of Toxicology*, vol. 89, no. 8, p. 1337-1346. <https://doi.org/10.1007/s00204-014-1309-4> PMID:25033990

Arunachalam, C., Doohan, F. M. 2013. Trichothecene toxicity in eukaryotes: cellular and molecular mechanisms in plants and animals. *Toxicology Letters*, vol. 217, no. 2, p. 149-158. <https://doi.org/10.1016/j.toxlet.2012.12.003> PMID:23274714

Bromley, J., Hughes, B. G., Leong, D. C., Buckley, N. A. 2005. Life-threatening interaction between complementary medicines: cyanide toxicity following ingestion of amygdalin and vitamin C. *Annals of Pharmacotherapy*, vol. 39, no. 9, p. 1566-1569. <https://doi.org/10.1345/aph.1E634> PMID:16014371

Caloni, F., Ranzenigo, G., Cremonesi, F., Spicer, L. J. 2009. Effects of trichothecene, T-2 toxin, on proliferation and steroid production by GCs. *Toxicon*, vol. 54, no. 3, p. 337-344. <https://doi.org/10.1016/j.toxicon.2009.05.002> PMID:19463844

Cortinovis, C., Caloni F., Schreiber N. B., Spicer L. J. 2014. Effects of fumonisin B1 alone and combined with deoxynivalenol or zearalenone on porcine granulosa cell proliferation and steroid production. *Theriogenology*, vol. 81, no. 8, p. 1042-1049. <https://doi.org/10.1016/j.theriogenology.2014.01.027> PMID:24576714

Dänicke, S. 2002. Fusarium toxins in animal nutrition (Fusarium-toxine in der Tierernährung). *Grosstierpraxis*, vol. 3, p. 5-18.

Denault, J. B., Salvesen, G. S. 2008. Apoptotic caspase activation and activity. *Methods in Molecular Biology*, vol. 414, p. 191-220. https://doi.org/10.1007/978-1-59745-339-4_15

Deng, Y., Guo, Z. G., Zeng, Z. L., Wang, Z. 2002. Studies on the pharmacological effects of saffron (*Crocus sativus* L.). *Zhongguo Zhong Yao Za Zhi*, vol. 27, no. 8, p. 565-568. PMID:12776492

Desjardins, A. E. 2009. From yellow rain to green wheat: 25 years of trichothecene biosynthesis research. *Journal of Agricultural and Food Chemistry*, vol. 57, no. 11, p. 4478-4484. <https://doi.org/10.1021/jf9003847> PMID:19385595

Fukuda, T., Ito, H., Mukainaka, T., Tokuda, H., Nishino, H., Yoshida, T. 2003. Anti-tumor promoting effect of glycosides from *Prunus persica* seeds. *Biological and Pharmaceutical Bulletin*, vol. 26, no. 2, p. 271-273.

<https://doi.org/10.1248/bpb.26.271>

PMid:12576693

Halenár, M., Medved'ová, M., Maruniaková, N., Kolesárová, A. 2015. Assessment of a potential preventive ability of amygdalin in mycotoxin-induced ovarian toxicity. *Journal of Environmental Science and Health B*, vol. 50, no. 6, p. 411-416.

<https://doi.org/10.1080/03601234.2015.1011956>

PMid:25844862

Howard-Ruben, J., Miller, N. J. 1984. Unproven methods of cancer management. Part II: Current trends and implications for patient care. *Oncology Nursing Forum*, vol. 11, no.1, p. 67-73. PMID:6318190

Chandler, R. F., Anderson, L. A., Phillipson, J. D. 1984. Laetrile in perspective. *Canadian Pharmacists Journal*, vol. 117, p. 517-520.

Chang, H. K., Shin, M. S., Yang, H. Y., Lee, J. W., Kim, Y. S., Lee, M. H., Kim, J., Kim, K. H., Kim, C. J. 2006. Amygdalin Induces Apoptosis through Regulation of Bax and Bcl-2 Expressions in Human DU145 and LNCaP Prostate Cancer Cells. *Biological and Pharmaceutical Bulletin*, vol. 29, no. 8, p. 1597-1602. <https://doi.org/10.1248/bpb.29.1597> PMID:16880611

Kolesárová, A., Sirotkin, A. V., Kováčik, J. 2008. Endocrine and intracellular mechanisms of sexual gestation of gilts (Endokrinné a vnútrobunkové mechanizmy pohlavného dospievania prasničiek). 1st ed. Nitra, Slovakia : Slovak University of Agriculture, p. 131. ISBN 978-80-552-0109-2.

Kolesarova, A., Capcarova, M., Maruniakova, N., Lukac, N., Ciereszko, R. E., Sirotkin, A. V. 2012. Resveratrol Inhibits Reproductive Toxicity Induced by Deoxynivalenol. *Journal of Environmental Science and Health Part B*, vol. 47, no. 9, p. 1329-1334. <https://doi.org/10.1080/10934529.2012.672144> PMID:22540658

Kolesarova, A., Sirotkin, A. V., Mellen, M., Roychoudhury, S. 2015. Possible intracellular regulators of female sexual maturation. *Physiological research*, vol. 64, no. 3, p. 379-386. PMID:25536325

Kovacova, V., Omelka, R., Sarocka, A., Sranko, P., Adamkovicova, M., Toman, R., Halenar, M., Kolesarova, A., Martiniakova, M. 2016. *Potravinárstvo*, vol. 10, no. 1, p. 393-399. <https://doi.org/10.5219/625>

Larsen, J. C., Hunt, J., Perrin, I., Ruckebauer, P. 2004. Workshop on trichothecenes with a focus on DON: summary report. *Toxicology Letters*, vol. 153, no. 1, p. 1-22. <https://doi.org/10.1016/j.toxlet.2004.04.020> PMID:15342076

Lee, H. M., Moon, A. 2016. Amygdalin regulates apoptosis and adhesion in Hs578T Triple-Negative Breast Cancer Cells. *Biomolecules & Therapeutics (Seoul)*, vol. 24, no. 1, p. 62-66. <https://doi.org/10.4062/biomolther.2015.172> PMID:26759703

Makarević, J., Rutz, J., Juengel, E., Kaulfuss, S., Reiter, M., Tsaour, I., Bartsch, G., Haferkamp, A., Blaheta, R. A. 2014. Amygdalin blocks bladder cancer cell growth *in vitro* by diminishing cyclin A and cdk2. *PLoS ONE*, vol. 9, no. 8, p. 1-9. <https://doi.org/10.1371/journal.pone.0105590> PMID:25136960

Makarević, J., Juengel, E., Tsaour, I., Borgmann, H., Nelson, K., Thomas, C., Bartsch, G., Haferkamp, A., Blaheta, R. A. 2016. Amygdalin delays cell cycle progression and blocks growth of prostate cancer cells in vitro. *Life Sciences*, vol. 147, p. 137-142. <https://doi.org/10.1016/j.lfs.2016.01.039> PMID:26827990

- Maruniakova, N., Kadasi, A., Sirotkin, A. V., Bulla, J., Kolesarova, A. 2014. T-2 toxin and its metabolite HT-2 toxin combined with insulin-like growth factor-I modify progesterone secretion by porcine ovarian granulosa cells. *Journal of Environmental Science and Health Part A*, vol. 49, no. 4, p. 404-409. <https://doi.org/10.1080/10934529.2014.854650> [PMid:24345238](https://pubmed.ncbi.nlm.nih.gov/24345238/)
- Medvedova, M., Kolesarova, A., Capcarova, M., Labuda, R., Sirotkin, A. V., Kovacik, J., Bulla, J. 2011. The effect of deoxynivalenol on the secretion activity, proliferation and apoptosis of porcine ovarian granulosa cells in vitro. *Journal of Environmental Science and Health*, vol. 46, no.3, p. 213-219. <https://doi.org/10.1080/03601234.2011.540205> [PMid:21442537](https://pubmed.ncbi.nlm.nih.gov/21442537/)
- Moertel, C. G., Fleming, T. R., Rubin, J. A. 1982. Clinical trial of amygdalin in the treatment of human cancer. *The New England Journal of Medicine*, vol. 306, no. 4, p. 201-206. <https://doi.org/10.1056/NEJM198201283060403> [PMid:7033783](https://pubmed.ncbi.nlm.nih.gov/7033783/)
- Naryzhny, S. N., Lee, H. 2001. Protein profiles of the Chinese hamster ovary cells in the resting and proliferating stages. *Electrophoresis*, vol. 22, no. 9, p. 1764-1775. [https://doi.org/10.1002/1522-2683\(200105\)22:9<1764::AID-ELPS1764>3.0.CO;2-V](https://doi.org/10.1002/1522-2683(200105)22:9<1764::AID-ELPS1764>3.0.CO;2-V)
- Oyewole, O. I., Olayinka, E. T. 2009. Hydroxocobalamin (vitb12a) effectively reduced extent of cyanide poisoning arising from oral amygdalin ingestion in rats. *Journal of Toxicology and Environmental Health Sciences*, vol. 1, no. 1, p. 8-11.
- Parent-Massin, D. 2004. Haematotoxicity of trichothecenes. *Toxicology Letters*, vol. 153, no. 1, p. 75-81. <https://doi.org/10.1016/j.toxlet.2004.04.024> [PMid:15342083](https://pubmed.ncbi.nlm.nih.gov/15342083/)
- Pestka, J. J., Zhou, H. R., Moon, Y., Chung, Y. J. 2004. Cellular and molecular mechanisms for immune modulation by deoxynivalenol and other trichothecenes: unraveling a paradox. *Toxicology Letters*, vol. 153, no. 1, p. 61-73. <https://doi.org/10.1016/j.toxlet.2004.04.023> [PMid:15342082](https://pubmed.ncbi.nlm.nih.gov/15342082/)
- Pestka, J. J., Smolinski, A.T. 2005. Deoxynivalenol: toxicology and potential effects on humans. *Journal of Toxicology and Environmental Health. Part B, Critical Reviews*, vol. 8, no. 1, p. 39-69. <https://doi.org/10.1080/10937400590889458> [PMid:15762554](https://pubmed.ncbi.nlm.nih.gov/15762554/)
- Porter, A. G., Jänicke, R. U. 1996. Emerging roles of caspase-3 in apoptosis. *Cell Death and Differentiation*, vol. 6, no. 2, p. 99-104. <https://doi.org/10.1038/sj.cdd.4400476> [PMid:10200555](https://pubmed.ncbi.nlm.nih.gov/10200555/)
- Petro, E. M., Leroy, J. L., Van Cruchten, S. J., Covaci, A., Jorssen, E. P., Bols, P. E. 2012. Endocrine disruptors and female fertility: focus on (bovine) ovarian follicular physiology. *Theriogenology*, vol. 78, no. 9, p. 1887-1900. <https://doi.org/10.1016/j.theriogenology.2012.06.011> [PMid:22925646](https://pubmed.ncbi.nlm.nih.gov/22925646/)
- Ranzenigo, G., Caloni, F., Cremonesi, F., Aad, P. Y., Spicer, L. J. 2008. Effects of Fusarium mycotoxins on steroid production by porcine GCs. *Animal Reproduction Science*, vol. 107, no. 1-2, p. 115-130. <https://doi.org/10.1016/j.anireprosci.2007.06.023> [PMid:17656051](https://pubmed.ncbi.nlm.nih.gov/17656051/)
- Rauws, A. G., Olling, M., Timmerman, A. 1982. The pharmacokinetics of prunasin, a metabolite of amygdalin. *Journal of Toxicology. Clinical Toxicology*, vol. 19, no. 8, p. 851-856. <https://doi.org/10.3109/15563658208992518> [PMid:7182513](https://pubmed.ncbi.nlm.nih.gov/7182513/)
- Rawan, A. F., Yoshioka, S., Abe, H., Acosta, T. J. 2015. Insulin-like growth factor-1 regulates the expression of luteinizing hormone receptor and steroid production in bovine granulosa cells. *Reproduction in Domestic Animals*, vol. 50, no. 2, p. 283-91. <https://doi.org/10.1111/rda.12486> [PMid:25626338](https://pubmed.ncbi.nlm.nih.gov/25626338/)
- Song, Z., Xu, X. 2014. Advanced research on anti-tumor effects of amygdalin. *Journal of Cancer Resesarch & Therapy*, vol. 1, p. 3-7.
- Spicer, L. J., Alonso, J., Chamberlain, C. S. 2001. Effects of Thyroid Hormones on Bovine Granulosa and Thecal Cell Function *In Vitro*: Dependence on Insulin and Gonadotropins. *Journal of Dairy Science*. vol. 84, no. 5, p. 1069-1076. [https://doi.org/10.3168/jds.S0022-0302\(01\)74567-5](https://doi.org/10.3168/jds.S0022-0302(01)74567-5)
- Strugala, G. J., Stahl, R., Elsenhans, B., Rauws, A. G., Forth, W. 1995. Small-intestinal transfer mechanism of prunasin, the primary metabolite of the cyanogenic glycoside amygdalin. *Human Experimental Toxicology*, vol. 14, no. 11, p. 895-901. <https://doi.org/10.1177/096032719501401107> [PMid:8588951](https://pubmed.ncbi.nlm.nih.gov/8588951/)
- Tomanek, M., Chronowska, E. 2006. Immunohistochemical localization of proliferating cell nuclear antigen (PCNA) in the pig ovary. *Folia Histochemica et Cytobiologica*, vol. 44, no. 4, p. 269-274. [PMid:17219721](https://pubmed.ncbi.nlm.nih.gov/17219721/)
- Vejdovszky, K., Schmidt, V., Warth, B., Marko, D. 2016. Combinatory estrogenic effects between the isoflavone genistein and the mycotoxins zearalenone and alternariol in vitro. *Molecular Nutrition & Food Research*, vol. 61, no. 3, p. 1-12.
- Yidirim, F. A., Askin, M. A. 2010. Variability of amygdalin content in seeds of sweet and bitter apricot cultivars in Turkey. *African Journal of Biotechnology*, vol.9, no. 39, p. 6522-6524.
- Zhou, C., Qian, L., Ma, H., Yu, X., Zhang, Y., Qu, W., Zhang, X., Xia, W. 2012. Enhancement of amygdalin activated with β -D-glucosidase on HepG2 cells proliferation and apoptosis. *Carbohydrate Polymers*, vol. 90, no. 1, p. 516-523. <https://doi.org/10.1016/j.carbpol.2012.05.073> [PMid:24751072](https://pubmed.ncbi.nlm.nih.gov/24751072/)
- Zhu, L., Yuan, H., Guo, Ch., Lu, Y., Deng, S., Yang, Y., Wei, Q., Wen, L., He, Z. 2012. Zearalenone induces apoptosis and necrosis in porcine granulosa cells via a caspase-3- and caspase-9-dependent mitochondrial signaling pathway. *Journal of Cellular Physiology*, vol. 227, no. 5, p. 1814-1820. <https://doi.org/10.1002/jcp.22906> [PMid:21732350](https://pubmed.ncbi.nlm.nih.gov/21732350/)

Acknowledgments:

This work was financially supported by the Ministry of Education, Science, Research and Sport of the Slovak Republic projects no. 1/0039/16, 011SPU-4/2016 KEGA, APVV-0304-12, SK-FR-2015-0009 and European Community under project no. 26220220180: Building Research Centre „AgroBioTech“.

Contact address:

Marek Halenár, Slovak University of Agriculture, Faculty of Biotechnology and Food Sciences, Department of Animal Physiology, Tr. A. Hlinku 2, 949 76 Nitra, Slovakia, E-mail: halenarmarek@gmail.com

Marína Medved'ova, Slovak University of Agriculture, Faculty of Biotechnology and Food Sciences, Department

of Animal Physiology, Tr. A. Hlinku 2, 949 76 Nitra, Slovakia, E-mail: mata.medvedova@yahoo.com

Simona Baldovská, Slovak University of Agriculture, Faculty of Biotechnology and Food Sciences, Department of Animal Physiology, Tr. A. Hlinku 2, 949 76 Nitra, Slovakia, E-mail: sbaldovska@gmail.com

Katarína Michalcová, Slovak University of Agriculture, Faculty of Biotechnology and Food Sciences, Department

of Animal Physiology, Tr. A. Hlinku 2, 949 76 Nitra, Slovakia, E-mail: kmichalcova86@gmail.com

Adriana Kolesárová, Slovak University of Agriculture, Faculty of Biotechnology and Food Sciences, Department of Animal Physiology, Tr. A. Hlinku 2, 949 76 Nitra, Slovakia, E-mail: adriana.kolesarova@uniag.sk



METHYLYXANTHINES AND CATECHINES IN DIFFERENT TEAS (*CAMELLIA SINENSIS* L. KUNTZE) – INFLUENCE ON ANTIOXIDANT PROPERTIES

Július Árvay, Martin Hauptvogel, Eva Ivanišová, Ivana TirdiPová, Miroslava Hrstková,
Daniel Bajčan, Peter Lazor

ABSTRACT

In general, there are four basic types of tea: green (not fermented), black (fermented), oolong and white tea (partially fermented). The differences among these types are in the processing technology, which is largely reflected in their chemical composition. The most influential factor that significantly affects the quality and quantity of substances (biologically active) is the processing temperature, which causes changes in the composition (isomerization and/or transformation). The present paper focuses on monitoring content of three methylxanthines – alkaloids (caffeine, theophylline and theobromine), and seven flavan-3-ols – catechins ((+)-catechin (C), (-)-catechin-3-gallate (C-3-G), (-)-epicatechin (EC), (-)-epicatechin-3-gallate (EC-3-G), (-)-epigallocatechin-3-gallate (EGC-3-G), (-)-gallocatechin (GC) and (-)-gallocatechin-3-gallate (GC 3-G)), which are characteristic for tea. Attention was also given to the assessment of selected antioxidant parameters using spectrophotometric procedures (ABTS - radical cation decolorization assay and Phosphomolybdenum reducing antioxidant power assay) in relation to the determined substances using RP-HPLC/DAD analysis. Based on the results obtained, it can be concluded that a type of tea clearly affects the quality and quantity of the substances that have a positive impact on the consumer's health, significantly reflected in the levels of antioxidant active substances determined by the spectrophotometric procedures. The highest content of methylxanthin, catechins, polyphenols and antioxidant substances was recorded in the green tea sample GT3. The highest content of flavonoids and phenolic acids was recorded in the Pu-erh tea sample PT 5.

Keywords: methylxanthines; catechines; *Camellia sinensis* L.; tea; antioxidants

INTRODUCTION

Tea is the second most widely consumed drink, after water. Its global consumption reached 4.84 million tonnes in 2013 (FAO, 2015). The worldwide popularity of tea is based on several aspects and benefits, including therapeutic, refreshing, tasteful and ritual. Its regular and long-term consumption plays a significant role in terms of positive impact on the health of the consumer, which is caused by the presence of a number of biologically active and health-promoting substances (Sharangi, 2009).

The tea plant (*Camellia sinensis* L.) is evergreen plant growing in more than 45 countries worldwide (excluding North America) (Jeszka-Skowron et al., 2015). The biggest producers of dried tea include China, India, Kenya, Sri Lanka, Japan, Taiwan and Nepal (Marcos et al., 1998; FAO, 2015). Global production of black, green and instant tea exceeded 5 million tonnes in 2013 (FAO, 2015). The best conditions for growing tea are in tropical and subtropical areas with sufficient rainfall and well drained and acidic soils. However, it grows also in the alpine zone, which characteristically affects its phytochemical

composition. Only the top two leaves and bud is collected in two to three harvests during the growing season. The most valuable is the first harvest (spring). In the dry matter, it contains 25 – 35% of biologically active substances from the polyphenol group (Almajano et al., 2008). There are several types of tea recognized, depending on the technology of the raw tea processing. The most frequently consumed are green (unfermented), black (fermented), oolong and pu-erh tea (Árvay et al., 2015). Recently, the so called “scientific teas” that are specifically bred to increase a content of particular substances came to the fore. Such teas include GABA tea (Tsai et al., 2008) that is characterized by high acid γ -aminobutyric acid, which has positive effects on the prevention of diseases of the CNS.

Regular consumption of tea and tea beverages has a significant positive effect on the prevention of various civilization diseases such as high blood pressure (Chung et al., 2003), cardiovascular diseases (Kuriyama et al., 2015) tumours (Yao et al., 2004), digestive system cancers (Nechuta et al., 2012). It positively affects cardiovascular

system and lowers level of low density lipids and cholesterol (Chung et al., 2003). Major substances that are present in the tea leaves, as well as the actual drink include polyphenols (flavan-3-ols) that have the highest antioxidant activity of all tea substances (Nováková et al., 2010). Characteristic group of tea substances include also methylxanthines. Their content in dry matter of tea is as follows: caffeine (2.0 – 6.9%), theobromine (0.15 – 0.20%) and theophylline (0.02 – 0.04%) (Rahim et al., 2014).

Teas are generally characterized by a significantly positive biological effect on the consumer's health. They have a high content of broad spectrum of catechins. The most important compounds of this group are epicatechin (EC), epicatechin-3-gallate (ECG), epigallocatechin-3-gallate (EGC) and (-)-epigallocatechin-3-gallate (EGC-3-G) (Nováková et al., 2010). The latter is biologically one the most effective (Murakami et al., 2013).

Qualitative and quantitative determination of the 11 most active biological compounds in 30 samples of different kinds of tea and tea-substitutes was the main objective of this paper. The studied compounds belonging to the group of catechins were (+)-catechin (C), (-)-catechin-3-gallate (C-3-G), (-)-epicatechin (EC), (-)-epicatechin-3-gallate (EC-3-G), (-)-epigallocatechin-3-gallate (EGC-3-G), (-)-gallocatechin (GC) and (-)-gallocatechin-3-gallate (GC 3-G). The studied compounds from the group of methylxanthines were caffeine (CAF), theobromine (TBM) and theophylline (TFL). Analyses were conducted in tea infusions by RP-HPLC-DAD method. The data obtained were statistically processed and evaluated in terms of the total content of the main groups of the studied compounds. We also focused on monitoring antioxidant characteristics of water extracts using ABTS and phosphomolybdenum (PM) method and total amount of polyphenols (TPC), flavonoids (TFC) and phenolic acids (PAC).

MATERIAL AND METHODOLOGY

Materials – samples

The study focused on the qualitative and quantitative determination of seven catechins and three methylxanthines by RP-HPLC-DAD analysis, total content of polyphenols and flavonoids and two antioxidant parameters by spectrophotometry in 30 samples of different kinds of teas and/or tea-substitutes. Their characteristics (name, kind and country of origin) are shown in Table 1.

Chemicals

Single-component standards (theobromine, and theophylline), acetonitrile (HPLC gradient grade), methanol (HPLC grade) and phosphoric acid (ACS grade) were purchased from Sigma Aldrich (Sigma-Aldrich Chemie GmbH, Steiheim, Germany). Blended standard Green Tea Catechin Mix (GTCM) was purchased from Cerrilant company (Cerrilant Corp., RR, Texas, USA). Double deionized water (ddH₂O) was treated (18.2 MΩ.cm⁻¹) in a Simplicity 185 purification system (Millipore SAS, Molsheim, France). Chemicals used for the spectrophotometric analyses were analytical grade and purchased from CENTRALCHEM (Bratislava, Slovakia)

and Sigma Aldrich (Sigma-Aldrich Chemie GmbH, Steiheim, Germany).

Preparation of calibration solutions and samples

Single-component standard solutions were prepared by dissolving 5 mg of each compounds (with accuracy to 4 decimal places) in 10 mL of methanol (HPLC grade). Consequently, 100 µL of theobromine and theophylline standards were added to 1 mL GTCM blended standard.

Tea beverages were prepared by extraction of 1 g of dried tea in hot water (85 °C) in a volume of 100 mL for 5 minutes. The tea beverages were afterwards filtered through a Munktell filter paper No. 390 (Munktell & Filtrak, Bärenstein, Germany). After cooling, the filtrates were filtered again through syringe PVDF filters Q-Max (0.22 µm, 25 mm) (Frisenette ApS, Knebel, Denmark) prior to the HPLC analysis.

RP-HPLC-DAD analysis

All studied compounds were determined by HPLC Agilent 1260 (Agilent Technologies, Waldbronn, Germany) with quaternary solvent manager coupled with degasser (G1311B), sample manager (G1329B), column manager (G1316A) and DAD detector (G1315C). All analyses were performed on C18 endcapped column with reverse phase Purosphere® (4 mm x 250 mm x 5 µm) (Merck, KGaA, Darmstadt, Germany). Mobile phases consisted of acetonitrile (A) and 0.1% H₃PO₄ in ddH₂O (v/v) (B). The gradient elution was as follows: 0-1 min isocratic elution (20% A and 80% B), 1 – 5 min linear gradient elution (25% A and 75% B), 5 – 15 min (30% A and 70% B) and 20 – 25 min (40% A and 60% B). Postrun was 3 min. The mobile phase flow was 1 mL min⁻¹ and the sample injection was 10 µL. Column thermostat was set to 30 °C and the samples were kept at 4 °C the sampler manager. The detection wavelength was set at 265 nm, with scanning of the spectrum in the range of 210 – 400 nm. The spectral data were collected and processed using Agilent OpenLab ChemStation software for LC 3D Systems.

Total polyphenol content

The total polyphenol content in water extracts of the samples was determined by the methodology of Singleton and Rossi (1965) using the Folin-Ciocalteu reagent. The samples (100 µL) were mixed with 100 µL of the reagent, 1 mL of 20% solution of sodium carbonate and 8.8 mL of deionized water. The samples were left to stand for 30 minutes in the dark and then, absorbance of the samples at 700 nm was measured on a spectrophotometer Jenway 6405 UV/Vis (Cole-Parmer, England). Gallic acid (25 – 250 mg.L⁻¹; R² = 0.9978) was used as the standard and the results were calculated to the gallic acid equivalents (mg GA.g⁻¹).

Total flavonoid content

The total flavonoid content was determined by the modified method of Willett (2002). The extract (500 µL) was mixed with 100 µL of 10% ethanol solution of aluminum chloride, 100 µL of sodium acetate (c = 1 mol L⁻¹) and 4.3 mL of deionized water. After 30 minutes of standing in the dark, the absorbance of solutions was

Table 1 Basic characteristics of tea samples.

Name	Abbreviation	Country of origin
Quitou Lu (green)	GT 1	China
Ming Qiah (green)	GT 2	China
Ujitawara (green)	GT 3	Japan
Huang Da Cha (green)	GT 4	China
Huang Ya (green)	GT 5	China
Taimu Shan Bai (green)	GT 6	China
Taimu Shan Shou (green)	GT 7	China
Gan De Benshan (green)	GT 8	China
Quing Bei Huo (green)	GT 9	China
Hojicha Organic (green)	GT 10	Japan
Matcha Organic (green)	GT 11	Japan
Huang Zhi Xiang (green)	GT 12	China
Tonumo Guan Da (green)	GT 13	China
Tie Guan Yin (black)	BT 1	China
Gruzia Ramiz (black)	BT 2	Georgia
Darjeeling 2015 (black)	BT 3	India
Sungma Organic (black)	BT 4	India
Shaanxi Fu (pu-erh)	PT 1	China
Wyzhou Yi Liu (pu-erh)	PT 2	China
Bulang Gu Shu (pu-erh)	PT 3	China
Jin Pai Ban Hou (pu-erh)	PT 4	China
Gua Feng Zhai (pu-erh)	PT 5	China
2014 Kun Lu (pu-erh)	PT 6	China
Nan Jian Tulin (pu-erh)	PT 7	China
Yong De Lao (pu-erh)	PT 8	China
1995 Menghai (pu-erh)	PT 9	China
2008 Mengku (pu-erh)	PT 10	China
Yong De (tea flower)	YD 1	China
Kudingeha (Ku ding cha)	K 1	China
Jiaogulan (5-leaf ginseng)	J 1	China

measured at 415 nm on a spectrophotometer Jenway 6405 UV/Vis (Cole-Parmer, England). Quercetin ($1 - 400 \text{ mg.L}^{-1}$, $R^2 = 0.9996$) was used as a standard and the results were expressed in mg QE.g^{-1} .

Total phenolic acid content

The total content of phenolic acids was determined by the method of **Farmakopea Polska (1999)**. Water extract (0.5 mL) was mixed with 0.5 mL Arnova reagent (10% $\text{NaNO}_2 + 10\% \text{Na}_2\text{MoO}_4$). Afterwards, 0.5 mL of NaOH with $c = 1 \text{ mol L}^{-1}$ (w/v) and 0.5 mL of ddH₂O. The total content of phenolic acids was determined by the spectrophotometer Jenway 6405 UV/Vis (Cole-Parmer, England). Caffeic acid ($1 - 200 \text{ mg L}^{-1}$, $R^2 = 0.9996$) was used as a standard and the results were expressed in mg.g^{-1} caffeic acid equivalents.

ABTS radical cation decolorization assay

ABTS radical cation decolorization assay was determined by the method of **Re et al. (1999)** with slight modification. ABTS radical was dissolved in ddH₂O to 7 mM concentration and potassium persulphate added to a concentration of 2.45 mM. The resulted mixture was left to stand in the dark at room temperature overnight before further analysis. The resultant intensely-coloured ABTS⁺ radical cation was diluted with 0.01 M phosphate buffer saline (PBS), pH 7.00 to give an absorbance value of 0.70

at 734 nm. ABTS solution (2 Ml) was mixed with 098 mL of PBS and 0.02 mL of sample extract. Absorbance was measured spectrophotometrically on Jenway 6405 UV/Vis (Cole-Parmer, England) at time intervals of 6 minutes after addition of sample extract. Trolox ($10 - 100 \text{ mg.L}^{-1}$, $R^2 = 0.9991$) was used as the standard and the results were expressed in mg.g^{-1} Trolox equivalents.

Phosphomolybdenum reducing antioxidant power assay

Reducing power of the extract was determined by the method of **Prieto et al. (1999)**. The mixture of sample (1 mL), monopotassium phosphate (2.8 mL, 0.1 M), H₂SO₄ (6 mL, 1M), ammonium heptamolybdate (0.4 mL, 0.1 M) and ddH₂O (0.8 mL) was incubated at 90 °C for 120 min. Then rapidly cooled and detected by monitoring absorbance at 700 nm using Jenway 6405 UV/Vis spectrophotometer (Cole-Parmer, England). Trolox ($10-100 \text{ mg.L}^{-1}$, $R^2 = 0.9980$) was used as the standard and the results were expressed in mg g^{-1} Trolox equivalents.

Statistical analysis

All the data obtained were processed and evaluated by basic descriptive statistics (min., max., St. Dev., mean). The results are presented as mean values of four and/or three independent measurements.

RESULTS AND DISCUSSION

Methylxanthines and catechines content

All the studied components determined by the RP-HPLC/DAD process belong to the compounds that are characteristic for tea (da Silva Pinto, 2013). Their content is dependent on many factors (Sharangia, 2009).

The total content of methylxanthines (alkaloids) was on average $17.4 \pm 9.79 \text{ mg.g}^{-1} \text{ DW}$ in all samples. Relatively high standard deviation can be explained by a wide range of the sample types, but also by the presence of non-tea samples (YD 1, K 1 and J 1), in which the content of methylxanthines was not detected (in the YD 1 and K 1 samples, the content of caffeine was very low and the contents of theophylline and theobromine were below the detection limit (Table 2).

The highest content of the methylxanthines was recorded in the green tea GT 3 sample ($35.0 \pm 0.07 \text{ mg.g}^{-1} \text{ DW}$). In general, it can be concluded that the highest concentrations of caffeine as well as the sum of methylxanthines were recorded in the green tea samples (compared to the other kinds of tea). These results are confirmed by the findings of Bae et al. (2015) and Yi et al. (2015). Based on the sum of methylxanthines in the individual sample types, there was the following descending order: GT > PT > BT > YD 1 > K 1 > J 1.

All the data obtained are shown in Table 2. Similarly to the methylxanthines, teas are characterized by high content of broad spectrum of flavan-3-ols, commonly known as catechins (Wang et al., 2011). Along with caffeine, they represent a group of substances with the highest content

(da Silva Pinto, 2013).

Their content is dependent on several factors (like the content of alkaloids). On average, their content is around 30% in the dry matter of the tea tree leaves 30% (Balentine et al., 1997). The total content of catechins in the studied samples was $15.3 \pm 17.0 \text{ mg.g}^{-1} \text{ DW}$ ($\text{ND} - 64.3 \text{ mg.g}^{-1} \text{ DW}$). As was the case of the alkaloids, the very wide range of the amount of catechins was due to the high number of the sample types. The highest concentration of catechins was recorded in epigallocatechin-3-gallate (EGC-3-G).

The average concentration of catechins was $9.42 \pm 12.5 \text{ mg.g}^{-1} \text{ DW}$ ($\text{ND} - 46.6 \text{ mg.g}^{-1} \text{ DW}$). Content of EGC-3-G represents about 40% of the amount of catechins, which corresponds to the findings of Bae et al. (2015) and Yi et al. (2015). The highest concentration of EGC-3-G was recorded in the sample of green tea GT 3. In general, green tea contained the highest concentrations of this substance. Other samples contained lower concentrations of EGC-3-G, which is caused by different levels of fermentation and thus thermal degradation, and/or epimerisation (conversion) of the compound to other forms of flavan-3-ols (Scholz and Williamson, 2007). In terms of total content of catechins, it can be concluded that the GT3 sample had the highest quality from the health point of view. It is confirmed by the fact that it was the only sample that contained all forms of the studied catechins.

Total polyphenol content

Several studies dealing with monitoring the content of

Table 2 Content of methylxanthines and catechins in all samples ($\text{mg.g}^{-1} \text{ DW}$) (mean \pm St.Dev).

Sample	Methylxanthines				Catechines						
	TBM	TFL	CAF	GC	C	EGC-3-G	EC	GC-3-G	EC-3-G	C-3-G	
GT 1	2.63 \pm 0.01	1.47 \pm 0.00	30.9 \pm 0.03	ND	0.86 \pm 0.03	33.9 \pm 0.05	4.13 \pm 0.01	1.62 \pm 0.01	4.12 \pm 0.03	ND	
GT 2	1.59 \pm 0.01	0.53 \pm 0.00	27.4 \pm 0.10	ND	0.64 \pm 0.43	24.6 \pm 0.09	2.48 \pm 0.01	1.60 \pm 0.01	2.85 \pm 0.00	ND	
GT 3	1.48 \pm 0.00	1.88 \pm 0.00	35.0 \pm 0.07	ND	1.25 \pm 0.01	46.4 \pm 0.15	6.57 \pm 0.07	3.80 \pm 0.02	5.68 \pm 0.02	0.26 \pm 0.02	
GT 4	0.98 \pm 0.01	0.24 \pm 0.00	16.8 \pm 0.10	ND	0.42 \pm 0.28	4.24 \pm 0.16	0.81 \pm 0.01	1.24 \pm 0.01	0.80 \pm 0.04	ND	
GT 5	3.64 \pm 0.01	0.27 \pm 0.00	24.0 \pm 0.06	ND	0.16 \pm 0.33	25.6 \pm 0.07	2.05 \pm 0.01	0.89 \pm 0.04	4.58 \pm 0.03	ND	
GT 6	1.13 \pm 0.00	0.32 \pm 0.00	31.2 \pm 0.06	ND	ND	20.5 \pm 0.24	1.46 \pm 0.04	0.42 \pm 0.03	3.94 \pm 0.05	ND	
GT 7	0.35 \pm 0.01	ND	14.8 \pm 0.02	ND	ND	1.74 \pm 0.09	ND	ND	0.06 \pm 0.13	ND	
GT 8	0.24 \pm 0.01	0.63 \pm 0.00	5.74 \pm 0.01	ND	ND	3.70 \pm 0.02	2.24 \pm 0.01	ND	0.44 \pm 0.02	ND	
GT 9	0.31 \pm 0.01	0.26 \pm 0.00	5.49 \pm 0.02	ND	ND	1.36 \pm 0.01	0.68 \pm 0.01	ND	ND	ND	
GT 10	0.53 \pm 0.00	ND	10.4 \pm 0.02	1.46 \pm 0.01	0.70 \pm 0.01	0.76 \pm 0.01	0.98 \pm 0.83	0.96 \pm 0.02	ND	ND	
GT 11	0.54 \pm 0.01	1.11 \pm 0.00	20.2 \pm 0.09	ND	0.54 \pm 0.01	26.3 \pm 0.35	3.36 \pm 0.01	1.17 \pm 0.01	3.31 \pm 0.01	ND	
GT 12	0.68 \pm 0.02	0.64 \pm 0.00	14.1 \pm 0.02	ND	0.15 \pm 0.31	24.0 \pm 0.02	2.28 \pm 0.01	1.77 \pm 0.01	3.66 \pm 0.01	ND	
GT 13	0.91 \pm 0.02	0.61 \pm 0.00	8.96 \pm 0.01	ND	ND	5.67 \pm 0.01	1.85 \pm 0.00	0.85 \pm 0.01	0.76 \pm 0.01	ND	
BT 1	0.49 \pm 0.01	ND	10.6 \pm 0.03	ND	ND	ND	ND	0.37 \pm 0.03	ND	ND	
BT 2	1.24 \pm 0.01	ND	19.9 \pm 0.03	ND	ND	ND	ND	0.88 \pm 0.00	ND	ND	
BT 3	1.40 \pm 0.02	1.01 \pm 0.00	15.1 \pm 0.01	1.65 \pm 0.02	0.81 \pm 0.01	23.2 \pm 0.02	3.80 \pm 0.01	0.88 \pm 0.01	5.22 \pm 0.04	ND	
BT 4	2.04 \pm 0.01	ND	14.4 \pm 0.07	ND	0.58 \pm 0.01	7.89 \pm 0.09	1.82 \pm 0.01	1.71 \pm 0.01	5.10 \pm 0.04	ND	
PT 1	0.52 \pm 0.00	0.51 \pm 0.00	10.7 \pm 0.01	ND	ND	0.89 \pm 0.00	1.87 \pm 0.01	0.40 \pm 0.01	ND	ND	
PT 2	2.04 \pm 0.01	ND	24.6 \pm 0.06	ND	ND	ND	0.68 \pm 0.01	ND	ND	ND	
PT 3	2.81 \pm 0.00	0.30 \pm 0.11	21.2 \pm 0.02	ND	1.01 \pm 0.12	8.03 \pm 0.04	3.32 \pm 0.01	0.76 \pm 0.18	6.47 \pm 0.18	ND	
PT 4	2.52 \pm 0.01	0.18 \pm 0.00	18.6 \pm 0.34	ND	0.48 \pm 0.00	ND	2.70 \pm 0.02	ND	ND	ND	
PT 5	1.26 \pm 0.01	0.43 \pm 0.00	14.6 \pm 0.09	ND	1.52 \pm 0.01	7.86 \pm 0.14	7.04 \pm 0.02	0.85 \pm 0.00	6.37 \pm 0.27	ND	
PT 6	3.60 \pm 0.01	0.57 \pm 0.00	23.4 \pm 0.06	ND	1.97 \pm 0.08	15.9 \pm 0.06	7.30 \pm 0.01	1.42 \pm 0.01	11.9 \pm 0.01	ND	
PT 7	2.52 \pm 0.00	ND	19.8 \pm 0.01	ND	ND	ND	0.89 \pm 0.02	ND	ND	0.45 \pm 0.00	
PT 8	1.70 \pm 0.03	ND	11.6 \pm 0.05	ND	ND	ND	ND	ND	ND	ND	
PT 9	1.07 \pm 0.01	ND	8.85 \pm 0.04	ND	ND	ND	ND	ND	ND	0.26 \pm 0.02	
PT 10	1.80 \pm 0.00	ND	10.5 \pm 0.01	ND	ND	ND	ND	ND	ND	ND	
YD 1	ND	ND	3.15 \pm 0.01	ND	ND	ND	ND	ND	ND	ND	
K 1	ND	ND	0.71 \pm 0.00	ND	ND	ND	0.64 \pm 0.01	ND	ND	ND	
J 1	ND	ND	ND	15.8 \pm 0.13	ND	ND	ND	ND	ND	ND	

Note: The results are presented as mean values of four separate measurements of each sample.

biologically active substances with antioxidant effects in different types of teas point to the fact that tea drinks are a major source of polyphenol compounds (Bae et al., 2015; Wang and Helliwell, 2001). The results of polyphenol content are shown in Table 3. The highest concentration of polyphenols was recorded in the green tea sample GT 3 (75.3 ± 2.42 mg GAE.g⁻¹). In general, it can be stated that green tea and pu-erh tea had the highest polyphenol content. Our findings are confirmed by results of Oh et al. (2013), who studied antioxidant parameters in leaves of medicinal plants, and/or by Almajano et al. (2008), who observed antimicrobial and antioxidant parameters in 13 samples of tea drinks.

Total flavonoids content

The total content of flavonoids (TFC) varied widely ($0.65 - 22.3$ mg QE.g⁻¹ DW) in all the samples. The highest TFC value was recorded in the sample PT 5, and/or in all Pu-erh teas that had several times higher values compared with the other samples. This fact is caused by changes in the structure of the phenolic compounds during the the processing (Yi et al., 2015).

Total phenolic acids content

Phenolic acids comprise of a large group of substances that are primarily characterized as secondary metabolites

of plants. The largest sources of these substances are tea, coffee but also a variety of berries. Their main positive effect on the consumer's health results from many aspects, such as redox processes in metabolism, antimicrobial effects, preventive effect against cancer, etc. (Halliwell et al., 2012; Hollmann et al., 2011).

Our results indicate that the highest content of the phenolic acids was recorded in the samples of Pu-erh tea, particularly in the PT 5 sample (similarly to the content of flavonoids) ($42.8 \text{ mg} \pm 1.40$ CAE.g⁻¹). It is due to the characteristic processing technology and/or transformation processes during the processing.

ABTS radical cation decolorization assay

Determination by ABTS radical is based on the change of the solution colour after the addition of sample extracts. The advantage of this method is sensitive reaction to the lipophilic and hydrophilic substances with antioxidant properties, therefore its use is broad-range and particularly universal (Re et al., 1999). The content of the antioxidant substances ranged widely in the studied samples (Table 3). The highest average concentration was recorded in green and black teas. The highest value was recorded in the GT 3 sample (33.6 ± 0.98 mg TEAC.g⁻¹). Again, it is possible to state that green teas have a high content of substances with antioxidant activity. It is due to, mainly in green teas, the

Table 3 Antioxidant parameters of water extracts of all sample types (mean \pm St.Dev).

Sample	ABTS	PM	TPC	TFC	TPA
	mg TEAC.g ⁻¹	mg TEAC.g ⁻¹	mg GAE.g ⁻¹	mg QE.g ⁻¹	mg CAE.g ⁻¹
GT 1	17.4 \pm 1.94	288 \pm 1.92	48.5 \pm 3.39	1.92 \pm 0.50	9.67 \pm 0.16
GT 2	15.6 \pm 2.13	223 \pm 1.44	35.9 \pm 1.18	0.97 \pm 0.19	7.52 \pm 0.12
GT 3	33.6 \pm 0.98	515 \pm 8.93	75.3 \pm 2.24	3.77 \pm 0.29	17.9 \pm 0.20
GT 4	9.45 \pm 0.32	173 \pm 0.73	24.9 \pm 2.19	2.24 \pm 0.40	8.26 \pm 0.23
GT 5	9.34 \pm 0.61	161 \pm 6.40	27.6 \pm 1.03	0.29 \pm 0.03	5.93 \pm 0.28
GT 6	6.90 \pm 0.94	86.1 \pm 6.00	15.2 \pm 0.93	0.65 \pm 0.11	3.03 \pm 0.14
GT 7	3.61 \pm 0.73	53.9 \pm 2.20	13.9 \pm 1.36	0.78 \pm 0.19	2.14 \pm 1.11
GT 8	4.90 \pm 0.14	56.2 \pm 2.90	13.2 \pm 0.77	1.10 \pm 0.11	1.56 \pm 0.12
GT 9	5.23 \pm 0.60	44.8 \pm 0.96	17.8 \pm 0.51	0.72 \pm 0.11	1.46 \pm 0.08
GT10	5.37 \pm 0.41	80.0 \pm 2.65	11.0 \pm 0.44	0.97 \pm 0.19	4.05 \pm 0.08
GT11	26.2 \pm 0.49	481 \pm 1.21	29.9 \pm 0.68	2.24 \pm 0.29	14.6 \pm 0.16
GT12	19.1 \pm 0.53	260 \pm 10.7	22.6 \pm 0.89	1.16 \pm 0.19	11.0 \pm 0.24
GT13	15.8 \pm 2.15	239 \pm 2.94	18.0 \pm 1.12	1.35 \pm 0.19	9.04 \pm 0.16
BT 1	3.63 \pm 0.20	63.2 \pm 1.54	13.8 \pm 0.68	1.86 \pm 0.29	1.69 \pm 0.08
BT 2	8.34 \pm 0.14	76.9 \pm 2.09	16.7 \pm 2.22	5.35 \pm 1.16	5.17 \pm 0.68
BT 3	18.6 \pm 1.08	293 \pm 13.4	24.2 \pm 1.03	1.03 \pm 1.11	11.3 \pm 0.05
BT 4	23.2 \pm 0.38	381 \pm 11.7	32.1 \pm 1.80	5.29 \pm 0.88	17.9 \pm 0.21
PT 1	9.36 \pm 0.49	123 \pm 4.88	24.7 \pm 0.93	8.15 \pm 0.40	8.70 \pm 0.23
PT 2	7.58 \pm 0.14	148 \pm 1.69	29.4 \pm 3.45	11.7 \pm 0.40	20.2 \pm 1.43
PT 3	15.6 \pm 0.40	234 \pm 6.56	43.3 \pm 2.96	14.2 \pm 0.61	20.7 \pm 0.42
PT 4	11.9 \pm 1.56	161 \pm 7.72	34.9 \pm 1.56	13.2 \pm 0.67	19.3 \pm 0.09
PT 5	26.8 \pm 1.01	307 \pm 5.00	63.8 \pm 0.68	22.3 \pm 0.38	42.8 \pm 1.40
PT 6	14.7 \pm 1.36	199 \pm 0.48	32.5 \pm 2.68	13.3 \pm 2.02	14.5 \pm 0.73
PT 7	9.72 \pm 0.17	145 \pm 2.37	30.3 \pm 0.68	15.6 \pm 1.44	19.7 \pm 0.86
PT 8	5.14 \pm 0.86	56.4 \pm 2.94	15.2 \pm 0.26	7.00 \pm 1.34	5.38 \pm 0.31
PT 9	4.78 \pm 0.72	73.5 \pm 1.69	17.4 \pm 1.56	8.46 \pm 0.22	10.1 \pm 0.20
PT10	11.5 \pm 0.18	150 \pm 1.92	13.7 \pm 0.89	1.16 \pm 0.19	14.9 \pm 0.36
YD 1	7.01 \pm 1.30	314 \pm 8.00	12.5 \pm 0.68	1.29 \pm 0.29	7.68 \pm 0.20
K 1	6.92 \pm 1.24	182 \pm 1.00	15.6 \pm 1.36	2.94 \pm 0.29	24.1 \pm 0.88
J 1	4.02 \pm 0.38	114 \pm 2.54	11.0 \pm 0.44	4.59 \pm 0.33	4.47 \pm 0.59

Note: The results are presented as mean values of three separate measurements of each sample.

absence of fermentation, as well as thermal processes in the tea processing (Yi et al., 2015).

Phosphomolybdenum reducing antioxidant power assay

The principle of the method is based on a reduction of $\text{Mo}^{\text{VI}+} \rightarrow \text{Mo}^{\text{V}+}$ and the increase in the content of pentavalent molybdenum is detected and quantified by spectrophotometry. The values of the antioxidant power of the samples varied widely (similarly to the ABTS method). The highest concentration of the antioxidant substances was recorded in the green tea sample (GT 3) ($515 \pm 8.93 \text{ mg TEAC} \cdot \text{g}^{-1}$). In contrast to the ABTS method, categorization of the samples by this parameter cannot be explicitly determined. Compared with the results of Godočíková et al. (2016), who studied the antioxidant parameters of the two types of chocolates with different processing technology, it can be concluded that teas are richer in the antioxidantly active substances. The data obtained are shown in Table 3.

CONCLUSION

Tea contains a wide range of biologically active substances of distinct characteristics and chemical nature. Regular and long-term tea consumption thus have a significantly positive impact on the consumers' health. The study focused on monitoring ten characteristic substances belonging to the groups of methylxanthines (alkaloids) and flavan-3-ols (catechins). Especially the second group is typical for tea and contains important health-promoting attributes. Tea contains a wide range of substances providing antioxidant properties, especially green tea, which was confirmed at our study by two spectrophotometric methods.

Based on the results obtained, it can be concluded that the studied parameters are significantly dependent on the type of tea (and/or processing technology). Chemical composition, as well as biologically active substances have a positive effect on the antioxidant properties of tea and therefore provide certain health benefits.

REFERENCES

Almajano, M. P., Carbó, R., Lopéz-Jiménez, J. A., Gordon, M. H. 2008. Antioxidant and antimicrobial activities of tea infusions. *Food Chemistry*, vol. 108, no. 1, p. 55-63. <https://doi.org/10.1016/j.foodchem.2007.10.040>

Árvay, J., Hauptvogel, M., Tomáš, J., Harangozo, E. 2015. Determination of mercury, cadmium and lead contents in different tea and teas infusions (*Camellia sinensis* L.). *Potravinárstvo*, vol. 9, no. 1, p. 398-402. <https://doi.org/10.5219/510>

Bae, I. K., Ham, H. M., Jeong, M. H., Kim, D. H., Kim, H. J. 2015. Simultaneous determination of 15 phenolic compounds, and caffeine in teas and mate using RP-HPLC/UV detection: Method development and optimization of extraction process. *Food Chemistry*, vol. 172, p. 469-475. <https://doi.org/10.1016/j.foodchem.2014.09.050> PMID:25442580

Balentine, D. A., Wiseman, S. A., Bouwens, L. C. 1997. The chemistry of tea flavonoids. *Critical Reviews in Food Science and Nutrition*, vol. 37, no. 8, p. 693-704. <https://doi.org/10.1080/10408399709527797> PMID:9447270

da Silva Pinto, M. 2013. Tea: a new perspective on health benefits. *Food Research International*, vol. 53, no. 2, p. 558-567. <https://doi.org/10.1016/j.foodres.2013.01.038>

FAO. 2015. World tea production and trade Current and future development. Food and Agriculture Organisation. Report. [online] s.a. [cit. 2017-01-17] Available at: <http://www.fao.org/3/a-i4480e.pdf>.

Farmakopea Polska, V. 1999. 5th ed. Warszawa : PTFarm., p. 880-881. ISBN: 83-88157-04-3.

Godočíková, L., Ivanišová, E., Árvay, J., Petrová, J., Kačániová, M. 2016. The comparison of biological activity of chocolates made by different technological procedures. *Potravinárstvo*, vol. 10, no. 1, p. 316-322. <https://doi.org/10.5219/628>

Halliwell, B. 2012. Free radical and antioxidants: Updating a personal view. *Nutrition Reviews*, vol. 70, no. 5, p. 257-265. <https://doi.org/10.1111/j.1753-4887.2012.00476.x> PMID:22537212

Hollman, P. C. H., Cassidy, A., Comte, B., Heinonen, M., Richelle, E. 2011. The biological relevance of direct antioxidant effects of polyphenols for cardiovascular health in humans is not established. *Journal of Nutrition*, vol. 141, no. 5, p. 989-1009. <https://doi.org/10.3945/jn.110.131490> PMID:21451125

Chung, F. L., Schwartz, J., Herzog, C. R., Yang, Y. M. 2003. Tea and cancer prevention: Studies in animals and humans. *Journal of Nutrition*, vol. 133, no. 10, p. 3268-3274.

Jeszka-Skowron, M., Krawczyk, M., Zgola-Grzeškowiak, A. 2015. Determination of antioxidant activity, rutin, quercetin, phenolic acids and trace elements in tea infusions: Influence of citric acid addition on extraction of metals. *Journal of Food Composition and Analysis*, vol. 40, p. 70-77. <https://doi.org/10.1016/j.jfca.2014.12.015>

Kuriyama, S., Shimazu, T., Ohmori, K., Kikuchi, N., Nakaya, N., Nishino, Y., Tsubono, Y., Tsuji, I. 2015. Green tea consumption and mortality due to cardiovascular disease, cancer, and all causes in Japan: the Ohsaki study. *The Journal of the American Medical Association*, vol. 296, no. 10, p. 1255-1265.

Marcos, A., Fisher, A., Rea, G., Hill, S. J., 1998. Preliminary study using trace element concentrations and a chemometrics approach to determine geographical origin of tea. *Journal of Analytical Atomic Spectrometry*, vol. 13, p. 521-525. <https://doi.org/10.1039/a708658j>

Murakami, A. N. N., Amboni, R. D. M. C., Prudencio, E. S., Amante, E. R., Zanotta, L. M., Maraschin, M. 2013. Concentration of phenolic compounds in aqueous mate (*Ilex paraguariensis* A. St. Hil) extracts through nanofiltration. *Food Chemistry*, vol. 44, no. 10, p. 60-65. <https://doi.org/10.1016/j.foodchem.2013.02.119> PMID:23768327

Nechuta, S., Shu, X. O., Li, H. L., Yang, G., Ji, B. T., Xiang, Y. B., Cai, H., Chow, W. H., Gao, Y. T., Zheng, W. 2012. Prospective cohort study of tea consumption and risk of digestive system cancers: results from the Shanghai Women's Health Study. *The American Journal of Clinical Nutrition*, vol. 96, no. 5, p. 1056-1063. <https://doi.org/10.3945/ajcn.111.031419> PMID:23053557

Nováková, L., Spáčil, Z., Sifrtová, M., Opletal, L., Solich, P. 2010. Rapid qualitative and quantitative ultra high performance liquid chromatography method for simultaneous analysis of twenty nine common phenolic compounds of various structures. *Talanta*, vol. 80, no. 5, p. 1970-1979. <https://doi.org/10.1016/j.talanta.2009.10.056> PMID:20152441

- Oh, J., Jo, H., Cho, A. R., Kim, S. J., Han, J. 2013. Antioxidant and antimicrobial activities of various leafy herbal teas. *Food Control*, vol. 31, no. 2, p. 403-409. <https://doi.org/10.1016/j.foodcont.2012.10.021>
- Prieto, P., Pineda, M., Aguilar, M. 1999. Spectrophotometric quantitation of antioxidant capacity through the formation of a phosphomolybdenum complex: specific application to the determination of vitamin E. *Analytical Biochemistry*, vol. 269, no. 2, p. 337-341. <https://doi.org/10.1006/abio.1999.4019> PMID:10222007
- Rahim, A. A., Nofrizal, S., Saad, B. 2014. Rapid tea catechins and caffeine determination by HPLC using microwave-assisted extraction and silica monolithic column. *Food Chemistry*, vol. 147, p. 262-268. <https://doi.org/10.1016/j.foodchem.2013.09.131> PMID:24206716
- Re, R. N., Pellegrini, A., Pannala, M., Yang, R., Rice-Evans, C. 1999. Antioxidant activity applying an improved ABTS radical cation decolorization assay. *Free Radical Biology and Medicine*, vol. 26, no. 9-10, p. 1231-1237. [https://doi.org/10.1016/S0891-5849\(98\)00315-3](https://doi.org/10.1016/S0891-5849(98)00315-3)
- Scholz, S., Williamson, G. 2007. Interaction affecting the bioavailability of dietary polyphenols in vivo. *International Journal of Vitamin and Nutrition Research*, vol. 77, no. 3, p. 224-235. <https://doi.org/10.1024/0300-9831.77.3.224> PMID:18214024
- Sharangi, A. B. 2009. Medicinal and therapeutic potentialities of tea (*Camellia sinensis*, L.) – a review. *Food Research International*, vol. 42, no. 5-6, p. 529-535. <https://doi.org/10.1016/j.foodres.2009.01.007>
- Singleton, V. L., Rossi, J. A. 1965. Colorimetry of total phenolics with phosphomolybdic-phosphotungstic acid reagents. *American Journal of Enology and Agricultural*, vol. 16, p. 144-158.
- Tsai, Y. S., Wang, H. F., Ou, A. S. M. 2008. Biological Functions and Manufacturing of GABA Tea. In Ho et al. *Tea and tea products: Chemistry and health-promoting properties*. United States : CRC Press. 320 p. ISBN-10: 0849380820. <https://doi.org/10.1201/9781420008036.ch4>
- Wang, G., Helliwell, K. 2001. Determination of flavonols in green and black tea leaves and green tea infusions by high-performance liquid chromatography. *Food Research International*, vol. 34, no. 2-3, p. 223-227. [https://doi.org/10.1016/S0963-9969\(00\)00156-3](https://doi.org/10.1016/S0963-9969(00)00156-3)
- Wang, H., Chen, L. G., Xu, Y., Zeng, Q. L., Zhang, X. P., Zhao, Q. 2011. Dynamic microwave-assisted extraction coupled on-line with clean-up for determination of caffeine in tea. *LWT – Food Science and Technology*, vol. 44, no. 6, p. 1490-1495. <https://doi.org/10.1016/j.lwt.2011.01.015>
- Willett, W. C. 2002. Balancing life-style and genomics research for disease prevention. *Science*, vol. 292, no. 5568, p. 695-698. <https://doi.org/10.1126/science.1071055> PMID:11976443
- Yao, L. H., Jiang, Y. M., Shi, J., Tomás-Barberán, F. A., Datta, N., Singanusong, R. 2004. Flavonoids in food and their health benefits. *Plant Food and Human Nutrition*, vol. 59, no. 3, p. 113-122. <https://doi.org/10.1007/s11130-004-0049-7> PMID:15678717
- Yi, T., Zhu, L., Peng, W. L., He, X. C., Chen, H. L., Li, J., Yu, T., Liang, Z. T., Thao, Z. Z., Chen, H. B. 2015. Comparison of ten major constituents in seven types of processed tea using HPLC-DAD-MS followed by principal component and hierarchical cluster analysis. *LWT – Food Science and Technology*, vol. 62, no. 1, p. 194-201. <https://doi.org/10.1016/j.lwt.2015.01.003>

Acknowledgments:

This work was co-funded projects VEGA 1/0147/17, KEGA 015SPU-4/2016 and by the European Community project no 26220220180: Building the Research Centre „AgroBioTech“.

Contact address:

Július Árvay, Slovak University of Agriculture, Faculty of Biotechnology and Food Sciences, Department of Chemistry, Tr. A. Hlinku 2, 949 76 Nitra, Slovakia, E-mail: julius.arvay@gmail.com

Martin Hauptvogel, Slovak University of Agriculture, Faculty of European Studies and Regional Development, Department of Sustainable Development, Tr. A. Hlinku 2, 949 76 Nitra, Slovakia, E-mail: martin.hauptvogel@uniag.sk

Eva Ivanišová, Slovak University of Agriculture, Faculty of Biotechnology and Food Sciences, Department of Plant Storage and Processing, Tr. A. Hlinku 2, 949 76 Nitra, Slovakia, E-mail: eva.ivanisova@uniag.sk

Ivana Tirdil'ová, Slovak University of Agriculture, Faculty of Biotechnology and Food Sciences, Department of Chemistry, Tr. A. Hlinku 2, 949 76 Nitra, Slovakia, E-mail: xtirdilova@is.uniag.sk

Miroslava Hrstková, Slovak University of Agriculture, Faculty of Biotechnology and Food Sciences, Department of Chemistry, Tr. A. Hlinku 2, 949 76 Nitra, Slovakia, E-mail: miroslava.hrstkova@uniag.sk

Peter Lazor, Slovak University of Agriculture, Faculty of Biotechnology and Food Sciences, Department of Chemistry, Tr. A. Hlinku 2, 949 76 Nitra, Slovakia, E-mail: peter.lazor@uniag.sk



EFFECT OF GRAPE SEED EXTRACT ON QUALITY OF RAW-COOKED MEAT PRODUCTS

Marek Bobko, Peter Haščík, Miroslav Kročko, Lenka Trembecká, Andrea Mendelová, Jana Tkáčová, Peter Czako, Tomáš Tóth

ABSTRACT

In the present study we aimed to evaluate the oxidative stability of Spiš frankfurters after application of grape seeds extracts (Blauburger + Cabernet Sauvignon and Danube) in amount of 10 mL.kg⁻¹ during 12 days of their storage at 4 °C. Sensory evaluation of Spiš frankfurters was carried out after 4 days of storage by 6-point ranking system (Surface appearance and color, appearance and color when cut, texture, aroma and flavor). It was found that sensory quality of Spiš frankfurters was not significantly ($p > 0.05$) affected by application of grape seed extracts. Oxidation stability of Spiš frankfurters after 12 days of storage at 4 °C was positively influenced ($p \leq 0.05$) only in the group with addition of extract made from grape seed Blauburger + Cabernet Sauvignon. This may probably related with the higher antioxidant activity of extract of this variety (100.5%) compared to an extract made from grape seed variety of Danube (55.8%). Also, it was not found significant differences ($p > 0.05$) of antioxidant activity between extract made from grape seeds variety Danube compared with the control group.

Keywords: grape seed; extract; Spiš frankfurter; oxidative stability; sensory quality

INTRODUCTION

The lipid oxidation is one of the major problems in meat industries. Meat products that are constituted of lipid and polyunsaturated fatty acids (PUFAs) tend to deteriorate due to lipid oxidation, leading to development of unpleasant flavours during processing and storage (Sanchez-Moreno et al., 1999; Mielink et al., 2006). In addition to the undesirable quality, the adverse effect of lipid oxidation leads to the development of free radicals which are involved in diseases and a range of disorders including cancer, arthritis, atherosclerosis, Alzheimer's disease, and diabetes. To prevent lipid oxidation in meat products, synthetic antioxidants can be used. However, synthetic antioxidants such as butylated hydroxyanisole (BHA) and butylated hydroxytoluene (BHT) have been shown to be carcinogenic and have, thus, restricted use in foods (Baydar et al., 2007).

In the past few years, various plant materials containing phenolic compounds have been demonstrated to be effective antioxidants in model systems. Flavonoids, the most potent antioxidative compounds of plant phenolics occur in vegetables, fruits, berries, herbs, and tea leaves (Wrolstad and Skrede, 2002).

According to the estimates provided by the Organisation Internationale de la Vigne et du Vin (OIV), annual process of grapes is estimated at around 66.5 million tonnes, with 38 million tonnes produced in Europe. At

European level, the grape pomace production is about 8 million tonnes per year in total (Burg et al., 2014).

A significant part of the grape pomace is comprised by grape seed which amounts to 38 – 52% on dry matter basis (Maier, 2009).

Among the beneficial effects of parts of a grape, grape seeds are believed to have a powerful antioxidant property due to its rich source of polyphenol compounds. The polyphenol compounds in grape seeds are in range of 60 – 70%, only 10 % is in the fruit, and 28 – 35% in the peels (Garcia-Marino et al., 2006; Nawaz et al., 2006).

It is likely that the demand for using natural antioxidants such as grape seed extract (GSE) has greatly increased in recent years. GSEs are substantially constituted with proanthocyanidins. They can react with free radicals and catalyzed metal ions necessary for the oxidation reaction then terminate chain reactions by removing radical intermediates, and inhibit other oxidation reactions by being oxidized themselves (Shahidi and Wanasundara, 1992; Sanchez-Moreno et al., 1999). The phenolic substances in GSE ranges from 80% to 99%, the most important being resveratrol (trans-3,4',5-trihydroxystilbene). Due to the strong antioxidant activity of resveratrol, it can inhibit peroxidation in a concentration-dependent manner. It does not scavenge hydroxyl radical nor does it react with H₂O₂, making it an

inefficient catalyst of subsequent oxidation (Murcia and Martinez-Tome, 2001).

In addition, GSE is rich in proanthocyanidins. The multiple mechanisms of their antioxidative activity are expressed in its ability of radical scavenging, metal chelation, and synergism with other antioxidants (Lu and Foo, 1999).

Based on the findings of many researches (Lau and King, 2003; Mielnik et al., 2006; Ahn et al., 2007; Goni et al., 2007; Brenes et al., 2010; Tekeli et al., 2014; Iqbal et al., 2015; Lichovnikova et al., 2015; Tournour et al., 2016; Guerra-Rivas et al., 2016; Brenes et al., 2016), application of grape pomace has been shown to exert a positive effect on animal products, such as improving the carcass parameters in chickens, oxidation stability and storage of meat products, egg production (Sahin et al., 2010; Kara and Kocaoglu-Guclu, 2012; Kara et al., 2016), and in raw-cooked meat products (Özvural and Vural, 2011; Özvural and Vural, 2013; Ryu et al., 2014).

The present study aimed to determine the effect of GSE application on quality (oxidative stability, sensory quality) of raw-cooked meat products (Spiš frankfurters) stored at 4 °C.

MATERIAL AND METHODOLOGY

The tested raw-cooked meat products (Spiš frankfurters) were made from pork meat and additional raw materials purchased at a market and processed according to the recipe for the product type (Table 1). Three groups of meat products were evaluated. The groups were formed on the basis of various additions of GSE during the mixing in a bowl cutter, as follows:

- control group (C),
- experimental group 1 (E1): 10 ml of GSE Blauburger and Cabernet Sauvignon per 1 kg of meat mixture,
- experimental group 2 (E2): 10 ml of GSE Dunaj per 1 kg of meat mixture.

The GSE-treated meat product was smoked and heat-treated (temperature in a product core reached 70 °C and persisted for 10 min). After the heat-treatment, the product was cooled to 4 °C. Meat samples were stored at 4 ±1 °C during the experimental period (12 days).

Preparation of grape seed extract

Extraction of grape seeds was carried according to Shirahigue et al. (2010). The homogenized grape seeds (20 g) were mixed with 100 mL of 80% ethanol in a laboratory shaker in the dark and at room temperature for 24 hours. Subsequently, the liquid phase was separated from the solid phase by filtration and added into volumetric flask. The 80% ethanol was then added until a

total volume of 100 mL. After that, the liquid fraction was evaporated in the vacuum rotary evaporator at 65 °C. The dry residue was weighed and redissolved in 50 mL of distilled water. The extract was then applied into raw-cooked meat product in an amount of 10 mL per 1 kg of raw material.

Assessment of antioxidant activity (AOA) with DPPH radical

The DPPH (2,2-diphenyl-1-picrylhydrazyl) inhibition in GSE according to method of Brand-Williams et al. (1995). The DPPH radical is used to quantify the ability of antioxidants to quench the DPPH radical. The dark purple colour of DPPH will be lost when it is reduced to its nonradical form stable organic nitrogen centred free radical with a dark purple colour which when reduced to its nonradical form by antioxidants becomes colourless. When the DPPH radical is scavenged, the colour of the reaction mixture changes from purple to yellow and decrease of the DPPH radical is measured spectrophotometrically. On the determination of AOA used which in ethanol solution is in colourless radical form. Its reduction is manifested by the change of colour of solution and is measured spectrophotometrically. Gallate was used as standard and the amount of AOA sample expressed as gallate equivalent was calculated.

Determination of the oxidative stability

During four storage times (day 1, 4, 8, and 12), oxidative stability of meat product samples was determined according to Marciničák et al. (2010). The method is based on the rupture of lipid bilayer by free radical to form malondialdehyde (MDA) as a secondary product. Two molecules of thiobarbituric acid react with one molecule of MDA to form pink coloured product showing maximum absorbance at 532 nm called TBARS. The absorbance was measured using UV spectrophotometer (Jenway UV-VIS Spectrophotometer). The results were calculated as malondialdehyde (MDA) quantity per 1 g of sample.

Sensory evaluation

Sensory quality of raw-cooked meat products (n = 9) after cooking (80 °C, 5 min) was assessed by five-member panel on the 4th day after processing. Sensory characteristics of meat products including surface appearance and colour, appearance and colour in cross-section, texture, aroma, and taste on a six-point hedonic scale (6 = very good, 1 = very bad).

Results of the experiment was evaluated with statistical program Statgraphics Plus version 5.1 (AV Trading Umex, Dresden, Germany), were calculated variation-statistical values (mean, standard deviation) and to determine the

Table 1 Composition of meat product (g).

Component	Amount
Pork meat	1000
Water	200
Curing salt	18
Garlic (<i>Allium sativum</i>)	0.5
Red pepper (<i>Capsicum annuum</i>)	6.2
Chilli pepper (<i>Capsicum frutescens</i>)	6.2
Polyphosphate	7

significant difference between groups was used variance analyse with subsequent Scheffe test.

RESULTS AND DISCUSSION

Antioxidant activity assessment of applied grape seed extracts of different grape varieties is shown in Table 2. In Blauburger and Cabernet Sauvignon grape varieties applied in E1 group was observed higher antioxidant activity (100.5%) than that in Cabernet Sauvignon grape variety (55.8%). Similarly, **Slezák (2007)**, **Bajčan et al. (2015)**, and **Špakovská et al. (2012)** found AA in the range of 69 – 90.9% in red wine grape varieties. In addition, similar AA values (61.4 – 87.1%) found **El-Beshbishy et al. (2009)** in red grape seed extracts.

Oxidation of meat lipids is a complex process and its dynamics depend on numerous factors including chemical composition of meat, light and oxygen access, and storage temperature. The manufacturing processes of meat products cause degradation of the muscle membrane system and have a strong impact on the oxidation of intracellular fat, primarily phospholipids (**Marcinčák et al., 2010; Karakaya et al., 2011**). Thermal treatment makes oxidative processes faster, what significantly changes the value of thiobarbituric acid. The level of oxidative damage of lipids in the manufacture and storage of poultry sausages is presented in Table 3.

As regards determination of oxidative stability of raw-cooked meat products (stored at 4 °C) on day 1, the highest MDA content was found in control group (0.107 mg.kg⁻¹) compared to experimental groups E1 and E2 (0.097 and 0.102 mg.kg⁻¹, respectively). The highest oxidative stability for all the storage times was observed in

E1 group that coincides with the highest antioxidant activity (100.5 ±0.7%) of grape varieties extracts added in this group (Blauburger and Cabernet Sauvignon) compared to Dunaj GSE added in E2 group (55.8 ±0.8%). On day 12, the lowest MDA content was found in E1 group (0.192 mg.kg⁻¹) compared to E2 and C groups (0.207 and 0.221 mg.kg⁻¹, respectively). On the whole, addition of GSE all the grape varieties examined in the present study resulted in increasing the oxidative stability and thus extending the storage life of raw-cooked meat products, which is consistent with the findings of **Mielnik et al. (2006)**, **Özvural and Vural (2010)**, **Özvural and Vural (2013)**, and **Ryu et al. (2014)**.

The mean scores of sensory characteristics of raw-cooked meat products (surface appearance and colour, appearance and colour in cross-section, texture, aroma, and taste) after addition of GSE are presented in Table 4. The highest mean scores for each sensory characteristic was found in control group, however, no significant differences ($p > 0.05$) among the groups were detected. The results demonstrated that GSE of grape varieties investigated in the present study had no significant effect ($p > 0.05$) on sensory characteristics of raw-cooked meat products since the panelists did not perceive differences among the samples. Moreover, the samples from experimental groups were shown to be less acceptable in appearance and colour in cross-section and texture than that from control group. Similar results were found in study of **Brannan (2009)** who investigated grape seed in ground chicken, as well as **Kulkarni et al. (2011)** who investigated grape seed in beef sausages, with no significant effects on sensory quality.

Table 2 Antioxidant activity (AA) of grape seed extracts of different grape varieties (%). Values are given as mean ±SD.

Grape variety	AA
Blauburger and Cabernet Sauvignon	100.5 ±0.7
Dunaj	55.8 ±0.8

Note: mean – average; SD – standard deviation.

Table 3 Values of thiobarbituric number during the storage expressed as MDA (mg.kg⁻¹). Values are given as mean ±SD.

Storage time	Group			p-value
	C	E1	E2	
Day 1	0.107 ±0.007	0.097 ±0.006	0.102 ±0.005	0.086
Day 4	0.122 ±0.013	0.107 ±0.011	0.116 ±0.008	0.185
Day 8	0.179 ±0.011	0.158 ±0.019	0.170 ±0.005	0.139
Day 12	0.221 ±0.015 ^a	0.192 ±0.010 ^b	0.207 ±0.014 ^{ab}	0.028

Note: MDA – malondialdehyde; C – control group; E1, E2 – experimental groups; a, b – means within a row with different superscripts differ significantly at $p \leq 0.05$; mean – average; SD – standard deviation.

Table 4 Sensory evaluation of raw-cooked meat products. Values are given as mean ±SD.

Sensory characteristic	Group			p-value
	C	E1	E2	
Surface appearance and colour	5.40 ±0.490	5.20 ±0.510	5.40 ±0.800	0.587
Appearance and colour in cross-section	5.60 ±0.374	5.40 ±0.374	5.40 ±0.374	0.471
Texture	5.80 ±0.400	5.50 ±0.775	5.50 ±0.447	0.347
Aroma	5.70 ±0.400	5.50 ±0.447	5.60 ±0.490	0.524
Taste	5.50 ±0.447	5.40 ±0.374	5.50 ±0.447	0.740

Note: C – control group; E1, E2 – experimental groups.

CONCLUSION

It can be concluded that the sensory quality was not significantly ($p > 0.05$) affected by application of extracts from grape seeds (Blauburger + Cabernet Sauvignon and Danube) in amount 10 ml.kg⁻¹ of produced spiske sausages. Oxidation stability of Spiš frankfurters after 12 days of storage at 4 °C was positively influenced ($p \leq 0.05$) only in the group with addition of extract made from grape seed Blauburger + Cabernet Sauvignon. This may probably related with the higher antioxidant activity of extract of this variety (100.5%) compared to an extract made from grape seed variety of Danube (55.8%).

REFERENCES

- Ahn, J., Grün, I., Mustapha, A. 2007. Effects of plant extracts on microbial growth, color change, and lipid oxidation in cooked beef. *Food Microbiology*, vol. 24, no. 1, p. 7-14. <https://doi.org/10.1016/j.fm.2006.04.006> PMID:16943089
- Bajčan, D., Šimanský, V., Tóth, T., Árvay, J. 2015. Colour, Phenolic content and antioxidant activity of the Slovak Alibernet red wine samples. *Journal of Microbiology, Biotechnology and Food Sciences*, vol. 4, special no. 3, p. 5-8.
- Baydar, N. G., Özkan, G., Yasar, S. 2007. Evaluation of the antiradical and antioxidant potential of grape extracts. *Food Control*, vol. 18, no. 9, p. 1131-1136. <https://doi.org/10.1016/j.foodcont.2006.06.011>
- Brannan, R. G. 2009. Effect of grape seed extract on descriptive sensory analysis of ground chicken during refrigerated storage. *Meat Science*, vol. 81, no. 4, p.589-595. <https://doi.org/10.1016/j.meatsci.2008.10.014> PMID:20416587
- Brand-Williams, W., Cuvelier, M. E., Berset, C. 1995. Use of a free radical method to evaluate antioxidant activity. *LWT – Food Science and Technology*, vol. 28, no. 1, p. 25-30. [https://doi.org/10.1016/S0023-6438\(95\)80008-5](https://doi.org/10.1016/S0023-6438(95)80008-5)
- Brenes, A., Viveros, A., Chamorro, S., Arija, I. 2016. Use of polyphenol-rich grape by-products in monogastric nutrition. A review. *Animal Feed Science and Technology*, vol. 211, p. 1-17. <https://doi.org/10.1016/j.anifeedsci.2015.09.016>
- Brenes, A., Viveros, A., Goñi, I., Centeno, C., Saura-Calixto, F., Arija, I. 2010. Effect of grape seed extract on growth performance, protein and polyphenol digestibilities, and antioxidant activity in chickens. *Spanish Journal of Agricultural Research*, vol. 8, no. 2, p. 326. <https://doi.org/10.5424/sjar/2010082-1199>
- Burg, P., Dědina, M., Hejtmankova, A. Hejtmankova, K., Jelinek, A., Lachman, J., Lipavsky, J., Mašan, V., Pivec, V., Skala, O., Střalkova, R., Taborsky, J., Zemanek, P. 2014. *The study of biologically active compounds in grapevine seeds and annual shoots and possibilities obtaining oil from the seeds*. 1st ed. Brno : Mendelova univerzita v Brně. 93 p. ISBN 978-80-7509-165-9.
- Garcia-Marino, M., Rivas-Gonzalo, J. C., Ibáñez, E., Garcia-Moreno, C. 2006. Recovery of catechins and proanthocyanidins from winery by-products using subcritical water extraction. *Analytica Chimica Acta*, vol. 563, no. 1-2, p. 44-50. <https://doi.org/10.1016/j.aca.2005.10.054>
- Goni, I., Brenes, A., Centeno, C., Viveros, A., Saura-Calixto, F., Rebole, A., Estevez, R. 2007. Effect of Dietary Grape Pomace and Vitamin E on Growth Performance, Nutrient Digestibility, and Susceptibility to Meat Lipid Oxidation in Chickens. *Poultry Science*, vol. 86, no. 3, p. 508-516. <https://doi.org/10.1093/ps/86.3.508> PMID:17297163
- Guerra-Rivas, C., Vieira, C., Rubio, B., Martínez, B., Gallardo, B., Mantecón, A. R., Lavín, P., Manso, T. 2016. Effects of grape pomace in growing lamb diets compared with vitamin E and grape seed extract on meat shelf life. *Meat Science*, vol. 116, p. 221-229. <https://doi.org/10.1016/j.meatsci.2016.02.022> PMID:26908145
- El-Beshbishy, H. A., Mohamadin, A. M., Abdel-Naim, A. B. 2009. *In Vitro* Evaluation of the Antioxidant Activities of Grape Seed (*Vitis vinifera*) Extract, Blackseed (*Nigella sativa*) Extract and Curcumin. *Journal of Taibah University Medical Sciences*, vol. 4, no. 1, p. 23-35. [https://doi.org/10.1016/S1658-3612\(09\)70078-2](https://doi.org/10.1016/S1658-3612(09)70078-2)
- Iqbal, Z., Kamran, Z., Sultan, J. I., Ali, A., Ahmad, S., Shahzad, M. I., Ahsam, U., Ashraf, S., Sohail, M. U. 2015. Replacement effect of vitamin E with grape polyphenols on antioxidant status, immune, and organs histopathological responses in broilers from 1- to 35-d age. *The Journal of Applied Poultry Research*, vol. 24, no. 2, p. 127-134. <https://doi.org/10.3382/japr/pfv009>
- Kara, K., Kocaoglu Güçlü, B., Baytok, E., Şentürk, M. 2015. Effects of grape pomace supplementation to laying hen diet on performance, egg quality, egg lipid peroxidation and some biochemical parameters. *Journal of Applied Animal Research*, vol. 44, no. 1, p. 303-310. <https://doi.org/10.1080/09712119.2015.1031785>
- Kara, K., Kocaoglu-Guclu, B. 2012. The Effects of Different Molting Methods and Supplementation of Grape Pomace to the Diet of Molted Hens on Postmolt Performance, Egg Quality and Peroxidation of Egg Lipids. *Journal of Faculty of Veterinary Medicine, Erciyes University*, vol. 9, p. 183-196.
- Karakaya, M., Bayrak, E., Ulusoy, K. 2011. Use of natural antioxidants in meat and meat products. *Journal of Food Science and Engineering*, vol. 1, p. 1-10.
- Kulkarni, S., DeSantos, F. A., Kattamuri, S., Rossi, S. J., Brewer, M. S. 2011. Effect of grape seed extract on oxidative, color and sensory stability of a pre-cooked, frozen, re-heated beef sausage model system. *Meat Science*, vol. 88, no. 1, p. 139-144. <https://doi.org/10.1016/j.meatsci.2010.12.014> PMID:21193269
- Lau, D. W., King, J. 2003. Pre- and Post-Mortem Use of Grape Seed Extract in Dark Poultry Meat To Inhibit Development of Thiobarbituric Acid Reactive Substances. *Journal Of Agricultural and Food Chemistry*, vol. 51, no. 6, p. 1602-1607. <https://doi.org/10.1021/jf020740m> PMID:12617591
- Lichovnikova, M., Kalhotka, L., Adam, V., Klejduš, B., Anderle, V. 2015. The effects of red grape pomace inclusion in grower diet on amino acid digestibility, intestinal microflora, and sera and liver antioxidant activity in broilers. *Turkish Journal of Veterinary and Animal Sciences*, vol. 39, p. 406-412. <https://doi.org/10.3906/vet-1403-64>
- Lu, Y., Yeap Foo, L. 1999. The polyphenol constituents of grape pomace. *Food Chemistry*, vol. 65, no. 1, p. 1-8. [https://doi.org/10.1016/S0308-8146\(98\)00245-3](https://doi.org/10.1016/S0308-8146(98)00245-3)
- Maier, T., Schieber, A., Kammerer, D. R., Carle, R. 2009. Residues of grape (*Vitis vinifera* L.) seed oil production as valuable source of phenolic antioxidants. *Food Chemistry*, vol. 112, no. 3, p. 551-559. <https://doi.org/10.1016/j.foodchem.2008.06.005>
- Marcinčák, S., Popelka, P., Šimková, J., Marcinčáková, D., Martonová, M. 2010. Oxidative stability of chilled chicken

meat after feeding of selected plants. *Potravinárstvo*, vol. 4, no. 3, p. 46-49. <https://doi.org/10.5219/38>

Mielink, M. B., Olsen, E., Vogt, G., Adeline, D., Skrede, G. 2006. Grape seed extract as antioxidant in cook, cold store turkey meat. *LWT – Food Science and Technology*, vol. 39, no. 3, p. 191-198. <https://doi.org/10.1016/j.lwt.2005.02.003>

Murcia, M. A., Martínez-Tomé, M. 2001. Antioxidant activity of resveratrol compared with common food additives. *Journal of Food Protection*, vol. 64, no. 3, p. 379-384. <https://doi.org/10.4315/0362-028X-64.3.379>
PMid:11252483

Nawaz, H., Shi, J., Mittal, G. S., Kakuda, Y. 2006. Extraction of polyphenols from grape seeds and concentration by ultrafiltration. *Separation and Purification Technology*, vol. 48, no. 2, p. 176-181. <https://doi.org/10.1016/j.seppur.2005.07.006>

Özvural, E. B., Vural, H. 2011. Grape seed flour is a viable ingredient to improve the nutritional profile and reduce lipid oxidation of frankfurters. *Meat Science*, vol. 88, no. 1, p. 179-183. <https://doi.org/10.1016/j.meatsci.2010.12.022>
PMid:21232878

Özvural, E. B., Vural, H. 2013. Which is the best grape seed additive for frankfurters: extract, oil or flour? *Journal of the Science of Food and Agriculture*, vol. 94, no. 4, p. 792-797. <https://doi.org/10.1002/jsfa.6442>
PMid:24122825

Ryu, K. S., Shim, K. S., Shin, D. 2014. Effect of Grape Pomace Powder Addition on TBARS and Color of Cooked Pork Sausages during Storage. *Korean Journal for Food Science of Animal Resources*, vol. 34, no. 2, p. 200-206. <https://doi.org/10.5851/kosfa.2014.34.2.200>
PMid:26760939

Sahin, K., Akdemir, F., Orhan, C., Tuzcu, M., Hayirli, A., Sahin, N. 2010. Effects of dietary resveratrol supplementation on egg production and antioxidant status. *Poultry Science*, vol. 89, no. 9, p. 1190-1198. <https://doi.org/10.3382/ps.2010-00635>
PMid:20460666

Sanchez-Moreno, C., Larrauri, J. A., Saura-Calixto, F. 1999. Free radical scavenging capacity and inhibition of lipid oxidation of wine, grape juices and related polyphenolic constituents. *Food Research International*, vol. 32, no. 6, p. 407-412. [https://doi.org/10.1016/S0963-9969\(99\)00097-6](https://doi.org/10.1016/S0963-9969(99)00097-6)

Shahidi, F., Wanasundara, P. K. 1992. Phenolic antioxidants. *Critical Reviews in Food Science and Nutrition*, vol. 32, no. 1, p. 67-103. <https://doi.org/10.1080/10408399209527581>
PMid:1290586

Shirahigue, L. D., Plata-Oviedo, M., De Alencar, S. M., D'Arce, M. A. B. R., De Souza Vieira, T. M. F., Oldoni, T. L. C., Contreras-Castillo, C. J. 2010. Wine industry residue as antioxidant in cooked chicken meat. *International Journal of Food Science and Technology*, vol. 45, no. 5, p. 863-870. <https://doi.org/10.1111/j.1365-2621.2010.02201.x>

Slezák, F. 2007. *Preserving of antioxidant components in wines from Little Carpathian region: research report*. Modra, Slovakia : Biocentrum Modra and VÚP Bratislava. 19 p.

Špakovská, E., Marcinčák, S., Bača, M., Turek, P. 2012. Polyphenolic content and antioxidative activity of wines from

Sobrance region. *Potravinárstvo*, vol. 6, no. 3, p. 32-35. <https://doi.org/10.5219/204>

Tekeli, A., Rustu Kutlu, H., Celik, L. 2014. Dietary Inclusion of Grape Seed Oil in Functional Broiler Meat Production. *Bulgarian Journal of Agricultural Science*, vol. 20, no. 4, p. 924-932.

Tournour, H. H., Segundo, M. A., Magalhães, L. M., Costa, A. S. G., Cunha, L. M. 2016. Effect of Touriga nacional Grape Extract on Characteristics of Mechanically Deboned Chicken Meat Kept under Frozen Storage. *Journal of Food Process Engineering*, vol. 40, no. 3.

Wrolstad, R., Skrede, G. 2002. Flavonoids from Berries and Grapes. In Mazza, G. et al. *Functional Foods Biochemical and Processing Aspects*. Boca Raton, FL : CRC press. ISBN: 978-1-4200-1287-3. <https://doi.org/10.1201/9781420012873.ch3>

Acknowledgments:

This work was supported by grants VEGA No. 1/0147/17 and 1/0139/17.

Contact address:

Ing. Marek Bobko, PhD., Slovak University of Agriculture in Nitra, Faculty of Biotechnology and Food Sciences, Department of Animal Products Evaluation and Processing, Tr. A. Hlinku 2, 949 76 Nitra, Slovakia, E-mail: marek.bobko@uniag.sk

doc. Ing. Peter Haščík, PhD., Slovak University of Agriculture in Nitra, Faculty of Biotechnology and Food Sciences, Department of Animal Products Evaluation and Processing, Tr. A. Hlinku 2, 949 76 Nitra, Slovakia, E-mail: peter.hascik@uniag.sk

Ing. Miroslav Kročko, PhD., Slovak University of Agriculture in Nitra, Faculty of Biotechnology and Food Sciences, Department of Animal Products Evaluation and Processing, Tr. A. Hlinku 2, 949 76 Nitra, Slovakia, E-mail: mirokrocko@yahoo.com

Ing. Lenka Trembecká, Slovak University of Agriculture in Nitra, Faculty of Biotechnology and Food Sciences, Department of Animal Products Evaluation and Processing, Tr. A. Hlinku 2, 949 76 Nitra, Slovakia, E-mail: xtrembecka@uniag.sk

Ing. Andrea Mendelová, PhD. Slovak University of Agriculture in Nitra, Faculty of Biotechnology and Food Sciences, Department of Storing and Processing of Plant Products, Tr. A. Hlinku 2, 949 76 Nitra, Slovakia, E-mail: andrea.mendelova@uniag.sk

Ing. Peter Czako, PhD. Chateau Malanta, Agátová 28, 95101, Nitrianske Hrnčiarovce E-mail: chateaumalanta@gmail.com

Ing. Jana Tkáčová, PhD., Slovak University of Agriculture in Nitra, Faculty of Biotechnology and Food Sciences, Department of Animal Products Evaluation and Processing, Tr. A. Hlinku 2, 949 76 Nitra, Slovakia, E-mail: jana.tkacova@uniag.sk

doc. RNDr. Ing. Tomáš Tóth, PhD., Slovak University of Agriculture in Nitra, Faculty of Biotechnology and Food Sciences, Department of Chemistry, Tr. A. Hlinku 2, 949 76 Nitra, Slovakia, E-mail:tomas.toth@uniag.sk



INFLUENCE OF THE ADDITION OF POST-EXTRACTION RAPESEED MEAL ON THE SENSORIC QUALITY OF POULTRY MEAT

Alžbeta Jarošová, Hana Šulcerová

ABSTRACT

Complete feed mixtures, very often enriched by the addition of various probiotic preparations, oils, extract, essential oils, mouldings, pollards etc., that are often added as a replacement for animal meals, antibiotic preparations, coccidiostats respectively, are used for feeding of chickens. In addition to the positive effects of these supplements, the final quality of meat may be adversely affected by the accumulation of certain components. The aim of the work was to monitor the influence of adding post-extraction rapeseed meal (PRM) to a broiler feed mixture on the sensory quality of breast and thigh muscle. The experience includes two hybrid combinations of broilers, ROSS 308 and COBB 500. Samples of breast and thigh muscle of broilers fed by a feed mixture with the addition of 10% post-extraction rapeseed meal were compared, using sensory analysis, with a control sample where the broilers were fed by a standard feed mixture without the addition of PRM. It has been found that the addition of post-extraction rapeseed meal to the broilers' feed mixture had a positive effect ($p < 0.05$) on the sensory quality of hybrid ROSS 308, both on the breast and thigh muscle. For COBB 500 hybrid, the quality of both breast and thigh muscle has not been shown to be significantly affected. The addition of 10% PRM affected positively especially the texture properties of ROSS 308, hybrid breast muscle, whereas they were deteriorated in COBB 500. In sensory evaluation, by adding 10% of PRM to the feed mixture, thigh muscle was affected less than breast muscle. Adding 10% PRM to the feed has almost no effect on descriptors of the intensity and pleasantness of smell and the intensity and pleasantness of taste, both in the negative and positive sense, both in breast and thigh muscle. The evaluation of the overall quality of both breast and thigh muscle has turned out more positive for ROSS 308 hybrid, although only slightly. The addition of rapeseed extracted meal to feed hybrids ROSS COBB 308 and 500 had no significant effect on the sensory quality of breast and thigh muscle.

Keywords: sensory quality; poultry meat; feed; fat

INTRODUCTION

In the last 20 years, we have experienced a significant increase of chicken meat consumption worldwide and in Europe, primarily due to dietary properties, favourable price and relatively quick kitchen processing. The World Health Organization (WHO) recommends reducing the intake of fat to maximum 30% of the total daily intake, saturated fatty acids 10%, 10 – 15% MUFA, 6 – 10% PUFA, maximum 300 g of cholesterol per day and less than 1% trans fatty acids (Jiménez-Colmenero, 2007). At the same time, the fattening period of broiler chickens has significantly decreased (Mates, 2013). Chicken meat is distinguished by a high nutrition value. Due to the cholesterol content, relatively high protein content and the content of polyunsaturated fatty acids (PUFA), it can be used as a valuable component of the human diet, with potential health benefits (Miličević et al., 2014).

The nutritional value of poultry, compared with other animal products, is characterised by a higher content and higher digestibility of proteins and lower content of energy. Compared with lard and beef tallow, poultry fat has a substantially lower content of adversely acting saturated fatty acids and contains two times higher amount of linoleic acid than beef tallow (Adeymo et al., 2010; Guèye, 2009; Vandendriessche, 2008; Duclos et al., 2007). Onyimonyi et al. (2009) suggest a tendency that the poultry holding plays an important role when bridging the protein gap in developing countries where the average daily protein consumption is significantly lower than the recommended standards.

It is generally known that the highest costs in chicken fattening consist in the costs of feed, representing up to 80% of total costs and therefore it is not always possible to produce feed mixtures on the basis of the requirements of particular chicken hybrid combinations (Olughemi et al.,

2010). Adeymo et al. (2010) state that delivering of high-quality feed which adequately meets broilers nutrition requirements is significant for their quick growth. A type of chicken hybrid combination is a basis for the creation and composition of feed mixtures (Cerrate and Waldroup, 2009).

When feeding broiler chickens, there is an effort to achieve quickly the slaughter weight with low consumption of feed per kilogram of gain, while preserving the best slaughter quality of broilers (Dozier et al., 2006). Most feed mixtures for fattening chicken are made in granular form, but also mixtures in bulk form are used (Choi et al., 1986; Cutlip et al., 2006; Cutlip et al., 2008). Ross 308 is one of the most widely reared broilers worldwide. Its biggest advantage is a quick growth with a minimum feed consumption. It is preferred in higher integrated wholes that provide above-average useful properties and are combined with a balanced muscularity of the body as well as high muscle yields. It represents good satisfaction of the customer's requirements, the customer requires a balanced animal performance and universal use in the final processing of meat (Xavergen, 2007). Cobb 500 is a robust broiler that achieves high daily gains when using basic types of feeds with lower nutrition content. High slaughter yield and great uniformity are appreciated the most in the manufacturing industry (Xavergen, 2007). It has the lowest feed conversion, the best growth rate and low nutrition requirements.

In the past, as today, possible alternatives of price – intensive components or supplements and enzymatic preparations for complete feed mixtures as essential oils, plant essences and extracts, bee products, probiotic preparations etc. were tested (Haščík et al., 2016; Mellen et al., 2014; Haščík et al., 2004, 2005; Skřivan and Tůmová, 1992; Angelovičová 1997). One of the possibilities is the use of post-extraction rapeseed meal (PRM).

The rapeseed is a very important source of proteins and its use for feed mixtures for ruminants and non-ruminants has been increased in the last decade. In addition to the seed and rape oil (Pelser et al., 2007), also PRM containing 32 – 38% of nitrogen substances is added to feed mixtures. Its quality depends on the variety of rape from which it stems.

Currently, double zero rapes having a low content of erucic acid which is less suitable for nutrition and glucosinolates (GSL) are grown. PRM 5 – 15% is added to feed mixtures for poultry. Besides the positive influence of PRM in animal fattening, also the sensory quality of meat can be affected (Haak et al., 2008; Wood a kol., 2008; Jaworskaa et al, 2016).

The entire quality of food means a set of all properties of the particular product that are important for meeting the needs and requirements of the consumers. These properties are divided into two basic groups – basic characteristics and useful properties which include also food sensory analysis (Ingr, 2010; Horčín, 2002). Sensory evaluation of food is one of the oldest methods of quality control which has been retained in the every day practices of the food-processing industry until today despite the high degree of development of objective methods, especially analytic ones (Buňka et al., 2008; Jarošová, 2001). The sensory quality of a food product can be affected virtually by any intervention in the production, manufacturing, storing the product etc. compared to the standard production. Adding various accessory substances to the feed not only of poultry but also other animals can affect both positively and negatively the sensory properties of the meat.

MATERIAL AND METHODOLOGY

The samples which were used for sensory evaluation were supplied by a company which has been long-term engaged in chicken fattening and the slaughter processing.

30 chicken broilers of ROSS 308 and 30 chicken broilers of COBB 500 who were fed by a feed mixture with the addition of 10% post-extraction rapeseed meal (PRM) were used for the experiment with fattening. Length of fattening period was 38 days. 15 pieces of each broiler were randomly selected and slaughtered and these slaughter bodies were used for sensory evaluation. Control groups (C) in both hybrid combinations [ROSS 308 (K), n = 15; COBB 500 (K), n = 15] were fed by the same feed mixture but without adding PRM. The chickens (experimental and control group) were slaughtered and portioned on the same day. Both groups were sampled – samples of breast muscle [ROSS 308, n = 15; COBB 500, n = 15; ROSS 308 (C), 308 n = 10; COBB 500 (C), n = 10] and thigh muscle (ROSS 308, n = 15; COBB 500, n = 15;



Figure 1 Samples of chicken ready for heat treatment.

ROSS 308 (C), n = 10; COBB 500 (C), n = 10]. All samples were individually packed to an aluminium foil, described and maintained at the temperature 5 ± 0.5 °C till the next day. Subsequently, the samples were thermally processed by stewing in their own juice at 250 °C for the duration of 1 hour (Figure 1). In total, n = 100 samples were thermally processed and presented for sensory testing.

Sensory analysis

Sensory evaluation was performed in sensory laboratory of the Department of Food Technology of Mendel University in Brno, equipped according to ISO 8589. Ten trained evaluators were presented with thermally processed samples of breast and thigh muscle of ROSS 308 and COBB 500 hybrids fed by a mixture without the addition (C) and with the addition of 10% PRM. The samples were presented always in the order control group (C), followed by the experimental group. At first, breast muscle was evaluated and subsequently thigh muscle. Sensory analysis was divided into the morning part (09:00 – 11:00 am) as ROSS 308 hybrid was evaluated and the afternoon part (02:00 – 04:00 pm) as COBB 500 hybrid was evaluated. The following descriptors were evaluated colour – pleasantness, colour – typicalness, colour – intensity, texture – by appearance and by palpation, smell – pleasantness, smell – intensity, chewiness, juiciness, taste – pleasantness, taste – intensity and the overall quality. The samples were presented anonymously. The results were recorded by the evaluators in forms with graphic unstructured scales (100 mm) with a verbal description of the end points where 0 was described as the worst value and 100 was described as the best value (Ambrosiadis et al., 2004).

Statistical data processing

The obtained results were further processed in MS Excel 2010 programme and in STATISTICA CZ (version 12) programme. One factor ANOVA, Duncan's test ($p < 0.05$) was used for statistical processing.

RESULTS AND DISCUSSION

Breast muscle

ROSS 308 control (C), ROSS 308 PRM

When comparing samples ROSS 308 hybrid control (C) and ROSS 308 with the addition of PRM in the feed we found that the addition of PRM did not affect significantly descriptors of smell and taste (Table 1). Mostly descriptors juiciness and chewiness were mostly affected by adding PRM, with statistic significance ($p < 0.05$). In these two descriptors, the sample with PRM was evaluated better. Furthermore, the addition has also manifested positively in the monitored descriptor texture – by appearance, by palpation, but not statistically significant.

COBB 500 control (C), COBB 500

PRM In the samples COBB 500 control (C) and COBB 500 with the addition of PRM to the chicken feed it was found that the addition had again the greatest influence on descriptors juiciness and chewiness and also on descriptors colour – typicalness, colour – intensity with statistical significance ($p < 0.05$) among the samples

(Table 2). In this case, PRM in the feed affected negatively juiciness, chewiness and also colour intensity, whereas it affected positively the typicalness of colour. Descriptors of smell and taste were not affected at all.

ROSS 308 PRM, COBB 500 PRM

When comparing both hybrids ROSS 308 with the addition of PRM and COBB 500 with the addition of PRM to the feed, there were recorded the biggest differences and statistical significance of difference ($p < 0.05$) was determined in descriptors colour – pleasantness, chewiness, juiciness, taste – pleasantness and overall quality (Table 3).

Thigh muscle

ROSS 308 control (C), ROSS 308 PRM

Statistically significant difference ($p < 0.05$) when evaluating thigh muscle of ROSS hybrid and ROSS with the addition of 10% PRM was found in one descriptor – juiciness where the control sample (Table 4) was evaluated better. On the contrary, in chewiness the sample with the addition of PRM was evaluated better. Descriptors of colour, smell and taste were not affected almost at all.

COBB control (C), COBB PRM

By sensory evaluation of thigh muscle in samples COBB 500 control and COBB 500 with the addition of PRM, statistically significant difference ($p < 0.05$) (Table 5) was not found in any of the monitored descriptors. In the sample with the addition of PRM to chicken feed, chewiness and texture by appearance and by palpation were affected only slightly positively.

ROSS 308 PRM, COBB 500 PRM

By sensory analysis of both hybrids with the addition of PRM, statistically significant difference ($p < 0.05$) was found in two descriptors – chewiness and taste – intensity (Table 6). COBB was better evaluated in both descriptors. In thigh muscle, COBB was better evaluated in eight of the eleven monitored descriptors, but ROSS was better evaluated in overall quality.

The study carried out by Miliećević et al. (2014) has shown that the content of cholesterol and unsaturated fatty acids in the chicken meat can be affected also by adjustment of feed mixture composition. Feed mixture composition had no impact on the sensory properties of meat but it has turned out that lower values of cholesterol and higher values of unsaturated fatty acids were measured in breast and thigh muscle.

There was conducted a study in Italy whose aim was to evaluate the effect of various genotypes and feeding for meat in terms of composition. Poultry was divided into 2 groups with a different food composition that differed in the protein source – soya bean and broad bean. In feeding rations with soya bean, lower contents of lipids, a higher proportion of PUFA and a lower proportion of monounsaturated fatty acids (MUFA) were found on breast and thigh muscle. The feed with broad bean has only slightly increased the levels of proteins in breast muscle and decreased the levels of lipids and ash in thigh muscle (Meluzzi et al., 2009).

Table 1 Average values of individual descriptors monitored in sensory analysis of breast muscle of ROSS 308 control (C) and ROSS 308 with the addition of 10% post-extraction rapeseed meal (PRM).

Descriptors	ROSS 308 C	ROSS 308 PRM
Color – pleasantness	75.12 ±13.89	72.18 ±11.16
Color – typicalness	71.04 ±15.68	72.60 ±13.09
Color – intensity	49.10 ±10.80	51.50 ±10.69
Texture*	50.56 ±18.14	54.90 ±20.92
Smell – pleasantness	70.74 ±14.63	72.72 ±11.49
Smell – intensity	66.90 ±15.78	65.70 ±9.86
Chewiness	49.38 ±23.97 ^a	60.20 ±20.20 ^b
Juiciness	44.80 ±22.50 ^a	56.77 ±20.58 ^b
Taste – pleasantness	71.90 ±15.17	68.01 ±12.66
Taste – intensity	59.64 ±18.03	63.60 ±10.27
Overall quality	65.86 ±13.88	62.06 ±17.34

Note: *by appearance, by palpation

^{a, b} statistically significant difference ($p < 0.05$) among groups.

Table 2 Average values of individual descriptors monitored in sensory analysis of breast muscle of COBB 500 hybrid control (C) and COBB 500 with the addition of 10% PRM.

Descriptors	COBB 500 C	COBB 500 PRM
Color – pleasantness	70.86 ±15.29	76.18 ±13.23
Color – typicalness	70.46 ±14.24 ^a	76.39 ±14.13 ^b
Color – intensity	56.66 ±13.15 ^b	50.52 ±9.86 ^a
Texture*	57.76 ±20.58	57.31 ±17.55
Smell – pleasantness	70.80 ±10.44	72.94 ±14.27
Smell – intensity	62.22 ±14.13	62.58 ±17.27
Chewiness	58.58 ±17.49 ^b	48.90 ±19.21 ^a
Juiciness	50.76 ±20.07 ^b	43.17 ±19.28 ^a
Taste – pleasantness	66.06 ±16.05	62.02 ±14.44
Taste – intensity	58.82 ±13.15	61.14 ±14.15
Overall quality	58.84 ±16.99	55.03 ±15.72

Note: *by appearance, by palpation

^{a, b} statistically significant difference ($p < 0.05$) among groups.

Table 3 Average values of individual descriptors monitored in sensory analysis of breast muscle of ROSS 308 hybrid with the addition of 10% PMR and COBB 500 hybrid with the addition of 10% PRM – post-extraction rapeseed meal (PRM).

Descriptors	ROSS 308 PRM	COBB 500 PRM
Color - pleasantness	72.18 ±11.16 ^a	76.18 ±13.23 ^b
Color - typicalness	72.60 ±13.09	76.39 ±14.13
Color - intensity	51.50 ±10.69	50.52 ±9.86
Texture*	54.90 ±20.92	57.31 ±17.55
Smell - pleasantness	72.72 ±11.49	72.94 ±14.27
Smell - intensity	65.7 ±9.86	62.58 ±17.27
Chewiness	60.20 ±20.20 ^b	48.90 ±19.21 ^a
Juiciness	56.77 ±20.58 ^b	43.17 ±19.28 ^a
Taste - pleasantness	68.01 ±12.66 ^b	62.02 ±14.44 ^a
Taste - intensity	63.60 ±10.27	61.14 ±14.15
Overall quality	62.06 ±17.34 ^b	55.03 ±15.72

Note: *by appearance, by palpation

^{a, b} statistically significant difference ($p < 0.05$) among groups.

There are differences in the composition of various kinds of meat depending on their anatomical structure of animal (Kameník, 2013). As stated by Pipek and Pour (1998), meat with a higher content of fat, in which post-mortem ripening processes took place, has a fuller taste and smell. Our results showed that when controlling ROSS 308 and COBB 500 hybrids, higher values in the pleasantness of smell were found in thigh muscle but the intensity of smell was higher in breast muscle. In the descriptor pleasantness and the intensity of taste in COBB 500 hybrid, the values

were higher in thigh muscle whereas in ROSS 308 hybrid, the pleasantness of taste was more intensive in breast muscle and the intensity of taste in thigh muscle. In samples with 10% PRM in COB 500, the higher values were always in thigh muscle whereas in ROSS 308, except for the pleasantness of taste, always in breast muscle. In the same way, the sensory quality can be significantly affected by the temperature of the presented sample as well as by the succession of evaluation of individual descriptors, i.e. the chosen methodology (Kinclová et al.,

Table 4 Average values of individual descriptors monitored in sensory analysis of thigh muscle of ROSS 308 hybrid control (C) and ROSS 308 with the addition of 10% post-extraction rapeseed meal (PRM).

Descriptors	ROSS 308 C	ROSS 308 PRM
Color – pleasantness	74.52 ±12.65	72.93 ±18.11
Color – typicalness	74.70 ±14.30	73.64 ±18.59
Color – intensity	51.26 ±11.30	55.53 ±14.78
Texture*	57.68 ±18.32	58.64 ±20.03
Smell – pleasantness	72.40 ±12.11	71.69 ±16.28
Smell – intensity	63.94 ±14.75	60.14 ±18.22
Chewiness	51.50 ±19.08	55.79 ±16.40
Juiciness	62.08 ±14.68 ^b	55.60 ±16.40 ^a
Taste – pleasantness	71.64 ±12.74	66.37 ±17.26
Taste – intensity	62.50 ±15.27	61.59 ±13.86
Overall quality	66.54 ±14.32	63.14 ±19.62

Note: *by appearance, by palpation

^{a, b} statistically significant difference ($p < 0.05$) among groups.

Table 5 Average values of individual descriptors monitored in sensory analysis of thigh muscle of COBB 500 hybrid control (C) and COBB with the addition of 10% post-extraction rapeseed meal (PRM).

Descriptors	COBB 500 C	COBB 500 PRM
Color – pleasantness	74.70 ±15.42	75.21 ±16.17
Color – typicalness	74.30 ±15.29	75.72 ±13.85
Color – intensity	58.24 ±13.38	54.52 ±16.17
Texture	61.02 ±20.78	63.70 ±21.75
Smell – pleasantness	71.88 ±15.18	73.25 ±15.04
Smell – intensity	61.28 ±13.94	62.73 ±15.54
Chewiness	59.62 ±16.02	64.08 ±19.57
Juiciness	57.52 ±19.32	57.28 ±22.95
Taste – pleasantness	68.64 ±12.99	64.58 ±16.44
Taste – intensity	65.06 ±11.82	65.78 ±13.06
Overall quality	65.54 ±16.96	62.95 ±18.90

Note: *by appearance, by palpation

^{a, b} statistically significant difference ($p < 0.05$) among groups.

Table 6 Average values of individual descriptors monitored in sensory analysis of thigh muscle of ROSS 308 hybrid with the addition of 10% post-extraction rapeseed meal (PRM) and COBB 500 hybrid with the addition of 10% post-extraction rapeseed meal (PRM).

Descriptors	ROSS 308 PRM	COBB 500 PRM
Color – pleasantness	72.93 ±18.11	75.21 ±16.17
Color – typicalness	73.64 ±18.59	75.72 ±13.85
Color – intensity	55.53 ±14.78	54.52 ±16.17
Texture*	58.64 ±20.03	63.70 ±21.75
Smell – pleasantness	71.69 ±16.28	73.25 ±15.04
Smell – intensity	60.14 ±18.22	62.73 ±15.54
Chewiness	55.79 ±16.40 ^a	64.08 ±19.57 ^b
Juiciness	55.60 ±16.40 ^a	57.28 ±22.95
Taste – pleasantness	66.37 ±17.26	64.58 ±16.44
Taste – intensity	61.59 ±13.86 ^a	65.78 ±13.06 ^b
Overall quality	63.14 ±19.62	62.95 ±18.90

Note: *by appearance, by palpation

^{a, b} statistically significant difference ($p < 0.05$) among groups.

2004). Kameník (2013) and Pipek and Kadlec (2009) state that the texture properties can be affected not only by the degree of ripening, the content of connective tissue but also by the spectrum of fatty acids.

As stated by Buňka et al. (2008) and Ingr et al. (2001), it is important to keep not only hygiene sampling but also the conditions of storing the samples before processing for consumption and the thermal processing since all these interventions may affect the nature of the product and its final sensory quality.

An important factor that affects the sensory quality of poultry meat is the length of fattening. It was found that broilers defeated in older age had a stronger flavor than younger chicks (Nollet and Boylston, 2007).

CONCLUSION

From the results obtained, we can state that the sensory quality in thigh muscle of COBB 500 hybrid was not affected by the addition of PRM to the feed. The addition of 10% PRM affected positively especially the texture

properties of breast muscle in ROSS 308 hybrid, whereas it deteriorated them in COBB 500 hybrid. By adding 10% PRM to the feed, in sensory evaluation, thigh muscle is affected much less than breast muscle. By adding 10% PRM to the feed, there is no or only a small effect on descriptors of smell and taste, both in negative and positive sense, both in breast and thigh muscle. The overall quality evaluation in both breast and thigh muscle turned out more positively for ROSS 308 hybrid, although only slightly. It has been found that the addition of post-extraction rapeseed meal to the broiler feed mixture had a positive effect ($p < 0.05$) on the sensory quality of ROSS 308 hybrid, both on breast and thigh muscle. In COBB 500 hybrid, a significant affection of the quality of breast or thigh muscle has not been shown. We can say that the addition of rapeseed extracted meal to feed hybrids ROSS COBB 308 and 500 had no significant effect on the sensory quality of breast and thigh muscle.

REFERENCES

- Adeyemo, G. O., Ologhobo, A. D., Adebisi, O. A. 2010. The Effect of Graded Levels of Dietary Methionine on the Haematology and Serum Biochemistry of Broilers. *International Journal of Poultry Science*, vol. 9, no. 2, p. 158-161. <https://doi.org/10.3923/ijps.2010.158.161>
- Ambrosiadis, J., Soultos N., Abraham, A., Bloukas, J.G. 2004. Physicochemical, microbiological and sensory attributes for the characterization of Greek traditional sausages. *Meat Science*, vol. 66, no. 2, p. 279-287. [https://doi.org/10.1016/S0309-1740\(03\)00100-1](https://doi.org/10.1016/S0309-1740(03)00100-1)
- Angelovičová, M. 1997. The effect of low protein fat blends on live weight and selected slaughter indicators of quality feeding poultry (Vplyv nízko bielkovinových tukových zmesí na živú hmotnosť a vybrané jatočné ukazovatele jatočnej kvality výkrmových kurčiat). *Pol'nohospodárstvo*, vol. 43, no. 10, p. 764-771.
- Buňka, F., Hrabě, J., Vospěl, B. 2008. *Sensory analysis of food I. (Senzorická analýza potravín I.)*. 1st ed. Zlín : Tomas Nata University in Zlín, 145 p., ISBN 978-80-7318-628-9.
- Cerrate, S., Waldroup, P. 2009. Maximum Profit Feed Formulation of Broilers: 1. Development of a Feeding Program Model to Predict Profitability Using non Linear Programming. *International Journal of Poultry Science*, vol. 8, no. 3, p. 205-215. <https://doi.org/10.3923/ijps.2009.205.215>
- Cutlip, S. E., Hott, J. M., Buchanan, N. P., Moritz J. S. 2008. Effect of steam conditioning practices on pellet quality and growing broiler nutritional value. *Journal of Applied Poultry Research*, vol. 17, no. 2, p. 249-261. <https://doi.org/10.3382/japr.2007-00081>
- Dozier, W. A., Price, I. C. J., Kidd, M. T., Corzo, A., Anderson, J., Branton, S. L. 2006. Growth performance, meat yield and economic responses of broilers fed diets varying in metabolizable energy from 30-59 days of age. *Journal of Applied Poultry Research*, vol. 15, no. 3, p. 367-382. <https://doi.org/10.1093/japr/15.3.367>
- Duclos, M. J., Berri, C., Le Bihan-Duval, E. 2007. Muscle growth and meat quality. *Journal of Applied Poultry Research*, vol. 16, no. 1, p. 107-112. <https://doi.org/10.1093/japr/16.1.107>
- Guèye, E. F. 2009. The role of networks in information dissemination to family poultry farmers. *World's Poultry Science Journal*, vol. 65, no. 1, p. 115-123. <https://doi.org/10.1017/S0043933909000099>
- Haak, L., De Smet, S., Fremaut, D., Van Walleghem, K., Raes, K. 2008. Fatty acid profile and oxidative stability of pork as influenced by duration and time of dietary linseed or fish oil supplementation. *Journal of Animal Science*, vol. 6, no. 86, p. 1418-1425. <https://doi.org/10.2527/jas.2007-0032> PMID:18310496
- Haščík, P., Čuboň, J., Vagač, V. 2004. Hodnotenie senzorickej kvality hydínového mäsa vplyvom probiotického preparátu IMB 52. *Maso*, vol. 15, no. 1, p. 62-65.
- Haščík, P., Trembecká, L., Bobko, M., Kačániová, M., Čuboň, J., Kunová, S., Bučko, O. 2016. Effect of diet supplemented with propolis extract and probiotic additives on performance, carcass characteristics and meat composition of broiler chickens. *Potravinárstvo*, vol. 10, no. 1, p. 223-231. <https://doi.org/10.5219/581>
- Haščík, P., Weis, J., Čuboň, J., Kulíšek, V., Makovický, P., Kačániová, M. 2005. Vplyv probiotického preparátu v KKZ brojlerových kurčiat ROSS 308 na chemické zloženie mäsa. *Acta fytotechnica et zootechnica*, vol. 8, no. 1, p. 20-24.
- Horčín, V. 2002. *Sensory evaluation of foods (Senzorické hodnotenie potravín)*. Nitra : Slovak University of Agriculture. 139 p. ISBN 80-8069-112-6.
- Choi, J. H., So, B. S., Ryu, K. S., Kang, S. L. 1986. Effects of pelleted or crumbled diets on the performance and the development of the digestive organs of broilers. *Poultry Science*, vol. 65, no. 3, p. 594-597. <https://doi.org/10.3382/ps.0650594> PMID:3703802
- Ingr, I. 2010. *Quality and processing of fish (Jakost a zpracování ryb)*. Brno : Mendel University in Brno. 102 p., ISBN 978-80-7375-382-5.
- Jarošová, A. 2001. *Sensory evaluation of food (Senzorické hodnotení potravín)*. 1st ed. Brno : MZLU, 84 p., ISBN 80-7157-539-9.
- Jaworska, D., Czauderna, M., Przybylski, W., Rozbicka-Wieczorek, A. J. 2016. Sensory quality and chemical composition of meat from lambs fed diets enriched with fish and rapeseed oils, carnosic acid and seleno-compounds. *Meat Science*, vol. 119, p. 185-192. <https://doi.org/10.1016/j.meatsci.2016.05.003> PMID:27214277
- Jiménez-Colmenero, F. 2007. Healthier lipid formulation approaches in meat-based functional foods. Technological options for replacement of meat fats by non-meat fats. *Trends in Food Science & Technology*, vol. 18, no. 11, p. 567-578. <https://doi.org/10.1016/j.tifs.2007.05.006>
- Kameník, J. 2013. Pork, beef, poultry, or horse? Vepřové, hovězí, drůbeží, nebo koňské? *Potravinářská revue*, vol. 5, p. 13-17.
- Kinclová, V., Jarošová, A., Tremlová B. 2004. *Sensory analysis of food (Senzorická analýza potravín)*. Veterinářství., vol. 54, p. 362-364. ISSN 0506-8231.
- Mates, F. 2013. Production of poultry meat in the Czech Republic, the EU and the world and its perspectives (Výroba drůbežního masa v ČR, v EU a ve světě a její perspektivy). *Potravinářská revue*, vol. 7, p.31-33.
- Mellen, M., Pavelková, A., Haščík, P., Bobko, M., Čuboň, J. 2014. Sensory evaluation of cobb 500 chicken meat after application of different additives in their nutrition. *Potravinárstvo*, vol. 8, no. 1, p. 184-189. <https://doi.org/10.5219/373>
- Meluzzi, A., Sirri, F., Castellini, C., Roncarati, A., Maletti, P., Franchini, A. 2009. Influence of genotype and feeding on chemical composition of organic chicken meat. *Animal science*, vol. 8, no. 2, p. 766-768.
- Miličević, D., Vranić, D., Mašić, Z., Parunović, N., Trbović, D., Nedeljković-Trailović, J., Petrović, Z. 2014. The role of total fats, saturated/unsaturated fatty acids and

cholesterol content in chicken meat as cardiovascular risk factors. *Lipids in Health and Disease*, vol. 13, p. 42. <https://doi.org/10.1186/1476-511X-13-42>
PMid:24588940

Nollet, L. M., Boylston, T. 2007. Handbook of meat, poultry and seafood quality [online] s.a. [cit. 2017-01-21] Available at: <http://197.14.51.10:81/pmb/AGROALIMENTAIRE/Handbook%20of%20Meat%20Poultry%20and%20Seafood%20Quality.pdf>.

Olugbemi, T. S., Mutayoba, S. K., Lekule, F. P. 2010. Effect of Moringa (*Moringa oleifera*) Inclusion in Cassava Based Diets Fed to Broiler Chickens. *International Journal of Poultry Science*, vol. 9, no. 4, p. 363-367. <https://doi.org/10.3923/ijps.2010.363.367>

Onyimonyi, A. E., Olabode, A., Okeke, G. C. 2009. Performance and Economic Characteristics of Broilers Fed Varying Dietary Levels of Neem Leaf Meal (*Azadirachta indica*). *International Journal of Poultry Science*, vol. 8, no. 3, p. 256-259. <https://doi.org/10.3923/ijps.2009.256.259>

Pelser, W. M., Linssen, J. P. H., Legger, A., Houben, J. H. 2007. Lipid oxidation in n-3 fatty acid enriched Dutch style fermented sausages. *Meat Science*, vol. 75, no. 1, p. 1-11. <https://doi.org/10.1016/j.meatsci.2006.06.007>
PMid:22063405

Kadlec, P., Melzoch, K., Voldřich, M. 2009. What you should know about food production? (Co byste měli vědět o výrobě potravin?). 1st ed. Ostrava : Key Publishong. 536 p. ISBN 978-80-7418-051-4.

Pipek, P., Pour, M. 1998. Evaluation of the quality of animal products (Hodnocení jakosti živočišných produktů), Praha, Czech Republic : VŠCHT, 139 p. ISBN 80-213-0442.

Skřivan, M., Tůmová, E. 1992. Differences in technological value of broiler chickens of hybrid combinations Ross - 208, Hybro, Ross PM - 3 (Rozdiely v technologickej hodnote brojlerových kurčiat hybridných kombinácií Ross - 208, Hybro, Ross PM - 3). *Náš chov*, vol. 52, p. 173-174.

Vandendriessche, F. 2008. Meat products in the past, today and in the future. *Meat Science*, vol. 78, no. 1-2, p. 104-113. <https://doi.org/10.1016/j.meatsci.2007.10.003>
PMid:22062100

Wood, J. D., Enser, M., Fisher, A. V., Nute, G. R., Sheard, P. R., Richardson I., Whittington F. M. 2008. Fat deposition, fatty acid composition and meat quality: A review. *Meat Science*, vol. 78, no. 4, p. 343-358. <https://doi.org/10.1016/j.meatsci.2007.07.019>
PMid:22062452

Xavergen, 2007. Breeding of meat hens (Chov masných slepic) [online] s.a. [cit. 2016-02-25] Available at: <http://www.xavergen.cz/slepice.php>.

Acknowledgments:

This work was carried out in the framework of research Number 0533-2014.

The results and outcomes were prepared using instrumentation funded from the Research and Development for Innovations Operational Programme, project CZ.1.05/4.1.00/04.0135 Teaching and Research Facilities for Biotechnological Disciplines and Extension of Infrastructure.

Contact address:

Ing. Hana Šulcerová, Ph.D., Mendel University in Brno, Faculty of AgriSciences, Department of Food Technology, Zemědělská 1, 613 00 Brno, Czech Republic, E-mail: hana.sulcerova@mendelu.cz

prof. Ing. Alžbeta Jarošová, Ph.D., Mendel University in Brno, Faculty of AgriSciences, Department of Food Technology, Zemědělská 1, 613 00 Brno, Czech Republic, E-mail: ualja@mendelu.cz



GROWTH OF MICROORGANISMS IN THE PRE-FERMENTATION TANKS IN THE PRODUCTION OF ETHANOL

Viera Michalová, Dana Tančinová

ABSTRACT

Our research was carried out to determine the plate count with a special observation *Saccharomyces cerevisiae* in the pre-fermenters cereal grains using the classical microscopic method. The cell counts were performed in the Bürker chamber. We followed changes in the plate count, number of *Saccharomyces cerevisiae* and changes during the yeast propagation in the mash. The mash would present only cultivated yeast *Saccharomyces cerevisiae* but may occur in a small number of other microorganism's types. Samples were taken during the propagation process in distillery factories. During this period, 30 samples of corn mash were examined. Samples were collected from two tanks during the fifteen generations. The total number of *Saccharomyces cerevisiae* was reduced and we got a number of unwanted microbiota. The statistical evaluation demonstrated that the growth of unwanted microbiota is directly related to the increase in the propagation of generation in corn mash. The maximum number of yeast cells was found in the twelfth generation 3.052×10^8 mL in the propagation tank. The total number of microorganisms in this generation was 3.149×10^8 mL and yeasts represent 96.92% of the total microbiota. In the sample B, 95.62% were *Saccharomyces cerevisiae* during the fifteenth generation. Our results showed that the optimal exchange of the yeast is in 15th generation. Subsequently, repeat the whole process but now with new yeast. These results confirmed our understanding of the relationship between *Saccharomyces cerevisiae* and contamination during the ethanol fermentation.

Keywords: microbiota; *Saccharomyces cerevisiae*; yeasts; generation

INTRODUCTION

Many microorganisms produce ethanol and the efficiency amongst them varies greatly and eliminates the practical industrial usage of many (Akinosho et al., 2015). Many microorganisms are able to produce ethanol, but the force between them is very different, and thus eliminating the practical industrial use. For the quality of the final product is therefore crucial to what extent, when and under what physical conditions this process participated (Furdíková and Malík, 2016). Yeasts with guaranteed optimal control of fermentation processes have maximum yield. Final product is very clean with standard quality and from a natural source (Pelikán and Sáková, 2001).

Saccharomyces cerevisiae is a yeast that has an extensive history in industrial fermentation and exhibits exceptional ethanol tolerance (Ginley and Cahen, 2011). Classification of *Saccharomyces cerevisiae*: Fungi, Ascomycota, Saccharomycotina, Saccharomycetes, Saccharomycetidae, Saccharomycetales, Saccharomycetaceae, Saccharomyces (Mycobank Database, 2016).

Yeasts form cells of two types – large ones being of 5 to 12 microns and smaller ones of 3 to 10 microns. Cell size increases with age (Čerňanský and Khun, 2011).

Although wild-type *Saccharomyces cerevisiae*, commonly known as baker's yeast, is unable to ferment xylose into ethanol (Demake et al, 2013). But it is able to metabolize certain types of carbohydrates as glucose, fructose and sucrose (Manikandan and Viruthagiri, 2010). It is most commonly used micro-organism in a wide range of processes to higher the recoveries of alcohol and productivity (Demake et al, 2013).

The potential development of the life cycles is largely influenced by the availability of nutrients (Casalone et al., 2005). Yeast can use for building cells only substances which penetrate cell membranes. If the mash does not contain enough nutrients, there is no sufficient multiplication of yeast (Rob and Hrabě, 2009). An increased availability of phosphorus accumulated in phytic acid residues can constitute an additional source of this element which is necessary for the yeast growth (Mikulski et al., 2014). Several researchers found that yeast extract, ammonium and calcium have a protective effect on growth or viability, and fermentation (Khongsay et al., 2010). Calcium ions together with magnesium ions strengthen the yeast cell membrane thereby improving the resistance to

increasing concentrations of ethanol and high osmotic pressure (Mikulski, 2014).

Saccharomyces cerevisiae is yeast that has an extensive history in industrial fermentation and exhibits exceptional resistance to ethanol (Ginley and Cahen, 2011) and high concentrations of sugar. This yeast is not expensive, produces low levels of by-products, is osmotolerant and presents high viability for recycling (Muruga et al, 2016). However, they have a high ability to yeast survive. Cell responds and adapts to ethanol, thermal and osmotic stress, by series of defence mechanisms, thereby increasing their flexibility and resilience. *Saccharomyces cerevisiae* has the ability to change their membrane structure that is more resistant to ethanol (Dong et al., 2015 and Wang et al., 2015).

The main factors influencing the activity of the yeast during fermentation process are temperature, concentration of the substrate, pH and the presence of stimulating and inhibitory substances (Pelikán and Sáková, 2001). Reduced availability of minerals in bound phytate can inhibit the metabolic activity of yeast (Kumar, 2012). On the other hand a high level of copper in the mash can inhibit the activity of the yeast. This slows the fermentation and reduces the alcohol production (Sun, Liu, 2015). Variations in temperature also have a significant impact on the viability of yeast. Thermal shock is much more severe than mild temperature fluctuations (Amillastre et al., 2012). Lactic acid bacteria can inhibit the growth of yeast cells, because it competes with yeast nutrient and living space. This is influenced by the kinetics of glucose consumption, consequently reducing the final fermentation and the ethanol yield (Dong, Lin, Li, 2015).

In the microbiological practice is often necessary to evaluate the growth and reproduction of microorganisms, which is very important especially in the fermentation, using fermentation processes for the balance. In the basic research cell count is used to assess the kinetics of yeasts growth, and to set the specific growth rate and the reproduction in the different stages of their development. The control laboratories use the cell count in the control of microbial contamination of different materials (Veselá, 2004).

Our research was focused on the determination of the viability of yeast and changing the microbiota during recirculation of cells.

MATERIAL AND METHODOLOGY

During our research, we investigated the plate count in two propagation reactors using the direct method. The aim of the study was the process of yeasts propagation and their viability, and observes how microorganisms are developed during the propagation in real conditions of production. The principle of direct method for the determination of cells, consists in direct cell counting by the microscope slide, therefore also known as the microscopic method. The plate count is determined in a unit volume. Promotional tanks contain water, grain stillage and grinding grain. Liquefaction of starch mash was performed in a continual reactor with a propeller stirrer. The liquefactions were done at constant temperature of 90 °C during 2 hour. This mixture is called mash and was liquified using α -amylase and β -amylase.

Then, the saccharification step was carried out by addition of glucoamylase which converted dextrins to glucose syrup obtained in the previous liquefaction step. In our conditions, there is no need for any pH adjustment, because it is provided by an appropriate ratio water and stillage. The pH value varied in the range of 4.7 – 5.0 and this is the optimal pH for used enzymes. Saccharification was carried out at pH 5.0 and temperature 61 °C for 1 hour. This mash is already sweet mash, because it contains only simple sugars with small amounts of unexpanded starch. Sweet mash had 18.8 saccharimeter degrees, and at this stage material was inoculated with yeast. We used dry alcohol yeast genus *Saccharomyces cerevisiae* with a trade name Safdistil C-70 from the company Fermentis. For the 25 m³ volume of promotional tanks were used 9.5 kg of dry alcohol yeast. In order to rehydrate the dry yeasts optimally, 1 kg of yeasts in about 10 liters of mash (10 % dry matter) at about 30 – 33 °C were slowly stirred. After repeated stirring for 15 – 20 minutes significant foam was noticeable. It was a sign of the activity of the yeast. To ensure that the high viable cell count of Safdistil C-70 brings dry yeasts into the fermentation, the warm yeast suspension must not be stirred into a cold fermentation vessel. The temperature drop could cause the yeasts death. When the yeast suspension worked then was added to the propagation reactors while stirring. The pH was adjusted by adding sulphuric acid to 3.30. This partially prevents the proliferation of undesirable lactic microbiota.

Both propagation tanks were tested to the same specific conditions at the temperature 34 °C and pH 3.3. The volume of both tanks was 25 m³ mash with saccharification of 18.8 degrees.

The process of preparing generations

Sweet mash, which passes from saccharification tank was pumped into a propagation tank about volume 25 m³ – tank A. The function of propagation tank was to multiply yeasts and bring them into an active proces, in which the yeasts are able to convert simple sugars to alcohol. 9.5 kg dried distilling yeasts were disected in the mash and added to the pre-fermentation tank A. During filling the tank was all the time stirred to ensure a homogeneous mixture. Thus we prepared the first generation.

After 3 hours we took 2 samples from tank A and calculated the average shown in the chart below. The promotion process was checked by counting yeasts and their activity.

After 5 hours of propagation, 80% of the active yeasts were pumped from propagation tank to the fermentation one. At this point, the first generation of promoting is completed. The propagation tank was refilled for the same volume with fresh mash, by which we prepared a second generation of yeast. We again took two samples after 3 hours and the average we stated in the chart. After 5 hours of propagation, 80% was repumped into the fermentation tank. The propagation tank was refilled for the same volume of the fresh sweet mash. We repeated this process until the fifteenth generation. The same process was chosen for the preparation of promotional tank B.

30 samples with a 50 mL volume of mash were taken after three hours of propagation from propagation tank A and 30 samples from tank B, too. From each fifteenth

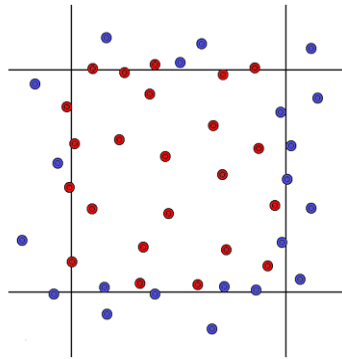

Picture 1 Illustration of method for counting in the chamber.

generation, two samples were examined and the average of the measurement was reported in the charts. The same concept was used in the tank B, also. These samples were 70 times diluted (mixture of 0.5 mL sample with 34.5 mL distilled water). All experiments were performed in duplicate. The total numbers of microorganisms were counted in a Bürker chamber with a light biological microscope Bresser 40 – 1000x Researcher Trino, WF 10X, trinocular head, transmitted light.

Normal microscopic image should contain the yeast in the form of globose with part of them being in a budding cells stage. The image should contain a minimum of sticks or small balls of bacterial origin. We counted the cells touching the right and top sides of the circuit area picture 1.

Cells touching on the left and bottom sides were not counted (we counted red cell, not the blue cells).

In the Bürker counting chamber we had the number of cells in 1 mL^{-1} determined using the relationship (1):

$$(1) \quad x = p \cdot r \cdot 2.5 \cdot 10^5$$

where x is the plate count, p is the average number of cells in a small square, and r is the dilution. From the total number of microorganisms, we deducted the amount of unwanted microbiota and obtained the number of yeast, which we expressed in percentages.

All the data in this study were analyzed using Microsoft Excel 2010.

RESULTS AND DISCUSSION

Fermentation process for the production of ethanol is based on the action of microbial cells (usually of some yeast cells) in a process called ethanol – alcohol fermentation. The pre-treatment of the raw material plays an important role for its conversion to ethanol (Paschos, Xiros, Christakopoulos, 2015). As a general rule, ethanol fermentation starts with the yeast controlled hydrolysis, based on the fermentation of sugars (Kasavi et al., 2012). The rate of fermentation (productivity) can significantly increase the concentration of cells, what is practically used in the recirculation of cells. Advantageously, the generated strains have increased tolerance to stress conditions (Muruga et al., 2015).

The results of the experiment confirmed that the highest number of yeast was observed in the 12th and 13th generation. In the propagation tank A, the highest amount of yeast was in the 12th generation with a number $3.052 \times 10^8 \text{ mL}$ (Table 1). From this generation on, the results showed only decrease in the count of yeast *Saccharomyces cerevisiae*.

The total number of microorganisms and *Saccharomyces cerevisiae* was in the first generation the same $0.555 \cdot 10^8 \text{ mL}$. It means that the propagation mass didn't contain any unwanted microorganisms Table 1. There was gradual increase of unwanted microorganisms in the subsequent generations.

In the 15th generation, the total number of microorganisms was $3.2 \times 10^8 \text{ mL}$, but of these, only $3.043 \times 10^8 \text{ mL}$ were already yeasts *Saccharomyces cerevisiae*. Microscopic

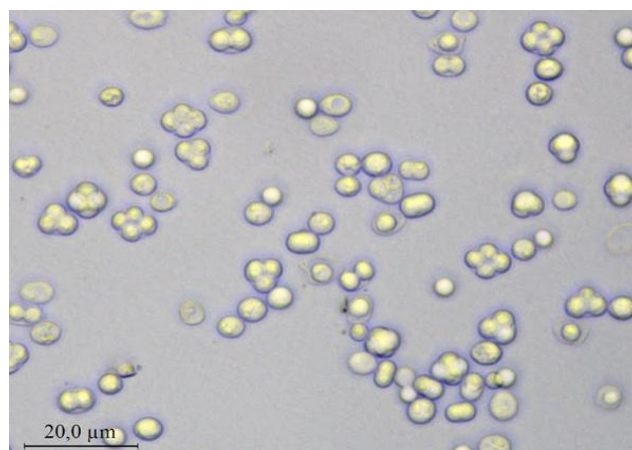

Picture 2 Microbiota – *Saccharomyces cerevisiae* the first generation in propagation tank.

Table 2 The observed indicators for propagation tank A, total number of microorganisms is the average of two measurements.

Generation of yeasts	Total number of microorganisms x 10 ⁸ mL	<i>Saccharomyces cerevisiae</i>	
		x 10 ⁸ mL	percentage of total number of microorganisms
1.	0.623	0.622	99.84
2.	1.077	1.075	99.81
3.	1.590	1.586	99.75
4.	1.692	1.686	99.65
5.	1.815	1.808	99.61
6.	2.062	2.048	98.32
7.	2.220	2.200	99.10
8.	2.408	2.382	98.92
9.	3.062	3.027	98.86
10.	3.115	3.058	98.17
11.	3.214	3.138	97.64
12.	3.305	3.215	97.28
13.	3.347	3.250	97.10
14.	3.347	3.238	96.14
15.	3.381	3.233	95.62

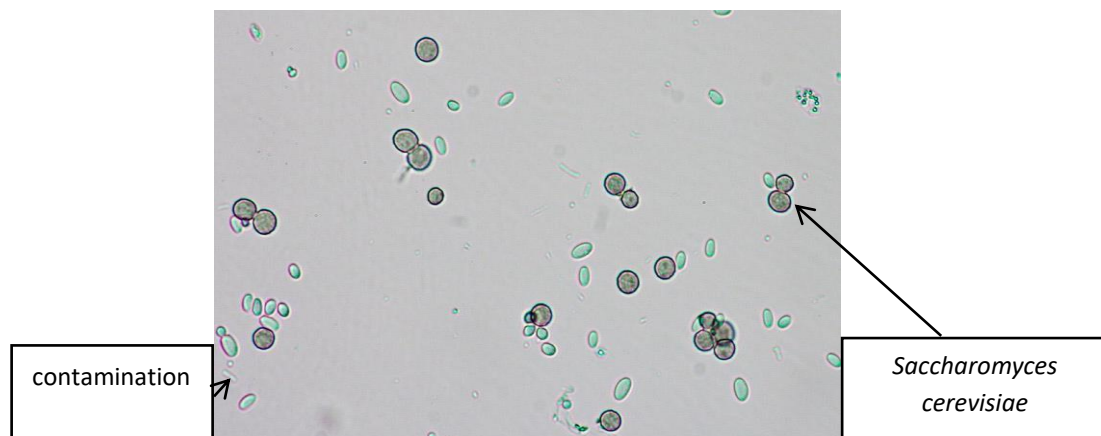

Picture 3 *Saccharomyces cerevisiae* and other microbiota in the last generation of the propagation tank B.

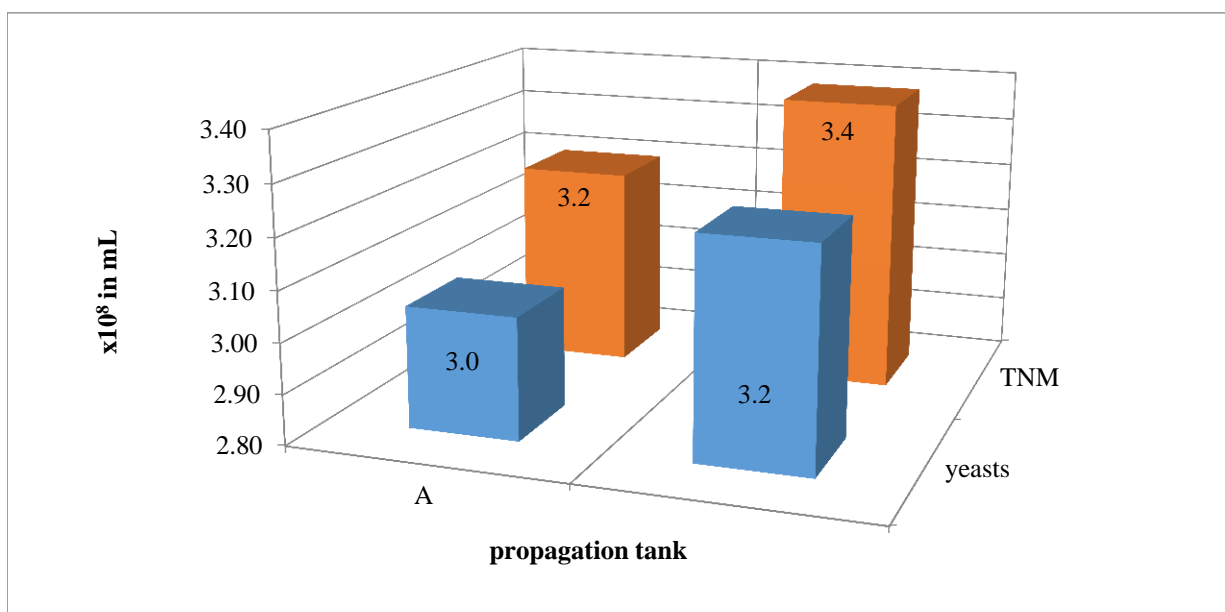

image contained only 95.09% of yeasts and this indicator signalled the need of total replacement of propagation. Undesirable microbiota in the microscopic slide was present in the form of sticks. During the industrial

bioethanol fermentation, *Saccharomyces cerevisiae* cells are often stressed by bacterial contaminants, especially lactic acid bacteria. Generally, lactic acid bacteria contamination can inhibit *S. cerevisiae* cell growth through

secreting lactic acid and competing with yeast cells for micronutrients and living space (Dong et al., 2015b). In our research, we did not identify representatives of undesirable microbiota, but only lactobacilli that could contaminate particularly ethanol production during the industrial production.

In the propagation sample B, the highest amount of yeasts was in the 13th generation, the number 3.233×10^8 mL (Table 2). The first generation, in contrast to sample A did not contain 100% *Saccharomyces cerevisiae* yeasts but only 99.84%. It shows that already at this stage were observed unwanted microbiota. On the other hand, the 15th generation of the propagation sample B contained 95.62% of yeasts, which was 0.53% higher than in sample A. From the first to the thirteenth generation we observed the increase of total plate count and also yeasts. But the number of yeasts in next generation declined. The total number of microorganisms has increased but more undesirable microbiota began to multiply at the expense of yeasts.

CONCLUSION

In spite of the fact that the promotion tanks A and B had the same volume and were prepared in the same way, there were visible slight variations in the results. The entire research process took place at the production factory, where it was influenced by several factors, in contrast to the laboratory conditions. The course of the promotion of both tanks was very similar. In the 13th generation there was a reproduction of yeast *Saccharomyces cerevisiae*, which was the predominant microbiota. Then it began to prevail in the undesirable microbiota. The modification of the microbiota was performed in acid-free reactor with sulphuric acid to prevent the spread of unwanted microbiota. The pH was controlled at 3.3 to 3.4. When the plate count of the microscopic image is less than 95% of yeast, it is necessary to reduce the pH of a propagation mash to pH 0.2. If such action would not improve conditions it is necessary to prepare a new mash with fresh yeasts. Preparation of the promotial tanks from 9.5 kg of dried alcohol yeast is sufficient, because it ensures that production runs for 6 days. The number of yeasts is sufficient for alcoholic fermentation lasting 70 hours. If there was no exchange in the 15th generation of promotion, unwanted microbiota would begin to multiply uncontrollably. This would lead to a reduction of ethanol yield.

It is necessary to constantly monitor the process of propagation as a healthy basis for the alcoholic fermentation. If a sufficient number and vitality of yeast is ensured, it is possible to say that the fermentation process will proceed standard way. Therefore, it is important to control the constant propagation tanks.

According to the Regulation of the operating company Po-05 it is necessary to perform a full exchange of promotion tanks when the amount of the yeast is under 95%. In both cases, research has confirmed that the fifteenth generation of yeasts is already marginal and therefore it is necessary to perform a full exchange yeasts in promotional tanks. The figure 1 showed us the fifteenth generation of both promotions where we carried out a 100% replacement of yeast, to prevent further spread of unnecessary microbiota. The research was conducted at the

factory, where the 100% equivalent conditions cannot be modulated. Therefore, there were observed two promotional tanks A and B. They were identical and the measurements were done in parallel. In the preparation of promotial tanks the same amount of yeast and the same successor saccharification was used. Therefore, the results of both observations were not completely consistent. On the other hand, the promotial tank B was confirmed by the measurements taken in the tank A.

Yeasts are among one of the most expensive components participating in the fermentation process. At the same time, they are the most important, because without the yeast, fermentation would not be possible and yeast is the component that affects the whole process of fermentation. Therefore, it is very important to check the contamination, vitality of yeasts and their count.

REFERENCES

- Akinosho, H., Rydzak, T., Borole, A., Ragauskas, A., Close, D. 2015. Toxicological challenges to microbial bioethanol production and strategies for improved tolerance. *Ecotoxicology*, vol. 24, no. 10, p. 2156-2174. <https://doi.org/10.1007/s10646-015-1543-4> PMID:26423392
- Amillare, E., Aceves-Lara, C. A., Uribellarrea, J. L., Alfenore, S., Guillouet, S. E. 2012. Dynamic model of temperature impact on cell viability and major product formation during fed-batch and continuous ethanolic fermentation in *Saccharomyces cerevisiae*. *Bioresource Technology*, vol. 117, p. 242-250. <https://doi.org/10.1016/j.biortech.2012.04.013> PMID:22617033
- Casalone, E., Barberio, C., Cappellini, L., Polsinelli, M. 2005. Characterization of *Saccharomyces cerevisiae* natural populations for pseudohyphal growth and colony morphology. *Research in microbiology*, vol. 156, no. 2, p. 191-200. <https://doi.org/10.1016/j.resmic.2004.09.008> PMID:15748984
- Čerňanský, S., Khun, M. 2011. *Utilization of technical microbiology in the fermentation and food industry (Využitie technickej mikrobiológie v kvasnom a potravinárskom priemysle)*. 1st ed. Bratislava, Slovakia : Univerzita Komenského. 250 p. ISBN 978-80-223-3135-7.
- Demcke, M. M., Dietz, H., Li, Y., Foulquie-Moreno, M. R., Mutturi, S., Deprez, S., Den Abt, T., Bonini, B. M., Liden, G., Dumortier, F., Verplaetse, A., Boles, E., Thevelein, J. M. 2013. Development of a D-xylose fermenting and inhibitor tolerant industrial *Saccharomyces cerevisiae* strain with high performance in lignocelluloses hydrolysates using metabolic and evolutionary engineering. *Biotechnology for Biofuels*, vol. 6, no. 1, p. 89. <https://doi.org/10.1186/1754-6834-6-89> PMID:23800147
- Dong, S. J., Lin, X. H., Li, H. 2015. Regulation of *Lactobacillus plantarum* contamination on the carbohydrate and energy related metabolisms of *Saccharomyces cerevisiae* during bioethanol fermentation. *The International Journal of Biochemistry & Cell Biology*, vol. 68, p. 33-41. <https://doi.org/10.1016/j.biocel.2015.08.010> PMID:26279142
- Dong, S. J., Yi, CH. F., Li, H. 2015. Changes of *Saccharomyces cerevisiae* cell membrane components and promotion to ethanol tolerance during the bioethanol fermentation. *The International Journal of Biochemistry & Cell Biology*, vol. 69, p. 196-203.

<https://doi.org/10.1016/j.biocel.2015.10.025>

PMid:26515124

Furdíková, K., Malík, F. 2016. Methods of conducting alcohol fermentation (Spôsoby vedenia alkoholovej fermentácie). *Agroporadenstvo*.

Ginley, D. S., Cahen, D. 2012. *Fundamentals of Material for Energy and Environmental Sustainability*. UK : Cambridge University Press. 754 p. ISBN 1139502689, 9781139502689.

Kasavi, C., Finore, I., Lama, L., Nicolaus, B., Oliver, S. G., Oner, E. T., Kirdar, B. 2012. Evaluation of industrial *Saccharomyces cerevisiae* strains for ethanol production from biomass. *Biomass and Bioenergy*, vol. 45, p. 230-238.

<https://doi.org/10.1016/j.biombioe.2012.06.013>

Khongsay, N., Laopaiboon, L., Laopaiboon, P. 2010. Growth and batch ethanol fermentation of *Saccharomyces* on sweet sorghum stem juice under normal and very high gravity conditions. *Biotechnology*, vol. 9, no. 1, p. 9-16.

<https://doi.org/10.3923/biotech.2010.9.16>

Kumar, V., Sinha, A. K., Makkar, H. P. S., Becker, K. 2010. Dietary roles of phytate and phytase in human nutrition : A review. *Food chemistry*, vol. 120, no. 4, p. 945-959.

<https://doi.org/10.1016/j.foodchem.2009.11.052>

Manikandan, K., Viruthagiri, T. 2010. Kinetic and optimization studies on ethanol production from corn flour. *International Journal of Chemical and Biological Engineering*, vol. 3, no. 2, p. 65-69.

Mikulski, D., Kłosowski, G., Rolbiecka, A. 2014. Effect of phytase application during high gravity (HG) maize mashes preparation on the availability of starch and yield of the ethanol fermentation process. *Applied Biochemistry and Biotechnology*, vol. 174, no. 4, p. 1455-1470.

<https://doi.org/10.1007/s12010-014-1139-0>

PMid:25119551

Muruaga, M. L., Carvalho, K. G., Domínguez, J. M., de Souza Oliveira, R. P., Perotti, N. 2016. Isolation and characterization of *Saccharomyces* species for bioethanol production from sugarcane molasses: Studies of scale up in bioreactor. *Renewable Energy*, vol. 85, p. 649-656.

<https://doi.org/10.1016/j.renene.2015.07.008>

Mycobank Database, 2016. Fungal Databases, Nomenclature and Species banks [online] s.a. [cit. 2017-02-01] Available at: <http://www.mycobank.org/>.

Paschos, T., Xiros, Ch., Christakopoulos, P. 2015. Simultaneous saccharification and fermentation by co-cultures of *Fusarium oxysporum* and *Saccharomyces cerevisiae* enhances ethanol production from liquefied wheat straw at high solid content. *Industrial Crops and Products*,

vol. 76, p. 793-802.

<https://doi.org/10.1016/j.indcrop.2015.07.061>

Pelikán, M., Sáková, L. 2001. *Quality and processing of plant products (Jakost a zpracování rostlinných produktů)*. České Budějovice, Czech Republic : ZF JČU. 233 p. ISBN 80-7040-502-3.

Rebroš, M., Rosenberg, M., Křištofiková, L., Stloukal, R. 2005. Microbial production of fuel ethanol: bacteria or yeasts? (Mikrobiálna produkcia palivového etanolu: baktérie alebo kvasinky?). *Chemické listy*, vol. 99, no. 402-409.

Rob, O., Hrabě, J. 2009. *Non-alcoholic and alcoholic beverages (Nealkoholické a alkoholické nápoje)*. 1st ed. Zlín, Czech Republic : Univerzita Tomáše Bati. 129 p. ISBN 978-80-7318-748-4.

Sun, X., Liu, L., Zhao, Y., Ma, T., Zhao, F., Huang, W., Zhan, J. 2016. Effect of copper stress on growth characteristics and fermentation properties of *Saccharomyces cerevisiae* and the pathway of copper adsorption during wine fermentation. *Food Chemistry*, vol. 192, p. 43-52.

<https://doi.org/10.1016/j.foodchem.2015.06.107>

PMid:26304318

Veselá, M. 2004. *Practice in general microbiology (Praktikum z obecné mikrobiologie)*. Brno, Czech Republic : FCH VUT. 3rd ed. 99 p. ISBN 80-214-2567-9.

Wang, Y., Zhang, S., Liu, H., Zhang, L., Yi, Ch., Li, H. 2015. Changes and roles of membrane compositions in the adaptation of *Saccharomyces cerevisiae* to ethanol. *Journal of Basic Microbiology*, vol. 55, no. 12, p. 1-10.

<https://doi.org/10.1002/jobm.201500300>

PMid:26265555

Acknowledgments:

This work was supported by Research Center AgroBioTech built in accordance with the project Building Research Centre „AgroBioTech“ ITMS 26220220180 and KEGA 015SPU-4/2015.

Contact address:

Ing. Viera Michalová, Slovak University of Agriculture, Faculty of Biotechnology and Food Science, Department of Microbiology, Trieda Andreja Hlinku 2, 949 76 Nitra, Slovakia, E-mail: viera.michalova@uniag.sk
 prof. Ing. Dana Tančinová, PhD., Slovak University of Agriculture, Faculty of Biotechnology and Food Science, Department of Microbiology, Trieda Andreja Hlinku 2, 949 76 Nitra, Slovakia, E-mail: dana.tancinova@uniag.sk



EFFECT OF PERORAL SUPPLEMENTATION WITH SELENIUM AND VITAMIN E DURING LATE PREGNANCY ON UDDER HEALTH AND MILK QUALITY IN DAIRY COWS

Milan Vasil', Fratišek Zigo, Juraj Elečko, Martina Zigová, Zuzana Farkašová

ABSTRACT

The aim of the experiment was to study selenium and vitamin E sources in the diet of dairy cows in late phase of pregnancy and their effects on udder health and milk quality during the first two weeks after calving. The experiment included 48 cows of Holstein breed divided into four equal groups ($n = 12$). The first experimental group (D1) was fed with addition of vitamin E in total dose of 1020 dl-a-tocopherol acetate Se/cow per day. The second group (D2) was added the selenium at a dose of 0.3 mg.kg⁻¹ of DM in form of sodium selenite. The third group (D3) was supplemented with addition of vitamin E in combination with sodium selenite in total dose of 1020 dl-a-tocopherol acetate Se/cow per day and of 5.0 mg Se/cow per day, respectively. The control group (C) was without the addition of selenium and vitamin E. In group (D2) with addition of selenium at a dose of 0.3 mg.kg⁻¹ of DM and vitamin E a dose of 50 mg dl-a-tocopherol acetate/kg of DM in diet, increased the plasmatic concentration of selenium and vitamin E and reduced the incidence of mastitis by 13.3% and number of somatic cells during periparturient period in comparison with other groups.

Keywords: dairy cows; selenium; vitamin E; mastitis; SCC

INTRODUCTION

Cows that are especially highly efficient are predisposed to metabolic, infectious and reproductive diseases during the periparturient period because of immune system suppression, rapid hormonal changes during birthing, and metabolic stress associated with lactation. The periparturient period is a time during which dairy cows are at risk, and they are prone to diseases that could affect their productivity. Mastitis, hypocalcemia, fatty liver syndrome, retained placenta, metritis, ketosis and other related diseases occur frequently in this period. Due to immune system suppression during the periparturient period, such diseases cause decreases in productivity and even culling of cows (Kafilzadeh et al., 2014; Horký, 2015).

Vitamins and minerals are micro-nutrient components that play important functions in all organisms, especially during reproduction. Selenium (Se) and vitamin E (VTE) are often deficient in compound feeding stuffs during dry period. Biological functions of selenium are complemented by VTE, which also shows the effects of a cellular antioxidant (Mohri et al., 2005; Meyer et al., 2014).

It has been reported that the supplementation of Se and VTE during late pregnancy provides increased fertilization in the number of service per conception and pregnancy

rate, decreased open days, ovarian cysts, incidence of mastitis and retained placenta (Lacetera et al., 1996).

According Nutrient requirements of dairy cattle (NRC, 2001) dietary recommendations for VTE and Se intake are 1000 IU VTE/head/day and 0.3 mg Se/kg of DM for dry cows. Diets containing under 0.2 mg Se/kg of DM, and 500 IU of VTE/head/day are deficient for antioxidant effect and immunostimulation of organism in transition period. Fresh green forages are excellent sources of VTE, usually containing 80-200 IU VTE/kg of DM. Diets of cows in total confinement housing depend on ensiled forages and hay as a source of roughage. These forages contain only one-fifth to one-sixth the amount of vitamin E in freshly cut forages in the vegetative state.

This study aimed to determine the effects of Se and VTE application on occurrence of mastitis and the quality of the produced milk in terms of functional food into the diet of dairy cows.

MATERIAL AND METHODOLOGY

Animal management

The experiment was carried out in herd of 270 Holstein cattle in east of Slovakia. Dairy cows were kept in a free housing system with a separate calving barn and equipped

with individual boxes with bedding and were allowed *ad libitum* access to water.

The mean daily intake for the dry period and at 5th day after calving under study was 10 kg and 18 kg of DM, respectively. The average milk yield of the dairy cows was 7,500 ±48 kg per lactation. Milking took place in the parallel parlor Boumatic 2 x 10 Xpressway (Wisconsin, USA). Before drying was applied intramammary antibiotic preparation Orbenin Dry cow a.u.v. (Pfizer, IT) to every quarter of udder.

The experiment included 48 Holstein dairy cows divided into four equal groups received the diets based on a total mixed ration (TMR). All animals received the diets based on a TMR that is required for the cows during the dry period and the beginning of lactation containing grass hay, corn silage, clover-grass silage, grass haylage, triticale grain, soybean meal and concentrate.

During pre partum and post partum, all cows received the diets containing 31 and 36 mg of vitamin E per kg of DM, respectively, but with the same amount of Se (0.2 mg.kg⁻¹ DM) in both diets.

Peroral application of Se and VTE

Four weeks prior to the expected parturition were the cows in groups D1, D2 and D3 peroral supplemented as follows:

- the first group (D1) of cows (n = 12) was supplemented with addition of Hydrovit E forte (PharmaGal, SR) in the dose 50 mg dl-a-tocopherol acetate/kg of DM in total dose of 1020 dl-a-tocopherol acetate Se/cow per day.
- the second group (D2) of cows (n = 12) was added the selenium at a dose of 0.3 mg.kg⁻¹ of DM in form of sodium selenite (Centralchem, SR) in total dose of 5.0 mg Se/cow per day.
- the third group (D3) of cows (n = 12) was supplemented with addition of Hydrovit E forte (PharmaGal, SR) in the dose 50 mg dl-a-tocopherol acetate/kg of DM and of 0.3 mg Se/kg in form of sodium selenite (Centralchem, SR) in total dose of 1020 dl-a-tocopherol acetate and 5.0 mg Se/cow per day, respectively).
- the control group (C) of cows (n = 12) was without the addition of selenium and vitamin E (this group of animals received only selenium and vitamin E from native sources). Selenium and vitamin E were mixed to the basic ration (TMR) and fed in the morning dose.

Collection of samples and laboratory examination

Blood samples were collected into 12 mL heparinised test tubes from the *jugular vein* of cows four weeks before the expected time of calving, on parturition day and at 14th day after calving. We also collected colostrum into 10 ml tubes immediately after the parturition.

On the basis of the comprehensive examinations on the 14th day according to **Jackson and Cockcroft (2002)** which consisted of a clinical examination, California mastitis test (CMT) and laboratory examination was analysed milk from each quarter of the udder. For the purpose of determining the values selected vitamin-mineral elements, was taken 1 kg comprehensive sample of TMR from feed according to **Van Soets et al. (1991)**.

Laboratory analysis

The blood plasma obtained by high speed centrifugation of heparinised blood at 3000 rpm during 15 min. The concentration of the Se in samples of feed, plasma, colostrum were determined by atomic absorptive spectrometer Zeman 4100 (Perkin Elmer, USA) according to the analytical procedure standardised by **Pechova et al. (2005)**.

The concentration of α -tocopherol in the samples of feed, plasma and colostrum were analysed by HPLC method according to **Hess et al. (1991)**. Determination of vitamin E from the homogenized sample from TMR after saponification and extraction by HPLC method was carried out by **Politis et al. (1996)**. The SCC were analysed in a commercial laboratory using a MilkoScan FT2 (Foss Electric, Hillerod, Denmark).

Milk samples (0.05 mL) were inoculated onto blood agar (Oxoid, UK) and cultivated at 37 °C for 24 h. Based on the colony morphology, bacteria *Staphylococcus* spp. were selected for the tube coagulase test (Staphylo PK, ImunaPharm, SR). Suspect colonies *Staphylococcus* spp., *Streptococcus* spp. and *Enterobacteriaceae* spp. were isolated on blood agar, cultivated at 37 °C for 24 h and identified biochemically using the STAPHY-test, STREPTO-test, resp. ENTERO-test and identification by software TNW Pro 7.0 (Erba-Lachema, CZ). Dry matter was acquired by 48 h drying sample at 105 °C.

Statistical analysis

Tukey's post tests were used to compare all four experimental groups and significant effect of peroral treatment was indicated by ANOVA. Differences between the mean values of the different treatment groups were considered assuming significance levels of 0.05 and 0.01. Values in tables are means (M) and standard deviation (SD).

RESULTS AND DISCUSSION

Selenium and vitamin E are important nutrients in animal and human areas. The receiving adequate level of selenium and vitamin E in the diet is essential for the maintaining of good health and reproduction parameters. Selenium is a part of the enzyme GPx transforming hydrogen peroxide to water and molecular oxygen. The food is low on selenium content and the total amount of antioxidants, which are associated with civilization diseases in many cases (**Horký, 2015**).

Selenium plasma concentrations of cows is shown in Table 1. In assessing the blood selenium status we can use three basic stages of evaluation: adequate (<100 µg.L⁻¹), marginal (70 – 100 µg.L⁻¹) and deficient (>70 µg.L⁻¹) (**Pavlata et al. 2004**).

At the beginning of the period considered, the measured values of Se in the blood plasma of dairy cows were in the range of 72.1 – 77.3 µg.L⁻¹, which can be considered as marginal concentration of this element. The animals of the supplemented groups D2 and D3 had significantly higher blood Se concentrations at day of parturition and 14th day after than the groups D1 and C (Tab.1).

It is well accepted that vitamin E supplementation during the dry period has a positive effect on the udder health of dairy cows in early lactation as various studies reported a

Table 1 Effect of peroral supplementation of selenium and vitamin E on the concentrations of α -tocopherol ($\mu\text{g}\cdot\text{mL}^{-1}$) and Se ($\mu\text{g}\cdot\text{L}^{-1}$) in blood plasma, milk and colostrum.

Period			Groups			
			C	D1	D2	D3
			M \pm SD	M \pm SD	M \pm SD	M \pm SD
28 th day a. p.	cows	VTE	5.5 \pm 0.58	5.2 \pm 0.50	5.8 \pm 0.72	5.0 \pm 0.56
		Se	75.1 \pm 6.8	75.2 \pm 6.1	77.3 \pm 5.5	72.1 \pm 6.8
parturition	cows	VTE	4.4 \pm 0.76 ^a	4.3 \pm 0.48 ^a	8.4 \pm 0.76 ^b	8.2 \pm 0.82 ^b
		Se	69.4 \pm 6.7 ^a	68.1 \pm 6.9 ^a	82.5 \pm 5.8 ^b	88.1 \pm 9.1 ^b
	colostrum	VTE	9.8 \pm 1.7 ^A	10.2 \pm 2.1 ^A	19.7 \pm 2.5 ^B	18.1 \pm 2.3 ^B
		Se	30.5 \pm 4.4 ^a	35.1 \pm 3.1 ^a	43.1 \pm 4.7 ^b	44.7 \pm 5.6 ^b
14 th day p. p.	cows	VTE	4.6 \pm 0.58 ^a	4.2 \pm 0.48 ^a	6.9 \pm 0.57 ^b	6.4 \pm 0.67 ^b
		Se	71.6 \pm 6.1 ^a	70.4 \pm 7.1 ^a	85.7 \pm 8.8 ^b	82.3 \pm 8.1 ^b

Note: a. p. – ante partum; p. p. – post partum; Se – selenium, VTE – vitamin E, a, b significance level $p < 0.01$ or A, B significance level $p < 0.001$ is presented by different superscribes in a row.

Table 2 Occurrence and aetiology of mastitis at 14th day after calving.

groups	Σ^h		Σ^i		Infected quarters	Mastitis forms from infected quarters (%)				Milk produc.*	SCC* $\times 10^3$
	n	%	n	%		L	SC	SA	A		
C	11	73.3	4	26.7	12	16.7	33.3	25.0	25.0	33.4 \pm 4.7	235 \pm 46 ^b
D1	11	73.3	4	26.7	11	9.1	18.2	45.5	27.3	32.6 \pm 5.1	229 \pm 38 ^b
D2	11	73.3	4	26.7	9	-	22.2	55.5	22.2	32. \pm 5.9	216 \pm 31
D3	13	86.7	2	13.3	5	-	20	60	20	35.7 \pm 6.1	174 \pm 54 ^a
							pathogens				
							CPS ¹	CNS ²	Str. spp.	other ³	
C							3	5	2	2	
D1							2	3	4	2	
D2							4	4	1		
D3							2	2		1	

Note: Σ^h – number of healthy dairy cows, Σ^i – number of infected dairy cows, nIq – infected quarters, rejected quarters – dairy cows with atrophy or fibrosis in the mammary gland, L – latent mastitis, SB - subclinical mastitis, SA – subacute mastitis, A - acute mastitis, Milk produc.* – milk production in the first month, SCC* – in the first month of lactation, CPS – (coagulase-positive staphylococci) *S. aureus*, *S. hyicus*, CNS¹ – (coagulase-negative staphylococci) *S. epidermidis*, *S. chromogenes*, *S. xylosum* and *S. schleiferi*, Str. spp. – *S. uberis*, *S. agalactiae*, other – *E. coli*, *Bacillus* spp., a, b – significance level $p < 0.05$ is presented by different superscribes in a column.

reduced incidence of (sub)clinical mastitis after supplementation (Bouwstra et al. 2010).

Over the last 10 year, feeding strategies may have changed due to positive reports and new recommendations for supplementation VTE might only have a positive effect in studies where cows started with a marginal or deficient VTE status, which then improved during the trial because of the high level of VTE supplementation. Serum α -tocopherol concentrations ($>4.0 \text{ mg}\cdot\text{mL}^{-1}$) have been reported to be adequate in cattle. Canadian researchers testing 10 clinically normal cows from 5 different herds found mean serum vitamin E concentrations in the 5 herds to range from 3.2 – 5.3 $\text{mg}\cdot\text{mL}^{-1}$ (Batra et al., 1992).

Low plasma levels ($<4.0 \text{ mg}\cdot\text{mL}^{-1}$) in the present study have been reported in calves from the control and D1 groups (Table 2).

Table 2 shows that after oral administration of the selenium-vitamin supplements in group D3 was observed the reduction of cases of mastitis and infected quarters. In D1, D2 and C groups were observed the same occurrence of mastitis on the level 73.3%.

Similar results were found by Smith et al. (1997) who supplied dairy cows with addition of 0.3 ppm selenium to all classes of cattle and feeding 1000 $\text{IU}\cdot\text{day}^{-1}$ of

supplemental vitamin E to dry cows and springing heifers and 500 $\text{IU}\cdot\text{day}^{-1}$ to lactating cows improves immunity, reduces the incidence of clinical mastitis, and reduces SCC.

Staphylococci are the main aetiological agents of ruminant IMI and *Staphylococcus aureus* with coagulase-negative species (CNS) is the most frequent isolate from subclinical and clinical cases IMI. The annual incidence of clinical IMI in dairy herds is generally lower than 5%, but in a small percentage of herds the incidence may exceed 30 – 50% of the animals, causing mortality (gangrenous mastitis) or culling of up to 70% of the herd (Vautor et al. 2009).

By our analysis of the quarter samples we confirmed CPS, CNS, bacteria *Streptococcus uberis*, *Streptococcus agalactiae*, which is most often associated with the formation of the subacute and acute forms of mastitis.

CONCLUSION

Supplemental vitamin E and selenium improve immune function of dairy cattle, especially during the peripartum period. An inadequate intake of selenium and vitamin E is related with an increased their plasmatic concentration and reduced the incidence of mammary gland infections and

number of somatic cells. The application of selenium and vitamin E in feed doses is one of the ways how to increase their intake in animal food and products.

REFERENCES

- Batra, T. R., Hidirolou, M., Smith, M. V. 1992. Effect of vitamin E on incidence of mastitis in dairy cattle. *Canadian Journal of Animal Science*, vol. 72, no. 2, p. 287-297. <https://doi.org/10.4141/cjas92-036>
- Bouwstra, R. J., Nielen, M., Stegeman, J. A., Dobbelaar, P., Newbold, J. R., Jansen, E. H., Van Werven, T. 2010. Vitamin E supplementation during the dry period in dairy cattle. Part I: adverse effect on incidence of mastitis postpartum in a double-blind randomized field trial. *Journal of Dairy Science*, vol. 93, no. 12, p. 5684-5695. <https://doi.org/10.3168/jds.2010-3159> PMID:21094740
- Hess, D., Keller, H. E., Oberlin, B., Bonfanti, R., Schüep, W. 1991. Simultaneous determination of retinol, tocopherols, carotenes and lycopene in plasma by means of high-performance liquid chromatography on reversed phase. *International Journal for Vitamin and Nutrition Research*, vol. 61, no. 3, p. 232-238. PMID:1794952
- Horký, P. 2014. Effect of protein concentrate supplement on the qualitative and quantitative parameters of milk from dairy cows in organic farming. *Annals of Animal Science*, vol. 14, no. 2, p. 341-352. <https://doi.org/10.2478/aoas-2014-0008>
- Horký, P. 2015. Effect of selenium on its content in milk and performance of dairy cows in ecological farming. *Potravinárstvo*, vol. 9, no. 1, p. 324-329. <https://doi.org/10.5219/492>
- Jackson, P., Cockcroft, P. 2002. *Clinical Examination of Farm Animals*. Oxford, UK : Blackwell Science Ltd, Wiley-Blackwell, p. 154-166. ISBN 0-632-05706-8. <https://doi.org/10.1002/9780470752425>
- Kafilzadeh, F., Kheirmanesh, H., Karami Shabankareh, H., Targhibi, M. R., Maleki, E., Ebrahimi, M., Yong Meng, G. 2014. Comparing the effect of oral supplementation of vitamin e, injective vitamin e and selenium or both during late pregnancy on production and reproductive performance and immune function of dairy cows and calves. *Scientific World Journal*, vol. 2014, p. 1-5. <https://doi.org/10.1155/2014/165841> PMID:25045726
- Lacetera, N., Bernabucci, U., Ronchi, B., Nardone, A. 1996. Effects of selenium and vitamin E administration during a late stage of pregnancy on colostrum and milk production in dairy cows, and on passive immunity and growth of their offspring. *American Journal of Veterinary Research*, vol. 57, no. 12, p. 1776-1780. PMID:8950434
- Meyer, U., Heerdegen, K., Schenkel, H., Dänicke, S., Flachowsky, G. 2014. Influence of various selenium sources on selenium concentration in the milk of dairy cows. *Journal für Verbraucherschutz und Lebensmittelsicherheit*, vol. 9, no. 2, p. 101-109. <https://doi.org/10.1007/s00003-014-0870-3>
- Mohri, M., Seifi, H. A., Khodadadi, J. 2005. Effects of preweaning parenteral supplementation of vitamin E and selenium on hematology, serum proteins, and weight gain in dairy calves. *Comparative Clinical Pathology*, vol. 14, no. 3, p. 149-154. <https://doi.org/10.1007/s00580-005-0581-3>
- NRC. 2001. *Nutrient Requirements of Dairy Cattle*. 7th ed. Washington, DC : National Academy Press. 408 p. ISBN: 978-309-06997-7.
- Pavlata, L., Prasek, J., Filipek, A., Pechova, A. 2004. Influence of parenteral administration of selenium and vitamin E during pregnancy on selected metabolic parameters and colostrum quality in dairy cows at parturition. *Veterinární Medicina*, vol. 49, no. 5, p. 149-155.
- Pechova, A., Pavlata, L., Illek, J. 2005. Blood and tissue selenium determination by hydride generation atomic absorption spectrophotometry. *Acta Veterinaria Brno*, vol. 74, p. 483-490. <https://doi.org/10.2754/avb200574040483>
- Politis, I. M., Hidirolou, J. H., White, J., Gilmore, S. N., Williams, H. Scherf, H., Frigg, M. 1996. Effects of vitamin E on mammary and blood leukocyte function with emphasis on chemotaxis in periparturient dairy cows. *American Journal of Veterinary Research*, p. vol. 57, no. 4, p. 468-471.
- Smith, K. L., Hogan, J. S., Weiss, W. P. 1997. Dietary vitamin E and selenium affect mastitis and milk quality. *Journal of Animal Science*, vol. 75, no. 6, p. 1659-1665. <https://doi.org/10.2527/1997.7561659x> PMID:9250530
- Van Soest, P. J., Robertson, J. B., Lewis, B. A. 1991. Methods for dietary fiber, neutral detergent fiber and non-starch polysaccharides in relation to animal nutrition. *Journal of Dairy Science*, vol. 74, no. 10, p. 3583-3597. [https://doi.org/10.3168/jds.S0022-0302\(91\)78551-2](https://doi.org/10.3168/jds.S0022-0302(91)78551-2)

Acknowledgments:

This work was supported by grant VEGA No. 1/0510/16.

Contact address:

Doc. MVDr. Milan Vasil', CSc., University of Veterinary Medicine and Pharmacy, Department of Animal Husbandry, Komenského 73, 041 81 Košice, Slovakia, E-mail: milan.vasil@uvlf.sk

MVDr. František Zigo, PhD., University of Veterinary Medicine and Pharmacy, Department of Animal Husbandry, Komenského 73, 041 81 Košice, Slovakia, E-mail: frantisek.zigo@uvlf.sk

MVDr. Juraj Elečko, CSc., University of Veterinary Medicine and Pharmacy, Department of Animal Husbandry, Komenského 73, 041 81 Košice, Slovakia, E-mail: juraj.elecko@uvlf.sk

MVDr. Martina Zigoová, PhD., Pavol Jozef Šafárik University of Košice, Department of Pharmacology, Šrobárova 1014/2, 040 01 Košice, Slovakia, E-mail: chripkova.martina@gmail.com

MVDr. Zuzana Farkašová, PhD., University of Veterinary Medicine and Pharmacy, Department of Animal Husbandry, Komenského 73 041 81, Košice, Slovakia, E-mail: zuzana.farkasova@uvlf.sk

COMPARATIVE STUDY OF BIOCORRECTIVE PROTEIN-PEPTIDE AGENT TO IMPROVE QUALITY AND SAFETY OF LIVESTOCK PRODUCTS

*Irina Mikhailovna Chernukha, Liliya Viacheslavovna Fedulova,
Ekaterina Romanovna Vasilevskaya, Elena Alexandrovna Kotenkova*

ABSTRACT

Water with modified isotopic composition (D/H = 40 ppm) as a solubilizing agent for biologically active substances extraction from immune organs *Sus Scrofa* increases protein yield in thymus to 20%, in spleen up to 38%, mesenteric lymph nodes up to 35% in comparison with distilled water (D/H = 150 ppm). It was found a significant amount of neurotransmitter amino acids, such as aspartic and glutamic acids, glycine (thymus – 10.5; 13.7; 7.6%; spleen – 12.2; 10.7; 7.8% lymph nodes – 11.0; 13.3; 11.1%, respectively) having the immunological and adaptogenic activity, in extracts of *Sus scrofa* immunocompetent organs (thymus, spleen, mesenteric lymph nodes). Application of water with modified isotopic composition as solubilizing agent (D / H = 40 ppm) for extraction of immunocompetent organs' biologically active compounds led to increased amino acid content, including hydrophilic amino acids, in thymus extracts – up to 22%, in spleen extracts – up to 15% , in lymph nodes extracts – up to 8%, in comparison to distilled water (D / H = 150 ppm). Peptide profile analysis revealed positive effect of water (D/H = 40 ppm) on a quality protein content extracts in molecular weight range from 10 to 20 kDa and from 30 to 45 kDa and peptide composition (2 kDa), at the same time quantitative content of compounds adaptogenic and immunocorrective action increased. Reducing of deuterium content in the solubilizing agent enhances quantitative amino acid content, i.e. extraction in an aqueous- salt solution based on deuterium depleted water of animal tissues with a high content of amino acids with hydrophilic radicals proceeded more completely.

Keywords: immunocorrection, adaptogen, deuterium depleted water, peptide profile, amino acid

INTRODUCTION

Nowadays, problem of the uncontrolled antibiotic non-medical application causes a sharp challenge because feed antibiotics as growth promoters lead to evolution, selection and accumulation of antibiotic-resistant strains of pathogenic and opportunistic agents in farms (Sokolov, 2015).

Recent studies indicate that antibiotics subinhibitory concentration increases quantity of resistant bacteria by horizontal gene transfer, as well as due to reactive oxygen species stimulation that contribute to the growth of mutant microorganisms with poly-drug resistance (Khaitov, 1993).

These pathogens can be transmitted from livestock to humans through contaminated environment and food products, mainly meat and milk, causing infectious diseases, which treatment is carried out by analogous already inefficient, synthetic antimicrobial agents, resulting in increased doses of medication, the recovery period of the organism and, finally, economic cost (Carlet, Ben and Chalfin, 2004). Thus, the reduction of irrational use of antibiotics in agriculture through the development

and implementation of natural antimicrobial and immunomodulating agents, is highly relevant (Chernukha et al., 2015; Hawkey, 1998).

Currently, most of the biotechnology research aimed at obtaining and study of biologically active substances from animal products. Thus, processing secondary raw materials in the food industry presently hardly exceeds 20% by mass formed, despite the fact that bulk of the "waste" for disposal legislation prohibits (Roca et al., 2015). In addition to the environmental aspect, in particular, the reduction of anthropogenic impacts on the environment due to waste recycling, the practical importance is the use of secondary products to create food and additives, high-value pet food, medical and cosmetic products and medicines (Perron et al., 2015).

Natural veterinary products industry with high biological activity based on animal raw for farm animals is on the stage of development in Russia. This is a very perspective and dynamically developing direction in the field of deep processing of secondary raw materials. Moreover, meat industry has a great potential for its implementation due to the diverse and unique composition of the main and

secondary products of the industrial slaughter of animals (Kim and Yung, 2015). Ongoing research suggests the development of veterinary drugs manufacturing technology and isolating bioactive compounds from low-value raw materials of animal origin, which may result in higher quality livestock products (Dzhimak et al., 2014). The scientific concept of innate immunity origin confirms the fact that survival possibility of any species including humans under the environment abundant in potentially pathogenic microorganisms is evolutionary process of mechanisms development ensuring resistance to infections (Kokryakov, 1999). Resistance (immunity) is divided into the general and local, innate and adaptive one. Reactions providing resistance are divided into antibacterial and antitoxic (Pozdeev, 2004). Immunomodulating bioactive substances extracting from endocrine glands, thymus and spleen of reindeers featuring have been shown to possess a strong stimulating impact on main characteristics of the immune system (Vladimirov, 2001, Matveev, 2001, Lebedeva and Jamsaranova, 2004, Bondarenko and Bezborodov, 2009). Extracts of pigs immune organs potentially contain large amounts of protein and peptide compounds that are actively involved in immune defense reactions of the organism (Vasilevskaya and Fedulova, 2015).

We suppose that water with modified D/H isotopic composition (WMIC) can be used for optimization the biocatalysis process as a solubilizing agent and also it can lead to significant quantitative and qualitative changes in the composition of protein-peptide extracts.

The aim of the study was investigation of bioactive components contained in water-salt extracts obtained from *Sus scrofa* immune organs involved in immune system functioning.

MATERIAL AND METHODOLOGY

The subjects was water-salt extracts obtained from *Sus Scrofa* organs (spleen tissue extracts; thymus tissue extracts; extracts of mesenteric lymph nodes and a combined mixtures of the extracts) based on distilled water (DW) and water with modified D/H composition (WMIC).

Sample preparation

Sample preparation consisted in the separation of organs from related tissues, grinding to a particle size of 3 ± 1 mm, extraction physiological solutions DW and WMIC (Hydromoduls 1 : 5, speed 400 rev / min for 3 hours) at 4 °C in laboratory dispersing system (Laboteks, Russia). Extracts sampling for determination of protein concentration was carried out punctually, prior to extraction, and then every 15 minutes. After extraction finished samples were centrifuged in a centrifuge CM-6M (ELMI, Latvia) at 3500 rev / min for 5 min, supernatant was collected. Protein concentration was determined in a photometer BioChem SA (HTI, USA) by biuret method. The mathematical treatment of the data including calculation of averages with standard errors ($M \pm m$) was carried out.

Amino acid composition

The study of the amino acid composition was carried out on "BiotronikLC-2000" amino acid analyser (Germany).

Amino acids determination was carried out in automatic ion exchange resin "DC-6A" (USA) analytical column using three sodium citrate buffer system (Sigma-Aldrich, USA): buffer A – 0.18 M, pH 3.25; buffer B – 0.3 M, pH 3.9; buffer C – 1.6 M, pH 4.75. High of the resin in the column was 22 cm, buffer solution flow rate - 32 mL.h⁻¹. Ninhydrin reaction was used for amino acids detection, ninhydrin flow rate was 20 mL.h⁻¹.

Electrophoresis

One-dimensional (1D) electrophoresis was performed according to the method of Laemmli (Laemmli U.K., 1970) under denaturing conditions in 12.5% polyacrylamide gel with the presence of SDS. The marker was used comprising of eleven standards (recombinant proteins) "Thremo" (USA).

Two-dimensional (2D) electrophoresis was performed according to the method of O'Farrell (O'Farrell, 1975) with isoelectric focusing in ampholine pH gradient (IEF-PAGE). The subsequent detection of the proteins was carried out by staining with Coomassie Brilliant Blue R-250. Identification of protein fractions was performed on DE after trypsinolysis by MALDI-TOF/MS and MS/MS mass spectrometry on Ultraflex MALDI-TOF mass spectrometer (Bruker, Germany) with UV laser (336 nm) in the positive ion mode in molecular weight range of 500 – 8000 Da with calibration according to known peaks of trypsin autolysis. Analysis of obtained tryptic peptides mass spectra was performed using Peptide Fingerprint option in Mascot software (Matrix Science, USA) with MH+ mass determination accuracy of 0.01%; search was performed in databases of the National Center for Biotechnology Information, USA (NCBI).

RESULTS AND DISCUSSION

It was shown solubilizing agent effect on extraction time and protein content in extracts (Table 1). While spleen extraction, protein content maximum was reached in 75 minutes, and obtained in WMIC solution 25.5 ± 0.2 g.L⁻¹, in DW solution – by 20 % lower (20.4 ± 0.4 g.L⁻¹). While thymus extraction with WMIC solution, maximum protein concentration obtained 18.9 ± 0.2 g.L⁻¹ in 30 min, whereas while extraction with DW solution maximum protein content was by 38% lower (11.7 ± 0.3 g.L⁻¹) in 45 min. While lymph nodes extraction in WMIC solution maximum protein concentration obtained 19.5 ± 0.47 g.L⁻¹ in 75 min, in solution based on DW protein level peaked at 45 minutes and was by 35% lower (12.6 ± 0.38 g.L⁻¹). Protein content difference between "zero samples" of respective extracts with WMIC and DW before the experiment did not exceed 0.1 g.L⁻¹.

It revealed a high content of amino acids in the extract of the lymph nodes based on WMIC. All extracts showed a significant amount of neurotransmitter amino acids such as aspartic and glutamic acid, glycine (thymus – 10.5; 13.7; 7.6%; spleen – 12.2; 10.7; 7.8%; lymph nodes – 11.0; 13.3; 11.1%, respectively) having the immunological and adaptogenic activity. Thus, it was detected high content of arginine and lysine residues involved in the normalization of the immune response; tyrosine and threonine adaptogenic mechanisms involved in stress leveling and depressive reaction; serine, alanine, valine involved in the

Table 1 Protein content in extracts, (g.L⁻¹ ±SD).

Time, min	Spleen		Thymus		Lymph Nodes	
	WMIC	DW	WMIC	DW	WMIC	DW
0	3.77 ±0.23	3.75 ±0.30	4.44 ±0.27	4.46 ±0.26	6.69 ±0.09	6.58 ±0.16
15	22.10 ±0.30	18.00 ±0.41	17.70 ±0.21	10.30 ±0.58	16.00 ±0.73	11.70 ±0.37
30	23.30 ±0.13	18.10 ±0.19	18.90 ±0.15	10.80 ±0.10	18.60 ±0.14	11.90 ±0.12
45	24.40 ±0.41	19.50 ±0.43	18.10 ±0.32	11.70 ±0.25	19.10 ±0.67	12.60 ±0.38
60	23.80 ±0.58	20.30 ±0.43	17.60 ±0.43	11.00 ±0.64	19.00 ±0.56	11.00 ±0.23
75	25.50 ±0.15	20.40 ±0.40	17.50 ±0.70	11.10 ±0.11	19.50 ±0.47	11.70 ±0.80
90	24.00 ±0.63	19.50 ±0.54	17.30 ±0.61	11.00 ±0.76	19.50 ±0.20	11.50 ±0.67
120	24.10 ±0.24	20.10 ±0.17	17.50 ±0.43	11.20 ±0.57	19.40 ±0.16	11.60 ±0.46

formation of active sites of several enzymes and isoleucine, leucine and proline involved in energy metabolism.

It was shown expressed increase of quantitative hydrophilic amino acids content in WMIC extracts in relation to DW extracts: thymus extract – up to 22%, spleen extracts – up to 15%, lymph nodes extract – up to 8%, respectively. This difference in the amino acid content of extracts with different isotopic D/H composition demonstrates positive impact of reduced deuterium content of the solubilizer in the extraction process in an water-salt solution.

The analysis of the protein-peptide profile by 1D electrophoresis revealed qualitative differences between WMIC and DW extracts (Figure 1). The tracks of the thymus extracts (2,5) found qualitative differences in the area of 10 kDa – 3 additional bands observed in the WMIC extract; in the range from 30 to 50 kDa protein contains two new fractions. We can expect that low-molecular weight fraction of thymus extract (WMIC) contain thymosin beta-10, capable of activating wound healing with protective effect (4.9 kDa) (Kim and Jung, 2015); annexin A1 (38.8 kDa), involved in the innate immune response, like glucocorticoids effector and inflammatory processes regulator (Gao, Li and Yan, 1999).

The spleen extracts track (3), based on WMIC solution were detected two additional bands – in area from 12 to 15 kDa; also there were observed appearance of the

peptide pool in the area below 5 kDa. Presumably, the proteins in the 12 – 13 kD are antigen MHC-1 (12.7 kDa) (Koopmann, Albring and Hüter, 2010), beta-2-microglobulin (13.4 kDa), involved in the presentation of peptide antigens in the immune system (Huang W.C., 2008) and C-1 lysozyme (14.7 kD), with antibacterial properties (Kajla et al., 2011).

In lymph nodes extracts (tracks 4,7) were identified differences in area up to 15 kDa – significant intensification of the protein bands in the area of 12 – 100 kDa (WMIC extract), appearance of a protein band in area of 15 – 20 kDa. Probably identified set of bands correspond interleukins: IL-2 (15.2 kDa), interleukin 15 (18.4 kDa), interleukin 6 (21.1 kDa), interleukin 23 subgroups 19 (21.13 kDa), which are directly involved in the immune response (Liao, Lin and Leonard, 2011; DePaolo et al., 2011; Heinrich et al., 2003; Yen et al., 2006).

Proteomic study (2D electrophoresis) revealed in a mixture of extracts based WMIC (thymus, spleen and lymph nodes extracts, 1:1:1) tissue-specific proteins: transferrins, affecting blood formation and plays an important role in the division of cells involved in innate immunity provision; dissociation inhibitor of Rho GTPases, involved in activation process of oxygen superoxide-generating NADPH oxidase of phagocytes; cystatin-B, involved in intracellular proteolysis; aldolase, involved in energy metabolism; glyceraldehyde

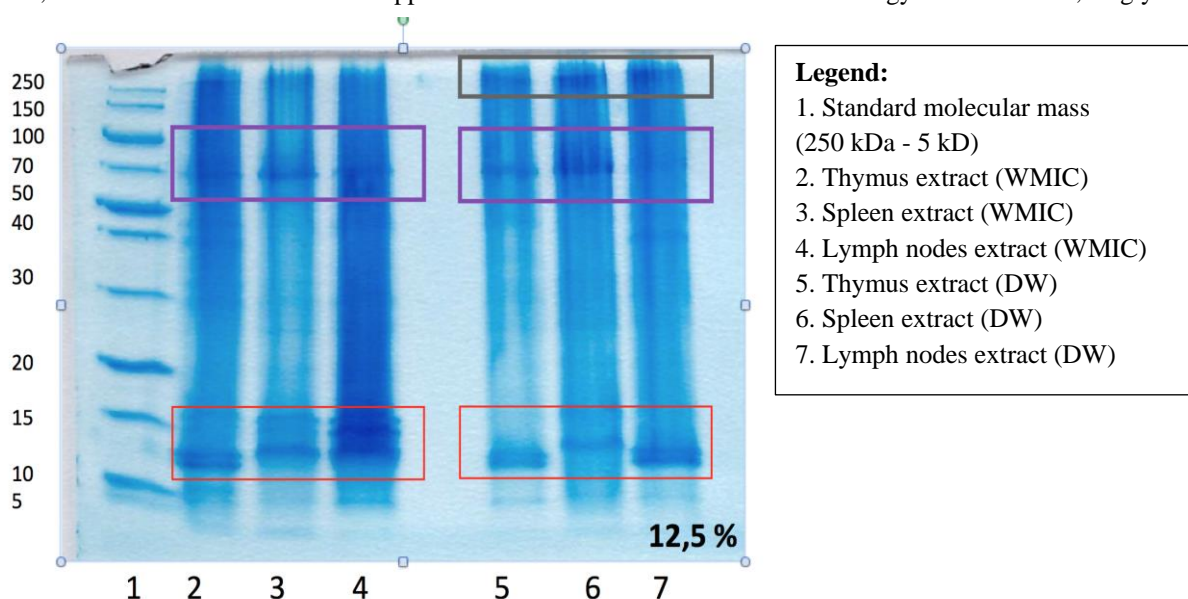

Figure 1 1D electrophoresis of WMIC and DW extracts.

Table 2 The results of mass spectrometric identification (MALDI-TOF/MS and MS/MS) of protein fractions in complex extracts.

Protein name; (Gene symbol)	S / M/ C *	mM/pI** (calculation)
Transferrin (TF)	143/27/39	77.0/6.73
Transferrin (TF)	305/35/53	77.0/6.73
rho GDP-dissociation inhibitor 1 (ARHGDI A) +Acetyl (Protein N-term)	179/14/71	23.4/5.12
rho GDP-dissociation inhibitor 2 (ARHGDI B)	141/5/43	22.8/5.08
Cystatin-B (CSTB) +Acetyl (Protein N-term)	140/9/94	11.1/5.87
Homologue fructose-bisphosphate aldolase A (ALDOA)	299/29/67	39.4/8.45
Glyceraldehyde-3-phosphate dehydrogenase (GAPDH) (2)	108/20/63	35.8/8.51
Malate dehydrogenase, mitochondrial (MDH2)	274/27/66	35.6/8.93
Glutathione S-transferase P (LOC100739163)	193/20/61	23.7/7.66
Phosphoglycerate mutase 1 isoform 1 (PGAM1)	352/30/87	28.8/6.77
Serpin B9 (SERPINB9)	119/13/35	42.5/5.37

Note: *S/M/C – traditional identification indicators adopted in the English literature: Score – indicator of conformity or "scorecard"; Match peptides –the number of matched peptides; Coverage – % coverage of the entire amino acid sequence of the protein by identified peptides.

**mM/pI (calculation) – estimates made based on amino acid sequence data with consideration of signal peptide removal, but with no consideration of other post-synthetic modifications using the ExPASy Compute pI/Mw tool software.

3-phosphate dehydrogenase, involved in activation transcription initiation apoptosis axonal transport processes; malate dehydrogenase catalyzed the last step of Krebs cycle; glutathione S-transferase, one of the most important defenses against toxins; phosphoglycerate mutase B, participated in adaptation processes; serpin B9, controlled a plurality of biological processes, including inflammation and coagulation; as well as several proteins involved in the metabolism (Table 2).

CONCLUSION

Obtained data revealed that water-salt extracts obtained from *Sus scrofa* organs with WMIC as solubilizing agent, can lead to significant quantitative and qualitative changes in the composition of protein-peptide extracts.

WMIC as a solubilizing agent affects the qualitative and quantitative composition of the protein in extracts from 10 to 20 kDa and in the molecular weight range of 30 to 45 kDa. Physico-chemical interactions during the extraction of WMIC don't affect macromolecular compounds, thus it is affected on selection of proteins and peptides that are directly or indirectly involved in the immune response.

Perspective material for further research are protein-peptide fractions obtained with WMIC, characterized by the presence of nonspecific immunity stimulant and adaptogenic immunocorrective action.

REFERENCES

Bondarenko, E. M., Bezborodov, N. V. 2009. Application of a timogena immunomodulator for treatment of newborn calves suffering functional dyspepsia. *Milk and meat cattle*, vol. 2, p. 24-26.

Carlet, J., Ben, A. H. A., Chalfin, A. 2004. Epidemiology and control of antibiotic resistance in the intensive care unit. *Current Opinion in Infectious Disease*, vol. 17, no. 3, p. 231-236.

Chernukha, I. M., Fedulova, L. V., Vasilevskaya, E. R., Ertikeeva, E. A., Ahremko, A. G. 2015. Compounds of antimicrobial activity in the animals mucous membranes

(Soedineniya antimikrobnogo dejstviya v slizistykh obolochkah zhivotnyh). *Vse o myase*, vol. 5, p. 32-35.

DePaolo, R. W., Abadie, V., Tang, F., Fehlner-Peach, H., Hall, J. A. 2011. Co-adjuvant effects of retinoic acid and IL-15 induce inflammatory immunity to dietary antigens. *Nature*, vol. 471, no. 7337, p. 220-224. <https://doi.org/10.1038/nature09849> PMID:21307853

Dzhimak, S. S., Barishev, M. G., Basov, A. A., Timakov, A. A. 2014. Influence of deuterium depleted water on freeze dried tissue isotopic composition and morphofunctional body performance in rats of different generations. *Biophysics*, vol. 59, no. 4, p. 614-619. <https://doi.org/10.1134/S0006350914040101>

Gao, J., Li, Y., Yan, H. 1999. NMR solution structure of domain 1 of human annexin I shows an autonomous folding unit. *The Journal of Biological Chemistry*, vol. 274, no. 5, p. 2971-2977. <https://doi.org/10.1074/jbc.274.5.2971> PMID:9915835

Hawkey, P. M. 1998. The origins and molecular basis of antibiotic resistance. *The BMJ*, vol. 317, p. 657-660. <https://doi.org/10.1136/bmj.317.7159.657> PMID:9727999

Heinrich, P. C., Behrmann, I., Haan, S., Hermanns, H. M., Müller-Newen, G. 2003. Principles of interleukin (IL)-6-type cytokine signalling and its regulation. *The Biochemical Journal*, vol. 374, p. 1-20. <https://doi.org/10.1042/bj20030407> PMID:12773095

Huang, W. C., Havel, J. J., Zhou, H. E., Qian, W. P., Lue, H. W. 2008. β 2-Microglobulin Signaling Blockade Inhibited Androgen Receptor Axis and Caused Apoptosis in Human Prostate Cancer Cells. *Clinical Cancer Research*, vol. 14, no. 17, p. 5341-5347. <https://doi.org/10.1158/1078-0432.CCR-08-0793> PMID:18765525

Kajla, M. K., Shi, L., Li, B., Luckhart, S., Li, J. 2011. New Role for an Old Antimicrobial: Lysozyme c-1 Can Function to Protect Malaria Parasites in Anopheles Mosquitoes. *PLOS ONE*, vol. 6, no. 5, p. e19649. <https://doi.org/10.1371/journal.pone.0019649> PMID:21573077

Khaitov, R. M. 1993. Vaccines Based on Synthetic Polypeptides and Peptides. *Annals of the New York Academy of Sciences. Immunomodulating Drugs*, vol. 685, p. 788-802.

Kim, J., Jung, Y. 2015. Potential role of thymosin Beta 4 in liver fibrosis. *International Journal of Molecular Science*, vol. 16, no. 5, p. 16-21. <https://doi.org/10.3390/ijms160510624> PMID:26006229

Kokryakov, V. N. 1999. *Biology of antibiotics of animal origin*. St. Petersburg, Russia : Nauka. 18-142 p. PMID:10417180

Koopmann, J. O., Albring, J., Hüter, E. 2010. Export of antigenic peptides from the endoplasmic reticulum intersects with retrograde protein translocation through the Sec61p channel. *Immunity*, vol. 13, no. 1, p. 117-127. [https://doi.org/10.1016/S1074-7613\(00\)00013-3](https://doi.org/10.1016/S1074-7613(00)00013-3)

Lebedeva, S. N. Jamsaranova, S. D. 2004. Efficiency of peptide's biocorrector in nutritional regulation secondary immunodeficiency. *Successes contemporary science*, vol. 4, p. 128.

Liao, W., Lin, J. X., Leonard, W. J. 2011. IL-2 family cytokines: new insights into the complex roles of IL-2 as a broad regulator of T helper cell differentiation. *Current Opinion in Immunology*, vol. 23, no. 5, p. 598-604. <https://doi.org/10.1016/j.coi.2011.08.003> PMID:21889323

Matveev, Y. A. 2001. *Development of the process for and study of properties of an immunomodulator of the reindeer thymus* : dissertation theses. Shchyolkovo, Russia. 136 p.

O'Farrell, P. H. 1975. High resolution two-dimensional electrophoresis of proteins. *Journal of Biological Chemistry*, vol. 250, no. 10, p. 4007-4021. PMID:236308

Perron, G. G., Inglis, R. F., Pleuni, S. P., Cobey, S. 2015. Fighting microbial drug resistance: a primer on the role of evolutionary biology in public health. *Evolutionary Applications*, vol. 8, no. 3, p. 211-222. <https://doi.org/10.1111/eva.12254> PMID:25861380

Pozdeev, O. K. 2004. *Medical Microbiology: Textbook*. 2nd ed. Moscow, Russia : GEOTAR-Media, p. 245-310.

Roca, I., Akova, M., Baquero, F., Carlet, J., Cavaleri, M., Coenen, S., Cohen, J., Findlay, D., Gyssens, I., Heuer, O. E., Kahlmeter, G., Kruse, H., Laxminarayan, R., Liébana, E., López-Cerero, L., MacGowan, A., Martins, M., Rodríguez-Baño, J., Rolain, J. M., Segovia, C., Sigauque, B., Tacconelli, E., Wellington, E., Vila, J. 2015. The global threat of antimicrobial resistance: science for intervention. *New*

Microbes and New Infections, vol. 6, 26-29. <https://doi.org/10.1016/j.nmni.2015.02.007> PMID:26029375

Sokolov, A. Y. 2015. Novye tendencii v racionalnom ispolzovanii syrya zhivotnogo proiskhozhdeniya. *Myasnye tekhnologii*, vol. 7, no. 151, p. 6-10.

Vasilevskaya, E. R., Fedulova, L. V. 2015. Animal raw materials as a source of natural regulators of immunity. *Actual Biotechnology*, vol. 3, p. 97-99.

Vladimirov, L. N. 2001. *Development of technology for the production of biologically active compounds from reindeer endocrine glands*: tutorial. Yakutsk, Russia. 106 p.

Yen, D., Cheung, J., Scheerens, H., Poulet, F., McClanahan, T. 2006. IL-23 is essential for T cell-mediated colitis and promotes inflammation via IL-17 and IL-6. *Journal of Clinical Investigation*, vol. 116, no. 5, p. 1310-1316. <https://doi.org/10.1172/JCI21404> PMID:16670770

Acknowledgments:

This work was supported by grant Russian Science Foundation (RSF) No. 15-16-00008.

Contact address:

Irina Mikhailovna Chernukha, The V. M. Gorbatov All-Russian Meat Research Institute, Experimental-clinical research laboratory of bioactive substances of animal origin, Talalikhina st. 26, 109316 Moscow Russia, E-mail:imcher@inbox.ru

Liliya Viacheslavovna Fedulova, The V. M. Gorbatov All-Russian Meat Research Institute, Experimental-clinical research laboratory of bioactive substances of animal origin, Talalikhina st. 26, 109316 Moscow Russia, E-mail:fedulova@vniimp.ru

Ekaterina Romanovna Vasilevskaya, The V. M. Gorbatov All-Russian Meat Research Institute, Experimental-clinical research laboratory of bioactive substances of animal origin, Talalikhina st. 26, 109316 Moscow Russia, E-mail:Rina715@yandex.ru

Elena Alexandrovna Kotenkova, The V. M. Gorbatov All-Russian Meat Research Institute, Experimental-clinical research laboratory of bioactive substances of animal origin, 109316, Talalikhina st. 26, Moscow, Russia, E-mail:lazovlena@yandex.ru



POTENTIAL OF *LACTOBACILLUS PLANTARUM* CCM 3627 AND *LACTOBACILLUS BREVIS* CCM 1815 FOR FERMENTATION OF CEREAL SUBSTRATES

Kvetoslava Romanová, Dana Urminská

ABSTRACT

Lactobacillus is the most representative strain in a group of lactic acid bacteria, which perform an essential role in the preservation and production of wholesome foods. Lactic acid fermentation is the oldest traditional method for preparation of fermented vegetables, meat products, dairy products and cereal foods. Cereal grains are considered to be one of the most important sources of dietary proteins, carbohydrates, vitamins, minerals and fibre for people. The main exploitation of cereals is to prepare sourdough, which is a mixture of wheat, rye or other cereal flour with water and contains yeasts and lactobacilli. The basic biochemical changes that occur in sourdough bread fermentation are acidification of the dough with organic acids produced by the lactobacilli and leavening with carbon dioxide produced by the yeast and the lactobacilli. Acidification perhaps initiate enzymatic processes of proteins and phytates degradation. Lactobacilli produce various enzymes which make flavour precursors, improve of mineral bioavailability or degrade celiac active peptides, because some species of lactobacilli produce specific peptidases during growth, which are capable to hydrolyze hardly cleavable, celiac-active proline-rich peptides. Microbial fermentation with selected strains of lactobacilli may be new alternative approach for modification of gluten by hydrolysis. In this paper are described growth characteristics and intracellular aminopeptidases activities of *Lactobacillus plantarum* CCM 3627 and *Lactobacillus brevis* CCM 1815. Work was focused on characterization of the lactobacilli for potential usage as a starter culture in further fermentation experiments.

Keywords: sourdough fermentation; *Lactobacillus*; growth; acidification; proteolysis

INTRODUCTION

Cereals are source of saccharides, dietary fibre, proteins, mineral elements and vitamins required for human health. Cereal goods also contain antinutrients such as phytic acid and are poor in essential amino acid content (Kocková and Valík, 2011). Microbial fermentation has been reported as a tool which can improve mineral availability of cereal goods by reduction of phytate, enhancing the flavour by microbial production of organic acids and releasing of essential amino acids by proteolysis (Kohajdová and Karovičová, 2007). In addition, nutritional features of cereals can be modified by proteolysis by sourdough microflora, which may lead to decreasing of amounts of celiac-active peptides (Nionelli and Rizzello, 2016).

Celiac disease is a chronic inflammatory disorder triggered by ingestion of gluten proteins and similar proteins from rye and barley, in genetically susceptible individuals (Gobbetti et al., 2014). Gluten proteins are consist of prolamins – gliadins and glutenins. Prolamins are proline-rich molecules with compact structure, difficult

to hydrolyze. Prolamins of wheat are also known as gliadins, secalins are prolamins of rye and hordeins are barley prolamins fraction. From technological point of view, gluten proteins are irreplaceable, because they are responsible for viscosity and elasticity of dough and gas retention during fermentation process (Osella et al., 2014).

Rollán et al. (2010) describe sourdough fermentation as one of the oldest traditional biotechnological process of bread-making. Sourdough is the mixture of flour and water, spontaneously fermented by presented metabolically active microflora. Microorganisms naturally associated with sourdough are yeasts and lactic acid bacteria at a ratio of 1:100. Gereková et al. (2011) characterize lactic acid bacteria as group of functionally and genetically related bacteria, belonging to the genera *Leuconostoc*, *Lactococcus*, *Pediococcus*, *Lactobacillus*, *Weissella*, *Tetragenococcus*, etc. *Lactobacillus* genus is frequently observed and prevalent strain in sourdough. Lactobacilli are Gram-positive, non-spore-forming, rod-shaped and non-motile bacteria. According to the hexose metabolism, they may be divided into two groups. First group is

homofermentative lactobacilli utilizing glucose via the Embden-Meyerhof pathway. They produce more than 85% of lactic acid as the main product. Heterofermentative lactobacilli metabolise hexoses via the phosphoketolase pathway and produce only 50% of lactic acid. They produce also acetic acid, formic acid, ethanol, carbon dioxide and aldehydes. Strains of lactobacilli which ferment glucose via heterofermentative pathway are adapted to live in microaerophilic conditions (**De Vuyst and Neysens, 2005; De Vuyst and Vancanneyt, 2007**).

Microbial acidification is crucial for activation of enzymes, which may improve nutritional properties of fermented cereal food. Phytases and endogenous cereal proteases are activated under acid conditions. Wheat and rye flour contain ca. 1% of phytate, which bind cations of calcium, iron or magnesium. These complexes are not accessible for hydrolysis above pH 5.0 and bioavailability of presented essential microelements is reduced. Cereal phytases are active in the pH value range from 3.5 to 5.0. (**Gänzle, 2014**). In the same way, acidic conditions play key role for initiation of proteolysis during fermentation process. Lactic acid bacteria shift pH value under 4.0 and activated endogenous cereal proteinases, which promote degradation of protein molecules into the various sized peptides. Peptides are transported across the bacterial cell membrane into the cytoplasm. There are presented various intracellular peptidases, which complete the proteolysis and liberate free amino acids (**Gobbetti et al., 2014**). Most lactic acid bacteria associated with sourdough do not produce extracellular peptidases (**Moroni et al., 2009**). Lactobacilli produce also proline specific peptidases and their activities vary at strain levels. Increased levels of amino acids was observed after cereal fermentation. The composition of lactic acid microflora of dough strongly affect on the concentration of amino acids in dough after fermentation process. Selected strains of bacteria using as a starter culture for cereal fermentation may be new biotechnological tool for producing gluten-low wheat and rye products (**Gänzle et al., 2008**).

In the last decades, potential of sourdough lactic acid bacteria as „cell factory“ of proteolytic enzymes was investigated. **Di Cagno et al. (2002)** and **Di Cagno et al. (2004)** reported producing a sourdough bread that is tolerated by celiac sprue patients. Their studies showed the ability of selected sourdough lactobacilli to hydrolyze of wheat prolamins effectively and extensively. **Rizzello et al. (2007)** described successful study of sourdough bread preparation using selected lactobacilli and fungal proteases.

The Codex Alimentarius claims that "gluten-free" label may also be used for products containing no more than 20 ppm of gluten proteins. Products with no more than 100 ppm of gluten can be labeled as "gluten-low" (**Walter et al., 2014**).

The aim of this study was to evaluate growth of *L. plantarum* CCM 3627 and *L. brevis* CCM 1815, characterized by increase of optical density of cells in cultivation medium in time, increase of dry cell weight and change in pH value of cultivation medium. Aminopeptidases activities were determined from crude enzyme extracts per volume of solution in $\mu\text{kat}\cdot\text{dm}^{-3}$.

MATERIAL AND METHODOLOGY

Bacterial strains and growth conditions

Growth characteristics of *Lactobacillus plantarum* CCM 3627 and *Lactobacillus brevis* CCM 1815 were investigated. Pure lyophilized cultures of both lactobacilli strains were obtained from Czech Collection of Microorganisms (Brno, Czech Republic). Lactobacilli were grown in de Man, Rogosa, Shrape medium (MRS medium) M369 (HiMedia, India) containing pepton 10 $\text{g}\cdot\text{dm}^{-3}$, beef extract 10 $\text{g}\cdot\text{dm}^{-3}$, yeast extract 5 $\text{g}\cdot\text{dm}^{-3}$, dextrose 20 $\text{g}\cdot\text{dm}^{-3}$, polysorbate 80 (Tween 80) 1 $\text{g}\cdot\text{dm}^{-3}$, ammonium citrate 2 $\text{g}\cdot\text{dm}^{-3}$, sodium acetate, 5 $\text{g}\cdot\text{dm}^{-3}$, magnesium sulphate 0.1 $\text{g}\cdot\text{dm}^{-3}$, manganese sulphate 0.05 $\text{g}\cdot\text{dm}^{-3}$ and dipotassium phosphate 2 $\text{g}\cdot\text{dm}^{-3}$.

Growth characteristics was determined from samples of lactobacilli cultivated in MRS medium at 37 °C during 40 hours, which was carried out with constant stirring (100 rpm). Initial optical density ($\lambda = 600$ nm) of lactobacilli in broth was 0.4 and inoculum was prepared by propagation of cells in MRS broth for 24 hours at 37°C.

Characterization of growth

For analysis, samples were taken every 4 hours and growth was studied by measuring optical density (OD) at $\lambda = 600$ nm photometrically (Genesys 10S UV-VIS Spectrophotometer, ThermoScientific), dry cell weight ($\text{g}\cdot\text{dm}^{-3}$) gravimetrically after drying of biomass to constant weight and by measuring of pH value of medium. Measured values of OD₆₀₀, dry cell weight and pH of medium were plotted on curves.

Aminopeptidase assays

To assay the cytoplasm aminopeptidase activities, cultures of both strain from the late exponential phase of growth were used. Cells were harvested by centrifugation at 9 000 x g per 10 minutes at 4 °C (Avanti® J-30I, Beckman Coulter, USA), washed with 0.1 M sterile Sorenson's phosphate buffer (pH 7.0) and resuspended in the same sterile buffer. Cytoplasmic extracts were prepared by ultrasonic disintegration of cells (Bandelin Sonopuls HD 3200, Germany). Smashed cells was centrifuged at 14 000 x g per 10 minutes at 4 °C to remove unbroken bacteria and large cellular debris. The supernatant represented crude cell-free extracts.

For determination of specific aminopeptidase activity were used substrates based on *p*-nitroanilides (*p*-Na): Phe-*p*Na, Ala-*p*Na, Leu-*p*Na, Met-*p*Na, Pro-*p*Na and Lys-*p*Na (Sigma, Germany; Serva, Germany). Activities of enzymes were determined by the method of **El Soda and Desmazeaud (1982)** based on measuring of absorbance of released *p*-nitroaniline at 410 nm. The concentration of *p*-nitroaniline was calculated by Lambert-Beer law. Results were expressed in units of activity per volume of solution ($\mu\text{kat}\cdot\text{dm}^{-3}$).

RESULTS AND DISCUSSION

The growth of lactobacilli was studied by measuring optical density (OD) at $\lambda = 600$ nm, dry cell weight and pH value of MRS medium during cultivation in time. First of all, optical density of cell in MRS medium was measured photometrically.

Growth curve is crucial for further fermentation experiments because it shows growth phases. In industrial production are bacterial cells commonly harvested during the late exponential or stationary growth phase to ensure high cell numbers (Laakso et al., 2011).

Figure 1 shows growth curve of *L. plantarum* cells, where optical density was measured every 4 hours. The end of exponential phase was noticed between 24. – 28. hours of cultivation in MRS medium. Growth curve of *L. brevis* (Figure 2) shows different result, the late exponential phase was reached after 28. – 32. hours of cultivation.

The stationary phase of growth started after 28. hours of *L. plantarum* cultivation and 32. hours of *L. brevis* cultivation in MRS broth, respectively. This study describe bacterial growth phases in batch system of cultivation, where initial amount of nutrients in a MRS medium was

limiting factor for the growth of lactobacilli. In the early stationary phase was observed growth retardation and stopping of cell growth. Reason is described in study by Cohen et al. (2006). During growth, levels of glucose in medium are decreasing. Lack of glucose provoked induction of alternative pathways to obtain energy by carbohydrate metabolism. The energy required for induction of alternative pathways may be the reason for reducing of growth rate in late exponential and early-stationary phases.

Dry cell weight of lactobacilli was measured gravimetrically and correspond with the highest optical density of cells in MRS medium. The highest amount of dry cell weight of *L. plantarum* CCM 3627 was reached between 24. to 28. hours of growth and reached $0.62 \text{ g}\cdot\text{dm}^{-3}$ of MRS broth (Figure 3). The final cell yield of *L. brevis* was lower, reaching a cell concentration of 0.45 g of dry

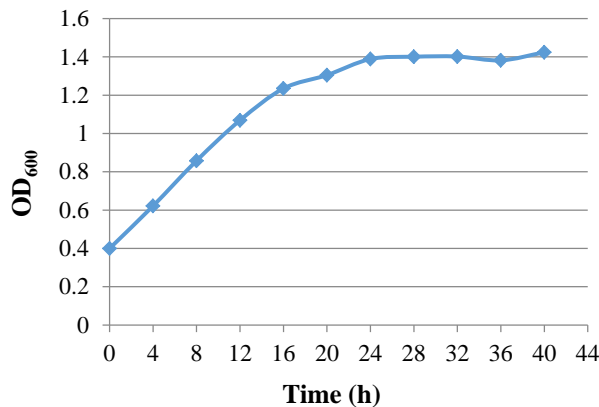

Figure 1 Growth curve of *L. plantarum* CCM 3627 during cultivation in time.

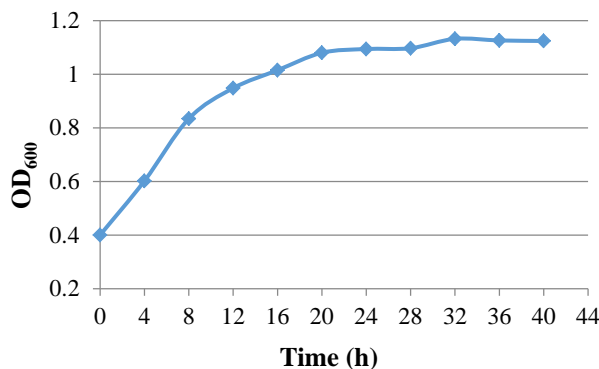

Figure 2 Growth curve of *L. brevis* CCM 1815 during cultivation in time.

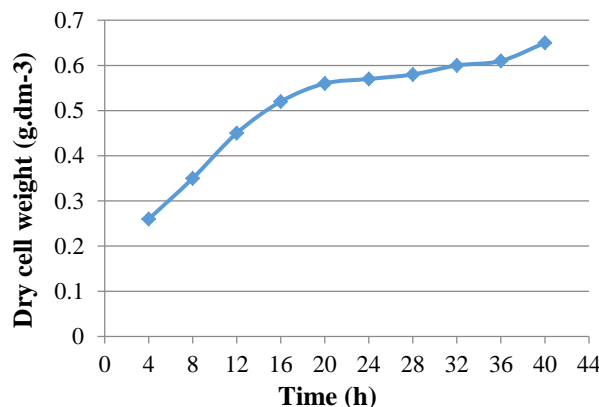

Figure 3 Increase of dry cell weight of *L. plantarum* CCM 3627 during cultivation in time.

biomass for 1 dm³ MRS media.

One of the important technological characteristics in of lactobacilli is ability to produce organic acids and acidification of an extracellular environment. Therefore, lactobacilli are acid tolerant. Ability of acidification is important for fermentation process of cereal substrates, because low pH value of dough activate cereal proteolytic enzymes and start proteolysis of cereal proteins. Acidification also may be protection against contaminating microorganisms (Rollán et al., 2010).

Measuring the pH values of the medium during cultivation showed that lactobacilli had very active carbohydrate metabolism. Significant changes of pH was observed in the first of 24 hours of cultivation time. It was produced such amount of organic acids, which decrease pH to less than 5.0 in both cases. Initial pH value of MRS

medium was 6.5 and it was acidified by *Lactobacillus plantarum* to pH value less than 4.6 in the late exponential phase (Figure 5). *Lactobacillus brevis* acidify extracellular environment in exponential phase of growth to pH 5.0 (Figure 6). This is very important information for further experiments, because investigated lactobacilli have considerable potential for successful acidification of dough, which initiate proteolysis of cereal proteins.

Mechanisms of acid resistance of fermentative microorganisms are provided by the glutamate decarboxylase system, alkalization of the external environment, homeostasis of intracellular pH, DNA and protein damage repair and changes in cell membrane. Lactobacilli are acid tolerant by production of acid shock proteins and changes in intracellular and surface-located proteins. Acid stress also induces changes in the fatty acid

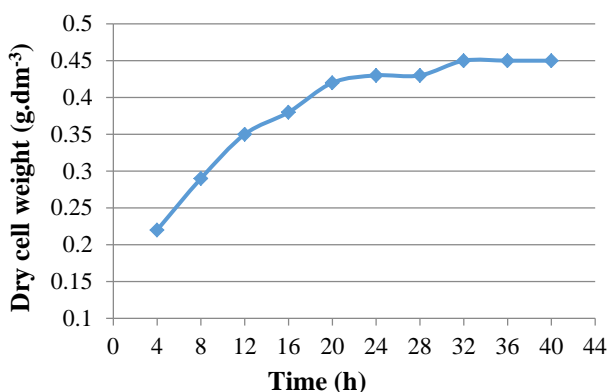

Figure 4 Increase of dry cell weight of *L. brevis* CCM 1815 during cultivation in time.

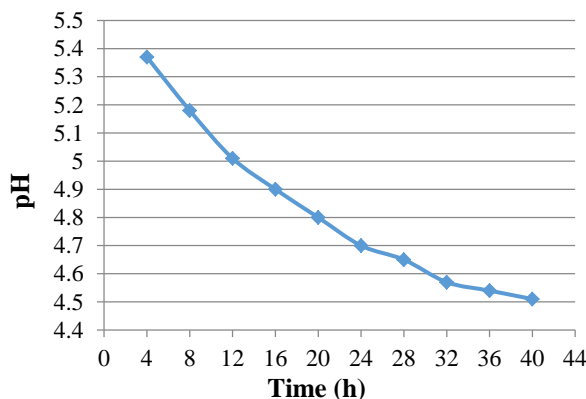

Figure 5 pH change of the MRS medium during growth of *L. plantarum* CCM 3627 in time.

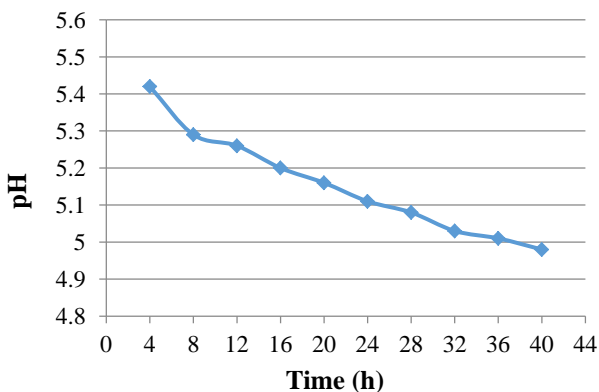

Figure 6 pH change of the MRS medium during growth of *L. brevis* CCM 1815 in time.

contents of the cytoplasmic membrane (Hussain et al., 2013).

Laakso et al. (2011) introduced that the abundance of several stress proteins and the transcription of genes encoding stress responsive proteins was elevated when the cells reach the stationary growth phase. Hussain et al. (2013) added that lactobacilli are robust in their adaptive and physiological responses under different conditions. They are adaptable because of production of the transient induction proteins and physiological changes. Their effective adaptation mechanisms enhancing the ability survive under adverse conditions. Proteins activate different metabolic pathways in stress conditions and protein profile of lactobacilli are subjected to changes.

In an experiment, the crude cell-free enzymatic extracts of both strains of *Lactobacillus* were assayed by synthetic substrates: Phe-pNa, Ala-pNa, Leu-pNa, Met-pNa, Lys-pNa and Pro-pNa. Table 1 summarizes the results obtained after hydrolytic reactions. Results were similar in both cases and were expressed in units of activity per volume of solution ($\mu\text{kat}\cdot\text{dm}^{-3}$). *L. plantarum* CCM 3627 possessed the highest activity of lysin-specific peptidase ($731 \mu\text{kat}\cdot\text{dm}^{-3}$), while proline-specific peptidase showed the lowest activity ($69 \mu\text{kat}\cdot\text{dm}^{-3}$). Peptidase complex of *L. brevis* CCM 1815 reached similar values. Lysine-specific aminopeptidase reached the highest activity ($410 \mu\text{kat}\cdot\text{dm}^{-3}$). In contrast, proline aminopeptidase activity was quite low ($12 \mu\text{kat}\cdot\text{dm}^{-3}$). From the point of view to produce fermented bread with hydrolysed celiac-active peptides the essential finding was presence of active proline-specific peptidase, which is prerequisite for successful cleavage of peptide bonds with proline from celiac-active hardly cleavable peptides.

CONCLUSION

Lactobacillus plantarum CCM 3627 and *Lactobacillus brevis* CCM 1815 produce organic acids, as well as specific intracellular aminopeptidases during cultivation in MRS medium. Results confirm production of active proline aminopeptidase, which is important for cleavage of proline rich-peptides. Through ability acidify of environment to pH value to less than 5.0, cereal phytases and endogenous cereal proteases may be activated during dough fermentation. These enzymatic processes can result in improvement mineral bioavailability and degradation of proteins into the peptides. Investigated *Lactobacillus* strains have real potential for exploitation in production of gluten-low products. Sourdough fermentation with addition of selected lactobacilli may be an alternative technology for degradation of celiac-active cereal proline-rich peptides and improvement of nutritional properties of cereal products.

REFERENCES

Codex Standart 118-1979: 2008. *Standard for foods for special dietary use for persons intolerant to gluten*.
Cohen, D., Renes, J., Bouwman, F., Zoetendal, E., Mariman, E., De Wos, W., Vaughan, E. 2006. Proteomic analysis of log to stationary growth phase *Lactobacillus plantarum* cells and a 2-DE database. *Proteomics*, vol. 6, no. 24, p. 1-8. <https://doi.org/10.1002/pmic.200600361> PMID:17115453

Di Cagno, R., De Angelis, M., Auricchio, S., Greco, L., Clarke, Ch., De Vincenzi, M., Giovanni, C., D'Archivio, M., Landolfo, F., Parrilli, G., Minervini, F., Arendt, E., Gobbetti, M. 2004. Sourdough Bread Made from Wheat and Nontoxic Flours and Started with Selected Lactobacilli Is Tolerated in Celiac Sprue Patients. *Applied and Environmental Microbiology*, vol. 70, no. 2, p. 1088-1090. <https://doi.org/10.1128/AEM.70.2.1088-1096.2004> PMID:14766592

Di Cagno, R., De Angelis, M., Lavermicocca, P., De Vincenzi, M., Giovanni, C., Faccia, M., Gobbetti, M. 2002. Proteolysis by Sourdough Lactic Acid Bacteria: Effects on Wheat Flour Protein Fractions and Gliadin Peptides Involved in Human Cereal Intolerance. *Applied and Environmental Microbiology*, vol. 68, no. 2, p. 623-624. <https://doi.org/10.1128/AEM.68.2.623-633.2002> PMID:11823200

El Soda, M., Desmazeaud, M. 1982. Les peptide-hydrolases des lactobacilles du groupe *Thermobacterium*. I. Mise en évidence de ces activités chez *Lactobacillus helveticus*, *L. acidophilus*, *L. lactis* et *L. bulgaricus*. *Canadian Journal of Microbiology*, vol. 28, no. 10, p. 1181-1184. <https://doi.org/10.1139/m82-174> PMID:6817904

Gobbetti, M., Rizzello, C. G., Di Cagno, R., De Angelis, M. 2014. How the sourdough may affect the functional features of leavened baked goods. *Food Microbiology*, vol. 37, p. 30-38. <https://doi.org/10.1016/j.fm.2013.04.012> PMID:24230470

Gänzle, M., Loponen, J., Gobbetti, M. 2008. Proteolysis in sourdough fermentations: mechanisms and potential for improved bread quality. *Trends in Food Science and Technology*, vol. 19, no. 10, p. 513-521. <https://doi.org/10.1016/j.tifs.2008.04.002>

Gänzle, M. 2014. Enzymatic and bacterial conversions during sourdough fermentation. *Food Microbiology*, vol. 37, p. 1-10. <https://doi.org/10.1016/j.fm.2013.04.007> PMID:24230468

Gereková, P., Petruľáková, Z., Šturdík, E. 2011. Importance of lactobacilli for bread-making industry. *Acta Chimica Slovaca*, vol. 4, no. 2, p. 119-123.

Hussain, M., Nezhad, M., Sheng, Y., Amofo, O. 2013. Proteomics and the stressful life of lactobacilli. *FEMS Microbiology letters*, vol. 349, no. 1, p. 1-4. <https://doi.org/10.1111/1574-6968.12274>

Kocková, M. and Valík, E. 2011. Potential of cereals and pseudocereals for lactic acid fermentations. *Potravinárstvo*, vol. 5, no. 2, p. 27-28. <https://doi.org/10.5219/127>

Kohajdová, Z., Karovičová, J. 2007. Fermentation of cereals for specific purpose. *Journal of Food and Nutrition Research*, vol. 46, no. 2, p. 51-55.

Laakso, K., Koskeniemi, K., Koponen, J., Kankainen, M., Surakka, A., Salusjärvi, T., Auvinen, P., Savijoki, K., Nyaman, T., Kalkkinen, N., Tynkkynen, S., Varmanen, P. 2011. Growth phase-associated changes in the proteome and transcriptome of *Lactobacillus rhamnosus* GG in industrial-type whey medium. *Microbial Biotechnology*, vol. 4, no. 6, p. 746-756. <https://doi.org/10.1111/j.1751-7915.2011.00275.x> PMID:21883975

Moroni, V., Dal Bello, F., Arendt, E. 2009. Sourdough in gluten-free bread making: An ancient technology to solve a novel issue? *Food Microbiology*, vol. 26, no. 7, p. 676-684. <https://doi.org/10.1016/j.fm.2009.07.001> PMID:19747600

Nionelli, L., Rizzello, C. G. 2016. Sourdough-Based Biotechnologies for the Production of Gluten-Free Foods.

Foods, vol. 5, no. 3, p. 1-7.

<https://doi.org/10.3390/foods5030065>

Osella, C., De la Torre, M., Sánchez, H. 2014. Safe Foods for Celiac People. *Food and Nutrition Sciences*, vol. 5, no. 9, p. 787-800. <https://doi.org/10.4236/fns.2014.59089>

Rizzello, C., De Angelis, M., Di Cagno, R. 2007. Highly efficient gluten degradation by lactobacilli and fungal proteases during food processing: new perspectives for celiac disease. *Applied and Environmental Microbiology*, vol. 73, no. 14, p. 4499-4506. <https://doi.org/10.1128/AEM.00260-07>
[PMid:17513580](https://pubmed.ncbi.nlm.nih.gov/17513580/)

Rollán, G., Gerez, C. L., Dallagnol, I. M., Torino, M. I., Font, G. 2010. Update in bread fermentation by lactic acid bacteria. *Applied Microbiology and Microbial Biotechnology*, p. 1168-1171.

Walter, T., Wieser, H., Koehler, P. 2014. Production of gluten-free wheat starch by peptidase treatment. *Journal of*

Cereal Science, vol. 60, no. 1, p. 202-203.

<https://doi.org/10.1016/j.jcs.2014.02.012>

Acknowledgments:

This work was supported by project KEGA 020SPU-4/2016. This work was supported by project ITMS 26220120054.

Contact address:

Kvetoslava Romanová, Slovak University of Agriculture, Faculty of Biotechnology and Food Sciences, Department of Biochemistry and Biotechnology, Tr. A. Hlinku 2, 949 76 Nitra Slovakia, E-mail: xkacmarova@uniag.sk

Dana Urminská, Slovak University of Agriculture, Faculty of Biotechnology and Food Sciences, Department of Biochemistry and Biotechnology, Tr. A. Hlinku 2, 949 76 Nitra Slovakia, E-mail: dana.urminska@uniag.sk



A COMPARATIVE STUDY OF THE PHYSICOCHEMICAL PROPERTIES AND ANTIMICROBIAL QUALITIES OF ABUAD MORINGA SOAP WITH CONVENTIONAL MEDICATED SOAPS

Pius Abimbola Okiki, Abiodun Ayodele Ojo, Hadiza Onyibe, Olawale Oso, Basiru Olaitan Ajiboye

ABSTRACT

The study was aimed at assessing the physicochemical properties and antimicrobial qualities of 'ABUAD moringa soap', a herbal soap produced with *Moringa oleifera* leaf by 'ABUAD Farm', Afe Babalola University, Ado Ekiti, Nigeria. The physicochemical properties and antimicrobial qualities of ABUAD moringa soap on some selected bacteria and fungi were evaluated and compared with those of some conventional medicated and herbal soaps commonly used in Nigeria, such as Dettol, Tetmosol, Tura, Septol, Delta and Dudu Osun (herbal), as well as Lux, which serves as a control soap. The results of the physicochemical analyses revealed that all the soaps fall within the pH range of 8.83 and 9.83. All the soaps possess low values of free caustic alkali and detectable free fatty acid, as well as moderate values of total fatty matter. *In-vitro* antibacterial and antifungal activities of the soaps were investigated against microbial agents commonly found in association with skin infections, using the well-agar diffusion technique. The bacteria tested were *Staphylococcus aureus* ATCC 25923 and *Proteus mirabilis* (ATCC 12453), as well as four clinical isolates namely, *Escherichia coli*, *Leutococcus sanguinis*, *Corynebacterium accolens* and *Burkholderia cepacia*. The fungi were *Candida albicans* ATCC 10231, *Malassezia furfur* ATCC 44349, and *Cryptococcus neoformans* ATCC 23645. All the soaps, with exception of lux, produced varied degrees of antibacterial activities, but ABUAD Moringa soap and Dudu Osun indicated superior effectiveness against the bacteria tested. Antifungal activities were produced by ABUAD moringa and Dudu Osun soaps only, on the fungi tested. ABUAD Moringa produced significantly higher antifungal activities on *Malassezia furfur* ATCC 44349 and *Candida albicans* ATCC 10231 than Dudu Osun, but no significant difference was observed between the two soaps on their activities against *Cryptococcus neoformans* ATCC 23645. The study showed that ABUAD Moringa soap possesses high therapeutic potentials against agents of bacterial and fungal skin infections.

Keywords: antibacterial; antifungal; moringa soap; skin infections

INTRODUCTION

The skin is an important organ of the body that serves as an agent of protection against infection by microorganisms and shields delicate underlying tissue from injury, most of the microflora found on the human skin are harmless and some are beneficial. The normal flora also serves as a defence against invading microorganisms, and therefore should not be adversely eliminated. However, it should be noted that every organism is a potential pathogen, because microorganisms may cause infections particularly if the skin is broken, causing skin diseases and could enter the blood system creating life-threatening diseases particularly in immunosuppressed people (Alam et al., 1989; Cogen et al. 2008; Callewat et al., 2013). Some of the normal microfloras of the skin include *Staphylococcus aureus*, *Candida albicans*, *Malassezia furfur* etc. (Speers et al., 1965).

The use of soaps plays a significant role in human's skin hygiene and as a consequence promotes health. Interestingly, soaps commonly called medicinal soaps are known to possess antimicrobial properties which make them useful for the treatment of various skin condition caused by microorganism while the regular soaps are used to wash of dirt.

Soap is a cleaning or emulsifying agent made by reacting animal or vegetable fats or oils with potassium or sodium hydroxide. Soap often contains colouring matter and acts by emulsifying grease and lowering the surface tension of water so that it readily penetrates to remove dirt. Medicated soaps contain additional ingredients, usually for the treatment of skin disorders. Bathing with soap and water has been considered a measure of personal hygiene (Eckburg et al., 2005).

Some common medicated soaps with their active ingredients are: Tura (Triclosan, Allantoin, Vitamin E, Tallowate, Sodium palmkernelate, Aqua, Parfum, C112940 (pigment Red), C177266 (carbon Black), C174160 (pigment Blue 15); Tetmosol (Soap base, Monosulfiran, B.P 5% and Citronella oil), Septol (Soap base, colour (yellow) Fragrance, water, Iragasan Dp300 (0.3%), EDTA (0.15%), Vitamin E (0.20%); Dettol (Soap base, Fragrance, Colour, Antibacterial deodorant, Chloroxylerol (0.3%); Delta (Sodium palmitate, Sodium palmkernelate, Stabiliers, Tricholorocarbaniide, Parfum, Colourant C.1.77891 (Eckburg et al., 2005).

Herbal soaps are soaps made with plants and natural ingredient that have medicinal value used to promote healthy skin (Soap History, 2014). Example of herbal soap include Dudu Osun (Pure honey Shea butter, Palm kernel oil Cocoa Pod ash, Lime juice, Aloe vera, Palm bunch ash, sulphur, Water and Fragrance.

Regular soap is designed to decrease water's surface tension and to lift dirt and oils off the surfaces so that it can be easily rinsed away. Though regular soap does not contain added antibacterial chemicals, it is effective in getting rid of bacteria and other germs (Lalan, 2010). An example of a regular or toilet soaps include Lux (Sodium Tallowate, Sodium Palmate, Aqua, Sodium Palm Kernate, Glycerin, Parfum, Sodium Sulphate, Titanium Dioxide, Phosphoric acid, Tetrasodium EDTA, Disulfonate, Hexyl Cinnamal, Benzyl Salicylate, Butylphenyl, Methylpropional, Citronellol, Gerniol, Coumarin, Limoene, Cl 74160).

The physicochemical properties of soaps determine their quality and cleansing efficacy. Such physicochemical characteristics include pH, total fatty matter, free caustic alkali, moisture content, and free fatty acid among others. The qualities of alkali and oil used as well achieving complete saponification also have significant contribution to soap quality (Viorica et al., 2011; Vivian et al., 2014).

This study was aimed at investigating the physicochemical and antimicrobial qualities of ABUAD Moringa Soap® (ABUAD farm, Teaching and Research Farm of Afe Babalola University, Ado -Ekiti, Nigeria) and comparing these qualities with those of conventional medicated soaps that are in high demand in Nigerian market, namely, Dettol, Delta, Tura, Septol, and Tetmosol soaps.

MATERIAL AND METHODOLOGY

Collection of samples

ABUAD moringa soap was obtained from ABUAD soap factory, Afe Babalola University, Ado Ekiti, Nigeria. ABUAD moringa soap (Plate 1) is a herbal soap (soap base, palm kernel oil, coconut oil and leaf extract of *Moringa oleifera* Lam as major constituents) is produced and marketed by ABUAD farm, the Teaching and Research Farm of Afe Babalola University, Ado Ekiti, Nigeria. DuduOsun (herbal soap), five medicated soaps namely, Delta, Tura, Tetmosol, Septol and Dettol, as well as Lux (a regular soap) were purchased from Oba market in Ado Ekiti. All the soaps were analysed in the Science laboratories of Afe Babalola University for their physicochemical and antimicrobial qualities.

Physicochemical analysis

The physicochemical analyses of the soaps, namely determinations of pH, total fatty matter, free caustic alkali and free fatty acid, were carried out as described by AOAC (2010)

Determination of pH

A 10% aqueous solution of each soap was prepared and used for pH determination using Hanna Instrument pH Meter (HI 2210), that was previously calibrated with buffer solutions 7 and 10.

Determination of Total Fatty Matter test

A quantity of 5 grams of soap was weighed into 250 mL conical flask and 100 mL of distilled water was added, warmed completely until the soap dissolved. A few drops of methyl orange were added, then dilute H₂SO₄ was added until the solution turn acidic and 5 mL of H₂SO₄ was added in excess. With a small funnel placed unto the flask, the soap solution was heated to a temperature not exceeding 60 °C until the fatty acids separated as a clear layer. A volume of 50 mL saturated sodium chloride was added to the solution and was allowed to cool before quantitatively transferring into a separating funnel and the aqueous layer carefully separated. The separated aqueous layer was washed with three portions of 50 mL of ethyl ether. The ether extract was combined with the fatty acid in the first separating funnel. The fatty acid/ether solution was washed with 3 × 10 mL of water portion. The water portion used for washing was shaken with 20 mL ether and the ether portion was added to fatty acid/ether solution. The ether portions was collected into a weighed beaker and evaporated on a steam bath. After evaporation of the ether, the beaker was placed in the oven at a temperature of 90 °C for 10 minutes. It was then removed from oven and cooled in the desiccators and weighed. The fatty matter residue was weighed and calculated.

Determination of free caustic alkali

A quantity of 5 grams of soap sample was weighed in a 250 mL conical flask and 25 mL of distilled water plus a few drops of phenolphthalein solution were added such that the solution turn pink, indicating an alkaline solution. The solution was titrated against 0.1 M of HCl until a pink coloration was discharged. The burette reading was used to calculate the free caustic alkali.

Determination of free fatty acid

A quantity of 5g of soap sample was weighed into a conical flask and set aside. 25 mL of each of diethyl ether and ethanol was measured into a conical flask and neutralized with NaOH solution using Phenolphthalein indicator and warmed on a water bath. Then the mixture was added into conical flask containing weighed soap sample and was titrated against 0.1 M NaOH until colour change. The titre value was used to calculate the free fatty acid.

Collection of test organisms

All microorganisms, six bacteria namely, *Proteus mirabilis* (ATCC 12453), *Luteococcus sanguinis*,

Burkholderia cepacia, Escherichia coli, Corynebacterium accolens and Staphylococcus aureus ATCC 25923, as well as three fungi namely, Malassezia furfur ATCC 44349, Candida albicans ATCC 10231, were obtained from the stock culture of the Department of Biological Sciences, Afe Babalola University, Ado-Ekiti.

Preparation of standard Inoculum

Bacteria isolates were suspended in nutrient broth in comparison to 0.5 McFarland standards and Fungi isolates were suspended into potato dextrose broth in comparison to 1.0 McFarland standards.

Sterilization Methods

Materials such as conical flask, universal bottles and beaker were sterilized by using the oven at 160 °C for 1 hour. Distilled water and Media such as Mueller Hinton agar, Nutrient broth and potato Dextrose broth were sterilized in autoclave (model type; ST 19T) at 121 °C for 15 minutes.

Preparation of Soap Concentration

A stock solution of 500 mg.mL⁻¹ of the soap was prepared by adding 5 g of the soap into 10 mL of sterile water in a universal bottle and warmed to dissolve the soap into solution in a water bath at 60 °C. Using the stock solution, various concentrations of the soap; 250, 125, 100 and 50 mg.mL⁻¹ were obtained.

Antimicrobial Susceptibility Test.

The antimicrobial susceptibility investigations for the soaps were done using agar well diffusion method as described by CLSI (2012, 2013). Each organism was inoculated onto the surface of already prepared sterile

Muller Hinton agar, a sterile swab stick was used to carpet spread the inoculums on the agar. A sterile cork-borer was used to bore 5 wells into the agar gel, while the different soap concentrations were dispensed into the five wells and were allowed to diffuse for 1 hour. Incubation was carried out at 37 °C for 24 hour for bacterial and 3 to 5 days at room temperature for fungi.

GC-MS analysis of oil of Moringa oleifera leaf

Hexane extract of dried leaves of *Moringa oleifera* was analyzed for the chemical constituents of the essential oil by Gas Chromatography Mass Spectrometry (GC-MS) technique as described by Sengupta et al. (2015).

Statistical Analysis

Statistical analyses were determined with Analysis of Variance (ANOVA) using SPSS window 20.0.

RESULTS AND DISCUSSION

Physicochemical analysis of soaps

The results obtained from analyses of different physicochemical parameters of the soaps tested are presented in Table 1. All the soaps fall within the pH range of 8.83 and 9.83. All the soaps possess low values of free caustic alkali and detectable free fatty acid, as well as moderate values of total fatty matter.

The pH values of all soaps analysed in this study agreed with the values obtained by Habib et al. (2016) for toilet soaps sold in Bangladesh; but were far higher than the pH 5.4 – 5.9 of normal human skin (Tarun et al., 2014). The use of soaps with high pH values will cause the skin pH to increase, resulting in dehydration, and alteration of bacteria flora, and ultimately pathogenesis of microbial skin diseases (Tarun et al., 2014). Most commercial soaps



Figure 1 Plate 1: ABUAD Moringa soap (with *Moringa oleifera* leaf shown on the package).

Table 1 Physicochemical analysis of soaps.

Soap	pH	Total Fatty Matter (%)	Free Caustic Alkaline (%)	Free Fatty Acid (%)
Moringa	9.32 ±0.02	70.3 ±2.02	0.65 ±0.12	0.60 ±0.01
DuduOsun	8.83 ±0.05	66.6 ±3.72	0.96 ±0.42	0.98 ±0.22
Tetmosol	9.44 ±0.55	70.7 ±2.41	0.35 ±0.06	0.20 ±0.02
Septol	9.56 ±0.13	68.0 ±1.02	0.25 ±0.02	2.80 ±0.25
Tura	9.61 ±0.20	77.1 ±1.02	0.37 ±0.23	1.19 ±0.11
Dettol	9.71 ±0.40	78.6 ±0.92	0.04 ±0.01	1.01 ±0.32
Delta	9.83 ±0.30	72.3 ±1.12	0.25 ±0.03	0.51 ±0.01
Lux	9.68 ±0.19	73.7 ±0.09	0.06 ±0.02	0.85 ±0.02

Table 2 Activities of soaps on bacteria showing zones of inhibition.

Soaps	Concentrations (mg.mL ⁻¹)	<i>Escherichia coli</i>	<i>Burkholderia cepacia</i>	<i>Corynebacterium accolens</i>	<i>Luteococcus Sanguiinis</i>	<i>Staphylococcus aureus</i> ATCC 25923	<i>Proteus mirabilis</i> (ACCT 12453)
Moringa	500	22	13	27	17	25	14
	250	20	6	20	10	23	13
	125	18 ^a	4 ^{adhj}	17 ^a	9 ^{ac}	17 ^a	11 ^{ad}
	100	6	0	10	4	9	9
	50	3	0	0	0	3	0
DuduOsun	500	28	13	18	18	14	12
	250	23	11	13	13	9	10
	125	18 ^b	8 ^{bi}	12 ^b	11 ^b	7 ^b	9 ^{bce}
	100	8	0	9	5	4	4
	50	0	0	6	0	0	0
Tetmosol	500	12	0	14	9	27	0
	250	9	0	9	5	23	0
	125	4 ^c	0 ^{dhjkl}	5 ^c	0 ^{bcdg}	18 ^c	0 ^{ab}
	100	2	0	0	0	15	0
	50	0	0	0	0	9	0
Septol	500	19	12	16	14	25	12
	250	15	10	12	10	17	6
	125	12 ^d	9 ^d	9 ^d	8 ^d	9 ^d	0 ^{ac}
	100	10	6	5	5	3	0
	50	6	0	0	0	0	0
Tura	500	12	14	9	17	19	14
	250	8	10	4	14	17	9
	125	6 ^{eh}	9 ^{ck}	0 ^{efg}	13 ^e	15 ^e	0 ^{bde}
	100	4	6	0	10	14	0
	50	0	0	0	0	9	0
Delta	500	16	13	14	10	10	13
	250	13	10	10	8	8	0
	125	11 ^{fh}	9 ^{ej}	8 ^f	5 ^f	5 ^f	0 ^{ab}
	100	8	6	5	3	3	0
	50	0	0	0	0	0	0
Dettol	500	15	0	12	14	14	0
	250	13	0	10	12	12	0
	125	10 ^{gh}	0 ^{hik}	8 ^g	9 ^g	9 ^g	0 ^{ab}
	100	8	0	2	3	2	0
	50	0	0	0	0	0	0
Lux	500	0	0	0	0	0	0
	250	0	0	0	0	0	0
	125	0 ^h	0 ^{hik}	0 ^{a-h}	0 ^{a-g}	0 ^g	0 ^{ab}
	100	0	0	0	0	0	0
	50	0	0	0	0	0	0
F-values		2.971	3.799	3.262	2.214	5.407	3.682
P-values		0.016	0.004	0.010	0.059	0.002	0.013

Note: Values are in mm.

^{a-k}Values of zones of inhibition (mm) compared between soaps along column with no common superscript are significantly different ($p < 0.05$).

do have high pH values. **Tarun et al. (2014)**, working on 66 different soaps (including bathing soaps) in India reported that only 5 of the soaps had pH <9.0; 53 soaps had pH 9.01 – 10.0; while the remaining 6 had pH value of 10.63 – 11.01. **Onyangu et al. (2014)** equally reported high pH values of 10.03 – 11.71 in soaps sold in Kenya. Since alteration in skin pH plays significant roles in pathogenesis of skin diseases, the use of cleansing agents with low pH values of about 5.5 has been advocated for

prevention and treatment of skin diseases (**Tarun et al., 2014**).

The free caustic alkali normally results from improper or incomplete saponification. The recommended value is 0.25% for laundry soap and 0.2% for toilet soap (**Snell, Ettore and Hilton, 2007**). The free caustic alkali contents of tetmosol, septol, tura, dettol, delta and lux soaps are relatively low, while those of ABUAD Moringa and DuduOsun soaps were of higher values. Although the values obtained for the free caustic alkali contents of

Table 3 Activities of soaps on fungi showing zones of inhibition.

Soaps	Concentrations (mg.mL ⁻¹)	<i>Malassezia furfur</i> ATCC 44349	<i>Candida albicans</i> ATCC 10231	<i>Cryptococcus neoformans</i> ATCC 23645
Moringa	500	14	16	14
	250	12	15	10
	125	11 ^a	14 ^a	9 ^a
	100	9	9	0
	50	0	0	0
Dudu Osun	500	13	12	14
	250	10	10	9
	125	7 ^b	6 ^b	8 ^a
	100	6	3	5
	50	0	0	0
Tetmosol	500	0	0	0
	250	0	0	0
	125	0 ^c	0 ^c	0 ^b
	100	0	0	0
	50	0	0	0
Septol	500	0	0	0
	250	0	0	0
	125	0 ^c	0 ^c	0 ^b
	100	0	0	0
	50	0	0	0
Tura	500	0	0	0
	250	0	0	0
	125	0 ^c	0 ^c	0 ^b
	100	0	0	0
	50	0	0	0
Delta	500	0	0	0
	250	0	0	0
	125	0 ^c	0 ^c	0 ^b
	100	0	0	0
	50	0	0	0
Dettol	500	0	0	0
	250	0	0	0
	125	0 ^c	0 ^c	0 ^b
	100	0	0	0
	50	0	0	0
Lux	500	0	0	0
	250	0	0	0
	125	0 ^c	0 ^c	0 ^b
	100	0	0	0
	50	0	0	0
F-values		0.675	0.692	0.898
P-values		0.614	0.602	0.426

Note: Values are in mm; ^{a-c}Values of zones of inhibition (mm) compared between soaps along column with different superscripts are statistically different ($p < 0.05$).





ABUAD Moringa and DuduOsun soaps agreed with the values reported by **Taiwo et al (2010)**, but were far lower than values reported by **Beetseh et al. (2013)**.

The total fatty matter of soap is a measure of its suitability for bathing and washing of materials (**Ogunsuyi and Akinawo, 2012**). The total fatty matter for all the reported in this compared favourably with the work of **Vivian et al. (2014)**, as well as the values of 71 – 84 obtained by **Viorica et al. (2011)**; but lower than values of 74 – 92 obtained by **Kuntom (1999)**.

In-vitro antimicrobial activities of soaps

The results of anti-bacterial activities of the soaps are presented in Table 2. All the bacteria tested were susceptible to ABUAD moringa soap, DuduOsun, Septol, Tura and Delta, while varied susceptibilities were obtained for Tetmosol and Dettol. Lux which served as negative control did not produce any antibacterial activity. ABUAD moringa and DuduOsun soaps indicated superior effectiveness against the bacteria tested compared to other soaps. However there was no significant difference

Table 4 Compounds identified in moringa leaf oil extract.

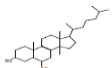
Peak no	Retention Time	Peak Area (%)	Name of compound	Molecular weight	Formula	Structure
1	15.292	1.73	2-Propenamide, N-(1-cyclohexylethyl)-	181	C11H19NO	
2	15.409	39.18	Hexadecanoic acid, methyl ester	270	C17H34O2	
3	16.793	47.13	9-Octadecenoic acid (Z)-, methyl ester	296	C19H36O2	
4	16.985	10.26	Heptadecanoic acid, 10-methyl-, methyl ester	298	C19H38O2	
5	18.793	1.70	Cholest-8-ene-3,6-diol, 14-methyl-, (3.beta.,5.alpha)	416	C28H48O2	

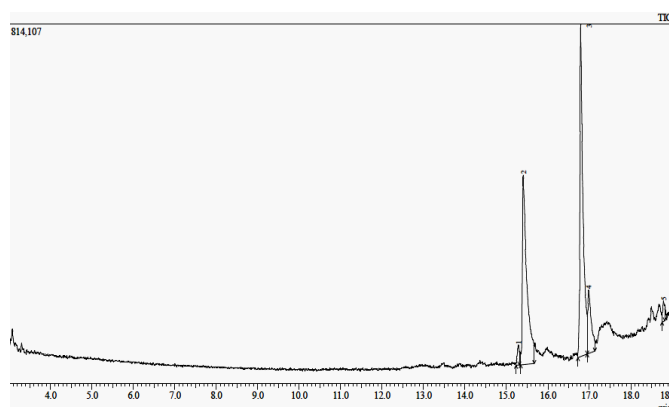

Figure 2 Spectra of GCMS Analysis of the Moringa leaf oil extract.

observed in antibacterial activities between ABUAD moringa and DuduOsun soaps.

The results of the antifungal activities of the soaps are presented in Table 3. Only ABUAD moringa and DuduOsun soaps were effective against all the fungi tested. ABUAD moringa soap indicated higher significant activities on *Malassezia furfur* ATCC 44349 and *Candida albicans* ATCC 10231 than DuduOsun. However there was no significant difference between the two soaps on their activities against *Cryptococcus neoformans* ATCC 23645.

The work of Ekanola et al. (2012) has previously established similar experimental evidence comparable to this work. Ekanola et al. (2012) investigated the role of soaps in human hygiene. In the work, the determination of the *in vitro* inhibitory activities of the various industrial soaps (Delta, Dettol, Lux, Septol, Tetmosol, and Tura), were carried out. It was discovered that none of the soaps showed inhibitory activity against *Candida*. Other researchers have also investigated the *in-vitro* inhibitory activities of soaps. According to Ihuma et al. (2013), Delta soap retained more normal flora than Tetmosol or Tura. Therefore based on this study, ABUAD moringa and Dudu Osun soaps were observed to have better justification in terms of their physicochemical properties and antimicrobial quality for preventive and therapeutic soap measures for maintaining good hygiene. Other soaps in this study have also indicated some effectiveness against bacterial isolates but not sufficiently against antifungal isolates.

The antimicrobial efficacy of ABUAD moringa soap could be attributed to the content of *Moringa oleifera* leaf extract, as previous studies on *Moringa oleifera* leaf cultivated in ABUAD farm, used for the soap production, have been found to possess vital phytochemicals and high antibacterial activities (Okiki et al., 2015a,b). In addition, coconut oil, which is known to possess antimicrobial and anti-inflammatory properties (Fitzpatrick, 2012), used in the ABUAD Moringa soap production, could contribute to the soap's antimicrobial qualities.

GCMS Analysis of Moringa Oleifera leaf

Figure 1 shows the spectra of GCMS analysis of the Moringa leaf oil extract and the identified compounds in the oil are presented in Table 4. The presence of hexadecanoic, 9-octadecenoic, heptadecanoic and cholest-8-ene-3,6-diol may be useful as anti-inflammatory, immunostimulant, antitumour, antioxidant and flavour enhancers in cosmetic production (Omotoso et al., 2014). This may serve as a plus to Moringa oleifera leaf soap.

CONCLUSION

ABUAD moringa soap was reported in this study to have potent antibacterial and antifungal activities. Antimicrobial soaps with high antimicrobial potency should be used only for therapeutic purposes and not for prophylaxis because its continuous use may eliminate both beneficial and harmful microflora of the skin.

REFERENCES

- Alam, N., Wojtyma, K. 1989. Mothers' personal and domestic hygiene and diarrhoea incidence in young children in rural Bangladesh. *International Journal of Epidemiology*, vol. 18, no. 1, p. 242-287. <https://doi.org/10.1093/ije/18.1.242> PMID:2722372
- Adamu, S. O., Johnson, T. L. 1997. *Statistics for beginners*. Book 1. Ibadan, Nigeria : SAAL Publication, p. 184-199.
- AOAC. 2010. Association of Analytical Chemist. Official Methods of Analysis 14th ed., Washington D C.
- Beetseh, C., Anza, M. 2013. Chemical Characterization of Black Soap (Chahul Mtse) Made by Using Cassava Peels Ashes (Alkali Base) and Palm Oil in North Central Zone of Nigeria. *Journal of Chemical Characteristics of Local Black Soap*, vol. 3, p. 82-93.
- Callewaert, C., Frederiek, M., Michael, S., Granitsiotis M., Tom V., Nico, B. 2013. Characterization of Staphylococcus and Corynebacterium Clusters in the Human Axillary Region; *PLoS ONE*, vol. 8, no. 8, p. e70538.14.
- CLSI, 2012. Clinical and Laboratory Standards Institutes. Methods for Dilution Antimicrobial Susceptibility Tests for Bacteria That Grow Aerobically; Approved Standard – 9th ed. [online] [cit. 2017-1-13] Available at: <https://clsi.org/standards/products/microbiology/document/s/m07/>.
- CLSI, 2013. Clinical and Laboratory Standards Institutes. Performance Standard of Antimicrobial Susceptibility Testing; 23rd Information Supplement [online] [cit. 2017-1-13] Available at: <https://www.aacc.org/store/books/9200/performance-standards-for-antimicrobial-susceptibility-testing.aspx>.
- Cogen, A. L, Nizet, V., Gallo, R. L. 2008. Skin microbiota: a source of disease or defense. *British Journal of Dermatology*, vol. 158, no. 3, p. 442-455. <https://doi.org/10.1111/j.1365-2133.2008.08437.x> PMID:18275522
- Eckburg, P. B, Bik, E. M., Bemstein, C. N., Pardon E., Dethlefsen, L., Sargent, M., Gill, S. R., Rehman, D. A. 2005. Diversity of the human skin microbiome. *Science*, vol. 324, p. 1190-1192.
- Ekanola, Y. A., Ogunshe, A. A. O., Azeez, D. L., Opasol, O. 2012. Studies on in vitro antimycotic potentials of local and industrial soaps on vuvlovaginal *Candida* species. *International Journal of Plant, Animal and Environmental Sciences*, vol. 2, no. 3, p. 69-74.
- Snell, F. D., Ettore, L. S., Hilton, C. L. 2007. *Encyclopedia of Industrial Chemical analysis*. Geneva, Switzerland : Interscience Publishers. 545 p. ISBN 9780471810100.
- Evans, C. A. 1975. Persistent individual differences in the bacterial flora of the skin of the forehead: numbers of propionibacter. *Journal of Dermatology*, vol. 64, no. 1, p. 42-50. <https://doi.org/10.1111/1523-1747.ep12540897>
- Ogunsuyi, H. O., Akinnowo, C. A. 2012. Quality Assessment of Soaps Produced from Palm Bunch Ash-Derived Alkali and Coconut Oil. *Journal of Applied Sciences & Environmental Management*, vol. 16, no. 4, p. 363-366.
- Habib, A., Kumar, S., Sorowar, S., Karmoker, J., Khatun, K., Al-Reza, S. M. 2016. Study on the Physicochemical Properties of Some Commercial Soaps Available in Bangladeshi Market. *International Journal of Advanced Research in Chemical Science*, vol. 3, no. 6, p. 9-12.
- Ihuma, J. O., Asenga, G. H., Abioye, J. O. K., Koggie, A. Z., Nmadu, P., Nwakwo, M. 2013. The Effect of Some Medicated Soaps on Some Normal-Micro-flora of the Human Skin. *International Journal of Advanced Biological Research*, vol. 3, no. 3, p. 341-347.
- Kuntom, A., Ahmad, I., Kifli, M., Shariff, Z. M. 1999. Chemical and Physical Characteristics of Soap Made from Distilled Fatty Acids of Palm Oil and Palm-Kernel Oil. *Journal of Surfactants and Detergents*, vol. 2, p. 325-329. <https://doi.org/10.1007/s11743-999-0084-5>
- Lalan, M. 2010. Antibacteria Soap Dangers [online] [cit. 2017-1-13] Available at: <http://www.buzzle.com/articles/antibacterial-soap-dangers.html>.
- Fitzpatrick, M. M. 2012. The Uses and Benefits of Coconut Oil [online] [cit. 2017-1-13] Available at: <http://ezinearticles.com/?Coconut-Oil-Uses&id=7084722>.
- Okiki, P. A., Balogun, B. D., Osibote, I. A, Asoso, S., Adelegan, O. 2015a. Antibacterial Activity of Methanolic Extract of *Moringa oleifera* Lam. Leaf on ESBL Producing Bacterial Isolates from Urine of Patients with Urinary Tract Infections. *Journal of Biology, Agriculture and Healthcare*, vol. 5, no. 20, p. 124-132.
- Okiki, P. A., Osibote, I. A., Balogun, O., Oyinloye, B. E., Idris, O., Adelegan, O., Asoso, S. O. 2015b. Evaluation of Proximate, Minerals, Vitamins and Phytochemical Composition of *Moringa oleifera* Lam. Cultivated in Ado Ekiti, Nigeria *Advances in Biological Research*, vol. 9, no. 6, p. 436-443.
- Omotoso, A. E., Ezealisiji, K. Mkpuru, K. I. 2014. Chemometric profiling of methanolic leaf extract of *Cnidioscolus aconitifolius* (*Euphorbiaceae*) using UV-VIS, FTIR and GC-MS techniques. *Peak Journal of Medicinal Plant Research*, vol. 2, no. 1, p. 6-12.
- Prescott, L., Harley, J. P., Klein, D. A. 2008. *Microbiology*. 7th ed. New York, USA : McGraw-Hill companies. ISBN 10: 0072992913.
- Sengupta, S., Pramanik, A., Ghosh, A., Bhattacharyya., M. 2015. Antimicrobial activities of actinomycetes isolated from unexplored regions Sundarbans mangrove ecosystem. *BMC Microbiology*, vol. 15, p. 170. <https://doi.org/10.1186/s12866-015-0495-4> PMID:26293487
- Soap History. 2014. Types of soap: *Differences between soaps*[online] [cit. 2017-1-13] Available at: <http://www.soaphistory.net/soap-facts/soap-types/>.
- Speers, R., Bernard, H. Grandy, F. Shooter, R. A. 1965. Increased dispersal of skin bacteria into the air after shower baths. *Lancet*, vol. 1, no. 7383, p. 478-480. [https://doi.org/10.1016/S0140-6736\(65\)91609-0](https://doi.org/10.1016/S0140-6736(65)91609-0)
- Taiwo, A., Oluwadare, I., Shobo, A., Amolegbe, S. 2008. Physical and Chemical Characteristics of Soap. *Scientific Research Essay*, vol. 3, p. 515-517.
- Tarun, J., Susan, J., Suria, J., Susan, V. J, Criton, S. 2014. Evaluation of pH of bathing Saps and Shampoos for Skin and Hair Care. *Indian Journal of Dermatology*, vol. 59, no. 5, p. 442-444. <https://doi.org/10.4103/0019-5154.139861> PMID:25284846
- Popescu, V., Soceanu, A., Dobrinas, S., Stanciu, G, Epure, D. T. 2011. Quality Control and Evaluation of Certain Properties for Soap Made in Romania. *Journal of Scientific Study and Research, Chemistry and Chemical Engineering, Biotechnology, Food Industry*, vol. 12, no. 3, p. 257-261.
- Vivian, O. P, Oyaro, N., Osano, A., Mesopirr, L., Omwoyo, W. N. 2014. Assessment of the Physicochemical Properties of Selected Commercial Soaps Manufactured and Sold in Kenya. *Open Journal of Applied Sciences*, vol. 4, no. 8, p. 433-440. <https://doi.org/10.4236/ojapps.2014.48040>

Acknowledgments:

The authors wish to appreciate all the technologists at Chemistry and Microbiology Laboratories, Afe Babalola University, Ado-Ekiti, Ekiti State, Nigeria.

Contact address:

Pius Abimbola Okiki, Department of Biological Sciences, Afe Babalola University, Ado-Ekiti, Ekiti State, Nigeria, E-mail: okikipa@abuad.edu.ng

Abiodun Ayodele Ojo, Department of Chemical Sciences, Afe Babalola University, Ado-Ekiti, Ekiti State, Nigeria, E-mail: ojoa@abuad.edu.ng

Hadiza Tani Onyibe, Department of Biological Sciences, Afe Babalola University, Ado-Ekiti, Ekiti State, Nigeria, E-mail: hadizaonyibe@yahoo.com

Olawe Oso, Department of Chemical Sciences, Afe Babalola University, Ado-Ekiti, Ekiti State, Nigeria, E-mail: wale_oso@yahoo.com

Basiru Olaitan Ajiboye, Department of Chemical Sciences, Afe Babalola University, Ado-Ekiti, Ekiti State, Nigeria, E-mail: bash1428@yahoo.co.uk



EFFECT OF HUMATES IN DIET OF DAIRY COWS ON THE RAW MILK MAIN COMPONENTS

Miroslava Potůčková, Lenka Kouřimská

ABSTRACT

The effect of supplemental humic substances (HS) on the main milk components was investigated. A total of 10 dairy cows (Czech pied cattle, crossbred Czech pied cattle × Ayrshire and crossbred Czech pied cattle × Red Holstein) were tested. Animals were randomly divided into 2 groups, control (C) and experimental (E). Animals fed the same feed mixture and group E was additionally supplemented with HS (200 mg.kg⁻¹ of product Humafit prepared from the Sakhalin Leonardite). The experimental period took 3 months. Cows were milked twice a day. The milk composition (lactose, fat, crude protein, pure protein and casein) of every cow was monitored on days 0, 14, 28, 42, 56, 70 and 84 of the experiment. Pure protein content was determined by Kjeldahl method, other components were analysed using an infrared analyser MilkoScan FT 120. It was found that the crude protein, pure protein and casein content in milk of group E significantly ($p < 0.05$) increased from the 56th day of the experimental period. Differences of the protein fraction contents in group C and of the dry matter, non-fat dry matter, lactose and fat content in both groups were non-significant ($p < 0.05$). Higher protein and especially casein content in milk could be very important for the cheesemaking as it could increase the cheese yield.

Keywords: humic substances; Sakhalin Leonardite; dairy cows; milk proteins; casein

INTRODUCTION

Humates are formed from chemical and biological decomposition of plant, animal and microbial materials mostly by soil bacteria. As high-molecular heteropolycondensed compounds with colloidal or amorphous nature and yellow to brown-black colour they contain variable functional groups such as amide, amine, carbonyl, carboxyl, hydroxyl, phenol or sulphhydryl. Humic substances (HS) are the main organic component of soil, peat, different types of coal, lignite, fresh and sea water, sewage and their sediments. Humates principal constituents are humus, humic acid, fulvic acid, ulmic acid and some trace microelements for instance copper, iron, manganese and zinc (Visser, 1973; Stevenson, 1994). They are currently used in industry, environmental and bio-medicine and agriculture (Cunha et al., 2014; Rose et al., 2014).

HS have been started to investigate in some areas of animal husbandry respective health, wellbeing and production during the past few decades. The HS have been reported to have significant analgesic, antidiarrheal, anti-inflammatory, antimicrobial, antiseptic, antitoxic, antiviral and immunostimulatory properties. They have been reported to have stimulating effects on oxygen transport, form protective film on the mucosa of gastrointestinal tract and ensure an improved nutrient utilization in animal feed (Islam et al., 2005; Kucukersan et al., 2005; Trckova et

al., 2005; Písaříková et al., 2010). These specific properties probably bring also possible benefits in animal production. Many authors indicated that supplemental humates reduced animal mortality, improved health, growth performance, feed conversion and some production characteristics of pigs (Wang et al., 2008; Písaříková et al., 2010; Bai et al., 2013), poultry (Hayirly et al., 2005; Šamudovská and Demeterová, 2010; Gładkowski et al., 2011) and dairy cattle (Degirmencioglu, 2012, 2014).

However, the use of the HS as a dietary supplement in dairy cow diet has not been well reported. Therefore, the aim of this research was to determine the effects of humates supplemented diet on the main milk components in dairy cows. The hypothesis was that the humates supplementation will affect the dairy cows' raw milk composition and the main milk components content will be increased.

MATERIAL AND METHODOLOGY

Humates characterisation

The humates (product Humafit) used in the experiment were obtained from ReConsulting a.s. company, CZ. The Humafit was prepared from the Sakhalin Leonardite and according to the producer contained 4.20 g.100 g⁻¹ of moisture, 95.80 g.100 g⁻¹ of dry matter, 65.34 g.100 g⁻¹ of natural humic acids, 7.74 g.100 g⁻¹ of crude protein,

Table 1 Formula of feed mixture.

Ingredient	Content (g.100 g ⁻¹ of DM)
Alfalfa haylage	21.44
Corn silage	20.62
Corn meal	17.87
Meadow hay	7.83
Soybean meal	6.93
Barley grain	6.05
Malt meal	5.27
Wheat bran	4.83
Wheat grain	3.99
Rapeseed meal	2.92
Sugar beet pulps	0.96
Vitamin and mineral premix*	1.31

Note: DM = dry matter; *premix composition per 1 kg: 150 g Ca, 60 g P, 90 g Na, 80 g Mg, 2 g Fe, 2 g Cu, 8 g Mn, 10 g Zn, 0.04 g Se, 0.20 g I, 0.04 g Co, 0.02 g S, 1000 × 1000 IU vitamin A, 200 × 1000 IU vitamin D₃, 5.00 g vitamin E.

Table 2 Chemical composition of feed mixture.

Component	Content
DM (g.100 g ⁻¹)	46.13
Protein (g.100 g ⁻¹ of DM)	16.65
Fat (g.100 g ⁻¹ of DM)	2.58
Ash (g.100 g ⁻¹ of DM)	7.04
Starch (g.100 g ⁻¹ of DM)	19.52
Fiber (g.100 g ⁻¹ of DM)	17.46
NDF (g.100 g ⁻¹ of DM)	32.22
ADF (g.100 g ⁻¹ of DM)	17.34
NE _L (MJ.kg ⁻¹)	1.27

Note: DM = dry matter, NDF = neutral detergent fiber, ADF = acid detergent fiber, NE_L = net energy of lactation.

Table 3 MilcoScan FT 120 calibration coefficients.

Analyte	Slope	Intercept	B0-coef.
Dry matter (total solids)	1.0542	-0.6963	1.5476
Non-fat dry matter (solids non-fat)	1.0060	-0.1504	0.6522
Lactose	1.1905	-0.6819	0.6027
Fat	1.0153	-0.0093	0.3590
Crude protein	0.9919	0.0644	0.1440
Casein	1.0758	-0.3635	-0.9734

0.82 g.100 g⁻¹ of fat, 21.90 g.100 g⁻¹ of ash, 1.45 g.100 g⁻¹ of nitrogen, 0.97 g.100 g⁻¹ of phosphorus, 0.40 g.100 g⁻¹ of calcium and 0.24 g.100 g⁻¹ of sodium. Humic acids were characterised according to the Novák and Hrabal (2011) and Madronová (2011). Other components were determined according to AOAC (2012).

Animal care, experimental design, animals and diets

The experimental conditions were designed in accordance with the Guide for the care and use of agricultural animals in research and teaching (FASS, 2010).

In the experiment Czech pied cattle, crossbred Czech pied cattle (79 – 87%) × Ayrshire (13 – 21%) and crossbred Czech pied cattle (83 – 87%) × Red Holstein (13 – 17%) dairy cows as research animals were used. A total of 10 dairy cows with balanced characteristics (body weight 654 ±48 kg, lactation period 97 ±21 days of milk production, producing 28.7 ±5.7 kg.day⁻¹) were randomly

divided into 2 groups with the same breed distribution: control (C) and experimental (E). There were 5 animals per group. Animals were housed in a free stall, allowed *ad libitum* access to water and fed twice a day (at 5 : 30 and 15 : 00) with feed mixture (Tables 1 and 2) prepared according to the Nutrient Requirements of Dairy Cattle (NRC, 2001).

The experimental group became extra supplemented by Humafit (ReConsulting a.s., CZ) which was manually handed to each experimental animal in dose of 200 mg.kg⁻¹. Cows were milked twice a day (at 5 and 17 hours) with an automated milking plant. The health status of the animals was checked before each milking to avoid milk affected by mastitis. The experimental period took 3 months. The seasonal effect of components were not taken into account because the samples from the both groups (control and experimental) were taken in parallel at the same time.

Milk sampling

Daily raw milk samples (500 mL, 1 : 1 from two daily milking) were taken from each cow and collected on days 0, 14, 28, 42, 56, 70 and 84 of the experimental period. Samples were preserved using Broad Spectrum Microtabs II (Advanced Instruments, Inc., USA) containing 8 mg of Bronopol and 0.30 mg of Natamycin. These tablets inhibit bacteria, yeasts and molds, provide extended shelf life and reduce lipolysis of milk samples. After this preservation the samples were stored at 4 °C until analysis, which was performed the next day after milk sampling.

Analytical methods

The raw milk samples were analysed for dry matter (total solids), non-fat dry matter (solids non-fat), lactose, fat, crude protein and casein content using an infrared automatic milk analyser MilkoScan™ FT 120 (FOSS Electric A/S, DK) according to ISO 9622. The MilkoScan calibration coefficients (slope, intercept and B0-coef for filters) for these analytes are in Table 3. Pure protein content was determined by the Kjeldahl method (ISO 8968-1, ISO 8968-3, ISO 8968-5). All measurements were performed twice for each sample.

Statistical analysis

The outliers were removed from the obtained data by Grubbs' test on the level of significance $\alpha = 0.05$ using Microsoft Excel 2003 (Microsoft Office Excel 2003, Microsoft Corporation, USA). Results in form of arithmetic means from 10 parallel measurements with standard deviation are expressed as difference from the day 0 in order to minimise the effect of genotype, animal individuality and stage of lactation. The one-way ANOVA F-test on the level of significance $\alpha = 0.05$ of the dry matter, non-fat dry matter, lactose, fat, crude protein, pure protein and casein content was performed by Microsoft Excel 2003 (Microsoft Office Excel 2003, Microsoft Corporation, USA). Means followed by the same letters have the same statistical significance.

RESULTS AND DISCUSSION

Effects of supplemental humates in form of the product Humafit on the main milk components content were investigated in dairy cows. Both groups of animals, C (control) and E (experimental), were fed with feed

mixture described in Tables 1 and 2. Group E was daily supplemented with 200 mg.kg⁻¹ of Humafit. The initial milk composition (dry matter, non-fat dry matter, lactose, fat, crude protein, pure protein and casein content respectively) and also changes of the main milk component content during the experimental period are shown in Tables 4 to 10. The contents of the main milk components were in line with Bujko et al. (2011), Filipejová et al. (2011) and Zajác et al. (2012, 2015).

No significant differences ($p < 0.05$) were observed in dry matter, non-fat dry matter, lactose and fat content in milk of both animal groups during the experiment. The same trend was recorded for the content of crude protein, pure protein and casein in group C ($p < 0.05$) milk. On the contrary, the crude protein, pure protein and casein content in milk of cows from group E supplemented with humates were significantly ($p < 0.05$) higher from the 56th day of the experimental period.

HS have been recognised to form a protective film on the gastrointestinal mucosa and positively modulate the gastrointestinal processes as so as nutrient utilization (Lange et al., 1996; Islam et al., 2005; Písaříková et al., 2010). Their antimicrobial, antiviral, antiseptic, anti-inflammatory, analgesic and immunostimulatory properties have been also well-reported (Lange et al., 1996; Islam et al., 2005; Kucukersan et al., 2005; Agazzi et al., 2007). Other authors demonstrated beneficial influence of humates on growth performance, feed efficiency and feed conversion ratio in the livestock (Hayirly et al., 2005; Avci et al., 2007; Wang et al., 2008; Šamudovská, and Demeterová, 2010; Bai et al., 2013), on meat quality in pigs (Wang et al., 2008; Bai et al., 2013) and on egg production and fatty acid profile of egg yolk modulation in hens (Hayirly et al., 2005; Gladkowski et al., 2011).

Degirmencioglu (2012, 2014) focused on the effects of different levels of humic acid (HA) supplementation (0, 1 and 3 g HA.kg⁻¹) on blood characteristics, milk yield and milk composition in dairy goats. He reported significantly lower levels of total and LDL cholesterol after HA supplementation. However, results of milk yields were inconsistent and he did not observe improvements in milk composition respectively non-fat dry matter, lactose, fat and protein content (Degirmencioglu, 2012, 2014).

Table 4 Effect of supplemental humic substances on dry matter content.

Time (days)	Dry matter content			
	Control group		Experimental group	
	(g.100 g ⁻¹ ±SD)	RV (day/day 0)	(g.100 g ⁻¹ ±SD)	RV (day/day 0)
0	12.75 ±0.79	1.00	12.85 ±0.81	1.00
14	12.49 ±1.55	0.98 ^a	12.22 ±0.43	0.96 ^a
28	12.69 ±1.65	0.99 ^a	12.97 ±0.63	1.01 ^a
42	12.92 ±0.88	1.01 ^a	13.13 ±0.76	1.02 ^a
56	12.68 ±0.99	1.00 ^a	13.24 ±1.17	1.03 ^a
70	13.23 ±0.65	1.04 ^a	12.89 ±0.43	1.01 ^a
84	13.18 ±0.84	1.04 ^a	13.74 ±0.87	1.07 ^a

Note: SD = standard deviation, RV = relative value. Results are expressed as arithmetic mean of four parallel evaluations. ^aNo significant differences ($p > 0.05$) from day 0 of the experimental period.

Table 5 Effect of supplemental humic substances on non-fat dry matter content

Time (days)	Non-fat dry matter content			
	Control group		Experimental group	
	(g.100 g ⁻¹ ±SD)	RV (day/day 0)	(g.100 g ⁻¹ ±SD)	RV (day/day 0)
0	8.50 ± .60	1.00	8.45 ±0.76	1.00
14	8.72 ±1.49	1.02 ^a	8.49 ±0.42	1.01 ^a
28	8.32 ±1.35	0.98 ^a	8.73 ±0.80	1.05 ^a
42	8.56 ±0.63	1.01 ^a	8.56 ±0.50	1.02 ^a
56	8.42 ±0.40	1.00 ^a	8.96 ±1.26	1.06 ^a
70	9.20 ±0.63	1.09 ^a	8.80 ±0.53	1.05 ^a
84	8.88 ±0.78	1.04 ^a	9.04 ±0.76	1.08 ^a

Note: SD = standard deviation, RV = relative value. Results are expressed as arithmetic mean of four parallel evaluations. ^aNo significant differences ($p >0.05$) from day 0 of the experimental period.

Table 6 Effect of supplemental humic substances on lactose content.

Time (days)	Lactose content			
	Control group		Experimental group	
	(g.100 g ⁻¹ ±SD)	RV (day/day 0)	(g.100 g ⁻¹ ±SD)	RV (day/day 0)
0	4.93 ±0.13	1.00	4.95 ±0.15	1.00
14	4.78 ±0.09	0.97 ^b	4.80 ±0.14	0.97 ^a
28	4.78 ±0.16	0.97 ^b	5.00 ±0.11	1.01 ^a
42	4.83 ±0.17	0.98 ^a	4.95 ±0.10	1.00 ^a
56	4.78 ±0.23	0.97 ^a	5.10 ±0.13	1.03 ^a
70	4.88 ±0.18	0.99 ^a	4.90 ±0.06	0.99 ^a
84	4.98 ±0.22	1.01 ^a	4.80 ±0.20	0.97 ^a

Note: SD = standard deviation, RV = relative value. Results are expressed as arithmetic mean of four parallel evaluations. ^aNo significant differences ($p >0.05$) from day 0 of the experimental period. ^bSignificant difference ($p <0.05$) from day 0 of the experimental period.

Table 7 Effect of supplemental humic substances on fat content

Time (days)	Fat content			
	Control group		Experimental group	
	(g.100 g ⁻¹ ±SD)	RV (day/day 0)	(g.100 g ⁻¹ ±SD)	RV (day/day 0)
0	4.29 ±0.52	1.00	4.61 ±0.76	1.00
14	3.99 ± 0.58	0.93 ^a	4.15 ±0.29	0.90 ^a
28	4.33 ±0.84	1.01 ^a	4.38 ±0.15	0.95 ^a
42	4.72 ±0.62	1.10 ^a	4.75 ±1.01	1.03 ^a
56	4.33 ±0.78	1.01 ^a	4.89 ±0.78	1.06 ^a
70	4.55 ±0.58	1.06 ^a	4.56 ±0.27	0.99 ^a
84	4.76 ±0.44	1.11 ^a	5.16 ±0.42	1.12 ^a

Note: SD = standard deviation, RV = relative value. Results are expressed as arithmetic mean of four parallel evaluations. ^aNo significant differences ($p >0.05$) from day 0 of the experimental period.

Table 8 Effect of supplemental humic substances on crude protein content

Time (days)	Crude protein content			
	Control group		Experimental group	
	(g.100 g ⁻¹ ±SD)	RV (day/day 0)	(g.100 g ⁻¹ ±SD)	RV (day/day 0)
0	3.48 ±0.38	1.00	3.21 ±0.13	1.00
14	3.44 ±0.42	0.99 ^a	3.21 ±0.09	1.00 ^a
28	3.51 ±0.41	1.01 ^a	3.37 ±0.08	1.05 ^a
42	3.55 ±0.40	1.02 ^a	3.40 ±0.09	1.06 ^a
56	3.51 ±0.30	1.01 ^a	3.50 ±0.14	1.09 ^b
70	3.51 ±0.39	1.01 ^a	3.69 ±0.13	1.15 ^b
84	3.55 ±0.16	1.02 ^a	3.88 ±0.19	1.21 ^b

Note: SD = standard deviation, RV = relative value. Results are expressed as arithmetic mean of four parallel evaluations. ^aNo significant differences ($p >0.05$) from day 0 of the experimental period. ^bSignificant difference ($p <0.05$) from day 0 of the experimental period.

Table 9 Effect of supplemental humic substances on pure protein content

Time (days)	Pure protein content			
	Control group		Experimental group	
	(g.100 g ⁻¹ ±SD)	RV (day/day 0)	(g.100 g ⁻¹ ±SD)	RV (day/day 0)
0	3.17 ±0.28	1.00	3.09 ±0.10	1.00
14	3.20 ±0.27	1.01 ^a	3.06 ±0.10	0.99 ^a
28	3.26 ±0.31	1.03 ^a	3.21 ±0.06	1.04 ^a
42	3.23 ±0.27	1.02 ^a	3.24 ±0.07	1.05 ^a
56	3.11 ±0.25	0.98 ^a	3.34 ±0.07	1.08 ^b
70	3.11 ±0.13	0.98 ^a	3.49 ±0.10	1.13 ^b
84	3.07 ±0.06	0.97 ^a	3.58 ±0.13	1.16 ^b

Note: SD = standard deviation, RV = relative value. Results are expressed as arithmetic mean of four parallel evaluations. ^aNo significant differences ($p > 0.05$) from day 0 of the experimental period. ^bSignificant difference ($p < 0.05$) from day 0 of the experimental period.

Table 10 Effect of supplemental humic substances on casein content.

Time (days)	Casein content			
	Control group		Experimental group	
	(g.100 g ⁻¹ ±SD)	RV (day/day 0)	(g.100 g ⁻¹ ±SD)	RV (day/day 0)
0	2.68 ±0.29	1.00	2.47 ±0.10	1.00
14	2.57 ±0.38	0.96 ^a	2.42 ±0.15	0.98 ^a
28	2.65 ±0.34	0.99 ^a	2.62 ±0.12	1.06 ^a
42	2.79 ±0.31	1.04 ^a	2.59 ±0.11	1.05 ^a
56	2.73 ±0.22	1.02 ^a	2.67 ±0.10	1.08 ^b
70	2.68 ±0.30	1.00 ^a	2.72 ±0.11	1.10 ^b
84	2.79 ±0.09	1.04 ^a	2.96 ±0.16	1.20 ^b

Note: SD = standard deviation, RV = relative value. Results are expressed as arithmetic mean of four parallel evaluations. ^aNo significant differences ($p > 0.05$) from day 0 of the experimental period. ^bSignificant difference ($p < 0.05$) from day 0 of the experimental period.

Our obtained data related to the milk composition are in agreement with average milk composition analysed in Central Milk Laboratory of the Czech Republic (CMDA, 2013; Kouřimská et al., 2014). Data related to the dry matter content, non-fat dry matter content, lactose and fat are in agreement with Degirmencioglu (2012, 2014). On the contrary, we recorded significantly higher crude protein, pure protein and casein content after the 56th days of the humates addition. These results could be attributable principally to the different HS preparations, animal species and ages and experimental conditions (dose of humates, longer length of experimental period) as was described preliminary (Wang et al., 2008).

CONCLUSION

According to the current experiment results it could be concluded that dietary supplementation with humates can influence milk composition. Although the mechanism of HS administration in milk synthesis has not been fully described, their beneficial effects on gastrointestinal processes and nutrient utilization can probably increase the crude protein, pure protein and casein content in milk. Higher protein and especially casein content in milk could be very important for the cheesemaking in context of the cheese yield.

REFERENCES

Agazzi, A., Cigalino, G., Mancin, G., Savoini, G., Dell'Orto, V. 2007. Effects of dietary humates on growth and an aspect of cell-mediated immune response in newborn kids.

Small Ruminant Research, vol. 72, no. 2-3, p. 242-245. <https://doi.org/10.1016/j.smallrumres.2006.10.020>

AOAC. 2012. *Official methods of analysis*. 19th ed. ARLINGTON, USA: Association of Official Analytical Chemists.

Avcı, M., Denek, N., Kaplan, O. 2007. Effects of humic acid at different levels on growth performance, carcass yields and some biochemical parameters of quails. *Journal of Animal and Veterinary Advances*, vol. 6, no. 1, p. 1-4.

Bai, H. X., Chang, Q. F., Shi, B. M., Shan, A. S. 2013. Effects of fulvic acid on growth performance and meat quality in growing-finishing pigs. *Livestock Science*, vol. 158, no. 1-3, p. 118-123. <https://doi.org/10.1016/j.livsci.2013.10.013>

Bujko, J., Kocman, R., Žitný, J., Trakovická, A., Hrnecar, C. 2011. Analyse of traits of milk production in dairy cows. *Potravinarstvo*, vol. 5, no. 1, p. 5-9. <https://doi.org/10.5219/93>

CMDA 2013. Statistic of milk purchasing and processing (Statistika nákupu a zpracování mléka), Czech and Moravian Dairy Association [online] s.a. [cit. 2013-01-25] Available at: <http://www.cmsm.cz/statistika>.

Cunha, G. D., Romão, L. P. C., Macedo, Z. S. 2014. Production of alpha-alumina nanoparticles using aquatic humic substances. *Powder Technology*, vol. 254, p. 344-351. <https://doi.org/10.1016/j.powtec.2014.01.008>

Degirmencioglu, T. 2012. Using humic acid in diets for Saanen goats. *Mljekarstvo*, vol. 62, no. 4, p. 278-283.

Degirmencioglu, T. 2014. Using humic acid in diets for dairy goats. *Animal Science Papers and Reports*, vol. 32, no. 1, p. 25-32.

- FASS. 2010. *Guide for the Care and Use of Agricultural Animals in Research and Teaching*. 3rd ed. CHAMPAIGN, USA: The Federation of Animal Science Societies.
- Filipejová, T., Kováčik, J., Kirchnerová, K., Foltýs, V. 2011. Changes in milk composition as a result of metabolic disorders of dairy cows. *Potravinarstvo*, vol. 5, no. 1, p. 10-16. <https://doi.org/10.5219/113>
- Gładkowski, W., Kielbowicz, G., Chojnacka, A., Gil, M., Trziszka, T., Dobrzański, Z., Wawrzeńczyk, C. 2011. Fatty acid composition of egg yolk phospholipid fractions following feed supplementation of Lohmann Brown hens with humic-fat preparations. *Food Chemistry*, vol. 126, no. 3, p. 1013-1018. <https://doi.org/10.1016/j.foodchem.2010.11.112>
- Hayirli, A., Esenbuğa, N., Macit, M., Laçin, E., Karaoğlu, M., Karaca, H., Yildiz, L. 2005. Nutrition practice to alleviate the adverse effects of stress on laying performance, metabolic profile, and egg quality in peak producing hens: I. The humate supplementation. *Asian-Australasian Journal of Animal Sciences*, vol. 18, no. 9, p. 1310-1319. <https://doi.org/10.5713/ajas.2005.1310>
- Islam, K. M. S., Schuhmacher, A., Gropp, J. M. 2005. Humic acid substances in animal agriculture. *Pakistan Journal of Nutrition*, vol. 4, no. 3, p. 126-134. <https://doi.org/10.3923/pjn.2005.126.134>
- ISO 8968-1: 2014. *Milk – Determination of nitrogen content – Part 1: Kjeldahl principle and crude protein calculation*.
- ISO 8968-3: 2004. *Milk – Determination of nitrogen content – Part 3: Block-digestion method (Semi-micro rapid routine method)*.
- ISO 8968-5: 2001. *Milk – Determination of nitrogen content – Part 5: Determination of protein-nitrogen content*.
- ISO 9622: 2013. *Milk and liquid milk products - Guidelines for the application of mid-infrared spectrometry*.
- Kouřimská, L., Legarová, V., Panovská, Z., Pánek, J. 2014. Quality of cows' milk from organic and conventional farming. *Czech Journal of Food Sciences*, vol. 32, no. 4, p. 398-405.
- Kucukersan, S., Kucukersan, K., Colpan, I., Goncuoglu, E., Reisl, Z., Yesilbag, D. 2005. The effects of humic acid on egg production and egg traits of laying hen. *Veterinární Medicína – Czech*, vol. 50, no. 9, p. 406-410.
- Lange, N., Kuhnert, M., Haase, A., Hoke, H., Seubert, B. 1996. Studies concerning the resorption properties of a low molecular humic substance after single oral application to rats. *Deutsche Tierärztliche Wochenschrift*, vol. 103, no. 4, p. 134-135.
- Madronová, L. 2011. *Humic acids from raw materials of the Czech Republic*. 1st ed. NEW YORK, USA : Nova Science Publishers.
- NRC. 2001. *Nutrient Requirements of Dairy Cattle*. 7th ed. WASHINGTON, USA : The National Academies Press, National Research Council.
- Novák, F., Hrabal, R. 2011. Quantitative C-13 NMR spectroscopy of humic acids. *Chemické Listy*, vol. 105, no. 10, p. 752-760.
- Pišaříková, B., Zralý, Z., Herzig, I. 2010. The effect of dietary sodium humate supplementation on nutrient digestibility in growing pigs. *Acta Veterinaria Brno*, vol. 79, no. 3, p. 349-353. <https://doi.org/10.2754/avb201079030349>
- Rose, M. T., Patti, A. F., Little, K. R., Brown, A. L., Jackson, W. R., Cavagnaro, T. R. 2014. A meta-analysis and review of plant-growth response to humic substances: Practical implications for agriculture. *Advances in Agronomy*, vol. 124, p. 37-89. <https://doi.org/10.1016/B978-0-12-800138-7.00002-4>
- Stevenson, F. J. 1994. *Humus chemistry: Genesis, Composition, Reactions*. 2nd ed. NEW YORK, USA : John Wiley & Sons.
- Šamudovská, A., Demeterová, M. 2010. Effect of diet supplemented with natural humic compounds and sodium humate on performance and selected metabolic variables in broiler chickens. *Acta Veterinaria Brno*, vol. 79, no. 3, p. 385-393. <https://doi.org/10.2754/avb201079030385>
- Trckova, M., Matlova, L., Hudcova, H., Faldyna, M., Zraly, Z., Dvorska, L., Beran, V., Pavlik, I. 2005. Peat as a feed supplement for animals: a review. *Veterinární Medicína – Czech*, vol. 50, no. 8, p. 361-377.
- Visser, S. A. 1973. Some biological effects of humic acids in the rat. *Acta Biologica et Medica Germanica*, vol. 31, no. 4, p. 569-581. [PMid:4781905](https://pubmed.ncbi.nlm.nih.gov/4781905/)
- Wang, Q., Chen, Y. J., Yoo, J. S., Kim, H. J., Cho, J. H., Kim, I. H. 2008. Effects of supplemental humic substances on growth performance, blood characteristics and meat quality in finishing pigs. *Livestock Science*, vol. 117, no. 2-3, p. 270-274. <https://doi.org/10.1016/j.livsci.2007.12.024>
- Zajác, P., Tomáška, M., Murárová, A., Čapla, J., Čurlej, J. 2012. Quality and safety of raw milk in Slovakia in 2011. *Potravinarstvo*, vol. 6, no. 2, 2012, p. 64-73. <https://doi.org/10.5219/189>
- Zajác, P., Čapla, J., Vietoris, V., Zubrická, S., Čurlej, J. 2015. Effects of storage on the major constituents of raw milk. *Potravinarstvo*, vol. 9, no. 1, 2015, p. 375-381. <https://doi.org/10.5219/518>

Acknowledgments:

Financial Support from The Ministry of Education, Youth and Sports of the Czech Republic (S grant of MSMT) is acknowledged. The authors would also like to thank to Mr. Matěj Přeslička and company ReConsulting a.s. for providing humates Humafit in this research and to Miss Adéla Kocmanová and Miss Barbora Petránková for chemical analyses of samples.

Contact address:

Miroslava Potůčková, Czech University of Life Sciences Prague, Faculty of Agrobiolgy, Food and Natural Resources, Department of Quality of Agricultural Products, Kamýcká 129, 165 00 Praha 6 – Suchdol, Czech Republic, mpotuckova@af.czu.cz

Lenka Kouřimská, Czech University of Life Sciences Prague, Faculty of Agrobiolgy, Food and Natural Resources, Department of Microbiology, Nutrition and Dietetics, Kamýcká 129, 165 00 Praha 6 – Suchdol, Czech Republic, kourimska@af.czu.cz

DETERMINATION OF TIN, CHROMIUM, CADMIUM AND LEAD IN CANNED FRUITS FROM THE CZECH MARKET

Pavel Diviš, Elena Šťábová, Jaromír Pořízka, Juliána Drábíková

ABSTRACT

The global production of metal cans is more than 300 billion cans. Benefits of metal packaging consist mainly from the great strength, excellent barrier properties and good thermal conductivity. The main problem of used metal packaging are the corrosion processes. The corrosion of metal container causes dissolution of tin which is used as a protective layer of the steel shell of the can and other metallic elements used in the manufacture of cans. In this work 31 samples of canned fruit was analysed and the concentration of tin, chromium, cadmium and lead was determined in fruit and in syrup using ICP-OES and ICP-MS techniques. The results showed no difference between the concentration of analysed elements in fruit and in syrup. In none of the analyzed samples the permitted maximum concentration of tin 200 mg.kg^{-1} was exceeded. Maximum concentration of tin was measured in canned greppfruit ($59.8 \pm 1.9 \text{ mg.kg}^{-1}$). The age of cans had no significant effect on the concentration of tin in canned fruit. The concentration of tin in fruit packaged in cans with protective layer of lacquer was significantly lower than the concentration of tin in fruit packaged in cans without protective layer of lacquer. Concentration of chromium, cadmium and lead in the analysed samples was very low at the natural levels of occurrence of these metals in fruit and it was impossible to determine unequivocally that the measured concentrations of these metals in canned fruit originate from the corrosion of can. The corrosion of the tinplate was studied using scanning electron microscopy with an energy dispersive spectrometer. By analyzing the SEM pictures and EDS spectra, critical areas of tin plate corrosion were observed. Based on the measured results it can be concluded that the consumption of fresh canned fruit is not a major problem for the inhabitants of the Czech Republic in terms of intake of potentially hazardous metals.

Keywords: corrosion; can; fruit; tin; spectrometry

INTRODUCTION

Metals are one of the most important packaging materials in food industry besides of plastics and paper. Properties for which the metal packaging's are used are mainly their strength, toughness, ductility and impermeability (Coles and Kirwan, 2011). The most important food packaging in the present time is can make from low carbon mild steel sheet. Practical use of cans as packaging is however limited by corrosion processes (Mannheim et al., 1983). To avoid corrosion the steel sheet is tinned. The tinplate surface consists of a large area of tin, tiny areas of tin-iron alloy and steel. According to the electrochemical laws, in aerated aqueous environment tin is noble to iron and the anodic corrosion of steel results in iron dissolving which may lead to perforation of the can (Robertson, 2005). In hermetically sealed can the food is deaerated and the headspace oxygen is limited. In anoxic conditions and in the present of citric acid, malic acid, tartaric acid, tannins and flavonoids, tin becomes the anode and protects the steel because of anodic dissolution of the tin (Robertson, 2005; Che et al., 2012). However the protective tin coating prevents damage to the packaging it causes dissolution of tin and other metallic elements such as zinc,

chromium, lead and cadmium to the inner contents of cans. The increase of these metals content in canned food poses a hazard of a chemical type. From this reason, in the European Union a limit of 200 mg.kg^{-1} of tin in canned food must be followed by food manufacturers (Council Directive 1881/2006/EC, 2006) amended by Commission regulation 629/2008/EC, 2008). Other metals having legislative limits in relation to food are lead and cadmium. The maximum allowable concentration of lead in fruits is 0.1 mg.kg^{-1} and 0.2 mg.kg^{-1} in berries. In fruit juices the maximum level of lead is 0.05 mg.kg^{-1} . The maximum allowable concentration of cadmium in fruits and vegetables is 0.05 mg.kg^{-1} (Council Directive 1881/2006/EC, 2006 amended by Commission regulation 629/2008/EC, 2008). These limits can be also applied on canned fruit. Concentration of chromium in foodstuff is not covered by the legislation. A parametric value of $50 \mu\text{g.L}^{-1}$ for total chromium in water intended for human consumption is laid down in Council Directive 98/83/EC, 1998.

The aim of this study was to determine the concentration of tin, chromium, cadmium and lead in canned fruits sold in the Czech Republic and to estimate the potential health

risk to residents of the Czech Republic associated with canned fruit consumption. Moreover, we tested two hypothesis. The first hypothesis consisted of fact that the concentration of tin in canned fruit is affected by the use of a lacquer layer and the second hypothesis consisted of fact that the concentration of tin in canned fruit depends on the time after manufacture.

MATERIAL AND METHODOLOGY

Samples were purchased in local stores in the city of Brno in February 2014 (Table 1). Each canned fruit sample was purchased in 2 pieces.

The amount of 5 g of canned fruit or syrup from the canned fruit was transferred into the 50 mL erlenmeyer flask and 10 mL of the mixture of nitric and hydrochloric acid (Analytika Praha, Czech republic, Analpure grade) was added. The sample was heated on the heating plate until its complete decomposition and then transferred to 25 mL volumetric flask and filled up to the mark with an ultrapure water. Both solid and liquid part of the sample was analysed separately. Each sample was analyzed 3 times.

Analysis of tin was performed on an ICP-OES (Ultima 2, Horiba Jobin Yvon, France) equipped with Mainhard type nebuliser and cyclonic spray chamber. The gas flow rate (Ar) was set to 13 L.min⁻¹ for cool gas, 0.2 L.min⁻¹ for auxiliary gas and 0.88 L.min⁻¹ for nebuliser gas. The radiofrequency power applied to the load coil was 1300 W. The instrument was calibrated using standard addition calibration methods. For the measuring wavelength 189.930 nm was used. The LOD of method used for the analysis was 0.024 mg.kg⁻¹ Sn. Extended uncertainty of measurement at a significance level of 95% with the extension coefficient $k = 2$ was 11%.

Analysis of chromium, cadmium and lead was carried out with a Thermo X-series quadrupole configuration ICP-MS with hexapole collision cell working on He/H mode (Thermo Fisher Scientific, Waltham, Massachusetts, USA). Instrument was equipped with an autosampler and MicroMist concentric nebulizer connected to Scott-type spray chamber. The gas flow rate (Ar) was set to 14 L.min⁻¹ for cool gas, 0.7 L.min⁻¹ for auxiliary gas and 0.9 L.min⁻¹ for nebuliser gas. The flow of collision cell gas was 5 mL.min⁻¹. The radiofrequency power applied to the load coil was 1300 W. Data were acquired by Plasma lab software (Thermo Fisher Scientific, USA). An internal standards ⁴⁵Sc and ¹¹⁵In (Analytika Praha, Czech republic) introduced to the plasma by Internal standard kit (Thermo Fisher Scientific, USA) were used for the drift corrections. Before the measurement on ICP-MS the instrument was optimized in order to increase the sensitivity on ⁵⁶Fe mass while maintaining oxide ratio for CeO/Ce <0.01. Flow of collision gas and collision cell setting was tuned for achieving <500 cps on mass 80. The standards of Fe and Ce were purchased by Analytika Praha. The LODs of the method used for the analysis were 0.002 mg.kg⁻¹ (Cr), 0.004 mg.kg⁻¹ (Cd) and 0.0003 mg.kg⁻¹ (Pb). Extended uncertainty of measurement at a significance level of 95% with the extension coefficient $k = 2$ was 6% for all elements.

For the surface analysis of tinplate scanning electron microscope (Zeiss EVO LS10, Germany) with an energy

dispersive spectrometer (Oxford Instruments XMAX 80mm, United Kingdom) was used.

Accuracy of the analytical methods used for the analysis was verified using recovery test. The liquid part of canned fruit was spiked by metals of interest and analysed. The recovery reached values from 94 to 102%.

All concentrations were expressed as the average of three independent measurements. The concentrations in mg.kg⁻¹ of fresh weight were calculated as $c_m = c_s \cdot V/m$, where c_m is the concentration of element of interest in mg.kg⁻¹, c_s is the concentration of element of the interest in the analysed solution (mg.L⁻¹), V is the volume of analysed solution (L) and m is the weight of the sample used for the analysis (kg). Obtained data were further analyzed with the XLStat (Addinsoft, USA) and Microsoft Excel software. Testing for significance of mean effects and interactions on all variables was calculated using ANOVA analysis of variance. Statistical significance was set at $p = 0.05$.

RESULTS AND DISCUSSION

Concentration of tin in canned fruit

Daily dietary tin intake of an adult is estimated to be about 4 mg. Canned fruits contributed more than 80% of the dietary intake of tin (EFSA, 2005). Tolerated daily dose of tin is not specified, however increased intake of tin in the diet leads to digestive problems, vomiting, headache, fever and other problems (Blunden and Wallace, 2003). The highest concentration of tin was measured in canned greppfruit (59.8 ± 1.9 mg.kg⁻¹) while the lowest in strawberry compote: 1.10 ± 0.12 mg.kg⁻¹ (Table 2). Except of one ananas compote sample and mandarine compote sample there was no statistically significant difference between the concentration of tin in solid and liquid part of the canned fruit samples ($F = 0.015 \leq F_c = 4.013$, data not shown) which is in contrast with results published by Trafandir et al. (2012). Results published by Mino (2006) are ambiguous as in some cases significant difference between the concentration of tin in syrup and in fruit was found, on the other side in some cases there was no significant difference. The concentration of tin in fruit packaged in cans with a protective layer of lacquer was statistically significantly different in comparison to the fruit packaged in tinned cans without protective layer of lacquer ($F = 37.696 > F_c = 4.149$). The average tin concentration in canned fruit was 1.91 mg.kg⁻¹ for cans with a protective layer of lacquer in contrast to 24.23 mg.kg⁻¹ in cans without a protective layer of lacquer. An average age of cans was 1.9 year. The oldest can was 3.1 year old, the latest one 1.0 year old. The age of can had no effect to the measured tin concentration in canned fruits ($p = 0.1590$). In some cans with older date of production lower concentration of tin in compote was found in comparison with cans of earlier date production. The pH value of syrup ranged between 3.15 and 3.98 and had no effect to the measured tin concentration in canned fruits ($p = 0.4509$). In none of the analyzed samples the maximum allowable concentration of tin 200 mg.kg⁻¹ was exceeded, however it must be mentioned that after opening the can the atmosphere in the can changes to aerobic from the anaerobic, which results in rapid dissolution of tin from the surface of the can (Knápek et al., 2009). For this reason, it

is not convenient to store the open canned fruit in the original package for an extended period of time and, if necessary, transfer it to plastic or glass container.

The data obtained in this study can be directly compared by data published by **Knápek et al. (2009)** who analysed tin in canned food from Czech market by AAS technique. The highest concentration of tin in canned fruit samples was similar as in the present study found by **Knápek et al. (2009)** in grapefruit compote (44.3 – 311 mg.kg⁻¹). **Knápek et al. (2009)** found also excessive amount of tin (in comparison with the permissible maximum limits) in some samples of peach compote (30.5 – 209 mg.kg⁻¹) and pineapple compote (24.1 – 238 mg.kg⁻¹). The concentration of tin in strawberry or raspberry compote found by **Knápek et al. (2009)** was low (<4 – 6 mg.kg⁻¹), similar as in the present study. Other works that deal with the determination of tin in canned fruit state the tin concentration in the range of 41 – 148 mg.kg⁻¹ (**Boutakhrif et al., 2011**) or 25 – 199 mg.kg⁻¹ (**Roncevic et al., 2012**).

The inner surface of the cans was analysed by scanning electron microscope with an energy spectrometer. On the picture 1 a surface of one tinplate without protective layer of lacquer is shown. Blackening of the tinplate and pitting corrosion of the tinplate is visible on different areas of the tinplate. The blackening of tinplate is caused by reaction of iron in tinplate and other fruit constituents like sulfur, phosphorous or oxygen and do not lead to the failure of the

container. More serious is the problem of pitting corrosion. The pitting corrosion is visible in area II on Figure 1. The measured spectra from the area II consists from large peaks of carbon and oxygen (Figure 2). These peaks indicate that the analysed tinplate could contain some residue of the food in the hole crated by process of pitting corrosion, even after cleaning of the tinplate. The spectra from the area I in the analysed tinplate contains no large peak of carbon and in contrast to the spectra from area II of analysed tinplate it contains higher intensity tin peaks (Figure 3). This testifies to the fact that the protective layer of lacquer in area II is damaged and dissolution of tin occurs here. For a comparison on the Figure 4 the surface of tinplate protected by yellow lacquer is shown. The measured spectra consists only from the peaks of oxygen and carbon and no tin or significant amount of iron is detected (Figure 5) indicating a perfect protective function of yellow lacquer against corrosion.

Concentration of chromium, cadmium and lead in canned food

At human dietary exposure levels chromium absorption is relatively low and depends on its valence state and ligands. Most of the ingested Cr(VI) is considered to be reduced in the stomach to Cr(III), which is poorly bioavailable and presents low ability to enter cells. In contrast to Cr(III), Cr(VI) is able to cross cellular

Table 1 Overview of analyzed samples and some basic parameters.

Sample	Tin plate protection	Manufacture date	Years after manufacture	pH
peach compote	tin side and bottom lacq. lid and seam	2013/01	1.1	3.86
peach compote	yellow lacquer	2012/10	1.3	3.94
peach compote	yellow lacquer	2012/04	1.5	3.83
peach compote	tin side and bottom lacq. lid and seam	2012/07	1.6	3.75
peach compote	tin side and bottom lacq. lid and seam	2012/08	1.6	3.72
peach compote	tin side and bottom lacq. lid and seam	n.a.	***	3.85
apricot compote	tin side and bottom lacq. lid and seam	2011/04	2.7	3.64
apricot compote	lacquered	2012/09	1.3	3.71
apricot compote	lacquered	2011/07	2.6	3.76
strawberry compote	lacquered	2012/03	1.8	3.52
strawberry compote	lacquered	2011/11	2.3	3.64
strawberry compote	lacquered	2012/03	1.9	3.80
strawberry compote	lacquered	2011/01	3.1	3.51
strawberry compote	lacquered	2012/06	1.7	3.68
strawberry compote	lacquered	2012/04	1.8	3.56
pineapples compote	tin side and bottom lacq. lid and seam	2012/09	1.3	3.96
pineapples compote	tin side and bottom lacq. lid and seam	2012/02	2.0	3.98
pineapples compote	tin side and bottom lacq. lid and seam	2012/10	1.3	3.87
pineapples compote	tin side and bottom lacq. lid and seam	n.a.	***	3.81
mandarin compote	tin side and bottom lacq. lid and seam	2011/09	2.4	3.61
mandarin compote	tin side and bottom lacq. lid and seam	2012/05	1.5	3.51
mandarin compote	tin side and bottom lacq. lid and seam	2012/07	1.6	3.93
mandarin compote	tin side and bottom lacq. lid and seam	2012/03	1.9	3.72
grapefruit compote	tin side and bottom lacq. lid and seam	2011/04	2.8	3.26
grapefruit compote	tin side and bottom lacq. lid and seam	2011/01	3.1	3.15
mango compote	lacquered	2011/09	2.4	3.65
mango compote	lacquered	2012/04	1.5	3.59
pear compote	tin side and bottom lacq. lid and seam	2013/02	1.0	3.52
pear compote	tin side and bottom lacq. lid and seam	2012/10	1.3	3.49
blueberry compote	white lacquer	2012/09	1.3	3.21
blackberry compote	white lacquer	2011/09	2.3	3.52

Table 2 Concentration of tin, chromium, cadmium and lead (mg.kg⁻¹) in analysed samples (fruit).

Sample	Sn	Cr	Cd	Pb
peach compote	12.49 ±0.11	0.012 ±0.006	0.009 ±0.003	0.0074 ±0.0012
peach compote	5.88 ±0.07	0.034 ±0.007	0.013 ±0.004	0.0041 ±0.0008
peach compote	1.69 ±0.03	0.025 ±0.005	0.008 ±0.003	0.0032 ±0.0005
peach compote	11.89 ±0.06	0.076 ±0.012	0.033 ±0.008	0.0099 ±0.0015
peach compote	19.33 ±0.09	0.085 ±0.015	0.019 ±0.005	0.0082 ±0.0017
peach compote	22.37 ±0.13	0.055 ±0.003	0.017 ±0.004	0.0054 ±0.0013
apricot compote	50.33 ±0.07	0.021 ±0.005	0.012 ±0.003	0.0076 ±0.0008
apricot compote	1.63 ±0.05	0.015 ±0.004	0.015 ±0.004	0.0027 ±0.0007
apricot compote	1.97 ±0.06	0.019 ±0.007	0.009 ±0.003	0.0015 ±0.0005
strawberry compote	1.62 ±0.04	0.013 ±0.004	0.014 ±0.005	0.0009 ±0.0003
strawberry compote	1.28 ±0.06	0.017 ±0.005	0.009 ±0.003	0.0012 ±0.0004
strawberry compote	1.11 ±0.12	0.018 ±0.004	0.012 ±0.005	0.0008 ±0.0003
strawberry compote	1.43 ±0.07	0.021 ±0.005	0.008 ±0.003	0.0011 ±0.0005
strawberry compote	1.19 ±0.05	0.023 ±0.003	0.013 ±0.004	0.0009 ±0.0005
strawberry compote	1.56 ±0.16	0.017 ±0.004	0.007 ±0.003	0.0013 ±0.0004
pineapples compote	21.58 ±0.14	0.072 ±0.012	0.022 ±0.007	0.0032 ±0.0011
pineapples compote	52.3 ±2.3	0.049 ±0.008	0.035 ±0.009	0.0024 ±0.0009
pineapples compote	19.2 ±0.5	0.028 ±0.005	0.014 ±0.004	0.0019 ±0.0008
pineapples compote	24.6 ±0.9	0.035 ±0.007	0.021 ±0.005	0.0027 ±0.0005
mandarin compote	22.3 ±0.5	0.016 ±0.006	0.029 ±0.007	0.0033 ±0.0007
mandarin compote	13.7 ±0.7	0.023 ±0.004	0.017 ±0.006	0.0027 ±0.0006
mandarin compote	16.5 ±0.3	0.018 ±0.005	0.031 ±0.008	0.0019 ±0.0003
mandarin compote	13.66 ±0.12	0.027 ±0.006	0.023 ±0.004	0.0036 ±0.0013
grapefruit compote	15.9 ±0.4	0.032 ±0.007	0.017 ±0.006	0.0028 ±0.0007
grapefruit compote	59.8 ±1.9	0.021 ±0.005	0.015 ±0.005	0.0019 ±0.0004
mango compote	1.83 ±0.06	0.018 ±0.004	0.008 ±0.004	0.0008 ±0.0005
mango compote	1.61 ±0.03	0.015 ±0.005	0.009 ±0.003	0.0011 ±0.0007
pear compote	23.5 ±0.3	0.028 ±0.003	0.013 ±0.005	0.0037 ±0.0009
pear compote	12.6 ±0.05	0.031 ±0.007	0.016 ±0.004	0.0018 ±0.0006
blueberry compote	2.07 ±0.04	0.012 ±0.004	0.007 ±0.003	0.0007 ±0.0003
blackberry compote	1.88 ±0.06	0.015 ±0.003	0.011 ±0.005	0.0009 ±0.0004

membranes. The acute toxicity of chromium(VI) is due to its strong oxidative properties. After it reaches the bloodstream, it damages blood cells by oxidation reactions. Some tinplates used for manufacturing cans may contain the thin chromium oxide film to prevent corrosion of the can. Maximum concentration of chromium in analysed samples was 0.085 ±0.015 mg.kg⁻¹. The average concentration was 0.029 mgkg⁻¹. The measured data are in accordance with the results published by **Jorhem and Slorlach (1987)** who determined the average concentration of chromium in fruit and vegetables packaged in lacquered

welded tinplate cans to be 0.018 mgkg⁻¹ and in unlacquered welded tinplate cans to be 0.091 mg.kg⁻¹.

The main toxic effect of cadmium is its toxicity to the kidney, although it has also been associated with lung damage and skeletal changes in occupationally exposed populations. The main source of cadmium in food is atmospheric deposition into the soil and crops or application of municipal sewage sludge to agricultural soil. Cadmium may be also present in the can as the impurity of materials used for making cans. Maximum concentration of cadmium in analysed samples was

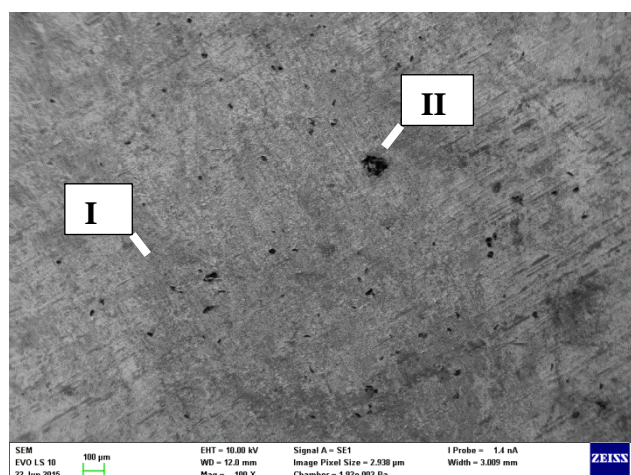

Figure 1 Picture of tinplate without protective lacquere taken by scanning electron microscope. Magnification = 100x.

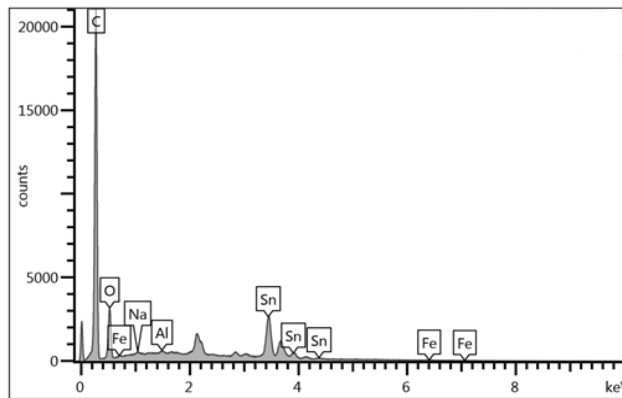

Figure 2 The EDS spectra of area II shown in Figure 1.

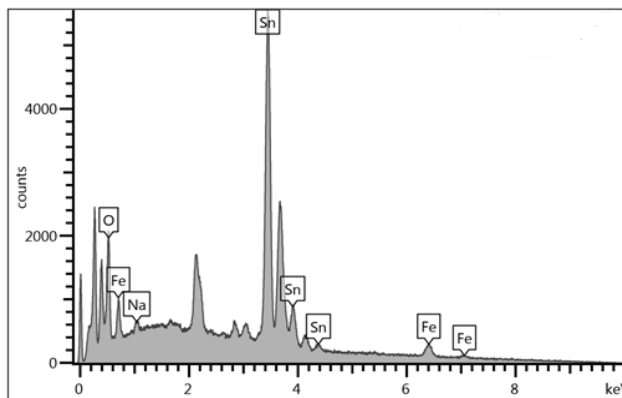

Figure 3 The EDS spectra of area I shown in Figure 1.

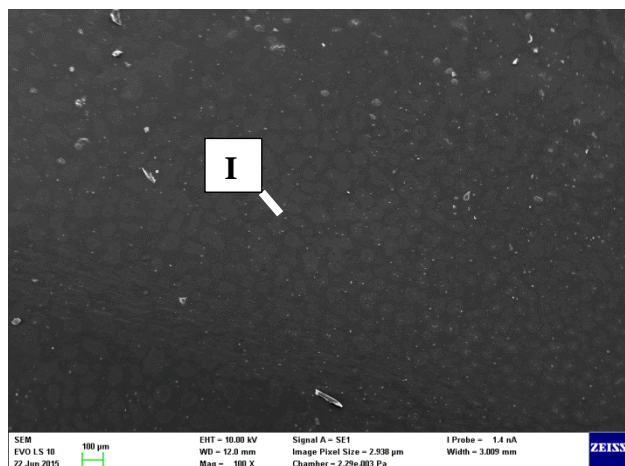

Figure 4 Picture of tinplate protected by yellow lacquer taken by scanning electron microscope. Magnification = 100x.

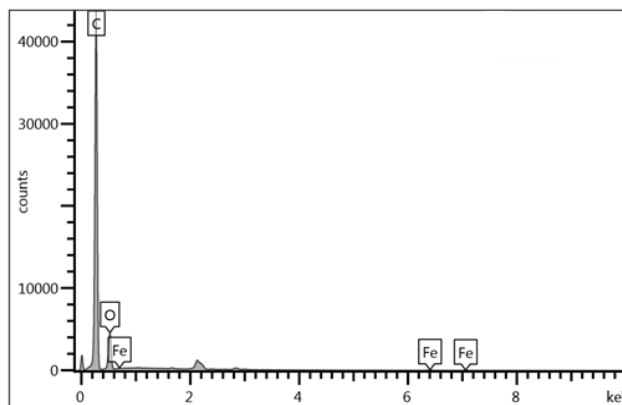

Figure 5 The EDS spectra of area I shown in Figure 4.

0.033 ±0.008 mg.kg⁻¹. The average concentration was 0.017 mg.kg⁻¹ which is under the maximum limit of 0.05 mg.kg⁻¹ set by EU. **Rafique et al. (2009)** analysed canned strawberry and pineapple from local markets of Pakistan. The concentration of cadmium in canned strawberry was 0.014 mg.kg⁻¹ and in canned pineapple 0.017 mg.kg⁻¹. **Jorhem and Slorlach (1987)** studied the concentration of cadmium in fruit and vegetables packaged in welded tinplate cans and they found the mean concentration of cadmium to be 0.004 mg.kg⁻¹ for foods in lacquered cans and 0.006 mg.kg⁻¹ for foods in un-lacquered cans.

Short-term exposure to high levels of lead can cause brain damage, paralysis, anaemia and gastrointestinal symptoms. Longer-term exposure can cause damage to the kidneys, reproductive and immune systems in addition to effects on the nervous system. The most critical effect of low-level lead exposure is on intellectual development in young children. The main source of lead in food is soil from which the lead may be taken up into plants or lead particles in air which can be deposited on the surface of leaves, stems and fruits. Important source of lead contamination is soldering in the canning process. The average concentration of lead in canned fruits was 0.003 mg.kg⁻¹ which is significantly lower concentration in comparison with results published by **Rafique et al. (2009)** or by **Jorhem and Slorlach (1987)** who determined the lead concentration in canned fruit in the range of 0.011 to 0.222 mg.kg⁻¹.

CONCLUSION

In none of the analyzed samples the maximum allowable concentration of tin 200 mg.kg⁻¹ was exceeded. The maximum measured concentration of tin was detected in greppfruit sample (59.8 ±1.9 mg.kg⁻¹). Concentration of chromium, cadmium and lead in the analysed samples was very low at the natural levels of occurrence of these metals in fruit and it was impossible to determine unequivocally that the measured concentrations of these metals in canned fruit originate from the corrosion of can. The measured results from ICP-OES and ICP-MS together with an analysis of SEM pictures and EDS spectra proved the perfect protective properties of lacquers used in tinplate cans against corrosion. No significant relationship was found between the age of the can and the tin concentration in the canned fruit (the age of the samples was 1 to 3 years). Based on the measured results it can be concluded that the consumption of canned fruit is not a major problem for the inhabitants of the Czech Republic in terms of intake of potentially hazardous metals.

REFERENCES

Blunden, S., Wallace, T. 2003. Tin in canned food: a review and understanding of occurrence and effect. *Food and Chemical Toxicology*, vol. 41, no. 12, p. 1651-1662. [https://doi.org/10.1016/S0278-6915\(03\)00217-5](https://doi.org/10.1016/S0278-6915(03)00217-5)

Boutakhrif, K., Crisci, M., Bolle, F., VanLoco, J. 2011. Comparison of four analytical techniques based on atomic spectrometry for the determination of the total tin in canned foodstuffs. *Food Additives and Contaminants: Part A*, vol. 28, no. 2, p. 173-179. <https://doi.org/10.1080/19440049.2010.544679> [PMid:21246429](https://pubmed.ncbi.nlm.nih.gov/21246429/)

Che, Y., Han, Z., Luo, B., Xia, D., Shi, J., Gao, Z., Wang, J. 2012. Corrosion Mechanism Differences of Tinplate in Aerated and Deaerated Citric Acid Solution. *International Journal of Electrochemical Science*, vol. 7, p.9997-10007.

Coles, R., Kirwan, M. 2011. *Food and beverage packaging technology*. 2nd ed. New Jersey, USA : Wiley-Blackwell. 344 p. ISBN-13: 978-1405189101.

Commission Regulation 629/2008/EC amending Regulation 1881/2006/EC setting maximum levels for certain contaminants in foodstuffs. *Official Journal of the European Communities L 173/6*.

Council Directive 1881/2006/EC setting maximum levels for certain contaminants in foodstuffs. *Official Journal of the European Communities, L 364/5*.

Council Directive 98/83/EC, 1998, on the quality of water intended for human consumption. *Official Journal of the European Communities, L 330/32*.

EFSA, 2005. Opinion of the Scientific Panel on Dietetic Products, Nutrition and Allergies on a request from the Commission related to the Tolerable Upper Intake Level of Tin [online] s.a. [cit. 2017-01-08] Available at: <http://www.efsa.europa.eu/en/efsajournal/pub/254>.

Jorhem, L., Slorach, S. 1987. Lead, chromium, tin, iron and cadmium in foods in welded cans. *Food Additives and Contaminants*, vol. 4, no. 3, p. 309-316. <https://doi.org/10.1080/02652038709373640> [PMid:3653455](https://pubmed.ncbi.nlm.nih.gov/3653455/)

Knápek, J., Herman, V., Buchtová, R., Vošmerová, D. 2009. Determination of tin in canned foods by atomic absorption spectrometry. *Czech Journal of Food Sciences*, vol. 21, special no., p. S407-S409.

Mannhaim, Ch., Passy, N., Brody, A.L. 1983. Internal corrosion and shelf life of food cans and methods of evaluation. *CRC Critical Reviews in Food Science and Nutrition*, vol. 17, no. 4, p. 371-407. <https://doi.org/10.1080/10408398209527354> [PMid:6759048](https://pubmed.ncbi.nlm.nih.gov/6759048/)

Mino, Y. 2006. Determination of tin in canned foods by X-ray fluorescence spectrometry. *Journal of Health Science*, vol. 52, no. 1, p. 67-72. <https://doi.org/10.1248/jhs.52.67>

Rafique, U., Iqbal, S., Faiz, S., Hashmi, A. 2009. Analysis of variation in concentration of essential and non essential elements in canned and fresh food. *Journal of Food Processing and Preservation*, vol. 33, no. 2, p. 186-203. <https://doi.org/10.1111/j.1745-4549.2008.00241.x>

Robertson, G. L. 2005. *Food packaging: Principles and practice*. 3rd ed. Boca Raton, USA : CRC Press. 733 p. ISBN-13: 978-1439862414.

Roncevic, S., Benutic, A., Nemet, I., Gabelica, B. 2012. Tin determination in canned fruits and vegetables by hydride generation inductively coupled plasma optical emission spectrometry. *International Journal of Analytical Chemistry*, vol. 2012, p. 1-7. <https://doi.org/10.1155/2012/376381> [PMid:22550488](https://pubmed.ncbi.nlm.nih.gov/22550488/)

Trandafir, I., Nour, V., Ionica, M. E. 2012. Determination of tin in canned foods by inductively coupled plasma mass spectrometry. *Polish Journal of Environmental Studies*, vol. 21, no. 3, p. 749-754.

Acknowledgments:

This work was financially supported by the project: Materials Research Centre at FCH BUT Sustainability and Development, REG LO1211, with financial support from the National Programme for Sustainability I (Ministry of Education, Youth and Sports) and by the specific research project FCH-S-16-3614.

Contact address:

Pavel Diviš, Brno University of Technology, Faculty of Chemistry, Department of Food Chemistry and Biotechnology & Materials Research Centre, Purkyňova 118, 612 00 Brno, Czech Republic, E-mail: divis@fch.vut.cz

Elena Šťávková, Brno University of Technology, Faculty of Chemistry, Department of Food Chemistry and Biotechnology, Purkyňova 118, 612 00 Brno, Czech Republic, E-mail: xcstavova@fch.vut.cz

Jaromír Pořízka, Brno University of Technology, Faculty of Chemistry, Department of Food Chemistry and Biotechnology & Materials Research Centre, Purkyňova 118, 612 00 Brno, Czech Republic, E-mail: xcporizkaj@fch.vut.cz

Juliána Drábiková, Brno University of Technology, Faculty of Chemistry, Materials Research Centre, Purkyňova 118, 612 00 Brno, Czech Republic, E-mail: xcdrabikovaj@fch.vut.cz

EFFECT OF THYME AND OREGANO AQUEOUS TEA INFUSIONS ON THE MICROBIOLOGICAL CHARACTERISTICS OF SAUSAGES

Miroslav Kročko, Viera Ducková, Margita Čanigová, Vladimíra Kňazovická, Zuzana Remeňová, Lenka Trembecká, Peter Haščík

ABSTRACT

In this work the antimicrobial effect of *Thymus vulgare* and *Origanum vulgare* aqueous tea infusion on the total mesophilic bacterial count (TVC), psychrotrophic bacteria count (PBC) and enterococci count in the heat treated meat product – sausages were evaluated. To prepare 1 kg of sausage in experimental groups were used 10 cm³ of *Thymus vulgare* resp. *Origanum vulgare* aqueous tea infusions. It was found that value of TVC and PBC in the experimental groups of sausages with *Thymus vulgare* addition after 7 days of storage (4 °C) were 2.78 resp. 2.14 log cfu.g⁻¹ and with the *Origanum vulgare* addition were 2.49 resp. 1.90 log cfu.g⁻¹. The value of TVC and PBC in the control group of sausage were 3.13 resp. 2.72 log cfu.g⁻¹. During 10 days of storage (4 °C) the TVC and PBC in the sausages with *Thymus vulgare* addition increase and reached the value 4.81 resp. 3.52 log cfu.g⁻¹. In the sausages with the *Origanum vulgare* addition TVC and PBC after 10 days of storage reached the value 3.67 resp. 1.60 log cfu.g⁻¹. The value of TVC and PBC in the control group of sausage after 10 days of storage were 6.47 resp. 5.47 log cfu.g⁻¹. Counts of enterococci in control and experimental groups of sausages during 10 days of storage were not detected. Thyme and origanum aqueous tea infusions suppressed the development of TVC and PBC compare to control samples.

Keywords: thyme; oregano; sausages; bacterial count; enterococci; psychrotrophic bacteria

INTRODUCTION

The possibility of compensation of synthetic antimicrobial and antioxidant compounds in animal husbandry as well as food production, with substances of plant or animal origin naturally occurring in the environment with a high content of bioactive substances has a world interest. Their impact is examined primarily in food to increase oxidative stability, inhibition of pathogenic and spoilage bacteria and improve their quality and safety with prologated period of consumption.

Raw meat can be easily contaminated by microorganisms and support the growth of pathogens, leading to serious food-borne illnesses. Refrigeration is the most common preservation method of raw meat and meat products. In order to extend the shelf life time of refrigerated storage, synthetic additives may be added to meat foods (Solomakos et al., 2008). Progress in a new data relating chemical additives with toxicological problems (Kaur and Kapoor, 2001) resulting in a tendency by the informed consumer to use natural food products. Many research groups are examining the chemical nature and activity of natural antimicrobials and antioxidants in fruits, vegetables, grains, herbs and other foods (Atoui et al., 2005; Gill and Holley, 2006).

Thyme (*Thymus vulgaris*) and origanum (*Origanum vulgare*) were often used in meat industry mainly as spices. Chemical analysis of thyme and oregano essential oils revealed the presence of more than 60 components which mainly thymol and carvacol are responsible for antibacterial effect against a board spectrum of gram-positive and gram-negative bacterial species (Gill and Holley, 2006).

The various thyme and origanum extracts were tested for the antioxidant and antimicrobial activity in the foods. In the *in vitro* studies were analyzed mainly ethanol extracts, acetone extracts, methanol extracts and hexane extracts (Ozen et al., 2011). Also were analyzed the edible coating or gelatin films from polysaccharides, proteins and lipids with thyme and origanum adding which can extend the shelf-life of meats, poultry and seafood (Gennadios et al., 1997; Gómez-Estaca et al., 2009; Min and Oh, 2009).

The main advantage of essential oils with antibacterial and antioxidant activity is that they can be used in any food and are generally recognized as safe (GRAS) (U.S Food and Drug Administration, 2006), as long as their maximum effects are attained with minimal change in the organoleptic properties of the food (Viuda-Martos, 2009). It is well known that potency of essential oil in food

system is generally reduced when compared to *in vitro* work, as the presence of fats, carbohydrates, proteins, salts and pH strongly influence the effectiveness of these agents (Burt, 2004).

The objective of this study was to examine antimicrobial activity of thyme and origanum aqueous tea infusions in pork sausages, to estimate their efficacy against to enterococci, mesophilic and psychrotrophic bacteria growth.

MATERIAL AND METHODOLOGY

Preparation of aqueous tea infusions

Dried origanum (*Origanum vulgare*) and thyme (*Thymus vulgare*) were purchased from a local store and kept in dark until the use. Aqueous extracts were prepared by one-step extraction with 3 g of each pulverized plants, placed in a flask with added 100 cm³ distilled water. The suspensions were incubated at 70 °C in water bath for 2 hours. After filtration through Whatman No. 4 the 10 cm³ of each aqueous extracts were used per 1kg of meat (Kulišić et al., 2007; Matsuura et al., 2003).

Preparation of meat products

The sausages were prepared from freshly boneless pork. Meat was from local abattoir approximately 24 h after slaughter. The pH value of pork was measured 45 min and 24 hours *post mortem* by pH apparatus Gryf 209L so as to avoid the purchase of PSE meat. The muscle was aseptically sliced and sausages were prepared using the following ingredients per 1kg of meat: 18 g of mixture sodium nitrite and sodium chloride, 1.5 g powdered black pepper (*Piper nigrum*), 1 g sweet pulverized paprika (*Capsicum annuum*), 0.2 g powdered nutmeg (*Myristica fragrans*), 0.2 g powdered allspice (*Pimenta officinalis*), 10 g cutter mix and 200 cm³ water. Following mincing, raw materials were assigned to one of six treatments. Control sausages (no added extracts); sausages with added 10 mL.kg⁻¹ thyme; sausage with added 10 and mL.kg⁻¹ origanum. The sliced meat with ingredients was fine chopped by bowl vertical cutter PSP 500 for 5 minutes. Mixing, filling and striking of sausage mixtures were carried out in aseptically conditions with minimal possibility of secondary contamination. Emulsified sausages were stuffed into polyamide casings (Ø 22mm), cold smoked for 4 hours and heat treated in water bath until the temperature in the center of sausages reached the value 70 °C for 10 min. The sausages were stored in air conditions at 4 ±1 °C and relative humidity 95% and evaluated for microbial growth on 1st, 7th, and 10th days.

Determination of antimicrobial activity

The samples of sausages (5 g) were taken after specified storage periods and homogenized in saline for 30 second by apparatus Heidolph DIAX 900. Mesophilic bacterial count, resp. total viable count (TVC) and count of psychrotrophic bacteria (PBC) were determined on diagnostic Plate count agar (*HiMedia*, India). Samples were incubated at temperature 30 ±1 °C for 72 ±2 h (TVC) and at the temperature 6.5 ±1 °C for 10 days (PBC).

The samples for enumeration of enterococci count were cultured on selective diagnostic Slanetz – Bartley agar at temperature 37 ±1 °C for 48 ±2 h (*Biokar Diagnostic*,

France). Microbial counts were transformed to log 10 cfu.g⁻¹.

Statistical analysis

The significance of differences among treatments at 1st, 7th, and 10th day of storage was determined by analysis of variance (ANOVA). Differences were considered significant at the *p* <0.05 level. The geomean and standard deviation of the difference was also calculated. The entire experiment was replicated three times.

RESULTS AND DISCUSSION

The TVC in sausages without added spices reached the value 3.00 ±0.25 log cfu.g⁻¹ after 24 hours of storage. The values of TVC in sausages treatment with spice aqueous tea infusions after 24 hours of storage were lower about 0.58 (thyme) resp. 0.96 (origanum) log cfu.g⁻¹ compared with control. Also it was found lower values of PBC in sausages with added thyme and origanum aqueous tea infusions compared with control (Figure 1). The differences between counts of bacteria in control and tested samples were after 24 hours and 7 days of chilling storage not significant (*p* >0.05). Slovak requirements not include the obligation to evaluate the count of mesophilic and bacteria in meat products. Nevertheless, in our opinion the enumeration of psychrotrophic bacteria is important especially in animal products stored at refrigeration temperatures. In matter of fact the group of psychrotrophic bacteria including mainly spoilage bacteria with proteolytic and lipolytic properties but also the pathogenic bacteria. Considering to their mentioned properties the psychrotrophic bacteria occurred in meat products represent one of the ultimate factors affected their shelf life during the chilling storage.

The TVC and PBC increased steadily during 10 days of storage in sausages treated with spice aqueous tea infusions and also in control. The highest increase of TVC and PBC were observed in sausages without spice treatment after 10 days of storage and reached the value 6.47 ±0.80 resp. 5.47 ±0.15 log cfu.g⁻¹. It was found statistically significant differences (*p* <0.05) in values of TVC and PBC between control and sausages treated with spice aqueous tea infusions. The TVC and PBC in sausages treated with thyme after 10 days of storage were lower about 1.66 respectively 1.95 log cfu.g⁻¹ (*p* <0.05) and in sausages treated with origanum were lower about 2.8 (for TVC) resp. 3.87 (for PBC) log cfu.g⁻¹ relative to control samples of sausages.

Occurrence of enterococci in tested and control sausages was not detected during of storage.

Discussed authors also found comparable results, however they tested the essential oils. Busatta et al. (2008) found that addition of *Origanum majorana* essential oil to fresh sausages exerted bactericidal effect but higher concentration of essential oil also caused alterations in the taste of product.

The Fratianni et al. (2010) found comparable results of TVC after chicken breast meat treatment by thyme essential oil. They reported that TVC of chicken breast meat with thyme treatment reached the value 2.9 x 10³ cfu.cm⁻³ and 4.4 x 10⁴ cfu.cm⁻³ after 7 resp. 21 days of storage. These results were significantly lower than those

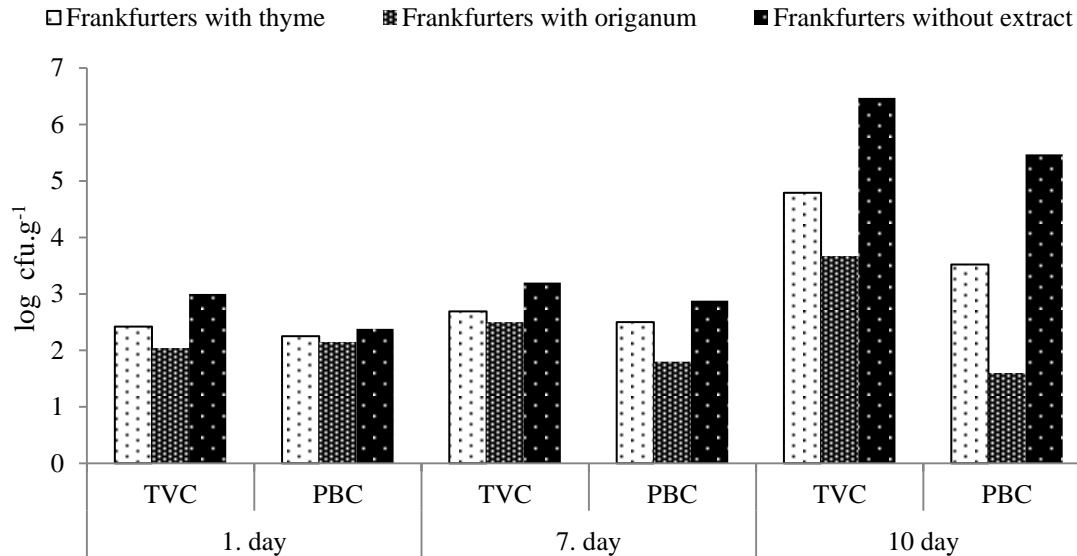

Figure 1 Total aerobic mesophilic bacterial count (TVC) and count of psychrotrophic bacteria (PBC) in tested sausages during 10 days of storage.

of the control sample after both 7 days (3.6×10^4 cfu.cm⁻³) and 21 days (3.6×10^4 cfu.cm⁻³) of storage at 4 °C. Also **Nessrien-Yasin and Abou-Taleb (2007)** treated the fish filets with 2.5% solution of thyme and origanum and found the decrease of TVC about more than 4 log cfu.g⁻¹ and PBC about more than 2 log cfu.g⁻¹ after 6 days of storage at 4 °C.

Tsigarida et al. (2000) reported a reduction of beef meat fillets microflora by 2 to 3 log cfu.g⁻¹ with the addition of 0.8% origanum essential oil after 7 days of storage. **Skandamis and Nychas (2001)** and **Chouliara et al. (2007)** also reported a suppression of TVC in poultry and minced meat when origanum oil was added.

CONCLUSION

Results obtained in this work indicated the technical viability of using the origanum and thyme aqueous tea infusions in relative low concentration, which is possible to enlarge the shelf-life of fresh sausages with the desired slight alteration of the original taste parameters. Results indicate that thyme and origanum aqueous tea infusions compare to essential oils can be cheaper alternative incorporate into pork sausages as natural antimicrobials.

REFERENCES

Atoui, A. K., Mansouri, A., Boskou, G., Kefalas, P. 2005. Tea and herbal infusions: their antioxidant activity and phenolic profile. *Food Chemistry*, vol. 89, no. 1, p. 27-36. <https://doi.org/10.1016/j.foodchem.2004.01.075>

Burt, S. 2004. Essential oils: their antibacterial properties and potential applications in foods. *International Journal of Food Microbiology*, vol. 94, no. 3, p. 223-253. <https://doi.org/10.1016/j.ijfoodmicro.2004.03.022> PMID:15246235

Busattaa, C., Vidala, R. S., Popiolskia, A. S., Mossia, A. J., Darivab, C., Rodriguesc M. R. A., Corazzaa, F. C., Corazzaa, M. L., Oliveiraa, J. V., Cansian, R. L. 2008. Application of *Origanum majorana* L. essential oil as an antimicrobial agent

in sausage. *Food Microbiology*, vol. 25, no. 1, p. 207-211. <https://doi.org/10.1016/j.fm.2007.07.003> PMID:17993397

Fратиани, F., De Martino, L., Melone, A. 2010. Preservation of chicken breast meat treated with thyme and balm essential oils. *Journal of Food Science*, vol. 75, no. 8, p. 528-535. <https://doi.org/10.1111/j.1750-3841.2010.01791.x> PMID:21535509

Gennadios, A., Hanna, M. A., Kurth, L. B. 1997. Application of Edible Coatings on Meats Poultry and Seafoods. *LWT – Food Science and Technology*, vol. 30, no. 4, p. 337-350. <https://doi.org/10.1006/fstl.1996.0202>

Gill, A. O., Holley, R. A. 2006. Disruption of *E. coli*, *Listeria monocytogenes* and *Lactobacillus sakei* cellular membranes by plant oil aromatics. *International Journal of Food Microbiology*, vol. 108, no. 1, p. 1-9. <https://doi.org/10.1016/j.ijfoodmicro.2005.10.009> PMID:16417936

Gómez-Estaca, J., Bravo, L., Gómez-Guillén, M. C., Alemán, A., Montero, P. 2009. Antioxidant properties of tuna-skin and bovine-hide gelatin films induced by the addition of oregano and rosemary extracts. *Food Chemistry*, vol. 112, no. 1, p. 18-25. <https://doi.org/10.1016/j.foodchem.2008.05.034>

Chouliara, E., Karatapanis, A., Savvaidis, I. N., Kontominas, M. G. 2007. Combined effect of oregano essential oil and modified atmosphere packaging on shelf life extension of fresh chicken breast meat, stored at 4 °C. *Food Microbiology*, vol. 24, no. 6, p. 607-617. <https://doi.org/10.1016/j.fm.2006.12.005> PMID:17418312

Kaur, C., Kapoor, H. C. 2001. Antioxidants in fruits and vegetables-the millennium's health. *International Journal of Food Science and Technology*, vol. 36, no. 7, p. 703-725. <https://doi.org/10.1046/j.1365-2621.2001.00513.x>

Kulišić, T., Dragović-Uzelac, V., Miloš, M. 2007. Antioxidant activity of aqueous tea infusions prepared from oregano, thyme and wild thyme. *Food Technology and Biotechnology*, vol. 44, no. 2, p. 485-492.

Matsuura, H., Chiji, H., Asakawa, C., Amano, M., Yoshihara, T., Mizutani, J. 2003. DPPH radical scavengers from dried leaves of oregano (*Origanum vulgare*). *Bioscience Biotechnology Biochemistry*, vol. 67, no. 11, p. 2311-2316. <https://doi.org/10.1271/bbb.67.2311>
PMid:14646188

Min, B. J., Oh, J. H. 2009. Antimicrobial activity of catfish gelatin coating containing origanum (*Thymus capitatus*) oil against gram-negative pathogenic bacteria. *Journal of Food Science*, vol. 74, no. 4, p. 143-148. <https://doi.org/10.1111/j.1750-3841.2009.01115.x>
PMid:19490330

Nessrien-Yasin, M. N., Abou-Taleb, M. 2007. Antioxidant and antimicrobial effects of marjoram and thyme in coated refrigerated semi fried mullet fish fillets. *World Journal of Dairy & Food Sciences*, vol. 2, no. 1, p. 1-9.

Ozen, T., Demirtas, I., Aksit, H. 2011. Determination of antioxidant activities of various extracts and essential oil compositions of *Thymus praecox subsp. skorpilii* var. *Skorpilii*. *Food Chemistry*, vol. 124, no. 1, p. 58-64. <https://doi.org/10.1016/j.foodchem.2010.05.103>

Skandamis, P., Nychas, G. E. J. 2001. Effect of oregano essential oil on microbiological and physico-chemical attributes of minced meat stored in air and modified atmospheres. *Journal of Applied Microbiology*, vol. 91, no. 6, p. 1011-1022. <https://doi.org/10.1046/j.1365-2672.2001.01467.x>
PMid:11851808

Solomakos, N., Govaris, A., Koidis, P., Botsoglou, N. 2008. The antimicrobial effect of thyme essential oil, nisin, and their combination against *Listeria monocytogenes* in minced beef during refrigerated storage. *Food Microbiology*, vol. 25, no. 1, p. 120-127. <https://doi.org/10.1016/j.fm.2007.07.002>
PMid:17993385

Tsagarida, E., Skandamis, P., Nychas, G. E. J. 2000. Behaviour of *Listeria monocytogenes* and autochthonous flora on meat stored under aerobic, vacuum and modified atmosphere packaging conditions with or without the presence of oregano essential oil at 5°C. *Journal of Applied Microbiology*, vol. 89, no. 6, p. 901-909. <https://doi.org/10.1046/j.1365-2672.2000.01170.x>
PMid:11123463

U.S Food and Drug Administration, 2014. Food additive status list [online] 2014-12-16 [cit. 2017-01-17] Available at: <https://www.fda.gov/food/ingredientspackaginglabeling/foodadditivesingredients/ucm091048.htm>

Viuda-Martos, M., Ruiz-Navajas, Y., Fernández-López, J., Pérez-Álvarez, J. A. 2009. Effect of adding citrus waste water, thyme and oregano essential oil on the chemical, physical and sensory characteristics of a bologna sausage. *Innovative Food Science and Emerging Technologies*, vol. 10, no. 4, p. 655-660. <https://doi.org/10.1016/j.ifset.2009.06.001>

Contact address:

Miroslav Kročko, Slovak University of Agriculture in Nitra, Faculty of Biotechnology and Food Sciences, Department for Evaluation and Processing of Animal Products, Tr. A. Hlinku 2, 949 76 Nitra, Slovakia, E-mail: mirokrocko@yahoo.com

Margita Čanigová, Slovak University of Agriculture in Nitra, Faculty of Biotechnology and Food Sciences, Department for Evaluation and Processing of Animal Products, Tr. A. Hlinku 2, 949 76 Nitra, Slovakia, E-mail: margita.canigova@yahoo.com

Viera Ducková, Slovak University of Agriculture in Nitra, Faculty of Biotechnology and Food Sciences, Department for Evaluation and Processing of Animal Products, Tr. A. Hlinku 2, 949 76 Nitra, Slovakia, E-mail: viera.duckova@uniag.sk

Vladimíra Kňazovická, Slovak University of Agriculture in Nitra, Faculty of Biotechnology and Food Sciences, Department for Evaluation and Processing of Animal Products, Tr. A. Hlinku 2, 949 76 Nitra, Slovakia, E-mail: vladimira.knazovicka@uniag.sk

Zuzana Remeňová, Slovak University of Agriculture in Nitra, Faculty of Biotechnology and Food Sciences, Department for Evaluation and Processing of Animal Products, Tr. A. Hlinku 2, 949 76 Nitra, Slovakia, E-mail: zuzana.remenova@uniag.sk

Lenka Trembecká, Slovak University of Agriculture in Nitra, Faculty of Biotechnology and Food Sciences, Department for Evaluation and Processing of Animal Products, Tr. A. Hlinku 2, 949 76 Nitra, Slovakia, E-mail: lenka.trembecka@uniag.sk

Peter Haščík, Slovak University of Agriculture in Nitra, Faculty of Biotechnology and Food Sciences, Department for Evaluation and Processing of Animal Products, Tr. A. Hlinku 2, 949 76 Nitra, Slovakia, E-mail: peter.hascik@uniag.sk

BIOLOGICAL EFFECT OF MAGNETIC FIELD ON THE FERMENTATION OF WINE

Jakub Dobšínský, Jaroslav Jedlička

ABSTRACT

During the transformation process of matter is produced energy, which afterwards interacts with matter itself, and other forms of energy. Energy induced electromagnetic appliances may affect the processes occurring in biological systems. In our study we have evaluated the wine fermentation process of the magnetic field with different amplitudes of electromagnetic induction, the constant exposure of 30 minutes a day for 10 days. The device for inducing magnetism was constructed at the Department of Fruit Growing, Viticulture and Enology at Slovak University of Agriculture in Nitra for research purposes. Essence of the device lies in the way of the management of direct current, which flows through the coil. Volume of direct current is regulated by network auto-transformer. Output of network autotransformer is rectified by two-way bridge rectifier. The coil is powered by a direct current voltage pulse. This device has a maximum value of the magnetic induction at 150 mT. At full power it must be supplied from three-phase socket with a rated current of 32 A. For our experiment, we chose wine grape variety of Hibernál, from Nitra wine region. The magnetic field induced by the electromagnetic device has an impact on the process of fermentation and sensory characteristics of a young wine. As part of the sensory profile, we noticed higher levels of residual sugar and speed up of the fermentation process and the process of purifying of the young wine. The influence of magnetic field on grape juice during the entire fermentation process and production of wine is a convenient way to improve the quality of wine without side effects or any chemical additives.

Keywords: wine; *Saccharomyces cerevisiae*; fermentation; magnetic field

INTRODUCTION

The low frequency magnetic field without thermal effect with a field strength of less than 0.1 mT induces a number of effects in cells and tissues (Blank, 1995; Goodman et al., 1995; Hong, 1995). Such effects include increased activity of the enzyme ornithine decarboxylase, Na, K-ATPase and cytochrome oxidase (Byus et al., 1988; Blank, 1995; Blank and Soo, 1998). Enhanced expression of genes which were exposed to the magnetic field indicates that the cells respond to the magnetism as the environmental stress (Goodman and Blank, 1995).

Non-thermal effects are given to do to long term treatment with weak fields. It is explain by the electromagnetic induction, with initiates formation of ion current in irradiated tissue. Biological properties of cell membranes (their permeability) and excitability are changing by influence of this ion current (Cabanová, 2004).

It is assumed, magnetic field at first induces the interaction with the cell membrane, which activates signalling pathways leading to the core, resulting in the synthesis of stress proteins. However, the cell membrane is the place of interaction with the magnetic field of the cell.

The increase in receptor binding and activation was established as well as the increased activity of membrane enzymes (Blank, 1995).

Other studies of cells and organisms interact with the magnetic field show the effect of the magnetic field on the cell metabolism. (Belyavskaya et al., 1992; Dardeniz et al., 2006). Anton-Leberre et al. (2009) prove no effect of magnetic field to yeast *Saccharomyces cerevisiae*, because of using strong static (up to 16 T for 8 h) and pulsed (up to 55 T single-shot and 4 x 20 T repeated shots) magnetic fields with are different conditions in experiment than we created.

MATERIAL AND METHODOLOGY

In the experiment, we focused on studying the influence of magnetic field on the fermentation of wine varieties Hibernál, from the harvest which was performed in 2016, by the yeast *Saccharomyces cerevisiae*. The grape juice, which was made out of this harvest contains 20.4 kg of sugar per one hectoliter. Grapes which have been used for this purpose came from Nitra wine region, directly from the botanical garden Slovak University of Agriculture. For the production of research sample were used healthy crops,

free from mold and other undesirable effects, so there was only minimal need for usage of sulfur.

Hibernal is an interspecific white wine grape variety, which was created by breeding varieties Seibel 7053 (Chancellor) x Riesling. The visual characteristics of this variety is defined as follows: medium-sized berry, yellow-red, medium length stems. The variety is very resistant to winter and spring frosts. From a sensory perspective, the wine from this variety has Riesling character, accompanied by subtle notes of savignon and pleasant acidity. Variety is suitable for the production of organic wine and aging in oak barrels. Character has taste characteristics of peach, grapefruit and citrus, also spicy notes.

The experiment was conducted in the laboratory, there were used three samples of the volume of 1.1 litres of fermentation wine, which were in the beginning of the fermentation exposed to electromagnetic field (EMF). Grape wine in the control sample for comparison of results was not exposed to EMF.

Electromagnetic induction coil used in our experiment was constructed by co-author of this research J. Jedlička. Induction coil internal diameter $2R = 55$ cm (Figure 1) generated the magnetic field by proposal of **Horák and Krupka (1976)** with relation to the solenoid.

Description of electromagnetic inductor

Electromagnetic inductor (coil), which we used in our experiments consists of the following components:

- Supply Network Driver,
- voltage transducer,
- The measurement of magnetic induction,
- leads with an induction coil,
- cylindrical induction coil.

The line voltage 230V --- Voltage Inverter --- magnetic induction meter --- Inductor

$$B = \frac{\mu_0 \mu_r I z}{\sqrt{l^2 + (2R)^2}}$$

Figure 1 Block diagram of the device

In which:

μ_0 = the permeability of free space $4\pi \cdot 10^{-7}$ [m.kg. p⁻².A⁻²],

μ_r = the relative permeability of the medium [-],

I = the electric current [A],

z = the number of turns of coil [-],

l = the length of coil [m],

R = the radius of the coil [m].

Experimental samples were magnetized by the aforementioned electromagnetic induction coil in the volume of the induction 10 mT, 40 mT, 100 mT and exposure for 30 minutes, five times a week for a total duration of 10 days. All options for the final fermentation and purification were bottled and stored in premises with a temperature of 13 °C.

Analysis of wines

The analysis was performed on the unit specialized for the analysis of wines FT / NIR spectrometer from Bruker Optics alpha wine analyser. Before analysing each variant was centrifuged to avoid measurement inaccuracies due to random impurities. The analysis of each variant was performed after completion of fermentation, individually for each sample, and the final value is the average of three single measurements.

Sensory evaluation

Sensory evaluation was performed by qualified and professional wine judges in accordance to the 100-point system of the International Union of Enologists (I.U.E.), in the total number of five persons. Lowest and highest value for each sample assessment were eliminated. Average values obtained from three evaluators were rounded to total numbers.

Statistical analysis

The data collected from the experiment was evaluated by our statistical method ANOVA (analysis of variance between groups).

RESULTS AND DISCUSSION

Analysis of the wine did not prove statistically significant differences in different versions in the amount of all acids or glycerol. The highest amount of alcohol was observed in the control sample – 10.93%, the other three variants had lower levels of alcohol what can be the result of increased value of the stress caused by the magnetic field. The lowest value of alcohol was recorded in experimental variant no. two (40 mT) – 10.5%. The most significant difference among the magnetized samples was noticed in sample no. two, which was exposed to the influence of the EMF of 40 mT strength. Fermentation stopped two days earlier, than in the other variants and began final

Table 1 The results of sensory analysis.

		1. variant 100 mT	2. variant 40 mT	3. variant 10 mT	4. control variant
Appearance	Clarity	5	5	5	5
	Colour	10	10	10	10
Fragrance	Intensity	7	6	7	7
	Softness	5	3	4	4
	Quality	12	11	12	12
Taste	Intensity	7	7	7	7
	Softness	5	4	5	4
	Quality	16	16	16	16
	Persistence	7	7	7	7
	general impression	10	9	10	10
	total points	84	79	83	82

Table 2 Analysis of the ingredients.

		1. variant 100 mT	2. variant 40 mT	3. variant 10 mT	4. control variant
Acetic acid	[g.L ⁻¹]	0.48	0.48	0.49	0.48
Citric acid	[g.L ⁻¹]	0.05	0.23	0.11	0.02
Malic acid	[g.L ⁻¹]	2.7	2.73	2.83	2.87
Tartaric acid	[g.L ⁻¹]	3.78	3.61	3.67	3.47
Lactic acid	[g.L ⁻¹]	0.71	0.57	0.66	0.74
Total acid	[g.L ⁻¹]	0.77	7.6	7.57	7.4
Density		0.995	0.996	0.995	0.995
Fructose	[g.L ⁻¹]	0.67	2.47	0.7	1.13
Glucose	[g.L ⁻¹]	1.3	1.13	1.4	1.2
Saccharose	[g.L ⁻¹]	0.5	0.6	0.3	0.4
Total sugar	[g.L ⁻¹]	1.43	3.17	1.4	1.77
Alcohol	[%]	10.67	10.5	10.77	10.93
Glycerol	[g.L ⁻¹]	5.93	5.87	5.93	5.7
pH		3.36	3.32	3.36	3.37

purification. Variant no. two (40 mT) was the purest of all samples, and by sensory analysis contained also the most of sugar. This argument was proved by the analysis of wine. Fructose content in variant no. two (40 mT) is 2.47 g.L⁻¹, which is the highest value. The lowest value of fructose was recorded in variant no. one (100 mT), 0.67 g.L⁻¹. Variant no. one (100 mT) completed its fermentation as the second, one day earlier than the control variant. As it is mentioned the total sugar content was highest in the variant no. two (40 mT) – 3.17 g.L⁻¹.

The best organoleptic characteristics of wine had the first experimental variant (100 mT), which was valued at an average of 84 points in total. The variant no. two was rated the lowest (40 mT), it received an average of 79 points.

The results of the experiment indicates, that the stress in a magnetic field of 40 mT, frequency of 50 Hz, and 30 minutes exposure for 10 days on the fermentation wine, induced change in the yeast *Saccharomyces cerevisiae* of their enzymatic activity in the processing of sugars into alcohol. Increased metabolism of yeast in the variant no.

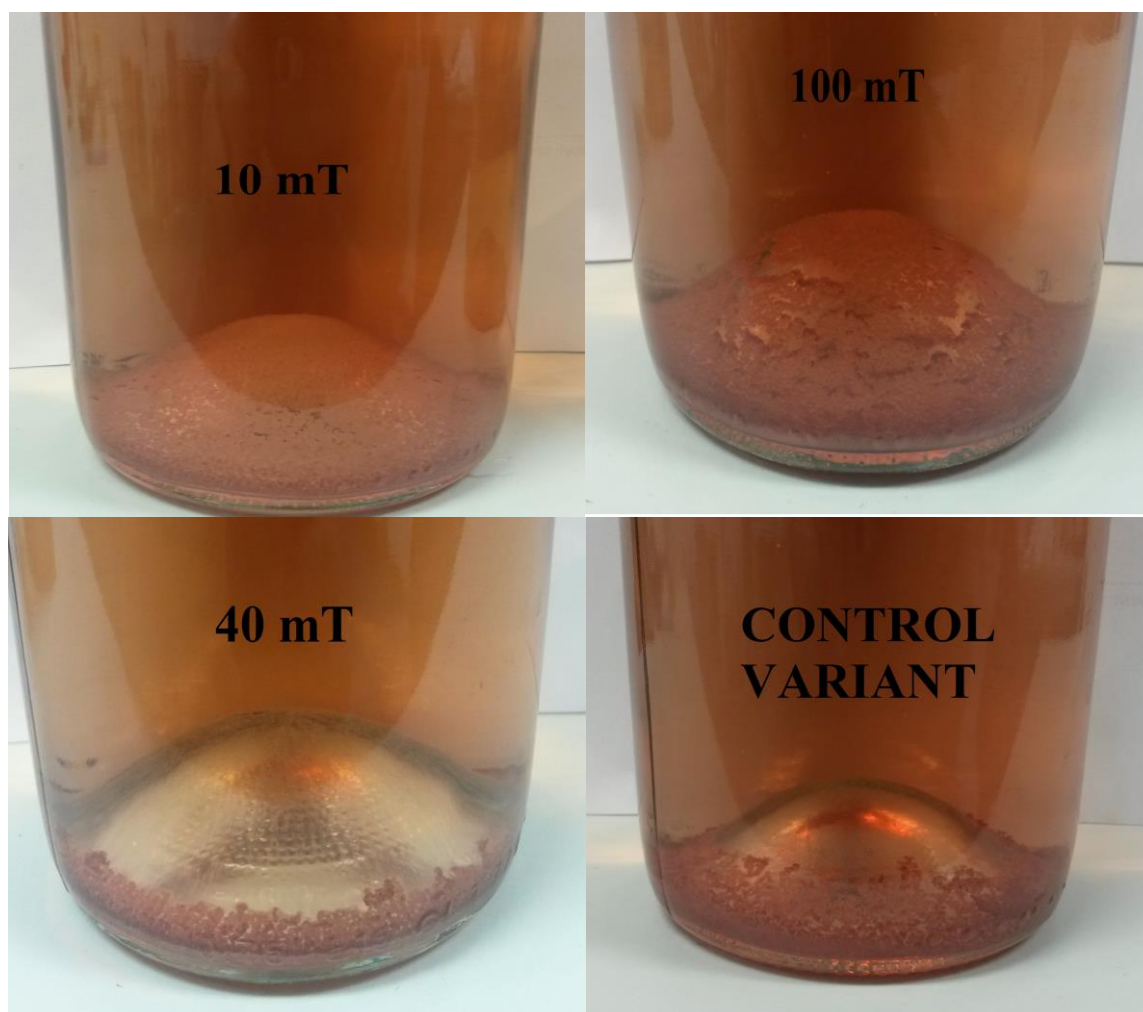

Figure 2 Differences in quantities of tartaric crystals at the bottom of bottles.

two (40 mT) and the change in the amount of each enzyme secreted led to increased metabolization of simple sugars and preferation glucose. It is necessary in the wine making process for the used yeast to prefer glucose over fructose, because fructose is for our palates sweeter. Accelerated metabolism caused a more rapid completion of the fermentation process by two days, in comparison to the other three variants, purification of the variant no. two (40 mT) was the fastest.

Rakoczy et al. (2016) exhibited yeast *Saccharomyces cerevisiae* to rotating magnetic field. The results of this study demonstrated change dynamic of growth, reducing the number of cells and cell metabolic activity of analyse yeast strains by the rotating magnetic field.

Low-frequency electromagnetic fields significantly affect the rate of biochemical oxidation – reduction reactions in used medium. Our research confirmed its positive impact on the relevant constituents and also on the sensory characteristics of the wine (**Ailer et al., 2013**).

Redox potential reflects the effect of different redox reactions in some point. Experiments have shown that the magnetic field can change the activity of certain enzymes, such as katalase, superoxidisedismutase, glutathionreductase, glutathiontransferase, peroxidase, ascobtát peroxidase or polyfenoloxidase. Experiments were conducted on cells of several plant species. Authors of this experiments are **Xia and Guo, 2000; Baby et al., 2011; Bhardwaj et al., 2012; Jouni et al., 2012; Radhakrishnan and Kumari, 2012; Radhakrishnan and Kumari, 2013; Shine et al., 2012; Serdyukov and Novitskii, 2013**. Results indicate that exposure of plants to magnetic field causes a change in enzymatic activities.

The magnetic field of 10 mT and the frequency of 50 Hz, influencing the yeast *Saccharomyces cerevisiae* for 24 min, reduces the yeast number in the colonies in and also slows their growth. Similar results were observed with *Escherichia coli*, *Stafilococcus aureus* and *Leclercia decarboxylata* (**Novak et al., 2005**).

The characteristic taste of wine is influenced by numerous factors. The most important of these factors is the grape variety and quality. Among other substantive additional factors, indicating the quality of crops, belong: the composition of soil, tillage, and the most important part is the way of processing of grapes and wine production techniques. During the aging of wine are made esters that contribute to the characteristic fruity odor of wine. Sensory characteristics of wine are significantly influenced by polyphenols. The final taste and aroma of the wine, is not relying only on the quantitative representation of individual substances, but also on their combination and interaction (**Harmatha, 2009**).

Measured differences in the content of certain substances in wine have repercussions on the overall taste profile of wine and were also encountered in sensory analysis. The observed differences in colour and clarity were among the only slight variants. The alcohol was in all variations in between 10% and 11%, and was not significant in the taste of the wine. Residual sugar, which was highest in variant no. two (40 mT), affects the taste of wine. After the final fermentation of residual sugar was evaluated positively, after one month aging at 13 °C the wine was warm and the smell less pronounced as confirmed by sensory analysis. Before sensory evaluation was recorded wine tartar at the

bottom of the bottles, in variants one and three (100 mT and 10 mT) was coated across the base of the bottle and in variant two and four (40 mT and the control variant) was tartaric less than half as much.

CONCLUSION

Low-frequency electromagnetic fields significantly affect the rate of alcoholic fermentation of yeast *Saccharomyces cerevisiae*, presumably by varying the amount of secreted enzymes to convert sugars into alcohol.

We achieved improvement in sensory characteristics of the wine. As the most suitable was manifested the magnetic field of 100 mT. Wine with influence of magnetic induction of 40 mT stopped fermentation earlier, but it is necessary to choose a more suitable way for preserving positive taste qualities. Application of a magnetic field in the fermentation of wine seems to be an appropriate mean to achieve a higher quality in young wines already, with this technology without any residues and adverse effects. Changes in content substances and positive impact on the organoleptic characteristics should not be reversible and short-term and therefore it is necessary to continue research and continuously monitor parameters of wine during its regular wine life. The need to continue in the research is not urged only because of the fermented wine, but also because of the behaviour of yeast in a magnetic field. For a better understanding of the effects of magnetic fields on the yeast we will continue its examination, especially on pure culture yeast in bigger number of samples.

REFERENCES

- Ailer, Š., Jedlička, J., Paulen, O. 2013. Biological effects of magnetic field on sensory profile and wine content (Biologické účinky magnetického poľa na senzoričný profil a obsahové látky vína). *Potravinárstvo*, vol. 7, special no., p. 138-145. Available at: http://www.potravinarstvo.com/dokumenty/mc_march_2013/bezpecnost_potravin_rastlinneho_povodu/ailer.pdf
- Anton-Leberre, V., Haanappel, E., Marsaud, N., Trouilh, L., Benbadis, L., Boucherie, H., Massou, S., François, J. M. 2009. Exposure to high static or pulsed magnetic fields does not affect cellular processes in the yeast *Saccharomyces cerevisiae*. *Bioelectromagnetics*, vol. 31, no. 1, p. 28-38.
- Baby, S. M., Narayanaswamy, G. K., Anand, A. 2011. Superoxide radical production and performance index of Photosystem II in leaves from magnetoprimed soy bean seeds. *Plant Signaling and Behavior*, vol. 6, no. 11, p. 1635-1637. <https://doi.org/10.4161/psb.6.11.17720>
- Belyavskaya, N. A. 2004. Biological effects due to weak magnetic field on plants. *Advances in Space Research*, vol. 34, no. 7, p. 1566-1574. <https://doi.org/10.1016/j.asr.2004.01.021>
- Bhardwaj, J., Anand, A., Nagarajan, S. 2012. Biochemical and biophysical changes associated with magnetopriming in germinating cucumber seeds. *Plant Physiology and Biochemistry*, no. 57, p. 67-73. <https://doi.org/10.1016/j.plaphy.2012.05.008>
- Blank, M. 1995. Na/K-Adenosine-Triphosphatase. *Advances in Chemistry*, vol. 250, p. 339-348. <https://doi.org/10.1021/ba-1995-0250.ch019>
- Blank, M., Soo, I. 1998. Enhancement of cytochrome oxidase activity in 60 Hz magnetic fields. *Bioelectrochemistry*

- and *Bioenergetics*, vol. 45, no. 2, 1998, p. 253-259. [https://doi.org/10.1016/S0302-4598\(98\)00086-5](https://doi.org/10.1016/S0302-4598(98)00086-5)
- Byus, C. V., Kartun, K., Pieper, S., Adey, W. R. 1998. Increased ornithine decarboxylase activity in Cultured cells exposed to low energy modulated microwave fields and phorbol ester tumor promoters. *Cancer Research*, vol 48, no. 15, p. 4222-4226.
- Cabanová, Z. 2004. Biological effects of electromagnetic field (Biologické účinky elektromagnetického poľa). *Advances in Electrical and Electronic Engineering*, vol. 3, no. 1, p. 24-29.
- Dardeníz, A., Tayyar, S., Yalcin, S. 2006. Influence of low frequency electromagnetic field on the vegetative growth of grape. *Journal Central European Agriculture*, vol. 7, no. 3, p. 389.
- Rakoczy, R., Konopacki, M., Fijalkowski, K. 2016. The influence of a ferrofluid in the presence of an external rotating magnetic field on the growth rate and cell metabolic activity of a wine yeast strain. *Biochemical Engineering Journal*, vol. 109, p. 43-50. <https://doi.org/10.1016/j.bej.2016.01.002>
- Goodman, R., Blank, M. 1995. Biosynthetic stress response in cell sex posed to electromagnetic fields. *Advances in Chemistry*, vol. 250, p. 423-436. <https://doi.org/10.1021/ba-1995-0250.ch023>
- Goodman, E. M., Greenebaum, B., Marron, M. T. 1995. Effects of electromagnetic fields on molecules and cells. *International Review of Cytology*, vol. 158, p. 238-279. [https://doi.org/10.1016/S0074-7696\(08\)62489-4](https://doi.org/10.1016/S0074-7696(08)62489-4)
- Harmatha, J. 2009. The quality of wine from the aspect of a chemist and sommelier (Kvalitavina z pohledu chemika a sommeliéra). In *Proceedings – Wine as a multicultural phenomenon (Vino jako multikulturní fenomén)*. Olomouc : Palacký University, Department of Philosophy, pp. 69-75.
- Hong, F. T. 1995. Magnetic field effects on biomolecules, cells and living organisms. *Biosystems*, vol. 36, no. 3, p. 187-229. [https://doi.org/10.1016/0303-2647\(95\)01555-Y](https://doi.org/10.1016/0303-2647(95)01555-Y)
- Horák, Z., Krupka, F. 1976. *Fyzika. Příručka pro vysoké školy technického směru*. 2nd ed. PRAHA : SNTL/ALFA. ISBN 04-011-76.
- Jouni, F. J., Abdolmaleki, P., Ghanati, F. 2012. Oxidative stress in broad bean (*Vicia faba* L.) induced by static magnetic field under natural radioactivity. *Mutation Research*, vol. 741, no. 1-2, p. 116-121. <https://doi.org/10.1016/j.mrgentox.2011.11.003>
- Novák, J., Strašák, L., Fojt, L., Slaninová, I., Vetterl, V. 2005. Effects of low-frequency magnetic fields on the viability of yeast *Saccharomyces cerevisiae*. *Bioelectrochemistry*, vol. 70, no. 1, p. 115-121. <https://doi.org/10.1016/j.bioelechem.2006.03.029>
- Radhakrishnan, R., Kumari, B. D. R. 2012. Pulsed magnetic field: a contemporary approach offers to enhance plant growth and yield of soy bean. *Plant Physiology and Biochemistry*, vol. 51, p. 139-144. <https://doi.org/10.1016/j.plaphy.2011.10.017>
- Radhakrishnan, R., Kumari, B. D. R. 2013. Influence of pulsed magnetic field on soy bean (*Glycine max* L.) seed germination, seed ling growth and soil microbial population. *Indian Journal of Biochemistry and Biophysics*, vol. 50, no. 4, p. 312-317.
- Serdyukov, Y., Novitskii, Y. I. 2013. Impact of weak permanent magnetic field on antioxidant enzyme activities in radish seed lings. *Russian Journal of Plant Physiology*, vol. 60, no. 1, p. 69-76. <https://doi.org/10.1134/S1021443713010068>
- Shine, M., Guruprasad, K., Anand, A. 2012. Effect of stationary magnetic field strengths of 150 and 200 mT on reactive oxygen species production in soybean. *Bioelectromagnetics*, vol. 33, no. 5, p. 428-437. <https://doi.org/10.1002/bem.21702> PMID:22253132
- Xia, L., Guo, J. 2000. Effect of magnetic field on peroxidase activation and isozyme in *Leymus chinensis*. *Ying Yong Sheng Tai Xue Bao*, no. 11, no. 5, p. 699-702.

Contact address:

Ing. Jakub Dobšínský, Slovak University of Agriculture, Horticulture and Landscape Engineering Faculty, Department of Fruit Growing, Viticulture and Enology, Tr. A. Hlinku 2, 949 76, Nitra Slovakia, E-mail: xdobsinsky@is.uniag.sk

doc. PaedDr. Ing. Jaroslav Jedlička, PhD., Slovak University of Agriculture, Horticulture and Landscape Engineering Faculty, Department of Fruit Growing, Viticulture and Enology, Tr. A. Hlinku 2, 949 76, Nitra Slovakia, E-mail: jaroslav.jedlicka@uniag.sk



AUTHENTICATION OF CAPRINE MILK AND CHEESE BY COMMERCIAL QPCR ASSAY

Tomáš Fekete, Marek Šnirc, Eubomír Belej, Radoslav Židek, Jozef Golian, Peter Haščík, Lucia Zeleňáková, Peter Zajác

ABSTRACT

The objective of the study was to investigate potential adulteration of commercial caprine milks and cheeses with bovine milk using commercial qPCR assay. The assay comprised of bovine-, ovine- and caprine-specific primers and TaqMan probe and mammalian internal control. Specificity, sensitivity, linearity, reproducibility and efficiency of the bovine assay were tested as well. Specificity was verified by running reaction on the DNA of other milk-producing species (caprine and ovine) and made-up bovine-caprine (v/v) milk mixes. In both experiments, a bovine DNA fragment was amplified whereas no amplification was obtained from the other species. Sensitivity, linearity, reproducibility and efficiency were tested on 10-fold dilution series of 10 ng bovine DNA. The assay has shown good linearity ($R^2 = 0.983$) within whole range, with efficiency of 86% and excellent reproducibility (SD around the C_T for the technical replicates <0.5). The sensitivity was adequate, as calculated LOD and LOQ were 1.44 pg and 2.94 pg of bovine DNA, respectively. Finally, the assay was used to authenticate 5 caprine milk samples and 5 caprine cheese samples, purchased from local supermarkets. Totally, 1 milk sample has shown the fluorescence signal, which exceeded baseline in cycle 39.01 ± 0.69 . However, the signal was above LOD and LOQ suggesting that there could not be unambiguously declared any adulteration with bovine milk. Amplification of bovine-specific DNA was not observed in the other samples indicating products were not adulterated. The commercial qPCR assay has proved that real-time PCR assays, as well as DNA-based techniques in a general, are the excellent and reliable tools for fighting with frauds in the food industry and protecting the public health.

Keywords: bovine; caprine; adulteration; qPCR

INTRODUCTION

Milk in its natural form has a high nutritive value as it is a one of the best sources of quality proteins, fats, carbohydrates, vitamins and minerals. It is easily digestible and hence is readily absorbed and thus is especially important for infants, nursing women, children and elderly people (Poonia et al., 2016; Azad and Ahmed, 2016; Barłowska et al., 2011).

Accounting for more than 80% of world milk production, bovine milk is the most universal raw material for processing, which is reflected in the broadest spectrum of manufactured products (Barłowska et al., 2011; Haug, Høstmark and Harstad, 2007).

Caprine milk is similar to bovine milk with around 87% water, 67% energy, 3.3% protein, 4.0% fat and 4.6% carbohydrates. Caprine milk differs from bovine and human milk in several ways, among them higher digestibility and lower lactose content. (Osman, Aradaib and Musa, 2013). The high dispersion state facilitates the digestion process of this milk and its products. Even though the nutrient contents in caprine milk are slightly

lower than those in bovine milk, its composition allows for a wide range of uses, such as consumption milk, and even to some extent as a therapeutical product (low content or lack of α_{s1} -casein) and most of all, as the raw material for dairy processing (Barłowska et al., 2011; Jung et al., 2011; Haenlein, 2004).

Milk and dairy product adulteration came into global concern after breakthrough of melamine contamination in Chinese infant milk products in 2008 (Azad and Ahmed, 2016). Identification of animal species origin in dairy products has become more and more important, with regard not only to accurate consumer information and legal aspects (e.g. labelling and guarantee requirements), but also to public health (bovine milk proteins are potential allergens, even if present in very low quantities) (Minimi et al., 2009; Zeleňáková et al., 2016). Moreover, bovine milk was reported as the main dairy product responsible for human adverse reaction (Osman, Aradaib and Musa, 2013).

In the production chain or during processing, there can be distinguished intentional or unintentional contamination

(Zhang et al., 2007). Regarding the former, undeclared bovine milk is frequently admixed with caprine and ovine milk during the manufacture of caprine and ovine cheeses, mainly due to the lower yield from goats and ewes, together with the much lower price of bovine milk (Klančnik et al., 2015). However, milk origin in the products can not be identified by the consumer. Moreover, they are sold at different prices under various product names (Kemal Seçkin, Yilmaz and Tosun, 2017).

Proving conclusively that adulteration or contamination has occurred requires the detection and quantification of food constituents. This can be difficult because the materials replaced are often biochemically very similar and food matrices are extremely complex and variable (Zhang et al., 2007). Poonia et al. (2016) and Azad and Ahmed (2016) reviewed numerous methods, based on electroimmigration, immunological reactions and chromatography, which have been used for of milk origin authentication in dairy products. The methods usually use lipids and proteins as a target analytes.

More recently, DNA molecules have received much attention and been the target compounds for species identification based on PCR because they are thermally more stable than lipids and proteins (Caldwell, 2017). Therefore, PCR-based methods have been designed and applied to dairy products for authenticating caprine milk. These methods can detect very small amounts of bovine milk in caprine milk (Kotowicz et al., 2007; Hutu et al., 2013). However, quantifying inability, inaccuracy and cross contamination have been suggested as the main disadvantages of end-point PCR. To overcome the limitations, several real-time PCR assays have been proposed to detect and quantify bovine milk in caprine cheese (Mininni et al., 2009) and in caprine milk (Jung et al., 2011). These studies showed that PCR-based methods have a potential in addressing food adulteration.

The study was aimed to test performance of bovine-specific TaqMan real-time PCR assay and to reveal potential adulteration of purchased caprine milks and cheeses.

MATERIAL AND METHODOLOGY

Sample preparation

Ultra-high-temperature processed commercial bovine (*Bos taurus*), caprine (*Capra hircus*) and ovine (*Ovis aries*) milks were purchased from several national food retailers in Nitra, Slovakia. Moreover, 5 UHT treated caprine milk samples (CM-1 – 5) and 5 caprine cheese samples (CCH-1 – 5) were randomly selected in market for authentication. Samples were transported to the laboratory and stored at 4 °C. Sensitivity, linearity, reproducibility and efficiency tests of the bovine qPCR assay were carried out with DNA extracted from bovine milk. Milk mixtures of bovine milk in caprine milk were prepared for further DNA extraction and assay specificity test. Five different mixtures, containing 50, 10, 5, 1, and 0.5% (v/v) bovine and caprine milks, were prepared in a final volume of 1 mL.

DNA extraction

DNA was extracted using the InnuPREP DNA Mini Kit (Analytik Jena, Jena, Germany) rendering an elution

volume of 250 µL DNA according to the manufacturer's instruction. DNA samples were quantified using the QuantiFluor dsDNA system (Promega) with Quantus™ Fluorometer (Promega).

Real-time PCR reaction

With the InnuDETECT Cheese Assay, bovine and caprine DNA were identified by using specific primers complementary to respective species. An internal positive control was incorporated in the InnuDETECT Cheese Assay kit. The internal control coamplified with the primers used for the qPCR reaction. PCR amplification was performed according to the manufacturer's recommendations by adding 10 µL 2x MasterMix, 3 µL Primer/Probe Mix bovine, 1 µL Internal control, 5 µL of sample and the mixture was filled up to 20 µL. Real-time qPCR assay was performed with a LightCycler (Roche, Germany) based on the TaqMan principle. Bovine and caprine DNA have been detected in separated tubes (FAM channel) in order to reach the maximum sensitivity. Internal Control was used as an amplification control (HEX channel). Real-time PCR cycling parameters were optimised based on manufacturer's manual: Initial denaturation 95 °C, 120 s, followed by 40 cycles of 95 °C, 10 s of denaturation, 62 °C 45s of annealing/elongation and finally, absolute quantification analysis. All reactions were run in triplicate. In qPCR, 10 ng of bovine DNA was considered as 100% bovine milk. Amount of amplified DNA, isolated from bovine-caprine milk mixtures, commercial caprine milks and cheeses, corresponded to ~10 ng DNA as well.

Data analysis

Primary real-time PCR data were analysed by the LightCycler Software 4.1.1.21 (Roche, Germany) and the threshold cycle (C_T) was calculated. C_T values of standard curve replicates (Y) and \log_{10} (DNA amount) (X) were analysed using XLSTAT (Addinsoft, 2016) software and a linear regression equation of the C_T value plotted against the \log_{10} (DNA amount) was calculated. The total DNA in prepared milk mixtures was estimated using the model. Limit of detection (LOD) and limit of quantification (LOQ) was calculated.

RESULTS AND DISCUSSION

DNA extracted from a sample of 100% bovine milk was used for the sensitivity and efficiency determination of the TaqMan real-time PCR assay. Linear range of positive amplification for the bovine milk assay was achieved over five log units, which extended from 10 ng to 0.001 ng bovine DNA (Figure 1, Table1).

Sensitivity

Parameters of the model for linear detection and quantification range are shown in Table 2. The assay showed good linearity, with correlation coefficient of $R^2 = 0.983$ and efficiency of 86%. The LOD and LOQ were 1.44 pg and 2.94 pg, respectively. This corresponded to cut-off in C_T of 37.80 and 36.64, respectively.

Table 2 Parameters of the model.

Source	Value	95% CI Value	Standard error	t	Pr > t
Intercept	27.214	26.708, 27.720	0.234	116.272	<0.01
Slope	-3.724	-4.016, -3.432	0.135	-27.558	<0.01

Specificity

Detection system was tested for its selectivity and cross-reactions to other milk-producing species. The bovine-specific system amplified fragment from bovine DNA whereas no amplification was obtained from ovine and caprine DNA. The internal control amplified fragment from different mammalian species (cow, sheep and goat), with similar C_T values.

Quantification of bovine DNA in milk mixtures and cheeses

Table 3 summarises mean $C_T \pm SD$ values and mean bovine DNA in target matrixes as predicted by linear regression model. Detection of bovine DNA in milk mixtures was achieved even in samples containing 0.5% of bovine milk. Totally, in 1 caprine milk sample (CM-3), a bovine-specific signal was observed after 40th cycle. Since LOD and LOQ were defined, C_T values above these limits were considered as either non-specific amplification or possible amplification of bovine trace DNA due to the accidental contamination during manufacturing. Amplification of bovine-specific DNA was not observed in the other samples suggesting products were not adulterated.

Molecular techniques using DNA technology to combat fraud, improve traceability and distinguish between closely related species are being increasingly utilised in food

forensic analysis (Caldwell, 2017).

The PCR assays rely on the amplification of known DNA sequences. Conventional end-point PCR utilise agarose gels to identify targets via fragment length. In PCR-RFLP technique, DNA is amplified and then cut into smaller fragments using restriction enzymes (Caldwell, 2017).

During last decade, end-point PCR and PCR-RFLP was widely used for milk species identification in dairy products. Branciari et al. (2000) used PCR-RFLP of cytochrome b (cyt-b) gene to investigate the adulteration rate of feta cheeses, made from mixture of ovine and caprine milk, with less expensive bovine milk. The restriction enzymes *HaeIII* and *Sau3AI* differentiated DNA of bovine, ovine, and caprine milk. The LOD of undeclared milk admixture was about 1%.

Bottero et al. (2003) developed end-point PCR-RFLP, based on mt12S and mt16S rRNA, for simultaneous detection of bovine, ovine and caprine milk in dairy products. In total, 19 cheeses from the retail trade were analysed, of which fifteen samples confirmed the information given by labelling, while four did not. The LOD of caprine DNA was 0.125 ng in mixture of all three species DNA. Regarding the bovine milk addition to caprine milk, LOD was 0.5% (v/v).

Lanzilao et al. (2005) developed PCR-RFLP method, targeting t cyt-b gene, for the identification of the 4 animal species of main interest in the dairy industry (cow, sheep,

Table 1 Sensitivity of bovine-specific assay.

Dilution (%)	DNA amount (ng)	$\log_{10}(\text{DNA amount})$	Mean $C_T \pm SD$
100	10	1.00	23.36 \pm 0.23
10	1	0.00	26.54 \pm 0.08
1	0.1	-1.00	32.09 \pm 0.37
0.1	0.01	-2.00	34.90 \pm 0.16
0.01	0.001	-3.00	37.80 \pm 0.21

Regression of C_T by $\log_{10}(\text{DNA})$ ($R^2 = 0.983$)

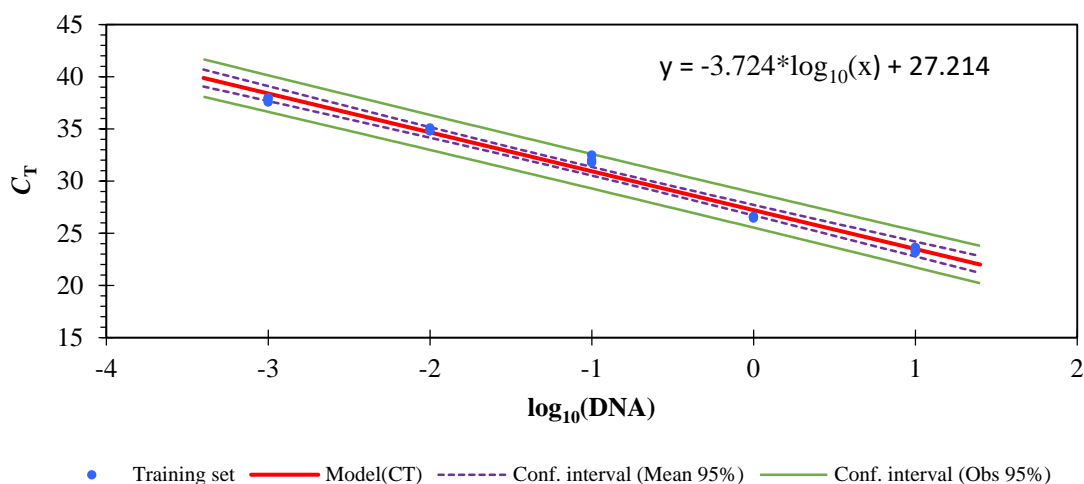

Figure 1 Linear range of detection and quantification of the bovine qPCR assay.

goat and buffalo). The comparative analysis of the 92 cyt-b sequences belonging to the 4 species allowed identification of 2 highly conserved regions, which were used to design 2 universal primers for the PCR amplification of cyt-b gene. The *in silico* analysis allowed identification of a set of species-specific restriction endonucleases (*Hae*III, *Taq*I, and *Mwo*I), which generated easily analysable species-specific restriction profiles of amplified cyt-b gene. The system was developed for both purified DNA and DNA extracted from meat or dairy products and finally tested on mixed samples, indicating its applicability to foodstuffs.

Due to the pattern overlapping, some studies reported ambiguous species identification. For this reason, species-specific end-point PCR has been proposed by several authors. For instance, **Maudet and Taberlet (2001)** suggested singleplex end-point PCR for detecting bovine milk in caprine cheese. Targeting the bovine-specific deletions of D-loop (cyt-b), it was possible to design bovine-specific primers and to identify the presence of less than 0.1% (w/w) of bovine milk in model mixture cheeses. In addition, the analysis of an agarose gel digital image allowed a rough estimation of the percentage of bovine milk used in adulteration.

Maudet and Taberlet (2002) applied end-point PCR detection of Prim'Holstein's milk, a *Bos taurus* breed not allowed for cheese making of some French cheeses (e.g. Reblochon, Abondance and Beaufort). The design of species-specific primers targeting the mt12 S rRNA gene enabled the specific detection of bovine milk in ovine and caprine milk mixtures.

López-Calleja et al. (2004) developed end-point PCR assay for specific identification of bovine milk in ovine and caprine milk by using forward primer targeting conserved region of mt12S rRNA gene along with a reverse primer specific for *Bos taurus*. The technique was applied to raw, pasteurised, and sterilised bovine-ovine and bovine-caprine binary milk mixtures, enabling the

specific detection of bovine milk, with LOD of 0.1% (v/v).

Cheng, Chen and Weng (2006) used primers targeting highly conserved regions in bovine mtDNA to reveal adulteration of caprine milk with bovine milk through end-point PCR. Random sampling of different brands of caprine milk powder and tablets showed that 25% of caprine powders and 50% of caprine milk tablets were adulterated. Using the assay, as low as 0.1% (v/v) of bovine milk in caprine milk could be identified.

Besides, in a more advanced PCR format, duplex PCR using two pairs of primers targeting mtD-loop region, has also been successfully used to identify up to 1% bovine milk in the caprine milk. A total of 54 milk samples were examined. In 33 samples, the bovine DNA was detected, while 21 samples produced the caprine-specific amplicon only (**Kotowich, Adamczyk and Bania, 2007**).

Similarly, a duplex PCR has been applied by **Mafra et al. (2007)** for the detection of both bovine and caprine milk in caprine milk cheeses using primers targeting the mt12S rRNA genes. It was possible to quantify cheese adulteration with bovine milk in the range of 1% – 60% (w/w). The duplex PCR technique allowed the detection of 0.1% (w/w) of bovine milk in caprine milk cheese. The proposed method was successfully applied to cheeses with defined amounts of bovine milk and commercial cheese samples. The results showed the fraudulent addition of bovine milk in three samples labelled as pure caprine milk cheeses and the omission of caprine milk mentioned on the label of two cheeses containing mixed milk.

Gonçalves et al. (2012) presented quadruplex PCR of species-specific mtDNA targets followed by fragment size analysis by capillary electrophoresis enabling detection of at least 1% (v/v) relative proportion of bovine, ovine, caprine and buffalo milk in binary mixtures.

More recently, **Hutu et al. (2013)** used two pairs of primers targeting mt12s rRNA gene to detect and quantify the percentage of bovine milk adulteration in products

Table 3 Mean $C_T \pm SD$ values mean bovine DNA in target matrixes (bovine-caprine milk mixtures, commercial caprine milks and cheeses) as predicted by the model.

Target matrix	Mean bovine $C_T \pm SD$	Mean bovine DNA (95% CI) (ng)
B/C-50% (v/v)	27.96 \pm 0.30	0.61 [0.46, 0.82]
B/C-10% (v/v)	30.71 \pm 0.21	0.12 [0.09, 0.15]
B/C-5% (v/v)	32.44 \pm 0.12	0.04 [0.03, 0.05]
B/C-1% (v/v)	35.55 \pm 0.17	6.06 x 10 ⁻³ [4.33 x 10 ⁻³ , 8.47 x 10 ⁻³]
B/C-0.5% (v/v)	37.40 \pm 0.24	1.97 x 10 ⁻³ [1.32 x 10 ⁻³ , 2.93 x 10 ⁻³]
CM-1	ND	-
CM-2	ND	-
CM-3	39.01 \pm 0.69	-
CM-4	ND	-
CM-5	ND	-
CCH-1	ND	-
CCH-2	ND	-
CCH-3	ND	-
CCH-4	ND	-
CCH-5	ND	-

Note: ND: not detected.

labelled as caprine milk or bovine-caprine mixture products. The method was validated on 10 standard cheeses: two for each species and eight products with mixed milk, containing different proportions (0.1% – 50% (w/w)) of bovine and caprine milk.

Unlike the end-point PCR, real time PCR utilise fluorescent signal to identify target via threshold cycle (C_T) (Caldwell, 2017).

Zhang et al. (2007) conducted TaqMan real-time PCR assay using a bovine-specific primer pair for the cyt-b gene and mammalian-specific cyt-b probe. LOD of the assay was <35 pg of bovine DNA and showed no cross-reaction with ovine, caprine or porcine DNA. The system has been successfully used to measure bovine DNA in fresh and processed meat, milk and cheese, and would be useful for bovine species identification and quantitative authentication of animal-derived products.

In the study of Mininni et al. (2009), a TaqMan real-time PCR assay was developed to detect and quantify bovine milk in caprine and ovine cheeses, based on two target genes. The cyt-b gene of *Bos taurus* was used to detect and quantify bovine DNA. The nuclear gene Myo, mt18S rRNA and mt16S rRNA were used alternatively as universal reference markers. Caprine (n = 30) and ovine (n = 51) cheese samples were purchased and analysed and most were shown to be contaminated by bovine milk. Regarding the sensitivity, LOD of cyt-b assay for bovine DNA corresponded to 0.2% (w/w) of bovine for standard caprine and ovine cheeses. Next, LOD of 16S assay for bovine DNA corresponded to 0.5% (w/w) for ovine cheese, the 0.5% (w/w) for ovine cheese obtained by the 16S assay, the 1% (w/w) for the 16S assay in caprine cheese. LOQ of Myo and 18S assays were 1% (w/w) for both species.

Rentsch et al. (2012) developed and interlaboratory validated two multiplex TaqMan real-time PCR assays to determine DNA of bovine, ovine and caprine in milk and cheese. For caprine DNA, milk and cheese assays showed amplification efficiency of 85% and 116%, respectively. Linear detection and quantification range was 0.32 – 32 ng of caprine DNA ($R^2 = 0.99$) of the total DNA in both assays.

Agrimonti et al. (2015) described a unique quadruplex SYBR Green real-time PCR platform for the simultaneous detection of milk ingredients (bovine, buffalo, ovine, goat) in dairy products and for quantification of bovine milk in the same products. The methodology enabled the detection of DNA from *Bos taurus* in mixes of milk and cheeses with a LOD = 0.1%. A good correlation ($R^2 > 0.9$) between peaks' area of derivative of melting curves of amplicons and percentages of bovine milk in bovine-caprine milk mixtures and bovine-caprine cheeses, allowed for an estimation of bovine DNA in a dynamic range 0.1 – 10% and 0.1 – 5%, respectively.

Di Domenico et al. (2017) developed and validated 4 TaqMan real-time PCR assays for species identification in dairy products. Totally, 18 commercial samples were analysed. Moreover, the authors were first who confirmed analysis of the samples by IEF, the official European Union reference method. The PCR assays were based on the amplification of a short sequence of mt12S rRNA or cyt-b. The analysis conducted on milk mixtures at the 1% level showed C_T values within the range of linearity

($R^2 \geq 0.99$) of the standard curve for every species tested. Amplification efficiency for all species was $\geq 96\%$. The method revealed a very high level of repeatability. For each assay, DNA from the other species was tested as non-target DNA, using the same amount, and no cross-amplifications were observed. The LOD was 25 pg for bovine, 19 pg for buffalo, 2.5 pg for ovine and 350 fg for caprine, which corresponded to 0.5% (v/v) of bovine, <0.5% (v/v) of buffalo, 0.05% (v/v) of ovine and <0.05% (v/v) of caprine milk admixture.

The milk can be used as a source of DNA because it contains many somatic cells, mostly leucocytes but also epithelial cells from the animal (Sakaridis et al., 2013). Due to the fact that each somatic cell has several copies of mitochondrial DNA and as there are approximately 1000 mitochondria in each somatic cell, there should be expected sensitive detection of milk species (Klančnik et al., 2015). Besides, short amplicons enhance the possibility of amplification in dairy products that have undergone intense treatments such as pasteurization, UHT treatment, rennet or acid coagulation, drying, fermentation, ripening, smoking, high pressure treatment, pH modification, and irradiation (Di Domenico et al., 2017). Nevertheless, accurate quantitative determination of different milk percentages in milk mixtures and cheeses is still problematic. Since DNA is derived from somatic cells that can vary depending on physiological and non-physiological (e.g. mastitis) levels and because several factors in cheese technology may influence the final DNA concentration, DNA-based methods can only provide approximate values (Di Domenico et al., 2017).

CONCLUSION

Adulteration of milk and dairy products is being serious issue not only from economic aspect but also consumer health. To ensure that products meet strict legislation criteria and to avoid adulteration, reliable assays should be used in routine. The commercial assay tested in the study has proved that real-time PCR is accurate and sensitive tool, which has the good potential to reveal adulteration. Taking into account the facts, qPCR-based techniques should be used for semi-quantitative purposes only.

REFERENCES

- Agrimonti, C., Pironcini, A., Marmiroli, M., Marmiroli, N. 2015. A quadruplex PCR (qPCR) assay for adulteration in dairy products. *Food Chemistry*, vol. 187, p. 58-64. <https://doi.org/10.1016/j.foodchem.2015.04.017>
- Azad, T., Ahmed, S. 2016. Common milk adulteration and their detection techniques. *International Journal Of Food Contamination*, vol. 3, no. 1, p. 22. <https://doi.org/10.1186/s40550-016-0045-3>
- Barłowska, J., Szwałkowska, M., Litwińczuk, Z., Król, J. 2011. Nutritional Value and Technological Suitability of Milk from Various Animal Species Used for Dairy Production. *Comprehensive Reviews In Food Science And Food Safety*, vol. 10, no. 6, p. 291-302. <https://doi.org/10.1111/j.1541-4337.2011.00163.x>
- Bottero, M., Civera, T., Nucera, D., Rosati, S., Sacchi, P., Turi, R. 2003. A multiplex polymerase chain reaction for the identification of cows', goats' and sheep's milk in dairy products. *International Dairy Journal*, vol. 13, no. 4, p. 277-282. [https://doi.org/10.1016/S0958-6946\(02\)00170-X](https://doi.org/10.1016/S0958-6946(02)00170-X)

- Branciar, R., Nijman, I., Plas, M., Di Antonio, E., Lenstra, J. 2000. Species Origin of Milk in Italian Mozzarella and Greek Feta Cheese. *Journal Of Food Protection*, vol. 63, no. 3, p. 408-411. <https://doi.org/10.4315/0362-028X-63.3.408>
- Caldwell, J. 2017. Food Analysis Using Organelle DNA and the Effects of Processing on Assays. *Annual Review Of Food Science And Technology*, vol. 8, no. 1, p. 57-74. <https://doi.org/10.1146/annurev-food-030216-030216>
- Cheng, Y., Chen, S., Weng, C. 2006. Investigation of Goats Milk Adulteration with Cows Milk by PCR. *Asian-Australasian Journal Of Animal Sciences*, vol. 19, no. 10, p. 1503-1507. <https://doi.org/10.5713/ajas.2006.1503>
- Di Domenico, M., Di Giuseppe, M., Wicochea Rodríguez, J., Cammà, C. 2017. Validation of a fast real-time PCR method to detect fraud and mislabeling in milk and dairy products. *Journal Of Dairy Science*, vol. 100, no. 1, p. 106-112. <https://doi.org/10.3168/jds.2016-11695>
- Gonçalves, J., Pereira, F., Amorim, A., van Asch, B. 2012. New Method for the Simultaneous Identification of Cow, Sheep, Goat, and Water Buffalo in Dairy Products by Analysis of Short Species-Specific Mitochondrial DNA Targets. *Journal Of Agricultural And Food Chemistry*, vol. 60, no. 42, p. 10480-10485. <https://doi.org/10.1021/jf3029896>
- Haenlein, G. 2004. Goat milk in human nutrition. *Small Ruminant Research*, vol. 51, no. 2, p. 155-163. <https://doi.org/10.1016/j.smallrumres.2003.08.010>
- Hutu, I., Boldura, A., Popescu, S., Balta, C., Chis, C., Mircu, C. 2013. A multiplex PCR approach to the quantification of cow milk in goat products. *Current Opinion in Biotechnology*, vol. 24, no. 1, p. 95. <https://doi.org/10.1016/j.copbio.2013.05.285>
- Jung, Y., Jhon, D., Kim, K., Hong, Y. 2011. Quantitative Detection of Cow Milk in Goat Milk Mixtures by Real-Time PCR. *Korean Journal For Food Science Of Animal Resources*, vol. 31, no. 6, p. 827-833. <https://doi.org/10.5851/kosfa.2011.31.6.827>
- Klančnik, A., Toplak, N., Kovač, M., Ogrinc, N., Jeršek, B. 2015. Robust PCR-based method for quantification of bovine milk in cheeses made from caprine and ovine milk. *International Journal of Dairy Technology*, vol. 69, no. 4, p. 540-549. <https://doi.org/10.1111/1471-0307.12287>
- Kemal Seçkin, A., Yilmaz, B., Tosun, H. 2017. Real-time PCR is a potential tool to determine the origin of milk used in cheese production. *LWT – Food Science And Technology*, vol. 77, p. 332-336. <https://doi.org/10.1016/j.lwt.2016.11.065>
- Kotowich, M., Adamczyk, E., Bania, J. 2007. Application of a Duplex – PCR for detection of cow's milk in goat milk. *Annals of Agricultural and Environmental Medicine*, vol. 14, no. 2, p. 215-218.
- Lanzilao, I., Burgalassi, F., Fancelli, S., Settimelli, M., Fani, R. 2005. Polymerase chain reaction-restriction fragment length polymorphism analysis of mitochondrial cyt-b gene from species of dairy interest. *Journal of AOAC International*, vol. 88, no. 1, p. 128-35. [PMid:15759735](https://doi.org/10.1016/j.jaoac.2005.01.009)
- López-Calleja, I., González, I., Fajardo, V., Rodríguez, M., Hernández, P., García, T., Martín, R. 2004. Rapid Detection of Cows' Milk in Sheeps' and Goats' Milk by a Species-Specific Polymerase Chain Reaction Technique. *Journal Of Dairy Science*, vol. 87, no. 9, p. 2839-2845. [https://doi.org/10.3168/jds.S0022-0302\(04\)73412-8](https://doi.org/10.3168/jds.S0022-0302(04)73412-8)
- Mafra, I., Roxo, Á., Ferreira, I., Oliveira, M. 2007. A duplex polymerase chain reaction for the quantitative detection of cows' milk in goats' milk cheese. *International Dairy Journal*, vol. 17, no. 9, p. 1132-1138. <http://dx.doi.org/10.1016/j.idairyj.2007.01.009>
- Maudet, C., Taberlet, P. 2001. Detection of cows' milk in goats' cheeses inferred from mitochondrial DNA polymorphism. *Journal Of Dairy Research*, vol. 68, no. 2, p. 229-235. <http://dx.doi.org/10.1017/s0022029901004794>
- Maudet, C., Taberlet, P. 2002. Holstein's Milk Detection in Cheeses Inferred from Melanocortin Receptor 1 (MC1R) Gene Polymorphism. *Journal of Dairy Science*, vol. 85, no. 4, p. 707-715. [https://doi.org/10.3168/jds.S0022-0302\(02\)74127-1](https://doi.org/10.3168/jds.S0022-0302(02)74127-1)
- Mininni, A., Pellizzari, C., Cardazzo, B., Carraro, L., Balzan, S., Novelli, E. 2009. Evaluation of real-time PCR assays for detection and quantification of fraudulent addition of bovine milk to caprine and ovine milk for cheese manufacture. *International Dairy Journal*, vol. 19, no. 10, p. 617-623. <https://doi.org/10.1016/j.idairyj.2009.04.003>
- Osman, A., Aradaib, I., Musa, O. 2013. Detection of Caprine-specific Nucleic Acid Sequences in Goat Milk Using Polymerase Chain Reaction. *Materia Socio Medica*, vol. 25, no. 2, p. 105. <http://dx.doi.org/10.5455/msm.2013.25.105-108>
- Rentsch, J., Weibel, S., Ruf, J., Eugster, A., Beck, K., Köppel, R. 2012. Interlaboratory validation of two multiplex quantitative real-time PCR methods to determine species DNA of cow, sheep and goat as a measure of milk proportions in cheese. *European Food Research And Technology*, vol. 236, no. 1, p. 217-227. <https://doi.org/10.1007/s00217-012-1880-y>
- Sakaridis, I., Ganopoulos, I., Argiriou, A., Tsaftaris, A. 2013. High resolution melting analysis for quantitative detection of bovine milk in pure water buffalo mozzarella and other buffalo dairy products. *International Dairy Journal*, vol. 28, no. 1, p. 32-35. <http://dx.doi.org/10.1016/j.idairyj.2012.08.006>
- Zeleňáková, L., Židek, R., Čanigová, M., Žiarovská, J., Zajác, P., Maršáľková, L., Fikselová, M., Golian, J. 2016. Research And Practice: Quantification Of Raw And Heat-Treated Cow Milk in Sheep Milk, Cheese And Bryndza By ELISA Method. *Potravinárstvo*, vol. 10, no. 1, p. 14-22. <https://doi.org/10.5219/566>
- Zhang, C., Fowler, M., Scott, N., Lawson, G., Slater, A. 2007. A TaqMan real-time PCR system for the identification and quantification of bovine DNA in meats, milks and cheeses. *Food Control*, vol. 18, no. 9, p. 1149-1158. <https://doi.org/10.1016/j.foodcont.2006.07.018>

Acknowledgments:

This work was supported by grant VEGA No. 1/0316/15.

Contact address:

Ing. Tomáš Fekete, Slovak University of Agriculture, Faculty of Biotechnology and Food Sciences, Department of Hygiene and Food Safety, Tr. A. Hlinku 2, 949 76 Nitra, Slovakia, E-mail: xfeketet@is.uniag.sk

Ing. Marek Šnirc, PhD., Slovak University of Agriculture, Faculty of Biotechnology and Food Sciences, Department of Animal Products Evaluation and Processing, Tr. A. Hlinku 2, 949 76 Nitra, Slovakia, E-mail: marek.snirc@uniag.sk

Ing. Ľubomír Belej, PhD., Slovak University of Agriculture, Faculty of Biotechnology and Food Sciences, Department of Hygiene and Food Safety, Tr. A. Hlinku 2, 949 76 Nitra, Slovakia, E-mail: lubomir.belej@uniag.sk

doc. Ing. Radoslav Židek, PhD., Slovak University of Agriculture, Faculty of Biotechnology and Food Sciences, Department of Hygiene and Food Safety, Tr. A. Hlinku 2, 949 76 Nitra, Slovakia, E-mail: radoslav.zidek@uniag.sk

prof. Ing. Jozef Golian, Dr., Slovak University of Agriculture, Faculty of Biotechnology and Food Sciences, Department of Hygiene and Food Safety, Tr. A. Hlinku 2, 949 76 Nitra, Slovakia, E-mail: jozef.golian@uniag.sk

doc. Ing. Peter Haščík, PhD., Slovak University of Agriculture, Faculty of Biotechnology and Food Sciences, Department of Animal Products Evaluation and Processing, Tr. A. Hlinku 2, 949 76 Nitra, Slovakia, E-mail: peter.hascik@uniag.sk

doc. Ing. Lucia Zelenáková, PhD., Slovak University of Agriculture, Faculty of Biotechnology and Food Sciences, Department of Hygiene and Food Safety, Tr. A. Hlinku 2, 949 76 Nitra, Slovakia, E-mail: lucia.zelenakova@is.uniag.sk

Ing. Peter Zajác, PhD., Slovak University of Agriculture, Faculty of Biotechnology and Food Sciences, Department of Hygiene and Food Safety, Tr. A. Hlinku 2, 949 76 Nitra, Slovakia, E-mail: peter.zajac@uniag.sk

THE EFFECT OF CONFORMATIONAL TRANSITION OF GELATIN-POLYSACCHARIDE POLYELECTROLYTE COMPLEX ON ITS FUNCTIONAL PROPERTIES

Tomáš Valenta, Barbora Lapčíková, Lubomír Lapčík, Li Peng

ABSTRACT

The blends of gelatin and shear-thinning hydrocolloids (guar gum, kappa-carrageenan and xanthan gum) were examined to determine the effect of the conformational change on the functional properties of the solutions. The polyelectrolyte complexes of 0.5% gelatin/0.5% polysaccharide in 70 mM KCl or 70 mM NaCl were investigated by the laboratory rheometer and conductivity meter in the temperature range 25 – 45 °C. The rheological data were fitted by the power-law and Herschel-Bulkley model to obtain the flow parameters. The functional properties of the samples were substantially affected by the conformational change of the polysaccharide, as well as by the type of the hydrocolloid and salt solution. There was an evident change of viscosity and conductivity of the solutions upon heating, corresponding to the helix-coil transition of the polysaccharide at temperature about 35 °C. The type of the salt solvent had an effect on the gelation properties of the samples. Gelatin/kappa-carrageenan blend in NaCl provided a gel of high consistency at ambient temperature (20 – 25 °C), whereas the blend in KCl did not gel in the studied temperature range. The potential stability of the blends was determined by zeta-potential analysis. The low values of ζ -potential indicate that the gelatin/polysaccharide blends are electrically unstable systems which tend to coagulate. The mixtures of gelatin/polysaccharide electrostatic complexes may have a great potential in many food applications.

Keywords: biopolyelectrolyte complex; conformational transition; flow parameter; gelatin-polysaccharide blend; hydrocolloid

INTRODUCTION

The biopolyelectrolyte complexes (PECs) in aqueous and salt solutions, formed by oppositely charged polysaccharides and proteins, were largely investigated in the last years. Particularly, the formation and physicochemical properties of these complexes were intensively studied (Derkach et al., 2015; Viebke, Piculell and Nilsson, 1994). Other research in the field of the polyelectrolyte complexes might be of great value in extending our knowledge of the protein/polysaccharide electrostatic complexation. The effect of the addition of hydrocolloids employed in these complexes and the hydrocolloid gels on the properties of food products can have a significant importance for manufacturing of food products (Bojňanská, Šmitalová and Vollmannová, 2016; Kumbár et al., 2017). Notably, the investigation of electrostatic interaction between gelatin and polysaccharides seems to be beneficial for new practical applications of PECs in the food industry. Gelatin, which is broadly used in food production, is limited by its rheological properties, thermal stability, etc. The compatibility of gelatin with different ionic

polysaccharides, such as guar gum, xanthan gum and kappa-carrageenan, is provided by the formation of PECs. It is possible to obtain new modifications of rheological properties of gelatin-based products using gelatin-polysaccharide combinations (Derkach et al., 2015).

One of the most common hydrocolloids in the polyelectrolyte complexes is carrageenan, an anionic polysaccharide, which plays a role of a basis in the electrostatic complexation. The κ -carrageenan molecule is negatively charged in aqueous solution due to one negatively charged sulphonic acid group per carrabiose unit. In the presence of a positively charged natural polyelectrolyte, κ -carrageenan self-assembles with the complementary polyelectrolyte, such as gelatin. The complexation with gelatin is provided by the electrostatic interaction between positively charged groups in gelatin and negatively charged sulfate groups in κ -carrageenan leading to conformational changes of gelatin macromolecules (Derkach et al., 2015; Voron'ko et al., 2016).

Gelatin, which is widely employed in the PECs, is protein (polypeptide) extracted by denaturation of collagen

from mammalian or fish tissues (Fang et al., 2006). In solution at moderate temperature above 40 °C, gelatin is present in the form of flexible, disordered coils which associate into triple helices, similar to native collagen. In other words, the polypeptide chains of gelatin have a random coil conformation at higher temperatures; this conformation is slowly transformed into single helix by lowering temperature. By sufficient concentration, gelatin bonds with two other molecules to form a triple helix upon cooling. The triple helix is an insoluble semi-rigid rod partly consisting of collagen due to unfinished renaturation. Above the gelation temperature T_g (ca. 40 °C), gelatin behaves as a viscous liquid (*sol state*), under T_g as a thermoreversible weak gel (*gel state*). However, the gelatin exhibits the increase in the gel strength upon cooling to below 30 °C. At temperature above 35 °C, gelatin melts due to the dissociation of triple helices (Pelc et al., 2014; Sarbon, Badii and Howell, 2015).

The electrostatic interactions are the main forces in the formation and stabilization of PECs, notably polysaccharide-protein complexes, although the hydrogen bonds and hydrophobic interactions are also important. As stated by Voron'ko et al. (2016), at high temperatures, when biopolymer macromolecules in solution assume the random coil conformation, hydrophobic interactions contribute to a large extent to complex stabilization. On the other hand, below and at the temperature of gelatin coil to helix conformational transition, the electrostatic interactions and hydrogen bonds play a decisive role in complex formulation.

In the field of food industry, the formation of an electrostatic complex between a polysaccharide and a protein, such as gelatin, plays an important role in many applications. The complexation is utilized for stabilizing of emulsions, design of low-calorie and low-starch food products, encapsulation of flavours, etc. The protein/polysaccharide complexes can be also used as new emulsifying agents providing unique emulsification properties (Cao et al., 2016; Li et al., 2012). Moreover, the specific hydrophilic and polydisperse character of gelatin provides the electrostatic complexes a great nutritional value in the production of dietary food. The polyelectrolyte complexes of gelatin/polysaccharide can have health benefits for an average customer as a substitute of high-sugar content food products. In other words, the complexes can prevent some diseases such as diabetes resulting from a high consumption of sugars in an unhealthy diet (Li and Nie, 2016).

The goal of this research is to study the rheological and other functional properties of the gelatin/polysaccharide mixtures dependent on the temperature, salt solvent and hydrocolloid employed in the mixture. The effect of the conformational transition of the biopolyelectrolyte complex on the functional properties will be examined.

MATERIAL AND METHODOLOGY

Materials

The powder samples of polysaccharides, guar gum (No. G4129), kappa-carrageenan (No. 22048, viscosity of 0.3% solution at 25 °C reported as 5 – 25 mPa.s) and xanthan gum (No. G1253, viscosity of 1% solution reported as 800

– 1200 mPa.s⁻¹) were delivered by Sigma-Aldrich Co. (St. Louis, USA). Gelatin, potassium chloride (KCl) and sodium chloride (NaCl) were obtained by the Czech company IPL – Ing. Petr Lukeš (Uherský Brod, Czech Republic). All chemicals were of analytical grade.

The samples of hydrocolloids were stored in a dry laboratory place at room temperature (ca 25 °C) and relative humidity about 40% (vol.).

Samples preparation

The solution of 1.0% gelatin was prepared by dissolving the sample in 70 mM KCl or 70 mM NaCl. The gelatin was swelled in a minor amount of the solvent. Afterwards, the solution was heated at 45 °C to dissolve completely. Then the solution was cooled under ambient temperature.

The polysaccharide solutions of 1.0% w/w concentration were prepared by dissolving the samples in 70 mM KCl or 70 mM NaCl and mixing by a magnetic stirrer. Since the powder samples were only partially soluble in cold solvent, the solutions were treated at room temperature (ca 25 °C) for a long time and heated at 80 – 89 °C for a short time to make easy the total dispersion. 0.5% w/w polysaccharide solutions were prepared in the same way as the reference samples.

The salt mixtures of gelatin/polysaccharide were prepared by blending the equal amounts of the stock solutions of 1.0% gelatin and 1.0% polysaccharide to achieve the final concentration of 0.5% w/w. The dispersions of gelatin/polysaccharide were stirred at 45 °C for 10 min. The solutions were kept at room temperature for 72 h to release air bubbles. Subsequently, the samples were stored in a refrigerator at temperature about 4 °C. Before the analyses, the samples were gently and carefully mixed and shaken to ensure the homogeneous consistency of the solutions.

Methods

Viscosimetric analysis

The viscosimetric analysis of the samples was performed using universal laboratory rheometer HAAKE RheoStress 1 (Thermo Scientific, USA) with automatic software. The model type of cylinder-cylinder geometry was used. The thermal control was ensured by thermostat HAAKE AC 200 (Thermo Scientific, USA).

Prior to testing, the samples were thermally equilibrated in the water bath. The viscosimetric measurements were performed at specific temperatures: 25 °C, 30 °C, 35 °C, 40 °C and 45 °C. The temperature was kept constant with an accuracy of ±0.5 °C using the heating circulator. The viscosity was measured in the shear rate between 2 and 200 s⁻¹. The shear rate was rising and decreasing, the duration of one cycle was 180 s.

The measurement was performed three times for each sample. The experimental data were statistically analysed and fitted by suitable rheological models, power-law (Ostwald-de Waele) model and Herschel-Bulkley model. The flow parameters were evaluated using the software SigmaPlot 2002 Version 8.0 (SPSS Inc., USA). The differences between the values of consistency coefficient (k), flow behaviour index (n) and yield stress (τ_0) were considered at significant level $p < 0.0001$.

Arrhenius model

The effect of temperature on the viscosity of the blends was evaluated using the Arrhenius equation. The values of determination coefficient (R^2) were stated at specified shear rates (20 s⁻¹ and 100 s⁻¹) for all solutions.

The form of Arrhenius model is shown in Eq. (1):

$$\eta = A \exp\left(\frac{E_a}{RT}\right) \quad (1)$$

where: η is the dynamic viscosity (Pa.s), A is the pre-exponential factor (-), E_a is the activation energy (J.mol⁻¹), R is the molar gas constant (8.3144598 J.K⁻¹mol⁻¹) and T is the thermodynamic temperature (K) (Marcotte et al., 2001).

Conductivity measurement

The conductivity of the blends was determined by conductometer Mettler-Toledo (USA) in the temperature range 25 – 45 °C. The temperature of the samples was ensured by the water bath Julabo MA-4 (Germany). Each sample was measured three times at specific temperatures: 25 °C, 27 °C, 29 °C, etc. The conductivity of 0.5% polysaccharide solutions as reference materials was also determined.

The conductivity of each sample was calculated as an average value of three measurements. The data were evaluated by plotting the graphs of conductivity C (mS.cm⁻¹) versus temperature (°C).

Zeta potential analysis

The zeta potential of 0.5% gelatin/polysaccharide blends was measured by Zeta Potential Analyzer, Zeta Plus (Brookhaven Instruments Corporation, USA). The appropriate amount of the sample (1.6 ml) was poured into the squared polystyrene cuvette. The temperature of the samples was equilibrated at 25 °C by automatic software. Prior to testing, the pH-values of the solutions were measured by pH meter Five Easy Plus FEP 20 (Mettler-Toledo, Switzerland); the obtained results were entered as parameters for the following analysis. The values of zeta potential of the solutions, as well as the effective diameter of the particles were analysed by the software. The data

were compared for the samples to evaluate the potential stability of the blends.

The zeta potential (ζ -potential) measurement consists in determining the electrostatic potential at the surface of shear which extends out from particle surface of the examined colloidal system. Generally, the electrostatic potential (y) is a function of distance from the particle surface and can be expressed by Eq. (2):

$$y = y_0 e^{-kx} \quad (2)$$

where y_0 is the potential at the surface and k is a parameter that measures the decrease of the potential with distance. Similar to y , the ζ -potential decreases in an exponential fashion. The parameter k^{-1} , called the double layer thickness, plays an important role in determining the distance from the particle surface; k^{-1} is a function of temperature, dielectric constant of the liquid and ionic strength due to free ions (typically by added salt like KCl) in the bulk of the fluid (Anonym, 2000).

RESULTS AND DISCUSSION

Viscosimetric analysis

The flow parameters obtained by fitting the rheological models, Ostwald-de Waele and Herschel-Bulkley models, to the data are summarized in **Chyba! Nenašiel sa žiaden zdroj odkazov. to Chyba! Nenašiel sa žiaden zdroj odkazov..** The Herschel-Bulkley parameters were evaluated without the extrapolation of the yield stress values. The Herschel-Bulkley model was the most suitable model for all samples in terms of determination coefficient (R^2). The high values of R^2 (0.99) obtained by fitting the Herschel-Bulkley model indicate a good fit of this model for the hydrocolloid blends.

The blends of gelatin/polysaccharide were dissolved in 70 mM KCl or 70 mM NaCl to eliminate contributions to the viscosity from intramolecular electrostatic repulsions which are typical for the polymer samples in distilled water (Kupská et al., 2014). The blends were prepared in two different salt solvents to follow the effects of helix-coil transition induced by external stimulus, i.e., by the change of temperature and type of the solvent.

Table 1 Flow parameters of 0.5% w/w gelatin/polysaccharide blends in 0.07M KCl (for upward curves).

Sample	t (°C)	Herschel-Bulkley model				Ostwald-de Waele model			
		τ_0 (Pa)	k (Pa.s ^{n})	n	R^2	k (Pa.s ^{n})	n	R^2	
Guar gum/gelatin	25	-7.008	6.830	0.22	0.9990	1.956	0.38	0.9905	
	30	-0.9089	0.8898	0.45	0.9998	0.5246	0.53	0.9982	
	35	-0.7405	0.5905	0.51	0.9998	0.3434	0.59	0.9980	
	40	-0.6377	0.4812	0.53	0.9997	0.2826	0.61	0.9980	
	45	-0.5032	0.3679	0.56	0.9998	0.2265	0.64	0.9984	
Kappa-carrageenan/gelatin	25	0.1580	0.0139	0.83	0.9962	0.0438	0.64	0.9895	
	30	0.1794	0.0015	1.18	0.9675	0.0201	0.72	0.9425	
	35	0.2516	0.0404	0.55	0.9198	-	-	0.9085	
	40	0.1044	0.0030	1.07	0.9906	0.0120	0.83	0.9824	
	45	0.3453	0.0038	0.89	0.6532	-	-	0.5522	
Xanthan gum/gelatin	25	3.282	0.8333	0.36	0.9998	3.264	0.187	0.9931	
	30	2.10	1.489	0.27	0.9985	3.177	0.180	0.9961	
	35	1.179	1.989	0.23	0.9985	2.953	0.186	0.9978	
	40	2.057	1.292	0.28	0.9993	2.919	0.185	0.9963	
	45	1.647	1.077	0.32	0.9988	2.281	0.224	0.9959	

Table 2 Flow parameters of 0.5% w/w gelatin/polysaccharide blends in 0.07M NaCl (for upward curves).

Sample	t (°C)	Herschel-Bulkley model				Ostwald-de Waele model		
		τ_0 (Pa)	k (Pa.s ⁿ)	n	R^2	k (Pa.s ⁿ)	n	R^2
Guar gum/gelatin	25	-2.823	2.493	0.31	0.9987	0.9213	0.45	0.9927
	30	-0.4414	0.3243	0.58	0.9998	0.2066	0.65	0.9986
	35	-0.2869	0.1849	0.66	0.9998	0.1253	0.72	0.9989
	40	-0.2373	0.1557	0.67	0.9999	0.1086	0.73	0.9991
	45	-0.1773	0.1166	0.70	0.9999	0.0848	0.76	0.9993
Kappa-carrageenan/gelatin	25	4.80	0.7628	0.56	0.9983	3.093	0.35	0.9867
	30	9.877	0.2149	0.76	0.9977	5.478	0.25	0.9427
	35	3.009	1.083	0.48	0.9992	2.674	0.34	0.9946
	40	2.084	1.044	0.39	0.9889	2.386	0.28	0.9953
	45	0.208	0.0727	0.68	0.9998	0.126	0.59	0.9982
Xanthan gum/gelatin	25	3.30	0.6827	0.38	0.9997	3.112	0.184	0.9913
	30	2.288	0.8347	0.36	0.9985	2.428	0.220	0.9976
	35	1.911	0.940	0.34	0.9987	2.332	0.219	0.9944
	40	1.394	1.184	0.30	0.9990	2.221	0.222	0.9970
	45	0.973	1.375	0.28	0.9992	2.106	0.227	0.9983

Table 3 Flow parameters of 0.5% w/w polysaccharide solutions in 0.07M KCl (for upward curves).

Sample	t (°C)	Herschel-Bulkley model				Ostwald-de Waele model		
		τ_0 (Pa)	k (Pa.s ⁿ)	n	R^2	k (Pa.s ⁿ)	n	R^2
Guar gum	25	-1.321	1.183	0.418	0.9997	0.6125	0.520	0.9971
	30	-1.340	1.214	0.407	0.9998	0.6182	0.511	0.9970
	35	-1.322	1.186	0.408	0.9998	0.6006	0.513	0.9970
	40	-1.268	1.116	0.412	0.9997	0.5614	0.518	0.9969
	45	-1.179	1.015	0.424	0.9997	0.5175	0.529	0.9970
Kappa-carrageenan	25	6.039	0.3985	0.60	0.9608	3.286	0.29	0.9521
	30	7.20	0.0370	0.98	0.9559	2.890	0.29	0.9125
	35	10.53	0.0063	1.24	0.8550	5.970	0.17	0.7617
	40	7.584	0.0189	1.05	0.8714	3.652	0.22	0.8074
	45	6.255	0.0269	0.96	0.8979	3.032	0.23	0.8520
Xanthan gum	25	2.014	0.903	0.35	0.9995	2.350	0.223	0.9948
	30	1.792	0.977	0.34	0.9998	2.248	0.227	0.9972
	35	1.580	1.083	0.32	0.9998	2.223	0.225	0.9979
	40	1.311	1.197	0.30	0.9998	2.152	0.228	0.9986
	45	1.139	1.299	0.29	0.9998	2.139	0.227	0.9989

Note: t , temperature; τ_0 , yield stress; k , consistency coefficient; n , flow behaviour index; R^2 , coefficient of determination. The hyphen means that no relevant value was possible to determine by the fitting of the model. The number of replicates, 3.

There was a clearly visible substantial change of the rheological behaviour of the blends reflecting a conformational transition of the helix to coil at temperature about 35 °C. The change corresponds to the conformational ordering of the polysaccharide in the gelatin/polysaccharide complex. The gelatin/polysaccharide electrostatic complexation is enhanced due to the conformational transition of the polysaccharide from double helix to random coil upon heating. At higher temperatures (above 40 °C), gelatin in the complexes is present in the form of disordered coils. On the other hand, gelatin/polysaccharide complexes dissociate during cooling by the conformational ordering of the polysaccharide (coil to double helix transition) as reported by Cao et al. (2016) for gelatin/ κ -carrageenan complexation.

The conformational transition temperature of the polysaccharide increases with the addition of salts such as KCl or NaCl. This is due to the reduction of electrostatic complex coacervation of gelatin/polysaccharide mixture

with increasing salt concentration; the coacervation is entirely screened after exceeding a certain limit of the salt. For example, the electrostatic complex coacervation of 0.75% gelatin/ κ -carrageenan mixture is completely screened when KCl concentration is more than 100 mM (Cao et al., 2016). The samples in the present study showed different behaviour of the polysaccharide solutions and gelatin/polysaccharide blends in 70 mM KCl or 70 mM NaCl. The polysaccharide conformational transition affected the rheological properties of the blends; the flow parameters of pure polysaccharide solutions in 70 mM KCl were evidently different from the parameters of the blends as can be seen in Chyba! Nenašiel sa žiaden zdroj odkazov. to Chyba! Nenašiel sa žiaden zdroj odkazov..

As shown in the tables, temperature had a considerable effect on the flow behaviour of the studied solutions. The consistency coefficient (k) of the blends of guar gum/gelatin and κ -carrageenan/gelatin predominantly

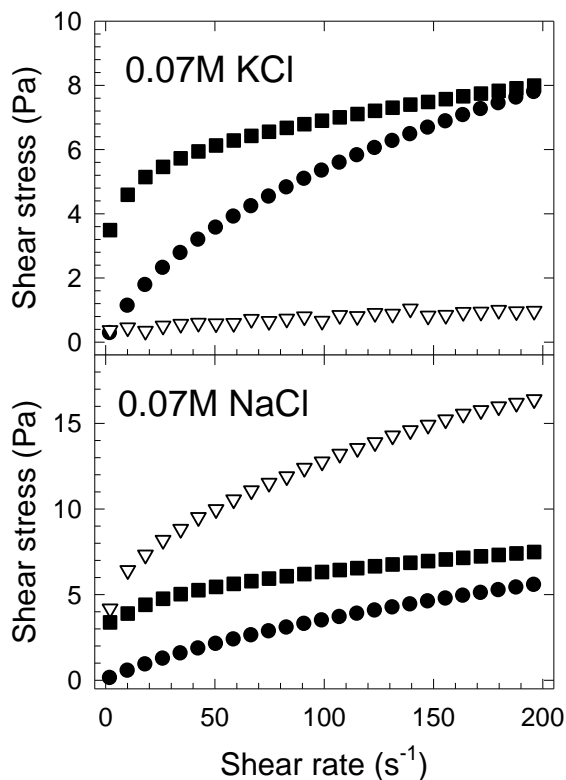

Figure 1 Flow curves of 0.5% w/w gelatin/polysaccharide blends in 0.07M KCl and 0.07M NaCl at 35 °C (upward shear rate): full circle – guar gum/gelatin, empty triangle – κ -carrageenan/gelatin, full square – xanthan gum/gelatin.

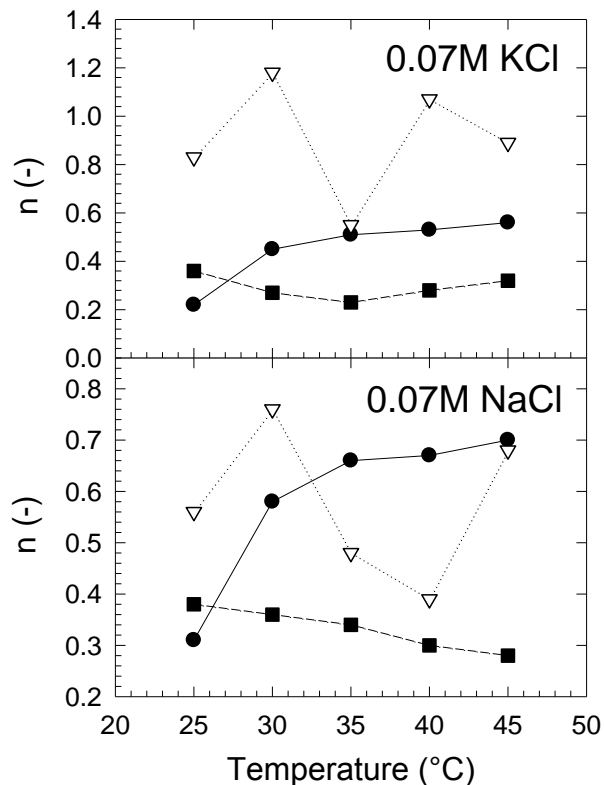

Figure 2 Temperature dependence of flow behaviour index (n) (Herschel-Bulkley model) of 0.5% w/w gelatin/polysaccharide blends in 0.07M KCl and 0.07M NaCl: full circle – guar gum/gelatin, empty triangle – κ -carrageenan/gelatin, full square – xanthan gum/gelatin.

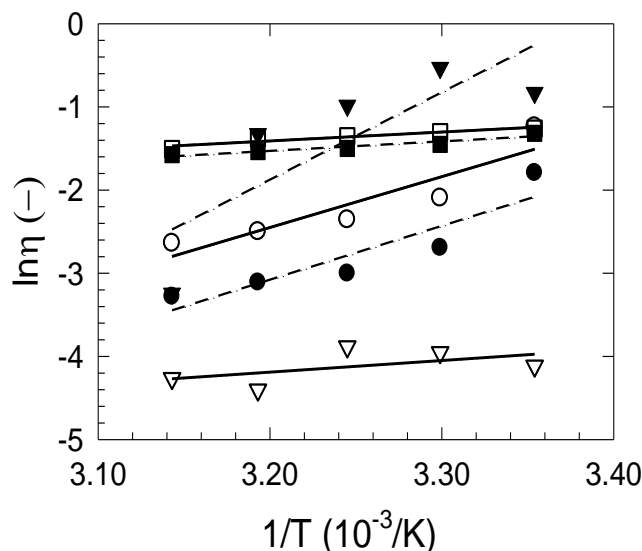

Figure 3 Arrhenius plots of 0.5% w/w gelatin/polysaccharide blends in 0.07M KCl (empty symbols) and in 0.07M NaCl (full symbols) (viscosities read at shear rate 20 s⁻¹): circle – guar gum/gelatin, triangle – κ -carrageenan/gelatin, square – xanthan gum/gelatin. Linear regression curves: full line – in 0.07M KCl, dash-dot line – in 0.07M NaCl.

decreased with the temperature, whereas the flow behaviour index (n) increased with the temperature. The pure polysaccharide solutions of guar gum and κ -carrageenan showed the same trend. However, the xanthan gum/gelatin blends and pure xanthan solution exhibited an opposite behaviour of n versus temperature, as compared to other samples. For xanthan gum/gelatin blend in NaCl and pure xanthan solution in KCl, the flow behaviour

index predominantly decreases, whereas the consistency coefficient increases within the studied temperature range (25 – 45 °C). For xanthan gum/gelatin in KCl, there is an evident step change of flow behaviour index at 30 – 35 °C. This change probably corresponds to the conformational transition of gelatin macromolecules, which undergo a helix to coil transition at temperature above 30 °C (Derkach et al., 2015); the change at temperature around

35 °C could demonstrate the conformational ordering of xanthan gum, i.e., the transition from single coils to double helices.

Overall, xanthan gum provides more viscous blends at higher temperatures, in contrast to guar gum and κ -carrageenan blends which tend to more Newtonian behaviour at elevated temperatures. The blends of xanthan gum also exhibit a significant yield stress (τ_0) within the whole temperature range. Although the values of τ_0 were predominantly decreasing with the temperature, the yield stress was noticeable even at 45 °C, the highest temperature under study (1.647 Pa for the blend in KCl, and 0.973 Pa for the blend in NaCl, respectively, compared to 1.139 Pa for the pure xanthan solution). The viscosity stability of xanthan blends at elevated temperatures (relatively high at low-shear conditions) and the non-negligible values of yield stress result from the weak intermolecular associations of xanthan structure, typical even at very low hydrocolloid concentration. This rheological behaviour of xanthan gum is a consequence of the progressive alignment of the rigid xanthan molecules with the shearing force (Marcotte et al., 2001).

For kappa-carrageenan and gelatin blends, the solutions in NaCl exhibit substantially larger values of yield stress and consistency coefficient, and comparatively lower values of flow behaviour index, than the samples in KCl. This fact can be related to the presence of the potassium or sodium cations which effect the gelation properties of the blends. It means that the flow parameters of the κ -carrageenan/gelatin blends, including yield stress values, are notably affected by the type of salt solvent. K-carrageenan/gelatin blends in NaCl provided a gel of high consistency at temperature about 25 °C, whereas the blend in KCl did not undergo a sol to gel transition within the studied temperature range. Therefore, the differences in the flow parameters between the blends in KCl and NaCl were substantive, particularly between the values of k and τ_0 . This behaviour proves that κ -carrageenan can be largely used as co-gelators of gelatin-based solutions via interaction of charged gelatin with the polysaccharide macroions leading to formation of PECs. As stated by Derkach et al. (2015) the addition of κ -carrageenan to aqueous gelatin solutions affects the gelation kinetics of the blends, as well as the thermal stability of the system;

Table 4 Arrhenius parameters at 20 s⁻¹ and 100 s⁻¹ (upward shear rate) of 0.5% w/w gelatin/polysaccharide blends in 0.07M KCl and 0.07M NaCl.

Sample	Arrhenius equation (20 s ⁻¹)				Arrhenius equation (100 s ⁻¹)		
	Solvent	η_0 (mPa.s)	E_A (kJ.mol ⁻¹)	R^2	η_0 (mPa.s)	E_A (kJ.mol ⁻¹)	R^2
Guar gum/gelatin	KCl	2.64x10 ⁻⁷	50.94	0.8438	1.03x10 ⁻⁴	34.02	0.8234
	NaCl	4.52x10 ⁻⁸	53.90	0.8398	2.45x10 ⁻⁵	36.62	0.8682
Kappa-carrageenan/ gelatin	KCl	0.1728	11.63	0.2940	n.c.	n.c.	n.c.
	NaCl	3.576x10 ⁻¹³	87.53	0.6613	1.494x10 ⁻¹¹	75.30	0.7083
Xanthan gum/gelatin	KCl	7.873	8.926	0.9113	4.995	6.727	0.9747
	NaCl	5.498	9.545	0.9153	4.163	6.992	0.96

Note: η_0 , pre-exponential factor; E_A , activation energy; R^2 , coefficient of determination; n.c., not computed value. The number of replicates, 3.

Table 5 Conductivity of 0.5% w/w gelatin/polysaccharide blends in the temperature range 31 – 41 °C.

t (°C)	Guar gum/gelatin		K-carrageenan/ gelatin		Xanthan gum/gelatin	
	KCl	NaCl	KCl	NaCl	KCl	NaCl
	C (mS.cm-1)					
31	11.37	9.43	11.35	9.59	10.45	8.94
33	11.40	9.53	11.65	9.98	10.55	8.94
35	11.42	9.67	11.73	10.09	10.75	8.94
37	11.54	9.80	11.88	10.61	11.31	9.19
39	11.75	10.10	12.09	10.69	11.34	9.48
41	12.15	10.20	12.22	10.88	11.41	9.51

Note: t , temperature; C , conductivity. The number of replicates, 3.

Table 6 Data of zeta potential analysis of 0.5% w/w gelatin/polysaccharide blends in 0.07 M KCl and 0.07 M NaCl.

Sample	Solvent	ζ -potential (mV)	D (nm)	pH (-)
Guar gum/gelatin	KCl	-0.99 ±0.36	7922 ±1280	4.83
	NaCl	1.00 ±0.20	3226 ±919	5.00
Kappa-carrageenan/ gelatin	KCl	2.37 ±0.84	6385 ±478	6.61
	NaCl	-7.21 ±0.95	14463 ±734	6.44
Xanthan gum/gelatin	KCl	-4.93 ±1.02	54020 ±9863	4.59
	NaCl	-5.01 ±1.72	28891 ±6874	4.63

Note: ζ -potential, zeta potential; d , effective diameter; pH , pH-value; \pm values indicate the standard deviation. The number of replicates, 10.

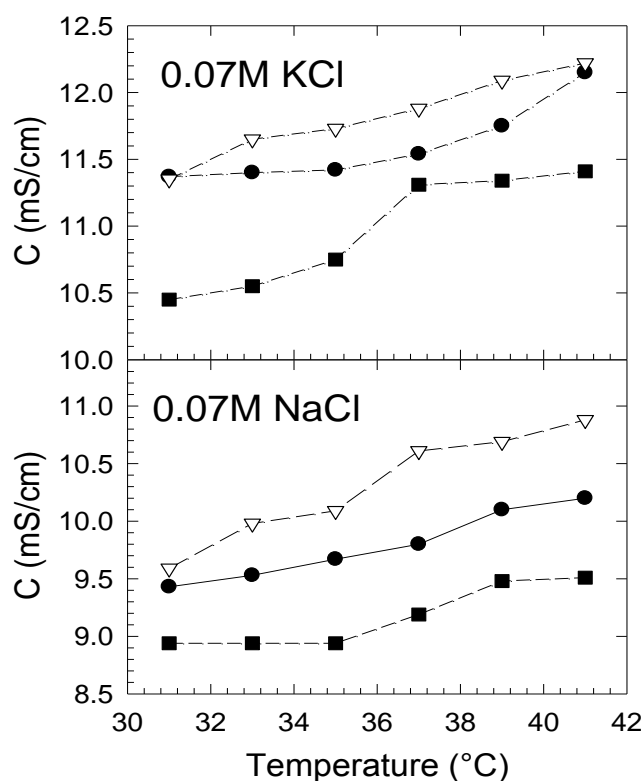

Figure 1 Temperature dependence of conductivity (C) of 0.5% w/w gelatin/polysaccharide blends in the temperature range 31 – 41 °C: full circle – guar gum/gelatin, empty triangle – κ -carrageenan/gelatin, full square – xanthan gum/gelatin.

moreover, the gelatin/ κ -carrageenan ratio has a substantial influence on the flow parameters of the blends. In other words, according to the type of the solvent and concentration of the components, the blends of gelatin/ κ -carrageenan tend to form a gel. The blends of gelatin with guar gum or xanthan gum in the present study did not undergo a sol to gel transition between 20 – 45 °C.

In the case of guar gum, the rheological behaviour of the gelatin/guar gum blends and pure guar gum solution was considerably different. The flow parameters of 0.5% guar gum in KCl varied in a relatively narrow range whereas the parameters of the gelatin/guar gum blends both in KCl and NaCl exhibit an evident change with the temperature. This fact can probably be attributed to the synergistic effect of gelatin on the flow properties of gelatin/guar gum blends. Besides, the values of k and n are comparatively different for the blends in KCl and NaCl, respectively. The presence of chaotropic cations (K^+) and kosmotropic cations (Na^+) leads to the reduction of electrostatic complex coacervation of polysaccharide/gelatin system (Cao et al., 2016). The mechanism of action of these ions is opposite: the chaotropic electrolytes (KCl) suppress the electrostatic repulsion effect on the polymer chains; moreover, the chaotropic ions can enhance the dissolution of colloidal aggregates which are ordinarily present in polysaccharide solutions under ambient conditions (Ma and Pawlik, 2007; Wang et al., 2015). On the other hand, the kosmotropic electrolytes (NaCl) promote interactions between water molecules and thus stabilize intramolecular interactions in protein macromolecules such as gelatin (Moelbert et al., 2004). These specific properties of the salt solvents affect the flow behaviour of guar gum/gelatin blends. The effect of Na^+ ions on the gelatin macromolecules seems to tend the guar gum/gelatin blends

to more Newtonian fashion at higher temperatures, as compared to the effect of K^+ ions in the same system showing more pseudoplastic behaviour (higher values of k , and lower values of n). The flow curves of gelatin/polysaccharide blends both in KCl and NaCl read at 35 °C are shown in Chyba! Nenašiel sa žiaden zdroj odkazov.. The temperature dependence of flow behaviour index of the blends is presented in Chyba! Nenašiel sa žiaden zdroj odkazov..

Arrhenius model

The temperature dependency of the blends' viscosity was investigated by the Arrhenius model. The activation energy (E_A), which was calculated according to the model, represents an energy barrier of the reorientation of water molecules in the biopolymer system (Baranowska et al., 2008). It means, that the activation energy reflects the sensitivity of the molecular structure to the temperature and its change at a specified shear rate (Wang et al., 2015). The Arrhenius parameters in the present study are stated in Chyba! Nenašiel sa žiaden zdroj odkazov.. As can be seen from the table, relatively high values of E_A were determined for the blends of guar gum/gelatin and for κ -carrageenan/gelatin blend in NaCl; these blends are relatively high temperature-dependent samples indicating a lower resistance of their structure at elevated temperatures. On the other hand, the lowest values of E_A were calculated for the mixtures of xanthan gum and gelatin which were less affected by temperature. This fact proves that xanthan gum/gelatin blends have the ability to retain their gel network and viscosity at higher temperatures which is in compliance with the temperature dependency of apparent viscosity observed for xanthan

gum solutions (Marcotte et al., 2001; Marcotte et al., 2001).

A relatively high difference between the values of activation energy was determined for kappa-carrageenan/gelatin blends in KCl and NaCl, respectively. However, the Arrhenius model seems to be not suitable for kappa-carrageenan/gelatin blends because of low values of coefficient of determination (R^2). Therefore, the Arrhenius model was not applied in some cases. In all cases, the activation energy of the samples in 70 mM NaCl was higher than for the samples in KCl; it means that the blends in NaCl need higher amount of activation energy which is needed to promote the viscous flow than the samples in KCl. In the same way, the activation energy read at 20 s⁻¹ was higher than E_A read at 100 s⁻¹ for all samples. This is in accordance with the fact that the structure of a hydrocolloid and its change with the shearing plays an important role in the temperature dependency of the solutions. As stated by (Marcotte et al., 2001) the decrease in activation energy of the hydrocolloid solutions is, in varying degree, associated with an increase of the applied shear rate, depending on the type of hydrocolloid. The observations indicate that the energy necessary for the reorientation of water molecules in the gelatin/polysaccharide blends is obviously influenced by the type of hydrocolloid and salt solvent, as well as by the applied shear rate.

The Arrhenius plots of gelatin/polysaccharide blends read at shear rate of 20 s⁻¹ are shown in **Chyba! Nenašiel sa žiaden zdroj odkazov.**

Conductivity measurement

The effect of conformational transition on conductivity of gelatin/polysaccharide blends depending on temperature was examined. As stated by Cao et al. (2016), pure gelatin solution contributes only negligibly to the conductivity of gelatin/polysaccharide blends. For that reason, the difference in conductivity between pure polysaccharide solution and gelatin/polysaccharide mixture reflects the difference between the polysaccharide in free and complex states. The average values of conductivity C (mS.cm⁻¹), determined for the gelatin/polysaccharide blends, are summarized in Table 5 (the data of conductivity for pure polysaccharide solutions used as reference materials are not stated).

As can be seen from the graph (**Figure 1**) there is an evident change of conductivity at temperature about 35 °C, both for blends in KCl and NaCl, which can be attributed to the helix-coil transition of the polysaccharide. This conformational change entails a steep rise of conductivity above 35 °C. As in the case of rheological behaviour, the change in the slope of conductivity can be considered as confirmation of the effect of polysaccharide conformational ordering on the functional properties of gelatin/polysaccharide complexes.

Zeta potential analysis

The potential stability of the gelatin/polysaccharide blends was evaluated based on the results of zeta potential (ζ -potential) analysis. The experimental data of ζ -potential, pH-values of the solutions and effective diameter of the

particles are summarized in **Chyba! Nenašiel sa žiaden zdroj odkazov.**

The zeta potential is a potential difference between the fluid volume and the thin layer of the counter ions tied to the particle surface. It represents the potential at the plane where slip with respect to bulk solution occurs. In other words, ζ -potential is an electrokinetic potential at the interface between compact and diffusive part of electric double layer. The electric charge of the double layer affects the stability of a colloidal system; ζ -potential is a function of interface order and its sign is opposite to the charge of the ions of outer layer in the electric double layer.

The zeta potential value is dependent on the nature of the surface, its charge (related to pH), the electrolyte concentration in the solution, and the nature of the electrolyte and solvent.

The most important factor for ζ -potential determination is the pH-value. The zero value of ζ -potential indicates the least stable state of the colloidal system at a defined pH, i.e., an isoelectric point of the system (Anonym, 2000; Delgado et al., 2007).

Zeta potential analysis was used to characterize the gelatin/polysaccharide blends. More specifically, the analysis determined the potential difference among the blend medium and the layer of fluid related to the dispersed particles. The colloidal particles (when dispersed in an aqueous medium) prone to interact with other close particles to form aggregates or clusters by attractive forces or remain dispersed via electrostatic repulsion. The balance between attractive and repulsive forces depends on surface charge characteristic which is determined by material and solution type; for example, an electrostatically stabilized colloid is possible to coagulate by adding enough electrolyte such as KCl. Thus, the zeta potential provided information about the magnitude of the electrostatic repulsive forces of the examined colloid systems (Gerzhova et al., 2016; Wu et al., 2015).

In the present study, the low values of ζ -potential determined for all samples (less than ± 10 mV) indicate the instability of gelatin/polysaccharide blends, which tend to coagulate. It means that the electrostatic repulsion between similarly charged nearby particles in the solutions is weak and the blends do not resist aggregation. It suggests that the particles of the blends are not small enough, and the attractive forces between them exceed the electrostatic repulsion.

The highest ζ -potential (in absolute value) was measured for kappa-carrageenan/gelatin in NaCl (7.21 mV) with corresponding effective diameter of the particles 14463 nm. On the other hand, the lowest values of ζ -potential were determined for guar gum/gelatin blends both in KCl and NaCl (around ± 1.0 mV) which represent the least electrically stabilized blends of all samples.

CONCLUSION

The results of the present study demonstrate that the conformational transition of gelatin/polysaccharide polyelectrolyte complex has a substantial influence on the functional properties of gelatin/polysaccharide blends. The noticeable change of flow parameters and conductivity of the solutions upon heating, determined about 35 °C, corresponds to the helix-coil transition of the

polysaccharide. The flow behaviour and gelation properties of the blends were also affected by the type of hydrocolloids and salt solution; gelatin/kappa-carrageenan blend in NaCl showed a gel of high consistency at ambient temperature (ca. 25 °C), while the same blend in KCl did not gel even at refrigerator temperatures. The potential stability of the blends was investigated by zeta-potential analysis. On the basis of relatively low values of ζ -potential, the gelatin/polysaccharide blends can be characterized as electrically unstable systems which tend to coagulate.

REFERENCES

- Anonym, 2000. Instruction manual for ZetaPlus Zeta Potential Analyzer [online] s.a. [cit. 2017-05-09] Available at: <http://149.171.168.221/partcat/wp-content/uploads/ZetaPALS.pdf>.
- Baranowska, H. M., Sikora, M., Kowalski, S., Tomasik, P. 2008. Interactions of potato starch with selected polysaccharide hydrocolloids as measured by low-field NMR. *Food Hydrocolloids*, vol. 22, no. 2, p. 336-345. <https://doi.org/10.1016/j.foodhyd.2006.12.014>
- Bojňanská, T., Šmitalová, J., Vollmannová, A. 2016. Effect of the addition of hydrocolloids on the rheological and baking properties of the products with added spelt flour. *Potravinárstvo Slovak Journal of Food Sciences*, vol. 10, no. 1, p.157-163. <https://dx.doi.org/10.5219/555>
- Cao, Y., Fang, Y., Nishinari, K., Phillips, G. O. 2016. Effects of conformational ordering on protein/polyelectrolyte electrostatic complexation: Ionic binding and chain stiffening. *Scientific Reports*, vol. 6, p. 23739. <https://doi.org/10.1038/srep23739> PMID:27030165
- Delgado, A. V., González-Caballero, F., Hunter, R. J., Koopal, L. K., Lyklema, J. 2007. Measurement and interpretation of electrokinetic phenomena. *Journal of Colloid and Interface Science*, vol. 309, no. 2, p. 194-224. <https://doi.org/10.1016/j.jcis.2006.12.075> PMID:17368660
- Derkach, S. R., Ilyin, S. O., Maklakova, A. A., Kulichikhin, V. G., Malkin, A. Y. 2015. The rheology of gelatin hydrogels modified by κ -carrageenan. *LWT – Food Science and Technology*, vol. 63, no. 1, p. 612-619. <https://doi.org/10.1016/j.lwt.2015.03.024>
- Derkach, S., Zhabyko, I., Voron'ko, N., Maklakova, A., Dyakina, T. 2015. Stability and the rheological properties of concentrated emulsions containing gelatin- κ -carrageenan polyelectrolyte complexes. *Colloids and Surfaces A: Physicochemical and Engineering Aspects*, vol. 483, p. 216-223. <https://doi.org/10.1016/j.colsurfa.2015.04.007>
- Fang, Y., Li, L., Inoue, C., Lundin, L., Appelqvist, I. 2006. Associative and segregative phase separations of gelatin/K-carrageenan aqueous mixtures. *Langmuir*, vol. 22, no. 23, p. 9532-9537. <https://doi.org/10.1021/la061865e> PMID:17073476
- Gerzhova, A., Mondor, M., Benali, M., Aider, M. 2016. Study of total dry matter and protein extraction from canola meal as affected by the pH, salt addition and use of zeta-potential/turbidimetry analysis to optimize the extraction conditions. *Food Chemistry*, vol. 201, p. 243-252. <https://doi.org/10.1016/j.foodchem.2016.01.074> PMID:26868572
- Kumbár, V., Nedomová, Š., Pytel, R. Kilián, L., Buchar, J. 2017. Study of rheology and friction factor of natural food hydrocolloid gels. *Potravinárstvo Slovak Journal of Food Sciences*, vol. 11, no. 1, p. 203-209. <https://doi.org/10.5219/735>
- Kupská, I., Lapčík, L., Lapčíková, B., Žáková, K., Juříková, J. 2014. The viscometric behaviour of sodium hyaluronate in aqueous and KCl solutions. *Colloids and Surfaces A: Physicochemical and Engineering Aspects*, vol. 454, p. 32-37. <https://doi.org/10.1016/j.colsurfa.2014.04.018>
- Li, J., Nie, S. 2016. The functional and nutritional aspects of hydrocolloids in foods. *Food Hydrocolloids*, vol. 53, p. 46-61. <https://doi.org/10.1016/j.foodhyd.2015.01.035>
- Li, X., Fang, Y., Al-Assaf, S., Phillips, G. O., Jiang, F. 2012. Complexation of bovine serum albumin and sugar beet pectin: Stabilising oil-in-water emulsions. *Journal of Colloid and Interface Science*, vol. 388, no. 1, p. 103-111. <https://doi.org/10.1016/j.jcis.2012.08.018> PMID:22975397
- Ma, X., Pawlik, M. 2007. Intrinsic viscosities and Huggins constants of guar gum in alkali metal chloride solutions. *Carbohydrate Polymers*, vol. 70, no. 1, p. 15-24. <https://doi.org/10.1016/j.carbpol.2007.02.024>
- Marcotte, M., Taherian Hoshahili, A. R., Ramaswamy, H. S. 2001. Rheological properties of selected hydrocolloids as a function of concentration and temperature. *Food Research International*, vol. 34, no. 8, p. 695-703. [https://doi.org/10.1016/S0963-9969\(01\)00091-6](https://doi.org/10.1016/S0963-9969(01)00091-6)
- Marcotte, M., Taherian, A. R., Trigui, M., Ramaswamy, H. S. 2001. Evaluation of rheological properties of selected salt enriched food hydrocolloids. *Journal of Food Engineering*, vol. 48, no. 2, p. 157-167. [https://doi.org/10.1016/S0260-8774\(00\)00153-9](https://doi.org/10.1016/S0260-8774(00)00153-9)
- Moelbert, S., Normand, B., De Los Rios, P. 2004. Kosmotropes and chaotropes: Modelling preferential exclusion, binding and aggregate stability. *Biophysical Chemistry*, vol. 112, no. 1, p. 45-57. <https://doi.org/10.1016/j.bpc.2004.06.012> PMID:15501575
- Pelc, D., Marion, S., Požek, M., Basletić, M. 2014. Role of microscopic phase separation in gelation of aqueous gelatin solutions. *Soft Matter*, vol. 10, p. 348-356. <https://doi.org/10.1039/C3SM52542B> PMID:24651841
- Sarboň, N. M., Badii, F., Howell, N. K. 2015. The effect of chicken skin gelatin and whey protein interactions on rheological and thermal properties. *Food Hydrocolloids*, vol. 45, p. 83-92. <https://doi.org/10.1016/j.foodhyd.2014.10.008>
- Viebecke, C., Piculell, L., Nilsson, S. 1994. On the mechanism of gelation of helix-forming biopolymers. *Macromolecules*, vol. 27, p. 4160-4166. <https://doi.org/10.1021/ma00093a017>
- Voron'ko, N. G., Derkach, S. R., Vovk, M. A., Tolstoy, P. M. 2016. Formation of κ -carrageenan-gelatin polyelectrolyte complexes studied by ¹H NMR, UV spectroscopy and kinematic viscosity measurements. *Carbohydrate Polymers*, vol. 151, p. 1152-1161. <https://doi.org/10.1016/j.carbpol.2016.06.060> PMID:27474666
- Wang, S., He, L., Guo, J., Zhao, J., Tang, H. 2015. Intrinsic viscosity and rheological properties of natural and substituted guar gums in seawater. *International Journal of Biological Macromolecules*, vol. 76, p. 262-268. <https://doi.org/10.1016/j.ijbiomac.2015.03.002> PMID:25749106
- Wu, C., Wang, L., Harbottle, D., Masliyah, J., Xu, Z. 2015. Studying bubble – particle interactions by zeta potential distribution analysis. *Journal of Colloid and Interface Science*, vol. 449, p. 399-408.

<https://doi.org/10.1016/j.jcis.2015.01.040>

[PMid:25731913](#)

Acknowledgments:

This work was financially supported by the national budget of the Czech Republic within the research project of the Tomas Bata University in Zlin Internal Grant Agency (reg. number: IGA/FT/2017/004).

Contact address:

Tomáš Valenta, Tomas Bata University in Zlín, Faculty of Technology, Department of Food Technology, Vavrečkova 275, 762 72 Zlín, Czech Republic, E-mail: tvalenta@ft.utb.cz

Barbora Lapčíková, Tomas Bata University in Zlín, Faculty of Technology, Department of Food Technology, Vavrečkova 275, 762 72 Zlín, Czech Republic, E-mail: lapcikova@ft.utb.cz

Lubomír Lapčík, Tomas Bata University in Zlín, Faculty of Technology, Department of Food Technology, Vavrečkova 275, 762 72 Zlín, Czech Republic, E-mail: lapcik@ft.utb.cz

Li Peng, Tomas Bata University in Zlín, Faculty of Technology, Department of Food Technology, Vavrečkova 275, 762 72 Zlín, Czech Republic, E-mail: lllippe@hotmail.com



SURVIVAL OF *LACTOBACILLUS BULGARICUS* AND *BIFIDOBACTERIUM ANIMALIS* IN YOGHURTS MADE FROM COMMERCIAL STARTER CULTURES DURING REFRIGERATED STORAGE

Eva Dudriková, Mária Nagyová, Zuzana Dičáková

ABSTRACT

All over the world, fermented dairy products have been consumed for nutrition and maintenance of good health for a very long time. This study evaluated the survival of *Lactobacillus delbrueckii* ssp. *bulgaricus* and *Bifidobacterium animalis* ssp. *lactis* BB-12 in yoghurts after the manufacturing during the shelf-life up to 21 days at 4 °C, which is mostly accepted by the consumers. The titratable acidity and pH showed the same patterns of increase or decline after manufacturing and storage of yoghurts. There was a significant difference ($p < 0.05$) in acidity between yoghurts in glass bottle and plastic cup. The increase in numbers of lactobacilli and bifidobacteria and their survival during storage time were dependent on the species and strain of associative yoghurt bacteria (control-only yoghurt lactic acid bacteria and experimental containing except yoghurt culture also *Bifidobacterium animalis* ssp. *lactis* BB-12) and on the packaging material (glass bottle versus plastic cup). It was observed, that counts of bifidobacteria were lower than counts of *Lactobacillus delbrueckii* ssp. *bulgaricus* (190 to 434×10^7 at 1d) and slowly increased ($p < 0.001$) at maximum level on day 7 ($294.3 - 754 \times 10^7$) and then slowly declined to 6.33×10^7 in glass bottle and 2.33×10^7 in plastic cups, respectively. *Lactobacillus delbrueckii* ssp. *bulgaricus* multiplied better in glass bottles than in plastic cups, as observed during experimental period in-group with *Bifidobacterium animalis* ssp. *lactis* BB-12. At the end of the storage period at 4 °C, viable counts of lactobacilli were higher ($p < 0.001$) in glass bottles. All the yoghurts, contained the recommended levels of lactobacilli and bifidobacteria (10^7 cfu.g⁻¹) at the end of storage period (21 d).

Keywords: survival; yoghurt bacteria; *Bifidobacterium animalis* ssp. *lactis* BB-12; acidity; storage temperature

INTRODUCTION

The first foods with probiotic bacteria were yogurts, and fermented milks are still the most important food vehicle for the delivery of probiotic bacteria. However, other foods have now appeared which carry probiotic bacteria. Numerous entries in the functional food market are linked to beverages, such as unfermented milk and fruit juices. Cheese is also gaining acceptance in the market. In addition to these commercial products, many research projects have been carried out which propose the addition of probiotics to chocolate, sausages, cereal products, dried products and vegetables. A multitude of food products contain lactic cultures and are subject to enrichment by probiotic bacteria (Hamann and Marth, 1983; Kailasapathy et al., 2008; Lovayová, 2007; Champagne, 2009).

Probiotics are applied as supporting nutritional supplements and the majority of chronic gastrointestinal diseases, where treatment of microbial flora can positively affect the health status and quality of life of these patients.

Considering to the safety of probiotics, exploring their still broader preventive and therapeutic using them early as in childhood, gets them into position became more attractive foods and dietary supplements (FAO/WHO, 2002; Lovayová et al., 2008). At present, most known probiotic organisms are bacteria, belonging to the *Lactobacillus* and *Bifidobacterium* genera.

The viability of lactobacilli and *Bifidobacterium* spp. in yogurts depends on a number of factors such as strain of probiotic bacteria incorporated, the yogurt starter cultures used. It is also fermentation time and storage conditions, pH of the yogurt (post-acidification during storage), sugar concentration (osmotic pressure), milk solids content, availability of nutrients, the presence of hydrogen peroxide, dissolved oxygen content (especially for *Bifidobacterium* spp.), buffering capacity and beta-galactosidase concentration in the yogurt (Dave and Shah, 1998; Shihata and Shah, 2000).

Lactobacillus delbrueckii ssp. *bulgaricus* is one of the two bacteria necessary for the production of yoghurts (Kandler and Weiss, 1984; Heller, 2001).

Shah (2000) reported that it is important to monitor the survival of probiotic lactobacilli because a number of products contain only a few viable bacteria by the time they reach the market.

Interest in the bifidobacteria started more or less contemporaneously, when Tissier described in the feces of breastfed infants the predominance of bacteria that produced lactic and acetic acid; these bacteria were bifurcated and which he named *Bacillus bifidus* (**Mitsuoka, 1990**), which was later called *Bifidobacterium*.

Bifidobacterium BB-12[®] (BB-12[®]) is a catalase-negative, rod-shaped bacterium. It was included in the cell culture bank of Chr. Hansen in 1983. At the time of isolation, BB-12[®] was considered to belong to the species *Bifidobacterium bifidum*. Modern molecular classification techniques reclassified BB-12[®] as *Bifidobacterium animalis* and later to a new species *Bifidobacterium lactis*.

The species *B. lactis* later shown not to fulfill the criteria for a species and was instead included in *Bifidobacterium animalis* as a subspecies. Today, BB-12[®] is classified as *Bifidobacterium animalis* subsp. *lactis*. Despite a change in the name over the years, the strain BB-12[®] has not changed (**Garrigues et al., 2005**).

It is strain that was specially selected by Chr. Hansen for the production of probiotic dairy products. BB-12[®] has been used in infant formula, dietary supplements and fermented milk products worldwide. This strain is technologically well suited, expressing fermentation activity, high aerotolerance, good stability and a high acid and bile tolerance, also as freeze-dried products in dietary supplements. Furthermore, BB-12[®] does not have adverse effects on taste, appearance or on the mouth feel of the food and is able to survive in the probiotic food until consumption (**Garrigues et al., 2010**).

MATERIAL AND METHODOLOGY

Sample preparation and yoghurt technology

Control yoghurt (yoghurt culture – *Streptococcus thermophilus* and *Lactobacillus delbrueckii* ssp. *bulgaricus*) and experimental probiotic yoghurt (*Streptococcus thermophilus*, *Lactobacillus delbrueckii* ssp. *bulgaricus* and *Bifidobacterium animalis* ssp. *lactis* BB-12) both of Chr. Hansen, were made from raw cow's milk after pasteurization at 85 °C for 15 seconds and cooling at 45 °C. To improve total solids content in yoghurt at 21%, the skim milk powder was added to the milk and stirred at high speed. After very well mixing, the mixture was heated at the high-pasteurized temperature as described above and kept at this temperature for 20 minutes. Then, the mixture was cooled to 43 ± 2 °C and yoghurt starter culture [2 g.100⁻¹ (w/w)] and *Bifidobacterium animalis* ssp. *lactis* BB-12 (experimental yoghurt) in the concentration of 107 CFU.g⁻¹ [1 g.100⁻¹ (w/w)] were added into the milk. Thereafter, after very well mixing, the mixtures were added into 150 mL cups (both, glass and plastic), sealed, labeled and incubated at the temperature of 43 ± 2 °C for 3.0 – 3.5 hours until titratable acidity of final product reached maximum 60 °SH. Then, the products were cooled in ice water bath and maintained under refrigeration temperature (4 °C) during 1, 7, 14, and 21 days.

The cultures used in this study were in freeze-dried (DVS) form and use according to the manufacturer recommendation.

Analyses of milk and yoghurt samples were done according to the **Commission regulation (EC) No 213/2001**.

Chemical analysis of raw milk

- For the experiment raw cow's milk free of antibiotic residues was used. Antibiotic residues in milk were determined by Beta star 25 tests, a commercial screening test (Neogen Food Safety, USA) before the yoghurt manufacturing. The antibiotic residue test was performed as described by manufacturer's instruction.
- The basic components of milk samples (milk proteins, fat, lactose, solids-non-fat (SNF), milk density and added water were determined using a LactiCheck ultrasonic milk analyzer (Page & Pedersen International, Ltd., USA). Temperature of the milk samples was 20 ± 1 °C.
- Titratable acidity of milk sample was determined by titration of milk with 0.25 mol.L⁻¹ NaOH and phenolphthalein as indicator and expressed in degrees of Soxhlet-Henkel (°SH).
- The somatic cell count was determined by the Fossomatic 90 (Denmark). Total bacteria count in milk was detected by the standard plate method using Plate count agar (Oxoid) at 30 °C for 72 hours.

Chemical analysis of yoghurt

The pH of yoghurts was determined with a digital pH meter (pH 340i/SET). The pH meter was calibrated using reference pH 4.0 and 7.0 buffered solutions as described by manufacturer's instruction. Titratable acidity of yoghurt samples was determined after mixing the yoghurt sample with 10 mL of hot distilled water (~90 °C) according to Soxhlet-Henkel and expressed in Soxhlet-Henkel degrees (°SH). All the analysis was performed in triplicate.

Microbiological analysis of yoghurt

For enumeration of *Lactobacillus delbrueckii* ssp. *bulgaricus* Lactobacillus MRS agar (Hi Media, India) agar was used. After suspension appropriately and dilution in sterile saline, the ten-fold dilutions were spread into selective medium as described above and incubated at 37 °C for 24 hour anaerobically. Enumeration of *Bifidobacterium animalis* ssp. *lactis* BB-12 was carried out through pour plate technique by using Bifidobacterium agar with L-cysteine hydrochloride (Hi Media, India) and incubated in modified atmosphere at 37 °C for 48 hours (**Fávaro-Trindade and Grosso, 2004**). In cases where no growth was detected, plates were re-incubated at 37 °C for an additional 24 hours. Numbers of bacteria stated for each sample are the means of replicated counts.

Depending on the number and morphological types of colony on a plate, three to five colonies of each type were randomly selected. After purification, isolates were examined for their morphology, Gram staining, and observed under a light microscope (Olympus BX 50, Japan) with a magnification of 1 000 x. For confirmation of bacteria present in yoghurts, one loop of the selected purified bacteria was mixed in a sterile vial containing

porous beads kept in glycerol as cryopreservative and serves as carriers to support microorganisms (Microbank) and stored at -20 °C for MALDI-TOF MS analysis.

MALDI-TOF MS analysis was performed on a Microflex MALDI Biotyper (Bruker Daltonik) according to a standard sample preparation protocol of Bruker Daltonik (Freiwald and Sauer, 2009). MALDI-TOF mass spectra were subjected to numerical analysis (BioTyper 3.1 software, Bruker Daltonik).

Statistical analysis

For statistical comparison of the results, statistical methods of processing and evaluation of the results were used to compare data processed into the tables and graph (MS Excel 2013). ANOVA parameter test and induction statistics methods un-pair t-test for testing means of related parameters. Correlation phi coefficient was used to assess the dependence of the relationship between the two nominal variables (IBM SPSS statistics 23).

Scientific hypothesis

The goal of the study, was to analyses a surviving *Lactobacillus delbrueckii* ssp. *bulgaricus* and *Bifidobacterium animalis* ssp. *lactis* BB-12 added for the manufacturing of probiotic yoghurt during the shelf-life up to 21 days which is mostly accepted by the consumers and which were packed into the screw glass bottles and plastic cups.

RESULTS AND DISCUSSION

Raw milk used for the manufacturing process was acceptable for yoghurt manufacturing process (data not shown).

The pH and titratable acidity changes during yoghurt storage are shown in Figure 1. An overall decline in the pH of all the stored yoghurts occurred during the study. The initial pH (day 1) ranged between 4.53 and 4.79 in plastic cup and glass bottle, respectively. There was a significant difference ($p < 0.05$) in pH between yoghurts in glass bottle and plastic cup during the experimental period. Titratable acidity increased significantly ($p < 0.05$) on day 21 of storage period at 4 °C. Higher lactic acid content was observed in yoghurt in plastic cup (47 °SH vs. 43 °SH on 1 d and 54 °SH vs. 49 °SH in day 21). There were any differences in acidity of yoghurts, both of control and

experimental groups, respectively. These results are in agreement with Tarakci and Erdogan (2003) who reported increased acidity of yoghurt over the storage period. Guler and Mutlu (2005) also observed an increase in titratable acidity during the storage period.

Changes in the viable counts of *Lactobacillus delbrueckii* ssp. *bulgaricus* and *Bifidobacterium animalis* ssp. *lactis* BB-12 during manufacturing and storage period (21d) of yoghurts are listed in Table 1. All lactic acid bacteria used in this study were confirmed by numerical analysis (MALDI-TOF MS) to be *Lactobacillus delbrueckii* ssp. *bulgaricus* and *Bifidobacterium animalis* ssp. *lactis* BB-12.

It was observed, that the initial counts of *Lactobacillus delbrueckii* ssp. *bulgaricus* were 280.3×10^7 cfu.g⁻¹ at day 1 in yoghurts (control) packed into glass bottles and 283.3×10^7 cfu.g⁻¹ in plastic cups, respectively. The count of lactobacilli in experimental group of yoghurt with probiotic strain of *Bifidobacterium animalis* ssp. *lactis* BB-12 was higher both in glass bottle (899×10^7 cfu.g⁻¹ and plastic cups 724.3×10^7 cfu.g⁻¹) at 1 d, respectively. This difference could possibly be due to the differences in different pH (4.79 vs. 4.53), respectively. After 1d storage period, the counts of *Lactobacillus delbrueckii* ssp. *bulgaricus* increased in control group of yoghurt samples and reached maximum at 3d period ($p < 0.001$) both for glass bottle and plastic cup. It could be due to the residual activity of *Lactobacillus delbrueckii* ssp. *bulgaricus* during this experimental period. This is in agreement with the rise in titratable acidity and drop in pH for this culture (Figure 1). For next storage periods, counts of *Lactobacillus delbrueckii* ssp. *bulgaricus* showed a sharp decline, which indicated the advantage for the viability of probiotic bacterium *Bifidobacterium animalis* ssp. *lactis* BB-12, used in this experiment (Table 1).

Our results are in agreement with data stated by Cruz et al. (2010), who submitted determination the shelf-life of probiotic flavored yoghurt supplemented with *Bifidobacterium animalis* DN 173010 W.

As shown in Table 1, counts of bifidobacteria were lower than counts of *Lactobacillus delbrueckii* ssp. *bulgaricus* (190 to 434.7×10^7 at 1d) and slowly increased ($p < 0.001$) at maximum level on day 7 ($294.3 - 754 \times 10^6$) and then slowly declined to 6.33×10^7 in glass bottle and 2.33×10^7 in plastic cups, respectively. The similar results were observed also by Dave and Shah (1997), Lovayová and

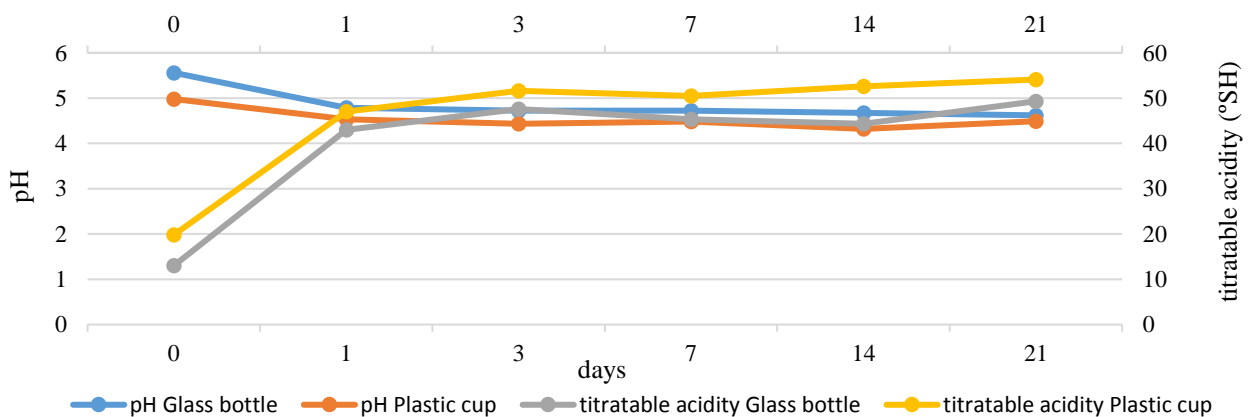

Figure 1 Change in pH and titratable acidity of experimental yoghurt during 21 days.

Table 1 Survival of *Lactobacillus delbrueckii* spp. *bulgaricus* and *Bifidobacterium animalis* spp. *lactis* BB-12 in yoghurts during storage period at 4 °C.

Storage period (days)	Control yoghur		Experimental yoghurt			
	<i>Lactobacillus delbrueckii</i> spp. <i>bulgaricus</i> (x 10 ⁷ cfu.g ⁻¹)		<i>Bifidobacterium animalis</i> spp. <i>lactis</i> BB-12 (x 10 ⁷ cfu.g ⁻¹)		<i>Lactobacillus delbrueckii</i> spp. <i>bulgaricus</i> (x 10 ⁷ cfu.g ⁻¹)	
	glass	plastic cup	glass	plastic cup	glass	plastic cup
1	280.3 ±17.62	283.3 ±28.01	190 ±15.52	434.7 ±20.82	899 ±25.94 ^a	724.3 ±31.09 ^a
3	602 ±168.2 ^b	454.7 ±291.4 ^b	284 ±11 ^a	645.3 ±42.39	261 ±340.7 ^a	160 ±285.1 ^a
7	113.3 ±10.21 ^b	172 ±228.7 ^b	294.3 ±9.45 ^a	754 ±22.72 ^a	408.7 ±19.5 ^a	127.3 ±19.6 ^a
14	44.3 ±4.16 ^a	36.33 ±2.52 ^a	26 ±30.51 ^a	132.7 ±17.47 ^a	6.33 ±0.58 ^a	5.3 ±0.58 ^a
21	216.7 ±10.2 ^a	3.67 ±0.58 ^a	6.33 ±0.58 ^a	2.33 ±0.58 ^b	11.67 ±1.53 ^a	7.33 ±0.58 ^b

Note: Results are the average of three independent assays. Results are expressed as ± means standard deviations. Unpaired t-tests were done to compare control and experimental group of yoghurts and glass bottle *versus* plastic cup. The probability (p) of a significant difference between the two values is identified with the following symbols: * represents $p < 0.05$, ** $p < 0.01$ and *** $p < 0.001$. All other comparisons had n.s. in the same row with different superscript lowercase letters are significantly different (a – $p < 0.001$, b – $p < 0.01$). Control yoghurt: yoghurt starter culture; experimental yoghurt: yoghurt starter culture and *Bifidobacterium animalis* spp. *lactis* BB-12.

Burdová (2008).

In general, from yoghurts manufactured only from yoghurt lactic acid bacteria and in yoghurts in which *Bifidobacterium* tested was included the viable counts of all enumerated bacteria were well above the recommended limit of 107.g⁻¹ during the storage period of 21 days at 4 °C.

Our results are also comparable with other recent studies (Martin and Chou, 1992; Lankaputhra and Shah, 1996). It seems that multiplication of *Bifidobacterium animalis* ssp. *lactis* BB-12 in experimental groups of yoghurts was due to the presence of *Lactobacillus delbrueckii* ssp. *bulgaricus* in this mixed culture. It is because the free amino acids that are produced by these lactic acid bacteria in yoghurt could have promoted the growth of bifidobacterium, which require free amino acids for its growth and development in yoghurt, respectively (Klaver et al., 1993).

As shown in Table 1, *Lactobacillus delbrueckii* ssp. *bulgaricus* multiplied better in glass bottles than in plastic cups, as observed during experimental period in-group with *Bifidobacterium animalis* ssp. *lactis* BB-12. Also at the end of the storage period at 4 °C, viable counts of lactobacilli were higher ($p < 0.001$) in glass bottles. This is in comparison with the count of *Bifidobacterium animalis* ssp. *lactis* BB-12, those counts were also significantly higher ($p < 0.001$) in yoghurts stored in glass bottle.

These differences could be associated with the limitation of the oxygen permeation in yoghurts filled into screw capped glass bottles, because dissolved oxygen content can have effect on titratable acidity, pH and viable counts of LAB as referred by Dave and Shah (1997). According to these authors, bifidobacteria preferred an environment with dissolved oxygen content and multiplied better in glass bottles than in plastic cups, which is in confirmation with the results of our experimental study.

As reported Burdová and Lovayová (2009) more carefully controlled studies in which energy intake and expenditure are measured needs to be conducted before any conclusions can be drawn regarding the positive effect of cultured dairy foods in humans and on weight gain and feed efficiency in animals. According to Nemcová et al. (2009), bacteria of dairy fermentation mainly of the

Lactobacillus genus create, apart from the known substances, many presently unidentified substances that are effective against harmful microorganisms. They have a protective influence in food storage, which can be used clinically. Start cultures are a part of useful microorganisms and their enzymes carry out important biochemical changes during the production process (Kačaniová et al., 2010).

CONCLUSION

The presence of *Lactobacillus delbrueckii* ssp. *bulgaricus* and *Bifidobacterium animalis* ssp. *lactis* BB-12 was confirmed at each of yoghurt samples packaged in both glass bottles and plastic cups during the completely experimental period of 21 d in total account of more than 107 cfu.g⁻¹ yoghurts. Although the counts of tested lactobacillus and bifidobacterium were significantly higher in yoghurts packaged in glass bottle, the plastic cups are although suitable for using as packaging material as followed from our experimental results. All manufactured yoghurts had high qualitative properties and contained lactic acid bacteria above recommended limit stated for these bacteria.

REFERENCES

Burdová, O., Lovayová, V. 2009. Food safety – Applying the principle “From stable to table” – experience and trends. In *Proceedings Škola – veda – prax I*. Košice : UVL, p. 91-94. ISBN 9788080771430.

Commission Regulation (EC) No 213/2001 of 9 January 2001 laying down detailed rules for the application of Council Regulation (EC) No 1255/1999 as regards methods for the analysis and quality evaluation of milk and milk products and amending Regulations (EC) No 2771/1999 and (EC) No 2799/1999.

Cruz, A. G., Walter, A. H. M., Cadena, R. S., Faria, J. A. F., Bolini, H. M. A., Pinheiro, H. P., Sant’Ana, A. S. 2010. Survival analysis methodology to predict the shelf-life of probiotic flavoured yoghurt. *Food Research International*, vol. 43, no. 5, p. 1444-1448. <https://doi.org/10.1016/j.foodres.2010.04.028>

Dave, R. I., Shah, N. P. 1997. Viability of yoghurt and probiotic bacteria in yoghurts made from commercial starter

- cultures. *International Dairy Journal*, vol. 7, no. 1, p. 31-41. [https://doi.org/10.1016/S0958-6946\(96\)00046-5](https://doi.org/10.1016/S0958-6946(96)00046-5)
- Dave, R. I., Shah, N. P. 1998. Ingredient supplementation effects on viability of probiotic bacteria in yogurt. *Journal of Dairy Science*, vol. 81, no. 11, p. 2804-2816. [https://doi.org/10.3168/jds.S0022-0302\(98\)75839-4](https://doi.org/10.3168/jds.S0022-0302(98)75839-4)
- FAO/WHO, 2002. Guidelines for the evaluation of probiotics in food: Report of a joint FAO/WHO working group on drafting guidelines for the evaluation of probiotics in food. (London, Ontario, Canada).
- Fávaro-Trindade, C. S., Grosso, C. R. F. 2004. Stability of free and immobilized *Lactobacillus acidophilus* and *Bifidobacterium lactis* in acidified milk and immobilized *B. lactis* in yoghurt. *Brazilian Journal of Microbiology*, vol. 35, no. 1-2, p. 151-156. <https://doi.org/10.1590/S1517-83822004000100025>
- Freiwald, A., Sauer, S. 2009. Phylogenetic classification and identification of bacteria by mass spectrometry. *Nature Protocols*, vol. 4, no. 5, p. 732-742. <https://doi.org/10.1038/nprot.2009.37>
- Garrigues, C., Stuer-Lauridsen, B., Johansen, E. 2005. Characterisation of *Bifidobacterium animalis* subsp. *lactis* BB-12 and other probiotic bacteria using genomics, transcriptomics and proteomics. *Australian Journal of Dairy Technology*, vol. 60, p. 84-92.
- Garrigues, C., Johansen, E., Pedersen, M. B. 2010. Complete genome sequence of *Bifidobacterium animalis* subsp. *lactis* BB-12, a widely consumed probiotic strain. *Journal of Bacteriology*, vol. 192, no. 9, p. 2467-2468. <https://doi.org/10.1128/JB.00109-10>
- Guler, A.; Mutlu, B. 2005. The effects of different incubation temperatures on the acetaldehyde content and viable bacteria counts of bio-yogurt made from ewe's milk. *International Journal of Dairy Technology*, vol. 58, p. 174-179. <https://doi.org/10.1111/j.1471-0307.2005.00209.x>
- Hamann, W. T., Marth, E. H. 1983. Survival of *Streptococcus thermophilus* and *Lactobacillus bulgaricus* in commercial and experimental yogurts. *Journal of Food Protection*, vol. 47, no. 10, p. 781-786. <https://doi.org/10.4315/0362-028X-47.10.781>
- Heller, K. J. 2001. Probiotic bacteria in fermented foods: product characteristics and starter organism. *American Journal of Clinical Nutrition*, vol. 73, no. suppl 2, p. 374-379.
- Champagne, C. P. 2009. Some Technological Challenges in the Addition of Probiotic Bacteria to Foods. In Charalampopoulos, D. and Rastall, R. A. *Prebiotics and Probiotics Science and Technology*. New York, USA : Springer-Verlag, 761 p. ISBN 978-0-387-79057-2. https://doi.org/10.1007/978-0-387-79058-9_19
- Kačániová, M., Angelovičová, M., Nováková, I., Pochop, J., Liptajová, D., Kliment, M., Kunová, S. 2010. Bacterial viability in probiotic bars. *Potravinárstvo*, vol. 4, no. 1, p.402-409. http://www.potravinarstvo.com/dokumenty/mc_februar_2010/pdf/4/Kacaniova.pdf
- Kandler, O., Weiss, N. 1984. Genus *Lactobacillus*. In: Sneath, P. H. A. et al. *Bergey's Manual of Systematics Bacteriology*. Baltimore M. D., USA : Williams and Wilkins, p. 1209-1234. ISBN 978-0-387-21609-6.
- Kailasapathy, K., Harmstorf, I., Phillips, M. 2008. Survival of *Lactobacillus acidophilus* and *Bifidobacterium animalis* ssp. *Lactis* in stirred fruit yoghurts. *LWT*, vol. 41, no. 7, p. 1317-1322. <https://doi.org/10.1016/j.lwt.2007.08.009>
- Klaver, F. A. M., Kingma, F., Weerkamp, A. H. 1993. Growth and survival of bifidobacteria in milk. *Netherlands Milk and Dairy Journal*, vol. 47, p. 151-164.
- Lankaputhra, W. E. V., Shah, N. P. 1996. A simple method for selective enumeration of *Lactobacillus acidophilus* in yogurt supplemented with *L. acidophilus* and *Bifidobacterium* spp. *Milchwissenschaft*, vol. 51, no. 8, p. 446-450.
- Lovayová, V. 2007. Probiotic influenced a gut microflora. In Proceedings Hygiene alimentorum XXVIII. Bratislava : Štátna veterinárna a potravinová správa SR, p. 297-298, ISBN 9788080770556.
- Lovayová, V., Majorová, E., Rimárová, K. 2008. Probiotic nutritional supplements and children health. In Proceedings from seminar of PhD. Students dedicated to academic Boďa: III. volume. Košice, p. 52-55, ISBN 9788096861828.
- Lovayová, V., Burdová, O. 2008. Assessment of probiotic activities in yoghurt during technological process and storage. *Mliekarstvo*, vol. 39, no. 4, p. 46-49.
- Martin, J. H.; Chou, K. M. 1992. Selection of *Bifidobacteria* for use as dietary adjuncts in cultured dairy foods: 1-tolerance to pH of yogurt. *Cultured Dairy Products Journal*, vol. 27, no. 4, p. 21-26.
- Mitsuoka, T. 1990. *Bifidobacteria* and their role in human health. *Journal of Industrial Microbiology & Biotechnology*, vol. 6, no. 4, p. 263-268. <https://doi.org/10.1007/BF01575871>
- Nemcová, R., Guba, P., Hajdučková, V., Stropfová, V., Lovayová, V. 2009. Viability of probiotic cultures in cheddar cheese. *International Journal of Probiotics and Prebiotics*, vol. 4, no. 2, p. 152-153. [https://doi.org/10.3168/jds.S0022-0302\(00\)74953-8](https://doi.org/10.3168/jds.S0022-0302(00)74953-8)
- Shah, N. P. 2000. Probiotic bacteria: selective enumeration and survival in dairy foods. *Journal of Dairy Science*, vol. 83, no. 4, p. 894-907. [https://doi.org/10.1016/S0958-6946\(00\)00072-8](https://doi.org/10.1016/S0958-6946(00)00072-8)
- Shihata, A., Shah, N. P. 2000. Proteolytic profiles of yogurt and probiotic bacteria. *International Dairy Journal*, vol. 10, no. 5-6, p. 401-408.
- Tarakci, Z., Erdogan, K. 2003. Physical, chemical, microbiological and sensory characteristics of some fruit-flavoured yogurt. *Y.Y.U. Veteriner Dergisi*, vol. 14, no. 2, p. 10-14.

Acknowledgments:

This work was financially supported by grant KEGA No. 005UVLF-4/2015.

Contact address:

Eva Dudriková, University of Veterinary Medicine and Pharmacy, Department of Food Hygiene and Technology, Komenského 73, 041 81 Košice, Slovakia, E-mail: eva.dudrikova@uvlf.sk

Mária Nagyová, University of P. J. Safarik in Košice, Faculty of Medicine, Department of Medical and Clinical Microbiology, tr. SNP 1, 040 11 Košice, Slovak Republic E-mail: maria.nagyova@upjs.sk

Zuzana Dičáková, University of Veterinary Medicine and Pharmacy, Department of Food Hygiene and Technology, Komenského 73, 041 81 Košice, Slovakia, E-mail: zuzana.dicakova@uvlf.sk



EFFECT OF THYME AND OREGANO AQUEOUS TEA INFUSIONS ON THE LIPID OXIDATION AND SENSORY CHARACTERISTICS OF FRANKFURKTERS SAUSAGES

Miroslav Kročko, Marek Bobko, Viera Ducková, Margita Čanigová, Peter Haščík, Jana Tkáčová

ABSTRACT

Lipid oxidation is one of the main limiting factors for the quality and acceptability of frankfurkter type of sausages. The antioxidant activity has been measured using a TBA assay. Dried oregano (*Origanum vulgare*) and thyme (*Thymus vulgare*) were purchased from a local store and kept in dark until the use. Aqueous extracts were prepared by one-step extraction with 3 g of each pulverized plant. Samples of freshly cooked sausages were evaluated by a 6 member semi-trained panel of laboratory co-workers. Panelists evaluate appearance overall texture, flavour, aroma and overall acceptability on a 6 point hedonic scale. In this work the antimicrobial and antioxidant effect of *Thymus vulgare* and *Origanum vulgare* significantly reduced ($p < 0.05$) lipid oxidation in frankfurkters sausages on 10th day of aerobic storage. The organoleptic changes in sausages had no negative effect on the sensory value of cooked sausages. Results obtained in this work indicated the technical viability of using the oregano and thyme aqueous tea infusions in relative low concentration, which is possible to enlarge the shelf-life of fresh sausages with the desired slight alteration of the original taste parameters. Results indicate that thyme and oregano aqueous tea infusions compare to essential oils can be cheaper alternative incorporate into pork frankfurkters as natural antioxidants.

Keywords: Frankfurkters; thyme; oregano; lipid oxidation; sensory quality

INTRODUCTION

The main advantage of essential oils with antibacterial and antioxidant activity is that they can be used in any food and are generally recognized as safe (GRAS) (USFDA, 2006), as long as their maximum effects are attained with minimal change in the organoleptic properties of the food (Viuda-Martos et al., 2009). It is well known that potency of essential oil in food system is generally reduced when compared to *in vitro* work, as the presence of fats, carbohydrates, proteins, salts and pH strongly influence the effectiveness of these agents (Burt, 2004). The food matrix can represent a physical hurdle and an essential oil dissolved in the fat of the food will be less available to act on bacteria present in aqueous phase. However, increased doses of essential oils required for food preservation, can also negatively influence taste or odor (Tserennadmid et al., 2010). On the other hand the water dispersible antioxidants most likely partitioned with the lipid phase, resulting in less protection of the more polar sarcoplasm to oxidation (Hayes et al., 2009). Extracts of oregano leaves contain flavanones, dihydroflavonols, favonols and flavones. Aqueous tea infusions from thyme and oregano represent a good source of the compounds with significant antioxidant activity.

Kulišić et al. (2006) found that oregano and thyme aqueous tea infusions have high amount of total phenols (12,500 mg.L⁻¹ gallic acid equivalent, GAE) and flavonoids (9,000 mg.L⁻¹ GAE). The rosmarinic acid was dominant in both oregano (123.11 mg.g⁻¹) and wild thyme (93.13 mg.g⁻¹). According to Matsuura et al. (2003) water soluble and antioxidant active ingredients from the oregano leaves were 4'-O-beta-D-glucopyranosyl-3',4'-dihydroxybenzylprotocatechuate and 4'-O-beta-D-glucopyranosyl-3',4'-dihydroxybenzyl-4-Omethylprotocatechuate.

The objective of this study was to examine antioxidant activity of thyme and oregano aqueous tea infusions in pork sausages and to evaluate sensory properties of cooked sausages after storage at 4 °C.

MATERIAL AND METHODS

Preparation of spice extracts

Dried oregano (*Origanum vulgare*) and thyme (*Thymus vulgare*) were purchased from a local store and kept in dark until the use. Aqueous extracts were prepared by one-step extraction with 3 g of each pulverized plants, placed in a flask with added 100 cm³ distilled water. The suspensions were incubated at 70 °C in water bath for

2 hours. After filtration through Whatman No. 4 the 5, 10 and 15 cm³ of each aqueous extracts were used per 1 kg of meat (Heilerová et al., 2003; Kulišić et al., 2006).

Preparation of meat products

The sausages were prepared from freshly boneless pork. Meat was purchased in local abattoir approximately 24 h after slaughter. Sausages were prepared using the following ingredients per 1 kg of meat: 18 g of mixture sodium nitrite and sodium chloride, 1.5 g powdered black pepper (*Piper nigrum*), 1 g sweet pulverized paprika (*Capsicum anum*), 0.2 g powdered nutmeg (*Myristica fragrans*), 0.2 g powdered allspice (*Pimenta officinalis*), 10 g cutter mix and 200 cm³ water. Following mincing, raw materials were assigned to one of six treatments. Control sausages (no added extracts); sausages with added 5, 10 and 15 mL.kg⁻¹ thyme; sausage with added 5, 10 and 15 mL.kg⁻¹ origanum. The sliced meat with ingredients was fine chopped by bowl vertical cutter PSP 500 (RM Gastro) for 5 minutes. Emulsified sausages were stuffed into polyamide casings (Ø 22 mm), cold smoked for 4 hours and heat treated in water bath until the temperature in the center of sausages reached the value 70 °C for 10 min. The sausages were stored in air conditions at 4 ± 1 °C and evaluated for antioxidant activity and sensory quality on 1st, 7th, and 10th days.

Determination of antioxidant activity

Lipid oxidation was assessed in triplicate by the 2-thiobarbituric acid (TBA) test following the recommendations of Grau et al. (2000) and measured by spectrophotometric method at 532 nm (Shimadzu UV/VIS – 1240). TBARS values were calculated from a standard curve of malondialdehyde (MDA) and expressed as mg MDA.kg⁻¹ sample. Antioxidant activity was analyzed on days 1st, 7th, and 10th in the raw sausages stored aerobically.

Sensory evaluation of cooked sausages

Samples of freshly cooked sausages were evaluated by a 6 member semi-trained panel of laboratory co-workers. Sausages were heat treated by boiling for 3 minutes. Samples were served within 1 min of cooking in random order to panelists. Panelists evaluate appearance overall texture, flavour, aroma and overall acceptability on a 6 point hedonic scale where 1 and 6 were the extremes of each characteristic.

Statistical analysis

The significance of differences among evaluations at each day of storage was determined by analysis of variance (ANOVA). Differences were considered significant at the *p* < 0.05 level. The geomean and standard deviation of the difference was also calculated. The entire experiment was replicated three times.

RESULTS AND DISCUSSION

Lipid oxidation is one of the main limiting factors for the quality and acceptability of this type of sausages. The antioxidant activity has been measured in the past using a TBA assay in model meat systems, showing a potential for protecting meat from oxidation (Ruberto, 1999).

Thyme and origanum aqueous tea infusions significantly reduced (*p* < 0.05) lipid oxidation in sausages on 10th day of aerobic storage. However, no significant differences (*p* > 0.05) on 7th day in sausages with added 5 mL/kg of thyme and 10 mL.kg⁻¹ of origanum, relative to control were observed (Figure 1).

Antioxidant potency of oregano essential oil for homogenized raw meat treatment was evaluated in work of Fasseas et al. (2007). In agreement with our results they found that essential oil significantly reduced the lipid oxidation of raw meat during twelve days of storage (4 °C). Salem et al. (2010) tested the addition of thyme,

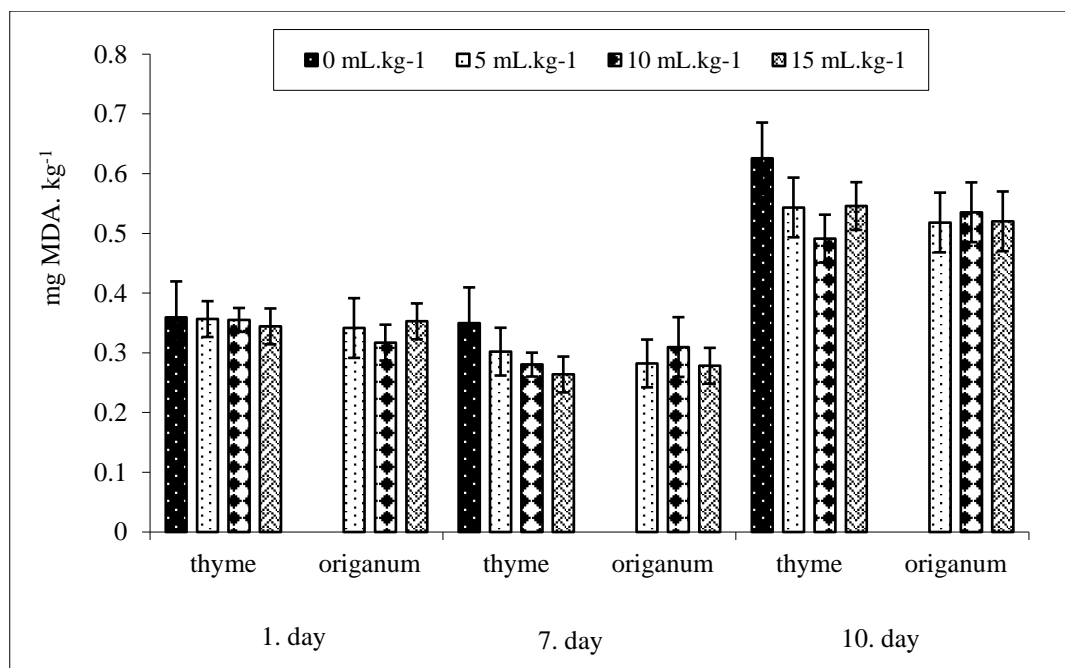

Figure 1 Effect of different amount thyme and origanum aqueous extracts on MDA production in sausages during 10 days storage.

Table 1 Sensory analysis of pork sausages after 24 hours of chilling storage.

Treatment	Appearance	Overall texture	Aroma	Flavour	Overall acceptability
5 mL thyme	4.18	4.18	4.05	4.09	4.12
10 mL thyme	4.21	4.18	4.05	4.10	4.14
15 mL thyme	4.20	4.19	4.20	4.28	4.21
5 mL origanum	4.23	4.23	4.09	4.03	4.14
10 mL origanum	4.22	4.17	4.08	4.01	4.12
15 mL origanum	4.23	4.18	4.05	4.05	4.13
Control	4.24	4.18	4.05	4.02	4.12

garlic and lemongrass essential oils as antioxidants and antimicrobials in minced beef. The obtained results of these authors indicated significantly lower value of TBA in tested groups relative to control. This is generally in agreement with other research studies that have investigated the effects of oregano essential oil in meat protection from oxidation through feeding (Botsoglou et al., 2002; Botsoglou et al., 2003).

In the past few years, a variety of plant materials containing phenolic compounds have been to be effective antioxidants in model systems. Since ancient times, herbs and spices have been added to food to improve sensory properties and prolong shelf life. Among the main objections against the use of spices as antioxidants, is the characteristic flavor which they give to the meat products. However, this could be turned towards a positive new exciting sensory sensation. The acceptability of the taste of highly spiced food is transmitted both culturally and genetically, and the countries with hotter climate use spices more frequently and at much higher levels than countries with cooler climates (Salem et al., 2010).

Appearance and overall texture were not affected by the addition of thyme and origanum (Table 1). The positive effect and significantly ($p < 0.05$) higher values for aroma, flavour and overall acceptability were recorded for the sausages with 15 mL.kg⁻¹ of thyme addition, which could be associated with the presence of thyme odor. The organoleptic changes in sausages with origanum addition were not significant ($p > 0.05$) and had no negative effect on the sensory value of cooked sausages. The results are in agreement with Viuda-Martos et al. (2008). They found that use of citrus waste water and oregano or thyme essential oil as ingredients of the fine meat paste used to produce bologna-type sausage had no negative effect on any of the chemical or physical properties assessed. Their addition to cooked meat products is a viable alternative for increasing the oxidative stability of the samples, while reducing nitrite levels. Solomakos et al. (2008) tested the antimicrobial effect of thyme essential oil against *Listeria monocytogenes* in minced beef. They found that 0.3% essential oil possessed weak antimicrobial activity, whereas at 0.9% showed unacceptable organoleptic properties in minced meat. The level of 0.6% thyme essential oil showed positive organoleptic effect and stronger inhibitory activity at 10 °C than at 4 °C.

CONCLUSION

The MDA assay data showed that the addition of the antioxidants can offer sufficient protection, which can be seen from the higher MDA values in the control compared to the oregano and thyme sausages. Results obtained in this work indicated the technical viability of using the

oregano and thyme aqueous tea infusions in relative low concentration, which is possible to enlarge the shelf-life of fresh sausages with the desired slight alteration of the original taste parameters. Results indicate that thyme and oregano aqueous tea infusions compare to essential oils can be cheaper alternative incorporate into pork frankfurters as natural antioxidants.

REFERENCES

- Botsoglou, N. A., Christaki, E., Fletouris, D. J., Florou-Paneri, P., Spais, A. B. 2002. The effect of dietary oregano essential oil on lipid oxidation in raw and cooked chicken during refrigerated storage. *Meat Science*, vol. 62, no. 2, p. 259-265. [https://doi.org/10.1016/S0309-1740\(01\)00256-X](https://doi.org/10.1016/S0309-1740(01)00256-X)
- Botsoglou, N. A., Fletouris, D. J., Florou-Paneri, P., Christaki, E., Spais, A. B. 2003. Inhibition of lipid oxidation in long-term frozen stored chicken meat by dietary oregano essential oil and a-tocopheryl acetate supplementation. *Food Research International*, vol. 36, no. 3, p. 207-213. [https://doi.org/10.1016/S0963-9969\(02\)00095-9](https://doi.org/10.1016/S0963-9969(02)00095-9)
- Burt, S. 2004. Essential oils: their antibacterial properties and potential applications in foods. *International Journal of Food Microbiology*, vol. 94, no. 3, p. 223-253. <https://doi.org/10.1016/j.ijfoodmicro.2004.03.022> PMID:15246235
- Fasseas, M. K., Mountzouris, K. C., Tarantilis, P. A., Polissiou, M., Zervas, G. 2007. Antioxidant activity in meat treated with oregano and sage essential oils. *Food Chemistry*, vol. 106, no. 1, p. 1188-1194.
- Grau, A., Guardiola, F., Boatella, M., Barroeta, A., Codony, R. 2000. Measurement of 2-thiobarbituric acid values in dark chicken meat through derivative spectrophotometry: influence of various parameters. *Journal of Agricultural and Food Chemistry*, vol. 48, no. 4, p. 1155-1159. <https://doi.org/10.1021/jf990518q> PMID:10775365
- Hayes, J. E., Stepanyan, V., Allen, P., O'Grady, M. N., O'Brien, N. M., Kerry, J. P. 2009. The effect of lutein, sesamol, ellagic acid and olive leaf extract on lipid oxidation and oxymyoglobin oxidation in bovine and porcine muscle model systems. *Meat Science*, vol. 83, no. 2, p. 201-208. <https://doi.org/10.1016/j.meatsci.2009.04.019> PMID:20416759
- Heilerová, E., Bučková, M., Tarapčík, P., Šilhár, S., Labuda, J. 2003. Comparison of antioxidative activity data for aqueous extracts of lemon balm, oregano, thyme and agrimony obtained by conventional methods and the DNA – Based Biosensor. *Czech Journal of Food Sciences*, vol. 21, p. 78-84.
- Kulišić, T., Dragović-Uzelac, V., Miloš, M. 2006. Antioxidant activity of aqueous tea infusions prepared from oregano, thyme and wild thyme. *Food Technology and Biotechnology*, vol. 44, no. 2, p. 485-492.

Matsuura, H., Chiji, H., Asakawa, C., Amano, M., Yoshihara, T., Mizutani, J. 2003. DPPH radical scavengers from dried leaves of oregano (*Origanum vulgare*). *Bioscience Biotechnology Biochemistry*, vol. 67, no. 11, p. 2311-2316. <https://doi.org/10.1271/bbb.67.2311>
PMid:14646188

Ruberto, G., Baratta, M. T. 1999. Antioxidant activity of selected essential oil components in two lipid model systems. *Food Chemistry*, vol. 69, no. 2, p. 167-174. [https://doi.org/10.1016/S0308-8146\(99\)00247-2](https://doi.org/10.1016/S0308-8146(99)00247-2)

Salem, A. M., Amin, R. A., Afifi, G. S. A. 2010. Studies on antimicrobial and antioxidant efficiency of some essential oils in minced beef. *Journal of American Science*, vol. 6, no. 12, p. 691-700.

Solomakos, N., Govaris, A., Koidis, P., Botsoglou, N. 2008. The antimicrobial effect of thyme essential oil, nisin, and their combination against *Listeria monocytogenes* in minced beef during refrigerated storage. *Food Microbiology*, vol. 25, no. 1, p. 120-127. <https://doi.org/10.1016/j.fm.2007.07.002>
PMid:17993385

Tserennadmid, R., Takó, M., Galgóczy, L., Papp, T., Vágvölgyi, C., Geró, L., Krisch, J. Antibacterial effect of essential oils and interaction with food components. *Central European Journal of Biology*, vol. 5, no. 5, p. 641-648. <https://doi.org/10.2478/s11535-010-0058-5>

Viuda-Martos, M., Ruiz-Navajas, Y., Fernández-López, J. 2008. Antifungal activity of lemon (*Citrus lemon* L.), mandarin (*Citrus reticulata* L.), grapefruit (*Citrus paradisi* L.) and orange (*Citrus sinensis* L.) essential oils. *Food Control*, vol. 19, no. 12, p. 1130-1138. <https://doi.org/10.1016/j.foodcont.2007.12.003>

Viuda-Martos, M., Ruiz-Navajas, Y., Fernández-López, J., Pérez-Álvarez, J. A. 2009. Effect of adding citrus waste water, thyme and oregano essential oil on the chemical, physical and sensory characteristics of a bologna sausage. *Innovative Food Science and Emerging Technologies*, vol. 10, no. 4, p. 655-660. <https://doi.org/10.1016/j.ifset.2009.06.001>

U.S Food and Drug Administration. 2006. Food additive status list [online] s.a. [21.1.2017] Available at: <http://www.cfsan.fda.gov/~dms/opa-appa.html#ftn.H>.

Contact address:

Miroslav Kročko, Slovak University of Agriculture, Faculty of Biotechnology and Food Sciences, Department for Evaluation and Processing of Animal Products, Tr. A. Hlinku 2, 949 76 Nitra, Slovakia, E-mail: mirokrocko@yahoo.com

Marek Bobko, Slovak University of Agriculture, Faculty of Biotechnology and Food Sciences, Department for Evaluation and Processing of Animal Products, Tr. A. Hlinku 2, 949 76 Nitra, Slovakia, E-mail: marek.bobko@uniag.sk

Viera Ducková, Slovak University of Agriculture, Faculty of Biotechnology and Food Sciences, Department for Evaluation and Processing of Animal Products, Tr. A. Hlinku 2, 949 76 Nitra, Slovakia, E-mail: viera.duckova@uniag.sk

Margita Čanigová, Slovak University of Agriculture, Faculty of Biotechnology and Food Sciences, Department for Evaluation and Processing of Animal Products, Tr. A. Hlinku 2, 949 76 Nitra, Slovakia, E-mail: margita.canigova@yahoo.com

Peter Haščík, Slovak University of Agriculture, Faculty of Biotechnology and Food Sciences, Department for Evaluation and Processing of Animal Products, Tr. A. Hlinku 2, 949 76 Nitra, Slovakia, E-mail: peter.hascik@uniag.sk

Jana Tkáčová, Slovak University of Agriculture, Faculty of Biotechnology and Food Sciences, Department for Evaluation and Processing of Animal Products, Tr. A. Hlinku 2, 949 76 Nitra, Slovakia, E-mail: jana.tkacova@uniag.sk

THE INVESTIGATION OF ALFALFA EFFECT ON THE ACTIVITY OF SUPEROXIDE DISMUTASE IN CHICKEN MEAT in dependence on TIME STORAGE

Jana Tkáčová, Mária Angelovičová, Marcela Capcarová, Adriana Kolesárová, Monika Schneidgenová, Adriana Pavelková, Marek Bobko, Juraj Čuboň

ABSTRACT

This study was conducted in order to monitor the effect of adding lucerne meal to chicken feed mixtures. The experiment was conducted at the Department Food Hygiene and Safety, Faculty of Biotechnology and Food Science, Slovak University of Agriculture in Nitra. Chickens for meat production - final type Cobb 500 were used in the experiment. Chickens were placed in boxes all together for one group at the beginning of the experiment and from 14 days of age chickens were divided individually into floor enriched cages. Feeding of chickens lasted 38 days. The experiment was carried out without sex segregation. For the production of a feed composition was used alfalfa (*Medicago sativa*) as lucerne meal, which was added to the feed at a rate of 4%, namely: starter (HYD-01), growth (HYD-02) and final (HYD-03). The control group did not include the addition of lucerne meal. Chickens were fed *ad libitum*. Chickens were slaughtered after completion of feeding and the meat samples were taken for analysis. The collected samples were stored at -18 °C. Collected samples of meat were analyzed after slaughter chickens at time intervals of 6, 12 and 18 months. In the experiment was monitored the content of superoxid dismutase in the chicken meat depending on the length of storage time. Superoxide dismutase content was increasing by storage time, while there were some statistically significant differences between groups.

Keywords: oxidation, superoxid dismutase, lucerne meal, meat, chicken, time storage

INTRODUCTION

Oxidation processes are one of the primary mechanisms of quality deterioration in meat and meat products because they lead to the degradation of lipids and proteins (including haem pigments) and they cause the loss of flavour, colour and nutritive value and limit the shelf-life of meat and meat products (Kanner, 1994; Karwowska et al., 2007).

The mechanisms of oxidative degradation can be autooxidation in presence of atmospheric oxygen (Angelovič et al., 2015).

Lipid peroxidation is a primary cause of quality deterioration in meat and meat products. Free radical chain reaction is the mechanism of lipid peroxidation and reactive oxygen species (ROS) such as hydroxyl radical and hydroperoxyl radical are the major initiators of the chain reaction. Lipid peroxy radical and alkoxy radical formed from the initial reactions are also capable of abstracting a hydrogen atom from lipid molecules to initiate the chain reaction and propagating the chain reaction (Min and Ahn, 2005).

Enzymes such as superoxid dismutase, katalase and glutation peroxidase can prevent of meat oxidation because they have influence to oxidation of muscle fiber (Daun and Akesson, 2004; Tkáčová and Angelovičová, 2013).

The superoxide dismutases (SODs) are the first and most important line of antioxidant enzyme defense systems against ROS and particularly superoxide anion radicals. At present, three distinct isoforms of SOD have been identified in mammals, and their genomic structure, cDNA, and proteins have been described (Chang et al., 1988; Keller et al., 1991; Crapo et al., 1992; Liou et al., 1993; Zelko et al., 2002).

Superoxide dismutases (SODs) are metalloenzymes found widely distributed in prokaryotic and eukaryotic cells (Fridovich, 1995; Johnson and Giulivi, 2005).

These SODs are historically designated, in higher eukaryotes, by their primary location as follows: SOD1 (cytoplasmic), SOD2 (mitochondrial) and SOD3 (extracellular) (Marklund, 1984; Johnson and Giulivi, 2005).

The superoxide dismutases (SODs) are ubiquitous components of cellular antioxidant systems. As described by McCord and Fridovich over 47 years ago, these proteins protect redox sensitive cellular machinery from damage by catalyzing the disproportionation of superoxide anion to oxygen and hydrogen peroxide (McCord and Fridovich, 1969; Culotta et al., 2006).

Zhou and Prognon (2006) dates discovery of the protein superoxide dismutase (SOD, EC 1.15.1.1) in 1969.

Superoxide dismutase is pervasive metalloenzyme in aerobic organisms (Bannister, 1987). Belongs to the superoxide dismutase enzyme groups, which in SOD molecules content metal - copper, zinc, manganese (Crapo et al, 1992). Copper/zinc superoxide dismutase is widely distributed in eukaryotes, whereas the iron-manganese superoxide dismutase is primarily found in the mitochondria or in prokaryotes (Fridovich, 1986). Copper / zinc are mainly presented in the cytosol (Steinman, 1982). The main function of superoxide dismutase is dismutating. It provides protection of biological tissue before not controlled reactive oxygen species (Crapo et al., 1992), especially before superoxide radicals (Rotilio Bannister, 1987). It is believed that superoxide dismutase belongs to among the most important line of antioxidant enzyme defense systems (Fridovich, 1995). Superoxide dismutase helps to use zinc, copper with manganese in the body (Bannister Rotilio, 1987; Tkáčová and Angelovičová, 2013).

Functions of superoxide dismutase have been widely studied by many authors. They have found that it have impact on the various human diseases, such as arteriosclerosis, diabetes mellitus, Down syndrome (Kakko et al., 2003; Haskins et al., 2004; Engidawork and Luberc; 2001, Culotta et al., 2006).

The strongest connection between SODs and human disease is found for the copper and zinc dependent forms, mutations in which can cause the neurodegenerative disease amyotrophic lateral sclerosis (ALS) (Rosen et al., 1993; Culotta et al., 2006).

The role of superoxide dismutase is to accelerate the dismutation of the toxic superoxide radical ($O_2^{\cdot-}$), produced during oxidative energy processes, to hydrogen peroxide and molecular oxygen (Randox, 2009).

Nowadays there is a strong tendency towards isolating organic antioxidants from natural sources as alternative methods to retard oxidative processes in meat and meat products (Wenk, 2003; Karwowska et al., 2007).

The addition of antioxidants to meat products is known to be effective in colour stability and lipid oxidation. Many authors report about the benefits of adding vitamin E (Buckley et al., 1995; Faustman et al., 1998; Haak et al., 2006; Houben and Gerris, 1998), tea catechins rosemary extract in the compound feed (O'Grady et al., 2006) Thereby affecting meat quality (Karwowska et al., 2007), but in the literature are little reports with information about the benefits alfalfa diets for the oxidation of meat.

Alfalfa is well balanced in amino acids and rich in vitamins, carotenoids (Sen, 1998) and saponins (Whitehead, 1981). Carotenoids are polyenoic terpenoids having conjugated trans-double bonds. They include carotenes (β -carotene and lycopene), which are polyene hydrocarbons, and xanthophylls (lutein, zeaxanthin, capsanthin, canthaxanthin, astaxanthin, and violaxanthin)

having oxygen in different form (Bonnie, 2000; Tkáčová and Angelovičová, 2013).

Moreover, the alfalfa has anti-carcinogenic and antioxidant effects (Rao and Gurfinkel, 2000; Tkáčová and Angelovičová, 2013).

The aim of the experiment was to determine an activity of superoxide dismutase in chicken meat in dependence on time storage. Meat samples were analyzed after time storage 6, 12, 18 months.

Scientific hypothesis

At the beginning of our experiment we supposed that the storage of chicken meat will increase the activity of superoxide dismutase. We also supposed that will be statistical confirmed differences of superoxide dismutase activity between groups of chickens and between storage periods (6, 12, 18 months).

MATERIAL AND METHODOLOGY

The experiment was performed at the experimental facility of the Department Food Hygiene and Safety, Faculty of Biotechnology and Food Science, Slovak University of Agriculture in Nitra. At the start of the experiment the chickens was housed in the box and they were divided individually into two-storey enriched cages from 14 days of age. In the experiment were used chickens for meat production - final type Cobb 500.

The experiment was performed according to the scheme: total experimental period chickens were divided into three phases according to the type of the feed mixtures:

- a) the starter, it was intended for chickens from hatching to 18 days of age; during this time chickens received starter feed mixture HYD 01, in the experimental group it was enriched with 4% alfalfa meal,
- b) growth, it was intended for chickens from days 19 to 31 of age; chickens fed the growth feed mixture HYD 02 during this time, in the experimental group it was enriched with 4% alfalfa meal,
- c) final, it was intended for chickens from days 32 to 38 of age; chickens fed a final feed mixture HYD 03 during this time, in the experimental group it was enriched with 4% alfalfa meal.

The company Biofeed a. s. Kolárovo produced feed mixtures. The feed mixtures in powder form were used. Alfalfa was used to the mixture in the vegetation phase of pucks by drying. Chickens were slaughter at the Department of Evaluation and Processing of Animal Products. The collected meat samples were stored at $-18^{\circ}C$.

Preparation of the samples

The sample preparation was determined by modified method of Jung and Henke (1996).

This method employs xanthine and xanthine oxidase (XOD) to generate superoxide radicals which react with 2-(4-iodophenyl)-3-(4-nitrophenol)-5-phenyltetrazolium chloride (I.N.T.) to form a red formazan dye. The superoxid dismutase activity is then measured by the degree of inhibition of this reaction. One unit of SOD is that which causes a 50% inhibition of the role of reduction of INT under the conditions of the assay (Randox, 2009).

1 gram of sample was flushed with ice-cold 154 mM NaCl solution, subsequently, the sample is placed in

homogenization medium, consisting of 250mM mannitol, 70 mM sucrose, 1 mM EDTA and the solution is adjusted with Tris to pH 7.4.

After homogenization of tissue in homogenization solution, the sample was centrifuged 10 min at 800xg in a centrifuge SW 14 FROILABO (Meyzieu, France). The supernatant was used as a homogenate.

In cold environments, sonication was performed on the unit UP 100 H Ultrasonic Processor Companies Hielscher 300W (Hielscher, Germany) in three 10-second intervals. Finally, the sample was centrifugated at 14000xg in 10 minutes.

The resulting supernatant was pipetted into a test tube and stored at -70 °C until analysis.

The prepared sample is measured using a kit RANSOD superoxide dismutase, Diluent and Control from Randox. After preparation of the various reagents and calibration solutions are measured activity of superoxide dismutase by spectrophotometry at 505 nm and 37 °C.

The concentration of superoxide dismutase was read from the calibration curve dependence of absorbance and concentrations of superoxide dismutase.

The resulting value of the contents of superoxide dismutase was expressed as SOD units, U.g⁻¹ of muscle.

Statistical analysis

The data obtained from experiment were evaluated according to basic statistical characteristic (average, s = standard deviation, CV = coefficient of variation). Difference between groups was tested according to Scheffe’s test (α = 0.05). It was used ANOVA in the programSAS version 9.1.

RESULTS AND DISCUSSION

Different authors **Suksombat and Buakeeree (2006)**, **Al-Haweizy and Al-Sardary (2007)**, **Bobko et al. (2012)** and **Tkáčová et al. (2015)** studied the influence of lucerne meal on production quality by adding different proportions of lucerne meal to feed mixtures. It has been found that the best contents of lucerne meal is 4% in a feed mixtures.

Superoxide dismutase activity has rising tendency during time storage as the control group and the experimental group (Figure 1).

The average activity of superoxide dismutase after time storage of meat 6 months at -18 °C was at the level of 14.57 U.g⁻¹ and in the control group reached almost the same value 14.08 U.g⁻¹.The difference in the activity of superoxide dismutase was not statistically significant (p >0.05) after time storage of meat 6 months at -18 °C between the groups.

The average activity of superoxide dismutase after time storage of meat 12 months was at the level of 46.3 U.g⁻¹ in group with a share of 4% lucerne meal and in control group 38.6 U.g⁻¹.The difference in the activity of superoxide dismutase was statistically significant (p <0.05) after time storage of meat 12 months of storage of the meat at -18 °C between the groups.

The average activity of superoxide dismutase was grouped with a share of 4% lucerne meal at the level of 52.30 U.g⁻¹ after time storage of meat 18 months of at -18 °C and in the control group 34.58 U.g⁻¹.The difference in the activity of superoxide dismutase was statistically significant (p <0.05) after time storage of meat 18 months at -18 °C between the groups.

Statistical differences between all groups in the experiment are shown in Table 1.

Authors are explaining alfalfa contains in addition to compounds with antioxidant properties and also substances that have a negative impact on production - a high proportion of fiber, low energy value (**Dansk, 1971; Suksombat and Buakeeree, 2006**) compared to other feed. Alfalfa contains a high level of anti-nutritional factors - saponins (**Francis et al., 2002; Stochmal et al., 2001**).

Few authors, however deals with the effect of lucerne meal feeding in chicken meat on oxidation.

Gibbs et al. (2013) argues, based on feed experiments that it is possible to influence the content of unsaturated fatty acids in chicken meat by adding fishmeal to the feed mixture, and thus the feeding can affect the subsequent oxidation of meat. **Hugo et al. (2009)** applied fish oil and sunflower oil into chicken feed mixture.

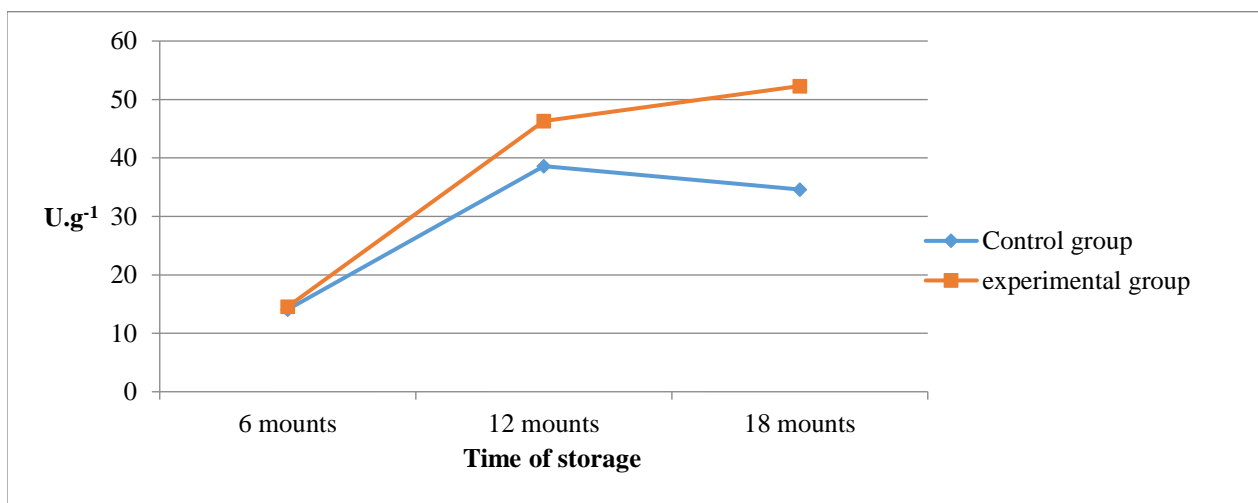

Figure 1 The activity of superoxide dismutase in dependente to different time storage of meat at -18 °C.

Table 1 Statistical evaluation of the differences of superoxide dismutase activity between the different time storage of meat at -18 °C and between groups of chickens.

F-test	21,15 ⁺⁺⁺					
Group	K 06	E 06	K 12	E 12	K 18	E 18
K 06		-	+++	+++	+++	+++
E 06			+++	+++	+++	+++
K 12				-	-	-
E 12					-	-
K 18						+++

The effect of dietary supplementation with extracted alfalfa meal (2 g per 1 kg diet) on oxidative stability studied Karwowska et al. (2007). The results did not indicate the influence of dietary supplementation with extracted alfalfa meal on the changes of lipid oxidation of smoked ham. During the storage period (14 days) of control and experimental ham slight changes of TBARs values were noted.

Dong et al. (2011) indicates in their work polysavone modulates antioxidation properties and modifies meat quality, but with no adverse effect on performance of broiler chickens.

Castellini et al. (2002) carried out the experiment with chickens. They fed chickens with feed mixture with 2.8% of dehydrated alfalfa meal. These organic chickens had lower levels of abdominal fat. Polyunsaturated fatty acids of n-3 series and TBA-RS were higher. A negative aspect was the higher level of TBA-RS in the muscles, probably due to greater physical activity.

Similarly, Lu et al. (2006) says the addition of the supplemental Mn did not influence (p>0.05) content of malondialdehyde (MDA) and activity of Mn-containing superoxide dismutase (MnSOD) in breast muscle and activity of malate dehydrogenase (MDH) and hormone sensitive lipase (HSL) activity in abdominal fat too.

The primary difficulty in assaying Superoxide dismutase (SOD) for its enzymatic activity consists in the free radical nature of its substrate O₂^{•-} which can only be supplied by generation within the assay medium. The substrate O₂^{•-} cannot easily be detected directly by conventional analytical tools (Flohé and Ötting, 1984).

Barriere et al. (2001) performed experiment where they used *Staphylococcus xylosus* as starter culture in sausages. He was to characterize the roles of catalase and superoxide dismutase (SOD) in the inhibition of free fatty acid oxidation by the *S. xylosus*. SOD of *S. xylosus* contributed to the inhibition of lipid oxidation.

CONCLUSION

Alfalfa is interesting object examining not only for human nutrition but also in animal nutrition for their content of biologically active substances. It can be used for nutrition of chickens but only in limited quantities because a higher proportion 6% or more has a negative impact on production. On the basis of experimental results we can state that proportion of alfalfa in feed mixture can have positive effect on activity of superoxide dismutase. It is appropriate to include of alfalfa in chicken feed mixtures for its other benefits.

REFERENCES

- Al-Haweizy, A., Al-Sardary, S. Y. 2007. Effect of Dehydrated Alfalfa and Ageon Egg Weight, Egg mass, Feedintake, and Feed Conversion efficiency HYLINEW-98 Layers. *Slovak J. Anim. Sci.*, vol. 40, no. 1, p. 19-23.
- Angelovič, M., Jablonický, J., Tkáč, Z., Angelovič, M. Oxidative Stability of Fatty Acid Alkyl Esters: a review. *Potravinárstvo Slovak Journal of Food Sciences*, vol. 9, no. 1, p. 417-426. <http://dx.doi.org/10.1016/j.fuproc.2009.06.009>
- Bannister, J. V., Bannister, W. H., Rotilio, G. 1987. Aspects of the structure, function, and applications of superoxide dismutase. *CRC Crit. Rev. Biochem.*, vol. 22, p. 111-180. <https://doi.org/10.3109/10409238709083738>
- Barrière, C., Centeno, D., Lebert, A., Leroy-Sétrin, S., Berdagué, J. L., Talon, R. 2001. Roles of superoxid dismutase and catalase of *Staphylococcus xylosus* in the inhibition of linoleic acid oxidation. *FEMS Microbiology Letters*. 201, 181-185. <https://doi.org/10.1111/j.1574-6968.2001.tb10754.x>
- Bobko, M., Haščík, P., Bobková, A., Kňazovická, V., Tóth, T., Angelovičová, M. 2012. Influence of different plant supplements applied in chicken nutrition on quality of their meat. *J. Mikrob. Biot. Food Sci.* vol. 1, Special issue, p.1020-1031.
- Bonnie, B. T., Choo, Y. M. 2000. Valuable minor constituents of commercial red palm olein: carotenoids, vitamin E, ubiquinone and sterols. *J. Oil Palm. Res.*, vol. 12, p. 14-24.
- Buckley D. ., Morrissey P. A., Gray J. I. 1995. Influence of dietary vitamin E on the oxidative stability and quality of pig meat. *J. Anim. Sci.*, 73, 3122-3130. <https://doi.org/10.2527/1995.73103122x>
- Castellini, C., Mugnai, C., Dal Bosco, A. 2002. Effect of organic production system on broiler carcass and meat quality. *Meat Science*, 60, p. 219-225. [https://doi.org/10.1016/s0309-1740\(01\)00124-3](https://doi.org/10.1016/s0309-1740(01)00124-3)
- Crapo, J. D., Oury, T., Rabouille, C., Slot, J. W., Chang, L.-Y. 1992. Copper, zinc superoxide dismutase is primarily a cytosolic protein in human cells. *Proc. Natl. Acad. Sci. USA*. 89, p. 10405-10409. <https://doi.org/10.1073/pnas.89.21.10405>
- Culotta, V. C., Yang, M., O'Halloran, T. V. 2006. Activation of superoxide dismutases: Putting the metal to the pedal. *Biochimica et Biophysica Acta*, 1763, p. 747-758. <https://doi.org/10.1016/j.bbamer.2006.05.003>
- Dansk, L. M. 1971. A role for alfalfa in high efficiency broiler rations. *Poult. Sci.*, vol. 50, p. 1569-1574.
- Daun, Ch., Åkesson, B. 2004. Comparison of glutathione peroxidase activity, and of total and soluble selenium content in two muscles from chicken, turkey, duck, ostrich and lamb. *Food Chemistry*, vol. 85, p. 295-303. <https://doi.org/10.1016/j.foodchem.2003.07.009>
- Dong, X. F., Gao, W. W., Su, J. L., Tong, Dr. J. M., Zhang, Q. 2011. Effects of dietary polysavone (Alfalfa extract) and chlortetracycline supplementation on antioxidation and meat

- quality in broiler chickens. *Journal British Poultry Science*, vol. 52, issue 3, p. 302-309. <https://doi.org/10.1080/00071668.2011.569008>
- Engidawork, E., Lubec, G. 2001. Protein expression in Down syndrome brain. *Amino Acids*, 21, p. 331-361. <https://doi.org/10.1007/s007260170001>
- Faustman C., Chan W. K. M., Schaefer D. M., Havens A. 1998. Beef color update: the role for vitamin E. *J. Anim. Sci.*, 76, 1019-1026. <https://doi.org/10.2527/1998.7641019x>
- Flohé, L., Ötting, F. 1984. Superoxide dismutase assays. *Methods in Enzymology. Oxygen Radicals in Biological Systems. B. Isolation, purification, characterization, and assay of antioxygenic enzymes.* Vol. 105, p. 93-104. [https://doi.org/10.1016/s0076-6879\(84\)05013-8](https://doi.org/10.1016/s0076-6879(84)05013-8)
- Francis, G., Kerem, Z., Makkar, H. P. S., Becker, K. 2002. The biological action of saponins in animal systems: a review. *Br. J. Nutr.*, vol. 88, p. 587-605. <https://doi.org/10.1079/bjn2002725>
- Fridovich, I. 1986. Superoxide dismutase. *Adv. Enzymol.*, vol. 58, p. 61-97.
- Fridovich, I. 1995. Superoxide radical and superoxide dismutases. *Annu. Rev. Biochem.* 64, p. 97-112. <https://doi.org/10.1146/annurev.biochem.64.1.97>
- Gibbs, R. A., Rymer, C., Givens, D. I. 2013. Fatty acid composition of cooked chicken meat and chicken meat products as influenced by price range at retail. *Food Chemistry*, vol. 138, p. 1749-1756. <https://doi.org/10.1016/j.foodchem.2012.11.002>
- Haak, L., Raes, K., Smet, K., Claeys, E., Paelinck, H., De Smet, S. 2006. Effect of dietary antioxidant and fatty acid supply on the oxidative stability of fresh and cooked pork. *Meat Sci.*, vol. 74, p. 476-486. <https://doi.org/10.1016/j.meatsci.2006.04.018>
- Haskins, K., Kench, J., Powers, K., Bradley, B., Pugazhenth, S., Reusch, J., McDuffie, M. 2004. Role for oxidative stress in the regeneration of islet beta cells? *J. Investig. Med.*, vol. 52, p. 45-49. <https://doi.org/10.1097/00042871-200401000-00025>
- Houben J. H., Gerris C. V. M. 1998. Effect of the dietary supplementation with vitamin E on colour stability of packaged, sliced pasteurized ham. *Meat Sci.*, 50, p. 421-428. [https://doi.org/10.1016/s0309-1740\(98\)00054-0](https://doi.org/10.1016/s0309-1740(98)00054-0)
- Hugo, A., Els, S. P., Bothma, C., De Witt, F. H., Van Der Merwe, H. J., Fair, M. D. 2009. Influence of dietary lipid sources on sensory characteristics of broiler meat. Peer-reviewed paper: 10th World Conference on Animal Production South African Journal of Animal Science, vol. 39, p. 11-14.
- Chang, L., Y., Slot, J. W., Geuze, H. J., Crapo, J. D. 1988. Molecular immunocytochemistry of the CuZn superoxide dismutase in rat hepatocytes. *J. Cell Biol.*, vol. 107, p. 2169-2179.
- Johnson, F., Giulivi, C. 2005. Review Superoxide dismutases and their impact upon human health. *Molecular Aspects of Medicine*, vol. , p. 340-352. <https://doi.org/10.1016/j.mam.2005.07.006>
- Jung, K., Henke, W. 1996. Developmental changes of antioxidant enzymes in kidney and liver from rats. *Free Radic. Biol. Med.*, vol. 20, no. 4, p. 613-617. [https://doi.org/10.1016/0891-5849\(95\)02090-x](https://doi.org/10.1016/0891-5849(95)02090-x)
- Kakko, S., Paivansalo, M., Koistinen, P., Kesaniemi, Y. A., Kinnula, V. L., Savolainen, M. J. 2003. The signal sequence polymorphism of the MnSOD gene is associated with the degree of carotid atherosclerosis. *Atherosclerosis*, 168, p. 147-152. [https://doi.org/10.1016/s0021-9150\(03\)00091-1](https://doi.org/10.1016/s0021-9150(03)00091-1)
- Kanner, J. 1994. Oxidative processes in meat and meat products: Quality implications. *Meat Sci.*, vol. 36, p. 169-189. [https://doi.org/10.1016/0309-1740\(94\)90040-x](https://doi.org/10.1016/0309-1740(94)90040-x)
- Karwowska, M., Dolatowski, Z. J., Grela, E. R. 2007. Effect of dietary supplementation with extracted alfalfa oxidation stability cooked. *Pol. J. Food Nutr. Sci.*, vol. 57, no. 4(B), p. 271-274.
- Keller, G.-A., Warner, T. G., Steimer, K. S., Hallewell, R. A. 1991. Cu,Zn superoxide dismutase is a peroxisomal enzyme in human fibroblasts and hepatoma cells. *Proc. Natl. Acad. Sci. USA*, vol. 88, p. 7381-7385. <https://doi.org/10.1073/pnas.88.16.7381>
- Liou, W., Chang, L. Y., Geuze, H. J., Strous, G. J., Crapo, J. D., Slot, J. W. 1993. Distribution of CuZn superoxide dismutase in rat liver. *Free Radic. Biol. Med.*, vol. 14, p. 201-207. [https://doi.org/10.1016/0891-5849\(93\)90011-j](https://doi.org/10.1016/0891-5849(93)90011-j)
- Lu, L., Ji, C., Luo, X. G., Liu, B., Yu, S. X. 2006. The effect of supplemental manganese in broiler diets on abdominal fat deposition and meat quality. *Animal Feed Science and Technology*, vol. 12, p. 49-59. <https://doi.org/10.1016/j.anifeedsci.2005.12.005>
- Marklund, S. L. 1984. Properties of extracellular superoxide dismutase from human lung. *Biochem. J.*, vol. 220, no. 1, p. 269-272. <https://doi.org/10.1042/bj2200269>
- McCord, J. M., Fridovich, I. 1969. Superoxide dismutase. An enzymic function for erythropoietin (hemocuprein). *J. Biol. Chem.*, vol. 244, p. 6049-6055.
- Min, B., Ahn, D. U. 2005. Mechanism of Lipid Peroxidation in Meat and Meat Products -A Review *Food Sci. Biotechnol.*, vol. 14, no. 1, p. 152-163.
- O'Grady M. N., Maher M., Troy D. J., Moloney A. P., Kerry J. P. 2006. An assessment of dietary supplementation with tea catechins and rosemary extract on the quality of fresh beef. *Meat Sci.*, 73, p. 132-143. <https://doi.org/10.1016/j.meatsci.2005.11.008>
- RANDOX Laboratories Ltd. , Ransod Superoxid dismutase Manual RX Monza.
- Rao, A. V., Gurfinkel, D. M. 2000. The bioactivity of saponins: Triterpenoid and steroidal glycosides. *Drug Metabol. Drug Interact.*, vol. 17, p. 211-235. <https://doi.org/10.1515/dmdi.2000.17.1-4.211>
- Rosen, D. R., Siddique, T., Patterson, D., Figlewicz, D. A., Sapp, P., Hentati, A. Donaldson, D., Goto, J., O'Regan, J. P., Deng, H. X. et al. 1993. Mutations in Cu/Zn superoxide dismutase gene are associated with familial amyotrophic lateral sclerosis. *Nature*, 362, p. 59-62. <https://doi.org/10.1038/362059a0>
- Sen, S., Makkar, H. P. S., Becker, K. 1998. Alfalfa saponins and their implications in animal nutrition. *J. Agric. Food Chem.*, vol. 46, p. 131-140. <https://doi.org/10.1021/jf970389i>
- Steinman, H. M. 1982. Copper-zinc superoxide dismutase from caulobacter crescentus cb15 a novel bacteriocuprein form of the enzyme. *J. Biol. Chem.*, vol. 257, p. 10283-10293.
- Stochmal, A., Simonet, A. M., Macias, F. A., Oliveira, M. A., Abreu, J. M., Nash, R., Oleszek, W. 2001. Acylated apigenin glycosides from alfalfa (*Medicago sativa* L.) var. *Artal. Phytochemistry*, vol. 57, p. 1223-1226. [https://doi.org/10.1016/s0031-9422\(01\)00204-7](https://doi.org/10.1016/s0031-9422(01)00204-7)
- Suksombat, W., Buakeeree, K. 2006. Utilization of hedge lucerne meal (*Demathus virgatus*) as protein supplement in layers diets. *Suranaree J. Sci. Technol.*, vol. 13, no. 2, p. 182-187.
- Tkáčová, J., Angelovičová, M. 2013. *Antioxidačná aktivita lucernovej múčky a kvalita kuracieho mäsa (Antioxidant activity of lucerne meal and quality of chicken meat.)*. Nitra : SPU in Nitra, 99 p. ISBN 978-80-552-1116-9.

Tkáčová, J., Angelovičová, M., Haščík, P., Bobko, M. 2015. Oxidative stability of chicken meat during storage influenced by the feeding of alfalfa meal. *Potravinárstvo*, vol. 9, no. 1, p. 106-111 <https://doi.org/10.5219/444>

Wenk C. 2003. Herbs and botanicals as feed additives in monogastric animals. *Asian-Australasian J. Anim. Sci.*, 16, p. 282-289. <https://doi.org/10.5713/ajas.2003.282>

Whitehead, C. C., McNab, J. M., Griffin, H. D. 1981. The effects of low dietary concentrations of saponin on liver lipid accumulation and performance in laying hens. *Poult. Sci.*, vol. 22, p. 281-288. <https://doi.org/10.1080/00071688108447887>

Zelko, I. N., Mariani, T. J., Folz, R.J. 2002. Superoxide dismutase multigene family: A comparison of the CuZn-SOD (SOD1), Mn-SOD (SOD2), and EC-SOD (SOD3) gene structures, evolution, and expression. *Free Radical Biology and Medicine*, vol. 33, no. 3, p. 337-349. [https://doi.org/10.1016/s0891-5849\(02\)00905-x](https://doi.org/10.1016/s0891-5849(02)00905-x)

Zhou, J. Y., Prognon, P. 2006. Raw material enzymatic activity determination: A specific case for validation and comparison of analytical methods - The example of superoxide dismutase (SOD). *J. Pharm. Biomed. Anal.*, vol. 40, p. 1143-1148. <https://doi.org/10.1016/j.jpba.2005.09.022>

Acknowledgments:

This work was supported by grant APVV No. 0304-12.

Contact address:

Ing. Jana Tkáčová, Ph.D., Slovak University of Agriculture in Nitra, Tr. A. Hlinku 2, Faculty of Biotechnology and Food Sciences, 949 76 Nitra, Slovakia, E-mail: tkacova.jt@gmail.com.

prof. Ing. Mária Angelovičová, Ph.D., Slovak University of Agriculture, Faculty of Biotechnology and Food Sciences, Department of Hygiene and Food Safety, Tr. A. Hlinku 2, 949 76 Nitra, Slovakia, E-mail: maria.angelovicova@uniag.sk.

Marcela Capcarová, Slovak University of Agriculture in Nitra, Faculty of Biotechnology and Food Sciences, Department of Animal Physiology, Tr. A. Hlinku 2, 949 76 Nitra, Slovakia, E-mail: marcela.capcarova@uniag.sk.

Adriana Kolesárová, Slovak University of Agriculture, Faculty of Biotechnology and Food Sciences, Department of Animal Physiology, 949 76 Nitra, Slovakia, E-mail: adriana.kolesarova@uniag.sk.

Monika Schneidgenová, Slovak University of Agriculture in Nitra, Faculty of Biotechnology and Food Sciences, Department of Animal Physiology, Tr. A. Hlinku 2, 949 76 Nitra, Slovakia, E-mail: monika.schneidgenova@uniag.sk.

Adriana Pavelková, Slovak University of Agriculture in Nitra, Faculty of Biotechnology and Food Sciences, Department of Evaluation and Processing of Animal Products, Tr. A. Hlinku 2, 949 76 Nitra, Slovakia, E-mail: adriana.pavelkova@uniag.sk.

Ing. Marek Bobko, Ph.D., Slovak University of Agriculture in Nitra, Tr. A. Hlinku 2, Faculty of Biotechnology and Food Sciences, 949 76 Nitra, Slovakia, E-mail: marek.bobko@uniag.sk.

prof. Ing. Juraj Čuboň, CSc., Slovak University of Agriculture in Nitra, Tr. A. Hlinku 2, Faculty of Biotechnology and Food Sciences, 949 76 Nitra, Slovakia, E-mail: juraj.cubon@uniag.sk.

MORPHOLOGICAL CHARACTERISTICS AND DETERMINATION OF VOLATILE ORGANIC COMPOUNDS OF *DIOSPYROS VIRGINIANA* L. GENOTYPES FRUITS

Olga Grygorieva, Svitlana Klymenko, Olena Vergun, Nataliia Hudz, Nataliia Nikolaieva, Zuzana Schubertová, Olena Palamarchuk, Ján Brindza

ABSTRACT

The aim of this study was to determine morphometric differences of fruits and seeds between 19 selected American persimmon (*Diospyros virginiana* L.) genotypes. The genotypes of American persimmon have been growing more than 15 years in Forest-Steppe of Ukraine in the M.M. Gryshko National Botanical Garden of NAS of Ukraine. They are well adapted to the climatic and soil conditions. The fruits were collected at the period of their full maturity (October). The population differs in a weight, shape, size and color of fruits and seeds. Their morphometric parameters were following: fruit weight from 2.30 to 81.30 g, fruit length from 8.84 to 49.73 mm, fruit width from 12.84 to 55.34 mm, seed weight from 0.1 to 1.0 g, seed length from 8.30 to 20.88 mm, fruit width from 7.04 to 14.88 mm, seed thickness from 1.98 to 7.09 mm and number of seeds in the fruit from 1 to 8. Partenocarpic fruits are found in some genotypes. The shape indexes of fruits and seeds were found ranging from 0.74 to 1.10 and from 1.01 to 1.77, respectively. During the analysis of qualitative composition and quantitative content of volatiles of fruits from the 4 perspective genotypes of *Diospyros virginiana* 106 compounds were detected. From them 83 compounds were identified. The identified compounds belong to alcohols, saturated and unsaturated aldehydes, ketons, fatty acids, esters, terpenoids etc. The fruits are rich in fat acids. The outcome of the research points to the fact that the genepool of Ukrainian *Diospyros virginiana* is a rich source of genetic diversity and might be used in selection for creation a new genotypes and cultivars.

Keywords: American persimmon; fruits; seeds; morphometric characteristics; volatile compounds; fatty acids

INTRODUCTION

Species of the genus *Diospyros* spp. belong to the family Ebenaceae Gürke (Wallnöfer, 2001). In Europe, the considerable interest of national economy to constitute such kinds of as: *Diospyros kaki* L. (Japanese persimmon) and *Diospyros virginiana* L. (American persimmon), fruit plants as food, *Diospyros lotus* L. (Date plum) – as rootstock, *Diospyros virginiana* – as a rootstock and as a source of high winter hardiness at the hybridization (Bellini, 2002; Grygorieva et al., 2009). The natural range of *Diospyros virginiana* includes the eastern part of North America from Connecticut to Iowa and from Kansas to Florida (Fletcher, 1915; Skallerup, 1953; Holdeman, 1998). Today more than 200 cultivars of *Diospyros virginiana* exist and their fruits have differences in fruits shape, size, color and ripening (Hague, 1911; Spongberg, 1979; Goodell, 1982; Zohary, 2004).

Archaeological and historical records provide evidence of the extensive use and management of American persimmons by Native Americans historically, yet the species is not viewed as a rare, weedy, wild fruit tree that is known primarily by hobbyists and wild harvesters (Ross

et al., 2014). The *Diospyros virginiana* is of great practical interest for fruit growing. In addition, the American persimmon is a valuable decorative and medicinal plant. For the last years was derived good cultivars of *Diospyros virginiana* and some of them are superior the best cultivars of *Diospyros kaki* (Spongberg, 1979; Vitkovsky, 2003; Grygorieva et al., 2011). *Diospyros virginiana* since ancient times are used in the folk medicine (Hamel and Chiltoskey, 1975; Mallavadhani et al., 1998; Foster and Duke, 1999; Briand, 2005). The fruit has been used medicinally as antiseptic and for the treatment of burns, diphtheria, dropsy, diarrhea, gonorrhoea, candidiasis, dysentery, fevers, thrush, fungal and bacterial infections, gastrointestinal bleeding, sore throats (Briand, 2005). Fruits exhibit the antimicrobial and antifungal activities (Rashed et al., 2014).

Also, the persimmon fruit can be considered as a highly nutritional product because of its strong antioxidant capacity induced by a high content of flavonoids, vitamin C, beta-carotene (Oz and Kefalas, 2010; Priya and Nethaji, 2014a).

Biologically active compounds are not only in fruits but in different parts of the plant: bark, wood, leaves, roots. The bark has an antiseptic properties (Briand, 2005) and hepatoprotective and antipyretic activity (Priya and Nethaji, 2015b; 2015c), the leaves showed antimycobacterial effect (Charley et al., 1999; Isfahani et al., 2014) and hepatoprotective and antipyretic activity (Priya and Nethaji, 2015b; 2015c), the roots of American persimmon showed antifungal effect (Wang et al., 2011). Powder of dry leaves has long been used in folk medicine. Shukla et al. (1989) in the leaves of *Diospyros virginiana* found lupeol, betulin, betulinic acid – components that are famous with antitumor properties.

nWegl et al. (2016) published, that some natural compounds could have positive antibacterial effect in pig nutrition. Naphthoquinones from the leaves exhibited fungicidal activity against *Saccharomyces vini*, *Candida mycoderma*, *Hansenula anomala*. Bactericidal activity was found against lactobacilli *Lactobacterium plantarum*, *L. breve*, *L. gracile* and relatively against to the acetic acid bacteria *Acetobacter aceti*, *A. xylinum*, *A. ascendens*, *A. rancens*. It was established by that the antimicrobial activity it exceeds the sulfuric anhydride which is widely used as antiseptic and preservative (Richter, 2001).

Some authors pointed out that the leaves extracts can be a potential source for new antimalarial agents (Trigg and Kondrachine, 1998; Ozbilgin et al., 2016).

The results of Priya and Nethaji (2014d) have showed that the ethanolic extracts of leaves and bark of *Diospyros virginiana* normalize the serum level of markers enzymes AST, ALT, GGT and ALP, bilirubin level in CC₄ induced hepatotoxicity.

The leaves of *Diospyros virginiana* by the biochemical composition have the highest content of ascorbic acid and mineral compounds comparing with other species (Richter, 2001; Grygorieva et al., 2012).

The fruits of persimmon are an excellent dietary product, they are used in fresh condition and from them are prepared pastes, jams, syrups, marinades. The fruits were also used to make wine, brandy, white wine vinegar and beer (Bartram, 1772; Briand, 2005). Additionally, the by products from processing of persimmon fruits or leaves can be used in animal nutrition as a source of bioactive compounds (Herkeľ et al., 2016; Gálik et al., 2016) and thereby improve the performance of farm animals.

The aim of this study was to distinguish the best genotypes from our collections of *Diospyros virginiana*, which could be successfully grown on plantations, and to investigate their qualitative and quantitative content of volatile organic compounds of fruits.

MATERIAL AND METHODOLOGY

Locating trees and data collection

The objects of the research were 15-year-old plants of *Diospyros virginiana*, which are growing in the Forest-Steppe of Ukraine in M.M. Gryshko National Botanical Garden of NAS of Ukraine (NBG). Observations on the collection's forms of *Diospyros virginiana* in the period

2015 – 2016 were performed during mass fruiting. We have described 19 genotypes of *Diospyros virginiana*.

Morphometric characteristics

Pomological characteristics were conducted with four replications on a total 30 fruits per genotypes. In the study only one plant (tree) used for per genotype.

The following measurements were taken: fruit weight (FM), in g, fruit length (FL), in mm, fruit width (FW), in mm and seed weight (SM), in g, seed length (SL), in mm, seed width (SW), in mm, seed thickness (ST), in mm, number of seeds in fruit (NS). Data, we are working with, were tested for normal distribution.

Volatile compounds analysis

The investigation of the volatiles was conducted at the National Institute of Viticulture and Wine "Magarach" under the direction (leadership) of B.O. Vinogradov by the method of Chernohorod and Vinogradov (2006).

The distillation of volatiles of the fruits was carried out by method of Chernohorod and Vinogradov (2006). The volatiles were investigated by the method of chromatography-mass spectrometry using the chromatograph Agilent Technologies 6890 N with the mass spectrometric detector 5973 N (USA) and a capillary column DB-5 length is 30 mm and an internal diameter is 0.25 mm. The carrier gas velocity (Helium) was 1.2 mL.min⁻¹. The injector heater temperature was 250 °C. The temperature of thermostat was programmed from 50 °C to 320 °C at the speed 4 °C. The mass spectra library NIST 05 WILEY 2007 with 470 000 spectra and AMDIS, NIST programs were used to identify the investigated compounds. The identification was conducted by comparing obtained mass spectra to mass spectra of standards. The method of internal standard used to determine the quantitative content of compounds.

Statistical analyses

Basic statistical analyses were performed using SAS System v. 9.2 (SAS 2009); a log-rank test was used for cyclic comparisons and a Student's t test for the cut-through analysis; $p < 0.05$ was considered to be statistically significant. The DISTRIBUTION analysis (verification of normal distribution of input data), the TREE procedure in SAS 9.2. for further detailed analysis were used. Variability of all these parameters was evaluated using descriptive statistics. Level of variability determined by Stehlíková (1998).

RESULTS AND DISCUSSION

The weight of the whole fruit is one of significant production characteristics of plant species. Further important features of the fruit and seed are shape, size and color. These parameters of the *Diospyros virginiana* fruit varied significantly. The images of *Diospyros virginiana* fruits of various genotypes are shown on Figure 1, 2. High variability of the size, shape and color of these fruits are evident.



Figure 1 Variability in the shape of *Diospyros virginiana* L. fruits.



Figure 2 Variability in the shape of *Diospyros virginiana* L. seeds.

Table 1 The variability of some morphometric parameters of fruits and seeds for the whole collection of *Diospyros virginiana* L. genotypes from Kyiv.

Characteristics	Unit	<i>n</i>	<i>min</i>	<i>max</i>	<i>mean</i>	<i>CV%</i>
Fruit weight	g	570	2.30	81.30	33.65	68.87
Fruit length	mm	570	8.84	49.73	31.83	32.10
Fruit width	mm	570	12.84	55.34	35.87	29.84
Seed weight	g	510	0.1	1.00	0.57	30.01
Seed length	mm	510	8.30	20.88	15.01	11.55
Seed width	mm	510	7.04	14.88	11.41	15.82
Seed thickness	mm	510	1.98	7.09	4.26	25.39
Number of seeds in fruit		2161	0	8.00	4.05	41.79

Legend: *n* – number of measurements; *min*, *max* – minimal and maximal measured values; *mean* – arithmetic mean; *CV* – coefficient of variation (%).

Morphometric characteristics

The weight of *Diospyros virginiana* fruits of present study was in the range from 2.30 (DV-17) to 81.30 (DV-09) g (Table 1). Coefficient of variation was 68.87%, which shows a very high degree of variability of fruit

weight. The fruit weight was determined in range from 9.0 to 14 g by Akhund-Zade (1957), from 9.0 to 20.20 g by Chentsova (2008), from 9.0 to 40.0 g by Surkhayev (2006). According to Grygorieva (2011) the fruit weight of American selection cultivars such as Weber, Meader, John Rick was determined as 19.71, 24.10, 26.47 g respectively.

There are genotypes, which reached minimum and maximum values in these characteristic, in Table 2.

The fruit length in our analyses was determined in the range from 8.84 (DV-15) to 49.73 (DV-09) mm. The value of the coefficient of variation was 32.10%, which shows a very high degree of variability of fruit weight. The fruit length was determined in range from 3.18 to 23.00 mm (Chentsova, 2008), in cultivars – from 27.03 to 29.55 mm (Grygorieva, 2011).

In our experiments the fruit width was determined in the range from 12.84 (DV-15) to 55.34 (DV-01) mm (Table 1). The variation coefficient (29.84%) confirmed a very high of variability within the collection. The fruit width was determined in range from 40.0 to 75.0 mm (Spongberg, 1979), from 19.0 to 51.0 mm (Halls, 1990), from 23.00 to 35.00 mm (Chentsova, 2008), in cultivars – from 33.30 to 37.71 mm (Grygorieva, 2011). There are genotypes, which reached minimum and maximum values in these characteristic, in Table 2.

The seed weight in our analyses was determined in the range from 0.1 (DV-15) to 1.0 (DV-13) g. The value of the coefficient of variation was 30.01%, which shows a very high degree of variability of fruit weight. Investigations of Grygorieva (2011) established the range of seed weight of cultivars from 0.40 to 0.57 g.

Seed length was identified in range from 8.30 (DV-08) mm to 20.88 (DV-13) mm (Table 1). The variation coefficient characterizes average degree of variability within the tested collection; genotypes reaching extreme values are listed in Table 2. Grygorieva (2011) determined the average length of the seed in the range from 12.57 to 14.75 mm. Spongberg (1979) determined the average length of the seed in the range from 11.0 to 17.0 mm.

Seed width was identified in range from 7.04 (DV-19) to 14.88 (DV-04) mm. The value of the coefficient of variation fixed the average degree of variability of this characteristic.

Seed thickness was identified in range from 1.98 (DV-06) to 7.09 (DV-04) mm. The variation coefficient (25.39%) confirmed a very high of variability within the collection.

Number of seeds in fruit was identified in range from 1 (DV-05, DV-16, DV-19) to 8 (DV-06). The partenocarpic fruits were found in both – genotypes DV-12 and DV-17. These trees were similar to other trees, that producing seeds, by morphological properties but their fruits had strong difference in shape and taste. Coefficient of variation was 41.79%, which shows a very high degree of variability.

Table 2 The fruits and seeds variability of *Diospyros virginiana* L. genotypes from the collection.

Genotypes	n	Mean	SD	CV%	Genotypes	n	Mean	SD	CV%
	Lowest values					Highest values			
Fruit weight (g)									
DV-17	30	3.47	0.70	20.24	DV-03	30	62.11	6.99	11.27
DV-12	30	3.83	1.30	32.88	DV-09	30	65.16	9.14	14.02
DV-15	30	3.98	0.65	18.29	DV-18	30	68.77	7.11	10.34
Fruit length (mm)									
DV-12	30	15.15	1.45	9.57	DV-03	30	44.57	2.95	6.63
DV-15	30	15.16	2.93	19.34	DV-18	30	44.58	2.37	5.33
DV-17	30	15.47	1.43	9.26	DV-09	30	45.53	2.39	5.25
Fruit width (mm)									
DV-17	30	17.85	1.44	8.08	DV-18	30	47.15	2.40	5.10
DV-12	30	18.23	1.21	6.64	DV-03	30	47.52	2.29	4.82
DV-15	30	18.59	2.72	14.65	DV-19	30	47.89	2.20	4.60
Seed weight (g)									
DV-15	30	0.14	0.02	16.48	DV-04	30	0.72	0.08	11.18
DV-07	30	0.45	0.07	16.10	DV-03	30	0.73	0.18	25.47
DV-05	30	0.50	0.11	21.94	DV-13	30	0.78	0.10	14.04
Seed length (mm)									
DV-16	30	12.63	0.69	5.49	DV-10	30	16.34	0.87	5.34
DV-06	30	13.35	1.03	7.78	DV-11	30	16.46	0.78	4.74
DV-07	30	14.34	0.85	5.96	DV-13	30	19.00	1.03	5.47
Seed width (mm)									
DV-15	30	8.62	0.77	8.98	DV-01	30	12.70	1.43	11.30
DV-19	30	8.89	0.65	7.39	DV-06	30	13.18	1.57	11.94
DV-14	30	8.911	0.42	4.76	DV-04	30	13.41	0.62	4.69
Seed thickness (mm)									
DV-15	30	2.75	0.19	6.97	DV-13	30	5.17	0.59	11.58
DV-06	30	2.81	0.38	13.56	DV-16	30	5.33	0.52	9.76
DV-14	30	2.90	0.17	6.03	DV-04	30	5.54	0.81	14.68
Number of seeds in fruit									
DV-16	30	2.73	1.50	55.13	DV-01	30	4.86	1.04	21.40
DV-18	30	3.26	0.82	25.33	DV-07	30	5.40	0.81	15.06
DV-10	30	3.36	0.49	14.55	DV-06	30	6.33	1.39	22.07

Note: n – number of measurements; mean – arithmetic mean; SD – standard deviation; CV – coefficient of variation (%).

The number of seeds in fruit was determined in range from 4 to 8 by **Akhund-Zade (1957)**, from 1 to 9 by **Surkhayev (2006)**, from 1 to 5 by **Chentsova (2008)**.

The shape of each object can be characterized by the shape index, i.e. the length to width ratio. Figure 3 represents the shape indexes of fruits and seeds. The shape index of the fruits was found in the range from 0.74 (DV-06) to 1.10 (DV-11), so the genotype's collection demonstrates significant variability in the shape of the fruit, as seen in Figure 1. The shape index of the seed was found in the range from 1.01 (DV-06) to 1.77 (DV-11). These parameters can be used for the identification of the genotypes.

The analysis of coefficient of variation showed the difference of variability of morphological signs between *Diospyros virginiana* samples. Data showed that the most variability of important selection signs are the number of seeds in fruit – from 8.97 (DV-15) to 55.13 (DV-16) %, fruit weight – from 9.00 (DV-14) to 48.18 (DV-01) %, seed weight – from 9.34 (DV-16) to 25.47 (DV-03) % and fruit width – from 3.60 (DV-04) to 22.40 (DV-01) %. These results indicate the promise of breeding in this way of investigations. The stable signs are seed length – from 4.51 (DV-01) to 10.60 (DV-08) % and seed width – from 3.12 (DV-05) to 11.94 (DV-06) % (Figure 4).

The results indicated high correlations between the fruit weight and the fruit length ($r = 0.962$), fruit width ($r = 0.948$), seed width ($r = 0.584$) (Table 3). Slight correlation was found between the fruit weight and the

number of seeds in fruit ($r = 0.353$), seed length and the seed thickness ($r = 0.283$). It was noticed no correlation between the seed width and the seed thickness ($r = 0.027$), fruit weight and the seed thickness ($r = 0.079$). There was a negative correlation between the seed length and the seed width ($r = -0.242$) and fruit weight and the seed length ($r = -0.271$). The results document that between specific characteristics is positive relationship which is very important in *Diospyros virginiana* breeding.

The genetic relationship among the 19 genotypes of *Diospyros virginiana* (Figure 5) was examined by cluster analysis. Dendrogram has showed 2 main group in cluster A and cluster B. Three of 19 genotypes were included in cluster A group no. 1 and 6 genotypes in group no. 2. Seventh of 19 genotypes were included in cluster B group no. 1 and 3 genotypes in group no. 2. The group no. 2 of cluster A and group no.1 of cluster B had the highest mean for fruit morphometric characteristics (weight, length, width), that were significantly different. The results of this assessment related to group 1 of cluster A and group 2 of cluster B had the lowest mean of fruit morphological parameters.

The genetic relationship among 17 genotypes of *Diospyros virginiana* was examined by cluster analysis (Figure 6). Dendrogram has showed two main groups. Tenth of the 17 genotypes were included in cluster group A and seventh were included in cluster group B. The group A had the highest mean than the group B for seed morphometric characteristics (weight, length, width, thickness). So, group A was significantly different with

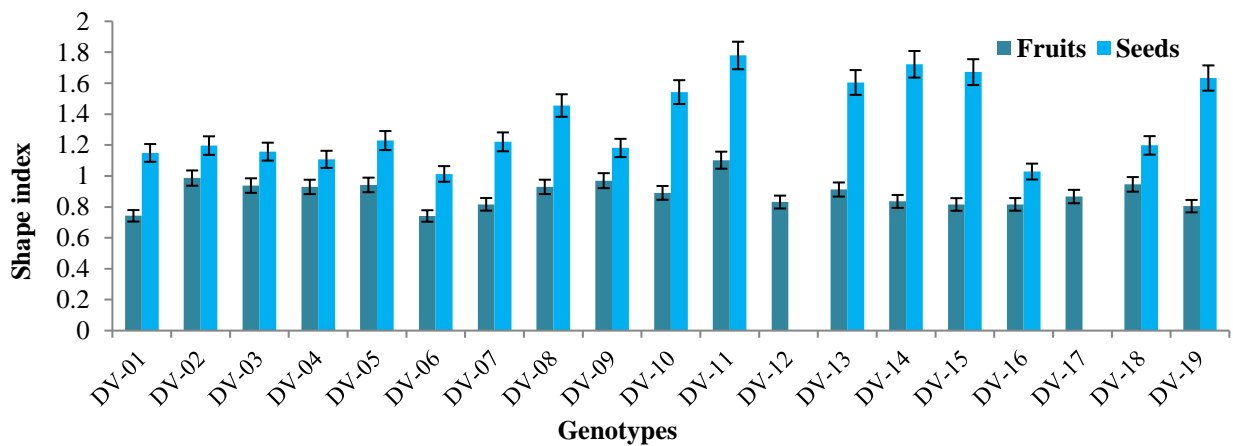

Figure 3 Comparison of the tested *Diospyros virginiana* L. genotypes in the shape index of fruit and seeds.



Figure 4 Level of variability of morphological characters of fruits and seeds *Diospyros virginiana* L. (%).

Table 3 The linear relationship between of the morphometric characteristics of evaluated genotypes of *Diospyros virginiana* L.

Characteristic	r	sr	Confidence Interval r _{95%}	r ²	t	p
F. weight / F. length	0.962	2.803	0.9027 ≤ r ≤ 0.9857	0.926	14.598	0.000
F. weight / F. width	0.948	3.400	0.8681 ≤ r ≤ 0.9803	0.899	12.330	0.000
F. weight / Number of seeds in fruit	0.353	0.506	-0.1197 ≤ r ≤ 0.6961	0.125	1.559	0.137
F. weight / S. length	-0.271	1.324	-0.6459 ≤ r ≤ 0.2087	0.073	1.161	0.261
F. weight / S. width	0.584	1.276	0.1774 ≤ r ≤ 0.8208	0.341	2.970	0.008
F. weight / S. thickness	0.079	0.890	-0.3889 ≤ r ≤ 0.5150	0.006	0.328	0.746
S. length / S. width	-0.242	1.526	-0.6278 ≤ r ≤ 0.2376	0.059	1.032	0.316
S. length / S. thickness	0.283	0.856	-0.1961 ≤ r ≤ 0.6535	0.080	1.218	0.239
S. width / S. thickness	0.027	0.893	-0.4322 ≤ r ≤ 0.4757	0.000	0.112	0.911

Legend: r – Pearson’s correlation coefficient, sr – standard error of the coefficient, min/max – 95% confidence interval for r, r² – coefficient of determination, p – significance level.

other group.

The figures clearly identified significant differences between tested *Diospyros virginiana* genotypes. Figures confirm the results from the evaluated variability of morphometric characteristics (Table 1).

Volatile organic compounds

The chromatogram of volatiles of fruits of selected genotypes of persimmon is represented on Figures 1 – 4.

Qualitative composition and quantitative content of identified substances of investigated objects are

represented in Table 4.

It was established that the fruit of DV-03 genotype contained 48 substances, among which were identified 42 substances, genotypes DV-09 – 63 and 52, genotypes DV-18 – 55 and 43, genotypes DV-19 – 46 and 43, respectively. The identified components belong to different chemical classes, including hydrocarbons, alcohols, aldehydes and phenylaldehydes, terpenes, esters and fatty acids.

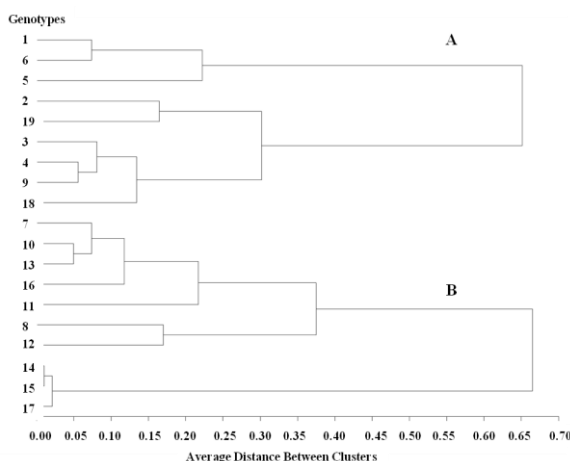

Figure 5 Dendrogram of 19 genotypes of *Diospyros virginiana* L. based on morphometric characteristics of fruits.

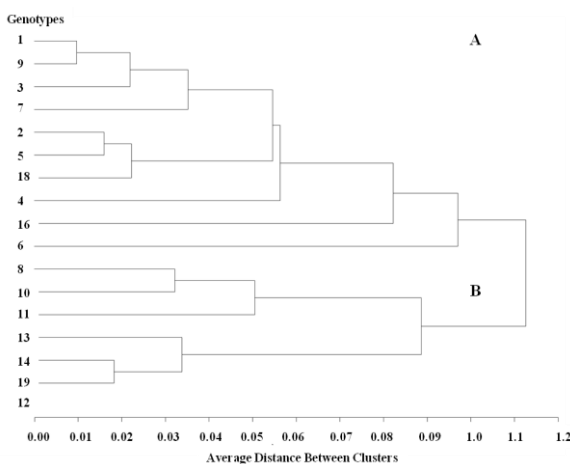

Figure 6 Dendrogram of 17 genotypes of *Diospyros virginiana* L. based on morphometric characteristics of seeds.

Table 4 The volatiles of fruits of selected genotypes of *Diospyros virginiana* L.

Component	DV-03		DV-09		DV-18		DV-19	
	1	2	1	2	1	2	1	2
Isoamyl alcohol	0.8	2.45		–		–		–
Acetoin	1.2	2.75		–		–		–
Isobutyl isobutyrate	1.2	3.4		–		–		–
*		–	0.4	3.74		–		–
*		–	0.6	3.97		–		–
Isobutyric acid		–	0.8	4.07		–		–
Butyric acid		–	0.4	4.72		–		–
2-methyltetrahydrofuranone-3		–		–		–	1.0	4.62
Furfural	1.0	5.56	1.4	5.6	1.5	5.61	5.9	5.57
*		–	0.4	6.47		–		–
Heptanol-4	0.7	5.79		–		–		–
Ethyl 3-hydroxybutyrate	2.7	6.88	1.5	6.9	3.9	6.92	0.9	6.88
Caproic acid	0.7	7.24	6.4	7.57	2.8	7.49	1.4	7.33
Furyl methyl ketone		–		–	0.5	7.58	0.5	7.55
Benzaldehyde		–		–		–	0.7	9.2
3- (methylthio) propanal		–		–	0.3	7.83		–
5-Methylfurfurol		–	0.1	9.49	0.5	9.5	0.4	9.50
Octanol	0.8	9.58	0.8	9.6		–	0.2	9.61
Cis-linaloolene oxide		–	1.8	9.82	3.2	9.84	1.4	9.82
Heptanoic acid		–	0.9	10.23	0.9	10.22		–
Trans-linalool oxide	1.3	9.81		–		–		–
Linalool	18.1	10.65	10.0	10.63	7.3	10.63	11.5	10.64
Ethyl 2-ethyl-3-hydroxybutyrate	1.1	10.87		–		–		–
2-ethyl-propanoic acid		–	0.6	11.02		–		–
Nonanal	1.7	11.01	1.8	11.20		–	0.9	11.02
Ho-trienol		–	0.4	11.35	0.4	11.35	0.3	11.36
Benzyl alcohol		–	0.6	11.61	1.2	11.62	0.6	11.62
Phenylacetaldehyde	5.3	12.26	9.1	12.27	13.3	12.29	15.9	12.31
Iodo-2-methylundecane		–	0.8	12.6		–	0.5	12.59
6-methyl-3,5-heptadien-2-one		–		–		–	0.2	12.97
2-nonen-4-one	0.8	12.49		–		–		–
Caprylic acid	2.5	13.42		–	4.1	13.52	3.4	13.50
Terpinene-4-ol		–		–	0.6	13.96		–
Decanal	0.5	14.2	1.3	14.26		–	0.8	14.25
B-phenylethyl alcohol		–	1.5	14.33	3.9	14.3		–
Epoxylinolene		–	1.3	14.38	1.9	14.35	2.3	14.37
Cis-epoxyalinalool	0.6	14.35		–		–		–
α -terpineol	1.9	14.75	2.4	14.8	3.0	14.78	1.3	14.78
Nerol	0.6	15.55		–	0.9	15.58		–
*		–	0.8	15.04		–		–
Nonanoic acid	3.4	16.54	3.1	16.56		–	2.1	16.46
Geraniol	1.6	16.62	1.4	16.63	1.6	16.64	0.8	16.63
*		–		–	3.0	18.59		–
Tetradecane		–		–		–	1.6	16.74
Tetradecene-7		–	1.0	17.08		–	0.3	17.08
Trans-2,4-decadiene		–		–		–	0.1	19.05
Benzonitrile	1.4	16.69		–		–		–
Capric acid	10.2	19.5	5.6	19.52	5.1	18.59	4.7	19.36
*		–		–	2.3	19.86		–
Tetradecanal		–		–		–	0.3	20.04
α -ethylidene phenylacetaldehyde		–		–		–	0.2	20.11
Geranylacetone		–		–		–	0.6	21.78
Eugenol		–	0.5	21.16	1.0	21.17		–
Hexadecene-1		–	0.4	21.24		–		–
Hexadecane		–	0.2	21.60	2.2	21.62		–
*		–	1.3	21.79	1.0	21.79		–
*		–		–	8.2	22.81		–
Hexadecene-8		–	1.0	21.83		–		–
Tetradecanal		–	0.4	22.07		–		–
B-ionone		–	0.5	22.88		–		–

Table 4 (continue) The volatiles of fruits of selected genotypes of *Diospyros virginiana* L.

Component	DV-03		DV-09		DV-18		DV-19	
	1	2	1	2	1	2	1	2
Ethyl laurate	0.8	23.27	1.1	23.25	1.6	23.27	1.3	23.25
Lauric acid	38.6	23.57	37.8	23.52	49.7	23.61	11.6	23.37
*	–	–	–	–	7.0	23.63	–	–
*	–	–	–	–	1.8	24.11	–	–
*	1.0	24.31	–	–	1.0	21.79	–	–
6-Phenyl-dodecane	–	–	–	–	2.8	25.3	–	–
5-Phenyl-dodecane	–	–	–	–	3.1	25.41	–	–
4-Phenyldodecane	–	–	–	–	2.0	25.58	–	–
*	–	–	–	–	4.5	25.84	–	–
3-Phenyldodecane	–	–	–	–	2.6	25.94	–	–
Hexadecanal	–	–	0.7	23.80	–	–	0.6	23.80
*	–	–	0.8	24.32	–	–	–	–
Tridecanoic acid	–	–	0.6	24.77	–	–	–	–
Octadecanal	–	–	1.3	25.32	–	–	1.2	25.32
Methyl myristate	0.6	25.33	–	–	–	–	–	–
Ethylmyristate	3.6	26.21	2.3	26.21	8.5	26.23	1.0	26.21
Myristic acid	101.0	26.61	153.3	26.63	234.6	26.77	89.7	26.54
4-Phenyltridecane	–	–	–	–	5.2	26.98	–	–
3-phenyltridecane	–	–	–	–	1.5	27.33	–	–
Hexahydrofarnesylacetone	0.7	26.79	–	–	–	–	–	–
*	0.6	26.95	–	–	–	–	–	–
Pentadecanoic acid	1.7	27.58	0.9	27.61	5.6	27.69	2.1	27.56
*	–	–	–	–	–	–	1.6	28.04
*	0.6	27.78	3.5	27.79	4.1	27.81	–	–
*	1.0	28.03	4.6	28.05	3.5	27.93	–	–
*	0.6	28.33	3.8	28.35	4.6	28.05	–	–
*	–	–	–	–	3.3	28.35	–	–
Ethyl palmitate	0.9	28.73	2.8	28.74	2.2	28.76	0.9	28.73
Ethyl palmitoleate	3.3	28.79	3.2	28.80	7.1	28.82	1.6	28.79
Palmitic acid	43.3	29.02	115.2	29.19	125.7	29.21	93.9	29.1
Palmitoleic acid	17.0	29.09	35.0	29.20	64.6	29.27	24.0	29.16
*	–	–	–	–	–	–	1.6	29.21
*	–	–	–	–	3.9	29.52	1.8	29.25
11-hexadecenoic acid	3.1	29.14	6.0	29.27	–	–	22.1	29.55
*	–	–	5.1	29.48	–	–	–	–
Methyl 7,10,13-hexadecatrioate	3.4	29.25	–	–	–	–	–	–
7,10,13-hexadecatrienic acid	18.6	29.51	33.4	29.64	33.4	29.68	–	–
Stearic acid	–	–	4.9	31.15	–	–	–	–
Oleic acid	2.2	31.12	2.7	31.21	1.2	31.2	–	–
Linoleic acid	1.4	31.32	2.2	31.36	–	–	–	–
Ethylene-indolate	1.5	31.5	1.0	31.51	2.5	31.52	–	–
Linolenic acid	6.4	31.68	16.5	31.73	10.6	31.72	3.9	31.66
*	0.6	36.11	–	–	–	–	–	–
Pentacosane	–	–	1.5	33.06	–	–	–	–
Heptakosan	–	–	0.9	34.96	–	–	–	–
*	–	–	1.2	37.29	–	–	–	–
Squalene	2.1	37.4	2.9	37.41	3.7	37.44	3.1	37.41

Among the fatty acids of genotype DV-03 fruits were found 32% of myristic acid, 14% of palmitic acid, and 12% of lauric acid; genotype DV-09 – 30, 23, 7%, respectively, genotype DV-18 contained 35% of myristic acid, 19% of palmitic acid, and 10% palmitoleic acid; genotype DV-19 contained 29% of palmitic acid, 28% of myristic acid, and 7% of palmitoleic acid. Palmitic acid was identified as minor constituents by Horvat et al. (1991).

Among other saturated fatty acids were identified butyric, caproic (hexanoic), caprylic (octanoic), nonanoic, capric (decanoic), lauric (dodecanoic), tridecanoic, pentadecanoic ones. Also we identified that some genotypes contain stearic acid $C_{17}H_{35}COOH$ and its unsaturated derivatives: oleic acid $C_{17}H_{33}COOH$ (one double bond), linoleic acid $C_{17}H_{31}COOH$ (two double bonds) and linolenic acid $C_{17}H_{29}COOH$ (three double bonds). Latter they were identified in all genotypes.

In present study among alcohols isoamyl alcohol and heptanol-4 (DV-03), octanol (DV-03, DV-09, DV-19), benzyl alcohol (DV-09, DV-18, DV-19) were identified. Saturated aliphatic aldehydes nonanal and decanal were identified in the three genotypes DV-03, DV-09 and DV-19. Phenylacetaldehyde was identified in all genotypes. Some genotypes also contained long straight-chain aliphatic saturated aldehydes such as tetradecanal, hexadecanal and octadecanal.

According to **Besada (2013)**, the high accumulation of phenylacetaldehyde and lipid-derived aldehydes are related with loss of astringency of fruits. Regarding to the previously described volatile compounds of the *Diospyros kaki*, **Besada et al. (2013)** benzyl alcohol and some related compounds such as acetaldehyde, hexanol-1, 3-methyl-1-heptanol, 1-undecanol, and aliphatic saturated and unsaturated aldehydes such as hexanal, heptanal, octanal, decanal, (E)-2-octenal, (Z)-2-nonenal, (E)-2-decenal, (E,E)-2,4-heptadienal were identified. **Taira et al. (1995)** identified such volatile compounds of astringent *Diospyros kaki* fruits as n-butanol, hexanol-1, (Z)-3-hexen-1-ol, 2-methyl hexanol, acetoin and acetic acid.

Flavour and aroma are important quality features in persimmon fruits. Flavour is formed by the combination of sweetness and sourness from carbohydrates, organic acids and aroma volatile compounds (**Besada et al., 2013**). In general, fruit volatile compounds refer to aliphatic esters, alcohols, aldehydes, ketones, lactones, terpenoids (monoterpenes, sesquiterpenes) and apocarotenoids. Fatty acids are the major primary precursor substrates of many character-impact aroma compounds in most fruits. Aliphatic alcohols, aldehydes, ketones, organic acids, esters and lactones, ranging from C₁ to C₂₀, are all derived from fatty acid precursors through three key biosynthetic processes: α -oxidation, β -oxidation and the lipoxygenase pathway. Sensor analysis is used for the estimation of ripening stage and storage life of *Diospyros kaki* fruits (**Baietto and Wilson, 2015**). Among the identified volatiles responsible for flavour in this study were linalool, α -terpineol and geraniol in all the genotypes and nerol in DV-3 and DV-18, terpinene-4-ol in DV-18 genotype. They all belong to terpenoids. Geraniol and nerol have a rose odour, nerol has a weaker odour (**Acree and Arn, 2004**). As was stated by **Martineli et al. (2013)** the volatiles from *Diospyros kaki* were mainly represented by terpenes hydrocarbons, followed by straight-chain esters.

The fact that less part of identified volatile compounds in American persimmon flesh in this study were reported by other scientists could be explained, first of all by the absence of available studies for *Diospyros virginiana*. Therefore, our results were compared with studies performed for *Diospyros kaki*.

CONCLUSION

The results of the experiment, which presented in this work, are consistent with the results reported earlier. In evaluating of 19 genotypes of American persimmon we determined the weight of the fruits in the range from 2.30 to 81.30 g, fruit length from 8.84 to 49.73 mm, fruit width from 12.84 to 55.34 mm, seed weight from 0.1 to 1.0 g, seed length from 8.30 to 20.88 mm, seed width from 7.04 to 14.88 mm, seed thickness from 1.98 to 7.09 mm and number of seeds in fruit from 1 to 8.

The shape index of the fruits was found in the range from 0.74 to 1.10. The shape index of the seed was found in the range from 1.01 to 1.77. The most variability of important selection signs are the number of seeds in fruit – 8.97 – 55.13%, fruit weight – 9.00 – 48.18%, seed weight – 9.34 – 25.47% and fruit width – 3.60 – 22.40%.

Obtained results are important for breeding new cultivars of *Diospyros virginiana* as well as their practical use. In this study 106 volatile compounds in the fruits of *Diospyros virginiana* were detected. Among them 83 compounds were identified, which belong to alcohols, saturated and unsaturated aldehydes, ketones, fatty acids, esters, terpenoids. The fruits are rich in fat acids. They are considered as precursors of many specific aroma compounds. Aldehydes are thought to be responsible for the loss of astringency by persimmon fruits.

REFERENCES

- Acree, T., Arn, H. 2004. Flavornet and human odor space [online] s.a. [cit. 2009-07-28] Available at: <http://www.flavornet.org/flavornet.html>.
- Akhund-Zade I. M. 1957. *Results of introduction and perspectives of development of persimmon in Azerbaijan*. Publishing house of the Academy of Sciences of the Azerbaijan SSR : Baku. 97 p.
- Baietto, M., Wilson, A. D. 2015. Electronic-Nose Applications for Fruit Identification, Ripeness and Quality Grading. *Sensors*, vol. 15, no. 1, p. 899-931.
- Bartram, I. 1772. A Memoir on the Distillation of Persimmons. *Transactions of the American Philosophical Society*, vol. 1, p. 231-234.
- Bellini, E. 2002. Cultural practices for persimmon production. In: Bellini E. and Giordani E. *First Mediterranean symposium on persimmon*. Zaragoza : CIHEAM, p. 39-52. ISBN 2853522490.
- Besada, C., Sanchez, G., Salvador, A., Granell, A. 2013. Volatile compounds associated to the loss of astringency in persimmon fruit revealed by untargeted GC – MS analysis. *Metabolomics*, vol. 6, no. 1, p. 157-172.
- Briand, C. H. 2005. The common persimmon (*Diospyros virginiana* L.): the history of an under utilized fruit tree (16 – 19th centuries). *Huntia*, vol. 12, no. 1, p. 71-89.
- Fletcher, W. F. 1915. The native persimmon. *Farmers' Bulletin*, vol. 685, no. 12, p. 1-24.
- Foster, S., Duke, J. A. 1999. *A field guide to medicinal plants and herbs of Eastern and Central North America*. Boston : Houghton Mifflin. 411 p. ISBN 0395988144.
- Gálik, B., Bíro, D., Šimko, M., Juráček, M., Capcarová, M., Kolesárová, A., Rolinec, M., Toman, R., Kanka, T. 2016. The effect of dietary bee pollen intake on growth performance and biochemical indicators of rats. *Acta Veterinaria Brno*, vol. 85, no. 1, p. 99-104.
- Goodell, E. 1982. Promising fruit plants for northern landscapes. *Arnoldia*, vol. 40, p. 103-133.
- Grygorieva, O., Brindza, J., Vietoris, V., Kucelová, L., Tóth, D., Abraham, V., Hricová, M. 2011. Morphological and organoleptic fruit properties of various persimmon species (*Diospyros* spp.). *Potravinárstvo*, vol. 5, no. 3, p. 11-19. <https://dx.doi.org/10.5219/150>
- Grygorieva, O., Klymenko, S., Brindza, J., Kochanova, Z., Toth, D., Derevjanko, V., Grabovecka, O. 2009. Introduction, breeding and use of persimmon species (*Diospyros* spp.) in Ukraine. *Acta Horticulturae (ISHS)*, vol. 833, p. 57-62.

- Grygorieva, O., Vergun, E., Brindza, J., Rakhmetov, D., Stehlikova, B. 2012. Ascorbic acid content changes in the leaves of selected species of *Diospyros* spp. genus during their growth. In *The 3rd International Symposium on Medicinal Plants, Their Cultivation and Aspects of Uses*. Petra-Jordan, pp. 75-76. ISBN 978-9957-31-012-7.
- Grygorieva, O. V. 2011. Morphological and bioecological features and reproduction of oriental persimmon (*Diospyros virginiana* L.) in the Forest-Steppe of Ukraine. *Scientific Reports of NULES of Ukraine*, vol. 2, no. 24, p. 1-20.
- Hague, S. M. 1911. A morphological study of *Diospyros virginiana*. *Botanical Gazette*, vol. 52, no. 1, p. 34-44.
- Halls, L. K. 1990. *Diospyros virginiana* L. In Burns R. M and Honkala B. H. *Silvics of North America*. Washington, DC : Department of Agriculture, Forest Service. p. 294-298. ISBN 86-600518.
- Hamel, P. B., Chiltoskey, M. U. 1975. *Cherokee Plants and Their Uses: A 400 Year History*. Herald Publishing Co. : Sylva, North Carolina. 65 p.
- Herkeľ, R., Gálik, B., Bíro, D., Rolinec, M., Šimko, M., Juráček, M., Arpášová, H., Wilkanowska, A. The effect of a phytogetic additive on nutritional composition of turkey meat. *Journal of Central European Agriculture*, vol. 17, no. 1, p. 25-39.
- Holdeman, Q. L. 1998. Persimmons for Louisiana's Children- young and old [online] s.a. [cit. 2007-05-13] Available at: http://webpages.charter.net/jtholdeman/PFLC1_QLH.pdf.
- Horvat, R. J., Senter, S. D., Chapman, G. W., Payne, J. A. 1991. Volatile compounds from the mesocarp of persimmons. *Journal of Food Science*, vol. 56, no.1, p. 262-263.
- Charley, W., Mitchell, M., Kidd, K. 1999. Antibiotics laboratory medicine. In *The antimycobacterial susceptibility tests*. New York : Williams & Wilkins Press, p. 127-175.
- Chentsova, E. S. 2008. *Perspectives of introduction and using of several species of persimmon in the Kuban zone of fruit growing* : dissertation theses. Krasnodar. 158 p.
- Chernogorod, L. B., Vinogradov, B. A. 2006. Essential oils of some species of the genus of *Ahillea* L. containing fragranol. *Rastitelnye resursy*, vol. 42, no. 2, p. 61-68.
- Isfahani, N. B., Hozoorbakhsh, F., Rashed, K., Havaei, S. A., Heidari, K., Moghim, S. 2014. Effect of *Lagerstroemia tomentosa* and *Diospyros virginiana* methanolic extracts on different drug-resistant strains of mycobacterium tuberculosis. *Research in Pharmaceutical Sciences*, vol. 9, no. 3, p. 193-198.
- Mallavadhani, U. V., Panda, A. K., Rao, Y. R. 1998. Pharmacology and chemotaxonomy of *Diospyros*. *Phytochemistry*, vol. 49, no. 4, p. 901-951.
- Martineli, M., Alves, A. A. R., de Figueiredo, GM., de Rezende, C. M., de Oliveira Fonseca, M. J. 2013. Persimmon cv. 'Mikado': analysis of volatile compounds in astringent and astringency removal. *Ciência Rural*, vol. 43, no. 8, p. 1516-1521.
- Oz, A. T., Kefalas, P. 2010. Quantity of the flavonoid profile peaks during storage and ripening in persimmon fruit. *Journal of Food, Agriculture & Environment*, vol. 8, no. 3, p. 132-134.
- Ozbilgin, A., Kayalar, H., Rashed, K., Ural, I. O., Cavus, I. 2016. Comparative investigation on antimalarial activity of *Ficus nitida*, *Terminallia bellerica* and *Diospyros virginiana* in BALB/C MICE infected with *P. Berghei*. *International Journal of Innovative Pharmaceutical Sciences and Research*, vol. 4, no. 5, p. 470-478.
- Priya, S., Nethaji, S. 2014a. Evaluation of antioxidant activity of leaf and bark extracts of *Diospyros virginiana* in rats. *International Journal of PharmTech Research*, vol. 8, no. 3, p. 1032-1035.
- Priya, S., Nethaji, S. 2015b. Antipyretic activity of ethanolic extract of leaf and bark of *Diospyros virginiana* in yeast induced pyrexia. *International Journal of Pharmacy and Pharmaceutical Sciences*, vol. 7, no. 9, p. 502-504.
- Priya, S., Nethaji, S. 2015c. Hepatoprotective activity of ethanolic extract of *Diospyros virginiana* in CCl₄ induced hepatotoxicity in swiss albino rats. *International Journal of PharmTech Research*, vol. 8, no. 3, p. 444-447.
- Priya, S., Nethaji, S. 2014d. Phytochemical Screening and Trace Element Analysis of *Diospyros virginiana*. *Research Journal of Pharmacology and Pharmacodynamics*, vol. 6, no. 1, p. 5-7.
- Rashed, K., Ćirić, A., Glamočlija, J., Soković, M. 2014. Antibacterial and antifungal activities of methanol extract and phenolic compounds from *Diospyros virginiana* L. *Industrial Crops and Products*, vol. 59, p. 210-215.
- Rauf, A., Uddin, G., Patel, S., Khan, A., Halim, S. A., Bawazeer, S., Ahmad, K., Muhammad, N., Mubarak, M. S. 2017. *Diospyros*, an under-utilized, multi-purpose plant genus: A review. *Biomedicine and Pharmacotherapy*, vol. 91, p. 714-730.
- Richter, A. A. 2001. *The improvement of the quality of fruit cultures*. Simferopol : Tavriya. 425 p.
- Ross, N. J., Stevens, M. H. H., Rupiper, A. W., Harkreader, J., Leben, L. A. 2014. The Ecological Side of an Ethnobotanical Coin : Legacies in Historically Managed Trees. *American Journal of Botany*, vol. 101, no. 10, p. 1618-1630.
- SAS, 2009. User's Guide Version 9. 2. SAS/STAT @ SAS Institute Inc. Cary, NC, USA.
- Shukla, Y. N., Kapadia, G. J., Govind J. 1989. Chemical constituents of *Diospyros virginiana*. *Indian Journal of Pharmaceutical Sciences*, vol. 51, no. 2, p. 73.
- Skallerup, H. R. 1953. The distribution of *Diospyros virginiana* L. *Annals of the Missouri Botanical Garden*, vol. 40, no. 3, p. 211-225.
- Spongberg, S. A. 1979. Notes on Persimmons, Kakis, Date Plums, and Chapotes. *Arnoldia*, vol. 39, no. 5, p. 290-309.
- Stehlíková, B., 1998. Basics of biostatistics (Biodiversity protection 51)) (Základy bioštatistiky (Ochrana biodiverzity 51)). Nitra : SPU, 79 p. ISBN 80-7137-539-X.
- Surkhayev, G. A. 2006. *Introduction and perspectives of using of unabi, almonds and persimmon in the Western Caspian* : dissertation theses. Volgograd. 124p.
- Taira, S. 1995. Astringency in persimmon. In H. F. Linskens and J. F. Jackson (Eds.), *Fruit analysis*. Germany : Springer, p. 97-110. ISBN: 978-3-642-79662-3.
- Trigg, P. I., Kondrachine, A. V. 1998. The Current Global Malaria Situation. In W. Sherman. *Malaria parasite Biology, Pathogenesis and Protection*. Washington, USA : ASM Press, p. 11-22.
- Vitkovsky, V. V. 2003. *Fruit plants of the world*. Lan : St. Petersburg, Publisher. 593 p. ISBN 5-8114-0477-8.
- Wallnöfer, B. 2001. The Biology and Systematics of Ebenaceae: aReview. *Annalen Des Naturhistorischen Museums in Wien*, vol. 103, p. 485-512.
- Wang, X., Habib, E., Leon, F., Radwan, M. M., Tabanca, N., Gao, J., Wedge, D. E., Culter, S. J. 2011. Antifungal metabolites from the roots of *Diospyros virginiana* by overpressure layer chromatography. *Chemistry and Biodiversity*, vol. 8, no. 12, p. 2331-2340.
- Wegl, G., Rolinec, M., Nagl, V., Fibi, S., Klose, V., Gierus, M., Schatzmayr, G. 2016. Effects of a natural feed additive and an in-feed antibiotic on abundance of antibiotic resistance

genes in feces of weaned piglets. In: *IPVS 2016*. Dublin, Ireland : Royal Dublin Society, p. 440.

Zohary, D. 2004. Unconscious selection and the evolution of domesticated plants. *Economic Botany*, vol. 58, no. 1, p. 5-10.

Acknowledgments:

The publication was prepared with the active participation of researchers in international network AGROBIONET, as a part of international program "Agricultural biodiversity to improve nutrition, health and quality of life" within the project ITMS 25 110 320 104 Innovation of test methods and procedures for the detection of sources of bioactive substances for the improvement of health and quality of life. Experimental activities were realized in laboratories of Excellent center for the conservation and use of agrobiodiversity at the Faculty of Agrobiolgy and Food Resources, Slovak Agricultural University in Nitra. Natalia Hudz (51600967) is thanking to the International Visegrad Scholarship Fund for the realization of research at Institute of Biodiversity Conservation and Biosafety.

Contact address:

Mgr. Olga Grygorieva, PhD., M. M. Gryshko National Botanical Gardens of Ukraine National Academy of Sciences, Timiryazevska 1, 01014 Kyiv, Ukraine, E-mail: olgrygorieva@gmail.com

prof. Svitlana Klymenko, M. M. Gryshko National Botanical Gardens of Ukraine National Academy of

Sciences, Timiryazevska 1, 01014 Kyiv, Ukraine, E-mail: cornusklymenko@mail.ru

Mgr. Olena Vergun, PhD., M. M. Gryshko National Botanical Gardens of Ukraine National Academy of Sciences, Timiryazevska 1, 01014 Kyiv, Ukraine, E-mail: en_vergun@ukr.net

Mgr. Nataliia Hudz, PhD., Danylo Halytsky Lviv National Medical University, Department of Drug Technology and Biopharmaceutics, Pekarska, 69, 79010, Lviv, Ukraine, E-mail: natali_gudz@ukr.net

Ing. Nataliia Nikolaieva, Slovak University of Agriculture in Nitra, Faculty of Agrobiolgy and Food Resources, Institute of Biological Conservation and biosafety, Trieda Andreja Hlinku 2, 949 76 Nitra, Slovakia, E-mail: n.nikolaeva703@gmail.com

Ing. Zuzana Schubertová, PhD., Slovak University of Agriculture in Nitra, Faculty of Agrobiolgy and Food Resources, Institute of Biological Conservation and biosafety, Trieda Andreja Hlinku 2, 949 76 Nitra, Slovakia, E-mail: zuzana.schubertoval@uniag.sk

Olena Palamarchuk, PhD., M. M. Gryshko National Botanical Gardens of Ukraine National Academy of Sciences, Timiryazevska 1, 01014 Kyiv, Ukraine, E-mail: lena_pastin@mail.ru

doc. Ing. Ján Brindza, PhD., Slovak University of Agriculture in Nitra, Faculty of Agrobiolgy and Food Resources, Institute of Biological Conservation and biosafety, Trieda Andreja Hlinku 2, 949 76 Nitra, Slovakia, E-mail: Jan.Brindza@uniag.sk



EFFECT OF DIFFERENT LEVELS OF GREEN TEA (*CAMELLIA SINENSIS*) ON PRODUCTIVE PERFORMANCE, CARCASS CHARACTERISTICS AND ORGANS OF BROILER CHICKENS

Cyril Hrnčár, Jozef Bujko

ABSTRACT

In this work we aimed to determine the effect of different levels of green tea in powder form to feed on productive performance, carcass parameters and organs in broiler chickens. Totally 240 day-old broiler chickens Ross 308 were divided to four dietary groups (n = 60) namely control and three experimental groups with supplementation of green tea to feed mixture in levels 0.5%, 1% and 1.5%. Broiler chickens were feeding with commercial feed mixtures and feed and drinking water were provided *ad libitum*. The feeding period lasted 42 days. Individual body weight of broiler chickens was determined at 1, 7, 14, 21, 28, 35 and 42 day, feed consumption and mortality per group were determined at 42 day of fattening period. Carcass quality and organs weight of broiler chickens were determined at the end of the experiment. The results indicated that supplementation of different levels of green tea statistically significant decreased body weight gain and we recorded lower body weight in 21 days of age compared with control group. However, in second period of fattening, broiler chickens in experimental groups growing faster and in 42 days of age we found statistically no significant differences among control and experimental groups. Feed consumption did not differ among the dietary groups at 42 days of fattening. Mortality no affected by supplementation of green tea to broiler chickens diets in comparison with control group. From the carcass parameters addition of green tea significantly decreased percentage of abdominal fat between control and 1.5% green tea level, in other parameters (percentage of breast, percentage of drumstick, carcass yield) were different among control and experimental groups not statistically significant. The caecum and small intestine weights was significantly ($p \leq 0.05$) decreased in chickens fed diets containing 0.5% green tea supplement compared to 1% and 1.5%. For neck, crop, heart, liver, proventriculus, gizzard, pancreas, kidneys, small intestine, caecum and large intestine weights among control and experimental groups we recorded no statistical differences ($p > 0.05$).

Keywords: broiler chicken; green tea; performance; carcass; organs

INTRODUCTION

In history, feed additives, such sub-therapeutic antibiotics, were amply used in order to modulate the intestinal microflora and consequently improving the performance and protect the health status of poultry (Dibaji et al., 2014; Seidavi and Simões, 2015).

Due to the consumer's pressure in whole world, including the prohibition of antibiotic usage as growth promoters in European Union from 2006, the research of alternative natural substances for diet incorporation was enhanced in last years, i.e. probiotics (Capcarová et al., 2010; Alloui et al., 2013; Ayasan, 2013), prebiotics (Alloui et al., 2013), organic acids (Kopecký et al., 2012), bee products (Haščík et al., 2013; 2015) and other feed additives (Hrnčár et al., 2015) in order to improve nutrient digestibility, control of pathogenic microorganisms, facilitate a favourable intestinal microbial

balance, and enhancing absorption of calorigenic nutrients across the gut wall through increasing its absorption capacity (Al-Harhi, 2002; El-Deek et al., 2003).

The blank phytogetic feed additives, e.g. phytobiotics such as green tea (*Camellia sinensis*), also received increased attention (Seidavi and Simões, 2015).

Abdo et al. (2010) found that air-dried green tea leaves contained 7.80% moisture, 92.20% dry matter, 82.40% organic matter, 18.15% crude protein, 8.72% ether extract, 19.32% crude fibre, 9.80% ash, 36.21% nitrogen free extract and 3002 kcal.kg⁻¹ calculated metabolisable energy (ME).

Green tea has over 200 bioactive compounds and contains over 300 different substances. The chemical composition of tea is multifaceted, consisting of polyphenols (catechins and flavanoids), alkaloids (caffeine, theobromine, theophylline), volatile oils,

polysaccharides, amino acids, lipids, vitamin C, minerals and other uncharacterised compounds (Karori et al. 2007; Khan, 2014).

Green tea has antimicrobial (Ishihara et al., 2001; Hara-Kudo et al., 2005; Lee et al., 2006; Erener et al., 2011), antioxidant (Nishida et al., 2006), immune modulatory properties (Ko and Yang, 2008) and anticoccidial effects (Jang et al., 2007).

Thielecke et al. (2010) observed that green tea has been studied extensively for its potential in the weight management category, with the compound epigallocatechingallate (EGCG), highlighted as a key component. Three mechanisms have been proposed: EGCG could increase energy metabolism and fatty acid oxidation, occurs apidogenesis i.e. inhibit fat cell development and reduce lipid absorption. EGCG has been found to be over 100 times more effective in neutralizing free radicals than vitamin C and 25 times more powerful than vitamin E. Numerous *in vitro* and *in vivo* studies of green tea preparations have demonstrated that the bioactive component of green tea improves the body weight gain and feed efficiency in poultry (Khan, 2014), calves (Sarker et al., 2010a) and pigs (Sarker et al., 2010b).

This study aims at investigating the effect of different levels of green tea in powder form on productivity, carcass characteristics and organ development of broiler chickens.

MATERIAL AND METHODOLOGY

A total of 240 day-old Ross 308 broiler chicks were housed in a close ventilated broiler house with deep litter. Temperatures were maintained at 33 °C in the 1st week and this was reduced by 2 °C every week then decrease gradually until reach 23 °C in the 6th week. The experiment was realised in housing density 30 kg.m⁻². Moisture was retained during fattening period between 50 to 60%. Lighting in the poultry house first day was 24 hours and by starting the 5 day became permanent and 23 hours, used the 40 watt bulbs.

Broiler chickens Ross 308 were divided to four dietary groups (n = 60) namely control and experimental groups with supplementation of green tea in powder form to feed (basal +0.5%; basal +1% and basal +1.5%). Broiler chickens were fed commercial feed mixtures (Boskop, a.s., Trenčín, Slovak Republic): starter (days 1 to 21) and grower (days 22 to 42), both in powder form. Feeding and watering were *ad libitum*. The nutritive values of the feed mixtures are presented in Table 1.

During the experiment broiler chickens were weighted for individual body weight at 1, 7, 14, 21, 28, 35 and 42 day of age and body weight gain were calculated as the difference between the final and initial chicken weight. Feed consumption and mortality were recorded at 42 day of fattening period.

In 42 day of fattening, representative 10 chickens with body weight similar to the mean were chosen from each group for slaughter weighed and subjected to a 12-hours feed withdrawal. After slaughter, carcasses were weighed and subjected to simplified dissection. Abdominal fat, breast and drumstick were collected and weighed. The organs development was measured by taking weight of the broilers after slaughtering. Neck, crop, heart, proventriculus, gizzard (empty gizzard), liver (without gall bladder), pancreas, caecum, kidney, small intestine and large intestine weights were recorded individually and their percentages in relation to live body weight were calculated. The results obtained were used to calculate dressing percentage and the percentage of carcass components.

Data were analyzed using analysis of variance (SAS, 2001). Significant difference was used at 0.05 probability level and differences between groups were tested using the Duncan's Multiple Range Test (Duncan, 1955).

RESULTS AND DISCUSSION

Table 2 represents the body weight and body weight gain of broiler chickens in control and experimental groups with supplementation of green tea. In period to 21 days of age, the highest ($p \leq 0.05$) body weight was found in

Table 1 Nutritional value of complete feed mixtures.

Nutrient	Unit	Starter (1. – 21. day)	Grower (22. – 42. day)
Crude protein	g.kg ⁻¹	min. 210.00	min. 190.00
ME	kJ.kg ⁻¹	min. 12.00	min. 12.00
Lysine	g.kg ⁻¹	min. 11.00	min. 9.50
Methionine and cystine from that methionine	g.kg ⁻¹	min. 7.50 min. 4.50	min. 7.50 min. 4.00
Linoleic acid	g.kg ⁻¹	min. 10.00	min. 10.00
Calcium	g.kg ⁻¹	min. 8.00	min. 7.00
Phosphorus	g.kg ⁻¹	min. 6.00	min. 5.00
Sodium	g.kg ⁻¹	1.20 – 3.00	1.20 – 2.50
Manganese	mg.kg ⁻¹	min. 50.00	min. 50.00
Iron	mg.kg ⁻¹	min. 60.00	min. 60.00
Copper	mg.kg ⁻¹	min.6.00	min. 6.00
Zinc	mg.kg ⁻¹	min.50.00	min. 50.00
Vitamin A	iu.kg ⁻¹	min. 10000	min. 8000
Vitamin B ₂	mg.kg ⁻¹	min. 4.00	min. 3.00
Vitamin B ₁₂	µg.kg ⁻¹	min. 20.00	min. 20.00
Vitamin D ₃	iu.kg ⁻¹	min. 1200	min. 1200
Vitamin E	mg.kg ⁻¹	min. 15.00	min. 15.00

Table 2 Effect of different levels of green tea on body weight and body weight gain in grams.

Day of fattening	Control (mean ±SD)	Green tea 0.50% (mean ±SD)	Green tea 1.00% (mean ±SD)	Green tea 1.50% (mean ±SD)
Body weight				
1.	44.95 ±3.86	45.03 ±4.03	44.89 ±3.79	45.08 ±3.98
7.	118.24 ±16.74 ^a	109.29 ±15.49	108.67 ±16.14	106.94 ±15.88
14.	324.69 ±51.67 ^a	305.27 ±49.36	307.91 ±50.46	304.79 ±48.19
21.	748.84 ±97.48 ^a	711.65 ±94.21	718.95 ±96.67	716.42 ±94.11
28.	1219.27 ±151.68	1196.37 ±149.37	1199.87 ±150.38	1193.07 ±147.69
35.	1647.51 ±178.36	1639.66 ±177.29	1643.97 ±178.74	1636.81 ±178.24
42.	2071.62 ±211.86	2078.81 ±213.18	2071.29 ±211.54	2069.57 ±212.67
Body weight gain				
1. – 7.	10.47 ±2.98 ^a	9.18 ±2.75	9.11 ±2.69	8.84 ±2.66
7. – 14.	29.49 ±4.96 ^a	28.00 ±4.87	28.46 ±4.71	28.26 ±4.89
14. – 21.	60.59 ±6.59 ^a	58.05 ±6.24	58.72 ±6.28	58.80 ±6.27
21. – 28.	67.20 ±8.28	69.25 ±8.44 ^b	68.70 ±8.71 ^c	68.09 ±8.73 ^d
28. – 35.	61.18 ±3.32	63.33 ±3.41 ^b	63.44 ±3.44 ^c	63.39 ±3.39 ^d
35. – 42.	60.59 ±4.79	62.74 ±4.83 ^b	61.05 ±4.81	61.82 ±4.84

^{a,b,c,d} means within the same row with different superscripts differ significantly ($p < 0.05$).

chickens in control group compared to all experimental groups. There were almost similar ($p > 0.05$) body weights on all diets with green tea from day old to 21 days of age. These results were equally with Kaneko et al. (2001) who reported that 1, 2.5 and 5% of green tea in broiler diets reduced body weight gain of the chicks and Uganbayar (2004) who found that 1 to 1.5% green tea supplement in broiler diet had effect to reduce body weight gain of the chickens. Biswas and Wakita (2001) added four levels of green tea powder (0.5, 0.7, 1, and 1.5%) to broiler starter diets. Supplemental green tea powder tended to decrease weight gain at a higher dose. In your experiment, body weight of broiler chickens in experimental groups were similar and were not significant ($p > 0.05$).

Significantly highest weight gain ($p \leq 0.05$) was observed in period from 22 to 42 day of age in 0.5% green tea fed

broilers compared to control group. Sarker et al. (2010) recorded significantly increased weight gain in broiler chickens during the finishing period at the 0.5% level compared to the 1% level of green tea. In contrast, Cao et al. (2005) found that body weight gain from 28 to 42 days of age was not improved. Supplementation of green tea can affect the absorptive processes in the gastrointestinal tract, for example, water, glucose, lipids, cholesterol, amino acids and minerals (Koo and Noh, 2007; Frejnagel and Wroblewska, 2010).

In 42 day we recorded that addition of different levels of green tea not significantly ($p > 0.05$) affected final body weight. Guray et al. (2011) supplemented a liquid hydroalcoholic extract of fresh green tea (0.1 or 0.2 g.kg⁻¹) in broiler diets. The dietary green tea extract increased the body weight. Recently, Shomali et al. (2012) investigated

Table 3 Effects of different levels of green tea on carcass characteristics in %.

Internal organ	Control (mean ±SD)	Green tea 0.50% (mean ±SD)	Green tea 1.00% (mean ±SD)	Green tea 1.50% (mean ±SD)
Breast	30.24 ±0.75	30.31 ±0.81	30.11 ±0.77	30.35 ±0.79
Drumsticks	31.18 ±0.64	30.86 ±0.68	31.11 ±0.59	30.94 ±0.66
Abdominal fat	6.36 ±0.11	6.21 ±0.10	6.19 ±0.11	6.16 ±0.10 ^a
Carcass yield	78.87 ±1.84	78.86 ±1.96	78.81 ±1.88	79.02 ±1.93

Note: ^a means within the same row with different superscripts differ significantly ($p < 0.05$).

Table 4 Effects of different levels of green tea on proportion of internal organs in %.

Internal organ	Control (mean ±SD)	Green tea 0.50% (mean ±SD)	Green tea 1.00% (mean ±SD)	Green tea 1.50% (mean ±SD)
Neck	2.98 ±0.38	3.11 ±0.36	2.96 ±0.39	3.07 ±0.37
Crop	0.29 ±0.08	0.25 ±0.06	0.26 ±0.06	0.28 ±0.07
Heart	0.62 ±0.11	0.64 ±0.13	0.64 ±0.14	0.65 ±0.14
Liver	1.92 ±0.26	1.96 ±0.32	2.08 ±0.35	2.13 ±0.36
Proventriculus	0.35 ±0.09	0.39 ±0.08	0.40 ±0.08	0.36 ±0.09
Gizzard	0.92 ±0.07	0.95 ±0.08	0.97 ±0.08	1.01 ±0.10
Pankreas	0.15 ±0.05	0.16 ±0.04	0.14 ±0.06	0.18 ±0.05
Caecum	0.51 ±0.12	0.49 ±0.09 ^a	0.55 ±0.14	0.53 ±0.11
Kidney	0.69 ±0.09	0.72 ±0.13	0.71 ±0.11	0.74 ±0.12
Small intestine	2.331 ±0.32	2.27 ±0.29 ^a	2.34 ±0.35	2.35 ±0.31
Large intestine	0.14 ±0.03	0.12 ±0.02	0.15 ±0.02	0.16 ±0.03

Note: ^a means within the same row with different superscripts differ significantly ($p < 0.05$).

the effects of high levels of greentea powder (1, 2, and 4%) on broiler growth performance for two weeks. Differences in body weight were insignificant. **Yang et al. (2003)** observed no differences in antibiotic and 0.5% green tea by product group, but body weight was decreased when broiler fed green tea by-product at 1% level. Moreover, **Sarker et al. (2010)** observed no changes in body weight and body weight gain of broiler fed green tea and fermented green tea at the level of 0.5 and 1%.

In present study was no significant difference ($p > 0.05$) in feed consumption among control group (1.72kg) and the addition of green tea 0.5% (1.69kg), 1.00% (1.70kg) and 1.50% (1.73kg) during fattening period. **Yang et al. (2003)** determined the optimum level of green tea by-product (0.5, 1, and 2%) in diets and observed non-significant differences in feed efficiency amongst treatments. Similar results were reported by **Cao et al. (2005)** indicating that feed efficiency from 28 days to 42 days of age was not improved. **Shomali et al. (2012)** observed that 1, 2, and 4% levels of green tea powder caused insignificant differences in FCR. In contrast, **Fujiki and Sugauma (2002)** and **Hasan (2014)** observed that potential improvement of feed efficiency upon the supplementation green tea were polyphenones particularly catechins, the most abundant of which is epigallocatechin gallate.

The mortality in control and experimental groups with 0.5 and 1.5% levels of green tea was identical (1.67 %), highest mortality we recorded in experimental group with 1% of green tea (3.33%) in 42 days. **Cao et al. (2005)** indicated that mortality was significantly reduced by supplementation with green tea by-products. This finding in green tea addition in broiler diet is also supported by previous studies (**Yang et al., 2003; Uganbayar, 2004**).

Carcass yield was not affected by supplementation of green tea; proportions of breast and drumstick were also no influenced (Table 3). **Biswas and Wakita (2001)** recorded that dressing percentage was not affected by green tea added in four levels of green tea powder (0.5; 0.75, 1, and 1.5%). In contrast, **Guray et al. (2011)** supplemented a liquid hydroalcoholic extract of fresh green tea (0.1 or 0.2 g.kg⁻¹) in broiler diets and recorded increased dressing percentage by dietary green tea extract. The inconsistency amongst the studies may be explained by the differences in catechins content of the green tea and green tea extract used in these studies (**Khan et al., 2014**).

The percentage of abdominal fat was decreased significantly ($p \leq 0.05$) with 1.5% green tea addition (Table 3) compared with other groups. Similar findings, namely that when the green tea by-product level was increased the percentage of abdominal fat decreased in broilers, were reported by **Yang et al. (2003)** and **Guray et al. (2011)**. However, the reduction of abdominal fat would have been caused by the suppressive effect of GTP on feed intake, which in turn reduces hepatic lipogenesis a major site of lipogenesis in poultry and fat accumulation in adipose tissue and muscles (**Biswas and Wakita, 2001**).

The results showed in Table 4 that caecum and small intestine weights was decreased significantly ($p < 0.05$) in broilers fed diets containing 0.5% green tea supplement compared to 1 and 1.5% though no significant ($p > 0.05$) difference were observed with other groups. The neck, crop, heart, liver, proventriculus, gizzard, pancreas, kidney and large intestine weights among control and

experimental groups didn't show statistical differences ($p > 0.05$). **Uganbayar (2004)** found that diets containing 0.5% green tea showed a significant weight loss of the small intestine compared to the control diet, which is similar to our study.

The analyzed data in the table 5 indicates that the treatment had no significant effect ($p > 0.05$) on neck, crop, heart, liver, proventriculus, gizzard, pancreas, kidney and large intestine proportions to body weight compared to control group.

CONCLUSION

Our results suggest that green tea supplementation at 0.5, 1, and 1.5% in powder form to broiler chicken diets no affected final body weight of broiler chickens, feed consumption, carcass parameters, carcass yield and majority of internal organs. Addition of green tea is favourable to the consumers because it makes broilers with less fat content without serious adverse effect on general performance. In conclusion, we can stated, that green tea may be good alternative to antibiotic growth promoters in broiler chickens fattening.

REFERENCES

- Abdo, Z. M. A., Hassan, R. A., Amal, A. E., Shahinaz, A. H. 2010. Effect of adding green tea and its aqueous extract as natural antioxidants to laying hen diet on productive, reproductive performance and egg quality during storage and its content of cholesterol. *Egyptian Poultry Science Journal*, vol. 30, p. 1121-1149.
- Al-Harathi, M. A. 2002. Efficacy of vegetable diets with antibiotics and different types of spices or their mixtures on performance, economic efficiency and carcass traits of broilers. *Journal of Agricultural Science – Mansoura University*, vol. 27, p. 3531-3545.
- Alloui, M. N., Szczurek, W., Świątkiewicz, S. 2013. The usefulness of prebiotics and probiotics in modern poultry nutrition: a review. *Annals of Animal Science*, vol. 13, p. 17-32.
- Ayasan, T. 2013. Effects of dietary inclusion of protexin (probiotic) on hatchability of Japanese quails. *Indian Journal of Animal Science*, vol. 83, no. 1, p. 78-81.
- Biswas, M. A. H., Wakita, M. 2001. Effect of dietary Japanese green tea powder supplementation on feed utilization and carcass profiles in broilers. *Journal of Poultry Science*, vol. 38, p. 50-57. <https://doi.org/10.2141/jpsa.38.50>
- Cao, B. H., Karasawa, Y., Guo, Y. M. 2005. Effects of green tea polyphenols and fructo-oligosaccharides in semi-purified diets on broilers' performance and caecal microflora and their metabolites. *Asian-Australasian Journal of Animal Sciences*, vol. 18, no. 1, p. 85-89. <https://doi.org/10.5713/ajas.2005.85>
- Capcarová, M., Weis, J., Hrnčár, C., Kolesárová, A., Pál, G. 2010. Effect of Lactobacillus fermentum and Enterococcus faecium strains on internal milieu, antioxidant status and body weight of broiler chickens. *Journal of Animal Physiology and Animal Nutrition*, vol. 94, no. 5, p. 215-224. <https://doi.org/10.1111/j.1439-0396.2010.01010.x> PMID:20626505
- Dibaji, S. M., Seidavi, A., Asadpour, L., Moreira da Silva, F. 2014. Effect of a synbiotic on the intestinal microflora of chickens. *Journal of Applied Poultry Research*, vol. 23, no. 1, p. 1-6. <https://doi.org/10.3382/japr.2012-00709>

- Duncan, D. B. 1955. The Multiple Range and Multiple F-test. *Biometrics*, vol. 11, p. 1-42. <https://doi.org/10.2307/3001478>
- El-Deek, A. A., Al-Harhi, M. A., Attia, Y. A., Hannfy, M. M. 2003. Effect of anise (*Pimpinella anisum*), fennel (*Foeniculum vulgare*) and ginger (*Zingiber officinale Roscoe*) on growth performance, carcass criteria and meat quality of broilers. *Archiv fur Geflugelkunde*, vol. 67, p. 92-96.
- Erener, G., Ocak, N., Altop, A., Cankaya, S., Aksoy, H. M., Ozturk, E. 2011. Growth performance, meat quality and caecal coliform bacteria count of broiler chicks fed diet with green tea extract. *Asian-Australasian Journal of Animal Sciences*, vol. 24, no.8, p. 1128-1135. <https://doi.org/10.5713/ajas.2011.10434>
- Frejnagel, S., Wroblewska, M. 2010. Comparative effect of green tea, chokeberry and honeysuckle polyphenols on nutrients and mineral absorption and digestibility in rats. *Annals of Nutrition and Metabolism*, vol. 56, p. 163-169. <https://doi.org/10.1159/000278747> PMID:20150725
- Fujiki, H., Suganuma, M. 2002. Green tea and cancer prevention of the Japanese. *Physical and Biological Sciences*, vol. 78, p. 263-270.
- Guray, E., Ocak, N., Altop, A., Cankaya, S., Aksoy, H. M., Ozturk, E. 2011. Growth performance, meat quality and caecal coliform bacteria count of broiler chicks fed diet with green tea extract. *Asian-Australasian Journal of Animal Sciences*, vol. 24, p. 1128. <https://doi.org/10.5713/ajas.2011.10434>
- Hara-Kudo, Y., Yamasaki, A., Sasaki, M., Okubo, T., Minai, Y., Haga, M., Kondo, K., Sugita-Konishi, Y. 2005. Antibacterial action on pathogenic bacteria spore by green tea catechins. *Journal of Science Food and Agriculture*, vol. 85, no. 14, p. 2354-2361. <https://doi.org/10.1002/jsfa.2259>
- Hassan, M. M. 2014. Use of green tea and probiotic as an alternative to antibiotic growth promoter in broiler diet : Ms. Theses, Bangladesh : Agricultural University, 54 p.
- Haščík, P., Elimam, I. O. E., Garlík, J., Bobko, M., Kročko, M. 2013. Sensory evaluation of broiler meat after addition slovak bee pollen in their feed mixture. *Potravinárstvo*, vol. 7, no. 1, p. 107-110. <https://dx.doi.org/10.5219/280>
- Haščík, P., Trembecká, L., Bobko, M., Čuboň, J., Bučko, O., Tkáčová, J. 2015. Evaluation of meat quality after application of different feed additives in diet of broiler chickens. *Potravinárstvo*, vol. 9, p. 174-182. <https://doi.org/10.5219/429>
- Hrnčár, C., Verguliaková, S., Svorad, P., Weis, J., Arpášová, H., Mindek, S., Fik, M., Bujko, J. 2015. Effect of L-carnitine supplementation on fattening and carcass parameters of broiler chickens. *Acta fytotechnica et zootechnica*, vol. 18, no. 1, p. 15-19.
- Ishihara, N., Chu, D. C., Akachi, S., Juneja, L. R. 2001. Improvement of intestinal microflora balance and prevention of digestive and respiratory organ diseases in calves by green tea extracts. *Livestock Production Science*, vol. 68, no. 2-3, p. 217-229. [https://doi.org/10.1016/S0301-6226\(00\)00233-5](https://doi.org/10.1016/S0301-6226(00)00233-5)
- Jang, S. I., Jun, M. H., Lillehoj, H. S., Dalloul, R. A., Kong, I. K., Kim, S., Min, W. 2007. Anticoccidial effect of green tea-based diets against *Eimeria maxima*. *Veterinary Parasitology*, vol. 144, no. 1-2, p. 172-175. <https://doi.org/10.1016/j.vetpar.2006.09.005> PMID:17027157
- Kaneko, K., Yamasaki, K., Tagawa, Y., Tokunaga, M., Tobisa, M., Furuse, M. 2001. Effects of dietary Japanese green tea powder on growth, meat ingredient and lipid accumulation in broilers. *Journal of Poultry Science*, vol. 38, no. 5, p. 77-85. <https://doi.org/10.2141/jpsa.38.J77>
- Karori, S. M., Wachira, F. N., Wanyoko, J. K., Ngure, R. M. 2007. Antioxidant capacity of different types of tea products. *African Journal of Biotechnology*, vol. 6, no. 19, p. 2287-2296. <https://doi.org/10.5897/AJB2007.000-2358>
- Khan, S. H. 2014. The use of green tea (*Camellia sinensis*) as a phytochemical substance in poultry diets. *Journal of Veterinary Research*, vol. 81, no. 1, p. 1-8. <https://doi.org/10.4102/ojvr.v81i1.706>
- Ko, S. Y., Yang, C. J. 2008. Effect of green tea probiotics on the growth performance, meat quality and immune response in finishing pigs. *Asian-Australasian Journal of Animal Sciences*, vol. 21, no. 9, p. 1339-1347. <https://doi.org/10.5713/ajas.2008.70597>
- Koo, S. I., Noh, S. K. 2007. Green tea as inhibitor of the intestinal absorption of lipids: potential mechanism for its lipid-lowering effect. *Journal of Nutritional Biochemistry*, vol. 18, no. 3, p. 179-183. <https://doi.org/10.1016/j.jnutbio.2006.12.005> PMID:17296491
- Kopecký, J., Hrnčár, C., Weis, J. 2012. The effect of organic acid supplement on the performance of broiler chickens. *Animal Science and Biotechnologies*, vol. 45, p. 51-54.
- Lee, H. C., Jenner, A. M., Low, C. S., Lee, Y. K. 2006. Effect of tea phenolics and their aromatic fecal bacterial metabolites on intestinal microbiota. *Research in Microbiology*, vol. 157, no. 9, p. 876-884. <https://doi.org/10.1016/j.resmic.2006.07.004> PMID:16962743
- Nishida T, Eruden B, Hosoda K, Nakagawa K, Miyazawa T, Shioya S 2006. Effects of green tea (*Camellia sinensis*) waste silage and polyethyleneon ruminal fermentation and blood components in cattle. *Asian-Australasian Journal of Animal Sciences*, vol. 19, p. 1728-1736. <https://doi.org/10.5713/ajas.2006.1728>
- SAS, 2001. User's Guide: Statistics version 6.12 Ed., SAS Institute, Inc., Cary, NC., USA.
- Sarker, M. S. K., Kim, G. M., Yang, C. J. 2010. Effect of green tea and biotite on performance, meat quality and organ development in Ross broiler. *Egyptian Poultry Science Journal*, vol. 30, no. 1, p. 77-88.
- Seidavi, A., Simões, J. 2015. Evaluation of dietary fish oil plus green tea supplementation on the gizzard, ileum and cecum microflora in broiler chickens. *Archivos de Zootecnia*, vol. 64, no. 248, p. 397-402.
- Shomali, T., Najmeh, M., Saeed, N. 2012. Two weeks of dietary supplementation with green tea powder does not affect performance, D-xylose absorption, and selected serum parameters in broiler chickens. *Comparative Clinical Pathology*, vol. 21, no. 5, p. 1023-1027. <https://doi.org/10.1007/s00580-011-1220-9>
- Sarker, M. S. K., Ko, S. Y., Lee, S. M., Kim, G. M., Choi, J. K., Yang, C. J. 2010a. Effect of different feed additives on growth performance and blood profiles of Korean Hanwoo calves. *Asian-Australasian Journal of Animal Sciences*, vol. 23, no. 1, p. 52 -60. <https://doi.org/10.5713/ajas.2010.90280>
- Sarker, M. S. K., Yim, K. J., Uganbayar, S. Y., Kim, D., Bae, G. M., Oh, J. I., Yee, S. T., Yang, C. J. 2010b. Green tea level on growth performance and meat quality in finishing pigs. *Pakistan Journal of Nutrition*, vol. 9, no. 1, p. 10-14. <https://doi.org/10.3923/pjn.2010.10.14>
- Thielecke, F., Rahn, G., Boehnke, J., Adams, F., Birkenfeld, A. L., Jordan, J., Boschmann, M. 2010. Epigallocatechin-3-gallate and postprandial fat oxidation in overweight/obese male

volunteers: a pilot study. *European Journal of Clinical Nutrition*, vol. 64, no. 7, p. 704-713.
<https://doi.org/10.1038/ejcn.2010.47>
[PMid:20372175](https://pubmed.ncbi.nlm.nih.gov/20372175/)

Uganbayar, D. 2004. A study on the utilization of green tea for laying hens and broiler chicks : dissertation theses. Suncheon, Korea : Sunchon National University.

Yang, C. J., Yang, I. Y., Oh, D. H., Bae, I. H., Cho, S. G., Kong, I. G., Uganbayar, D., Nou, I. S., Choi, K. S. 2003. Effect of green tea by-product on performance and body composition in broiler chicks. *Asian-Australasian Journal of Animal Sciences*, vol. 16, no. 6, p. 867-872.
<https://doi.org/10.5713/ajas.2003.867>

Acknowledgments:

This work was supported by grant VEGA No. 1/0742/17.

Contact address:

Cyril Hrnčár, Slovak University of Agriculture, Faculty of Agrobiolgy and Food Resources, Department of Poultry Science and Small Animal Husbandry, Tr. A. Hlinku 2, 949 76 Nitra, Slovakia, E-mail: cyril.hrncar@uniag.sk

Jozef Bujko, Slovak University of Agriculture, Faculty of Agrobiolgy and Food Resources, Department of Genetics and Breeding Biology, Tr. A. Hlinku 2, 949 76 Nitra, Slovakia, E-mail: jozef.bujko@uniag.sk



SEED OIL CONTENT AND SELECTED QUALITATIVE PARAMETERS OF OILS FROM GRAPE SEEDS

Patrik Burg, Vladimír Mašán, Kazimierz Rutkowski, Jana Burgová, Lubomír Lampíř, Vladimír Višacki

ABSTRACT

Grape seed oil (*Oleum vitis viniferae*) represents promising plant oil, which is used mainly in gastronomy and for pharmaceutical purposes as well as for various technical applications. In this paper, there were examined oil contents and oil quality properties of seeds taken from 8 grape cultivars. Oil contents were found to be different for each cultivar, which ranged from 11.5% (Dornfelder) to 17.5% (Riesling). The results showed a dependence between the length of the growing season for individual varieties and the total content of oil in seeds. Fatty acid concentrations in the evaluated oil samples were in various ranges, while the highest values were determined in linoleic acid 70.10 to 71.55%, oleic acid 15.61 to 17.14%, palmitic acid 6.87 to 8.18% and stearic acid 3.16 to 3.90%. Saturated fatty acid values were lower than the values of monounsaturated fatty acids and polyunsaturated fatty acids in all oil samples. The degree of unsaturation in the grape seed oil ranged between 88.6 – 89.21%. Thanks to its content, grape seed oil can be considered as a food supplement improving the nutritional value of the human diet.

Keywords: grape cultivars; grape seed oil (*Oleum vitis viniferae*); fatty acid composition; cold screw pressing

INTRODUCTION

The grape wine is the most commonly grown kind of fruit around the world. Currently the area of vineyards is about 8 million hectares, where Europe occupies approximately 57% of this hectareage, i.e. about 4.5 million hectares. According to the information from Organisation Internationale de la Vigne et du Vin (OIV, 2009), 66.5 million tonnes of grapevine are processed every year. From this amount, 38 million tonnes of grapevine are processed in Europe. Production of grapes is generally situated in moderate-warm climate zones, e.g. Italy (9.3 mt.year⁻¹), France (6.8 mt.year⁻¹), USA (6.4 mt.year⁻¹), Spain (5.9 mt.year⁻¹) but also China (5.7 mt.year⁻¹) according to the information from 2006 (FAO, 2006).

Grape pomace, the residue of wine processing, accounts for 20% of grape (v/w). Winemaking wastes, traditionally considered as an economic and environmental problem, are now becoming increasingly recognised as valuable commodities for the production of value added products, such as grappa or vine seed oil (Passos et al., 2009). Pomace consists by 20 – 26% of grape seeds, 7.8 – 11% of protein and 10 – 20% of fatty oil depending on pressing conditions (Bockisch, 1993; Schieber et al., 2002).

On average, grape seed oil is by 90% composed of poly- and monounsaturated fatty acids, which are responsible for its value as nutritive edible oil, particularly of linoleic acid (58 – 78%, 18:2n-6) followed by oleic acid (3 – 15%,

18:1n-9) and minor amounts of saturated fatty acids (10%). Unrefined oils contain bioactive compounds including tocopherols (5 – 52 mg.100 g⁻¹) and numerous phenolic components, consisting of low and high molecular plant phenolics, which may contribute to beneficial effects of vegetable oils (Bockisch, 1993; Firestone, 1999; Morin, 1996; Francáková et al., 2015).

The aim of the study was to compare seeds of 8 varieties of vine and their evaluation from the perspective of oil content and oil quality properties such as fatty acid composition.

Scientific hypothesis

Different grape varieties can affect contrast in oil content and its qualitative composition when pressed from seeds.

MATERIAL AND METHODOLOGY

Grape seeds

Collection of grape marc for the separation of seeds was carried out in the processing season 2016 at the Agropol Mikulov Company. A prototype of vibratory separator was used to separate the seeds from marc. This machine applies the principle of mechanical vibrations transmitted on three flat screens with different shapes and sizes of holes. Separation of seeds was carried out separately from marc from four white (Riesling, Pinot Gris, Pálava, and

Hibernal) as well as four red (Dornfelder, Blaufränkisch, Zweigelt and Laurot) must varieties of grapevine. For successful pressing of seeds and their storage, their initial moisture content was lowered from 43 – 49% to about 5 – 10% in a chamber dryer. The temperature in the chamber dryer did not exceeded 40 °C. Material was kept in a closed bag, at room temperature until screw pressing.

Screw pressing process

Before screw pressing experiments, the press head was pre-heated at the desired temperature for 20 minutes using a temperature-regulated heating ring. Pressing experiments were conducted without external heating (cold pressing). During pressing, grape seeds were fed into the press on demand by gravity through the hopper and the seed level was maintained constant to ensure constant press performance. Seeds of all varieties were pressed at the same speed of 40 rpm.

Analytical procedure – chemicals

There were used Sodium methoxide (Fluca), Boron trifluoride (Sigma Aldrich), 2,2,4-Trimethylpentane = isooctane (Sigma Aldrich), Nitrogen (6.0), Hydrogen (6.0) and technical air (Siad). The standard for identification: PUFA No. 3, from Menhaden Oil (Supelco) and IS (inner standard) for quantification: Methyl pentadecanoate (was purchased from Fluca) were used in analyses of fatty acid content.

Determination of water content and density

Water content of grape seeds was determined by dehydration at 103 °C according to CSN EN ISO 665 (461025) Oilseeds – Determination of moisture and volatile matter content. The analysis was made on 5 g of grinded sample, weighted with an accuracy of 0.1 mg. Results are expressed as the ratio of water loss per gram of dried sample. Determination of water content was performed in triplicate. Density of oil was determined pycnometrically according to CSN EN ISO 6883. This international standard specifies a method for the determination of the conventional mass per volume (“litre weight in air”) of vegetable fats and oils.

Determination of the total lipid content in the seeds through extraction

To determine the total lipid content, the Soxhlet extractor (Kavalierglass, Czech Republic) was used with hexane as a solvent. Crushing the seeds of a given variety always took place immediately prior to the extraction of oil using a coffee blender (Moulinex, France), for 2 min. The emphasis was always placed on precise cleaning of the grinder in order to avoid distorting of results. For seeds of each variety after grinding, the water content of the sample was determined. The temperature of the extraction mixture was kept by the heating mantle closely around the boiling point of hexane (70 °C). Extraction was always carried out for 32 hours. Subsequently, the hexane was evaporated and the sample weighed twice in two day intervals. During this time, the sample of oil was kept in a dark environment. Determination of oil content was performed in triplicate.

Analysis of fatty acids

In the analysis of fatty acids by gas chromatography, there is firstly necessary their transesterification. The extracted fat is after adding of 2 mL of isooctane with 10 mg of methyl pentadecanoate (inner standard) dissolved in ultrasound for 2 minutes. The mixture is afterwards heated with 2 mL under a reflux condenser. Subsequently, there are added 2 mL of boron fluoride to neutralize the unreacted sodium methanolate and in the acidic environment there are also esterified possible free fatty acids.

For the analysis of fatty acids, there was used a gas chromatograph HP 4890D (Hewlett Packard) with a flame ionization detector (GC-FID). The separation was performed on column DB-23 (60 m x 0,25 mm x 0.25 µm). For measuring, there was chosen the temperature program T1 = 100 °C, t1 = 3 min, 10 °C.min⁻¹ on T2 = 170 °C, t2 = 0 min, 4 °C.min⁻¹ on T3 = 230 °C, t3 = 8 min, 5 °C.min⁻¹ on T4 = 250 °C, t3 = 15 min. The injector temperature 270 °C, detector temperature 280 °C, injection 2 µl. The flow divider was set up to the ratio 40:1. The nitrogen carrier gas flow was 1 mL.min⁻¹. The resulting chromatograms were processed using the station CSW (version 1.7, Data Apex, Praha). The samples were performed in triplicates.

Statistic analysis

Results were reported as means and standard deviation. Analysis of variance (ANOVA) and Tukey's honestly significant difference (HSD) tests were conducted to determine the differences among means, (Statistica CZ, ver. 10). The statistical significance was declared at $p \leq 0.05$.

RESULTS AND DISCUSSION

The oil contents and selected oil quality properties of grape seeds obtained from 8 grape cultivars are shown in Table 1 and Table 2.

Oil Content

The results of values stated in Table 1 show that oil content of seeds of evaluated varieties moved from 11.5% for the variety Dornfelder to 17.5% for the variety Riesling (v/w). The experimentally determined values of oil content in grape seeds in this work, thus, correspond with literature data. For example, from 12.4% to 16.0% of oil in seeds of varieties typical for Turkey (Baydar et al., 2007), or state the oil content in the range of 8 – 20% (dry basis) (Crews et al., 2006) and also states the range 7 – 20% (Matthaus 2006). The experimentally determined level of oil 15.6 ± 0.14% in the variety Zweigelt grown in the Czech Republic, corresponded very well with the value found in the same variety grown in Japan (15.4%) (Ohnishi et al., 1990). This fact leads to the assumption, that a variety has a significantly higher influence on oil content in seeds than an actual location. The highest oil content was found in the variety Riesling and Laurot, which represent late-ripening varieties. The lowest oil content was determined in the variety Dornfelder, which belongs to middle early varieties. Thus, these results suggest a link between oil content and maturity of seeds.

Table 1 Oil content and selected qualitative parameters of oil from seeds of evaluated varieties.

Cultivar	Pinot Gris	Riesling	Hibernal	Pálava	Dornfelder	Blaufränkisch	Laurot	Zweigelt
Oil content (%) (v/w)	16.3 ±0.08	17.5 ±0.15	16.9 ±0.11	13.8 ±0.10	11.5 ±0.17	14.9 ±0.05	17.1 ±0.10	15.7 ±0.06
Fatty acid composition (%) (v/w)								
1	0.06 ±0.00 ^a	0.06 ±0.00 ^a	0.08 ±0.02 ^a	0.08 ±0.01 ^a	0.07 ±0.01 ^a	0.07 ±0.01 ^a	0.06 ±0.01 ^a	0.06 ±0.01 ^a
2	7.45 ±0.00 ^a	6.87 ±0.04 ^b	6.92 ±0.03 ^b	7.67 ±0.08 ^c	8.18 ±0.09 ^d	7.39 ±0.01 ^a	7.48 ±0.03 ^a	7.33 ±0.02 ^a
3	0.15 ±0.01 ^{ab}	0.19 ±0.00 ^d	0.17 ±0.01 ^a	0.15 ±0.01 ^{ab}	0.16 ±0.01 ^a	0.14 ±0.00 ^b	0.15 ±0.01 ^{ab}	0.12 ±0.00 ^c
4	3.76 ±0.00 ^b	3.87 ±0.01 ^a	3.87 ±0.02 ^a	3.62 ±0.01 ^e	3.16 ±0.02 ^d	3.9 ±0.00 ^c	3.76 ±0.01 ^b	3.88 ±0.01 ^a
5	15.33 ±0.01 ^b	17.14 ±0.02 ^a	17.14 ±0.01 ^a	16.17 ±0.02 ^d	15.61 ±0.03 ^c	16.24 ±0.02 ^e	16.44 ±0.03 ^f	16.84 ±0.04 ^g
6	0.76 ±0.00 ^{bc}	0.82 ±0.00 ^a	0.83 ±0.01 ^a	0.82 ±0.01 ^a	0.79 ±0.01 ^{cd}	0.72 ±0.01 ^e	0.79 ±0.01 ^d	0.76 ±0.00 ^b
7	71.55 ±0.01 ^e	70.15 ±0.01 ^{ab}	70.1 ±0.03 ^a	70.66 ±0.10 ^c	71.05 ±0.08 ^d	70.66 ±0.04 ^c	70.25 ±0.02 ^b	70.18 ±0.03 ^{ab}
8	0.01 ±0.00 ^a	0.01 ±0.00 ^a	0.01 ±0.01 ^a	0.01 ±0.00 ^a	0.02 ±0.00 ^b	0.02 ±0.00 ^b	0.02 ±0.00 ^b	0.01 ±0.00 ^a
9	0.42 ±0.00 ^{ab}	0.45 ±0.10 ^b	0.42 ±0.02 ^a	0.41 ±0.00 ^a	0.55 ±0.01 ^e	0.43 ±0.01 ^{ab}	0.52 ±0.01 ^d	0.38 ±0.00 ^c
10	0.14 ±0.00 ^a	0.13 ±0.00 ^a	0.12 ±0.01 ^a	0.14 ±0.00 ^a	0.08 ±0.06 ^b	0.15 ±0.01 ^a	0.15 ±0.02 ^a	0.15 ±0.01 ^a
11	0.21 ±0.01 ^c	0.18 ±0.01 ^{ad}	0.20 ±0.01 ^{abc}	0.17 ±0.01 ^d	0.20 ±0.01 ^{bc}	0.18 ±0.00 ^{abd}	0.20 ±0.01 ^{abc}	0.19 ±0.01 ^{abcd}
12	0.01 ±0.00 ^{ab}	0.01 ±0.01 ^{ab}	0.02 ±0.00 ^{bc}	0.01 ±0.00 ^{ab}	0.00 ±0.00 ^a	0.00 ±0.00 ^a	0.03 ±0.01 ^c	0.00 ±0.00 ^a
13	0.03 ±0.00 ^{ab}	0.04 ±0.00 ^a	0.03 ±0.00 ^{ab}	0.02 ±0.00 ^b	0.04 ±0.00 ^a	0.03 ±0.00 ^{ab}	0.03 ±0.00 ^{ab}	0.03 ±0.00 ^{ab}
14	0.01 ±0.01 ^a	0.00 ±0.00 ^a	0.01 ±0.01 ^a	0.00 ±0.01 ^a	0.01 ±0.01 ^a	0.00 ±0.00 ^a	0.01 ±0.01 ^a	0.00 ±0.00 ^a
15	0.03 ±0.03 ^a	0.02 ±0.02 ^a	0.01 ±0.01 ^a	0.01 ±0.02 ^a	0.02 ±0.01 ^a	0.01 ±0.01 ^a	0.03 ±0.02 ^a	0.01 ±0.01 ^a
16	0.03 ±0.01 ^a	0.03 ±0.01 ^a	0.03 ±0.01 ^a	0.02 ±0.00 ^a	0.03 ±0.02 ^a	0.02 ±0.01 ^a	0.03 ±0.01 ^a	0.02 ±0.00 ^a
17	0.02 ±0.01 ^a	0.01 ±0.00 ^a	0.01 ±0.00 ^a	0.01 ±0.00 ^a	0.01 ±0.01 ^a	0.01 ±0.01 ^a	0.02 ±0.01 ^a	0.02 ±0.01 ^a
18	0.03 ±0.00 ^a	0.03 ±0.02 ^a	0.03 ±0.01 ^a	0.03 ±0.01 ^a	0.03 ±0.01 ^a	0.03 ±0.00 ^a	0.03 ±0.01 ^a	0.02 ±0.01 ^a
Degree of unsaturation (%)	88.73 ±0.11	89.21 ±0.12	89.13 ±0.09	88.62 ±0.20	88.6 ±0.27	88.64 ±0.13	88.7 ±0.10	88.73 ±0.13

Note: 1 – myristic, 2 – palmitic, 3 – palmitoleic, 4 – stearic, 5 – oleic, 6 – vaccenic, 7 – linoleic, 8 – γ -linolenic, 9 – α -linolenic, 10 – octadecatetraenoic, 11 – cis-11-eicosenoic, 12 – arachidic, 13 – eicosatetraenoic, 14 – eicosapentaenoic, 15 – adrenic, 16 – docosapentaenoic n-6, 17 – docosapentaenoic n-3, 18 – docosahexaenoic, Mean \pm SD of three determinations, ^a Means in a column, not followed by a common letter are significantly different according to Tukey's multiple range test ($p < 0.05$).

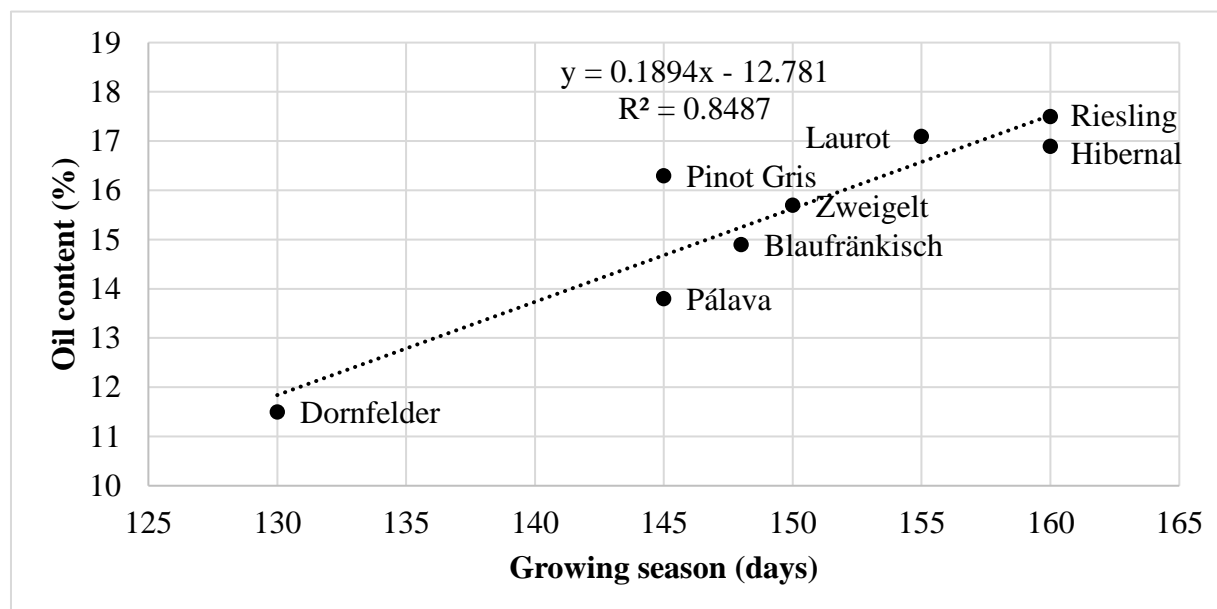

Figure 1 Influence of the growing season to the oil content in seeds.

Other author reached similar conclusions in his observations, and he states that oil content in different varieties is dependent on their maturity (Ohnishi et al., 1990).

In Figure 1, there is stated a dependence between the length of growing season of individual varieties and the

total oil content in seeds. Results clearly show lower oil content in seeds with a shorter growing season. There was found a very strong linear dependence in the samples, the coefficient of determination is $R^2 = 0.8487$.

Fatty Acid Composition

Fatty acid concentrations in evaluated oil samples ranged in different extent. The highest values were determined for linoleic acid 70.10 to 71.55%, oleic acid 15.61 to 17.14%, palmitic acid 6.87 to 8.18% and stearic acid 3.16 to 3.90%. Other fatty acids were represented in a relatively small amount in evaluated samples, e.g. myristic acid 0.06 – 0.08%, palmitoleic 0.12 – 0.19%, α -linoleic 0.38 – 0.55% etc. In oil samples from the varieties Blaufränkisch and Zweigelt, there was not determined arachidonic acid and eicosapentaenoic acid, in oil from the variety Riesling and Pálava, there was not determined eicosapentaenoic acid. The results of Tukey’s honestly significant difference (HSD) showed differences between the evaluated oil samples, especially in the content of palmitic acid, stearic acid, oleic acid, 6-vaccenic acid and 7-linoleic acid, as stated in Table 1. The differences were statistically provable ($p < 0.05$).

For example, **Barron et al. (1988)** and **Schuster (1992)** dealt with the evaluation of fatty acid content in grape seed oil. Their results imply, that in oil extracted from a mixed sample of seeds, there are mostly represented palmitic, stearic, oleic, and linoleic acids. **Ohnishi et al. (1990)** dealt with the issue of representation of fatty acids in varietal oils. In analyses of oils from five grape cultivars, he determined that the representation of palmitic acid is at the level 6.7 to 8.9%, stearic 1.1 to 5.3%, oleic 9.7 to 17.5% and linoleic 69.2 to 80.5%. He determined low values under the level of 0.1% for palmitoleic and linolenic acid. **Crews et al. (2006)** state that in grape seed oil, there is mostly represented linoleic acid (58 – 78%) and oleic acid (10 – 20%). **Morin (1996)** and **Firestone (1999)** also state that grape seed oil is on average composed of 90% poly- and monounsaturated fatty acids, which are responsible for its value as nutritive edible oil, particularly of linoleic acid (58 – 78%) followed by oleic

acid (3 – 15%) and minor amounts of saturated fatty acids (10%). Similar results are shown also by the evaluated samples, as stated in Table 2.

Ohnishi et al. (1990) state that the fatty acid composition of grape seed oil is similar to that of sunflower, or safflower oil. Sunflower oil generally comprises of 44 – 75% linoleic, 14 – 35% oleic, 3 – 6% palmitic and 1 – 3% stearic acid and safflower oil generally comprises of 73 – 79% linoleic, 13 – 21% oleic, 3 – 6% palmitic and 1 – 4% stearic acid (**Crews et al., 2006**).

The degree of unsaturation in the grape seed oil (Table 1) was over 88%, coming from unsaturated fatty acids. **Baydar et al. (2007)** state that grape seed oils are rich in oleic and linoleic acids and the degree of unsaturation in the oils is over 85%. High levels of unsaturation play an important role in lowering of high blood cholesterol and also in the treatment of atherosclerosis (**Gey 1993**). **Kinsella et al. (1993)** also states that fatty acids such as omega-3 and omega-6 significantly decrease the concentration of LDL cholesterol and their higher consumption significantly decreases the risk of myocardial hearth attack and sudden death. **Bagchi et al. (2003)** state that this positive influence is probably caused not only by the decrease of cholesterol in blood, but also by lowering of blood coagulation.

Poly-unsaturated fatty acids such as linoleic and linolenic are essential for a human body and grape seed oil may be their significant source. Grape seed oil was rather poor in linolenic acid.

To reduce smell and undesirable taste of edible oils, there is beneficial low representation of linoleic acid. **Baydar and Akkrut (2001)** state that lower content of linoleic acid positively influences shelf-life of oil. The reason is the fact that linolenic acid is simply oxidized due to having three double bonds on its hydrocarbon chain, the stability or shelf-life of an oil rich in linolenic acid would be too short.

Table 2 Fatty acid composition (%) (v/w) according to grape variety.

Cultivar	Saturated	Unsaturated	Poly-unsaturated	n-6	n-3	n-3/n-6
Pinot Gris	11.273	16.454	72.274	71.629	0.645	0.009
Riesling	10.793	18.326	70.882	70.212	0.670	0.010
Hibernal	10.877	18.345	70.793	70.174	0.622	0.013
Pálava	11.373	17.304	71.319	70.711	0.608	0.009
Dornfelder	11.398	16.767	71.836	71.122	0.714	0.010
Blaufränkisch	11.360	17.281	71.360	70.706	0.655	0.009
Laurot	11.304	17.582	71.123	70.368	0.766	0.017
Zweigelt	11.270	17.915	70.815	70.219	0.596	0.008

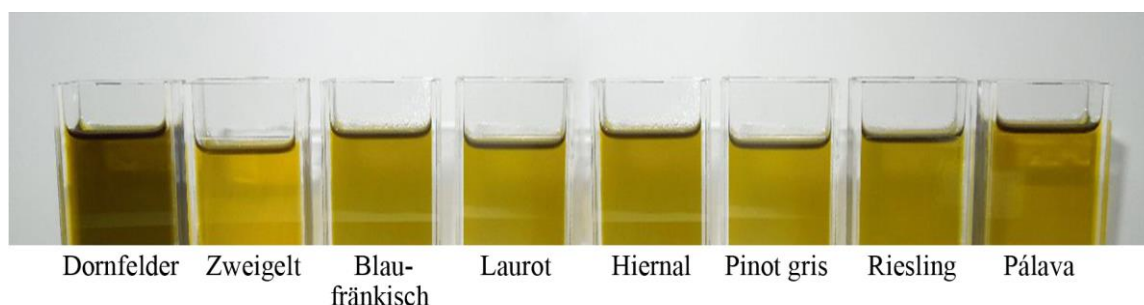

Figure 2 Colours of tested grape seed oils.

CONCLUSION

The grape seeds of eight grape cultivars (Riesling, Pinot Gris, Pálava, Hibernál, Dornfelder, Blaufränkisch, Zweigelt and Laurot) were evaluated in terms of oil content and oil quality properties including fatty acid composition. The oil content was found to be different for each cultivar, which ranged from 11.5% (Dornfelder) to 17.5% (Riesling). In the analysed samples, there were proved statistically significant differences in fatty acid composition. Saturated fatty acid values were less (10.79 – 11.40) than the values of monounsaturated fatty acids and polyunsaturated fatty acids in all evaluated oil samples. Among the identified fatty acids, linoleic acid was the predominant fatty acid and followed by oleic acid, palmitic acid and stearic acid in all varieties. Following the conducted analyses, there can be seen that the quality properties of fatty acids are markedly dependent on their degree of saturation. Unsaturated fatty acids have a lower melting point than saturated fatty acids. Grape seeds as a large by-product from wine production may be evaluated as a source of high-quality vegetable oil, which can be used as a food supplement to improve the nutritional value of the human diet.

REFERENCES

Bagchi, D., Sen, C. K., Ray, S. D., Das, D. K., Bagchi, M., Preuss, H. G., Vinson, J. A. 2003. Molecular mechanisms of cardioprotection by a novel grape seed proanthocyanidin extract. *Mutation Research*, vol. 523, p. 87-97. [https://doi.org/10.1016/S0027-5107\(02\)00324-X](https://doi.org/10.1016/S0027-5107(02)00324-X)

Barron, L. J. R., Celaa, M. V., Santa-Maria, G., Corzo, N. 1988. Determination of the triglyceride composition of grapes by HPLC. *Chromatographia*, vol. 25, no. 7, p. 609-612. <https://doi.org/10.1007/BF02327656>

Baydar, N. G., Akkurt, M. 2001. Oil content and oil quality of some grape seeds. *Turkish Journal of Agriculture and Forestry*, vol. 25, p. 163-168.

Baydar, N. G., Özkan, G., Cetin, E. S. 2007. Characterization of grape seed and pomace oil extracts. *Grasas y Aceites*, vol. 58, p. 29-33.

Bockisch, M. 1993. *Nahrungsfette und Öle (Handbuch der Lebensmitteltechnologie*. Stuttgart : Ulmer Verlag. 694 p. ISBN-10: 3800158175.

Crews, C., Hough, P., Godward, J., Brereton, P., Lees, M., Guiet, S., Winkelmann, W. 2006. Quantitation of the main constituents of some authentic grape-seed oils of different origin. *Journal of Agricultural and Food Chemistry*, vol. 54, p. 6261-6265.

FAO. 2006. FAOSTAT database collections. Food and Agriculture Organization of the United Nations [online] s.a. [cit. 2017-05-09] Available at: <http://www.fao.org/faostat/en/#home>.

Firestone, D. 1999. *Physical and chemical characteristics of oils, fats and waxes*. 2nd ed. Champaign : AOCS Press. 152 p. ISBN 9781893997042.

Frančáková, H., Ivanišová, E., Dráb, Š., Krajčovič, T., Tokár, M., Mareček J., Musilová, J. 2015. Composition of fatty acids in selected vegetable oils. *Potravinarstvo*, vol. 9, no. 1, p. 538-542. <https://doi.org/10.5219/556>

Gey, K. F. 1993. Prospects for the prevention of free radical diseases, regarding cancer and cardiovascular diseases. *British Medical Bulletin*, vol. 49, p. 679-690.

<https://doi.org/10.1093/oxfordjournals.bmb.a072640>
[PMid:8221032](https://doi.org/10.1093/oxfordjournals.bmb.a072640)

Kinsella, J. E., Frankel, E., German, B., Kanner, J. 1993. Possible mechanisms for the protective role of antioxidants in wine and plant foods. *Food Technology*, vol. 47, p. 85-89.

Matthaus, B. 2006. Native grape seed oil-as good as the advertisement promises? *NutraCos*, vol. 5, no. 3, p. 15-18.

Morin, O. 1996. *Corn and grapeseed oil*. In A. Karleskind and J. P. Wolff. *Oil and fats manual*. Hampshire: Andover. 1572 p. ISBN 1898298084.

Ohnishi, M., Hirose, S., Kawaguchi, M., Ito, S., Fujino, Y. 1990. Chemical composition of lipids, especially triacylglycerol, in grape seeds. *Agricultural and Biological Chemistry*, vol. 54, no. 4, p. 1035-1042.

OIV. 2009. Internationaler Kodex der önologischen Praxis. 2nd ed. Organisation Internationale de la Vignette et du Vin. German [online] s.a. [cit. 2017-05-09] Available at: <http://www.oiv.int/de/normen-und-technische-dokumente/onologischen-praxis/internationaler-kodex-der-onologischen-praxis>.

Passos, C. P., Silva, R. M., Silva, F. A. D., Coimbra, M. A., Silva, C. M. 2009. Enhancement of the supercritical fluid extraction of grape seed oil by using enzymatically pretreated seed. *Journal of Supercritical Fluids*, vol. 48, no. 3, p. 225-229. <https://doi.org/10.1016/j.supflu.2008.11.001>

Schieber, A., Muller, D., Rohrig, G., Carle, R. 2002. Influence of grape cultivar and processing method on the quality of cold-pressed grape seed oils. *Mitteilungen Klosterneuburg*, vol. 52 no. 1-2, p. 29-33.

Schuster, W. H. 1992. *Ölpflanzen in Europa*. Frankfurt am Main : DLG-Verlag. 239 p.

Acknowledgments:

Financial support for this research was provided by project IGA ZF MENDELU Brno, project ID: IGA-ZF/2017-DP004.

Contact address:

Patrik Burg, Mendel University in Brno, Faculty of Horticulture, Department of Horticultural Machinery, Valtická 337, 691 44 Lednice, Czech Republic, E-mail: patrik.burg@mendelu.cz

Vladimír Masan, Mendel University in Brno, Faculty of Horticulture, Department of Horticultural Machinery, Valtická 337, 691 44 Lednice, Czech Republic, E-mail: vladimir.masan@mendelu.cz

Kazimierz Rutkowski, University of Agriculture, Faculty of Production and Power Engineering, Institute of Agricultural Engineering and Informatics, ul. Balicka 116 B, pok. 402, 30-149 Krakow, Poland, E-mail: kazimierz.rutkowski@ur.krakow.pl

Jana Burgová, Mendel University in Brno, Faculty of Horticulture, Department of Breeding and Propagation of Horticultural Plants, Valtická 337, 691 44 Lednice, Czech Republic, E-mail: xmokrick@node.mendelu.cz

Lubomír Lampíř, Czech University of Life Sciences Prague, Faculty of Agrobiological Sciences, Department of Horticulture, Kamýcká 129, 165 00 Praha 6 – Suchbátka, Czech Republic, E-mail: lampir@af.czu.cz

Vladimír Višacki, University of Novi Sad, Department of Agricultural Engineering, Trg Dositeja Obradovića 8, 21000 Novi Sad, Serbia, E-mail: vladimir.visacki@polj.uns.ac.rs



THE RABBIT MEAT QUALITY AFTER DIFFERENT FEEDING

Adriana Pavelková, Jana Tkáčová, Karin Červienková, Ondřej Bučko

ABSTRACT

The goal of this present work was to evaluation the effect of feeding on selected chemical and physical parameters rabbit meat. For testing was used rabbits incurred by the crossing of two breeds: the mother – Nitriansky králik and father – Nemecký obrovitý strakoš. Rabbits came from domestic breeding and were 8 weeks old separated from the mother. We created two groups: group A was fed by feed wheat and group B was fed by granulated fodder Králik gold forte. During all the time of fattening, rabbits were fed with hay, respectively green fodder. Rabbits were slaughtered at the age of 19 weeks. After slaughtering was dissection obtained fresh rabbit meat for analysis. From chemical parameters were determined: dry matter, fat, protein, ash, energy value and biogenic amines as putrescine, cadaverine, tyramine, spermidine and spermine. From physical parameter was measured pH of meat. The initial value of pH in group A was 6.12 and after 48 hours was 6.38 and in group B was 7.32 and 6.40, respectively. Dry matter in group A was 24.86 g.100 g⁻¹ and in group B was 24.70 g.100 g⁻¹, content of fat was 1.44 g.100g⁻¹ and 1.33 g.100 g⁻¹, protein was 20.94 g.100 g⁻¹ and 21.12 g.100 g⁻¹, ash was 1.18 g.100 g⁻¹ and 1.25 g.100 g⁻¹, energy value was 461.89 kJ.100 g⁻¹ and 440.27 kJ.100 g⁻¹, respectively. Statistical evaluation of all results we found statistically significant differences ($p < 0.05$) only between the groups A and B only in biogenic amine – spermidine. Experiment was shown a high correlation between biogenic amines putrescine and tyramine, putrescine and spermine, cadaverine and tyramine.

Keywords: rabbit; feeding; analysis; protein; biogenic amin

INTRODUCTION

Rabbit meat is routinely consumed in many European countries (Malta, Cyprus, Italy, Czech Republic, Spain, Belgium, Luxembourg, Portugal, France) and Certain North African countries (Egypt, Algeria) (FAOSTAT, 2012; Dalle Zotte Szendrő, 2011; Wang et al., 2015).

More than 1.2 billion rabbits are slaughtered for meat globally every year (FAOSTAT, 2012). China is the largest producer accounting for more than 462 million rabbits or 40% of global production; China experienced a steep increase in rabbit production over the last decade (up 26% since 2001). The EU27 accounts for 28% of global production, with more than 340 million rabbits produced annually (FAOSTAT, 2012). Rabbits are the second-most farmed species in Europe, primarily in Italy, France and Spain.

At present, the importance of rabbit meat in human nutrition is growing, is considered a product of rational nutrition (Ouhayoun, 1998).

Rabbit meat is highly valued for its nutritional and dietary properties; it is a lean meat with a low-fat content and less saturated fatty acids and cholesterol than other meats (Hernandez, 2008). Compared to other types of meat (veal, lamb and pork) is rabbit meat more digestible (Enser, 1996). Rabbit meat is highly digestible, tasty and

low-calorie food often recommended by experts for human consumption (Cavani and Petracci, 2004) and recommended by persons with cardiovascular disease (Hu and Willett, 2002).

Many authors deals with possibilities to influence meat quality of different feeds – by adding, for example, alpha linolenic acid C18:3n⁻³ (Ahn et al., 1996), fish oils (it contains high amounts of long chain polyunsaturated (LCP) n-3) (Mitsuharu et al., 1997), combination of α -linolenic acid and vitamin E (Dal Bosco et al., 2004), conjugated linoleic acid (CLA) and synthetically produced oil (Marounek, 2007).

Authors Zhang et al. (2010) and Capra (2013) examined to fortify of the rabbits diet by different additives and ingredients for the purpose to improve the functional value of meat and to increase the bioactive compounds.

Meat quality not only includes nutritional properties, such as appropriate proportions of bioactive compounds, proteins, lipids and their essential sub-constituents; sensory characteristics such as tenderness, flavour and colour; healthiness such as fat and saturated fatty acids (FA); technological factors such as aptitude to be processed, but also views or perceptions about the conditions of animal production in relation to animal

welfare, the impact of animal production on the environment and, of course, food safety (Parigi Bini et al., 1992b; Bielanski et al., 2000; Dalle Zotte, 2002; Hermida et al., 2006; Dalle Zotte and Szendrő, 2011, Pogány Simonová, 2012). Impact on meat quality impacts during different life (intravital – the species, breed, age, sex, nutrition, hygiene breeding, preparation for killing and health) and after the slaughter of animals (*post-mortem*) (Mucha and Zelník, 1970).

Biogenic amines (BAs) are aliphatic (putrescine, cadaverine), aromatic (tyramine, 2-phenylethylamine) or heterocyclic (histamine, tryptamine) alkaline compounds formed in foodstuff mainly by microbial decarboxylation. BA precursors are free amino acids provided by proteolytic changes of proteins and/or peptides. Histamine is formed from histidine, tyramine from tyrosine, phenylethylamine from phenylalanine, tryptamine from tryptophane, cadaverine from lysine, and putrescine from arginine or ornithine. Apart from Bas mentioned above, the concentrations of polyamines, such as agmatine, spermine, and spermidine should be also observed. Agmatine is formed from arginine, spermine and spermidine from putrescine (Halász et al., 1994; Shalaby, 1996; Silla Santos, 1996).

BAs and polyamines are endogenous compounds with the key functions in the metabolism of living organisms. Generally, low concentrations of BAs in food and drink (practically under 100 mg.kg⁻¹) do not represent a significant risk for a healthy human. However, higher amounts of BAs (generally above 100 mg.kg⁻¹) may induce undesirable psychoactive and vasoactive effects (hypotension or hypertension, headache, nausea, breathing problems etc.) (Buňka et al., 2013).

The aim of this work was to study the effect of different feeding on selected chemical and physical parameters and content of biogenic amines in rabbit meat.

MATERIAL AND METHODOLOGY

For evaluation of effect feed on quality of rabbit meat was used Nemecký obrovitý strakoš (Checked Giant Rabbit) and Nitriansky králik (Nitraner Rabbit) which were from domestic breeding. After separation from the mothers were formed two groups – group A (n = 5) feeding with Králik gold forte and 5 days before slaughter was added wheat and group B (n = 7) feeding with only wheat. Rabbits were feeding two times in day ad – libitum and slaughter 19 weeks old (133 days).

Composition of Králik gold forte

Wheat bran, alfalfa pellets, grass pellets, sugar beet pulp – dried – sugar free, malt flower, palmo kernel pomace, sunflower meal, wheat, rape seeds pomace, sugar beet molasses, calcium carbonate, a premix of additives, rye bran, vegetable oil, sodium chloride (www.deheus.cz).

Rabbits were slaughtered and bled on Department of evaluation and processing of animal products SUA in Nitra in age 133 days.

Physical-chemical analysis

Determination of pH

Value of pH was measured in thigh muscle by core probe at a depth of 2 cm immediately after slaughter and every 30 minutes (13times), next day 3times and after 48 hours after slaughter.

Determination of basic chemical composition

Content of protein and fat was determined by INFRATEC. Content of dry mater was determined at 170 °C for 45 min. Content of ash was determined burning of meat at 550 °C for 4 hours to constant weight. The energy value was calculated according to:

$$EV = (16.75 \times P) + (30.68 \times F) \text{ (kJ.100g}^{-1}\text{)}$$

where P – protein, F – fat. Every sample (n = 12) was measured threetimes.

Determination of biogenic amines

Biogenic amines were extracted threefold from thelyophilised mater with the use of 0.6 mol L⁻¹ perchloric acid. The content of 5 biogenic amines (tyramine – TYM, putrescine – PUT, cadaverine – CAD, spermidine – SPD and spermine – SPN) was determined by the method of high performance liquid chromatography (Agilent Technologies, Agilent, PaloAlto, USA) after the preceding derivatisation by dansylchloride. Derivatisation, chromatographic separation (ZORBAX Eclipse Plus C18, 50 mm × 3.0 mm, 1.8 μm, Agilent Technologies, USA) and detection (spectrophotometrically λ = 254 nm) were performed according to Buňka et al. (2013).

Every sample (n = 12) was extracted threetimes, every extract was derivatized twice and every derivatized mixture was spread on thecolumn threetimes. Results were expressed for the fresh mater before lyophilization.

Results of the experiment were evaluated by statistical program SAS 9.3 with using application EnterpriseGuide 4.2. The variation-statistical values (mean, standard error,

Table 1 Chemical composition of Králik gold forte.

Ingredients	%
Total protein	16.00
Total oils and fats	4.60
Total fibre	16.20
Total ash	7.40
Lysin	0.75
Methionin	0.27
Calcium	0.80
Phosphorus	0.59
Natrium	0.20

coefficient of variation) and statistically significant differences by t-test between tested parameters were calculated.

RESULTS AND DISCUSSION

The figure 1 show changes of meat pH after slaughtering. Measured values had roughly the same course with only minor deviations in both groups – decreasing and increasing pH had a similar values. The initial value of pH in group A was 6.12 and after 48 hours was 6.38 and in group B was 7.32 and 6.40, respectively. **Tumova et al. (2006)** detected a pH 3 hours after the slaughter of the rabbits (they was fed ad libitum) of values in the range of 6.18 to 6.51, after 24 hours the pH decrease from 5.75 to 5.87. **Capra (2013)** followed the impact of diets with and without alfalfa on the lipid profile and he measured pH 24 hours after sloughrering. Value of pH was in group without alfalfa 5.57 and in group with alfalfa 5.59. Our data was compared to **Tumová et al. (2006)** slightly increased only – after three hours was 6.54 respectively 6.72, and after 24 hours pH was 6.62, respectively 6.51. **Mertin et al. (2012)** detected value 5.95 pH after 48 hours of sloughrering of domestic rabbit. **Pogany Simonová et**

al. (2010) found a pH of 48 hours after sloughrering was from 5.61 to 5.71 in the experimental group and 5.68 in the control group. In our experiment, the values of pH was 6.38 respectively 6.40. **Dal Bosco et al. (2001)** examined the effect of feeding on nutritional quality. The pH of the meat in the control group was 5.42 and in the group fortified by vitamin E the pH was 5.55.

Content of dry matter, ash, protein, fat and energy value are presented in Table 2.

In meat samples in the group A were measured average value of dry matter 24.86% and in group B 24.70%. **Malík (2002)** lists content of 28 – 29% dry matter in the young rabbits. **Rafay (1996)** reports that the water content is variable, depending on the age of the animals and it ranges from 65 – 80%, the dry matter is in the range 20 – 35%, the dry matter in our experiment was in this range. **Mertin et al. (2012)** in his experiment measured the total water that was 74.25% (dry matter was 25.75%), but he was measured the water content in rabbits in independence from sex and age, which could lead to different results. In this case, our data was determined at a lower level. **Barát (1989)** indicates the moisture content in meat rabbits in the range of 75.04 to 75.17 g.100 g⁻¹. **Hernandez and Dalle**

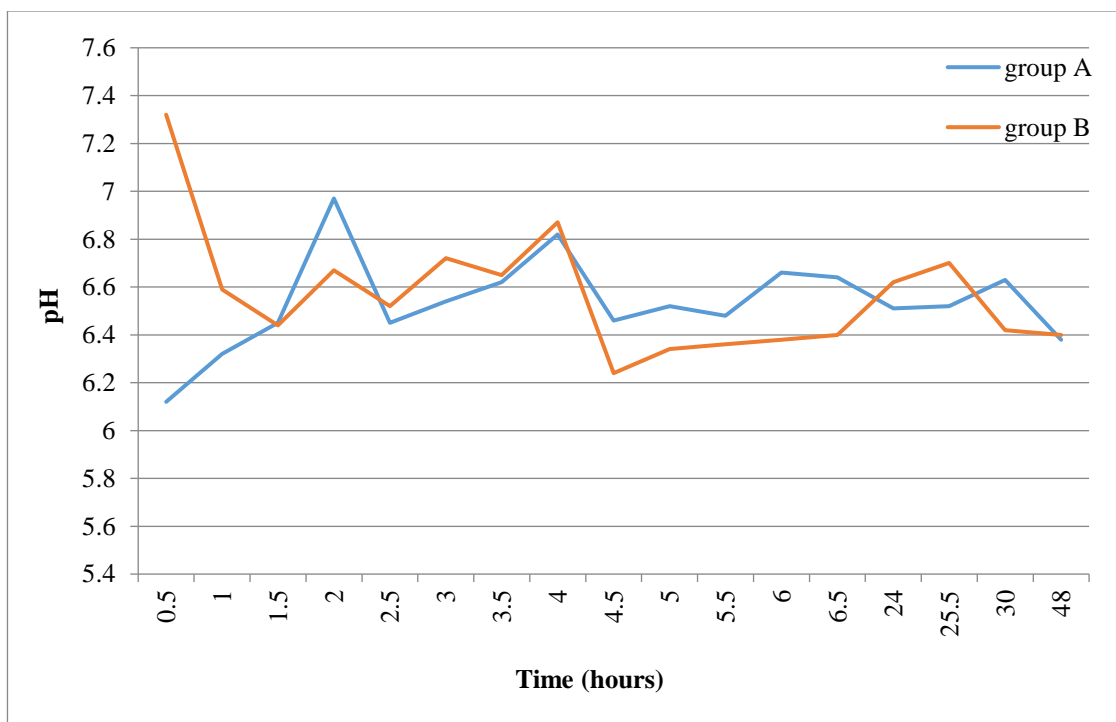

Figure 1 Change pH of rabbit meat.

Table 2 Chemical composition and energy value of rabbit meat (mean ±SD).

Group		Dry matter g.100 g ⁻¹	Fat g.100 g ⁻¹	Proteins g.100 g ⁻¹	Ash g.100 g ⁻¹	Energy kJ.100g ⁻¹
A	mean ±SD	24.86 ±0.74 ^a	1.44 ±0.30 ^a	20.94 ±0.43 ^a	1.18 ±0.08 ^a	461.89 ±56.05 ^a
	SE	0.37	0.15	0.21	0.04	28.03
	c _v (%)	2.99	20.82	2.04	7.12	12.14
B	mean ±SD	24.70 ±0.45 ^a	1.33 ±0.43 ^a	21.12 ±0.93 ^a	1.25 ±0.11 ^a	440.27 ±48.92 ^a
	SE	0.18	0.18	0.38	0.05	19.97
	c _v (%)	1.82	32.36	4.42	8.93	11.11

Note: A, B – tested group of rabbit, SE – standard error, c_v – correlation of variation. Mean values in the same columne with different superscripts (a, b) are significantly different at p <0.05 level.

Table 3 Biogenic amines concentration (mg.kg⁻¹) in rabbit meat.

Group		Putrescine	Cadaverine	Tyramine	Spermidine	Spermine
A	mean ±SD	12.003 ±5.644 ^a	109.681 ±52.634 ^a	27.658 ±11.427 ^a	6.786 ±2.270 ^a	56.926 ±9.102 ^a
	SE	2.822	26.317	5.713	1.135	4.551
	c _v (%)	47.019	47.989	41.315	33.461	15.989
B	mean	10.586 ±2.093 ^a	28.307 ±13.995 ^a	18.315 ±6.759 ^a	13.297 ±3.781 ^b	73.017 ±17.449 ^a
	SE	0.936	8.080	3.023	1.691	7.803
	c _v (%)	19.768	49.940	36.904	28.437	23.897

Note: A, B – tested group of rabbit, SE – standard error, c_v – correlation of variation. Mean values in the same column with different superscripts (a, b) are significantly different at *p* < 0.05 level.

Zotte (2010) and Dalle Zotte and Szendro (2011) indicate content of water 69.7% (30.3% solids) and Dalle Zotte (2002) reported that the water content was in the range of 66.2 to 75.3% (dry weight 33.8 to 24.7%). Dal Bosco et al. (2001) examined the effect of feeding on nutritional quality. The water content in the control group was 74.12% (25.88% dry matter) and in the group with adding of vitamin E water content was 74.26% (25.74% dry matter). Pogany Simonová et al. (2010) watched rabbit diet enriched with oregano, sage, and *Eleutherococcus senticosus* extracts. The water content was varied in the experimental groups ranging from 74.07 to 75.80% (dry matter 25.93 to 24.20%) in the control group was 75.97% (24.03% dry matter). Marounek (2007) fed rabbits in his work in experimental groups with feed supplemented with a commercial CLA preparation. Content of dry matter was from 26.5 to 26.9% in the experimental group and in the control group without supplements was dry matter 25.9%. Rabbits were slaughtered aged 77 days in his experiment. Our rabbits were slaughtered in age 133 days.

The average content of ash was in the experimental group 1.18% and in group B 1.25%. Barát (1983) mentions the ash content from 1.32 to 1.42%, Malík (2002) detected in young rabbits 1.2% and in older rabbits value of ash 1.3%. Hernandez and Dalle Zotte (2010) and Dalle Zotte and Szendro (2011) detected 1.8% of ash content. Dal Bosco et al. (2001) examined the effect of feeding on nutritional quality. The ash content in the control group was 1.06% and in the group enriched by vitamin E the ash content was 1.04%. In experimental groups enriched with oregano, sage and *Eleutherococcus senticosus* extracts Pogany Simonová et al. (2010) found an ash content of 1.033 to 1.070%, and 1.000% in control group.

The protein content in group A was in average 20.94 g.100 g⁻¹ and in group B 21.12 g.100 g⁻¹. Malík (2002) mentions that value of protein in meat young rabbits was 21.5 g.100 g⁻¹, the fat content was in the range of 2.3 to 4.5 g.100 g⁻¹. Mertin (2002), Hernandez and Dalle Zotte (2010) and Dalle Zotte and Szendro (2011) reported in their work that the contents of proteins was 20.3% and Dalle Zotte (2002) the protein content was in the range of 18.1 to 23.7%. Dal Bosco et al. (2001) examined the effect of feeding on nutritional quality. Proteins content of the control group was 22.97%, and in the group by addition vitamin E was 22.89%. Pogany Simonová et al. (2010) founded in the experimental groups protein level from 21.37 to 21.80% and in the control group 21.63%. Marounek et al. (2007) detected the content of proteins in range from 20.5 to 20.8% in experimental groups and in control group 19.6%.

Content of intramuscular fat was in average higher in Group A 1.44 g.100 g⁻¹ than in group B was 1.33 g.100 g⁻¹. Hernandez and Dalle Zotte (2010) and Dalle Zotte and Szendro (2011) mention that lipid content was 8.4% and Zotte and Dalle (2002) mention lipid content in the range of 0.6 to 14.4%. Dal Bosco et al. (2001) examined the effect of feeding on nutritional quality. The fat content of the control group was 1.85% and in the group with addition of vitamin E the fat content was 1.81%. Pogany Simonová et al. (2010) detected variability between observed groups from 1.37 to 3.53% and in the control group 1.40%. Content of lipids in experimental groups was in range from 3.22 to 3.76% and in control groups was 3.93%. Capra et al. (2013) found 1.41% of lipids in meat rabbit in group without alfalfa and 1.39% in group with alfalfa.

Average energy value was in group A 461.89 kJ.100 g⁻¹ and in group B 440.27 kJ.100 g⁻¹. Havlín et al. (1983), shows approximately the same energy value (468.5 kJ.100 g⁻¹) as it was in our Group A. Dalle Zotte (2000) shows energy value in the range 427 – 849 kJ.100 g⁻¹. Hernandez and Dalle Zotte (2010) and Dalle Zotte and Szendro (2011) indicate of energy value of meat rabbits onto 789 kJ and Dalle Zotte (2002) indicate of energy value in the range 427 – 849 kJ. Pogany Simonová et al. (2010) indicates of energy value in rabbit in the range of 416.65 – 491.03 kJ and in control group 415.11 kJ.

Content of biogenic amines are entered in the Table 3. Group A had a content of three biogenic amines (putrescine, cadaverine and tyramine) in average higher than a rabbit in group B. Found content of cadaverine in group A was several times higher in average than in group B. This extreme difference was highly likely due to differences in feeding. In literature resources are a little information about biogenic amines in meat of rabbits.

Putrescine was found in group A on average 12.003 mg.kg⁻¹, in group B 10.586 mg.kg⁻¹.

Dadáková et al. (2012) reported that putrescine was detected only in kidney samples of rabbit with mean and maximum value of 3.5 mg. kg⁻¹ and 5.3 mg. kg⁻¹, respectively. Okamoto et al. (1997) recorded at the chick meat from Japan the content of putrescine greatly lower 0.4 mg.kg⁻¹, Balamatsia et al. (2007) detected of values 53.2 mg.kg⁻¹ in chick meat from Greece, Moreira et al. (2008) show content of putrescine 1 mg.kg⁻¹ in chick meat from Brazil.

Average content of cadaverine and tyramine was in group A was 109.681 and 27.658 mg.kg⁻¹, respectively and in group B 28.307 and 18.315 mg.kg⁻¹, respectively. Sirocchi et al. (2014) not detectable content of cadaverine and

tyramine in rabbit meat by liquid chromatography – tandem mass spectrometry.

Content of spermidine and spermine was average in group A 6.786 and 56.926 mg.kg⁻¹, respectively and in group B 13.297 and 73.017 mg.kg⁻¹, respectively. **Sirocchi et al. (2014)** reported content of spermidine 8 mg.kg⁻¹ and spermine 19.40 mg.kg⁻¹ in rabbit meat. **Dadáková et al. (2012)** found of mean spermidine levels 2.2, 2.2, 61.7 and 32.7 mg.kg⁻¹ and spermine concentration 14.7, 8.0, 115 and 88.4 mg.kg⁻¹ in rabbit saddle, leg, liver and kidneys, respectively. Concentration of spermidine and spermine varied widely in meat and particularly in the organs. Level of spermidine and spermine in unspecified rabbit leg meat were 7.6 and 15.4 mg.kg⁻¹, respectively (**Cipolla et al., 2007**).

In our experiment was found statistical significant difference only in spermidine between groups A and B rabbits.

The presence of polyamines in fresh meat, liver and kidney of various animal is solved by several authors, e.g. **Okamoto et al. (1997)**, **Rokka et al. (2004)**, **Krausová et al. (2006)**, **Balamatsia et al. (2007)**, **Cipoolla et al. (2007)**, **Moreira et al. (2008)**, **Kozová et al. (2009)**, **Fuchs et al. (2009)**, **Dadáková et al. (2011)**.

CONCLUSION

Goal of work was compared influence of seed and granulated feed on chosen parameters (pH, dry matter, ash, energy value, proteins, biogenic amines) of rabbits in home rearing. In the study, the difference between the initial and ending pH values was recorded as result of the aging of meat. There were not monitored differences in values of dry matter, chemical composition of meat and energy value. Value of ash was higher in group fed by wheat. Last goal was detection of biogenous amines. There were observed significant differences. From the five monitored biogenous amines, were three higher in group A and two in group B. This difference was with high probability caused by influence of different feed.

REFERENCES

Ahn, D. H., Lutz, S., Sim, J. S. 1996. Effects of dietary α -linolenic acid on the fatty acid composition, storage stability and sensory characteristics of pork loin. *Meat Science*, vol. 43, no. 3-4, p. 291-299. [https://doi.org/10.1016/S0309-1740\(96\)00001-0](https://doi.org/10.1016/S0309-1740(96)00001-0)

Balamatsia, Ch. C., Patsias, A., Kontominas, M. G., Savvaidis, I. N. 2007. Possible role of volatile amines as quality-indicating metabolites in modified atmosphere-packaged chicken fillets: Correlation with microbiological and sensory attributes. *Food Chemistry*, vol. 104, no. 4, p. 1622-1628. <https://doi.org/10.1016/j.foodchem.2007.03.013>

Barát, E. 1989. *Rabbit farming (Chováme králiky)*. 3rd ed. Bratislava : PRÍRODA, 164 p. ISBN 80-07-00164-6.

Bielanski, P., Zajac, J., Fijal, J., 2000. Effect of genetic variation of growth rate and meat quality in rabbits. In *Proceedings of the 7th World Rabbit Congress*. Valencia, Spain : World Rabbit Science Association, p. 561–566.

Buňka, F., Budinský, P., Zimáková, B., Merhaut, M., Flasarová, R., Pachlová, V., Kubáň, V. Buňková, L. 2013. Biogenic amines occurrence in fish meat sampled from restaurants in region of Czech Republic. *Food Control*, vol. 31, no. 1, p. 49-52. <https://doi.org/10.1016/j.foodcont.2012.09.044>

Capra, G., Martínez, R., Fradiletto, F., Cozzano, S., Repiso, L., Márquez, R., Ibáñez, F. 2013. Meat quality of rabbits reared with two different feeding strategies: with or without fresh alfalfa *ad libitum*. *World Rabbit Science*, 2013, vol. 21, no. 13, p. 23-32. <https://doi.org/10.4995/wrs.2013.1197>

Cavani, C., Petracci, M. 2004 Rabbit meat processing and traceability. In *Proceedings – 8th World Rabbit Congress*. Puebla, Mexico : World Rabbit Science Association, p. 1318-1336.

Cavani, C., Petracci, M. 2006. Rabbit meat traceability. In Maertens. L. and Coudert P. *Recent Advances in Rabbit Sciences*. Merelbeke, Belgium : ILVO, p. 291-300. ISBN 92-898-0030.EPS.

Cipolla, B. G., Havouis, R., Moulinoux, J. P. 2007. Polyamine contents in current foods: A basis for polyamine reduced diet and a study of its long term observance and tolerance in prostate carcinoma patients. *Amino Acids*, vol. 33, no. 2, p. 203-212. <https://doi.org/10.1007/s00726-007-0524-1>
[PMid:17578651](https://pubmed.ncbi.nlm.nih.gov/17578651/)

Dadáková, E., Pelikánová, T., Kalač, P. 2011. Concentration of biologically active polyamines in meat and liver of sheep and lambs after slaughter and their changes in mutton during storage and cooking. *Meat Science*, vol. 87, no. 2, p. 111-116. <https://doi.org/10.1016/j.meatsci.2010.09.009>
[PMid:20952133](https://pubmed.ncbi.nlm.nih.gov/20952133/)

Dadáková, E., Pelikánová, T., Kalač, P. 2012. Concentration of biologically active polyamines in rabbit meat, liver and kidney after slaughter and their changes during meat storage and cooking. *Meat Science*, vol. 90, no. 3, p. 796-800. <https://doi.org/10.1016/j.meatsci.2011.11.017>
[PMid:22136981](https://pubmed.ncbi.nlm.nih.gov/22136981/)

Dal Bosco, A., Castellini, C., Bernardini, M. 2001. Nutritional Quality of Rabbit Meat as Affected by Cooking Procedure and Dietary Vitamin E. *Journal of Food Science*, vol. 66, no. 7, p. 1047-1051. <https://doi.org/10.1111/j.1365-2621.2001.tb08233.x>

Dal Bosco, A., Castellini, C., Bianchi, L., Mugnai, C. 2004. Effect of dietary α -linolenic acid and vitamin E on the fatty acid composition, storage stability and sensory traits of rabbit meat. *Meat Science*, vol. 66, no. 2, p. 407-413. [https://doi.org/10.1016/S0309-1740\(03\)00127-X](https://doi.org/10.1016/S0309-1740(03)00127-X)

Dalle Zotte, A. 2000. Main factors influencing the rabbit carcass and meat quality. In *Proceedings - 7th World Rabbit Congress*. Valencia, Spain : World Rabbit Science Association, Suppl.1, p. 507-537.

Dalle Zotte, A. 2002. Perception of rabbit meat quality and major factors influencing the rabbit carcass and meat quality A. *Livestock Production Science*, vol. 75, no. 1, p. 11-32. [https://doi.org/10.1016/S0301-6226\(01\)00308-6](https://doi.org/10.1016/S0301-6226(01)00308-6)

Dalle Zotte, A., Szendrő, Zs. 2011. The role of rabbit meat as functional food. *Meat Science*, vol. 88, no. 3, p. 319-331. <https://doi.org/10.1016/j.meatsci.2011.02.017>
[PMid:21392894](https://pubmed.ncbi.nlm.nih.gov/21392894/)

Enser, M., Hallet, K., Hewitt, B., Fursey, G. A. J., Wood, J. D. 1996. Fatty acid content and composition of English beef, lamb and pork at retail. *Meat Science*, vol. 4, no. 4, p. 443-456. [https://doi.org/10.1016/0309-1740\(95\)00037-2](https://doi.org/10.1016/0309-1740(95)00037-2)

FAOSTAT, 2012. Rabbit meat production in the EU [online] s.a. [cit. 2017-05-09] Available at: <http://www.compassioninfoodbusiness.com/media/6898105/info-1-rabbit-meat-production-in-the-eu.pdf>.

Fuchs, T., Bauer, F., Paulsen, P. 2009. Content of polyamines in by-products of slaughter pigs. *Meat Science*, vol. 83, no. 1, p. 161-164.

<https://doi.org/10.1016/j.meatsci.2009.04.018>

PMid:20416770

Halász, A., Baráth, Á., Simon-Sarkadi, L., Holzapfel, W. 1994. Biogenic amines and their production by microorganisms in food. *Trends in Food Science and Technology*, vol. 5, no. 2, p. 42-49.

[https://doi.org/10.1016/0924-2244\(94\)90070-1](https://doi.org/10.1016/0924-2244(94)90070-1)

Havlín, J. 1983. *Domestic animal breeding (Domáci chov zvierat)*. Praha : Státní zemědělské nakladatelství. 408 p.

Hermida, M., Gozalez, M., Miranda, M., Rodríguez-Otero, J. L. 2006. Mineral analysis in rabbit meat from Galicia (NW Spain). *Meat Science*, vol. 73, no. 4, p. 635-639.

<https://doi.org/10.1016/j.meatsci.2006.03.004>

PMid:22062563

Hernández, P. 2008. Enhancement of Nutritional Quality and Safety in Rabbit Meat. In *Proceedings 9th World Rabbit Congress*. Verona, Italy : Meat Quality and Safety, p. 1287-1300.

Hernández, P., Dalle Zotte, A. 2010. Influence of diet on rabbit meat quality. In de Blas, C. and Wiseman, J. *Nutrition of the rabbit*. Univesidad Poletenica, Madrid : University of Nottingham, UK, p 163-178. ISBN 978 1 84593 669 3.

<https://doi.org/10.1079/9781845936693.0163>

Hu, F. B. 2002. Optimal diets for prevention of coronary heart disease. *Journal of American Medical Association*, vol. 288, no. 20, p. 2569-2578.

<https://doi.org/10.1001/jama.288.20.2569>

PMid:12444864

Kozová, M., Kalač, P., Pelikánová, T. 2009. Contents of biologically active polyamines in chicken meat, liver, heart and skin after slaughter and their changes during meat storage and cooking. *Food Chemistry*, vol. 116, no. 2, p. 419-425.

<https://doi.org/10.1016/j.foodchem.2009.02.057>

Krausová, P., Kalač, P., Křížek, M., Pelikánová, T. 2006. Contents of polyamines in beef and pork after animal slaughtering. *European Food Research and Technology*, vol. 223, no. 3, p. 321-324. <https://doi.org/10.1007/s00217-005-0206-8>

Malík, V. 2002. *Poultry and rabbits (Hydina a králiky)*. Bratislava : PRÍRODA, p. 88-104. ISBN 80-07-00963-9.

Marounek, M., Skrivanova, V., Dokoupilova, A., Czauderna, M., Berladyn, A. 2007. Meat quality and tissue fatty acid profiles in rabbits fed diets supplemented with conjugated linoleic acid. *Veterinarni Medicina*, vol. 52, no. 12, p. 552-561.

Mertin, D. Slamečka, J. Ondruška, E., Zaujec, K., Jurčík, R., Gašparík, J. 2012. Comparison of meat quality between European brown hare and Domestic rabbit. *Slovak Journal of Animal Science*, vol. 45, no. 3, p. 89-95.

Mitsuharu, I., Yoshihiro, K., Keiichi, S., Yuuko, O., Hiroyuki, A. 1997. The effects of fish oil enriched with n-3 polyunsaturated fatty acids on lipids and tasty compounds of pork loin. *Nippon Shokuhin Kagaku Kogaku Kaishi*, vol. 43, no. 11, p. 1219-1226.

Moreira, A. P. S., Giombeli, A., Labanca, R. A., Nelson, D. L., Glória, M. B. A. 2008. Effect of aging on bioactive amines, microbial flora, physicochemical characteristic and tenderness of broiler breast meat. *Poultry science*, vol. 87, no. 9, p. 1868-1873. <https://doi.org/10.3382/ps.2007-00370>

PMid:18753456

Mucha, R., Zelník, J. 1970. *Rabbit farming (Chov králikov)*. 2nd ed. Bratislava : Príroda. 273 p.

Okamoto, A., Sugi, E., Koizumi, Y., Yanadiga, F., Uda, S. 1997. Polyamine content of ordinary foodstuffs and various fermented foods. *Bioscience, Biotechnology, and Biochemistry*, 61, no. 9, p. 1582-1584.

<https://doi.org/10.1271/bbb.61.1582>

PMid:9339564

Ouhayoun, J. 1998. Influence of the diet on rabbit meat quality. In de Blas, J. C. and Wiseman, J. *The nutrition of the rabbit*. Wallingford, UK : CAB International, p. 177-195.

Parigi Bini, R., Xiccato, G., Cinetto, M., Dalle Zotte, A., 1992b. Effetto dell'eta e peso di macellazione e del sesso sulla qualita della carcassa e della carne cunicola. 2. Composizione chimica e qualita della carne. *Zootechnical Nutrition of Animal*, vol. 18, p. 173-190.

Pogány Simonová, M., Lauková, A., Chrastinová, L., Szabóová, R., Strompfová, V. 2012. Microbial Status and Quality of Rabbit Meat after Rabbits Feed Supplementation with Phyto-Additives. *Potravinárstvo*, vol. 6, no. 4, p. 41-44.

<https://doi.org/10.5219/213>

Pogány Simonová, M., Chrastinová, L., Mojto, J., Lauková, A., Szabóová, R., Rafay, J. 2010. Quality of Rabbit Meat and Phyto-Additives. *Czech Journal of Food Science*, vol. 28, no. 3, p. 161-167.

Rafay, J. 1996. Meat of rabbits (Mäso králikov). *Chovateľ*, no. 8, p. 304-308.

Rokka, M., Eerola, S., Smolander, M., Alakomi, H. L., Ahvenainen, R. 2004. Monitoring of the quality of modified atmosphere packaged broiler chicken cuts stored in different temperature conditions B. Biogenic amines as quality-indicating metabolites. *Food Control*, vol. 15, no. 8, p. 601-607. <https://doi.org/10.1016/j.foodcont.2003.10.002>

SAS 2008. 9.3 Enhanced Logging Facilities (Computer software). Cary, NC : SAS Institute Inc.

Silla Santos, M. H. 1996. Biogenic amines: their importance in foods. *International Journal of Food Microbiology*, vol. 29, no. 2-3, p. 213-231. [https://doi.org/10.1016/0168-1605\(95\)00032-1](https://doi.org/10.1016/0168-1605(95)00032-1)

Shalaby, A. R. 1996. Significance of biogenic amines to food safety and human health. *Food Research International*, vol. 29, no. 7, p. 675-690. [https://doi.org/10.1016/S0963-9969\(96\)00066-X](https://doi.org/10.1016/S0963-9969(96)00066-X)

Sirocchi, V., Caprioli, G., Ricciutelli, M., Vittori, S., Sagratini, G. 2014. Simultaneous determination of ten underivatized biogenic amines in meat by liquid chromatography-tandem mass spectrometry (HPLC-MS/MS). *Journal of Mass Spectrometry*, vol. 49, no. 9, p. 819-825.

<https://doi.org/10.1002/jms.3418>

PMid:25230178

Tümová, E., Zita, L., Štolc, L. 2006. Carcass quality in restricted and ad libitum fed rabbits. *Czech Journal of Science*, vol. 51, no. 5, p. 214-219.

Wang, J., Guowu, L., Mauricio, A. E., Linjun, Y., Shiyi, Ch., Xianbo, J., Songjia, L. 2015. A novel single nucleotide polymorphism of the POU1F1 gene associated with meat quality traits in rabbits. *Annals of Animal Science*, vol. 15, no. 3, p. 611-620. <https://doi.org/10.1515/aoas-2015-0015>

Zhang, W., Xiao, S., Samaraweera, H., Joo, L. E., Ahn, D. U. 2010. Improving functional value of meat products. *Meat Science*, vol. 86, no. 1, p. 15-31.

<https://doi.org/10.1016/j.meatsci.2010.04.018>

PMid:20537806

Contact address:

Adriana Pavelková, Slovak University of Agriculture, Faculty of Biotechnology and Food Sciences, Department of Evaluation and Processing of Animal Products, Tr. A. Hlinku 2, 949 76 Nitra, Slovakia, E-mail: adriana.pavelkova@uniag.sk

Jana Tkáčová, Slovak University of Agriculture, Faculty of Biotechnology and Food Sciences, Department of

Evaluation and Processing of Animal Products, Tr. A.
Hlinku 2, 949 76 Nitra, Slovakia, E-mail:
jana.tkacova@uniag.sk

Karin Červienková, Slovak University of Agriculture,
Faculty of Biotechnology and Food Sciences, Department
of Evaluation and Processing of Animal Products, Tr. A.

Hlinku 2, 949 76 Nitra, Slovakia, E-mail:
Karin.Cervienkova@uniag.sk

Ondřej Bučko, Slovak University of Agriculture, Faculty
of Agrobilogy and Food Resources, Department of Animal
Husbandry, Tr. A. Hlinku 2, 949 76 Nitra, Slovakia,
E-mail: ondrej.bucko@uniag.sk



PRODUCTION AND CHARACTERIZATION OF PECTINASE ENZYME FROM *RHIZOPUS ORYZAE*

Taminur Islam Chowdhury, Fahad Jubayer, Burhan Uddin, Gulzarul Aziz

ABSTRACT

The research was conducted with the production of pectinase enzyme by fungal fermentation using *Rhizopus oryzae* and characterization of produced enzyme with respect to pH, temperature, incubation time, and substrate specificity. Carbon source was optimized replacing sugar with different concentration of pectin (0.5, 0.75, and 1.0%) during submerged fermentation. The outcomes of the fermentation process showed that media containing carbon source of 1% pectin replaced dextrose at pH 6.0 incubating for 72 hours at 35 °C were the best condition for pectinase production. The maximal activity for pectinase enzyme produced from *Rhizopus oryzae* by fermentation was 3.16 U.mL⁻¹ and it was found at 40 °C and pH 6.5. The produced pectinase enzyme was found thermo stable up to 60 °C for 50 min. The activity of the enzyme was increased with the increasing pectin concentration in the media and maximum activity was found at the pectin concentration of 5 mg.mL⁻¹. The k_m and V_{max} values were found 0.84 mg.mL⁻¹ and 5.294 mg.mL⁻¹ respectively at optimized condition. The outcomes of the research may be useful for further research in low cost production of pectinases from *R.oryzae* for domestic consumption in many industries.

Keywords: pectinase; submerged fermentation; Pectin; enzyme; incubation

INTRODUCTION

Enzyme is an essential tool in juice processes, both in terms of quality improvement and cost saving (**Ramadan and Moersel, 2007**). Now a day's production of fruit and vegetable juice is almost unthinkable without the use of enzymes (**Baumann, 1981**). The degradation of plant cell walls by exogenous enzymatic treatment results in easier release of the components contained in cells (**Janser, 1997**).

The utilization of microbial enzymes has found broad technological application in different industrial processes. Among the various enzymes commercialized many are products of fermentation of filamentous fungi (**Piccoli-valle et al., 2001**).

Pectinases are the groups of enzymes, which cause degradation of pectin that, are chain molecules with a rhamnogalacturonan backbone, associated with other polymers and carbohydrates. These pectinases have wide applications in fruit juice industry and wine industry. In fruit juice industry, it is used for clarification, where reduction in viscosity is caused which ultimately leads to formation of clear juice. In wine industry pectinases are mainly used for decreasing astringency by solubilizing anthocyanins without leaching out procyanidin polyphenols, and pectinases also increase pigmentation by extracting more anthocyanins (**Tucker and Woods, 1991**).

Pectinases can be produced by both submerged and solid state fermentation (SSF). Submerged fermentation is cultivation of microorganisms on liquid broth. It requires high volumes of water, continuous agitation and generates lot of effluents. Solid state fermentation incorporates microbial growth and product formation on or within particles of a solid substrate (**Mudgett, 1986**) under aerobic conditions, in the absence or near absence of free water, and does not generally require aseptic conditions for enzyme production. Many filamentous fungi like *Aspergillus niger*, *Aspergillus awamori*, *Penicillium restrictum*, *Trichoderma viride*, *Mucor piriformis*, and *Yarrowia lipolytica* are used in both submerged as well as solid state fermentation for production of various industrially important products such as citric acid and ethanol.

Fungi can produce both intracellular as well as extracellular enzymes. All fungi are heterotrophic, and rely on carbon compounds synthesized by other living organisms. Small molecules like mono disaccharides, fatty acids and amino acids can easily pass through but for breaking down of larger complex compounds like pectin, fungi secrete extra cellular enzymes. It is well known that as compared to intracellular enzymes, the extra cellular enzymes are easier to be extracted. Intracellular enzymes require more time and costly chemicals for extraction (**Hankin and Anagnostakis, 1975**).

Rhizopus oryzae is a filamentous fungus which is commonly found in dead organic matter. *Rhizopus sp.*, *Gleosporium kake*, *Ciniotrium diplodella* and *Aspergillus niger* have been reported to produce exo-Polygalacturonases as well as endo Polygalacturonase which release galacturonic acid from the terminal pectin chain (Kawano *et al.*, 1999).

In Bangladesh, this enzyme is not commercially produced and cost to import is very high. At the same time, commercial production of enzymes is not reputed in Bangladesh. Normally enzyme is produced either by fermentation or extracted from plant or animal sources. It involves high cost for the production of enzymes employing any of the processes. Moreover, to get the potential benefits from extracted enzymes; it has to send through series of purification steps and needs special care to stabilize during storage. Due to these constraints, no companies are interested to adopt this technology in food industries of Bangladesh.

Scientific hypothesis

Keeping the above-mentioned points in consideration, the present investigation was undertaken to produce and to characterize pectinase enzymes from the *Rhizopus oryzae* collected from DSMZ, Germany in the form of freeze-dried. The following main objectives were drawn to carry out the investigation:

- To optimize cell growth of *Rhizopus oryzae*
- To optimize medium conditions for enzyme production
- To characterize pectinase enzyme.

MATERIAL AND METHODOLOGY

Materials

Fermentative organism

Rhizopus oryzae (DSM-1185) was collected from DSMZ, Germany in the form of freeze-dried. The culture was activated according to the following method as mentioned by suppliers:

At first the tip of the ampoule was heated in a flame. Two or three drops of water were then placed onto the hot tip to crack the glass. After that the glass tip was carefully strike off with an appropriate tool (e.g. forceps). The insulation material was removed with forceps and taken out the inner vial. The cotton plug of the inner vial was lifted and kept it under sterile condition and the top of the inner vial was then flamed. Added 0.5 mL of medium prepared following the manufacturer's formulation and replaced the plug. Then the pallet was allowed to rehydrate for about

30 minutes. The content was mixed gently with an inoculation loop or a pasteur pipette and transferred the whole amount of the mixture in to a test tube with about 5 mL of potato dextrose liquid medium. The mixture was then transferred in to the vial. 100 µL of the suspension was streaked onto an agar plate. The liquid and agar culture was then incubated under sterile conditions.

Chemicals

Dinitrosalicylic acid (DNS) (purity 99%), potassium mono-hydrogen phosphate (purity 99%), dipotassium hydrogen phosphate (purity 97%), sodium potassium tartrate (purity 99%), D (+) galcturonic acid (purity >95%) were collected from commercial suppliers. All the chemicals were analytical grade with the highest purity.

Instruments

Microscope; Thermo shaker (Hangz hou long Gene Scientific Instruments Co. Ltd. P.R., China); Potable pH meter (HANNA Instruments Inc., Woonsocket, Rhode Island, USA); Centrifuge (cat. No.: CF, 405, 5000 rpm. Gallenkamp, England); Air oven (Memmert, Germany), Incubator (Model: 1H-100, Gallenkamp, England); Water bath (Wytownia Sprzetu Laboratorynego, Poland); Laminar flow (HEPA filter 0.3 micron, area: 3×2×2 ft., Bangladesh); Sterilizer (St. Steel Autoclave, Capacity 30 liter, cat.no. ST 3028, model no. ST××28, Unipath Ltd., Basingstoke, England); Spectrophotometer (Spectronic ins., USA) was used throughout research period.

Growth of *Rhizopus oryzae* on potato dextrose agar

R. oryzae culture was cultivated on the potato dextrose agar as the spores were to be stored for longer period for the utilization of organism in different trials. The Potato dextrose agar (PDA) medium was prepared according to the composition given in Table 1

At first healthy potato tuber was taken and skin was removed. Then the potato was cut into small slices. 200 g sliced potato and 500 mL of water was then boil together for 15 minutes so that the potato tissues could be softened. The prepared pulp was then sieved through a muslin cloth. After that 15 g of agar and 500 mL of water was heated separately. Then both water and agar solutions were mixed and 20 g dextrose was added to it. Thus, 1000 mL potato dextrose agar medium (PDA) was prepared.

The prepared medium was autoclaved at 121 °C for 15 minutes under 1.1 kg.cm⁻² pressures (Asghar *et al.*, 2000). After cooling, the medium was transferred

Table 1 Sporulation medium (PDA) composition for *Rhizopus oryzae*.

Ingredient	Composition
Sliced potato	200g
Dextrose	20g
Agar	15g
Distilled water	1000mL

Table 2 Liquid medium (PD) composition for *Rhizopus oryzae*.

Ingredient	Composition
Sliced potato	200g
Dextrose	20g
Distilled water	1000mL

aseptically to pre-sterilized petri dishes. Then streak 100µl of the mother culture of the organism onto an agar plate or petri dishes and incubated at 30 °C for 3 days to allow the spores to germinate.

Determination of cell growth by dry cell wt. methods

Seven (7) test tubes were taken containing 5 mL of liquid medium. The liquid medium was prepared according to the composition given in Table 2.

By using inoculation loop the culture from the sporulation medium was transferred to the test tubes under aseptic conditions. Then incubated these test tubes at 37 °C in an incubator for 9 days and observed the wt. gain of biomass of the *R. oryzae* for every 24 hr over 9 days by the following method:

At first a filter paper was taken and placed in an air oven (at 65 ±5 °C) for 1 hr. Then the wt. (W₁) of the filter paper was taken. After incubation the biomass was filtrated through the filter paper. Then the filter paper with biomass was placed in an air oven (at 65 ±5 °C) for 24 hr. After drying, the filter paper was removed from the oven and cooled in desiccators. The filter paper was removed from desiccators and weighed (W₂) soon after reaching room temperature. The gain in weight was taken as the cell growth of the *R. oryzae*. The readings were taken after incubating the test tube for every 24 hr over 9 days and the cell growth were calculated as follows:

$$\text{Dry cell wt. (cell growth, g/L)} = (W_2 - W_1)/5 * 1000$$

Enzyme production

The fungal mother culture was used to produce pectinase enzyme using liquid medium containing dextrose 2%, citrus pectin 1% at pH 6. Fermentation was carried out in a test tube containing 5 mL of liquid medium with 100µl mother culture of *R. oryzae* and incubated at 30 °C for 7 days (Angayarkanni et al., 2002). The biomass was separated by filtration. The supernatant was used to evaluate the polygalacturonase enzyme activity.

Optimization

Medium carbon source (dextrose) replaced with pectin

Pectin was used separately at different concentrations (0.5, 0.75 and 1.0%) in the medium. The fermentation was carried out for a period of 120 hours keeping other components and conditions were the same as described before.

pH

Pectinase biosynthesis was carried out by growing fungus at different pH media (5.0, 5.5, 6.0, 6.5, and 7.0) to find out the optimum pH level for enzyme production.

Temperatures

For optimization of temperature, the production of pectinase was performed at different temperatures (30.0, 32.5, 35.0, and 37.5 °C) using the same media.

Incubation time

To find out the optimum time required for maximum pectinase activity, samples were harvested at different time intervals of 24, 48, 72, 96, and 120 hours and pectinase activity were determined.

Sample harvesting

After specific interval of incubation time, the biomass from the experimental test tubes was separated by filtering through Whatman filter paper no.1. The filtrate was centrifuged at 5,000 rpm for 15 minutes in the centrifuge (cat. no.: CF, 405, 5000 rpm. Gallenkamp, England) to remove the spores and mycelia of the organism. The supernatant was carefully collected and stored at refrigerated temperature in sterilized test tubes.

Enzyme activity

Polygalacturonase hydrolyzes the polymer of pectin into the galacturonic acid monomers. The free galacturonic acid units produced as a result of polygalacturonase activity reacts with 3-5 dinitrosalicylic acid (DNS) reagent and form a colored complex. The degree of change of color was measured by spectrophotometer at wavelength of 550 nm. Greater the amount of galacturonic acid produced, darker the color of the enzyme- galacturonic acid complex formed and more the light absorbed.

Preparation of dinitrosalicylic acid (DNS) solution

Different ingredients used for the preparation of DNS solution are as follows:

- 1) Distilled water 1416 mL
- 2) 3.5 Dinitrosalicylic Acid 10.6 g
- 3) NaOH 19.5 g

The above ingredients were dissolved gently in water bath at 80 °C until a clear solution was obtained. Then the following chemicals were added.

- 4). Rochelle salt (sodium potassium tartrate) 300g

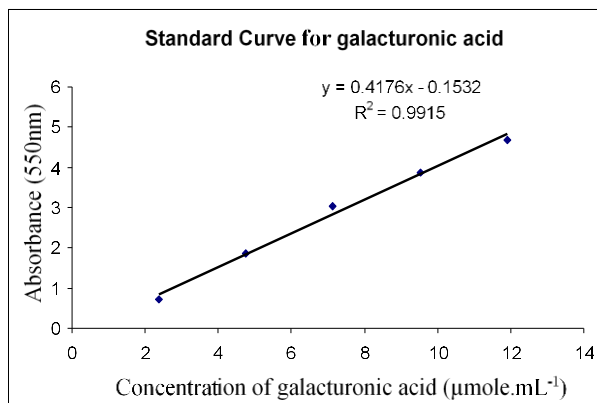

Figure 1 Standard curve for galacturonic acid.

- 5) Phenol (melted at 60 °C) 7.5 mL
- 6) Sodium meta-bisulphate 8.3g

After dissolving the above ingredients, the solution was filtered through Whatman filter paper 1 and stored at room temperature in an amber colored bottle to avoid photo oxidation.

Standard curve for galacturonic acid (GA)

Five solutions having concentration of 0.05 mg.mL⁻¹, 0.10 mg.mL⁻¹, 0.15 mg.mL⁻¹, 0.20 mg.mL⁻¹ and 0.25 mg.mL⁻¹ of galacturonic acid were prepared in distilled water. Each concentration of 500 µL was added in a vial along with 500 µL DNS solution. The vials were kept in boiling water for 3 minutes and cooled. A blank sample was also prepared (500 µL each of distilled water and DNS solution). Absorbance was determined at 550 nm and a graph was drawn by plotting absorbance against concentration (Figure 1).

Polygalacturonase (PG) enzyme assay

The filtrate was assayed for pectinase activity; determined at 50 °C using 0.1% (w/v) pectin as substrate at pH 5.0. Reducing substances were measured using DNS method (Miller, 1959; Carmona et al., 1998). Enzyme activity was expressed as U.mL⁻¹.

Unit of activity

According to the International Union of Biochemistry, one international unit of pectinase (1 U) corresponds to the amount of enzyme required to release 1 micromole of reducing substance (GA) in 1 minute. Enzyme activity was expressed as U.mL⁻¹.

Estimation of activity

The polygalacturonase activity was determined by measuring the amount of reducing substances liberated from citrus pectin. The reaction mixture consisted of substrate buffer (0.1 g citrus pectin dissolved in 100 mL of 0.1 M phosphate buffer, pH 5) 450 µL and enzyme solution 50 µL. This mixture was incubated at 50 °C for 30 min under shaking condition (800 rpm) in the thermo shaker. Later, 500 µL DNS reagent was added to the vial, kept in boiling water for 5 minutes and cooled in ice water. A blank was also prepared in the same way as mentioned earlier. The absorbance was read at 550 nm using spectrophotometer. One unit of enzyme activity (U) was defined as 1 µmole of galacturonic acid released per min

(Silva et al., 2002).

Calculation of enzyme activity

The enzyme activity was calculated by the following formula

$$\text{Activity} = \frac{\text{Dilution} \times \text{Absorbance}}{\text{Time of incubation (min)}} \times \text{Standard Factor}$$

$$\text{Standard factor} = \frac{\text{Concentration of standard solution (\mu\text{mole/mL})}}{\text{Absorbance at 550 nm}}$$

Enzyme characterization

Characterization of pectinase was performed with respect to temperature, pH and substrates following the method described by Coral et al. (2002).

Optimum temperature

For the estimation of optimum temperature, the enzyme assay was carried out at pH 6.5 in six different temperatures of 30 °C, 35 °C, 40 °C, 45 °C, 50 °C, and 55 °C.

Optimum pH

The best pH for enzyme activity was determined by carrying out the enzyme assay at optimum temperature in different pH levels (5.0, 5.5, 6.0, 6.5, 7.0, 7.5 and 8.0).

Heat stability

The heat stability of enzyme was determined by subjecting it to different temperatures of 40 °C, 50 °C, 60 °C, 70 °C and 80 °C for 15 min. The percentage of original activity retained after heat treatment (80 °C for 15 min) was calculated.

Optimum incubation time

For estimation of optimum incubation time, the enzyme assay was carried out at optimum pH and temperature in different incubation time (15, 30, 45, 60, 75, and 90 min.).

K_m and V_{max} value

The reaction speed V_{max} and Michaelis constant K_m were

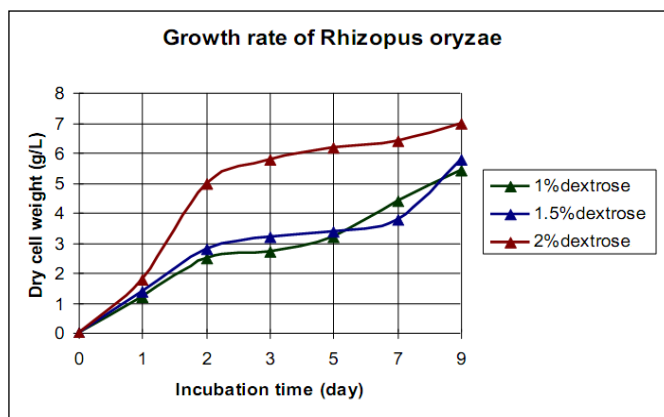

Figure 2 Growth curve of R.oryzae.

Table 3 Rate of change of cell mass growth (g/L/d).

At day	Rate of change of cell growth (g/L/d) at		
	1% dextrose	1.5% dextrose	2% dextrose
1	1.2	1.4	1.8
2	1.3	1.4	3.2
3	0.2	0.4	0.8
5	0.25	0.1	0.2
7	0.6	0.2	0.1
9	0.5	1.0	0.3

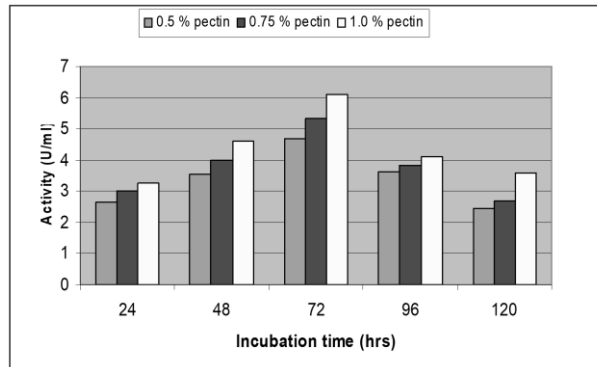

Figure 3 Effect of incubation period for pectinase production in different pectin substitute media.

determined for the enzyme by varying the substrate concentration from 0.25 – 5.0 mg.mL⁻¹ and plotting substrate/velocity as function of substrate concentration (Line-Weaver & Burk, 1934).

Substrate specificity

Pectin is the main substrate of pectinase enzymes. To assess the substrate specificity of extracted pectinase enzymes, starch, CMC in addition of pectin were incubated at optimum pH and temperature. Activities exhibited in different substrates will be used as a measure of substrate specificity of extracted enzymes after cell separation from fermented media.

RESULTS AND DISCUSSION

Growth of *Rhizopus oryzae* on potato dextrose

The prepared potato dextrose agar (PDA) medium was transferred aseptically to pre-sterilized Petri dishes. Then 100µl of mother culture of the organism was streaked onto an agar plate or petri dishes and incubated at 30 °C for 3 days to allow the spores to germinate. From the morphological study of *R. oryzae* and microscopic view of *R. oryzae* it was confirmed that it was the fungus of *R. oryzae*.

Optimization of growth rate of *Rhizopus oryzae*

The dextrose concentration of the culture medium is important for the growth of *R. oryzae*. In the present study the various concentrations of dextrose (1.0%, 1.5% and 2.0%) were used to optimize the growth rate of *R. oryzae*. During fermentation, it was observed that at 2% dextrose solution *R. oryzae* showed rapid growth and higher cell mass than that of at 1.5% and 1.0 % respectively. [Sentence deleted]. It is interesting that the growth rate of *R. oryzae* in fermentation media containing 1% and 1.5% dextrose showed almost the same trend throughout the fermentation period (Figure 2).

According to Table 3, the highest cell growth rate was found at day 2 irrespective of dextrose concentrations. After then cell growth rate drastically reduced and it remained almost unchanged up to day 7.

It means that the three media containing 1%, 1.5% and 2% dextrose respectively were reached in log phase within two days of incubation period and from day 2 to 7 the phase seems to be stationary. In log phase the rate of multiplication is rapid because of presence of sufficient nutrient and favorable growth conditions whereas in stationary phase the fungus was hardly multiplied and the number remained almost static due to cease of nutrient. It is noticeable that the continuation of fermentation (after day 7) resulted in further increase of the dry cell mass. Though the following after stationary phase the fungus goes to die, the unusual increase of dry cell at day 9 might due to waste accumulation and unwanted metabolites in the fermentation media.

Production of pectinase

Pectinase enzyme exhibits extracellular behavior during metabolism of many funguses. In case of extracellular enzymes, they are excreted outside the cell of the microorganism into the media during fermentation. Due to extracellular nature of fungus, *R. oryzae* was used for the pectinase biosynthesis and various conditions including concentration of pectin in the medium, incubation temperature, pH of medium and incubation time were optimized.

Optimization of incubation time and pectin concentration in the medium

Various concentrations of pectin at the rate of 0.5%, 0.75% and 1.0% were added to the production medium and the enzyme production in the submerge fermentation (SmF) was studied for different period of incubation (24h, 48h, 72h, 96h and 120h) at control temperature of 35 °C

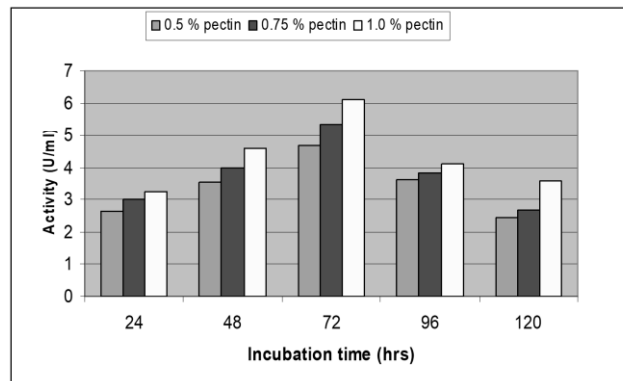

Figure 4 Effect of pH on pectinase production.

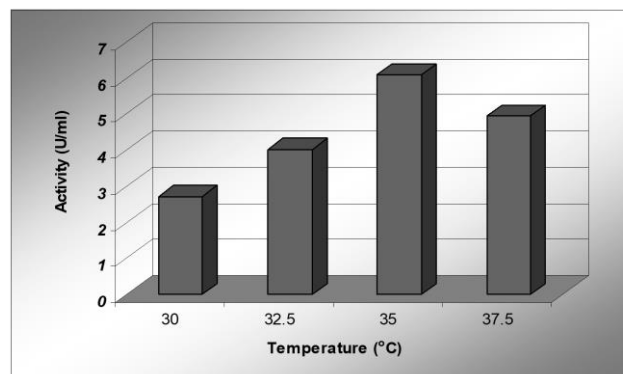

Figure 5 Effect of temperature on pectinase production.

and at pH 6.0. As shown in Figure 3, the maximum pectinase production was found in 72 hrs (4.70 U.mL⁻¹, 5.34 U.mL⁻¹ and 6.09 U.mL⁻¹) irrespective of pectin substitution in the fermentation medium. In comparison to the entire fermentation time, pectinase production in terms of volumetric activity was increasing gradually with increasing incubation time up to 72 hrs and afterwards it was decreasing following the same pattern.

This might be due to the fungi would have entered into its exponential phase within this period. According to Figure 2, though the log phase was shown up to day 2, it was observed in most of the cases of fermentation that the highest yield of enzymes was achieved at the end log phase and/or just starting of the stationary phase.

Thereafter the fungus started to die so that the metabolism was also stopped and enzyme production started to decrease. Excess waste accumulation and unwanted metabolites production are also responsible to decrease enzyme production in case of fermentation of extra-cellular enzyme producing microorganism.

The results of current work are in close conformity to the findings of Phutela et al. (2005). They reported that the maximal production of pectinase (415 U.g⁻¹) and PG (473 U.g⁻¹) was obtained after 48 and 72 h of incubation,

respectively. Further incubation resulted in the decline in enzyme activities up to 120 h.

In case of pectin substituted media at specific incubation time, pectinase activity increased with increasing pectin concentration. At 72 hrs incubation time, the highest activity (6.09) was found at 1% pectin substituted media and the lowest (4.70) was found at 0.5% pectin substituted media. The activity of pectinase at 0.75% substituted media was 5.34 U.mL⁻¹. At incubation time of 120 hrs, pectin substitutions at the rate of 0.5% and 0.75% have minor effect. But at incubation time 96 hrs the change in pectinase activity at different pectin solution were observed much close. The phenomenon in case of incubation time 24 hrs was almost the same. Likewise 72 hrs incubation, significant good variation in pectinase activity was observed at incubation time 48 hrs.

After separation of cells from fermentation media, the clarified solution was used as pectinase samples and it was observed that the solution with higher activity showed more turbid which resulted in higher absorbance reading in DNS solution. This is due to the higher concentration of protein as pectinase enzyme, which was secreted during metabolism of pectin in fermentation.

Table 4 Effect of temperature on the pectinase activity.

Temperature (°C)	Absorbance at 550nm	Volumetric activity (U.mL ⁻¹)
30 °C	1.76	2.80
35 °C	1.83	2.92
40 °C	1.90	3.03
45 °C	1.89	3.01
50 °C	1.77	2.85
55 °C	1.71	2.72

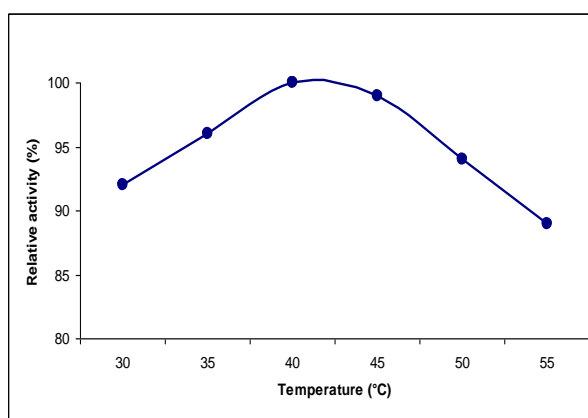

Figure 6 The relative activity of pectinase at pH 6.5 under different temperatures.

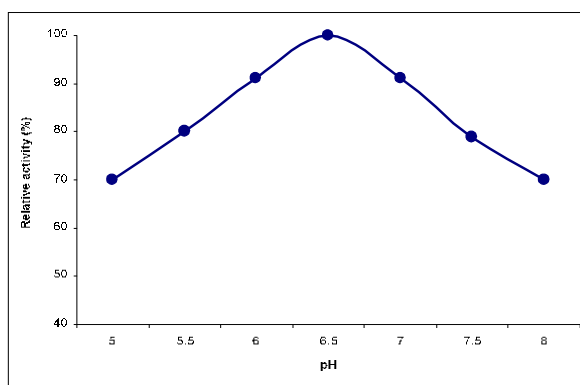

Figure 7 The relative activity of pectinase at 40 °C under different pH levels.

Effect of pH of cultivated media on pectinase production

The pH of the cultivation medium is an important factor in the production of pectinases for it influences the sort and content of those enzymes produced by fungus. The fermentation was carried out in medium containing 1.0% pectin at 35 °C and incubated at 72 hrs under pH 5.0, 5.5, 6.0, 6.5 and 7.0.

In our study the maximum activity of 6.09 U.mL⁻¹ was found at pH 6.0. Either increase or decrease of pH beyond the optimum value showed decline in enzyme production (Figure 4). However, the mechanism by which the pH acts

on the production of pectic enzyme is not known. The increasing levels of pH significantly affected the enzyme production. The enzyme activity was increased from 3.62 U.mL⁻¹ to 6.09 U.mL⁻¹ at pH 5.0 to 6.0 respectively then it decreased progressively to 4.58 U.mL⁻¹ at pH 7.0.

The results were more or less similar to those reported by Banu et al. (2010). They reported that the enzyme production by *Penicillium chrysogenum* was higher at pH 6.5 and a temperature of 35 °C. Piccoli-Valle et al. (2001) observed that a high polygalacturonase and pectin esterase activity was showed by *P. griseoroseum* in more acid pH of 4.5 and 5 and of pectinlyase, pH was close to the

Table 5 Effect of pH on the pectinase activity.

pH	Absorbance at 550nm	Volumetric activity (U.mL ⁻¹)
5.0	1.408	2.24
5.5	1.596	2.54
6.0	1.811	2.89
6.5	1.985	3.16
7.0	1.816	2.89
7.5	1.581	2.52
8.0	1.404	2.23

Table 6 Effect of heat treatment on the pectinase activity.

Temperature (°C)	Volumetric activity (U.mL ⁻¹)	Relative activity (%)	% loss of activity
40 °C	3.03	100	0
50 °C	2.76	91	9
60 °C	2.71	89	11
70 °C	2.23	74	26
80 °C	0.87	28	72

Table 7 Effect of incubation time on the pectinase activity.

Time (min.)	Relative activity (%)
10	95
20	95
30	100
40	93
50	85
60	72
70	68
80	60
90	52

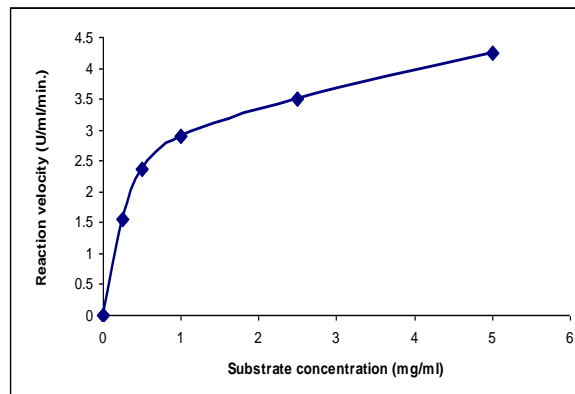

Figure 8 Effect of substrate concentrations on pectinase activity of *R. oryzae*.

neutral, 5 – 7. *P. viridicatum* showed maximum production of polygalacturonase and pectinase at a pH of 4.5 and 5 respectively (Silva et al., 2002).

Effect of temperature of cultivated media on pectinase production

The fermentation was carried out in medium containing 1.0% pectin at pH 6.0 and incubated at 72 hrs under different temperatures such as 30 °C, 32.5 °C, 35 °C and 37.5 °C. In our study the maximum activity of 6.09 U.mL⁻¹ was found at 35 °C. The pectinase production increased with rise in temperature 30 °C to 35 °C and exhibited maximum activity at 35 °C. With a rise in temperature over 35 °C the pectinase production was decreased (Figure 5).

Similar result was found by Banu et al. (2010). They reported that the enzyme production by *Penicillium chrysogenum* was higher at pH 6.5 and a temperature of 35 °C using sucrose and ammonium sulphate as carbon and nitrogen source, respectively. However, Chellegatti (2002) reported that the temperature optima of 50 °C were obtained from a purified culture fluid of *P. frequentans*.

Characterization of pectinase

After separation of cells from fermentation media, pectinase solution was subjected to characterization to find the optimum conditions for its best activity. Data regarding characterization of pectinase would be a guide line for its application in food products. For this purpose, pectinase produced in the study was characterized for temperature, pH, heat stability, incubation time and K_m values.

Effect of temperature on the pectinase activity

The effects of temperature on enzymatic activities were investigated at pH 6.5 under different temperature and the

results showed in Table 4. The maximum activity (3.03 U.mL⁻¹) was found at temperature 40 °C and minimum activity (2.72 U.mL⁻¹) was found at temperature 55 °C.

The Figure 6 depicts the effect of different temperatures on relative activity of pectinase. It is obvious that when enzyme assay was performed at various temperatures, the pectinase activity increased with rise in temperature up to 40 °C and exhibited maximum activity. However, further increase in temperature caused a decrease in activity. Minimum activity was observed at 55 °C; the highest temperature studied in the present study.

The results of current work are in close conformity to the findings of Martin et al. (2004). They reported that the purified polygalacturonase from the fungus *Penicillium sp EGC5* exhibited highest activity at 40 °C. Likewise, Riou et al. (1992) calculated optimum activity of exopolymethylgalacturonase from the fungus *Sclerotinia sclerotiorum* at 45 °C. However, Banu et al. (2010) reported 50 °C as optimum temperature for the activity of pectinase enzyme from the fungus *Penicillium chrysogenum*.

Effect of pH on the pectinase activity

The effects of pH on enzymatic activities were investigated at temperature 40 °C and the results showed in Table 5. For estimation of optimum pH, the enzyme assay was carried out at optimum temperature (40 °C) in different pH levels ranging from 5 to 8.0. The increasing level of pH influenced the activity of pectinase enzyme. At pH 5.0 to 6.5, the activity of pectinase increased from 2.24 U.mL⁻¹ to 3.16 U.mL⁻¹ then it decreased progressively to 2.23 U.mL⁻¹ at pH 8.0.

The graphical representation of the relative activity of produced enzymes under the influence of different pH

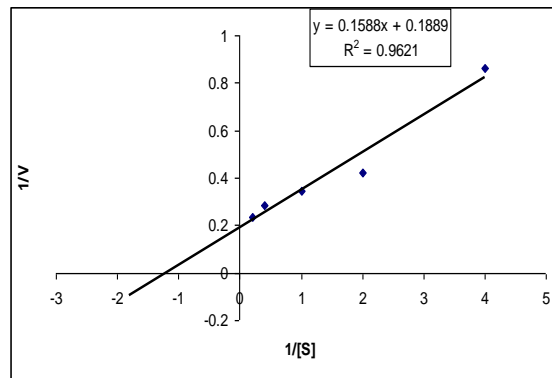

Figure 9 Lineweaver-burk plot for the hydrolysis of pectin by the pectinase activity of *R. oryzae*.

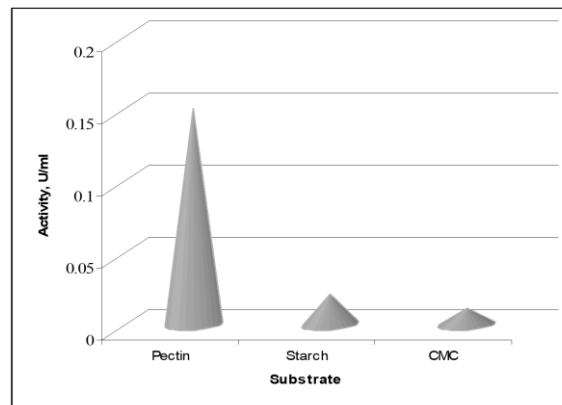

Figure 10 Substrate specificity of extracted enzyme at optimized pH and temperature.

values indicated that the enzyme exhibited minimum relative activity at pH 5.0 ($2.24 \text{ U}\cdot\text{mL}^{-1}$) (Figure 7). When the pH was raised above 5.0, a gradual increase in enzyme activity was observed and at pH 6.5 the enzyme exhibited maximum activity ($3.16 \text{ U}\cdot\text{mL}^{-1}$). However, further increase in pH showed a gradual decrease in pectinase activity.

The results of current work are similar with the findings of **Banu et al. (2010)**. They found the maximum pectinase activity from *Penicillium chrysogenum* in the pH 6.5. Likewise, **Arotupin et al. (2008)** reported that the optimum temperature for pectinmethylesterase (PME) activity was 30°C and most active at pH 6.5. **Martin et al. (2004)** reported that polygalacturonase (PG) from *Penicillium sp.* was stable at pH range of 3 – 8 and maintained 70% of initial activity at 70°C . Pectin lyase (PL) produced by this microorganism was stable in acidic to neutral pH (4.0 – 8.0) and was stable in temperature lower than 40°C .

Heat stability of pectinase enzyme

Heat stability of the enzyme under different temperatures is important regarding its application in different processes. The responses of produced enzymes against heat are shown in Table 6.

When the activity of the pectinase was detected at different temperatures, it showed maximum activity at 40°C (Table 6). Considering this activity as 100%, the enzyme was subjected to the elevated temperature in order to find out the stability of pectinase. The increase in temperature showed a negative effect on the enzyme performance and activity loss was higher as the incubation temperature was kept higher than 60°C . When the

temperature was 70°C , the enzyme exhibited 74% enzyme activity infers that it lost 26% of the total activity. However, when the enzyme activity was calculated at 80°C , it exhibited only 28% enzyme activity infers that it lost 72% of the total activity. The decrease in the heat stability is certainly being due to enzyme denaturation at higher temperatures.

The findings of the present study are supported by the results found by **Banu et al. (2010)**; they produced pectinase from the fungus *Penicillium chrysogenum* that was stable at a temperature 40°C up to 60 min.

Effect of incubation time on the pectinase activity

The effects of incubation time on enzymatic activities were investigated at pH 6.5 and 40°C under 10 to 90 min (Table 7).

As shown in Table 7, the influence of different incubation time on the enzyme activity indicated that the activity of pectinase enzyme produced by *Rhizopus oryzae* was increased up to the first 30 mins. After then enzyme activity was decreased gradually with increasing reaction time. It indicated that the reaction was seized within this time due to completion of hydrolysis of all most all substrate within this time. The further increase in incubation time resulted in a gradually decrease in relative activity. This might due to the change of its structure or conformity during prolong exposure in solution.

The findings of the present study are supported by the results found by **Banu et al. (2010)**; they produced pectinase from the fungus *Penicillium chrysogenum* that was stable at a temperature 40°C up to 60 min.

Determination of K_m and V_{max} of pectinase enzyme from *R. oryzae*

The activity of the enzyme increased from 1.16 to 4.25 U/ml/min with increasing in the substrate concentration from 0.25 to 5.0 mg.mL⁻¹ and was found maximum activity at 5 mg.mL⁻¹ and further increase in substrate concentration above the optimum level will not produce any increase in the enzyme activity (Figure 8). This is happened when residual substrate is reached too low to continue further reaction.

The kinetic parameter of pectinase enzyme from *Rhizopus oryzae* was determined. The Lineweaver-Burk plot for the hydrolysis of pectin showed a K_m of 0.84 mg.mL⁻¹ and V_{max} of 5.294 U.mL⁻¹ of enzyme (Figure 9).

The results of current work are similar with the findings of Arotupin et al. (2008). They reported that the activity of the enzyme produce by *Aspergillus repens* increased with increase in substrate concentration reaching maximum at 4 mg/mL and the Lineweaver-Burk plot for the hydrolysis of pectin indicated approximately 1.3 mg.mL⁻¹. Likewise Banu et al. (2010) reported that the pectinase produced from *Penicillium chrysogenum* have the K_m and V_{max} values of 1.0 mg.mL⁻¹ and 85 U.mg⁻¹ of protein respectively.

Substrate specificity

Pectin is the major substrate of pectinase enzyme. To assess the presence of different enzymes other than pectinase enzymes, extracted enzyme solution was incubated with starch and CMC, other than pectin. The activity of produced enzymes in different substrates is shown in Figure 10. As shown in Figure 10, there is hardly any activities observed in starch and CMC.

CONCLUSION

The current exploration was an effort to produce pectinase enzyme by *R. oryzae*. In the production medium dextrose at three concentrations (1%, 1.5% and 2%) were used to optimize the growth rate of *R. oryzae*. Dextrose replaced with pectin was used as a carbon source by the organism through submerged fermentation technique. Pectin replaced at three concentrations (0.5, 0.75 and 1.0%), five pH levels of the culture medium (5.0, 5.5, 6.0, 6.5 and 7.0), four incubation temperatures (30 °C, 32.5 °C, 35 °C and 37.5 °C) and five fermentation periods (24, 48, 72, 96 and 120 hrs), were used to optimize the conditions for maximum pectinase activity. The outcomes of the fermentation process showed that at 2% sugar solution *R. oryzae* showed rapid growth and higher cell mass and dextrose replaced with 1% pectin was the best carbon sources for pectinase production as compared to that of 0.5% and 0.75% pectin. It showed maximum pectinase activity 6.09 U.mL⁻¹ at 35 °C, pH 6.0 and 72 hrs fermentation period. After optimization of culture conditions, the laboratory scale production of pectinase was carried out using dextrose replaced with 1% pectin as carbon source at 35 °C, pH 6.0 and 72 hrs of incubation for its further use. The produced pectinase was then stored at refrigerated temperature in sterilized test tubes and subjected to characterize for its optimum pH (5.0 – 8.0), temperature (30 – 70 °C), heat stability, and substrate

(pectin) concentration (0.25 to 5.0 mg.mL⁻¹). The kinetic parameter K_m and V_{max} of the produced pectinase enzyme was also determined. Later on, to assess the presence of different enzymes other than pectinase enzymes, extracted enzyme solution was incubated with starch and CMC, other than pectin. It was found that the maximal activity of *R. oryzae* secreting pectinase was found at pH 6.5 and 40 °C whereas showed 91% heat stability at 60 °C. The activity of the enzyme increased with increasing the substrate (pectin) concentration from 0.25 mg.mL⁻¹ to 5.0 mg.mL⁻¹ and was found maximum activity at substrate concentration of 5.0 mg.mL⁻¹. K_m and V_{max} values were found 0.84 mg.mL⁻¹ and 5.294 U.mL⁻¹, respectively at optimized conditions. The activity of produced enzymes in different substrates was shown that there is hardly any activity observed in starch and CMC other than pectin. In conclusion, pectinase enzyme is an important tool for many processing industries especially for fruit juice, wine and textile industry. However, a limited supply of this enzyme, high cost and complicated produces for production locally restricts wider use. The results obtained here will be useful for further research in low cost production of pectinases from *R. oryzae* for domestic consumption in many industries. Research revealed that solid state fermentation using low cost renewable substrate is excellent alternative in reducing cost of enzyme production. By solid state fermentation it is possible to produce enzymes with higher activity and higher concentration of protein. Therefore, further research of producing pectinase enzyme by employing solid state fermentation might result in a low cost and economically viable process.

REFERENCES

- Arotupin, D. J., Akinyosoye, F. A., Onifade, A. K. 2008. Purification and characterization of pectinmethylesterase from *Aspergillus repens* isolated from cultivated soil. *African Journal of Biotechnology*, vol. 7, no. 12, p. 1991-1998. <https://doi.org/10.5897/AJB2008.000-5046>
- Angayarkanni, J., Palaniswamy, M., Murugesan, S., Swaminathan, K. 2002. Improvement of tea leaves fermentation with *Aspergillus spp.* pectinase. *Journal of Bioscience and Bioengineering*, vol. 94, no. 4, p. 299-303. [https://doi.org/10.1016/S1389-1723\(02\)80167-0](https://doi.org/10.1016/S1389-1723(02)80167-0)
- Asghar, M., Yaqub, M., Sheikh, M. A., Barque, A. R. 2000. Optimization of cellulase production by *Arachniotus sp.* using corn stover as substrate. *Journal of Animal and Plant Science*, vol. 10, no. 1-2, p. 37-40.
- Banu, A. R., Devi, M. K., Gnanaprabhal, G. R., Pradeep, B. V., Palaniswamiy, M. 2010. Production and characterization of pectinase enzyme from *Penicillium chrysogenum*. *Indian Journal of Science and Technology*, vol. 3, no. 4, p. 377-381.
- Baumann, J. W. 1981. Application of Enzymes in Fruit Juice Technology. *Enzymes and Food Processing*, p. 129-147. https://doi.org/10.1007/978-94-011-6740-6_8
- Carmona, E. C., Marcia, R. B. B., Aline, A. P. K., Jao, A. J. 1998. Purification and biochemical characterization of an endoxylanase from *Aspergillus versicolor*. *FEMS Microbiol. Letters*, vol. 166, no. 2, p. 311-315. <https://doi.org/10.1111/j.1574-6968.1998.tb13906.x>
- Chellegatti, M. A. S. C., Fonseca, M. J. V., Said, S. 2002. Purification and partial characterization of exopolysaccharuronase I from *Penicillium frequentans*.

Microbiology Research, vol. 157, no. 1, p. 19-24.

<https://doi.org/10.1078/0944-5013-00127>

Coral, G., Arikan, B., Unaldi, M. N., Guvenmez, H. 2002. Some properties of crude carboxymethyl cellulase of *Aspergillus niger* Z10 wild-type strain. *Turkish Journal of Biology*, vol. 26, no. 2002, p. 209-213.

Hankin, L., Anagnostakis, S. L. 1975. The use of solid media for detection of enzyme production by fungi. *Mycology*, vol. 67, no. 3, p. 597-607.

<https://doi.org/10.2307/3758395>

Janser, E. 1997. Enzymes applications for tropical fruits and citrus. *Fruit Processing*, vol. 10, p. 388-393.

Kawano, C. Y., Chellegatti, M. A. D. S. C., Said, S., Fonseca, M. J. V. 1999. Comparative study of intracellular and extra cellular pectinases produced by *Penicillium freuestan*. *Biotechnology and Applied Biochemistry*, vol. 29, p. 133-140.

[PMid:10075909](https://pubmed.ncbi.nlm.nih.gov/10075909/)

Lineweaver, H., Burk, D. 1934. The determination of enzyme dissociation constants. *Journal of the American Chemical Society*, vol. 56, no. 3, p. 658-666.

<https://doi.org/10.1021/ja01318a036>

Martin, N., Souza, S. R., Silva, R., Gomes, E. 2004. Pectinase production by fungal strains in solid state fermentation using agro-industrial bioproduct. *Brazilian Archives of Biology and Technology*, vol. 47, no. 5, p. 813-819.

<https://doi.org/10.1590/S1516-89132004000500018>

Miller, G. L. 1959. Use of dinitrosalicylic acid reagent for determination of reducing sugar. *Analytical Chemistry*, vol. 31, no. 3, p. 426-429.

<https://doi.org/10.1021/ac60147a030>

Mudgett, A. E. 1986. Solid state fermentations. pp. 66-83. In A. L. Demain and N. A. Solomon, eds. *Manual of Industrial Microbiology and Biotechnology*, American Society for Microbiology, Washington, D.C.

Piccoli-Valle, R. H., Passos, F. M. L., Passos, F. J. V., Silva, D. O. 2001. Production of pectin lyase by *Penicillium griseoforme* in bioreactors in the absence of inducer. *Brazilian Journal of Microbiology*, vol. 32, no. 2, p. 135-140.

<https://doi.org/10.1590/S1517-83822001000200013>

Phutela, U., Dhuna, V., Sandhu, S., Chadha, B. S. 2005. Pectinase and polygalacturonase production by a thermophilic *Aspergillus fumigatus* isolated from decomposing orange

peels. *Brazilian Journal of Microbiology*, vol. 36, no. 1, p. 63-69.

<https://doi.org/10.1590/S1517-83822005000100013>
Ramadan, M. F., Moersel, J. T. 2007. Impact of enzymatic treatment on chemical composition, physicochemical properties and radical scavenging activity of goldenberry (*Physalis peruviana* L.) juice. *Journal of the Science of Food and Agriculture*, vol. 87, no. 3, p. 452-460.

<https://doi.org/10.1002/jsfa.2728>
Riou, C., Freyssinet, G., Feure, M. 1992. Purification and characterization of extracellular pectinolytic enzymes produced by *Sclerotinia sclerotiorum*. *Applied and Environmental Microbiology*, vol. 58, no. 2, p. 578-583.

[PMid:16348646](https://pubmed.ncbi.nlm.nih.gov/16348646/)
Silva, D., Martins, E. S., Silva, R., Gomes, E. 2002. Pectinase production by *Penicillium viridicatum* RFC3 by solid state fermentation using agro-industrial by-products. *Brazilian Journal of Microbiology*, vol. 33, no. 4, p. 318-324.

<https://doi.org/10.1590/S1517-83822002000400008>

Acknowledgments:

The study was conducted with financial and logistic support from the project, "Small Scall Processing of Functional Fruit Juices by Applying Enzyme Technology" funded by CGP, Krishi Goveshona Foundation (KGF).

Contact address:

Taminur Islam Chowdhury, Department of Food Technology and Rural Industries, Bangladesh Agricultural University, Mymensingh-2202, Bangladesh. Email: tamin22@yahoo.com

Md. Fahad Jubayer, Department of Food Technology and Rural Industries, Bangladesh Agricultural University, Mymensingh-2202, Bangladesh. Email: fahadbau21@hotmail.com

Md. Burhan Uddin, Department of Food Technology and Rural Industries, Bangladesh Agricultural University, Mymensingh-2202, Bangladesh. Email: burhan992003@yahoo.com

Md. Gulzarul Aziz, Department of Food Technology and Rural Industries, Bangladesh Agricultural University, Mymensingh-2202, Bangladesh. Email: gulzar992003@yahoo.com

MICROBIOLOGICAL QUALITY OF FRESH AND HEAT TREATED COW'S MILK DURING STORAGE

Simona Kunová, Jozef Golian, Lucia Zeleňáková, Eubomír Lopašovský, Juraj Čuboň, Peter Haščík, Miroslava Kačániová

ABSTRACT

The aim of the present study was to evaluate the microbiological quality of raw milk from milk vending machine and heat treated milk during storage. There were analyzed 120 samples of milk (30 samples of fresh milk, 30 samples of raw milk stored 4 day at 4 °C, 30 samples of heat treated milk – 70 °C stored 4 day at 4 °C and 30 samples of heat treated milk – 100 °C stored 4 day at 4 °C). Total viable counts (TVC), coliform bacteria (CB) and microscopic filamentous fungi (MFF) were determined by microbiological analysis. Plate dilution method were used for microbiological analysis. The number of total viable counts (TVC) in fresh milk ranged from 4.08 log KTJ.mL⁻¹ to 4.89 CFU.mL⁻¹. TVC in raw milk after storage ranged from 5.31 log CFU.mL⁻¹ to 6.81 log CFU.mL⁻¹. TVC in heat treated milk with temperature 70 °C after storage ranged from 3.89 log CFU.mL⁻¹ to 4.45 log CFU.mL⁻¹ and TVC in heat treated milk with temperature 100 °C after storage ranged from 2.96 log KTJ.mL⁻¹ to 3.91 log KTJ.mL⁻¹ in heat treated milk with temperature 100 °C after storage. The number of CB were in range from 1.49 log CFU.mL⁻¹ to 1.89 log CFU.mL⁻¹ in fresh milk, from 1.99 log CFU.mL⁻¹ to 2.61 log CFU.mL⁻¹ in raw stored milk. Coliform bacteria were not present in heat-treated milk samples. The values of MFF ranged from 0 log CFU.mL⁻¹ to 2.01 log CFU.mL⁻¹ in fresh milk, from 1.43 log CFU.mL⁻¹ to 3.98 log CFU.mL⁻¹ in raw milk after storage, from 1.33 log CFU.mL⁻¹ to 3.41 log CFU.mL⁻¹ in heat treated milk with temperature 70 °C after storage and from 1.30 log CFU.mL⁻¹ to 3.32 log CFU.mL⁻¹ in heat treated milk with temperature 100 °C after storage.

Keywords: milk; total viable counts; coliform bacteria; microscopic filamentous fungi; heat treatment

INTRODUCTION

Milk and dairy products are important components of the diet worldwide. The quality and shelf life of liquid milk as well as dairy products are often compromised by flavor, odors, and visual defects arising from the bacterial growth and activities of heat-stable enzymes produced by psychrotrophic bacteria before processing (Techer et al., 2014).

Milk testing and quality control should be carried out at all stages of the dairy chain (Zajác et al., 2015).

The quality and safety of raw cow's milk is very important for dairy companies and consumers of milk products. Due to the methods of production, it is impossible to completely eliminate contamination of milk with microorganisms, therefore the microbial content of milk is a major feature in determining its quality (Zajác et al., 2012).

Milk is a nutritious food for humans but it is also an ideal growth medium for bacterial pathogens (Ruusunen et al., 2013). The consumption of raw milk is not well-documented, but in the context of the current trend toward "consuming natural", consumption of raw milk is

becoming more popular. However, due to its high nutritional value together with the neutral pH and high water activity, raw milk is good growth medium for different micro-organisms, whose multiplication depends mainly on temperature and on competing micro-organisms and their metabolic products. In order to guarantee its microbial safety and to prolong its shelf-life, milk is heat treated (Claeys et al., 2013).

In general, raw milk intended for human consumption must meet the requirements of the General Food Law (Regulation (EC) 178/2002) and be free of pathogens.

Raw milk can be a source of pathogenic bacteria. Bacteria can get into milk directly from cow breeding or in the non-hygienic handling of fresh raw milk. Consumption of untreated raw milk may pose a risk to humans. (Wouters et al., 2002). The use of hygienic milking procedures and hygienic storage are the most importance in reducing the levels of contamination of milk by microorganisms (Mhone et al., 2011).

The total viable counts in milk has a decisive effect on the quality and safety of dairy products (Sztejn et al., 2005). Milk contaminated by high levels of spoilage

bacteria usually becomes unsuitable for further processing since it does not meet the consumer's expectations in terms of health, safety and satisfaction (Nanu et al., 2007). The presence of total coliforms in food of animal origin shows to environmental sources of contamination since these micro-organisms are abundant in the environment (Shojaei and Yadollahi, 2008). *Escherichia coli* is the most common contaminant of raw and processed milk. It is a reliable indicator of faecal contamination of water and food (Todar, 2008). *E. coli* is a commensal micro-organism of the intestines of animals and humans but its presence in food may be of public health concern due to the possible presence of enteropathogenic and/or toxigenic strains (Soomro et al., 2002).

Fungi are eukaryotic, Gram positive, non-acid fast, heterophilic, non-photosynthetic, osmotrophic and saprobic microorganisms. Presently, over 250,000 fungi are present in our environment. The fungi are ubiquitous in distribution, and are found in the soil, water, and air (Pal, 2007). The fungi which include moulds and yeasts are responsible for the spoilage of milk and milk products (Pal and Jadhav, 2013).

The fungal contamination of dairy products can occur from environment, equipments, handlers and packaging materials. Among these fungi, *Aspergillus*, *Fusarium* and *Penicillium* are important as they produce mycotoxins which can cause serious health hazards. In order to detect the source of fungal contamination in milk products, molecular tools should be applied in the dairy enterprises. The application of hazard analysis control point (HACCP), good manufacturing practice (GMP), sanitation, and preservation of open milk products in refrigeration can avoid the contamination of the dairy products from fungi, and thereby, prevent the economic loss in dairy establishment (Pal, 2014).

Scientific hypothesis

The microbiological quality of the raw milk and heat treated milk during storage at temperature 4 °C was compared. It is prerequisite, that the raw milk contains undesirable microorganisms, so it can be dangerous for human consumption. The heat treatment to 70 °C during 5 minutes were used, because it's assumed, that most of bacteria are eliminated at this temperature and 100 °C during 5 seconds were used because many consumers boil raw milk before consumption.

MATERIAL AND METHODOLOGY

Microbiological quality of raw milk from milk vending machine and heat treated milk was evaluated in this study. There were analyzed 120 samples of milk (30 samples of fresh milk, 30 samples of raw milk stored 4 day at 4 °C, 30 samples of heat treated milk – 70 °C stored 4 day at 4 °C and 30 samples of heat treated milk – 100 °C stored 4 day at 4 °C. The heat treated milk samples were heated in water bath to 70 °C during 30 seconds and to 100 °C during 10 seconds. Total viable counts (TVC), coliform bacteria (CB) and microscopic filamentous fungi (MFF) were examined. Plate dilution method was used for quantitative cfu counts of groups of microorganisms in 1 ml of milk. Gelatinous nutritive substrate in petri dishes was inoculated with 1 ml of milk samples by flushing and

on surface in three replications. Basic dilutions (10^{-1}) was obtained by mixing 5 g of the sample (cheese) and 45 ml of physiological solution (0.85% NaCl). Plate Count Agar (PCA, Oxoid, UK) was used for determine of TVC in samples. Dilutions of 10^{-3} and 10^{-4} were used to determine of TVC. Petri dishes were cultivated upside-down in a thermostat at 30 °C for 48 – 72 hours (STN EN ISO 4833).

Violet red bile agar (VRBA, Oxoid, UK) was used for determine of CB in samples. Dilutions of 10^{-1} and 10^{-2} were used to determine of CB. Petri dishes were cultivated upside-down in a thermostat at 37 °C for 24 – 48 hours (STN EN ISO 4832). Dichloran Rose-Bengal Chloramphenicol (DRBC, Oxoid, UK). Agar was used for determine of MFF. Dilutions of 10^{-1} and 10^{-2} were used to determine of MFF. Petri dishes were cultivated upside-down in a thermostat at 25 °C for 5 – 7 days (STN ISO 7954). The heat treatment of milk and preparing of milk samples were performed in accordance with ISO 6887-5.

Calculation of microorganisms

The number of microorganisms in 1 g samples (N) were calculated using the following formula:

$$N = \Sigma C / [(n_1 + 0.1n_2) \times d]$$

ΣC – sum of characteristic colonies on selected plates,
 n_1 – number of dishes from 1. dilutions used to calculate,
 n_2 – number of dishes from 2. dilutions used to calculate,
 d – dilution factor identical with 1. used dilution.

Statistic analysis

Mathematical and statistical analyzes are processed in the tables. Arithmetic mean, standard deviation, coefficient of variation (%) were performed using Excel. Statistically significant differences by paired t-test between tested parameters were performed in program Tanagra v 1.4.50.

RESULTS AND DISCUSSION

The sale of raw milk in large amounts directly to consumers through vending machines or via other means has increased in recent years in many countries (Bianchi et al., 2013). Studies have shown, that many consumers prefer raw milk due to better taste and believe in better nutritional value and several health benefits compared to heat treated milk (Claeys et al., 2013).

In Europe, the current regulatory microbial criteria for raw cow milk are $\leq 100\,000$ CFU.mL⁻¹ (5 log CFU.mL⁻¹) for total viable counts (at 30 °C) (Regulation (EC) 853/2004).

The average values of TVC in milk samples are shown in the Table 1. The number of TVC ranged from 4.08 CFU.mL⁻¹ to 4.89 CFU.mL⁻¹ in fresh milk, from 5.31 log CFU.mL⁻¹ to 6.81 log CFU.mL⁻¹ in raw milk after storage, from 3.89 log CFU.mL⁻¹ to 4.45 log CFU.mL⁻¹ in heat treated milk with temperature 70 °C after storage and from 2.96 log CFU.mL⁻¹ to 3.91 log CFU.mL⁻¹ in heat treated milk with temperature 100 °C after storage (Figure 1). The TVC in samples of fresh milk were in accordance with Regulation (EC) 853/2004. The values of TVC were significantly higher ($p < 0.001$) in samples of raw stored

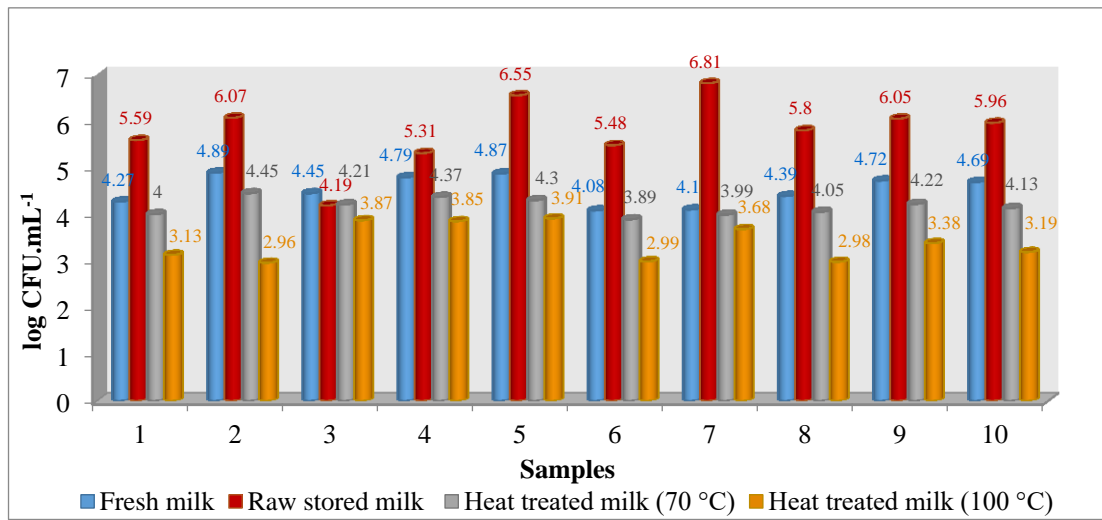

Figure 1 Total viable counts values in milk.

Table 1 Basic statistical characteristics of TVC in milk.

	n	x	s	min	max	V%
Fresh milk	10	4.53	0.29	4.08	4.89	6.40
Raw stored milk	10	5.98	0.44	5.31	6.81	7.36
Heat treated milk (70 °C)	10	4.16	0.17	3.89	4.45	4.09
Heat treated milk (100 °C)	10	3.39	0.38	2.96	3.91	11.21

n – number of samples, x – average, s – standard deviation, v% – coefficient of variation.

milk in comparison with fresh milk and heat treated milk. Lan et al. (2017) analyzed 160 raw milk samples, the TVC varied from 3.15 to 6.61 log CFU.mL⁻¹, with the average of 5.10 log CFU.mL⁻¹. Kalmus et al. (2015) examined raw milk from 14 dairy farms for TVC. The total bacterial counts exceeded 100 000 CFU.mL⁻¹ in three (21.4%) bulk milk samples and in 10 samples (71.4%) collected at the retail level.

In the study of Victoris et al (2016) the bacteriological quality of raw cow's milk sold in vending machines was evaluated. They found that 64 out of 70 samples (91%) of

raw cow's milk from the milk vending machines coincided with the criterion of maximum value of TBC 100 000 CFU.mL⁻¹ (5.00 log₁₀ CFU.mL⁻¹) according the European Commission Regulation No. 1662/2006. They have found the average value of total bacterial count in bulk tank raw cow's milk samples 4.61 log₁₀ CFU.mL⁻¹ and average value of total bacterial count in vending machine raw cow's milk samples 4.76 log₁₀ CFU.mL⁻¹.

The risk caused by consumption of raw milk is reduced and even eliminated by a heat treatment. Based on the temperature and time applied, different heat treatments can be used, such as thermization, pasteurization and

Table 2 Basic statistical characteristics of CB in milk.

	n	x	s	min	max	V%
Fresh milk	10	1.67	0.14	1.49	1.89	8.38
Raw stored milk	10	2.32	0.19	1.99	2.61	8.19
Heat treated milk (70 °C)	10	0	0	0	0	0
Heat treated milk (100 °C)	10	0	0	0	0	0

n – number of samples, x – average, s – standard deviation, v% – coefficient of variation.

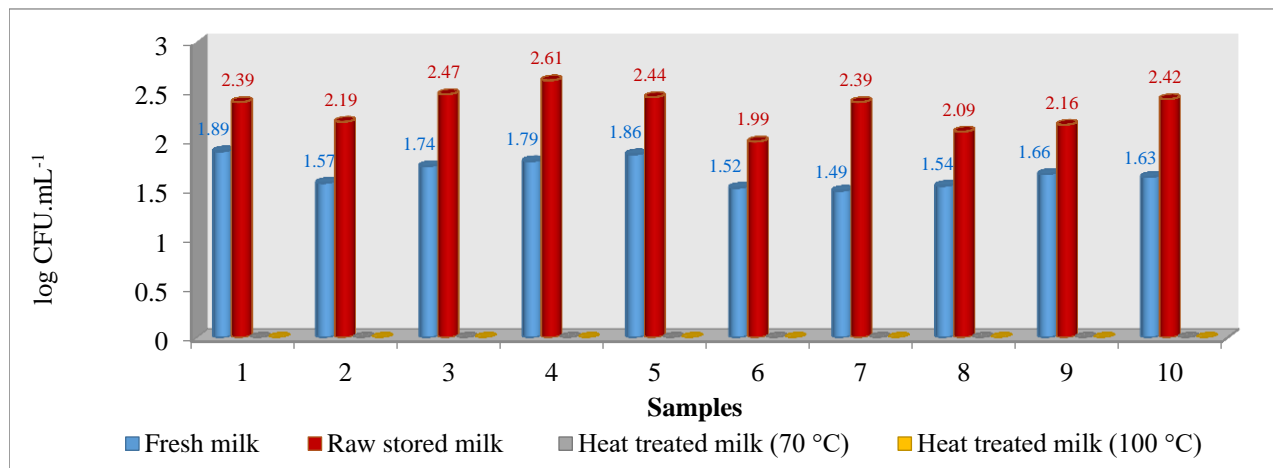

Figure 2 Values of coliform bacteria in milk.

Table 3 Basic statistical characteristics of MFF in milk.

	n	x	s	min	max	V%
Fresh milk	10	1.26	0.85	0	2.01	67.46
Raw stored milk	10	2.78	0.73	1.43	3.98	26.26
Heat treated milk (70 °C)	10	2.50	0.62	1.33	3.41	24.80
Heat treated milk (100 °C)	10	2.38	0.63	1.30	3.32	26.47

n – number of samples, x – average, s – standard deviation, v% – coefficient of variation.

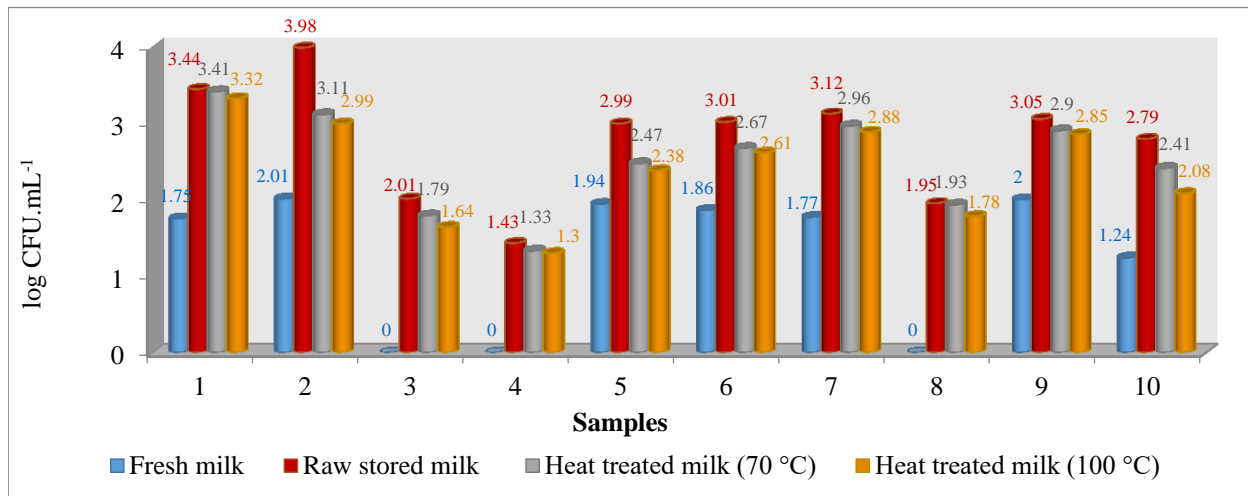

Figure 3 Values of microscopic filamentous fungi in milk.

sterilization, including UHT (ultra high temperature) and ISI (innovative steam injection) treatment, aimed at different microbial targets and resulting in a different shelf-life of the milk (Claeys et al., 2013).

In the study of Tremonte et al. (2014), the microbiological quality of 30 raw milk samples from 3 vending machines were examined. Milk samples were stored for 72 h at 4 °C and then subjected to different treatments, such as boiling and microwaving, to simulate domestic handling. The results show that all the raw milk samples examined immediately after their collection were affected by high microbial loads, with values very close to or even greater than those acceptable by European legislation. The microbial populations increased during refrigeration, reaching after 72 h values of about 8.0 log CFU.mL⁻¹ for *Pseudomonas* spp., 6.5 log CFU.mL⁻¹ for yeasts, and up to 4.0 log CFU.mL⁻¹ for *Enterobacteriaceae*. Boiling treatment, applied after 72 h to refrigerated milk samples, caused complete decontamination, but negatively affected the nutritional quality of the milk, as demonstrated by a drastic reduction of whey proteins.

The average values of CB in milk samples are shown in the Table 2. The number of CB were in range from 1.49 log CFU.mL⁻¹ to 1.89 log CFU.mL⁻¹ in fresh milk, from 1.99 log CFU.mL⁻¹ to 2.61 log CFU.mL⁻¹ in raw stored milk. Coliform bacteria were not present in heat-treated milk samples (Figure 2). The values of CB were significantly lower ($p < 0.001$) in samples of fresh milk and heat treated milk in comparison with raw stored milk.

The prevalence and high level of *E. coli* in food of animal origin implies environmental and fecal contamination (Mhone et al., 2011). Other authors have reported that some herd management practices were associated with *E. coli* contamination, such as milking machine, milking parlor type, and milking hygiene (Piepers et al., 2014). Many microorganisms can get access to milk and products, among these are *E. coli*. Coliforms and *E. coli* are often

used as marker organisms. *E. coli* is used as reliable indicator of fecal contamination and indicates a possible presence of enteropathogenic and/or toxigenic microorganisms which mean a public health hazard. *E. coli* is one of the main inhabitants of the intestinal tract of most mammalian species. Most *E. coli* are harmless, but some are known to be pathogenic bacteria, causing severe intestinal and extraintestinal diseases in man (Kaper et al., 2004).

Altalhi and Hassan (2009) analyzed 50 samples of milk from different sources for presence of coliform bacteria, 40 samples (80%) were contaminated by coliform bacteria, seven samples (17.5%) with non-faecal coliform bacteria, and 10 (20%) were with no growth. In the study of Hill et al. (2012) the presence of *Escherichia coli* in raw milk was examined, 99% of samples tested for *E. coli* had counts $< 10^2$ CFU.mL⁻¹ and only 0.7% were $> 10^3$ CFU.mL⁻¹.

Microscopic filamentous fungi usually present in raw milk do not survive pasteurization. Their presence in pasteurized milk and other milk products is caused by reinfection during manufacturing (Jodral et al., 1993).

The moulds have little practical importance in raw milk, but they are important in pasteurized milk, especially when it is used for the manufacture of cheese and other dairy products (Wouters et al., 2002).

The average values of MFF in milk samples are shown in the Table 3.

The values of MFF ranged from 0 log CFU.mL⁻¹ to 2.01 log CFU.mL⁻¹ in fresh milk, from 1.43 log CFU.mL⁻¹ to 3.98 log CFU.mL⁻¹ in raw milk after storage, from 1.33 log CFU.mL⁻¹ to 3.41 log CFU.mL⁻¹ in heat treated milk with temperature 70 °C after storage and from 1.30 log CFU.mL⁻¹ to 3.32 log CFU.mL⁻¹ in heat treated milk with temperature 100 °C after storage (Figure 3). The values of MFF were significantly lower ($p < 0.001$) in samples of fresh milk in comparison with raw stored milk and heat treated milk.

Torkar and Vengušt (2008) analyzed 60 samples of raw milk for the presence of moulds and yeasts, the yeasts were present in 95.0% of raw milk samples with the mean concentration of 1.7 log CFU.mL⁻¹. Moulds were found in 63.3% of raw milk samples with mean concentration 0.6 log CFU.mL⁻¹.

CONCLUSION

The microbiology quality of raw and processed milk after storage were evaluated. The results of the present study show that all samples of fresh milk meet the requirements of legislation for number of TVC. However, all samples of raw milk stored for 4 days at 4 °C exceeded the limit for TVC, so raw milk is not suitable for consumption. Milk at direct milk sale points must be stored at 2.5 °C to 4 °C and it must be heat treated, which eliminates the possibility of intensive bacterial growth. Educating of farmers about general hygiene practices, can improve the microbiological quality of milk. It is also very important to ensure of high level of hygiene at the obtaining, processing and storage of raw cow's milk.

REFERENCES

Altalhi, A. D., Hassan, S. A. 2009. Bacterial quality of raw milk investigated by *Escherichia coli* and isolated analysis for specific virulence gene markers. *Food Control*, vol. 20, no. 10, p. 913-917. <https://doi.org/10.1016/j.foodcont.2009.01.005>

Bianchi, D. M., Barbaro, A., Gallina, S., Vitale, N., Chiavacci, L., Caramelli, M., Decastelli, L. 2013. Monitoring of foodborne pathogenic bacteria in vending machine raw milk in Piedmont, Italy. *Food Control*, vol. 32, no. 2, p. 435-439. <https://doi.org/10.1016/j.foodcont.2013.01.004>

Claeys, W. L., Cardoen, S., Daube, G., De Block, J., Dewettinck, K., Dierick, K., De Zutter, L., Huyghebaert, A., Imberechts, H., Thiange, P., Vandenplas, Y., Herman, L. 2013. Raw or heated cow milk consumption: review of risks and benefits. *Food Control*, vol. 31, no. 1, p. 251-262. <https://doi.org/10.1016/j.foodcont.2012.09.035>

Hill, B., Smythe, B., Lindsay, D., Shepherd, J. 2012. Microbiology of raw milk in New Zealand. *International Journal of Food Microbiology*, vol. 157, no. 2, p. 305-308. <https://doi.org/10.1016/j.ijfoodmicro.2012.03.031> PMID:22663980

Jodral, M., Liñan, E., Acosta, I., Gallego, C., Rojas, F., Bentabol, A. 1993. Mycoflora and toxigenic *Aspergillus flavus* in Spanish milk. *International Journal of Food Microbiology*, vol. 18, no. 2, p. 171-174. [https://doi.org/10.1016/0168-1605\(93\)90222-3](https://doi.org/10.1016/0168-1605(93)90222-3)

Kalmus, P., Kramarenko, T., Roasto, M., Meremäe, K., Viltrop, A. 2015. Quality of raw milk intended for direct consumption in Estonia. *Food Control*, vol. 51, p. 135-139. <https://doi.org/10.1016/j.foodcont.2014.11.018>

Kaper, J. B., Nataro, J. P., Mobley, H. L. T. 2004. Pathogenic *Escherichia coli*. *Nature Reviews Microbiology*, vol.2, no. 2, p. 123-140. <https://doi.org/10.1038/nrmicro818> PMID:15040260

Lan, X. Y., Zhao, S. G., Zheng, N., Li, S. L., Zhang, Y. D., Liu, H. M., McKillip, J., Wang, J. Q. 2017. *Short communication*: Microbiological quality of raw cow milk and its association with herd management practices in Northern China. *Journal of Dairy Science*, vol. 100, no. 6, p. 4294-4299. <https://doi.org/10.3168/jds.2016-11631> PMID:28434737

Mhone, T. A., Matope, G., Saidi, P. T. 2011. Aerobic bacterial, coliform, *Escherichia coli* and *Staphylococcus aureus* counts of raw and processed milk from selected smallholder dairy farms of Zimbabwe. *International Journal of Food Microbiology*, vol. 151, no. 2, p. 223-228. <https://doi.org/10.1016/j.ijfoodmicro.2011.08.028> PMID:21944662

Nanu, E., Latha, C., Sunil, B., Prejit, T. M., Menon, K. V. 2007. Quality assurance and public health safety of raw milk at the production point. *American Journal of Food Technology*, vol. 2, no. 3, p. 145-152. <https://doi.org/10.3923/ajft.2007.145.152>

Pal, M. 2007. *Veterinary and Medical Mycology*. 1st ed. New Delhi, India : Indian Council of Agricultural Research, p. 401. ISBN 8171640710.

Pal, M. 2014. Spoilage of Dairy Products due to Fungi. *Beverage and food world*, vol. 41, no. 7, p. 37-40.

Pal, M., Jadhav, V. J. 2013. Microbial contamination of various India milk products. *Beverage and Food World*, vol. 40, no. 12, p. 43-44.

Piepers, S., Zrimsek, P., Passchyn, P., De Vliegheer, S. 2014. Manageable risk factors associated with bacterial and coliform counts in unpasteurized bulk milk in Flemish dairy herds. *Journal of Dairy Science*, vol. 97, no. 6, p. 3409-3419. <https://doi.org/10.3168/jds.2013-7203> PMID:24704236

Ruusunen, M., Salonen, M., Pulkkinen, H., Huuskonen, M., Hellstrom, S., Revez, J., Hanninen, M. L., Fredriksson-Ahomaa, M., Lindstrom, M. 2013. Pathogenic bacteria in Finnish bulk tank milk. *Foodborne Pathogens and Disease*, vol. 10, no. 2, p. 99-106. <https://doi.org/10.1089/fpd.2012.1284> PMID:23373473

Regulation (EC) 853/2004 of the European Parliament and of the Council of 29 April 2004 laying down specific hygiene rules for on the hygiene of foodstuffs. Official Journal of the European Union, L139, p. 55.

Regulation (EC) 178/2002 of the European Parliament and of the Council of 28 January 2002 laying down the general principles and requirements of food law, establishing the European Food Safety Authority and laying down procedures in matters of food safety. Official Journal of the European Communities, L31, p. 1-24.

Shojaei, Z. A., Yadollahi, A. 2008. Physicochemical and microbiological quality of raw, pasteurised and UHT milk in shops. *Asian Journal of Scientific Research*, vol. 1, no. 5, p. 532-538. <https://doi.org/10.3923/ajsr.2008.532.538>

Soomro, A. H., Arain, M. A., Khaskheli, M., Bhutto, B. 2002. Isolation of *Escherichia coli* from raw and processed milk in relation to public health sold under market conditions at Tandojam. *Pakistan Journal of Nutrition*, vol. 1, no. 3, p. 151-152. <https://doi.org/10.3923/pjn.2002.151.152>

Sztejn, J., Wiszniewska, A., Fus-Szewczyk, M. M., Cichosz, W. 2005. Changes in microbiological quality of raw milk from the Region of Warmia and Mazury in 1998 – 2003. *Veterinarija ir Zootechnika. T.*, vol. 32, no. 54.

Techer, C., Baron, F., Jan, S. 2014. Spoilage of animal products/Microbial Milk Spoilage. In Batt, C. A. *Encyclopedia of Food Microbiology*. Amsterdam, Netherlands : Elsevier, Academic press, p. 446-452. ISBN: 978-0-12-384733-1.

Todar, K. 2008. Pathogenic *E. coli*. [online] s.a. [cit. 2017-09-12] Available at: <http://www.textbookofbacteriology.net/e.coli.html>

Torkar, K. G., Vengušt, A. 2008. The presence of yeasts, moulds and aflatoxin M₁ in raw milk and cheese in Slovenia.

Food Control, vol. 19, no. 6, p. 570-577.

<https://doi.org/10.1016/j.foodcont.2007.06.008>

Tremonte, P., Tipaldi, L., Succi, M., Pannella, G., Falasca, L., Capilongo, V., Coppola, R., Sorrentino, E. 2014. Raw milk from vending machines: Effects of boiling, microwave treatment, and refrigeration on microbiological quality. *Journal of Dairy science*, vol. 97, no. 6, p. 3314-3320.

<https://doi.org/10.3168/jds.2013-7744>

PMid:24704234

Vietoris, V., Zajác, P., Zubrická, S., Čapla, J., Čurlej, J. 2016. Comparison of total bacterial count (TBC) in bulk tank raw cow's milk and vending machine milk. *Carpatian Journal of Food Science and Technology*, vol. 8, no. 1, p. 184-191.

Wouters, J. T. M., Ayad, E. H. E., Hugenholtz, J., Smit, G. 2002. Microbes from raw milk for fermented dairy products. *International Dairy Journal*, vol. 12, no. 2-3, p. 91-109.

[https://doi.org/10.1016/S0958-6946\(01\)00151-0](https://doi.org/10.1016/S0958-6946(01)00151-0)

Zajác, P., Tomáška, M., Murárová, A., Čapla, J., Čurlej, J. 2012. Quality and safety of raw cow's milk in Slovakia in 2011. *Potravinarstvo*, vol. 6, no. 2, p. 64-73.

<https://doi.org/10.5219/189>

Zajác, P., Čapla, J., Vietoris, V., Zubrická, S., Čurlej, J. 2015. Effects of storage on the major constituents of raw milk. *Potravinarstvo*, vol. 9, no. 1, p. 375-381.

<https://doi.org/10.5219/518>

Contact address:

Simona Kunová, Slovak University of Agriculture, Faculty of Biotechnology and Food Sciences, Department

of Food Hygiene and Safety, Tr. A. Hlinku 2, 949 76 Nitra, Slovakia, E-mail: simona.kunova@uniag.sk

Jozef Golian, Slovak University of Agriculture, Faculty of Biotechnology and Food Sciences, Department of Food Hygiene and Safety, Tr. A. Hlinku 2, 949 76 Nitra, Slovakia, E-mail: jozef.golian@uniag.sk

Lucia Zeleňáková, Slovak University of Agriculture, Faculty of Biotechnology and Food Sciences, Department of Food Hygiene and Safety, Tr. A. Hlinku 2, 949 76 Nitra, Slovakia, E-mail: lucia.zelenakova@uniag.sk

Lubomír Lopašovský, Slovak University of Agriculture, Faculty of Biotechnology and Food Sciences, Department of Food Hygiene and Safety, Tr. A. Hlinku 2, 949 76 Nitra, Slovakia, E-mail: lubomir.lopasovsky@uniag.sk

Juraj Čuboň, Slovak University of Agriculture, Faculty of Biotechnology and Food Sciences, Department of Evaluation and Processing of Animal Products, Tr. A. Hlinku 2, 949 76 Nitra, Slovakia, E-mail: juraj.cubon@uniag.sk

Peter Haščík, Slovak University of Agriculture, Faculty of Biotechnology and Food Sciences, Department of Evaluation and Processing of Animal Products, Tr. A. Hlinku 2, 949 76 Nitra, Slovakia, E-mail: peter.hascik@uniag.sk

Miroslava Kačániová, Slovak University of Agriculture, Faculty of Biotechnology and Food Sciences, Department of Microbiology, Tr. A. Hlinku 2, 949 76 Nitra, Slovakia, E-mail: miroslava.kacaniova@gmail.com



ANTIOXIDANT, ANTIMICROBIAL ACTIVITY AND MINERAL COMPOSITION OF LOW-TEMPERATURE FRACTIONING PRODUCTS OF *MALUS DOMESTICA BORKH* (COMMON ANTONOVKA)

Elena Kuznetsova, Alexander Emelyanov, Elena Klimova, Tatyana Bychkova, Andrey Vinokurov, Natalia Selifonova, Vladislav Zomitev, Jan Brindza

ABSTRACT

The low-temperature fractionation of fruit *Malus domestica Borkh* (Common Antonovka) has been performed. We obtained by fractionation the biologically active products that are the dehydrated concentrate of juice and the powder of pomace fibers. Use of low temperature minimizes biological value losses during processing. These fractions of fruit *Malus domestica Borkh* (Common Antonovka) are experimentally studied. It is found that the fractions have high antioxidant activity and include bioflavonoids and organic and phenol carboxylic acids. Analysis of chromatograms showed availability of the identical compounds in the products of low-temperature fractionation. Sodium and potassium are part of the cells of biological systems as highly mobile ionic forms. Therefore, these elements prevail in the concentrated juice. Iron, manganese, copper, and zinc are biogenic trace elements or components of enzyme systems and are evenly distributed as in plant cell walls as well in protoplasm. It follows from the results of the study of the mineral composition that the products of the low-temperature fractionation can be used for a functional food as a result of its high content of magnesium and iron. The low-temperature fractionation of fruit *Malus domestica Borkh* (Common Antonovka) has antimicrobial activity against the standard strains of spoilage: *Bacillus subtilis* VKM-B-501, *Micrococcus luteus* VKM-As-2230, *Aspergillus flavus* VKM-F-1024, *Penicillium expansion* VKM-F-275, *Mucor mucedo* VKM-F-1257, *Rhizopus stolonifer* VKM-F-2005. Experimental data show that the products of low-temperature fractionation of *Malus domestica Borkh* (Common Antonovka) inhibit microorganism's growth. The detected composition of *Malus domestica Borkh* (Common Antonovka) fractions allows using these products as natural additives in food technology to maintain and increase period of storage and also for preventive nutrition.

Keywords: concentrated juice; pomace powder; *Malus domestica Borkh*. Common Antonovka fruit; antioxidant activity; bioflavonoids

INTRODUCTION

The synthetic food additives used in food technologies are suspected of toxicity and general public increases pressure on the food manufacturers with the view of application natural alternatives for maintaining or extending lifetime of products (Seneviratne and Kotuwegedara, 2009).

Products of oxidation can lead to a deterioration of qualities and even endanger the food safety (McClements and Decker, 2006), so the choice of natural sources that have an antioxidant effect, shall guarantee safety of food additives.

Numerous plants contain biologically active compounds that can be considered as a good alternative to synthetic antioxidant food additives (Nakatani, 2000; Yanishlieva et al., 2006). Antioxidant properties of biologically active

compounds, mainly determined by their redox activity, allow to chelate heavy metals and to bind active oxygen (Krishnaiah et al., 2011; Suja et al., 2016). Antioxidant activity into plant tissue is associated with presence of natural compounds, in particular bioflavonoids, hydroxyl acids, C and E vitamins, β -carotene and selenium. Antioxidants are used as compounds that can effectively interact with free radical, which determine biological membrane lipids oxidation protecting human body from diseases (Rice-Evans, 1996; Van Acker, 1996; Du et al., 2016; Brzóska et al., 2016).

Concentrated juices have high antioxidant potential to combat oxidative processes. They are also a source of calcium (Chambi et al., 2016).

Apple pomace is rich in polyphenols, which are used as food additives due to their strong antioxidant and

antimicrobial properties (Vineetha et al., 2014; Zhang et al., 2016). Polyphenols of apple pomace are presented by chlorogenic acid, coffee acid, syringin, epicatechin, cinnamic acid, kumarinovy acid, and quercetin. Determination of antioxidant activity showed that the extracts have a strong antioxidant activity DPPH radical to 90.96% ±10.23% (Bai et al., 2013; Francini et al., 2017). The high antioxidant activity of apple pomace and juice is determined (Maragò et al., 2015). It is established that the pomace and biowaste generated in the process of industrial processing apples, possess both antioxidant and geroprotector activity. Markers of liver damage alanine aminotransferase, aspartate aminotransferase and alkaline phosphatase were reduced in the serum of the monkeys, which used the apple pomace and biowaste. (Vineetha et al., 2014; Sharma et al., 2016).

Thermal processing is usually considered as a degrading factor for biologically active compounds because most of them are unstable during heating. In this connection, processed fruits are deemed to have much lower nutritional value and antioxidant activity than fresh (Zhang and Hamauzu, 1995; Turkmen et al, 2005; Silva et al., 2015). Low-temperature fractioning of plants can be a possible alternative for food technology (Emel'yanov, 2009). The fractioning leads to obtain biologically active products, which are the dehydrated juice and the dietary fiber. The result of pressing pulp is the juice containing main soluble solids and pomace mainly consisting of dietary fiber. The juice of direct extraction is evaporated under vacuum to produce a concentrated juice. Next, the concentrate and the pomace are dried in the convection oven at temperature up to 50 °C until the moisture that provides long shelf life under normal conditions at room temperature. Usage of low temperature minimizes loss of biological value during processing. As a result, the dehydrated fractions are biologically active one and can be used for manufacturing of functional purpose products (Emel'yanov and Emel'yanov, 2009).

To obtain biologically active food additives and investigate their antioxidant and antimicrobial activity and mineral composition, we carried out the low-temperature fractioning of *Malus domestica Borkh* (Common Antonovka) fruits.

MATERIAL AND METHODOLOGY

Samples of *Malus domestica Borkh* (Common Antonovka) fruits were selected in Orel district, Orel Region of the Russian Federation in 2010 – 2012.

Preliminarily prepared raw materials, which are *Malus domestica Borkh* (Common Antonovka) fruits, are

physically separated into juice of direct extraction and pomace of pulp. We evaporated juice under vacuum at temperature $t = 30 - 50$ °C to obtain a concentrate. Input power and speed of moisture removal, normalized to mass unit of evaporated fluid, respectively, accounted for $N/G_0 \approx 270$ W/kg and 60% h⁻¹ (Emel'yanov, 2009). The concentrate and pulp pomace are dried at atmospheric pressure and temperatures up to 50 °C to obtain dehydrated juice and dried pomace. After evaporation under vacuum, the concentrate took a paste form. As a result of convective drying concentrate, we have risen viscosity to a value that allows extruding product. We dried the granular juice and finally pulverized it to powder. Figure 1 presents photos of products of the low-temperature fractionation of *Malus domestica Borkh* (Common Antonovka) fruits.

To study the antimicrobial activity of products of the low-temperature fractioning of *Malus domestica Borkh* (Common Antonovka) fruits, we used the strains of microorganisms *Bacillus subtilis* VKM B – 501, *Micrococcus luteus* VKM - As – 2230, *Aspergillus flavus* VKM F – 1024, *Penicillium expansion* BKM-F-275, *Mucor mucedo* BKM-F-1257, and *Rhizopus stolonifer* BKM-F-2005. The sensitivity of test cultures to the action of the pomace powder and the juice concentrate is studied with assistance of diffusion in agar using wells in agar medium. Test organisms served as 18-20 hour cultures of microorganisms grown on stubble MPA. Suspension of microbes was added at the rate of 10⁶ microbial bodies per 1 cm³ of the nutrient medium. We used agarine dense nutrient medium, which are MPA (for spore-forming bacteria and micrococci) and wort-agar (for fungi), as a nutrient media.

Antioxidant activity of processing products of *Malus domestica Borkh* (Common Antonovka) fruits is determined by spectrophotometric method in an alcoholic extract described in (Silva et al., 2005) based on percentage of inhibition of DPPH radical (2,2-diphenyl-1-picrylhydrazyl). We determined the optical density of solutions in the interaction DFGP with extractive substances of plants by spectrophotometer "Specord M40" at a wavelength of 515 nm.

Bioflavonoids amount is determined by spectrophotometer analysis of complexes with aluminum chloride. Rutin (Lobanov et al., 2004) served as a standard.

Determination of trace is performed after dry digestion in a muffle furnace at 450 °C and dissolving the ash in the mixture of 10% hydrochloric acid and nitric acid by atomic absorption spectrophotometry and the air-acetylene



Figure 1 Concentrated juice from apple pulp as a plate form and pulp pomace powder.

flame device firm HITACHI 180-80 with deuterium background corrector. We used standard solutions of elements of the company «Merk» for calibration. Determination of the qualitative composition of extracts is performed by HPLC method on Milichrom UV-5 device equipped with a computer processing system "Multichrom". Reversed-phase HPLC, chromatographic column Separon C-18.5, eluent - acetonitrile solution in an aqueous buffer at pH 3 – 7 with a volume ratio 0.02 and KH₂PO₄: acetonitrile solution – 85:15 were used for analysis. The detection is performed at wavelengths of 252 nm.

RESULTS AND DISCUSSION

It is known that fresh apples have high antioxidant and anticancer activity (Eberhard et al., 2000). It is found that the exact combination of biochemical substances in apple fruits is responsible for health benefits. Consumption of apples can play a significant role in reducing the risk of chronic diseases such as cancer. The main and most active natural antioxidants have a phenolic nature. This is about natural polyphenols, different types of flavonoids, phenolic hydroxyl acids, and vitamins. Table 1 shows the results of determination of antioxidant activity and total amount of bioflavonoids in extracts of processed products made of *Malus domestica Borkh* (Common Antonovka) fruits.

These data suggest that the processed products obtained

from *Malus domestica Borkh* (Common Antonovka) fruits, which are the pomace powder and the juice concentrate, have a great value for food processing industry as a result of high antioxidant activity. The pomace powder has elevated bioflavonoids content, since this group of compounds is more abundant in the cell walls of plants. However, the concentrated juice can be used as additive in food technologies due to high percentage of DPPH inhibition. Sodium and potassium are presented by highly mobile ionic forms in the cells of biological systems. Therefore, these elements prevail in the concentrated juice. Iron, manganese, copper, and zinc that are biogenic trace elements or components of enzyme systems are evenly distributed in plant cell walls and protoplasm. Investigation of the mineral composition of the low-temperature fractioning products showed that they can be used for a functional food due to high content of magnesium and iron. The chromatographic analysis of the pomace powder and the concentrated juice extracts is performed.

To determine qualitative composition of processed products obtained from *Malus domestica Borkh* (Common Antonovka) fruits, we analyzed the differences between three groups of biologically active substances, which are organic acids, phenol carbonic acids, and flavonoids. Groups of biologically active agents are identified by their

Table 1 Antioxidant activity and content of bioflavonoids in the extracts of processed products made of *Malus domestica Borkh* (Common Antonovka) fruits.

Parameter	Pomace powder	Concentrated juice
% of DPPH inhibition	71.45 ±0.25	57.31 ±0.20
Bioflavonoids sum, %	2.19 ±0.05	1.24 ±0.08
Mineral elements content, mg.100g⁻¹		
potassium	132.00 ±8.00	178.00 ±3.00
calcium	17.00 ±0.45	12.00 ±0.35
magnesium	114.00 ±3.00	67.00 ±2.00
sodium	11.00 ±0.30	19.00 ±0.20
phosphorus	13.00 ±0.10	7.00 ±0.05
ferrum	2.00 ±0.02	3.50 ±0.02
manganese	0.49 ±0.01	0.68 ±0.01
cuprum	0.14 ±0.01	0.30 ±0.01
zinc	0.24 ±0.01	0.35 ±0.01

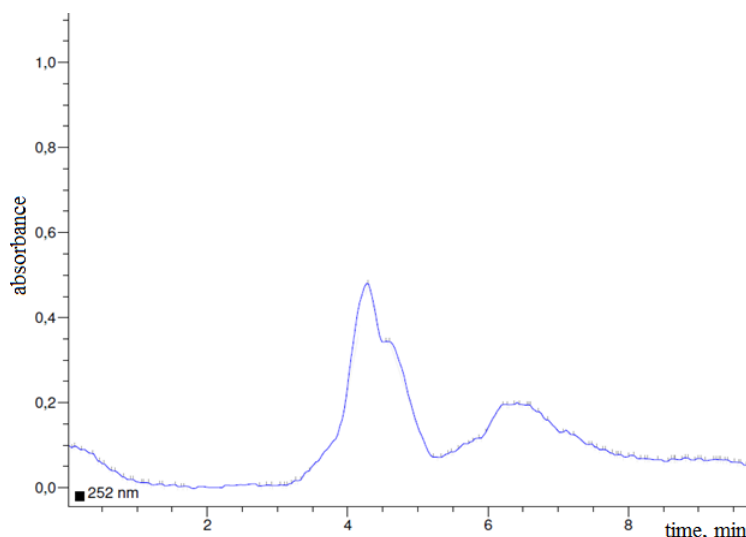

Figure 2 Chromatogram of the pomace powder of *Malus domestica Borkh* (Common Antonovka) fruits.

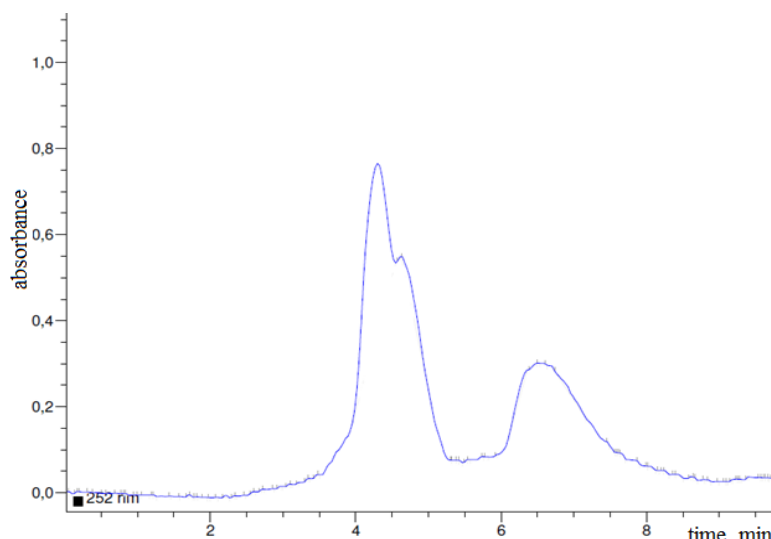

Figure 3 Chromatogram of the concentrated juice extract of *Malus domestica Borkh* (Common Antonovka) fruits.

Table 2 Antimicrobial activity of the products of the low-temperature fractioning of *Malus domestica Borkh* (Common Antonovka) fruits.

The type of microorganism	The diameters of zones of inhibition of growth of test cultures of microorganisms mm
<i>Bacillus subtilis</i> BKM-B-501	11.7 ±0.6
<i>Micrococcus luteus</i> BKM-As-2230	5.8 ±0.6
<i>Aspergillus flavus</i> BKM-F-1024	14.1 ±0.6
<i>Penicillium expansion</i> BKM-F-275	11.6 ±0.6
<i>Mucor mucedo</i> BKM-F-1257	9.8 ±0.6
<i>Rhizopus stolonifer</i> BKM- F-2005	8.2 ±0.6

retention time on the chromatograms presented in the form of peaks. The retention times from 2 to 5 minutes correspond to organic and phenol carbonic acids. The times from 5 to 8 minutes correspond to bioflavonoids.

Figures 2 and 3 show the chromatograms of the pomace powder and the concentrated juice extract obtained from *Malus domestica Borkh* (Common Antonovka) fruits. The chromatograms confirm the results of content determination of organic acids and bioflavonoids. Analysis of chromatograms shows the contents identical compounds in the products of the low-temperature fractionation. Both processed products contain organic and phenol carbonic acids in its composition. The compounds that are experimentally discovered have antiseptic and antioxidant activity.

The results of the antimicrobial activity study of the products obtained from *Malus domestica Borkh* (Common Antonovka) fruits with respect to the test cultures of microorganisms *Bacillus subtilis* VKM-B-501, *Micrococcus luteus* VKM-As-2230, *Aspergillus flavus* VKM-F-1024, *Penicillium expansion* VKM-F-275, *Mucor mucedo* VKM-F-1257, *Rhizopus stolonifer* VKM- F-2005 are presented in Table 2.

Data show that the products of the low-temperature fractioning of *Malus domestica Borkh* (Common Antonovka) fruits inhibit the microorganism's growth. It is found experimentally that the zone diameters of growth inhibition of test cultures vary from 5.8 to 14.1 mm. The tested strains of microorganisms are the most common

causative agents of food spoilage. The experimental results indicate that products of the low-temperature fractioning of *Malus domestica Borkh* (Common Antonovka) fruits have antiseptic properties. These points to the prospects of using the powder from pomace and the fruit juice concentrate of *Malus domestica Borkh* (Common Antonovka) in food technology as natural food additives.

CONCLUSION

During the experiment, it was found that the products of the low-temperature fractioning of *Malus domestica Borkh* (Common Antonovka) fruits have a high antioxidant activity. Determination of the amount of flavonoids and qualitative composition of the extracts from products of the low-temperature fractioning of *Malus domestica Borkh* (Common Antonovka) fruits showed the presence of identical compounds in both fractions. Study of the mineral composition of the obtained products showed that the majority of the chemical elements predominate in the concentrated juice. The pomace powder contains most calcium, magnesium and phosphorus. Processing products of apples have antimicrobial activity against the standard strains of food spoilage. Antioxidant and antimicrobial activity and magnesium and iron content are quite high in the highlighted fractions. That reflects the prospects of using the obtained natural additives in food technologies in order to maintain and increase the shelf life as well as for use in functional and preventive nutrition.

REFERENCES

- Bai, X., Zhang, H., Ren, S. 2013. Antioxidant activity and HPLC analysis of polyphenol enriched extracts from industrial apple pomace. *Journal of the Science of Food and Agriculture*, vol. 93, no. 10, p. 2502-2506. <https://dx.doi.org/10.1002/jsfa.6066>
- Brzóška, M. M., Rogalska, J., Roszczenko, A., Galazyn-Sidorczuk, M., Tomczyk, M. 2016. The mechanism of the osteoprotective action of a polyphenol-rich Aronia melanocarpa extract during chronic exposure to cadmium is mediated by the oxidative defense system. *Planta Medica*, vol. 82, no. 7, p. 621-631. <https://doi.org/10.1055/s-0042-103593>
- Chambi, H. N. M., Arid, J. D., Schmidt, F. L. 2016. Dehydrated melon containing antioxidants and calcium from grape juice. *Functional foods in health and disease*, vol. 11, no. 6, p. 718-734.
- Du, G., Sun, L., Zhao, R., Du, L., Song, J., Zhang, L., He, G., Zhang, Y., Zhang, J. 2016. Polyphenols: Potential source of drugs for the treatment of ischaemic heart disease. *Pharmacology and Therapeutics*, vol. 162, p. 23-34. <https://dx.doi.org/10.1016/j.pharmthera.2016.04.008>
- Eberhard, M. V., Lee, Cy-Liu, R. H. 2000. Antioxidant activity of fresh apples. *Nature*, vol. 405, no. 6789, p. 903-904. <https://doi.org/10.1038/35016151>
- Emel'yanov, A. A. 2009. Resource Saving Processing of Fruits Raw Material at Lowered Temperatures. *Food Processing Industry*, no. 7, p. 28-29.
- Emel'yanov, A. A., Dolzhenkov, V. V., Emel'yanov, K. A. 2008. A vacuum distiller. *Instruments and Experimental Techniques*, vol. 51, no. 5, p.146-149.
- Francini, A., Romeo, S., Cifelli, M. 2017. H-1 NMR and PCA-based analysis revealed variety dependent changes in phenolic contents of apple fruit after drying. *Food Chemistry*, vol. 221, p. 1206-1213. <https://doi.org/10.1016/j.foodchem.2016.11.038>
- Krishnaiah, D., Sarbatly, R., Nithyandam, R. 2011. A review of the antioxidant potential of medicinal plants. *Food and Bioproducts Processing*, vol. 89, no. 3, p. 217-233. <http://dx.doi.org/10.1016/j.fbp.2010.04.008>
- Lobanova, A. A., Budaeva, V. V., Sakovich, G. V. 2004. The study of the biologically active flavonoids in the extracts of the plant raw materials. *Chemistry of Plant Raw Materials*, vol. 1, p. 47-52.
- Maragò, E., Iacopini, P., Camangi, F., Scattino, C., Ranieri, A., Stefani, A. 2015. Phenolic profile and antioxidant activity in apple juice and pomace. *Effects of different storage conditions*, vol. 70, p. 213-223. <http://dx.doi.org/10.1051/fruits/2015015>
- McClements, D. J., Decker, E. A. 2006. Lipid oxidation in oil-in-water: influence of molecular environment on chemical reactions in heterogeneous food systems. *Journal of Food Science*, vol. 65, no. 8, p. 1270-1282. <https://dx.doi.org/10.1111/j.1365-2621.2000.tb10596.x>
- Nakatani, N. 2000. Phenolic antioxidants from herbs and spices. *Biofactors*, vol. 13, no. 1-4, p. 141-146.
- Patent RU. *A method for producing reconstituted juice*. Patent RU № 2369273. 2009-10-10.
- Rice-Avans, C. A. Miller, N. J., Paranga, G. 1996. Structure-antioxidant activity relationships of flavonoids and phenolic acids. *Free Radical Biology and Medicine*, vol. 20, no. 7, p. 933-956.
- Senevirate, K., Kotuwagedara, R. 2009. Antioxidant activities of phenolic extracts of vegetable oils and seed hulls of five plant species. *The Products of Scientific Technology*, vol. 15, no. 5, p. 419-425.
- Sharma, S., Rana, S., Patial, V. 2016. Antioxidant and hepatoprotective effect of polyphenols from apple pomace extract via apoptosis inhibition and Nrf2 activation in mice. *Human & Experimental Toxicology*, vol. 35, no. 12, p. 1264-1275. <https://doi.org/10.1177/0960327115627689>
- Silva de Lima, A. C., da Rocha Viana, J. D., de Sousa Sabino, L. B. da Siva, L. M. R., da Siva, N. K. V., deSousa, P. H. M. 2015. Processing of three different cooking methods of cassava: Effects on *in vitro* bioaccessibility of phenolic compounds and antioxidant activity. *LWT – Food Science and Technology*, vol. 76, part B, p. 253-258. <http://dx.doi.org/10.1016%2Fj.lwt.2016.07.023>
- Silva, B. A., Ferreres, F., Malva, J. O., Dias, A. C. P. 2005. Phytochemical and antioxidant characterization of Hypericum perforatum alcoholic extracts. *Food Chemistry*, vol. 90, no. 1-2, p. 157-167. <https://dx.doi.org/doi:10.1016/j.foodchem.2004.03.049>
- Suja, C., Shuhaib, B., Abdurahman, M., Khathoom, H., Simi, K. 2016. A review on dietary antioxidants. *Research Journal of Pharmacy and Technology*, vol. 9, no 2, p. 196-202.
- Turkmen, N., Sari, F., Velioglu, S. 2005. The Effect of cooking methods on total phenolic compounds and antioxidant activity of certain green vegetables. *Food Chemistry*, vol. 93, p. 713-718. <https://dx.doi.org/10.1016/j.foodchem.2004.12.038>
- Van Acker, S. A., Tromp, M. N. 1996. Structural aspects of antioxidant activity of flavonoids. *Free Radical Biology and Medicine*, vol. 20, no. 3, p. 331-342.
- Vineetha, V. P., Girija, S., Soumya, R. S., Raghu, K. G. 2014. Polyphenol-rich apple (*Malus domestica* L.) peel extract attenuates arsenic trioxide induced cardiotoxicity in H9c2 cells via its antioxidant activity. *Food Funct.*, vol. 5, no. 3, p. 502-511.
- Yanishlieva, N., Marinova, E., Pokorny, J. 2006. Natural antioxidants from herbs and spices. *European Journal of Lipid Science and Technology*, vol. 109, no. 9, p. 776-793.
- Zhang, D., Hamauzu, X. 1995. Phenols, ascorbic acid, carotenoids and antioxidant activity of broccoli and their changes during conventional microwave oven. *Food Chemistry*. vol. 88, no. 4, p. 503-509.
- Zhang, T., Wei, X., Miao, Z., Hassan, H., Song, Y., Fan, M. 2016. Screening for antioxidant and antibacterial activities of phenolics from Golden Delicious apple pomace. *Chemistry Central Journal*, vol. 10, p. 47. <https://dx.doi.org/10.1186%2Fs13065-016-0195-7>

Acknowledgments:

This article was prepared with active participation of researchers from AgroBioNet international network for implementation of the international program "Agrobiodiversity to improve nutrition, health and quality of life" within the project "Promotion of innovative technologies of special natural products for a healthy diet of people" (ITEBIO ITMS 26220220115) at the Center for the conservation and use of agricultural biodiversity at the Faculty of agrobiological and food resources Slovak agricultural university. Contributors Elena Kuznetsova, Elena Klimova and Natalya Selifonova would like to thank the Slovak agricultural University in Nitra for the opportunity to conduct scientific training and for scholarship within Erasmus + program for research, during which experimental results were obtained and this scientific publication was prepared.

Contact address:

Elena Kuznetsova, Orel State University named I.S. Turgenev, 302026, Orel, Komsomolskaya street, 95, Russian Federation,

E-mail: elkuznetcova@yandex.ru

Alexander Emelyanov, Orel State University named I.S. Turgenev, 302026, Orel, Komsomolskaya street, 95, Russian Federation, E-mail:

alexandr.emelyanov@gmail.com

Andrey Vinokurov, Orel State University named I.S. Turgenev, 302026, Orel, Komsomolskaya street, Russian Federation, 95, E-mail: tolmach_88@mail.ru

Tatyana Bychkova, Orel State University named I.S. Turgeneva, 302026, Orel, Komsomolskaya street, 95, Russian Federation, E-mail: ya2810@mail.ru

Elena Klimova, University named I.S. Turgenev, 302026, Orel, Komsomolskaya street, 95 Russian Federation, E-mail: kl.e.v@yandex.ru

Vladislav Zomitev, Orel State University named I.S. Turgenev, 302026, Orel, Komsomolskaya street, 95, Russian Federation, E-mail: gz63@mail.ru

Natalia Selifonova, Orel State University named I.S. Turgenev, 302026, Orel, Komsomolskaya street, 95, Russian Federation, E-mail: kapelka232@yandex.ru

Ján Brindza, Institute of biological conservation and biosafety, Faculty of agrobiological and food resources, Slovak University of Agriculture in Nitra. Trieda Andreja Hlinku 2, 949 76 Nitra, Slovakia. E-mail: Jan.Brindza@uniag.sk



EVALUATION OF SELECTED PHYSICOCHEMICAL PARAMETERS OF EXTRA VIRGIN OLIVE OIL COMMERCIALIZED IN THE CZECH MARKET AND STORED DURING A PERIOD OF 5 MONTHS

Richardos Nikolaos Salek, Iva Burešová, Stanislav Kráčmar, Eva Lorencová, Ludmila Zálešáková, Vikendra Dabash

ABSTRACT

The scope of this work was to evaluate the development of selected physicochemical parameters (free acidity, peroxide value and specific extinction coefficients in ultraviolet) of extra virgin olive oil, commercialized in the Czech market and stored for a time period of 5 months (at 20 ± 5 °C). The tested extra virgin olive oil samples were stored under conditions simulating domestic and commercial storage environment, in which the impact of light and headspace volume were also examined. Moreover, all the analyzed samples fell within the established “extra virgin olive oil category”, thus proving their legitimacy, authentication and excellent quality. Furthermore, all the monitored physicochemical parameters were affected by the progress of the storage period, the rising volume of headspace (due to more available oxygen in the container) and exposition to light, resulting in decreasing quality of the examined extra virgin olive oil samples. In addition, the storage of extra virgin olive oil samples in dark containers reported sufficient resistance to oxidation processes up to a period of 3 months, however, after this period signs of oil quality deterioration were reported. Nevertheless, if exposition to light occurred, accelerated decrease in the quality of the extra virgin olive oil samples was observed.

Keywords: extra virgin olive oil; oxidation; quality; storage period; storage conditions

INTRODUCTION

Extra virgin olive oil (EVOO) is a “natural juice” obtained only from fresh and mature fruit of the olive tree (*Olea europaea* L.) through solely mechanical or other physical operations (in particular thermal means) under conditions not leading to product alterations. Moreover, EVOO shall not undergo any treatment other than washing, decanting, centrifuging and filtering. High quality EVOO is an ingredient of great importance of the Mediterranean diet, due to its nutritional, health benefits and its organoleptic properties (Kanavouras et al., 2005; Dabbou et al., 2011; Condelli et al., 2015; Jabeur et al., 2015; Gomez-Caravaca et al., 2016; Kotsiou and Tasioula-Margari, 2016). In addition, the health-promoting characteristics of EVOO concern of the ability preventing diseases (cardiovascular, cancer, and neurodegenerative) (Ben-Hssine et al., 2013; Condelli et al., 2015). Furthermore, the high proportion of monounsaturated fatty acids, namely oleic acid and a balanced presence of polyunsaturated fatty acids and minor components (tocopherol, phenolic compounds – hydroxytyrosol, oleuropein) result in the protective effect of EVOO (Kiritsakis, 1998; Dais and Hatzakis, 2013; Condelli et al., 2015; Frančáková et al., 2015).

The hard and time-consuming tasks involved in the cultivation of olive trees, the harvesting of the fruits and the extraction process are the main factors that cause the increase in the price of EVOO. The price of EVOO can be 6 to 7 times higher than that of other edible vegetable oils. In general, adulteration of food products involves the replacement of high cost ingredients with lower grade and cheaper substitutes. Nevertheless, for the above-mentioned reasons, adulterations of EVOO with lower quality/price olive oils and/or with oils of different botanical origin are monitored. Olive oil adulteration is one of the leading food frauds and is a serious problem for regulatory agencies, oil suppliers and could also threat health of consumers (Tay et al., 2002; Vlachos et al., 2006; Gurdeniz and Ozen, 2009; Poulli et al., 2009). The International Olive Council defines four commercial graded groups of olive oils based on their free acidity (FA) value (expressed as percentage w/w of oleic acid) – extra virgin ($\leq 0.8\%$ w/w), virgin ($\leq 2.0\%$ w/w), ordinary virgin ($\leq 3.3\%$ w/w), and lampante ($> 2.0\%$ w/w). The value of olive oil FA can be affected by factors such as variety, method of harvesting, extraction process and storage parameters (Tsimidou et al., 2005; Hirri et al., 2016).

However, the quality of EVOO decreases during storage, and is attributable mainly to lipid oxidation mechanisms leading to rancidity and hydrolytic reactions which cause the partial loss of minor compounds having health-promoting benefits. Several factors can affect the oxidative processes that influence the shelf-life of olive oil. Concretely, temperature, light, oxygen availability, packaging and storage conditions are the main parameters influencing the rate of the phenomena mentioned above (Brenes et al., 2001; Vacca et al., 2006; Kotsiou and Tasioula-Margari, 2016). Therefore, the packaging material applied for EVOO must adequately protect it against light, oxygen and the autooxidation process that can cause rancidity. Autooxidation is a chemical reaction occurring at ambient temperatures between atmospheric oxygen and an organic compound. Plethora of types of packaging materials (plastic films, metal containers) can be used, whereas glass containers of various shapes and colours are the most common. However, the main disadvantage of “clean” glass and transparent plastic containers is that the product might be subjected to photooxidation. Moreover, real time storage of EVOO in the marketplace or under domestic conditions may expose the product to light and/or elevated temperatures (typically 28 – 30 °C). The latter storage conditions are not optimum of preservation the high quality of EVOO, as are among the main factors affecting the rate of degradation reactions (Gutiérrez et al., 2002; Kanavouras and Coutelieris, 2006; Cozzolino, 2015).

The per capita consumption of olive oil in the Czech Republic together with other Eastern European countries is very low (0.6 kg per capita per year). This phenomenon is probably related to the high price of EVOO and to the population's poor dietary habits of this region (high intake of saturated fats), which is also linked with increased cardiovascular diseases and other chronic disorders (Ness and Powles, 1997; Boylan et al., 2009). However, these facts indicate that olive oil is not so significant commodity in the Czech Republic and some neighboring countries and thus, rising advertence should be provided to the legality standards of EVOO sold at these regions. To our knowledge, in the available scientific literature there has not been found yet a study focused on the physicochemical quality indices of EVOO sold exclusively in the Czech Republic or other countries with minimum olive oil consumption.

The present study was undertaken with the primary objective to evaluate the legitimacy and selected physicochemical quality parameters (free acidity, peroxide value and specific extinction coefficients in ultraviolet) of EVOO samples commercialized in the Czech market and stored in dark glass containers during a 5 month storage period (at 20 ±5 °C). The storage parameters were simulating mainly domestic and commercial conditions. Moreover, a supplementary aim of the current study was to investigate the phenomenon mentioned above on an EVOO sample which was exposed to light.

Scientific hypothesis

The storage conditions (storage period, light exposition) of EVOO can influence its physicochemical quality characteristics.

MATERIAL AND METHODOLOGY

Samples and storage conditions

EVOO monovarietal samples of five different commercial brands were considered in this work in total. Four of the evaluated samples originated from two distinctive producing countries, including Spain (samples A and E) and Greece (samples C and D). In addition, one sample was a mixture of EVOOs originating from areas of the European Union and outside the European Union (sample B; Spain and Morocco). All the samples were manufactured from olives of one crop harvesting season (2014/2015). The examined samples were purchased from Czech local retail. Furthermore, the samples were transferred in dark glass containers and were stored in a room without light exposition for a period of 5 months at 20 ±5 °C. Moreover, one of the samples (sample B) was transferred also in a transparent glass container and was stored on a laboratory shelf, where was exposed intermittently 12 h to artificial light for a period of 5 months at 20 ±5 °C. All glass containers (Skláry Moravia, Úsobrnno, Czech Republic) were of 500 mL in capacity and after the filling contained 450 mL of oil. Finally, the containers were tightly sealed with aluminum screw-type caps of negligible permeability to oxygen.

Solvents and reagents

For the determination of free acidity (free fatty acids), ethanol (≥99.9%) and diethyl ether (≥99.7%), potassium iodine (>99.0%), sodium thiosulphate and sodium hydroxide (>99%) were purchased from Sigma-Aldrich (Schnelldorf, Germany). For the determination of peroxide value, chloroform (>99.1%) and acetic acid (100.0%) were also purchased (Sigma-Aldrich, Schnelldorf, Germany). For the determination of absorption indices isoctane was purchased from Sigma-Aldrich (Schnelldorf, Germany).

Determination of moisture content

The mass assessment by heating in a drying oven (103 ±2 °C) standardized method was performed in order to determine the moisture content of the samples (EC No 1989/2003). In brief, in a capsule, previously dried at 103 ±2 °C and cooled, 20.00 ±0.05 g of the examined were weighted. Thereafter, the samples were transferred into a drying oven at 103 ±2 °C for a period of 24.0 ±0.5 h, after which the samples were removed and weighted again. The operation was repeated until constant weight was obtained. Finally, the moisture content was calculated as the difference in weights. The analysis was performed in triplicate for each sample on each day of analysis.

Determination of free acidity

The free acidity (FA) is indicative of the free fatty acid content of the examined oil and is expressed as percentage of oleic acid, since it is the major fatty acid found in olive oils (corresponding to 55 – 83% of the total fatty acid content) (Rodrigues et al., 2016). The current determination was performed by titration with the aqueous solution of sodium hydroxide (0.1 mol.L⁻¹) of an oil solution in a previously neutralized solvent (ethanol/ethylether, 1 : 1 v/v) and using phenolphthalein as indicator. The applied method was according the standard analytical methods described by the Regulation 1989/2003

of the Commission of the European Union (EC No 1989/2003). For each sample at each day of analysis the determination was performed in triplicate.

Determination of peroxide value

The peroxide value (PV) is a measurement of the amount of hydroperoxides formed through oxidation during storage. Peroxide value is expressed as milliequivalents of active oxygen per kilogram of oil. Peroxide value was determined as follows: olive oil (2.5 g) was dissolved in a mixture of chloroform/acetic acid (2 : 3, v/v) and was left to react with a solution of potassium iodide in the darkness; the free iodine was then titrated with a sodium thiosulfate solution. The analysis was assessed following the analytical methods described by the Regulation EC/1989/2003 of the Commission of the European Union (EC No 1989/2003). For each sample the analysis was performed in triplicate.

Analysis of spectroscopic indices in ultraviolet

The ultraviolet characteristics, i.e. extinction coefficients determined from absorption at 232 nm (K232), at 270 nm (K270) and ΔK value [difference between absorbance at 270 nm and (266 nm + 274 nm)/2], by an UVmini-1240 UV-VIS spectrophotometer (Shimadzu, Kyoto, Japan), using a 1.0% (v/v) solution of oil in isooctane and a path length cuvette of 1 cm. The ΔK value was calculated according to Eq. 1 as follows:

$$\Delta K = A - \frac{B+C}{2} \quad (1)$$

where; A, B and C are the absorbencies at wavelengths of 270 nm, 266 nm and 274 nm, respectively.

The determinations describing the samples characteristics in ultraviolet were performed according to the European Union Commission Regulations 1989/2003 (EC No 1989/2003). For each sample the determination of spectroscopic characteristics in ultraviolet was performed in triplicate.

Statistic analysis

The obtained data were subjected to analysis of variance using the Minitab 17 statistical software program (Minitab, Coventry, United Kingdom). Where statistical differences were noted, differences among data were determined, using the Tukey's test. Significance was defined at $p < 0.05$.

RESULTS AND DISCUSSION

Determination of moisture content

The moisture content of the analyzed EVOO samples ranged from 5.0×10^{-2} to $4.5 \times 10^{-1} \text{ g} \cdot \text{kg}^{-1}$, a range similar to that was reported in the study of **Ragni et al. (2016)**. The moisture content of the samples was in accordance to the established regulations and standards by the European Union (EC No 1989/2003). The quality of EVOO is known to be closely related to its composition and the moisture content is considered one of the basic criteria of evaluating its quality. Moreover, the amount of water content which is indirectly correlated with some organoleptic characteristics, such as pungency and

bitterness, can also affect the stability and preservation of EVOO during storage (**Fregapane et al., 2006; Hatzakis and Dais, 2008**). Moreover, the amount of water in commercial EVOO samples is highly affected by the applied technological processes, such as extraction and filtration operations. However, the high polar phase (water) may augment the alteration of EVOO during storage, by increasing the hydrolytic rate of the present triacylglycerols. However, the latter process increases FA, exposing EVOO to oxidation in the presence of oxygen, light or high temperature. This could be explained by the hydrolysis of the ester linkage of triacylglycerols, resulting in the production of free fatty acids. Hence, as these are less resistant to autooxidation, their presence could lead to the development of rancidity, off-flavours and decrease of the smoke point (**Ragni et al., 2012; Yun and Surh, 2012**).

Determination of free acidity

The analysis of FA reports the level of hydrolysis in the examined oil. In the same token, could provide information correlated with how the olives were manipulated prior processing and the length of time from harvest to milling (**Borges et al., 2017**). Furthermore, EVOO is composed by approximately 98% of neutral lipids, mainly triglycerides (96 – 97%), followed by a small quantity of diglycerides (1 – 2%) and a variable amount of free fatty acids which are used as a marker in quality evaluation (**Jabeur et al., 2015**). The results of FA values development during storage in dark glass bottles are depicted in Figure 1 (part A). From the obtained results it can be assessed that the examined samples fell within the ranges established for EVOO category, as required by Regulation EC/1989/2003 (EC No 1989/2003). Concretely, the FA values at the initial stage of the experiment (month 0) were below 0.8% (0.2 – 0.4%), indicating that all the examined samples presented efficient resistance to oxidation, since FA could be used as a quality parameter contributing also to oil oxidative stability (**Dabbou et al., 2011**). Additionally, it should be mentioned that the lower the values of FA, the higher of the oil obtained from fresh and healthy olives, harvested at the optimal maturity degree, followed by immediate extraction without proceeding to olive storage. In general, it is accepted that olives of higher maturity level result in products with elevated levels of FA, since they can undergo an increase in enzymatic activity (especially lipolytic enzymes) and are more sensitive to pathogenic infections and mechanical damage (**Manai-Djebali et al., 2012**). Moreover, the results of FA values development during storage in transparent and dark glass containers are shown in Figure 2 (part A). From the results it could be depicted that the sample stored in dark container showed a minimum increase ($p > 0.05$) in FA during storage. Hence, the protective effect on light of the dark container was obvious during the storage of EVOO. Moreover, similar findings have been previously reported in the studies of **Dabbou et al. (2011)** and **Pristouri et al. (2010)**. On the other hand, the values of FA significantly rose ($p < 0.05$) in the samples stored in transparent glass containers and thus exposed to light. Concretely, after 3 months of storage the oil sample exceeded the established limit for EVOO category. A possible explanation of this phenomenon

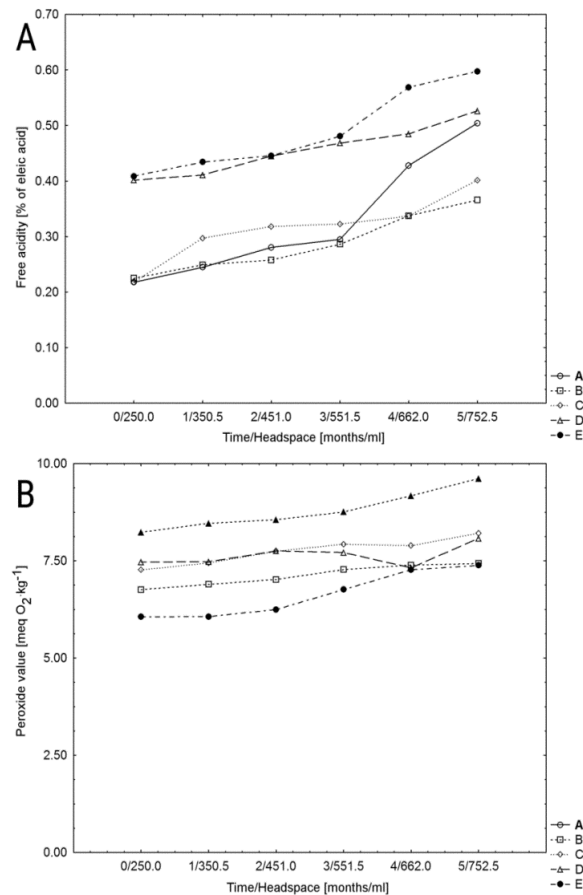

Figure 1 Parameters development in EVOO samples. Development of free acidity (Part A). Development of peroxide value (Part B). The samples (A, B, C, D, E) were stored in dark glass containers during a storage period of 5 months (at 20 ± 5 °C). The results are expressed as means ($n = 3$); standard deviations were in range of 0.01 – 0.03 and are not displayed.

could be the impact of light on triacylglycerides hydrolysis leading to free acid release, which in turn can cause rancidity. Moreover, another explanation could be the photosensitized oxidation mechanism, occurring via the action of light, present natural photosensitizers (such as chlorophyll) and atmospheric oxygen. Photosensitizers can react with atmospheric triplet oxygen (3O_2) producing the excited state singlet oxygen (1O_2). Therefore, 1O_2 can form a free radical from unsaturated fatty acids, resulting in the development of lipid hydroperoxides (first lipid oxidation products). Nevertheless, the latter in EVOO can decompose immediately into aldehydes, ketones, alcohols and short-chain hydrocarbons, which are secondary lipid oxidation products and are responsible for the production of off-flavours (Pristouri et al., 2010; Dabbou et al., 2011; Kim and Choe, 2013).

Determination of peroxide value

The PV could be characterized as quality parameter of mandatory importance, reflecting the onset of the oxidation process. The PV analysis determines mainly the content of hydroperoxides, which are unstable and can decompose producing aldehydes and ketones (Borges et al., 2017, Šulcerová et al., 2017). The results of PV development during storage in dark containers are presented in Figure 1 (part B). The measured PV in all samples exhibited initial values within the range of EVOO

category (≤ 20 meq·kg⁻¹), regardless of the storage time, signaling EVOO of excellent quality. Moreover, another interesting observation was that the PV slightly rose ($p < 0.05$) during the 5-month storage, with a maximum at the last month of storage. Hence, this certain trend could be explained by the primary oxidation occurring in the presence of oxygen in the container headspace leading to the production of hydroperoxides. Additionally, the oxygen content in oil is dependent on the oxygen partial pressure in the headspace. Hence, higher oxygen partial pressure in the headspace results in higher levels of dissolved oxygen in the oil, which in turn enhances the lipid oxidation process (Pristouri et al., 2010; Kim and Choe, 2013; Rodrigues et al., 2016). Furthermore, similar results were reported in the work of Kotsiou and Tasioula-Margari (2016) and Vacca et al. (2006). The above-mentioned phenomenon was dramatically more intensive ($p < 0.05$) in the sample which was exposed to light during storage (Figure 2; part B). From the results it could be depicted that the examined sample exceeded the permitted limit after 3 months of storage. However, after the completion of this period the combined effect of light and oxygen availability resulted in rapid EVOO oxidation acceleration during the remainder storage time. According to scientific literal sources photosensitized oxidation does not occur in olive oil stored in the dark at relatively low temperatures (13 – 20 °C). Thus, due to the present chlorophyll this can act as natural antioxidant along with

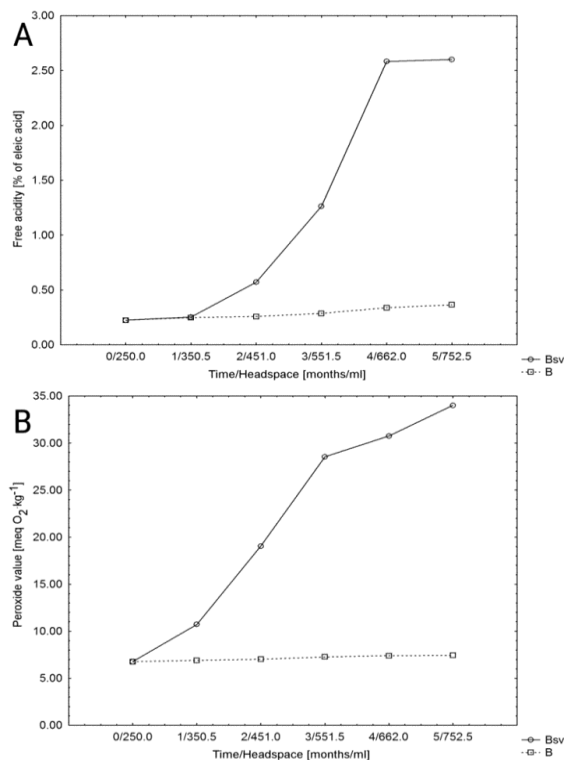

Figure 2 Parameters development in EVOO samples. Development of free acidity (Part A). Development of peroxide value (Part B). The samples were stored in dark glass (B) and transparent glass (Bsv) containers during a storage period of 5 months (at 20 ± 5 °C). The results are expressed as means (n = 3); standard deviations were in range of 0.01 – 0.04 and are not displayed.

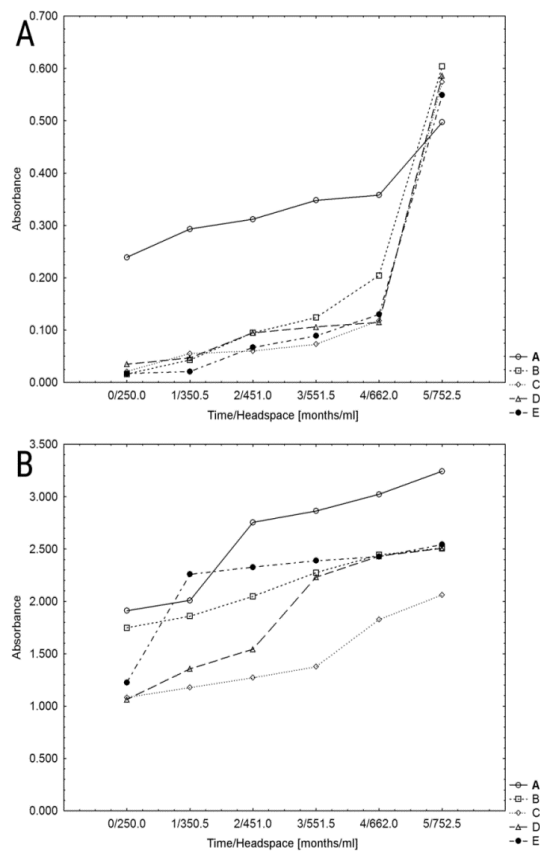

Figure 3 Absorption coefficients development of the EVOO samples. Development of K₂₃₂ values (Part A). Development of K₂₇₀ values (Part B). The samples (A, B, C, D, E) were stored in dark glass containers during a storage period of 5 months (at 20 ± 5 °C). The results are expressed as means (n = 3); standard deviations were in range of 0.02 – 0.05 and are not displayed.

polyphenols protecting the EVOO from oxidation. In general, higher PV is an indicator of low quality EVOO with weak oxidative stability (Pristouri et al., 2010; Pizarro et al., 2013).

Analysis of spectroscopic indices in ultraviolet

The absorption coefficients in ultraviolet are used as indicators of olive oil oxidation, allowing the measurement of certain oxidized compounds resonating at wavelengths of 232 nm and 270 nm. Moreover, the K232 index corresponds to the absorbancy of conjugated dienes and their oxidation products. In addition, the K270 index corresponds to the absorbancy of the conjugated trienes and secondary products of oxidation (carbonyl compounds) (Manai-Djebali et al., 2012; Bachari-Saleh et al., 2013). The ΔK value can provide information about detection of oil treatments with colour removing substances and the presence of refined or pomace oil. The results of spectroscopic characteristics in ultraviolet for the examined EVOO samples stored in dark containers (at 20 ±5 °C) as a function of storage period are depicted in Fig. 3 (parts A and B). From the results it could be reported that all samples presented values of K232, K270, and ΔK below the established critical limits (K232 ≤2.50, K270 ≤0.22, ΔK ≤0.01). Hence, all the samples fell within the established for EVOO category. Moreover, the obtained results indicate that the analyzed samples were of superior quality, obtained from fresh and health raw material, harvested at the ideal ripening level, followed by

immediate extraction without proceeding to olive storage. However, if high initial values of K232 and K270 were detected this could indicate the presence of conjugated dienes and trienes, which are formed in oils that have been heat-treated during the refining, process (Bachari-Saleh et al., 2013). According to Ben-Hassine et al. (2013) fresh EVOO are characterized by low values of K232 and K270 in contrast to samples of extended storage. The K232 value development rose as the storage period progressed. Therefore, the K232 of most of the samples did not exceed the limit of 2.5 during the 5 month storage period. However, exception was sample E, whose measured values exceeded the established limit after 2 months of storage. The development of K270 value rose (p <0.05) with the increase of the storage period. All the samples at the initial stage (month 0) of the experiment reported values below 0.22 (which is the permitted limit); however, sample A from the beginning was slightly above the permitted limit. Moreover, the monitored values (with exception sample A) were below the limit up to the 4th month of storage, after this period the values rose significantly (p <0.05). The increase in the values of K232 and K270 during the evolution of storage was due to the formation of conjugated dienes and trienes, respectively. Their formation is proportional to the oxygen uptake and formation of hydroperoxides in the early stages of oxidation (Kim and Choe, 2013). Moreover, this phenomenon was more intensive when the examined sample was exposed to light (Figure 4; parts A and B).

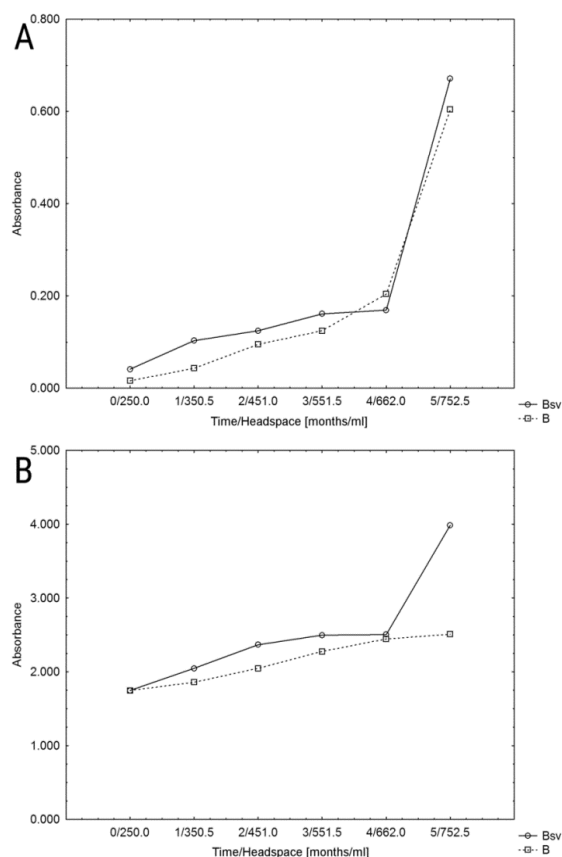

Figure 4 Absorption coefficients development in the extra virgin olive oil samples. Development of K₂₃₂ values (Part A). Development of K₂₇₀ values (Part B). The samples were stored in dark glass (B) and transparent glass (Bsv) containers during a storage period of 5 months (at 20 ±5 °C). The results are expressed as means (n = 3); standard deviations were in range of 0.01 – 0.03 and are not displayed.

Specifically, after 4 months of storage the EVOO sample exceeded the permitted limit. Similar results were found in the work of **Pristouri et al. (2010)** and **Stefanouadaki et al. (2010)**. The results of ΔK values ranged from 0.0005 to 0.0020, reporting that none of the analyzed samples were adulterated with refined or pomace oil and none of them were processed with colour removing substances.

CONCLUSION

The evolution of EVOO selected quality factors which simulated real-time household conditions was examined. The examined parameters of EVOO samples stored during 5 months at dark or transparent containers were affected by the storage time, lighting conditions and oxygen availability (headspace volume). Furthermore, all the samples merchandised in the Czech market fell within the established legal limits of EVOO category, thus proving not only their legitimacy and authentication whereas also their high quality. During the storage all the samples showed an increase in FA, PV and specific extinction coefficients at 232 nm (K232) and 270 nm (K270), respectively. Moreover, it could be concluded that the quality of the samples decreased with the increasing storage period, the rising volume of headspace (due to more available oxygen in the container) and exposition to light. Furthermore, the quality factors of the sample which was exposed to light decreased dramatically after 4 months of storage, depicting the significance of the packaging material on EVOO quality. The results indicated that transparent glass containers were unsuitable for long-term storage (≥ 4 months) of EVOO. In general, the EVOO samples when were stored in dark containers presented sufficient resistance to oxidation, reporting minimal quality changes. Finally, it could be assessed that even if EVOO stored under inadequate conditions presented minimal quality changes up to a period of 3 months; however, after this period signs of deterioration in olive quality were observed.

REFERENCES

Bachari-Saleh, Z., Ezzatpanah, H., Aminafshar, M., Safar, H. 2013. The Effect of Refining Process on the Conjugated Dienes in Soybean Oil. *Journal of Agricultural Science and Technology*, vol. 15, p. 1185-1193.

Ben-Hassine, K., Taamalli, A., Ferchichi, S., Mlaouah, A., Benincasa, C., Romano, E., Flamini, G., Lazzez, A., Grati-Kamoun, N., Perri, E., Malouche, D., Hammami, M. 2013. Physicochemical and sensory characteristics of virgin olive oils in relation to cultivar, extraction system and storage conditions. *Food Research International*, vol. 54, no. 2, p. 1915-1925. <https://doi.org/10.1016/j.foodres.2013.09.007>

Borges, T. H., Pereira, J. A., Cabrera-Vique, C., Lara, L., Oliveira, A. F., Seiquer, I. 2017. Characterization of Arbequina virgin olive oils produced in different regions of Brazil and Spain: Physicochemical properties, oxidative stability and fatty acid profile. *Food Chemistry*, vol. 215, p. 454-462. <https://doi.org/10.1016/j.foodchem.2016.07.162> PMID:27542498

Boylan, S., Welch, A., Pikhart, H., Malyutina, S., Pajak, A., Kubinova, R., Bragina, O., Simonova, G., Stepaniak, U., Gilis-Januszewska, A., Milla, L., Peasey, A., Marmot, M., Bobak, M. 2009. Dietary habits in three Central and Eastern European countries: The HAPIEE study. *BMC Public Health*,

vol. 9, p. 1439. <https://doi.org/10.1186/1471-2458-9-439> PMID:19951409

Brenes, M., García, A., García, P., Garrido, A. 2001. Acid hydrolysis of secoiridoid aglycons during storage of virgin olive oil. *Journal of Agricultural and Food Chemistry*, vol. 49, no. 11, p. 5609-5614. <https://doi.org/10.1021/jf0107860> PMID:11714367

Condelli, N., Caruso, M. C., Galgano, F., Russo, D., Milella, L., Favati, F. 2015. Prediction of the antioxidant activity of extra virgin olive oils produced in the Mediterranean area. *Food Chemistry*, vol. 177, p. 233-239. <https://doi.org/10.1016/j.foodchem.2015.01.001> PMID:25660881

Cozzolino, D. 2015. The role of vibrational spectroscopy as a tool to assess economically motivated fraud and counterfeit issues in agricultural products and foods. *Analytical Methods*, vol. 7, no. 22, p. 939-994. <https://doi.org/10.1039/C5AY01792K>

Dabbou, S., Gharbi, I., Dabbou, S., Brahmi, F., Nakbi, A., Hammami, M. 2011. Impact of packaging material and storage time on olive oil quality. *African Journal of Biotechnology*, vol. 10, no. 74, p. 16937-16947.

Dais, P., Hatzakis, E. 2013. Quality assessment and authentication of virgin olive oil by NMR spectroscopy: A critical review. *Analytica Chimica Acta*, vol. 765, p. 1-27. <https://doi.org/10.1016/j.aca.2012.12.003> PMID:23410622

Frančáková, H., Ivanišová, E., Dráb, Š., Krajčovič, T., Tokár, M., Mareček, J., Musilová, J. 2015. Composition of fatty acids in selected vegetable oils. *Potravinarstvo*, vol. 9, no. 1, p. 538-542. <https://doi.org/10.5219/556>

Fregapane, G., Lavelli, V., León, S., Kapuralin, J., Salvador, M. D. 2006. Effect of filtration on virgin olive oil stability during storage. *European Journal of Lipid Science and Technology*, vol. 108, no. 2, p. 134-142. <https://doi.org/10.1002/ejlt.200501175>

Gomez-Caravaca, A. M., Maggio, R. M., Cerretani, L. 2016. Chemometric applications to assess quality and critical parameters of virgin and extra-virgin olive oil. A review. *Analytica Chimica Acta*, vol. 913, p. 1-21. <https://doi.org/10.1016/j.aca.2016.01.025> PMID:26944986

Gurdeniz, G., Ozen, B. 2009. Detection of adulteration of extra-virgin olive oil by chemometric analysis of mid-infrared spectral data. *Food Chemistry*, vol. 116, no. 2, p. 519-525. <https://doi.org/10.1016/j.foodchem.2009.02.068>

Gutiérrez, F., Villafranca, M., Castellano, J. 2002. Changes in the main components and quality indices of virgin olive oil during oxidation. *Journal of the American Oil Chemists' Society*, vol. 79, no. 7, p. 669-676. <https://doi.org/10.1007/s11746-002-0541-3>

Hatzakis, E., Dais, P. 2008. Determination of water content in olive oil by ³¹P NMR spectroscopy. *Journal of Agricultural and Food Chemistry*, vol. 56, no. 6, p. 1866-1872. <https://doi.org/10.1021/jf073227n> PMID:18303819

Hirri, A., Bassbasi, M., Platikanov, S., Tauler, R., Oussama, A. 2016. FTIR spectroscopy and PLS-DA classification and prediction of four commercial grade virgin olive oils from Morocco. *Food Analytical Methods*, vol. 9, no. 4, p. 974-981. <https://doi.org/10.1007/s12161-015-0255-y>

Jabeur, H., Zribi, A., Abdelhedi, R., Bouaziz, M. 2015. Effect of olive storage conditions on Chemlali olive oil quality and the effective role of fatty acids alkyl esters in checking olive oils authenticity. *Food Chemistry*, vol. 169, p.

289-296. <https://doi.org/10.1016/j.foodchem.2014.07.118>
 PMID:25236229

Kanavouras, A., Coutelieris, F. A. 2005. Shelf-life predictions for packaged olive oil based on simulations. *Food Chemistry*, vol. 96, no. 1, p. 48-55. <https://doi.org/10.1016/j.foodchem.2005.01.055>

Kanavouras, A., Kiritsakis, A., Hernandez, R. J. 2005. Comparative study on volatile analysis of extra virgin olive oil by dynamic headspace and solid phase micro-extraction. *Food Chemistry*, vol. 90, no. 1-2, p. 69-79. <https://doi.org/10.1016/j.foodchem.2004.03.025>

Kim, N., Choe, E. 2013. Contribution of minor compounds to the singlet oxygen-related photooxidation of olive and perilla oil blend. *Food Science and Biotechnology*, vol. 22, no. 2, p. 315-321. <https://doi.org/10.1007/s10068-013-0083-z>

Kiritsakis, A. 1998. Flavor components of olive oil – A review. *Journal of the American Oil Chemists' Society*, vol. 75, no. 6, p. 673-681. <https://doi.org/10.1007/s11746-998-0205-6>

Kotsiou, K., Tasioula-Margari, M. 2016. Monitoring the phenolic compounds of Greek extra-virgin olive oils during storage. *Food Chemistry*, vol. 200, p. 255-262. <https://doi.org/10.1016/j.foodchem.2015.12.090>
 PMID:26830587

Mabood, F., Boqué, R., Folcarelli, R., Busto, O., Jabeen, F., Al-Harrasi, A., Hussain, J. 2016. The effect of thermal treatment on the enhancement of detection of adulteration in extra virgin olive oils by synchronous fluorescence spectroscopy and chemometric analysis. *Spectrochimica Acta Part A: Molecular and Biomolecular Spectroscopy*, vol. 161, p. 83-87. <https://doi.org/10.1016/j.saa.2016.02.032>
 PMID:26963728

Manai-Djebali, H., Krichène, D., Ouni, Y., Gallardo, L., Sánchez, J., Osorio, E., Daoud, D., Guido, F., Zarrouk, M. 2012. Chemical profiles of five minor olive oil varieties grown in Central Tunisia. *Journal of Food Composition and Analysis*, vol. 27, no. 2, p. 109-119. <https://doi.org/10.1016/j.jfca.2012.04.010>

Ness, A. R., Powles, J. W. 1997. Fruit and vegetables, and cardiovascular disease: A review. *International Journal of Epidemiology*, vol. 26, no. 1, p. 1-13. <https://doi.org/10.1093/ije/26.1.1>
 PMID:9126498

Owen, R. W., Giacosa, A., Hull, W. E., Haubner, R., Spiegelhalter, B., Bartsch, H. 2000. The antioxidant/anticancer potential of phenolic compounds isolated from olive oil. *European Journal of Cancer*, vol. 36, no. 10, p. 1235-1247. [https://doi.org/10.1016/S0959-8049\(00\)00103-9](https://doi.org/10.1016/S0959-8049(00)00103-9)

Pizarro, C., Esteban-Díez, I., Rodríguez-Tecedor, S., González-Sáiz, J. M. 2013. Determination of the peroxide value in extra virgin olive oils through the application of the stepwise orthogonalisation of predictors to mid-infrared spectra. *Food Control*, vol. 34, no. 1, p. 158-167. <https://doi.org/10.1016/j.foodcont.2013.03.025>

Poulli, K. I., Mousdis, G. A., Georgiou, C. A. 2009. Monitoring olive oil oxidation under thermal and UV stress through synchronous fluorescence spectroscopy and classical assays. *Food Chemistry*, vol. 117, no. 3, p. 499-503. <https://doi.org/10.1016/j.foodchem.2009.04.024>

Pristouri, G., Badeka, A., Kontominas, M. G. 2010. Effect of packaging material headspace, oxygen and light transmission, temperature and storage time on quality characteristics of extra virgin olive oil. *Food Control*, vol. 21, no. 4, p. 412-418. <https://doi.org/10.1016/j.foodcont.2009.06.019>

Ragni, L., Berardinelli, A., Cevoli, C., Valli, E. 2012. Assessment of the water content in extra virgin olive oils by time domain reflectometry (TDR) and partial least squares (PLS) regression methods. *Journal of Food Engineering*, vol. 111, no. 1, p. 66-72. <https://doi.org/10.1016/j.jfoodeng.2012.01.028>

Regulation (EC) No 1989/2003 of the European Parliament and of the Council of 6 November 2003 amending Regulation (EEC) No 2568/91 on the characteristics of olive oil and olive-pomace oil and on the relevant methods of analysis. OJ L 295, 6.11.2003, p. 57-66.

Rodrigues, N., Dias, L. G., Veloso, A. C. A., Pereira, J. A., Peres, A. M. 2016. Monitoring olive oils quality and oxidative resistance during storage using an electronic tongue. *LWT – Food Science and Technology*, vol. 73, p. 683-692. <https://doi.org/10.1016/j.lwt.2016.07.002>

Stefanoudaki, E., Williams, M., Harwood, J. 2010. Changes in virgin olive oil characteristics during different storage conditions. *European Journal of Lipid Science and Technology*, vol. 112, no. 8, p. 906-914. <https://doi.org/10.1002/ejlt.201000066>

Tay, A., Singh, R. K., Krishnan, S. S., Gore, J. P. 2002. Authentication of olive oil adulterated with vegetable oils using Fourier transform infrared spectroscopy. *LWT – Food Science and Technology*, vol. 35, no. 1, p. 99-103. <https://doi.org/10.1006/ftsl.2001.0864>

Tsimidou, M. Z., Georgiou, A., Koidis, A., Boskou, D. 2005. Loss of stability of “veiled” (cloudy) virgin olive oils in storage. *Food Chemistry*, vol. 93, no. 3, p. 377-383. <https://doi.org/10.1016/j.foodchem.2004.09.033>

Vacca, V., Caro, A. D., Poiana, M., Piga, A. 2006. Effect of storage period and exposure conditions on the quality of Bosana extra-virgin olive oil. *Journal of Food Quality*, vol. 29, no. 2, p. 139-150. <https://doi.org/10.1111/j.1745-4557.2006.00062.x>

Vlachos, N., Skopelitis, Y., Psaroudaki, M., Konstantinidou, V., Chatzilazarou, A., Tegou, E. 2006. Applications of Fourier transform-infrared spectroscopy to edible oils. *Analytica Chimica Acta*, vol. 573-574, p. 459-465. <https://doi.org/10.1016/j.aca.2006.05.034>
 PMID:17723561

Yun, J. M., Surh, J. B. 2012. Fatty acid composition as a predictor for the oxidation stability of Korean vegetable oils with or without induced oxidative stress. *Preventive Nutrition and Food Science*, vol. 17, no. 22, p. 158-165. <https://doi.org/10.3746/pnf.2012.17.2.158>
 PMID:24471078

Šulcerová, H., Gregor, T., Burdychová, R. 2017. Quality determination of vegetable oils used as an addition to fermented meat products with different starter cultures. *Potravinárstvo*, vol. 11, no. 1, p. 236-243. <https://doi.org/10.5219/745>

Acknowledgments:

This study was kindly supported by a project of the internal grant agency of Tomas Bata University in Zlín, Czech Republic (IGA/FT/2017/004) funded from the resources of specific university research.

Contact address:

Richardos Nikolaos Salek, Department of Food Technology, Faculty of Technology, Tomas Bata University in Zlín, T. G. Masaryka 5555, 760 01, Zlín, Czech Republic, E-mail: rsalek@ft.utb.cz

Iva Burešová, Department of Food Technology, Faculty of Technology, Tomas Bata University in Zlín, T. G.

Masaryka 5555, 760 01, Zlín, Czech Republic, E-mail: buresova@ft.utb.cz

Stanislav Kráčmar, College of Business and Hotel Management, Bosonožská 9, 625 00 Brno, Czech Republic, E-mail: standa1948@gmail.com

Eva Lorencová, Department of Food Technology, Faculty of Technology, Tomas Bata University in Zlín, T. G. Masaryka 5555, 760 01, Zlín, Czech Republic, E-mail: lorencova@ft.utb.cz

Ludmila Zálešáková, Department of Food Technology, Faculty of Technology, Tomas Bata University in Zlín, T. G. Masaryka 5555, 760 01, Zlín, Czech Republic, E-mail: lzalesakova@ft.utb.cz

Vikendra Dabash Department of Food Technology, Faculty of Technology, Tomas Bata University in Zlín, T. G. Masaryka 5555, 760 01, Zlín, Czech Republic, E-mail: vikendradabash@rediffmail.com



VERIFICATION OF ANIMAL SPECIES IN HAM AND SALAMI BY DNA MICROARRAY AND REAL TIME PCR METHODS

Zuzana Drdolová, Jozef Golian, Jozef Čurlej, Lenka Maršalková

ABSTRACT

Consumer protection and detecting of adulteration is very important and has a wide societal impact in the economic sphere. Detection of animal species in meat products and the use of combining different methods is one of the means to achieve relevant product status. The aim of this study was to reveal whether or not the products label clearly meets the content declared by producer. In our study, 29 samples of meat products such as salami and ham obtained from stores and supermarkets in Slovakia were analyzed to detect the existing animal species according to the product label the use of Chipron LCD Array Analysis System, Meat 5.0. Products in which the presence of non-declared animal species has been detected were subjected to testing by the innuDETECT PCR Real-Time Kit, repeatedly. The results showed that 20 (68.96%) samples were improperly labeled. From in total 14 tested ham samples 11 (78.57%) products exhibited non-conformity with declared composition. Tested salami samples (15) revealed 9 (60%) incorrectly labelled products. The results obtained by DNA Microarray and Real Time PCR methods were identical, and both methods should be extensively promoted for the detection of animal species in the meat and meat products.

Keywords: Ham; Salami; DNA Microarray; RT-PCR; meat

INTRODUCTION

Consumers require clear and accurate information to make the decision in personal diet. Consumer choice might reflect lifestyle, religious concerns, or health status. Therefore, the description and labelling of food must be based on the true. The information that must be given is defined by the current legislation of developed countries; the food must be authentic and not misdescribed (Woolfe and Primrose, 2004).

The adulteration of food is associated with food quality. Verification of genuineness of certain products is a necessary part of a comprehensive examination of quality with regard to consumer protection (Maršalková et al., 2014). Considering the recent cases of meat adulteration and fraud, efficient and accurate analytical methods are essential for identification of meat species as a key importance to maintain consumer trust and to comply with labelling legislations (Cottenet, 2016).

Meat products usually contain meats of various origin, this should meets the producer declaration posted on the product label (Mašlej, Golian and Maršalková, 2014). In this way, meat authenticity not only relates to industrial economic profit resulting from illegal trading, handling or substitution of species, but also to public health risks such as zoonoses or allergenicity to specific meat protein. In this context, wild game meats may originate from farms having regulated hygienic standards and fair commercial

practices (Hoffman and Wiklund, 2006; Fajardo et al., 2010). Following the horse meat crisis which spread throughout Europe in 2013, food fraud and adulteration are identified as a top priority addressed by authorities, regulators and food industries (Elliott, 2014, Cottenet et al., 2016). Economically motivated adulteration presents many challenges because perpetrators are specifically seeking to avoid detection and circumvent existing regulatory systems or testing methodologies (Everstine, Spink and Kennedy, 2013; Cottenet et al., 2016).

The application of quality assurance systems through the food chain requires the development of reliable and simple tools, which facilitate routine control assessments. The detection of meat species in various food products deserves special attention due to the recent crisis in the meat sector (Brodmann and Moor, 2003; Saez, Sanz and Toldrá 2004). As a consequence of the tremendous profit that results from selling cheaper meat as meat from more profitable and desirable species, fraudulent misdescription of game meat products is becoming a common practice among unscrupulous processors who apply deceptive practices on their products (Brodmann et al., 2001; Fajardo et al., 2010).

In the last years, the attention has been paid towards implementation of molecular genetic approaches for meat species identification due to their high sensitivity and

specificity, as well as rapid processing time and low costs (Fajardo et al., 2010).

Furthermore, DNA analysis presents an attractive strategy for meat species identification. In comparison with protein detection, DNA is stable against technological treatments and independent of the considered tissue (Martinez and Yman, 1998; Wolf, Rentsch and Hübner 1999; Saez, Sanz and Toldrá 2004).

Real-Time PCR and DNA chip technique in detection of animal species are well suited for rapid screening of meat products in a routine analytical laboratory. However, the DNA Chip offers additional advantage, undeclared and unknown animal species presented in meat products, resulting from contamination or deliberate adulteration, can be detected (Iwobi et al., 2011).

In our study, 29 samples of meat products (salami and ham) reached from stores and supermarkets in Slovakia were analyzed to detect animal species according to product label by using Chipron LCD Array Analysis System, Meat 5.0. Those products where the presence of unlabel animal species was detected have been subjected to innuDETECT PCR Real-Time test.

In recent time, numbers of food products have been revidel as fraud products, where their label is not follow the statement provided by the producer. Real Time PCR and Microarray technics presents a usefull tool in the elimination of deep-laid business practices. Their reliability and above mentioned theory have been confirmed by our study on tested products.

MATERIAL AND METHODOLOGY

The collected samples, hams and salami were placed in sterile refrigerated container under 8 °C for sample preparation and DNA isolation. The pieces taken by disposable scalpel were placed into Eppendorf tubes. DNA was extracted according to innuPREP DNA Mini Kit (Catalog no: 845-KS-1040250) user guide. The extracted samples of DNA were stored at -18 °C.

The extracted DNA samples were amplified by PCR (Toptical Gradient 96) following the manufacturer requirements of Chipron LCD Array Kit Meat 5.0 (Chipron GmbH, Germany). Since the kit was ready to use, 12.5 µL of Chipron 2x Master mix, 1.5 µL of Primer Mix MEAT and 6 µL of PCR grade water were added into Eppendorf tube. The volume of 25 µL from prepared solution was pipetted to each of the plate well following

addition of 5 µl of the DNA template. The plate was closed and installed into the cycler. Thermal processing was setted to 1 cycle at 95 °C for 5 min, then 35 cycles at 94 °C for 30 sec, 57 °C for 45 sec, 72 °C for 45 sec, and finally 72 °C for 2 min (Chipron, 2014).

Twenty two microliter of hybridization buffer and 2 µl of modulator solution were added into Eppendorf tube. This mixture was pipetted in the volume 24 µl to each of the plate well following the addition of 10 µL of PRC product from extracted DNA samples. Chip from the kit was placed in the chip box, incubation of the slide was provided under 35 °C for 30 minutes in humidity chamber. We prepared 3 wash containers filled with 150 ml of washing solution. Slide was incubated and 28 µL from each plate well was pipetted onto the lower left hand corner for each of the eight patterns. Chip box was closed, incubated at 35 °C for 30 min, washed, dried, and then placed in the box again. Putting the dilution solution into the Eppendorf tube, 30 µl of annealing solution was pipetted into each of the patterns of the chip and allowed to standby for 5 min.

After the incubation washing procedure was done, and chip was centrifuged for 15 sec, allowed to dry, and placed in the box again. Twenty seven microliter of dilution buffer, 3 µL modulator and 0.2 µL label were aplicated on eight patterns on the slide and the slide was incubated at room temperature for 5 minutes. Washing buffer was replaced in all containers and washing procedure was repeated. Slide was dried by spinning for 10 seconds in the CHIP Spin FVL2400N (Catalog no: HS-500-01). Twenty eighth microliters of staining solution were added into each of the patterns of the chip, and the chip was allowed to standby for 5 min in room conditions. Following staining procedure, it was kept in washing cointainer for 1 minute, and then centrifuged for 10 sec for drying (Chipron, 2014).

Evaluation of the Results

Chipron LCD Array System can detect cattle, sheep, equine, goat, camels, buffalo, pork, kangaroo, hare, rabbit, reindeer, roe deer, red deer, fallow deer, springbok, dog, cat, chicken, turkey, goose, ostrich, mallard duck, muscovy duck, pheasant in tested sample. The detection in this system is based on specific sites within 16S rRNA mitochondrial locus of all meat species in analyzed food sample. A dark precipitate is formed by the enzyme

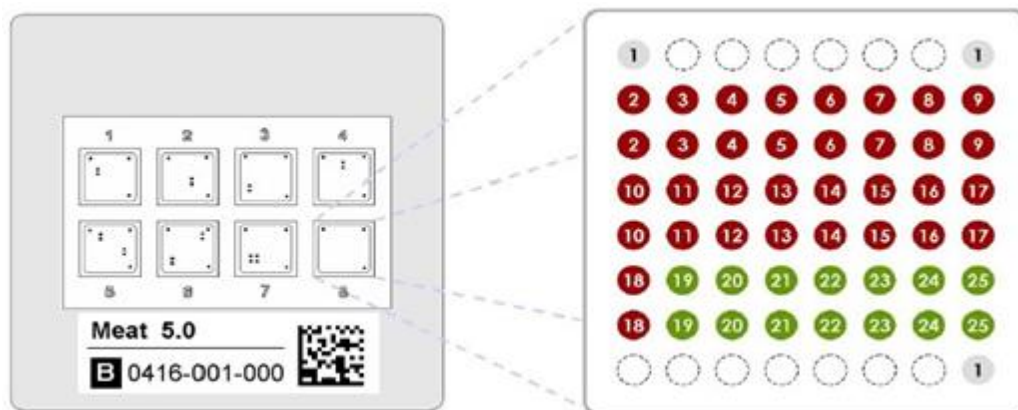

Figure 1. Chipron LCD Array System

Table 1 Capture probes Chipron Meat 5.0 LCD Kit.

Well No	Probe	Specificity	Well No	Probe	Specificity
01			Hyb-Ctrl		
02	Cattle	<i>Bos taurus, Bos bison</i>	14	Red deer	<i>Cervus elaphus</i>
03	Sheep	<i>Ovis aries</i>	15	Fallow deer	<i>Dama dama</i>
04	Equine	<i>Equus caballus, E. asinus</i>	16	Springbok	<i>Antidorcas marsupialis</i>
05	Goat	<i>Capra hircus</i>	17	Canine	<i>Canis sp.</i>
06	Camel	<i>Camelus sp.</i>	18	Cat	<i>Felis silvestris</i>
07	Water buffalo	<i>Bubalus bubalis</i>	19	Chicken	<i>Gallus gallus</i>
08	Pork	<i>Sus scrofa</i>	20	Turkey	<i>Meleagris gallopavo</i>
09	Kangaroo	<i>Macropus rufus / giganteus</i>	21	Goose	<i>Anser sp.</i>
10	Hare	<i>Lepus europaeus</i>	22	Ostrich	<i>Struthio camelus</i>
11	Rabbit	<i>Oryctolagus cuniculus</i>	23	Mallard Duck	<i>Anas platyrhynchos</i>
12	Rein deer	<i>Rangifer tarandus</i>	24	Muscovy Duck	<i>Cairina moschata</i>
13	Roe deer	<i>Capreolus capreolus</i>	25	Pheasant	<i>Phasianus sp.</i>

substrate provided in the test kit, and it indicates a positive hybridization reaction. After staining procedure completed chip was read with the scanner, and analysis was done by the software from the “Analysis-Package” provided by Chipron. Three different spots on the chip are called the control points to detect a positive reaction which are located in upper-left, upper right and lower right corners.

If no control spots occur, the test should be repeated. The animal species were identified using Slide Scanner (Catalog no: HS-300-01), Slide Reader Software (Catalog no: HS-200-01) (Table 1).

Samples analysed by DNA Microarray method were verified by Real Time PCR method (innuDETECT Assay).

The DNA previously isolated by using innuPREP DNA Mini Kit (Catalog no: 845-KS-1040250) stored at -18 °C was used. The procedure given by innuDETECT Assay was followed up. Positive and negative controls were run. All solutions and materials in the kit were dissolved before the use. Twenty microliters of PCR master mix including 10 µL of PCR, 2x master mix, 3 µL primer/probe mix, 1 µL internal control and 3 µL PCR-grade water was pipetted into each of the plate well. Three microliters of previously extracted DNA were added onto each.

The tubes were closed tightly and placed in LightCycler 2.0. The thermal processing was designed as one cycle at 95 °C for 120 sec, then 35 cycles at 95 °C for 10 sec and 62 °C for 45 sec. The analysis was done by the LightCycler 2.0 software.

RESULTS AND DISCUSSION

The results obtained by DNA Microarray indicated that 20 (68.96%) samples were improperly labeled. Adulteration was made according to the notifications on the label. From tested ham samples 11 (78.57%) products exhibited non-conformity with declared composition of the product from analyzed samples. In the second analyzed category 9 (60%) from 15 of analyzed salami samples were labelled incorrectly (Table 2, Table 3). The presence of several unlabeled species has been identified in the products. The results obtained by DNA Microarray and Real Time PCR methods were identical, both methods should be extensively promoted for the detection of animal species in the meat and meat products, these findings are in accordance with Özpınar et al. (2013).

DNA Microarray indicated that 39 out of 73 samples (53.4%) were labelled incorrectly, and adulteration was made in contrary to the notifications on the label. The adulteration was detected mostly in meat balls (87.5%), ground meat (72.7%), salami (57.1%), sausages (50%) and fermented sausages (30.3%), respectively.

It was mostly seen that meat balls and ground meat have significantly potential risk for adulteration. Following them fermented

The adulteration was detected mostly in meat balls (87.5%), ground meat (72.7%), salami (57.1%), sausages (50%) and fermented sausages (30.3%). It was found that meat balls and ground meat significantly have potential risk for adulteration. Following them fermented sausage

Table 2 Authentication of meat species in ham.

No	Describe of sample	Beef		Pork		Chicken		Turkey	
		Chipron Meat 5.0 LCD Kit	PCR- RT	Chipron Meat 5.0 LCD Kit	PCR- RT	Chipron Meat 5.0 LCD Kit	PCR- RT	Chipron Meat 5.0 LCD Kit	PCR- RT
1	pork 60%	-	-	+	+	-	-	-	-
2	pork 70%	-/+	-/+	+	+	-/+	-/+	-/+	-/+
3	pork 96%	-	-	+	+	-	-	-	-
4	pork 97%	-	-	+	+	-	-	-/+	-/+
5	turkey 31%, chicken 30%	-	-	-/+	-/+	+	+	+	+
6	chicken 63%	-	-	-/+	-/+	+	+	-/+	-/+
7	pork 92%	-	-	+	+	-/+	-/+	-	-
8	pork 51%, pork natural protein	-/+	-/+	+	+	-/+	-/+	-/+	-/+
9	pork 65%, pork natural protein	-	-	+	+	-/+	-/+	-	-
10	pork 90%,	-/+	-/+	+	+	-	-	-	-
11	pork 87%,	-	-	+	+	-/+	-/+	-/+	-/+
12	pork 65%,	-	-	+	+	-/+	-/+	-	-
13	pork 70%, pork natural protein, hemoglobin	-	-	+	+	-	-	-	-
14	turkey 64%	-	-	-/+	-/+	-/+	-/+	+	+

Note: +/- declared, absent; -/+ undeclared, present; + declared, present, - undeclared, absent

samples showed incorrect labelling with the range of 30%. On the other hand, mentioned types of food claimed 100% beef on the labels. Hence, species detected in meat ball, ground meat and fermented sausage samples were presented by chicken, turkey and sheep species. Pig and equine species were not detected in 79 samples.

The fraudulent misdescription of food contents declared product labels is a widespread problem, particularly with value products of premium price. In respect of this detection and quantification of food constituents is required. As they are often biochemically similar to the materials they replace, their identification and measurement is extremely difficult (Woolfe and Primrose, 2004).

DNA Microarray and Real Time PCR offer detection of animal species in one reaction. Common similarity between them is the step of DNA isolation. Microarray Analysis enable the detection of more than one species in one reaction whereas Real Time PCR requires specially designed primers and probes needed for amplification of specially selected DNAs regions belonging to different species. This difference means longer time needed for the optimization step of primers and probes (Myers et al., 2010, Özpınar et al., 2013). DNA Microarray can deliver the results faster and more sensitive using amplified DNA in comparison to conventional PCR technique (Azuky et al., 2011). Polymerase chain reaction (PCR) is commonly

used technique in many fields of molecular biology due to its sensitivity, specificity and capability to detect even a single copy of DNA sequence from a single cell sample (Chikuni et al., 1994).

DNA Microarray as a method has been widely preferred for understanding mechanisms, detection of foodborne microbial pathogens and food safety studies, nutraceuticals and functional foods as well as following up the different expression levels of DNA in bacteria, yeasts, plants and human; genetic and mutation analyses; environmental studies; identification of antimicrobial genes, proteomics, protein-nucleic acids, protein-protein interactions, biochemical analysis of protein functions and drug development (Bottero and Dalmaso, 2010; Kostrzynska and Bachand, 2006). A study done in USA indicated that 62% of meat products had only one foreign species, 36% had two, and 2% had three. A similar study in the States also showed that the adulteration ratio has increased up to 46.4% (Macedo-Siva et al., 2000, Özpınar et al., 2013). In Brasil commercial samples of swine hamburgers showed no adulteration with bovine, chicken, swine or horse meats, and expectation of hamburger adulteration was not confirmed (Özpınar et al., 2013).

Table 3 Authentication of the meat in salami.

No	Describe of sample	Beef		Pork		Chicken		Turkey	
		Chipron Meat 5.0 LCD Kit	PCR-RT	Chipron Meat 5.0 LCD Kit	PCR-RT	Chipron Meat 5.0 LCD Kit	PCR-RT	Chipron Meat 5.0 LCD Kit	PCR-RT
1	beef and pork 70%	-	-	+	+	-	-	-	-
2	beef and pork 88%	+	+	+	+	-	-	-/+	-/+
3	pork 70%, pork natural protein	-	-	+	+	-	-	-	-
4	pork 89%, hemoglobin	-	-	+	+	-	-	-	-
5	pork 60%, pork natural protein	-	-	+	+	-	-	-	-
6	port and beef 56%, pork natural protein	+	+	+	+	-/+	-/+	-/+	-/+
7	pork and beef 65%, pork natural protein	+/-	+/-	+	+	-	-	-	-
8	pork and beef 58%, pork natural protein	+/-	+/-	+	+	-	-	-	-
9	pork 48 %, beef 5 %,	+	+	+	+	-	-	-	-
10	pork and beef 93%, pork hemoglobin	+	+	+	+	-	-	-	-
11	turkey 40%	-	-	-/+	-/+	-	-	+	+
12	chicken, pork bacon, hemoglobin	-	-	+	+	+	+	-/+	-/+
13	pork 42.3%, beef 25.8%, pork bacon 23.4%	+	+	+	+	-/+	-/+	-	-
14	pork	-/+	-/+	+	+	-/+	-/+	-	-
15	pork	-/+	-/+	+	+	-/+	-/+	-	-

CONCLUSION

In conclusion, adulteration is a serious global problem in food industry. Regular controls are necessary to ensure food security. It was found that the results obtained by DNA Microarray and Real Time PCR assays were identical with each other, and both methods should extensively be promoted for the detection of animal species in meat products.

REFERENCES

Azuka, I., Ingrid, H., Georg, H., Andreas, M., Ulrich, B. 2011. Biochip technology for the detection of animal species in meat products. *Food Analytical Methods*, vol. 4, no. 3, p. 389-398. <https://doi.org/10.1007/s12161-010-9178-9>
 Bottero, M. T., Dalmaso, A. 2010. Animal species identification in food products: Evolution of biomolecular methods. *Veterinary Journal*, vol. 190, no. 1, p. 34-8.

<https://doi.org/10.1016/j.tvjl.2010.09.024>

[PMid:21041103](#)

Brodmann, P. D., Moor, D. 2003. Sensitive and semi-quantitative TaqMan™ real-time polymerase chain reaction systems for the detection of beef (*Bos Taurus*) and the detection of the family Mammalian in food and feed. *Meat Science*, vol. 65, no. 1, p. 599-607. [https://doi.org/10.1016/S0309-1740\(02\)00253-X](https://doi.org/10.1016/S0309-1740(02)00253-X)

Brodmann, P. D., Nicholas, G., Schaltenbrand, P., Ilg, E. C. 2001. Identifying unknown game species: experience with nucleotide sequencing of the mitochondrial cytochrome b gene and a subsequent basic local alignment search tool search. *European Food Research Technology*, vol. 212, no. 4, p. 491-496. <https://doi.org/10.1007/s002170000284>

Chikuni, K., Tabata, T., Kosugiyama, M., Monma, M. 1994. Polymerase chain reaction assay for detection of sheep and goat meats. *Meat Science*, vol. 37, no. 3, p. 337-345. [https://doi.org/10.1016/0309-1740\(94\)90051-5](https://doi.org/10.1016/0309-1740(94)90051-5)

Chipron: Meat 5.0 LCD Array Kit, DNA-based identification of Animal species. 2014. User Guide for Application [online] s.a. [cit. 2017-07-02] Available at: <http://www.peramed.com/peramed/docs/Manual%20MEAT%205.0%20Vers.1.1-2014.pdf>.

Cottenet, G., Sonnard, V., Blancpain, C., Zhen Ho, H., Lum Leong, H., Fong Chuah, P. 2016. A DNA macro-array to simultaneously identify 32 meat species in food samples. *Food control*, vol. 67, no., p.135-143.

Elliott, C. 2014. Elliott review into the integrity and assurance of food supply networks: final report national food crime prevention framework. Food Standards Agency accessed 22.04.15 [online] s.a. [cit. 2017-07-02] Available at: <https://www.gov.uk/government/publications/elliott-review-into-the-integrity-and-assurance-of-food-supply-networks-final-report>.

Everstine, K., Spink, J., Kennedy, S. 2013. Economically motivated adulteration (EMA) of food: common characteristics of EMA incidents. *Journal of Food Protection*, vol. 76, p. 723-735. <https://doi.org/10.4315/0362-028X.JFP-12-399>
[PMid:23575142](#)

Fajardo, V., González, I., Rojas, M., García, T., Martín, R. 2010. A review of current PCR-based methodologies for the authentication of meats from game animal species. *Trends in Food Science & Technology*, vol. 21, no. 8, p. 408-421. <https://doi.org/10.1016/j.tifs.2010.06.002>

Hoffman, L. C., Wiklund, E. 2006. Game and venison – meat for the modern consumer. *Meat Science*, vol. 74, no. 1, p.197-208. <https://doi.org/10.1016/j.meatsci.2006.04.005>
[PMid:22062729](#)

Iwobi, A. N., Huber, I., Hauner, G., Miller, A., Busch, U. 2011. Biochip Technology for the Detection of Animal Species in Meat Products. *Food Analytical Methods*, vol. 4, no. 3, p. 389-3898. <https://doi.org/10.1007/s12161-010-9178-9>

Kostrzynska, M., Bachand, A. 2006. Application of DNA microarray technology for detection, identification, and characterization of food-borne pathogens. *Canadian Journal of Microbiology*, no. 52, no. 1, p. 1-8.

Macedo-Siva, A., Barbosa, S. F. C., Aklim, M. G. A., Vaz, A. J., Shimokomaki, V., Tenuta-Filho, A. 2000. Hamburger meat identification by dot-ELISA. *Meat Science*, vol. 56, no. 2, p. 189-192. [https://doi.org/10.1016/S0309-1740\(00\)00039-5](https://doi.org/10.1016/S0309-1740(00)00039-5)

Maršalková, L., Mašlej, M., Belej, L., Golian, J., Židek, R. 2014. Determination of the species specificity of the primers for the detection of chicken and turkey meat by realtime PCR method. *Potravinárstvo*, vol. 8, no. 1, p. 216-220. <https://doi.org/10.5219/390>

Martinez, I., Yman, M. I. 1998. Species identification in meat products by RAPD analysis. *Food Research International*, vol. 31, no. 6-7, p. 459-466. [https://doi.org/10.1016/S0963-9969\(99\)00013-7](https://doi.org/10.1016/S0963-9969(99)00013-7)

Mašlej, M., Golian, J., Maršalková, L. 2014. Determining the presence of chicken and turkey meat in selected meat in selected meat products using real time pcr method. *Potravinárstvo*, vol. 8, no. 1, p. 267-271. <http://doi.org/10.5219/393>

Myers, M. J., Farrell, D. E., Deaver, C. M., Mason, J., Swaim, H. L., Yancy, H. F. 2010. Detection of rendered meat and bone meals by PCR is dependent on animal species of origin and DNA extraction method. *Journal of Food Protein*, vol. 73 no. 6, p. 1090-1006. <https://doi.org/10.4315/0362-028X-73.6.1090>
[PMid:20537265](#)

Özpinar, H., Tezmen, G., Gökçe, I., Tekiner, I. 2013. Detection of Animal Species in Some Meat and Meat Products by Comparatively Using DNA Microarray and Real Time PCR Methods. *Kafkas Üniversitesi Veteriner Fakültesi Dergisi*, vol. 19, no. 2, p. 245-252.

Saez, R., Sanz Y., Toldrá, F. 2004. PCR-based fingerprinting techniques for rapid detection of animal species in meat products. *Meat Science*, vol. 66, no. 3, p. 659-665. [https://doi.org/10.1016/S0309-1740\(03\)00186-4](https://doi.org/10.1016/S0309-1740(03)00186-4)

Wolf, C., Rentsch, J., Hübner, P. 1999. PCR-RFLP analysis of mitochondrial DNA: a reliable method for species identification. *Journal of Agricultural and Food Chemistry*, vol. 47, no. 4, p. 1350-1355. <https://doi.org/10.1021/jf9808426>
[PMid:10563979](#)

Woodliffe, M., Primrose, S. 2004. Food forensics: using DNA technology to combat misdescription and fraud. *Trends in Biotechnology*, vol. 22, no. 5, p. 222-226. <https://doi.org/10.1016/j.tibtech.2004.03.010>
[PMid:15109807](#)

Acknowledgments:

This work was supported by grant VEGA No. 1/0316/15.

Contact address:

Ing. Zuzana Drdolová, Slovak University of Agriculture, Faculty of Biotechnology and Food Sciences, Department of Hygiene and Food Safety, Tr. A. Hlinku 2, 949 76 Nitra, Slovakia, E-mail: drdolova.zuzana@gmail.com

prof. Ing. Jozef Golian, Dr., Slovak University of Agriculture, Faculty of Biotechnology and Food Sciences, Department of Hygiene and Food Safety, Tr. A. Hlinku 2, 949 76 Nitra, Slovakia, E-mail: jozef.golian@uniag.sk

Ing. Jozef Čurlej, PhD., Slovak University of Agriculture, Faculty of Biotechnology and Food Sciences, Department of Hygiene and Food Safety, Tr. A. Hlinku 2, 949 76 Nitra, Slovakia, E-mail: jozef.curlej@uniag.sk

Ing. Lenka Maršalková, PhD., Slovak University of Agriculture, Faculty of Biotechnology and Food Sciences, Department of Hygiene and Food Safety, Tr. A. Hlinku 2, 949 76 Nitra, Slovakia, E-mail: marsalkova@gmail.com

EFFECT OF THERMAL TREATMENT ON RUTIN CONTENT IN SELECTED BUCKWHEAT PRODUCTS USING CALCIUM AS AN INTERNAL TRACER

Eliška Krejzová, Miroslava Bittová, Stanislav Kráčmar, Petra Vojtíšková,

Vlastimil Kubáň, Jozef Golian

ABSTRACT

Reversed-phase high-performance liquid chromatography (RP-HPLC) was used for rutin (quercetin-3-rutinoside) determination in selected buckwheat products (whole meal flour, broken seeds, seed hulls, herbs and baked cereal breads). The effect of various thermal procedures on content of rutin was evaluated using calcium as an internal tracker to correct changes in mass and composition of the buckwheat products. These factors are very seldom taken into account. The results show non-significant changes in rutin levels obtained in whole meal flour and broken seed samples after thermal treatment up to 150°C. Higher temperature already caused sudden fall in the observed rutin concentrations. The evaporation of some volatile compounds and degradation products can decrease the mass of the samples and formally increase the content of rutin (35.5 ± 4.7 mg per 100 g for whole meal flour and 10.2 ± 0.4 mg per 100 g for broken seeds at 150°C). Serious decrease of rutin contents at elevated temperatures (>150°C) can be explained by its degradation (by breaking off the C-C bond in quercetin-3-rutinoside moiety) and/or evaporation (24.3 ± 1.4 mg per 100 g for whole meal flour and 3.06 ± 0.3 mg per 100 g for broken seeds at 180°C). In case of baked cereal breads the level of rutin changed in dependence on the ratio between buckwheat and corn flour. Longer time leaching and higher temperature implicate higher rutin content in infusions prepared from buckwheat seed hulls and herbs.

Keywords: rutin; buckwheat; *Fagopyrum esculentum* Moench; effect of thermal treatment; calcium; internal tracer

INTRODUCTION

Basic chemical composition of nutritionally important plants differs with respect to its origin, vegetative cycle or growing conditions. As expected, the level of biologically active compounds is directly influenced by many factors such as weather, maturing, stress or fertilization. However, indispensable influence is also caused by technological processes for food production and/or culinary practices.

Various treatment processes have significant effects on chemical composition of food matrix. Degradation of thermo labile compounds and evaporation of volatile compounds (organic compounds, alkylated metals etc.) can cause losses of mass of the matrices. On the other hand, absorption of water, frying oil, oxidation processes and other reactions among constituents can increase the mass of matrix. Technological and/or culinary procedures also influence accuracy (overestimate or underestimate) of the final results. Thus, the presence of internal/external tracers in a sample matrix could be applied to correct the changes in mass (volume) and/or composition of the matrix.

Rutin, a representative of flavonoids, is synthesized in higher plants as a response on stress invoked by diseases,

predators or ultraviolet radiation. It was recognized that rutin (quercetin-3-rutinoside) has significant anti-carcinogenic and anti-inflammatory properties (Sharma et al., 2013), acts as α -glucoside inhibitor (Li et al., 2009) and shows lipid peroxidation and antioxidant activity. More, rutin antagonizes the increase of capillary fragility associated with hemorrhagic disease or hypertension in humans (Shanno, 1946). It also decreases the permeability of the blood vessels and has an anti-oedema effect, reduces the risk of arteriosclerosis. Nowadays, rutin has been revealed as a very interest constituent of functional foods. Common buckwheat (*Fagopyrum esculentum* Moench) and tartary buckwheat (*Fagopyrum tataricum*) are well-known as nutritious gluten-free ingredient and very valuable pseudocereal sources of rutin (Zhang et al., 2012; Ahmed et al., 2014).

Generally, buckwheat is a rich source of phenolic acids and polyphenolic compounds (Guo et al., 2011; Inglett et al., 2011; Guo et al., 2012). Several papers are focused on evaluation of nutrient quality, antioxidant properties and rutin content in various foodstuff enriched with buckwheat flour such as instant noodles (Choy et al., 2013) or cereal

bread (Lin et al., 2009). The effect of pseudocereal flour addition to antioxidant properties and sensory value of breads was also studied in Chlopicka et al. (2012). Content of rutin in buckwheat raw material and some food product was deeply investigated by Kreft et al. (2006). Fessas et al. (2008) evaluated nutritional properties of wheat and buckwheat flour (namely polysaccharides and proteins composition) by thermogravimetry and differential scanning calorimetry. They showed how dehulling step and addition of buckwheat fraction affect crumb structure and bread properties.

Technological and/or culinary treatments influence food product properties such as hardness, integrity, color and/or representation of analytes. As showed in Blanszczak et al. (2013), high-pressure treatment of buckwheat groats resulted in decreasing nearly 20% of antioxidant activity and rutin loses almost 50% in comparison with raw material. Pressured-steam heating, roasting and microwave irradiation heating were applied to whole meal flour processing and the effect on polyphenolic content was followed in Zhang et al. (2010). Similarly, Zielinski et al. (2009) evaluated the effect of roasting on antioxidants of buckwheat seeds and Vogrincic et al. (2010) studied losses of rutin and other polyphenolic compounds caused by bread baking procedure. They also followed changes in antioxidant activity of bread samples prepared by mixing of buckwheat and wheat flour. Other studies, reported by Biney a Beta (2014) and Verardo et al. (2011) illustrated effect of cooking of buckwheat pasta to antioxidant properties and amount of phenolic compounds. In all mentioned publications related with thermal treatment authors observed significant decrease of antioxidant characteristics and losses of phenolic compounds content.

Basic chemical composition of products studied in this work has been previously described in Vojtišková et al. (2014). The aim of this study was to evaluate effect of various thermal treatment procedures on rutin content in selected products (cereal breads, whole meal flour, broken seeds, seed hulls and herbs) made from common buckwheat (*Fagopyrum esculentum* Moench) cultivated in the Czech Republic. Applications of calcium as an internal tracer to compensate the changes in mass (volume) and/or composition of the matrix were also tested.

Statistical hypothesis

Thermal procedures has an significant effect on rutin content in selected products.

MATERIAL AND METHODOLOGY

2.1. Sample preparation

Selected buckwheat products were made from common buckwheat (*Fagopyrum esculentum* Moench) cultivated in the region of Slezské Rudoltice, Czech Republic. Baking of breads was realized on 300 g flour samples (mixtures of corn and buckwheat flours from 0% up to 100% with steps of 10%) applying high speed dough mixing and a short fermentation time. Dough was prepared from flour (up to 100%), 1.5% dry yeast, 1.5% salt, 1.9% sugar and 0.005% ascorbic acid with addition of water to optimum consistency. Baking of breads was realized in accordance with ICC Standard No. 131 (ICC, 1980). The final breads were dried, ground to a fine powder and sieved through 1 mm mesh. Buckwheat whole meal flour, broken seeds,

seed hulls and buckwheat herbs were obtained from Pohankový mlýn Šmajstrla (Frenštát p. R., Czech Republic).

2.2 Chemicals

Acetonitrile (ACN), methanol (both Chromasolv, gradient grade) and Folin-Ciocalteu reagent were purchased from Sigma-Aldrich (Steinheim, Germany). Acetic acid was obtained from Penta (Chrudim, Czech Republic). Sodium carbonate, potassium persulphate and gallic acid from Lachema (Brno, Czech Republic) and 2,2'-azinobis(3-ethylbenzothiazoline-6-sulfonic acid), diammonium salt (ABTS) from Fluka (Steinheim, Germany) were used. Rutin hydrate was purchased from Dr. Ehrenstorfer GmbH (Ausburg, Germany). All used reagents were of the analytical grade and all solutions were prepared in double distilled water (Heraeus Quarzschmelze, Hanau, Germany).

2.3. Chromatographic method for rutin determination

HPLC method for rutin determination was based on Deineka et al. (2004). All experiments were carried out on Shimadzu 10AVP chromatographic system (Shimadzu, Tokyo, Japan) comprising a SCL-10AVP system controller, two LC-10AVP pumps, CTO-10ASVP column oven, Rheodyne 7120 injection valve (20 µL sample loop) and SPD-M10AVP photodiode-array detector and degasser GT-154. Analyses were provided using HPLC column Waters C18 (Waters Corp., Milford, MA, USA, 75 x 4.6 mm, 5 µm pore size). The temperature of column was set to 25°C. Mobile phase composed of 2% acetic acid, acetonitrile and methanol (75/15/10, v/v/v) was used under isocratic elution at the flow rate of 1 mL min⁻¹. Chromatograms were collected at 355 nm and evaluated using the VP-Class analytical software (version 6.13 SP2). Limit of detection for rutin was 0.06 µg mL⁻¹, limit of quantification was 0.2 µg mL⁻¹. Retention time of rutin was 3 min and all analyses were realized in triplicate.

2.4. Analysis of whole meal breads

Breads consisted of various buckwheat and corn flour ratios (100/0, 90/10, 80/20, 70/30, 60/40, 50/50, 40/60, 30/70, 20/80, and 10/90) were baked in accordance with ICC Standard No. 131 (ICC, 1980). The dehydrated breads were crushed, ground to a fine powder and sieved through 1 mm mesh. Weighed ground samples (2 g ±0.001 g) were extracted with acetic acid/methanol/water mixture (1/50/50, v/v/v). After sonication and shaking, test-tubes were centrifuged at 4000 rpm for 5 minutes and supernatant was filtrated through 0.45 µm filter (Millipore, Bedford, MA, USA) and analyzed for rutin content. The extracts were also used for spectrophotometric determination of total polyphenolic content and antioxidant activity. All spectrophotometric measurements were carried out on spectrophotometer UNICAM 5625 (Spectronic Unicam Cambridge, UK) in a quartz cuvette, 10 mm optical path.

2.4.1. Determination of total polyphenolic content

Total phenolic content (TPC) was measured according to Folin-Ciocalteu method (Singleton a Rossi, 1965). The procedure was as follows: 1.58 mL of distilled water was mixed in the test tubes with 0.1 mL of Folin-Ciocalteu

reagent and 0.02 mL of calibration standards (0, 50, 100, 250 and 500 mg L⁻¹ of gallic acid) or properly diluted extracts. After 5 minutes, 0.3 mL of sodium carbonate solution (200 g L⁻¹) was added and the mixtures were kept 2 hours in the dark at 20°C. The absorbance was measured three times against blank at 765 nm. The results were expressed as gallic acid equivalent (GAE) per 1 g of dry matter (DM).

2.4.2. Determination of total antioxidant activity

Antioxidant activity (TAA) measurements were carried out using ABTS reagent (Re et al., 1999). Standard stock solution of cation radical ABTS⁺ consisted of 7 mM ABTS and 2.4 mM potassium persulphate was mixed and 2 hours incubated at 50°C. The solution was 50-times diluted and used as working ABTS solution. Then, 1.99 mL of ABTS working solution was mixed in the test tubes with 0.01 mL of calibration standards of gallic acid (0, 25, 50, 100 and 250 mg L⁻¹) or suitably diluted samples. After 10 minutes, the absorbance was measured in triplicate at 734 nm against blank and the results were expressed as gallic acid equivalents (GAE) per 1 g of dry matter (DM).

2.5. Calcium as an internal tracer

Calcium as a non-volatile and most abundant element (Vojtíšková et al., 2014) was selected as an internal standard to correlate any changes in composition and in weight of the samples during the thermal treatment. Precisely weighed ground samples of wholemeal flour and broken seeds (0.3 to 0.5 g ±0.001 g) were decomposed in a microwave oven Ethos SEL (Milestone, Sorisole, Italy) using concentrated HNO₃ (5 mL conc. HNO₃ + 5 mL of deionized H₂O) at a temperature of 210°C for 30 min. The final solution was transferred into 25 mL volumetric flasks after cooling to a room temperature. The flasks were filled to the mark. Calcium contents as an internal standard were determined by flame AAS (acetylene-air) on an atomic absorption spectrometer AA 30 (Varian A.G., Australia) at 422.7 nm. Strontium nitrate at a concentration of 1 g L⁻¹ was used as a spectral buffer to suppress the flame emission. Concentrations were determined by the calibration curve method and the integration of peak area.

2.6. Thermal treatment of whole meal flour and broken seed

The influence of thermal treatment on rutin content was further studied with buckwheat flour and broken seeds. Precisely weighed samples of selected buckwheat products (0.5 ±0.001 g) were heated in a laboratory oven with temperature control on glass dishes. Small portions of samples (approximately 10 %) were taken at specific temperatures 25°C, 60°C, 90°C, 120°C, 150°C, 180°C and 210 °C in the time intervals of 20 min, extracted with 10 ml of mixture consisted of acetic acid:methanol:water (1:50:50, v/v/v). After cooling and shaking, the extracts were centrifuged and filtrated through 0.45 µm filter. The content of rutin was measured using HPLC method.

2.7. Thermal treatment of buckwheat seed hulls and herbs

Buckwheat seed hulls and herbs were analyzed as a material for tea preparation and the effect of water temperature and leaching time were evaluated. Precisely weighed samples (1 g ±0.001 g) of hulls and herbs were

mixed with 100 ml distilled water of 80°C, 90°C or 100°C. Water macerates were sampled in intervals 5, 10, 15 and 20 min, filtrated through 0.45 µm filter and analyzed by HPLC method.

2.8. Statistical evaluation

All results were statistically evaluated using the variation statistics (ANOVA, StatSoft, Prague, Czech Republic). Correlation matrices and regression functions were calculated using the statistical package Unistat, v. 5.5 (Unistat Ltd., England).

RESULTS AND DISCUSSION

3.1. Whole meal breads analysis

Kreft et al. (2006) in their study presented the value of rutin concentration in various buckwheat material and products such as dark flour (218.5 mg kg⁻¹) and light flour (112.8 mg kg⁻¹). We studied cereal breads consisted of various buckwheat and corn flour ratios. Depending on rising portion of buckwheat flour, increasing trend in rutin content was found (Figure 1). While in 10% buckwheat flour bread the concentration 2.7 ±0.2 mg per 100 g was observed, in 100% whole meal buckwheat flour bread the rutin concentration was 10-times higher (28.2 ±2.9 mg per 100 g). Convex form of the relationship between rutin concentration and content of buckwheat flour is evident over the 70/30 ratios.

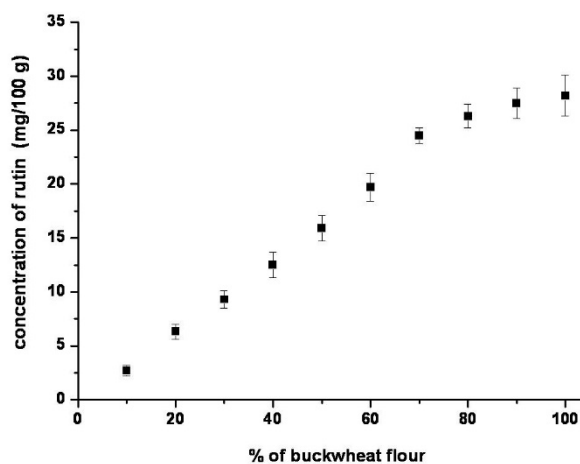

Figure 1 Content of rutin (mg/100g) in breads baked of various buckwheat and corn flour ratios

Total polyphenolic content (TPC) and total antioxidant activity (TAA) give information about expected antioxidant properties. As observed previously, addition of buckwheat flour to semolina flour significantly ($p < 0.001$) increase antioxidant properties and polyphenolic content (Biney et al., 2014). Similar trend $p < 0.001$ was noticed in our measurements. TAA was calculated as total activity of hydrophilic and lipophilic antioxidants using ABTS⁺ cation radical and the higher values of TPC and TAA were observed in samples with higher portion of buckwheat flour. However, observed trend did not correlate linearly with buckwheat flour content (Table 1) due to the more remarkable destruction of rutin in samples with higher contents of buckwheat flour.

Table 1 Total polyphenolic content (TPC) and total antioxidant activity (TAA) of buckwheat (F) and corn (S) flour mixture (F:S) expressed as gallic acid equivalent per 1 gram of dry matter (DM).

F:S	TPC	TAA
	mg GAE g ⁻¹ of DM	mg GAE g ⁻¹ of DM
100:0	3.95 ±0.02	4.16 ±0.04
90:10	3.81 ±0.02	4.09 ±0.02
80:20	3.63 ±0.02	3.38 ±0.04
70:30	3.03 ±0.02	2.42 ±0.05
60:40	2.88 ±0.05	2.36 ±0.02
50:50	2.53 ±0.05	2.05 ±0.05
40:60	2.26 ±0.02	1.57 ±0.02
30:70	1.67 ±0.02	1.18 ±0.04
20:80	1.38 ±0.07	0.91 ±0.02
10:90	1.23 ±0.05	0.97 ±0.05

3.2. Evaluation of thermal treatment on rutin content in whole meal flour and broken seed

The changes in rutin concentration after heating of whole meal flour and broken seeds are depicted in **Figure 2**.

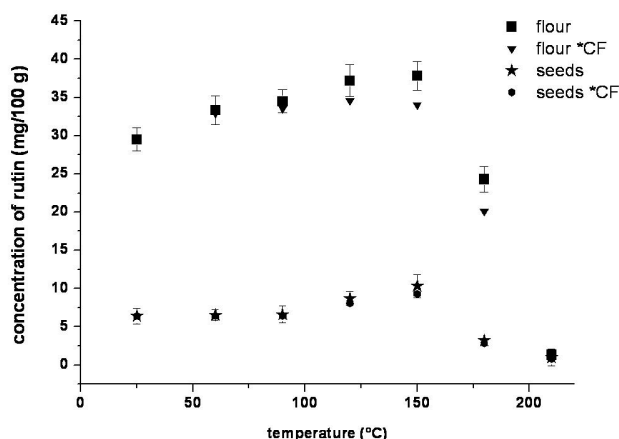

Figure 2 Effect of thermal treatment on rutin content in the whole meal flour and broken seeds. Corrected values correspond to the multiplying with corrected factor CF (25°C CF=1.00, 60°C CF=0.99, 90°C CF=0.97, 120°C CF=0.93, 150°C CF=0.90, 180°C CF=0.86 and 210°C CF=0.81)

Units or tens of mg of rutin per 100 g of buckwheat product samples were determined and approximately 5-times lower levels of rutin were found in broken seeds compare to whole meal flour ($p < 0.001$). Very steady increase of rutin content can be attributed to the destruction of the sample particles and easier extraction of rutin from their structure (the destruction is more evident especially in the case of broken seeds). Another reason can be explained by partial destruction of samples by overheating and degradation of some compounds of flour or seeds. The evaporation of some volatile compounds and degradation products can decrease the mass of the samples and formally increase the content of rutin (35.5 ±4.7 mg per 100 g for whole meal flour and 10.2 ±0.4 mg per 100 g for broken seeds at 150°C). Serious decrease of rutin contents at elevated temperatures (>150°C) can be explained by its degradation and/or evaporation (24.3 ±1.4 mg per 100 g for whole meal flour and 3.06 ±0.3 mg per 100 g for broken seeds at 180°C). Chromatograms of whole meal flour and broken seed extracts with peak of rutin are shown in **Figure 3**.

The changes in chemical composition and mass of heated samples can be compensated using correction factor (CF) that is equal to the ratio of calcium concentration at the start of heating (c_{Ca-0}) and calcium concentration at each heating temperature t (c_{Ca-t}), i.e. $CF = c_{Ca-0}/c_{Ca-t}$. The CF is equal to 1 at the lowest temperatures and it rises values <1 at the elevated temperatures for matrices with losses of mass or values >1 for matrices with increased mass. Multiplying the determined concentrations of rutin by CF we can compensate some changes in mass and chemical composition of matrices expecting thermal stability of calcium ions (CF equal to 1.00, 0.99, 0.97, 0.93, 0.90, 0.86 and 0.81 for 25°C, 60°C, 90°C, 120°C, 150°C, 180°C and 210°C, respectively).

3.3. Evaluation of thermal treatment of buckwheat seed hulls and herbs

More dissimilar results were obtained after boiling of seed hulls and herbs for preparation of buckwheat infusions. In comparison, rutin content detected in hulls was 100-times lower than in herbs ($p < 0.001$). It is in agreement with the findings of **Kreft et al. (2006)** and **Vojtišková et al. (2014)** that the leaves and flowers of

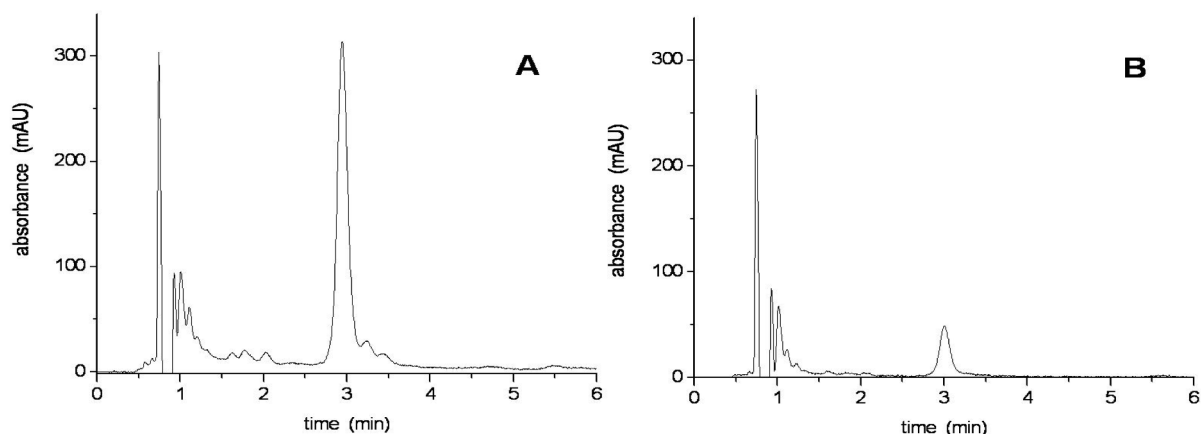

Figure 3 Chromatogram of the whole meal flour extract (A) and the broken seeds extracts (B) at 355 nm.

buckwheat plant are the richest sources of rutin. Observed amounts of rutin in seed hulls ranged from 7.2 mg per 100 g to 14.9 mg per 100 g while concentrations in buckwheat herbs infusions varied from 716 mg per 100 g to 1302 mg per 100 g. In both cases, increasing tendency related with warmer water and longer time of maceration (**Figure 4**) due to the higher efficacy of the maceration process.

CONCLUSION

Buckwheat for human nutrition is used in several forms. People use mainly seeds for making a gluten-free meal. Nowadays, a broad range of buckwheat products is available on a market, such as pasta, crunchy products, flour, tea (mixture of peels and milled aerial part of plants) *etc.* In this work, the highest content of rutin was obtained in tea prepared from buckwheat herbs while the lowest amount of rutin was determined in buckwheat broken seeds. Depending on increasing portion of buckwheat flour in cereal breads, nonlinear rising tendency in rutin content and antioxidant characteristics due to the more evident degradation of rutin was also observed. Serious decrease of rutin contents at elevated temperatures (>150°C) can be explained by its degradation and/or evaporation. Thus, classical mechanical milling must be preferred against thermal treatment and all cooking practices can avoid high temperature ($t > 100^\circ\text{C}$) treatment.

REFERENCES

- Ahmed, A., Khalid, N., Ahmad, A., Abbasi, N., Latif, M. S. Z., Randhawa M. A. 2014. Phytochemicals and biofunctional properties of buckwheat: A review. *J. Agr. Sci.*, vol. 152, p. 349-369. <http://dx.doi.org/10.1017/S0021859613000166>
- Biney, K., Beta, T. 2014. Phenolic profile and carbohydrate digestibility of durum spaghetti enriched with buckwheat flour and bran. *LWT - Food Sci. Technol.*, vol. 57, p. 569-579. <http://dx.doi.org/10.1016/j.lwt.2014.02.033>
- Blanszczak, W., Zielinska, D., Zielinski, H., Szawara-Nowak, D., Fornal, J. 2013. Antioxidant properties and rutin content of high pressure-treated raw and roasted buckwheat groats. *Food Bioprocess Tech.*, vol. 6, p. 92-100. <http://dx.doi.org/10.1007/s11947-011-0669-5>
- Chlopicka, J., Pasko, P., Gorinstein, S., Jedryas, A., Zagrodzki, P. 2012. Total phenolic and total flavonoid content, antioxidant activity and sensory evaluation of pseudocereal breads. *LWT - Food Sci. Technol.*, vol. 46, p. 548-555. <http://dx.doi.org/10.1016/j.lwt.2011.11.009>
- Deineka, V. I., Grigorev, A. M., Staroverov, V. M. 2004. HPLC analysis of flavonoids: determining rutin in plant extracts. *Pharm. Chem. J.*, vol. 38, p. 23-25. <http://dx.doi.org/10.1007/s11094-004-0004-9>
- Choy, A. L., Morrison, P. D., Hughes, J. G., Marriott, P. J., Small, D. M. 2013. Quality and antioxidant properties of instant noodles enhanced with common buckwheat flour. *J. Cereal Sci.*, vol. 57, p. 281-287. <http://dx.doi.org/10.1016/j.jcs.2012.11.007>
- Fessas, D., Signorelli, M., Pagani, A., Mariotti, M., Iametti, S., Schiraldi, A. 2008. Guidelines for buckwheat enriched bread – thermal analysis approach. *J. Therm. Anal. Calorim.*, vol. 91, p. 9-16. <http://dx.doi.org/10.1007/s10973-007-8594-6>
- Guo, X. D., Ma, Y. J., Parry, J., Gao, J. M., Yu, L. L., Wang, M. 2011. Phenolics content and antioxidant activity of tartary buckwheat from different locations. *Molecules*, vol. 16, p. 9850-9867. <http://dx.doi.org/10.3390/molecules16129850>
- Guo, X. D., Wu, Ch. S., Ma, Y. J., Parry, J., Xu, Y. Y., Liu, H., Wang, M. 2012. Comparison of milling fractions of tartary buckwheat for their phenolics and antioxidant properties. *Food Res. Int.*, vol. 49, p. 53-59. <http://dx.doi.org/10.1016/j.foodres.2012.07.019>
- Inglett, G. E., Chen, D., Berhow, M., Lee, S. 2011. Antioxidant activity of commercial buckwheat flours and their free and bound phenolic compositions, *Food Chem.*, vol. 125, p. 923-929. <http://dx.doi.org/10.1016/j.foodchem.2010.09.076>
- Kreft, I., Fabjan, N., Yasumoto, K. 2006. Rutin content in buckwheat (*Fagopyrum esculentum Moench*) food materials and products. *Food Chem.*, vol. 98, p. 508-512. <http://dx.doi.org/10.1016/j.foodchem.2005.05.081>
- Li, Y. Q., Zhou, F. Ch., Gao, F., Bian, J. S., Shan, F. 2009. Comparative evaluation of quercetin, isoquercetin and rutin as inhibitors of α -glucosidase, *J. Agric. Food Chem.*, vol. 57, p. 11463-11468. <http://dx.doi.org/10.5219/189>
- Lin, L. Y., Liu, H. M., Yu, Y. W., Lin, S. D., Mau, J. L. 2009. Quality and antioxidant property of buckwheat enhanced wheat bread. *Food Chem.*, vol. 112, p. 987-991. <http://dx.doi.org/10.1016/j.foodchem.2008.07.022>
- Roberta, R., Pellegrini, N., Proteggente, A., Pannala, A., Yang, M., Rice-Evans, C. 1999. Antioxidant activity applying an improved ABTS radical cation decolorization assay. *Free Radical Bio. Med.*, vol. 26, p. 1231-1237. [http://dx.doi.org/10.1016/S0891-5849\(98\)00315-3](http://dx.doi.org/10.1016/S0891-5849(98)00315-3)
- Shanno, R. L. 1946. Rutin – a new drug for the treatment of increased capillary fragility. *Am. J. Med. Sci.*, vol. 211, p. 539-543.
- Sharma, S., Ali, A., Ali, J., Sahni, J. K., Baboota, S. 2013. Rutin: therapeutic potential and recent advances in drug delivery. *Expert Opin. Inv. Drug*, vol. 22, p. 1063-1079. <http://dx.doi.org/10.1517/13543784.2013.805744>
- Singleton, V. L., Rossi, Jr., J. A. 1965. Colorimetry of total phenolics with phosphomolybdic-phosphotungstic acid reagents. *Amer J Enol Viticult*, vol. 16, p. 144-159.
- Verardo, V., Arráez-Román, D., Segura-Carretero, A., Marconi, E., Fernández-Gutiérrez, A., Fiorenza Caboni, M. 2011. Determination of free and bound phenolic compounds in buckwheat spaghetti by RP-HPLC-ESI-TOF-MS: Effect of thermal processing. *J. Agric. Food Chem.*, vol. 59, p. 7700-7707. <http://dx.doi.org/10.1021/jf201069k PMid:21678994>
- Vogrinic, M., Timoracka, M., Melichacova, S., Vollmannova, A., Kreft, I. 2010. Degradation of rutin and polyphenols during the preparation of tartary buckwheat bread, *J. Agric. Food Chem.*, vol. 58, p. 4883-4887. <http://dx.doi.org/10.1021/jf9045733>
- Vojtišková, P., Švec, P., Kubáň, V., Krejzová, E., Bittová, M., Kráčmar, S., Svobodová, B. 2014. Chemical composition of buckwheat plant parts and selected buckwheat products. *Potravinarstvo*, vol. 8, p. 247-253. <http://dx.doi.org/10.5219/385>
- Zhang, M., Chen, H., Li, J., Pei, Y., Liang, Y. 2010. Antioxidant properties of tartary buckwheat extracts as affected by different thermal processing methods. *LWT - Food Sci. Technol.*, vol. 43, p. 181-185. <http://dx.doi.org/10.1016/j.lwt.2009.06.020>
- Zhang, Z. L., Zhou, M. L., Tang, Y., Li, F. L., Tang, Y. X., Shao, J. R., Xue, W. T., Wu, Y. M. 2012. Bioactive compounds in functional buckwheat food. *Food Res. Int.*, vol. 49, p. 389-395. <http://dx.doi.org/10.1016/j.foodres.2012.07.035>

Zielinski, H., Michalska, A., Amigo-Benavent, M., Dolores del Castillo, M., Piskula, M. K. 2009. Changes in protein quality and antioxidant properties of buckwheat seeds and groats induced by roasting. *J. Agric. Food Chem.*, vol. 57, p. 4771-4776. <http://dx.doi.org/10.1021/jf900313e>

Acknowledgments:

This study was kindly supported by the Ministry of Education, Youth and Sports of the Czech Republic (Grant No. MSM 7088352101) and by Internal Grant Agency of Tomas Bata University in Zlín, project IGA/FT/2014/001

Contact address:

Eliška Krejzová, Masaryk University, Faculty of Science, Department of Chemistry, Kotlářská 2, 611 37 Brno, Czech Republic, E-mail: krejzova@sci.muni.cz

Miroslava Bittová, Masaryk University, Faculty of Science, Department of Chemistry, Kotlářská 2, 611 37 Brno, Czech Republic, E-mail: bittova@sci.muni.cz

Stanislav Kráčmar, College of Business and Hotel Management, Department of Gastronomy, Bosonožská 9, 625 00 Brno, Czech Republic, E-mail: kracmar@hotskolabrno.cz

Petra Vojtišková, Thomas Bata University in Zlín, Faculty of Technology, Department of Food Technology, Vavrečkova 275, 762 72 Zlín, Czech Republic, E-mail: VojtiskovaPetra@seznam.cz

Vlastimil Kubáň, Thomas Bata University in Zlín, Faculty of Technology, Department of Food Technology, Vavrečkova 275, 762 72 Zlín, Czech Republic, E-mail: kuban@ft.utb.cz

Jozef Golian, Slovak University of Agriculture, Faculty of Biotechnology and Food Sciences, Department of Hygiene and Food Safety, Tr. A. Hlinku 2, 949 76 Nitra, Slovakia, E-mail: jozef.golian@uniag.sk



COSTS OF GROWING WHEAT AND OILSEED RAPE IN SLOVAKIA AND OTHER V4 COUNTRIES

Lenka Hudáková Stašová, Radoslav Bajus

ABSTRACT

This paper deals with the issue of cost in primary agricultural production. In this paper, we assess the trends in the costs of agricultural products in the V4 countries and compare them with each other. The subject of the analysis is the evaluation of the structure and development of costs and benefits for agricultural production as a whole, partially for crop and for livestock production and also for two specifically selected products. The purpose is to find out whether the costs incurred for the cultivation of wheat and oilseed rape in Slovakia are adequate as they are compared with the surrounding countries. Following the evaluation of the development of total costs, we define the substantive issues in overhead costs and evaluate their development. Based on the results of the analyses we have defined the proportion of overhead costs in agriculture as an important component of total production costs. The paper points to the need to innovate and modernise the way we think about overheads and the method of their calculation. We also look for the answer to how modern cost management methods could influence their height and development. We propose to improve the calculation system of agricultural enterprises in the analysed countries by introducing of non-traditional calculation method which removes the inaccuracy of the traditional methods and the non-targeted allocation of high overheads to the products.

Keywords: cost calculations; competitiveness; overhead costs; calculation methods; Slovakia; Czech Republic; Hungary; Poland

INTRODUCTION

Costs are an effective tool of economic management of businesses. The worldwide trend is focusing on improving product quality, reducing company costs, increasing productivity, increasing flexibility to respond to market needs and so on. Concepts for building a business and the means to gain a competitive advantage are specific, depending mainly on the sector, and the size of the company. Agriculture is a particularly specific sector. It is the sector of the economy whose main task is to ensure the nourishment of the population. This important task is the cornerstone of the very existence of the society and mankind. The main mean of its production is land. Characteristic activities in agriculture are tilling the land, the cultivation of crops and raising livestock. A characteristic feature of agricultural production is its connection to land.

The costs of agricultural products and their calculation, unlike in other sectors of the economy, are influenced by other factors resulting from the character of agricultural production. Among the most important ones are natural factors, which include soil conditions, weather conditions and the location of the land. These factors determine the quality of land and hence, the yield of individual crops.

Another important particularity is high consumption of own production in the production process – in-house consumption. Its large extent is due to the combination of two basic sectors of agricultural production – plant and animal productions. Both sectors mutually supply their products as raw material. Also, the fragmentation of plots and their shape adversely affect transportation costs and labour costs for mechanised labour in the crop production. The nature of certain fixed assets in agriculture is different. For example, land – provided it is treated expertly – is not subject to wearing out; its period of use can be considered as infinite. This eliminates the problem of the depreciation. The circulation of current assets affects the development of costs and the inequality of their reproduction during the calendar year (accounting, tax year). In the crop production, the production takes a year, in most of the livestock sector the production cycle is longer than a year. Agriculture is also affected by industry, which increasingly impacts on the level of costs (scope, quality of agricultural inputs). In agriculture, there are some damages that directly or indirectly affect the costs (death of animals, frost of winter crops, destruction of plants by floods, droughts, pests, etc.).

For agricultural enterprises, it is very important to know the amount of costs spent on manufactured products. This information is necessary in the decision-making process of a company. Knowledge and the use of it is a pre-condition for the success of emerging companies as well as the successful adaptation of existing enterprises to the market economy.

The cost-calculation reflects the quality of the work done in the business on mechanised production. Therefore, the calculation methodology includes both intracompany comparisons, as well as intercompany and international comparisons. The calculations must be factually and formally comparable, especially in terms of the content and breakdown calculation formulae. Comparing costs and revenues of agricultural products between countries mutually enables to define the position in the international competition.

In every competitive economic environment, costs play an important role in the decision making to choose the optimal production volume. Costs are a great instrument in the hands of managers. Managers can use the information obtained from calculations and comparisons to assess the viability of the products or business strategies used and to choose between alternative options (Bogdanoiu, 2011; Kozelová et al., 2010, 2013). Cost information is used to assess the level of individual cost items and costs of activities and uncovering reserves for decreasing them. It is also important for planning and recording costs (Sedliačiková et al., 2012; Kubicová and Habánová, 2012). Cost management currently focuses on two main areas. The first area is an accurate assessment of the cost of corporate activities. For this purpose, the calculation of costs is used. The second area of the cost management strategy is the ability to affect existing costs in a targeted way. It is a method of reducing costs. For effective management, it is necessary to know, which products are the most profitable, and which, on the other hand, produce loss and it is also important to know how much each activity performed costs and if it is being implemented efficiently. However, managers often have limited information on the cost structure; very often companies know their costs only by generic classification of inputs and, on the other hand, only the value of net profit for the enterprise as a whole. This kind of monitoring of costs does not give managers sufficient information about the actual implementation of activities and their relationship to corporate activities (products). Managers often only focus on the management of direct costs (material, wages) and do not pay sufficient attention to indirect overhead costs that are a high proportion of the total costs of the company. For costing, many businesses still use traditional methods, such as allocating variable costs in direct proportion to fixed costs, that do not provide accurate information on the costs related to corporate activities (Popesko, 2012, Popesko et al., 2015). Costing methodologies are different ways to quantify cost items attributable to a calculation unit. The choice of method for the calculation of costs depends on the nature of the activity and the conditions in which the activity takes place (type of activity, technology and production type). There exists a variety of methods how to do a good calculation, but recently companies have been developing their own calculation formulas and forming their own calculations that have the explanatory

power they need. This is a positive process because it is the only way to obtain optimal results (Gallo, 2015; Kozáková et al., 2014). It is important that management can determine which calculation method it can use for a specific decision-making task. The use of inappropriate methods may lead to incorrect decisions with a negative impact on the economic outcomes and efficiency of a company, and thus, its competitiveness. Methods for calculating the full costs are suitable for calculating the sales price, which should strive to reproduce all costs and bring a company profit. They are necessary for long-term, strategic management and decision-making. They are not appropriate in those cases, where there is a need to respond rapidly to the changing conditions of the market environment. In such a case it is necessary to work with fixed and variable costs (not with direct and indirect costs) and to use methods to calculate marginal (variable) costs, which are suitable for short-term management and decision-making. To carry out effective management and decision-making, managers need to calculate both full and marginal costs (Škorecová and Košovská, 2010). It is necessary to establish a form of calculation, which will be sufficient for the purpose, i.e. to determine a fair amount of the costs for a product in a rational manner. In this case, it is also appropriate to examine under what conditions the costs calculations used could be improved for improving the management process and pricing policy. (Kupkovič and Tóth, 2004). Current manufacturing technology allows increased automation and lower personnel costs; on the other hand, it increases the costs of servicing activities in production. The greater proportion of overheads a company achieves, the more the correct allocation of overheads becomes important. For manufacturing companies, it is not rare that direct costs are less than 50% of the total cost; the rest is swallowed by manufacturing overheads, shipping, customer service, R&D and product design and quality control. Overhead costs should be allocated to the products according to the extent to which the products are responsible for the overheads being incurred (Schawel and Billing, 2012). This problem is solved using the Non-traditional method of Activity Based Costing (ABC). It is a suitable cost management tool. Activity Based Costing is an approach to solve the problems of traditional cost management systems. These traditional costing systems are often unable to determine accurately the actual costs of production and the costs of related services. Consequently, managers make decisions based on inaccurate data especially in case of multiple products. Instead of using broad arbitrary percentages to allocate costs, ABC seeks to identify cause and effect relationships to objectively assign costs. Once costs of the activities have been identified, the cost of each activity is attributed to each product to the extent that the product uses the activity. In this way ABC often identifies areas of high overhead costs per unit and thus, directs attention to finding ways to reduce the costs or to charge more for costly products (Kaplan and Anderson, 2005, 2007). Traditional cost accounting methods were developed in the period, when direct costs of labour and material factors of production were dominant and when changes in the technology and consumer demand were not so fast. The problems with traditional cost accounting emerge, when indirect costs (such as maintenance, insurance, production

preparation, etc.) amount to significant sums or are even higher than direct costs. Activity Based Costing is a commonly used tool and has practical significance for the specific conditions of agricultural production, where it can be used to achieve the improvement of cost management (Zakić and Borović, 2013).

Scientific hypothesis

The aim of this paper is to assess the trend in overall production cost of agricultural firms in V4 countries, to compare the level of costs between countries as well as evaluating the development of yields on farms and evaluating the amount of profit achieved. Following the analysis of the total cost, another aim of the paper is to define substantive problems in overheads and to assess their dynamics. The purpose is to find out whether the costs incurred for the cultivation of wheat and oilseed rape in Slovakia are adequate as they are compared with the surrounding countries. We also look for the answer to how modern cost management methods could influence their height and development.

MATERIAL AND METHODOLOGY

The subject of the analysis is the evaluation of the structure and development of costs and benefits for agricultural production as a whole, partially for crop and for livestock production and also for two specifically selected products. The reporting period is the period 2009 – 2013, while in Poland we evaluated the years 2009 – 2012, and in case of Hungary we added an extra year (2014).

From the methodological point of view, we use traditional calculation methods for compiling calculations of costs and we note the benefits of the non-traditional calculation method Activity Based Costing. For the needs of analysis, we work with the following products: wheat and oilseed.

The data on the level of costs and revenues are denominated in Euro, per ton of manufactured product. The conversion is calculated using current exchange rates (at the time of writing).

In our analysis the following groups of businesses are used: 1st Group – agricultural enterprises included in the survey in individual countries - Slovakia, the Czech Republic, Poland and Hungary. We chose this group to analyse the development of the total cost, and the level of overheads. 2nd Group Surveyed group of companies – we created a group of businesses in which we performed our own questionnaire survey. The group consists of 18 agricultural enterprises in Slovakia (30 firms were approached) – cooperatives, limited liability companies and share companies.

We used data on the cost of selected agricultural products in organisations devoted to determining the cost of agricultural products statistically, separately in each of the countries analysed.

In Slovakia, this is the National Agricultural and Food Centre – Research Institute of Agriculture and Food in Slovakia (Národné poľnohospodárske a potravinárske centrum, Pracovisko: Výskumný ústav ekonomiky poľnohospodárstva a potravinárstva – VÚEPP), Research Institute of Agricultural and Food Economics, Bratislava office. The information concerning income and

expenditures of business entities was obtained using statements of their total costs. Some companies are unwilling to provide requested information, even though it would be appropriate, if calculations were compiled by every business entity, even if it is methodologically very difficult and demanding. The group of companies included in this survey represents about 40% of all farms in Slovakia (of 200 respondents, about 75 participated in the research. For the year 2013, 75 business entities (granges, Ltd., joint stock company) provided data, the numbers vary slightly in the analysed years.

Before processing costs considerable attention is paid to checking the factual accuracy of data. After multiple analysis and the removal of errors, the summary reports were prepared.

The results of the research on the cost of agricultural products can be used in various analyses of costs and production efficiency of agricultural products in different geographical conditions, for forecasting agricultural policy, the creation of different analyses and comparison of costs etc. The level of total production costs of agricultural products, as is apparent from the characteristics of total internally produced inventory costs, apart from direct costs, also includes a share of production overheads and if necessary a share of administrative expenses. The direct costs of the calculated activity as well as the share of production overheads are expenses directly related to the relevant activity, which are recorded as costs of the activity or in a narrower concept as the costs of production. The administrative costs incurred in the process of economic activities are considered costs not identifiable with a specific activity and are designated as periodic expenses and in a narrower concept as non-production costs. The level of the total production cost of a surveyed business was included in the final calculations of the surveyed sample. The total costs are the sum of direct and indirect costs together. The direct costs per 1 ha of harvested area (also 1 ton of product) or per 100 feeding days include: the consumption of purchased and produced seeds, seedlings, feed, litter; The consumption of purchased and manufactured fertilisers; The consumption of other purchased materials; The consumption of other products; Payroll; Social costs; Repairs and maintenance of external and internal; depreciation of intangible and tangible fixed assets; other direct costs; share of the costs of ancillary activities (e.g. work of tractors, combines, freight). Indirect costs consist of general and administrative expenses. The share of production overheads is the share of indirect costs related to the management and service of crop and livestock production. It is the actual overheads incurred related to crop and livestock production which would be impossible or uneconomic to assign (monitor) directly for individual crops and breeds of animal. The amount of production overheads is obtained from the analytical accounts to individual cost accounts or internal records. Costs of production overheads are assigned to different crops and animal breeds through allocation units. The allocation base is the actual direct costs of individual crops and species of animal. The share of the administrative costs, the share of indirect costs related to the management and administration. The share of administrative expenses attributable to individual crops and breeds is determined

by the cost-allocation units. The amount of administrative expenses is obtained from the analytical accounts to individual accounts or cost of factory records. The allocation base is the actual direct costs of individual crops and breeds.

In the Czech Republic, the data on the costs of agricultural products is compiled by the Institute of Agricultural Economics and Information in the Czech Republic (Institute of Agricultural Economics in Prague). The results on revenues and costs are presented for a set of 240 to 280 farms from all regions and agricultural production areas of the Czech Republic. Data is collected from internal calculations for activities within double-entry bookkeeping. Most respondents have audited accounts. All the data collected from the farms is inspected, analysed and then processed. Businesses included in the research set ascertain the total production cost by calculations, where the total costs are the sum of direct and indirect costs together. Direct costs per 1 ha of harvested area/1 ton of product and 100 feeding days include: direct material costs (purchased and own seeds, purchased and own fertiliser, spraying of plants with protection products and other direct materials, other direct costs and services, direct labour and personnel costs, payroll and personnel costs of ancillary activities, depreciation and amortization, costs of ancillary activities. Indirect costs include costs of general and administrative expenses. Total costs are the sum of direct and indirect costs. The Research Institute monitors costs in the following breakdown for each product by production areas. It does not separately monitor the total cost of crop and livestock production and total cost of agricultural production.

In Poland, the data collection is done by the Institute of Agricultural and Food Economics – National Research Institute, Agricultural Accountancy Department in Poland (Instytut Ekonomiki Rolnictwa i Gospodarki Żywnościowej – Państwowy Instytut Badawczy, Zakład Rachunkowości Rolnej). In individual years it calculates the economic situation of selected groups of farms. Statistical results contain information about production, costs, income from agriculture, economic results and selected financial metrics and ratios. Businesses submit information in a standard format. Using a special questionnaire, data is collected from about 200 farms (legal entities). From the data obtained, a database is subsequently created using specially created computer programs. Direct costs in crop production include: seeds and plants, seeds and plants home-grown, fertilisers, crop protection, other crop specific costs. Direct costs of livestock products include: feed for livestock, feed for livestock home-grown, other livestock specific costs. Direct costs also include: machinery and building current costs, energy, contract works, depreciation, wages paid, rent paid, other direct inputs. Indirect costs are tracked in one item: total farming overheads.

In Hungary, information on the costs of agricultural products is compiled by the Research Institute of Agricultural Economics in Hungary (Agrárgazdasági Kutató Intézet). The Institute collects and analyses data, conducts research and distributes the results obtained through their publications. It obtains information on the results achieved in agriculture, forestry and food production. It ensures the comparability of time series in

connection with the published data for previous years. The data is useful for international comparisons, and researching key trends. Data are collected at enterprise level, in businesses that maintain double-entry bookkeeping. The results are presented in the form of standard tables. The costs are not recorded with classification as direct or indirect costs, just as the totals for individual agricultural products. The costs of agricultural production of 1 ton of products in the research include both costs for seeds and seedlings (purchased from external suppliers and own production) cost of fertilisers (purchased and own) the cost of food and bedding (purchased and own), consumption of other purchased material costs, labour, depreciation of fixed assets, other direct costs, general overhead costs. The institute provides information (as in the Czech Republic) on the total cost of each product by production area. It does not specifically monitor the overall cost of crop and livestock production and the total cost of agricultural production.

Businesses included in the researched groups in individual countries ascertain their total level of costs using traditional calculations. From the cost structure included in total production cost in different countries, it is evident that they are mutually comparable.

When comparing the competitiveness of plant commodities, it is necessary to consider that the economic results of individual farms are affected by different production technology, size of enterprise (farm), forms of ownership, the amount of support provided in different countries, development of world and domestic markets. (Janotová and Boudný, 2013).

RESULTS AND DISCUSSION

Development and comparison of costs and benefits for agricultural production as a whole, and broken down into crop and livestock production

In Table 1 and Chart 1 we show values for indicators for agricultural production as a whole. We evaluate the total cost of 1 ha of agricultural land in euro, the share of overhead costs to total own costs, earnings per one hectare for the entire agricultural production as well as the profit or loss on one hectare in euro. We compare two countries, Slovakia and Poland.

In 2009, Slovak farms spent more on agricultural production costs than Poland, but revenues were at a similar level. Slovakia, in the given year, lost € -87.44 / ha from agricultural production and Poland achieved a profit of € 44.02 / ha. In 2010, Slovakia again had higher overall costs, with lower yields than Poland, which was reflected in the fact that although both countries made profits, in the Slovak Republic it was € 7.65 / ha, while in Poland € 175.03 / ha. In 2011 Slovakia had lower costs than Poland, as well as lower yields. Both countries were profitable. In 2012, Poland achieved a significantly higher income from agricultural production, which was reflected in the achievement of high profits, € 249.25 / ha. Profit in Slovakia in that year was € 64.1 / ha. However, in terms of the share of overheads, Poland has a significantly higher share.

In Table 2 and Chart 2 we show the same variables as in Table 1 and Chart 1, but now separately for crop production and for livestock production.

Table 1 Costs, revenues and the profit and loss statement for agricultural production in €/ha.

Agricultural production	Slovakia				Poland			
	Total costs / 1ha	Proportion of overhead costs	Revenues / 1ha	Profit or loss / 1ha	Total costs / 1ha	Proportion of overhead costs	Revenues / 1ha	Profit or loss / 1ha
2009	1177.14	16.60%	1089.7	-87.44	1033.16	21.61%	1077.18	44.02
2010	1113.28	19.00%	1120.93	7.65	1070.6	24.71%	1245.63	175.03
2011	1193.27	17.29%	1296.46	103.19	1216.43	23.67%	1435.89	219.46
2012	1224.02	18.36%	1288.12	64.1	1301.93	23.60%	1551.18	249.25
2013	1302.30	17.47%	1319.08	16.78	*	*	*	*

Source: Own calculations on data of The National Agricultural and Food Center - Research Institute of Agriculture and Food in Slovakia, The Institute of Agricultural and Food Economics – National Research Institute, Agricultural Accountancy Department in Poland.

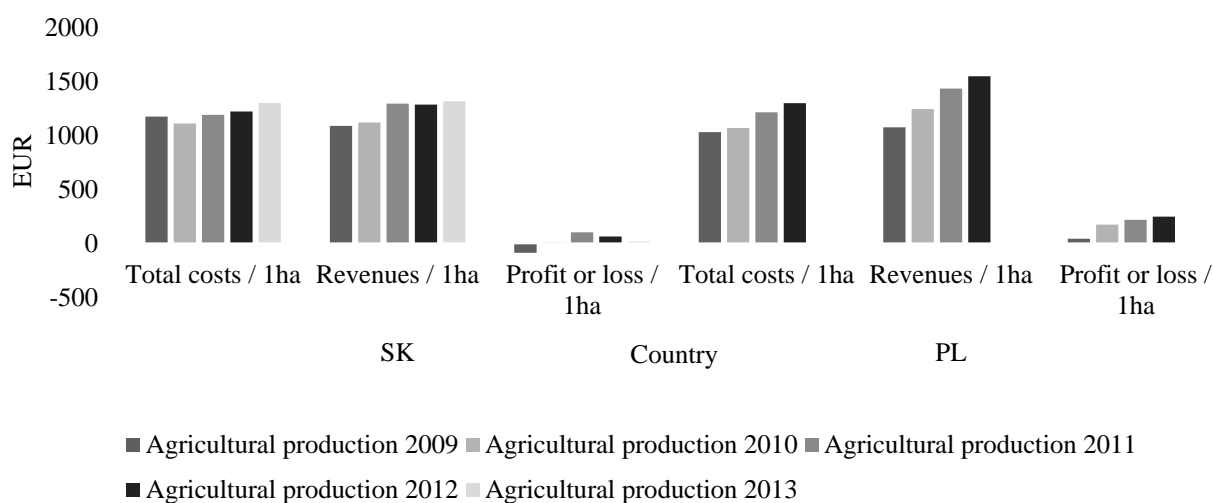

Figure 1 Costs, revenues and the profit and loss statement for agricultural production in €/ha. Source: own chart on data from Table 1.

Table 2 Costs, revenues and the profit and loss statement for agricultural production and livestock production in €/ha

		Slovakia				Poland			
		Total costs / 1ha	Proportion of overhead costs	Revenues / 1ha	Profit or loss / 1ha	Total costs / 1ha	Proportion of overhead costs	Revenues / 1ha	Profit or loss / 1ha
Crop production	2009	560.32	16.98%	538.99	-21.33	498.73	28.40%	536.82	38.09
	2010	504.32	20.21%	537.27	32.95	602.32	28.52%	717.59	115.27
	2011	590.73	17.68%	747.5	156.77	678.54	28.36%	805.3	126.76
	2012	604	19.94%	747.04	143.04	694.72	28.98%	884.34	189.62
	2013	636.72	21.49%	730.08	93.36	*	*	*	*
Livestock production	2009	616.81	16.36%	550.71	-66.1	534.43	18.27%	540.22	5.79
	2010	608.96	18.01%	583.65	-25.31	468.28	21.54%	528.05	59.77
	2011	602.54	16.91%	548.96	-53.58	537.89	20.07%	630.59	92.7
	2012	620.02	16.82%	541.08	-78.94	607.21	20.18%	667.49	60.28
	2013	665.58	16.85%	589	-76.58	*	*	*	*

Source: Own calculations on data of The National Agricultural and Food Center - Research Institute of Agriculture and Food in Slovakia, The Institute of Agricultural and Food Economics – National Research Institute, Agricultural Accountancy Department in Poland.

We evaluate the total cost per 1 ha of agricultural land in euro, the share of overhead costs to total costs, earnings per one hectare for the entire agricultural production as well as the profit or loss on one hectare in euro. We compare the same two countries, Slovakia and Poland.

In crop production in 2009, Slovakia lost money and Poland profited, even though revenues were higher in the Slovak Republic. In 2010, Slovakia was also making profits, although earnings in Poland were significantly higher. Although Poland had higher costs, it also had

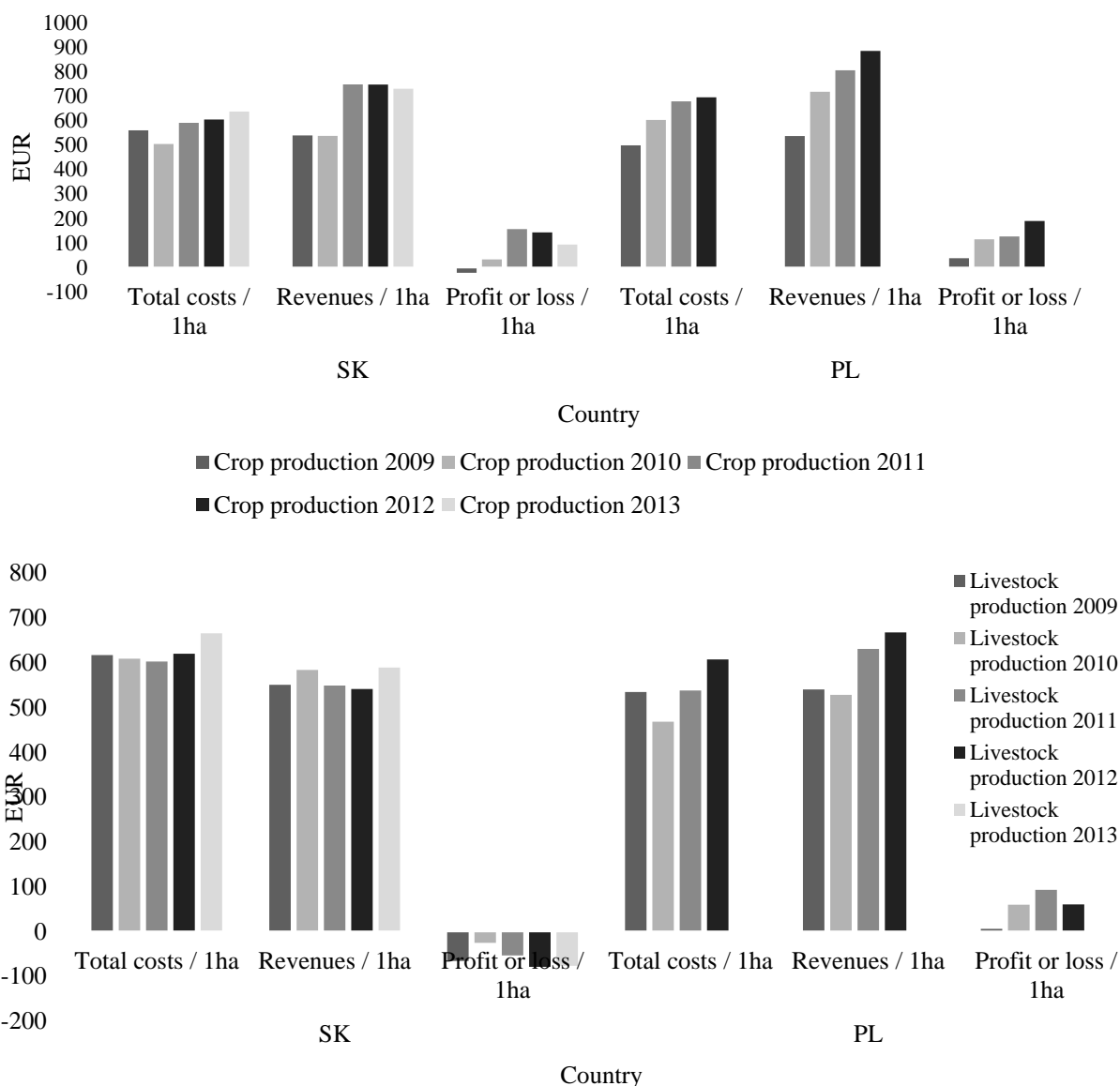

Figure 2 Costs, revenues and the profit and loss statement for agricultural production and livestock production in €/ha. Source: own charts on data from Table 2.

higher yields. In 2011, the profit of Slovakia increased significantly over the previous year, reaching € 156.77 / ha. In this year, it is higher than the profit from crop production in Poland. In 2012, both countries were again profitable, but Poland was more profitable again at € 189.62 / ha. The share of overheads was significantly higher in Poland.

In livestock production Slovakia lost money in all years, and Poland made profits in all years. The highest loss in Slovakia was € -78.94 / ha in 2012. Poland had its highest profit in 2011. It is also the case in livestock that Poland reported a higher proportion of overheads relative to total costs.

Development and comparison of total costs and yields for selected crops in the V4 countries

Development and comparison of total costs and yields of wheat

In Table 3 and Chart 3 we present, the figures for the total cost of wheat in euro per 1 ton of product produced, the shares of overhead costs to total costs as a percentage,

per yield of 1 ton of wheat in euro, as well as profit and loss for 1 ton of product.

The highest total cost per 1 ton of wheat in 2009 was in Slovakia, the lowest in Hungary. All countries studied this year grew wheat at a loss except Hungary which made a profit of € 53.63 / t. In 2010 the highest cost of 1 ton of wheat was again in Slovakia, which was the only studied country reporting a loss. All other countries were growing wheat at a profit, the highest profit was achieved in Hungary, € 58.26 / t. In 2011 all four countries were already profitable; the most profit again was again achieved in Hungary, even though it had the highest production costs.

The lowest profit was in Slovakia at € 17.91 / t. The Czech Republic achieved almost the same profit as Poland and the two countries also had similar costs. In 2012, all countries were profitable, the highest profit was again seen in Hungary, followed by Slovakia. The cost of production was at a comparable level in the two countries. In 2013 Hungary was the most profitable again. Slovakia achieved profits, but much lower than in the previous year. The

Table 3 Costs, revenues, profit or loss statement for the cultivation of wheat in €/t.

Agricultural crop	Year	Indicator	Slovakia	The Czech Republic	Poland	Hungary
Wheat	2009	Total cost / t	154.8	112.08	104.08	97.64
		Proportion of overhead costs	15.89%	16.49%	24.90%	*
		Revenues / t	137.19	94.64	84.52	151.28
		Profit or loss / t	-17.61	-17.44	-19.56	53.64
	2010	Total cost / t	157.27	110.12	105.58	129.23
		Proportion of overhead costs	19.84%	17.35%	26.70%	*
		Revenues / t	152.97	125.29	140.81	187.49
		Profit or loss / t	-4.3	15.17	35.23	58.26
	2011	Total cost / t	143.7	110.19	112.06	166.35
		Proportion of overhead costs	17.15%	18.30%	27.07%	*
		Revenues / t	161.61	159.19	165.06	237.91
		Profit or loss / t	17.91	49	53	71.56
	2012	Total cost / t	199.47	151.66	155.12	195.52
		Proportion of overhead costs	19.21%	17.77%	26.70%	*
		Revenues / t	261.3	179.32	200.24	269.12
		Profit or loss / t	61.83	27.66	45.12	73.6
	2013	Total cost / t	164.14	127.51	*	156.63
		Proportion of overhead costs	17.18%	14.56%	*	*
		Revenues / t	193.27	167.1	*	240.79
		Profit or loss / t	29.13	39.59	*	84.16
	2014	Total cost / t	*	*	*	154.01
		Proportion of overhead costs	*	*	*	*
		Revenues / t	*	*	*	269.93
		Profit or loss / t	*	*	*	115.92

Source: Own calculations on data of The National Agricultural and Food Centre - Research Institute of Agriculture and Food in Slovakia, The Institute of Agricultural Economics and Information in Czech Republic, The Institute of Agricultural and Food Economics – National Research Institute, Agricultural Accountancy Department in Poland, The Research Institute of Agricultural Economics in Hungary.

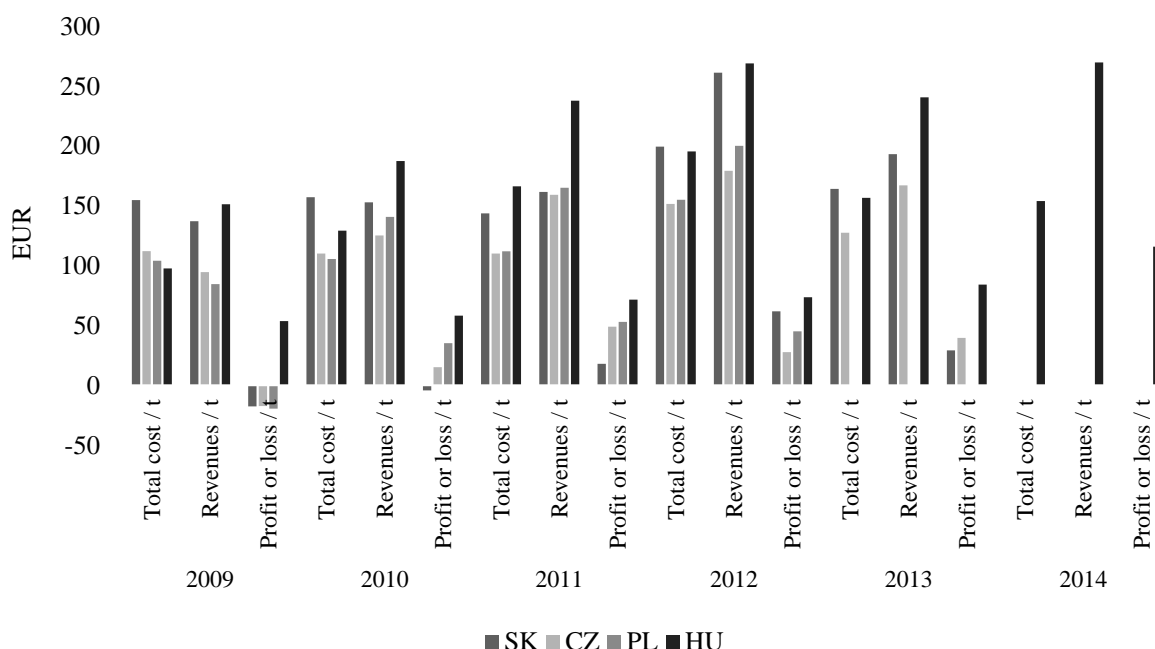

Figure 3 Costs, revenues, profit or loss statement for the cultivation of wheat in €/t. Source: own chart on data from Table 3.

lowest cost of production this year was in the Czech Republic, which achieved a higher profit than the Slovak Republic. Hungary is a country that has a growing trend in

terms of making a profit in the cultivation of wheat. In other countries, the development of profits showed fluctuating characteristics. The shares of overheads to total

Table 4 Costs, revenues, profit or loss statement for the cultivation of oilseed rape in €/t.

Agricultural crop	Year	Indicator	Slovakia	The Czech Republic	Poland	Hungary
Oilseed rape	2009	Total cost / t	337.79	271.12	*	245.14
		Proportion of overhead costs	13.93%	15.01%	*	*
		Revenues / t	342.74	246.02	*	363.99
		Profit or loss / t	4.95	-25.1	*	118.85
	2010	Total cost / t	349.85	288.7	*	271.4
		Proportion of overhead costs	17.52%	16.48%	*	*
		Revenues / t	329.02	283.02	*	353.6
		Profit or loss / t	-20.83	-5.68	*	82.2
	2011	Total cost / t	373.75	345.46	*	386.73
		Proportion of overhead costs	16.24%	17.72%	*	*
		Revenues / t	469.78	375.32	*	511.74
		Profit or loss / t	96.03	29,86	*	125.01
	2012	Total cost / t	465.44	371.09	*	451.3
		Proportion of overhead costs	16.12%	16.73%	*	*
		Revenues / t	628.97	431.98	*	718.43
		Profit or loss / t	163.53	60,89	*	267.13
	2013	Total cost / t	353.9	318.57	*	359.45
		Proportion of overhead costs	17.24%	15.02%	*	*
		Revenues / t	452.86	380.47	*	470.39
		Profit or loss / t	98.96	61.9	*	110.94
2014	Total cost / t	*	*	*	328.1	
	Proportion of overhead costs	*	*	*	*	
	Revenues / t	*	*	*	534.96	
	Profit or loss / t	*	*	*	206.86	

Source: Own calculations on data of The National Agricultural and Food Centre - Research Institute of Agriculture and Food in Slovakia, The Institute of Agricultural Economics and Information in Czech Republic, The Institute of Agricultural and Food Economics – National Research Institute, Agricultural Accountancy Department in Poland, The Research Institute of Agricultural Economics in Hungary.

production cost is evaluated for the Slovak Republic, the Czech Republic and Poland. For these countries, the highest proportion of overheads is Poland, 24.9 to 27.07%. Slovakia and the Czech Republic have a similar proportion of overheads to total costs, from 15.89 to 19.84% during the monitored period.

Development and comparison of total costs and yields for oilseed rape

In Table 4 and Chart 4 we present, the figures for the total cost of oilseed rape in euro per 1 ton of product produce, the share of overheads to total costs in percentage and yields per 1 ton of rape in euro as well as the economic result per 1 ton of product. For this product, we are excluding Poland from this evaluation. In this country, we were unable to obtain data for these indicators separately for oilseed rape, only oil crops in general, which would distort the mutual comparison.

In 2009, cultivation of oilseed was at a loss in the Czech Republic while Slovakia made a small profit. High profits were achieved in Hungary, and in this year, it also saw the lowest cost of oilseed cultivation in all countries evaluated. In 2010, two countries lost money, Slovakia and the Czech Republic, while Hungary once again made profits, though significantly lower than in the previous year. Hungary had the lowest costs, but their amount was comparable to costs in the Czech Republic. Slovakia had significantly higher costs. In 2011, all three countries had comparable costs per 1 ton of oilseed; all made a profit from oilseed cultivation. A much higher profit on a comparable level of costs was

achieved in Hungary at € 125.01 / t. The smallest profit this year was in the Czech Republic, € 29.86 / t, but it had the lowest costs. The year 2012 can be evaluated similarly to 2011, the highest profit was in Hungary at € 267.13 / t and the lowest costs in the Czech Republic. In 2013, all countries had comparable costs in the range 318.57 to 359.45 € / t, whereby the lowest value was in the Czech Republic. All countries made a profit; again the highest was in Hungary, although it was much lower than in the previous two years at € 110.94 / t. For Hungary, we have data for 2014, which found that generated profits almost doubled in comparison with 2013. During the monitored period, we found a comparable level of costs in different countries, but Hungary achieved significantly higher earnings in all years. This success is largely influenced by high yields. This can be explained mainly by better natural conditions in southern areas.

We evaluate the share of overheads to total costs for this product only for the Slovak Republic and the Czech Republic, between which these costs are similar. The development share of overhead costs has a variable character.

Calculation methods versus the amount of overhead costs

In our own survey was focused on enterprises in primary agricultural production. The set of businesses covered by the survey is described in more detail under methodology. Even though the group consists of only 18 enterprises, the

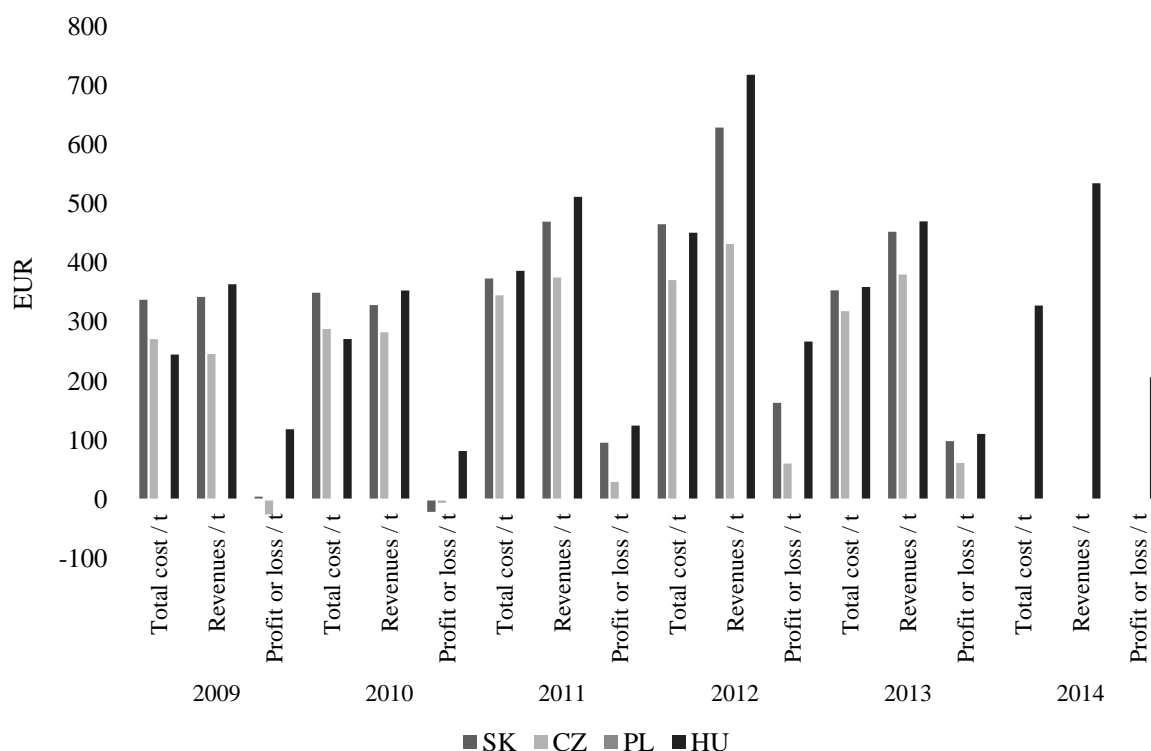

Figure 4 Costs, revenues, profit or loss statement for the cultivation of oilseed rape in €/t. Source: own chart of data from Table 4.

data obtained can help in assessing the situation of cost calculations in agriculture. We found that overhead costs were a high proportion of the total production cost. Up to 62% of the respondents replied that their share of overheads was 21 – 30%. While 28% said their overheads were 31 – 40%. The cause of the high calculated proportion of overhead costs was deemed to be misleading calculation by 35% of the analysed companies. 88% of the companies surveyed use traditional overhead calculation. Traditional overhead calculation is usually unsatisfactory because of its inaccuracies and static nature. It does not provide correct information in determining business conditions, such as prices, volume discounts or even the evaluation of real profit from partial production or customers. 61% of the companies surveyed did not use any software in calculations. It is not always required to have expensive, capital intensive costing software. Smaller and more simple companies that do not have the personnel, financial and software capabilities yet despite this still need a reliable tool for calculation and pricing can build a calculation methodology using MS Excel.

Enterprises included in the researched groups in individual countries ascertain their total level of costs using traditional calculations. We also found that 88% of our respondents' agricultural enterprises in Slovakia uses only traditional methods of cost calculation. Based on the results from all analyses performed, we consider the proportion of overhead costs in agriculture to be high, forming an important component of the overall production cost. From these findings, we can conclude that it is appropriate to innovate, modernise the way we think about overheads and the method of calculating them.

Direct allocation of costs to products or services does not reflect the real flow of costs to the business. Traditional

calculation systems are not able to calculate costs of products with sufficient precision. Most of the cost is assigned to products based on an allocation base that does not reflect the real causes of costs. The result is distorted, which adversely affects the decisions of the managers.

Most of the costs, however, are caused by the implementation of activities. Therefore, it is advisable to use a process-oriented controlling system that can describe links between resources consumed, activities undertaken and manufactured products. The method of Activity Based Costing appears to be the most effective tool for controls. It increases the transparency costs of processes, activities and actions and with their help creates "process costing" of products. We understand controlling as a function of economic management. In the broader sense, it means collecting feedback on the performance of an organisation, which is a broader area than just cost analysis. The Activity Based Costing method (supported in the business by appropriate specialised software) is a partial tool for controlling. In the literature, it is sometimes referred to as a method of controlling overheads.

The share of overhead costs to total costs is an important factor that a business should consider, when deciding whether to use a calculation method of costing. The higher the proportion of overhead costs to total costs in a certain business is, the greater the uncertainty in terms of allocating costs using an allocation base. For this reason, we propose that agricultural businesses phase in or improve their existing systems of cost management by creating a flexible model of functioning of their company. According to present knowledge and international experience, a suitable method for the creation of such a model is Activity Based Costing.

The biological character of the production is not an obstacle to the introduction of Activity Based Costing (ABC) in agriculture. The ABC method is universal. Any business that can be broken down into activities can benefit from ABC. A large part of business processes are common, regardless of the nature of the production. These are, for example, processes associated with supplies, a large part of administrative processes, supporting processes related to the maintenance of machines and buildings, the sales process, processes associated with the communication with customers. Opportunities for savings and improvements often hide in just such general - supporting processes that managers do not consider as significant.

CONCLUSION

Comparing the costs between companies that produce the same or related products can be used mainly to guide the production process, ensure optimal profitability of production activities especially by reducing production costs, identify new lines of technological development to upgrade the technology of production processes, improve the organisation and management of a company or internal department.

We compared the costs and revenues of selected agricultural products in V4 countries. Such information is important for defining the status of a particular country in international competition. When taking into account the selected period, the highest revenues from wheat cultivation were achieved in 2012 in Hungary and Slovakia. The wheat production in all selected countries except Hungary generated loss in 2009. The following years were more successful and profitable than 2009. In case of oilseed rape 2012 was the most successful year. The best result was achieved by Hungary, followed by Slovakia and the Czech Republic. Generally it can be noted that the most profitable country growing wheat and oilseed rape is Hungary. It is necessary to consider that the economic results are affected by different production technology, size of enterprise, forms of ownership, the amount of support provided in different countries, development of world and domestic markets.

Comparison also helps to identify various economic results of agricultural production. Monitoring, planning and cost control is justified in finding reserves to reduce costs, provide the basis for cost planning for future periods and it is also the basis for pricing. It enables the determination of the position of domestic producers relative to international competition and the discovery of the reasons for differences in the economic performance of agricultural production. Such information is useful not only for agricultural policy makers in the country, but also for farmers. The global competitiveness of a company cannot be secured without building a quality calculation and budgeting system meeting the requirements of a developed market economy. The company must use the calculations correctly to enable it to increase the effectiveness of the use of inputs costs. And just for this purpose, we propose to improve the calculation system of agricultural enterprises in the analysed countries by introducing of non-traditional calculation method which removes the inaccuracy of the traditional methods and the non-targeted allocation of high overheads to the products.

REFERENCES

- Bogdănoiu, C. 2011. Place and Role of Management Accounting and Cost Calculation in Food Industry of Manufacturing Dairy Products. *Journal of Applied Economic Sciences VI*, vol. 4, no. 18, p. 282-285.
- Bogdănoiu, C. 2011. Bases for Managerial Accounting and Cost Calculation. *Journal of Applied Economic Sciences VI*, vol. 4, p. 211-221.
- Gallo, P. 2015. *Target Costing (Cieľové kalkulácie)* [online] 2016-08-01 [cit. 2017-08-20] Available at: <http://www.dominanta.sk/kalk.htm>.
- Janotová, B., Bodný, J. 2013. International comparison of costs and revenues of selected agricultural crops (Mezinárodní komparace nákladů a výnosů vybraných zemědělských komodit) [online] s.a. [cit. 2017-10-20] Available at: http://www.uzei.cz/data/usr_001_cz_soubory/bu1303.pdf.
- Kaplan, R. S., Aderson, S. R. 2005. Rethinking Activity-Based Costing - HBS Working Knowledge [online] 2015-08-01 [cit. 2017-08-20] Available at: <http://hbswk.hbs.edu/item/4587.html>.
- Kaplan, R. S., Anderson, S. R. 2007. *Time – Driven Activity – Based Costing*. Boston : Harvard Business School Press. ISBN 978-1-4221-0171-1.
- Kozáková, J., Lančarič, D., Savov, R., Tóth, M. 2014. Organic and Conventional Production in Slovakia: Comparison of Selected Managerial and Financial Indicators. *Potravinárstvo*, vol. 8, no. 1, p. 254-260. <https://doi.org/doi:10.5219/386>
- Kozelová, D., Matejková, E., Qineti, A. 2010. Analyzing consumers opinion on organic food, their safety and availability in the Slovak food market. *Potravinárstvo*, vol. 4, no. 3, p. 30-35. <https://doi.org/10.5219/16>
- Kozelová, D., Vietoris, V., Fikselová, M. 2013. Quality and availability of organic foods by Slovak consumers. *Potravinárstvo*, vol. 7, no. 1, p. 146-150. <https://doi.org/10.5219/306>
- Kubicová, E., Habánová, M. 2016. Development Of Milk Consumption and Marketing Analysis of Its Demand. *Potravinárstvo*, vol. 10, no. 1, p. 557-562.
- Kupkovič, M., Tóth, M. 2004. Porovnanie prírážkovej kalkulácie nákladov a kalkulácie nákladov podľa čiastkových činností (Comparison of Survey Cost Calculation and Cost Calculation by Sub-Actions) (method ABC – Activity Based Costing). *Ekonomický časopis*, no. 2, p. 133-147. (in Slovak)
- Popesko, B. 2012. Process cost management by using Activity Based Costing method (Procesní řízení nákladu s využitím metody Activity Based – Costing). *Úspěch – produktivita a inovace v souvislostech*, vol. 7, no. 2. p. 1
- Popesko, B., Papadaki, Š., Novák, P. 2015. Cost and Reimbursement Analysis of Selected Hospital Diagnoses via Activity-Based Costing. *E&M Economic and Management*, vol. 18, no. 3, p. 50-61.
- Schawel, Ch., Billing, F. 2012. *Activity Based Costing. Top 100 Management Tools*. Germany : Springer Gabler Verlag. p. 16-18. ISBN 978-3-8349-4104-6.
- Sedliačiková M., Šatanová A., Foltínová A. 2012. Financial controlling in theory and praxis of small and medium size enterprises. *Ekonomický časopis*, no. 09, p. 949-966.
- Škorecová, E., Košovská, I. 2010. Application of process management and ABC method in the livestock production (Uplatnenie procesného riadenia a metódy ABC v živočíšnej výrobe). In *National and regional economics VIII*. Košice : Technická univerzita v Košiciach - Ekonomická fakulta, p. 1-7. ISBN 978-80-553-0517-2.

Zakić, V., Borović, N. 2013. Application Of Activity-Based Costing in Agricultural Enterprises. *AgEcon Search. Research in Agricultural & Applied Economics*, no. 9, p. 13.

Research Institutes: National agricultural and food center - Research Institute of Agriculture and Food in Slovakia (Národné poľnohospodárske a potravinárske centrum, Pracovisko: Výskumný ústav ekonomiky poľnohospodárstva a potravinárstva - VÚEPP) [online] s.a. [cit. 2017-08-20] Available at: http://www.vuepp.sk/04_naklady.htm.

Institute of Agricultural Economics and Information in Czech republic (Ústav zemědělské ekonomiky a informací - ÚZEI) [online] s.a. [cit. 2017-08-20] Available at: <http://www.uzei.cz/nakladovost-zemedelskych-vyrobku/>.

Institute of Agricultural and Food Economics – National Research Institute, Agricultural Accountancy Department in Poland (Instytut Ekonomiki Rolnictwa i Gospodarki Żywnościowej – Państwowy Instytut Badawczy, Zakład Rachunkowości Rolnej) [online] s.a. [cit. 2017-08-20]

Available at: <http://fadn.pl/publikacje/wyniki-standardowe-2/wyniki-standardowe-srednie-wazone/>.

Research Institute of Agricultural Economics in Hungaria (Agrárgazdasági Kutató Intézet) [online] s.a. [cit. 2017-08-20] Available at: https://pair.aki.gov.hu/web_public/general/home.do?lang=en&changelangaction=true.

Contact address:

Ing. Lenka Hudáková Stašová, PhD., Technical University of Košice, Faculty of Economics, Department of Finance, Némcovej 32, 040 01 Košice, Slovakia, E-mail: lenka.hudakova.stasova@tuke.sk

Ing. Radoslav Bajus, PhD., Technical University of Košice, Faculty of Economics, Department of Finance, Némcovej 32, 040 01 Košice, Slovakia, E-mail: radoslav.bajus@tuke.sk

DYNAMICS OF LACTOSE CHANGES DURING RIPENING OF EDAM CHEESE

*Lenka Vorlová, Lenka Prokopová, Jan Pospíšil, Petr Tichovský,
Zuzana Derflerová Brázdová, Kateřina Bogdanovičová*

ABSTRACT

The published data show that milk and dairy products are an important part of the diet in the European population and the population of North America, where they cover from 20 to 30% of protein, 15% of lipids and about 80% of calcium from food sources. The exclusion of milk and dairy products from human diet due to lactose intolerance (approximately 75% of the global population are lactose malabsorbers) can cause very serious health consequences. From a public health point of view, it is therefore extremely important for dairy products to capture all the facts about the fluctuation process or rather reduction of lactose content during dairy production technology. The aim of our study was to determine the lactose in various stages of Edam cheese ripening, to assess its suitability for consumption on the afflicted population. For the determination of lactose (day of production, first, second and sixth month of storage) the reference enzymatic method using the enzymatic set Megazyme International Ireland with a detection limit of 0.00296 g.100 g⁻¹ was applied. This set is intended for determination of lactose in samples presented as low-lactose or lactose-free products and is based on the hydrolysis of lactose to D-galactose and D-glucose by the enzyme β -galactosidase. After the subsequent oxidation of galactose, the amount of formed NADH (stoichiometrically related to the amount of lactose contained in the sample) is measured in a spectrophotometer at 340 nm. According to current legislation, the lactose-free product must contain less than 10 mg of lactose per 100 g or 100 mL of the consumed product, while a product that contains up to 1 g of lactose in 100 g or 100 mL of the product consumed is considered as a product with low lactose content. The study results showed that even after one month of storage Edam cheese can be, according to current national and EU legislation, designated as a lactose-free food. This means that the consumer receives a lactose-free product whenever buying this type of cheese.

Keywords: lactose; lactose intolerance; enzymatic method lactose determination; cheese Edam

INTRODUCTION

The position of milk and dairy products as a legitimate part of human nutrition is the result of qualities such as filling ability, content of high quality essential amino acids, vitamins and minerals – calcium in particular. Despite these obvious benefits, in some social groups milk is a taboo subject (Meyer-Rochow, 2009), in other cultures and societies its consumption is influenced not only availability, but also a degree of popularity and preference, which are usually of population character.

Except for breast milk, which is the only natural food for a human during the first six months of their life due to which reason it is always accepted positively, in case of other foodstuffs, including milk of other mammals and products from it, this will not be so unambiguous. In the early childhood, an individual is protected a priori by a so-called food neophobia, which, as a certain evolutionary attitude, ensures that the individual does not consume new and unknown food that could endanger them. This neophobia is later carried through an individual's life and

applied on foods which are unknown or prepared in a new way. People in economically developed countries also respond to those foods they encounter without sufficient cultural and social adaptation, or consumption of which is traditionally considered undesirable in a particular social group or religious community, or within their immediate vicinity.

The published data show that milk and dairy products are an important part of the diet in the European population and the population of North America, where they cover from 20 to 30% of protein, 15% of lipids and about 80% of calcium from food sources. The nutritional importance of dairy products in the whole context of their individual types is still not completely described. But certainly a number of positive aspects of milk are enhanced by the used cultural microflora (Park and Haenlein, 2013).

Campaigns against the consumption of cow's milk and dairy products organised in economically developed countries often abuse the fact that part of the European and North American population is affected by the defect of

lactase enzyme production and suffers from lactose intolerance. This fact together with the low level of knowledge of the actual lactose content in various stages of dairy production, which covers cheese as well, is often fallaciously used for recommendation of total avoidance of consumption of any dairy products (Roginski, Foquay and Fox, 2002).

It should be mentioned that there exists a possibility of intolerance of some milk nutrients, which is often misused to the disadvantage of milk. However, it must be mentioned, that there may exist intolerance of any food (Roginski, Foquay and Fox, 2002; Park and Haenlein, 2013).

In principle we distinguish between allergy and intolerance. Unlike food intolerance, allergy is always the response of the body via the immune system. In some individuals, milk proteins, as well as the components of another 160 foodstuffs, may induce an inappropriate response of the immune system (Park and Haenlein, 2013).

Based on clinical symptoms, it is possible to define two forms of allergic reaction in IgE-mediated food allergy. Food allergic reactions may be manifested differently with respect to localisation, time horizon, and the severity of the symptoms, the last mentioned ranging from the simplest to the anaphylactic shock. One form of allergy is manifested shortly after birth and in early childhood. Sensitization is triggered by a reaction in the gastrointestinal tract and is most often manifested as atopic dermatitis. Other possible forms of allergy are inflammation of the intestinal mucosa (accompanied by vomiting, nausea, diarrhoea and abdominal pain) and/or affection of the respiratory tract, namely bronchoconstriction, rhinitis, rhinoconjunctivitis (Park and Haenlein, 2013).

Allergens represent a wide range of substances (antigenic molecules) which are present in foodstuffs. Most allergens are proteins. Antigenic determinants of food allergens have different tertiary and quaternary structures. However, their definition is not easy because their conformation may be modified during the food technology (Park and Haenlein, 2013).

The main allergens of milk are also proteins, for example casein (in most cases α -casein) or whey proteins (β -lactoglobulin, but also α -lactalbumin).

Another possible type of milk intolerance is caused by lactose intolerance. Lactose intolerance is not an answer of the immune system, even though some of its manifestations may be identical with the manifestations of allergy. On the contrary, it is based on varied degrees of lactose malabsorption. This disease is also referred to as e.g. lactase deficiency, alactasia or hypolactasia.

On physiological conditions, lactose received in milk is hydrolysed in the jejunum (but also in the duodenum and ileum) into glucose and galactose by the enzyme lactase (β -galactosidase). Reduced or absent activity of this enzyme will induce manifestations of intolerance very similar to the gastrointestinal manifestations of allergy (Roginski, Foquay and Fox, 2002).

According to a number of factors, it is possible to classify various types of lactose intolerance. The first type is congenital lactase deficiency which is characterised by a rare genetic abnormality of lactase activity in which the

activity of the enzyme at birth is low or none at all (Roginski, Foquay and Fox, 2002).

Another type of this disease is also a very rare disease, referred to as congenital toxic lactase deficiency. This disease is characterised by the absorption of intact lactose which has a toxic effect on the liver and kidneys (potentially causing the death of the patient). The third type is so-called primary lactose intolerance. There is also secondary lactose intolerance in which lactase activity is low as a result of diseases such as tropical sprue, regional ileitis, various parasitoses, infections and/or gastrointestinal surgery (Roginski, Foquay and Fox, 2002).

Primary lactose intolerance has the highest prevalence in the world population. Besides other benefits, dairy products offer solution for a number of cases of lactose intolerance. Azcarate-Peril, Ritter and Savaiano (2017) indicate that approximately 75% of the global human population are lactose malabsorbers. The principle of this metabolic disease is a lactose malabsorption of various degrees. The extent of symptoms of lactose intolerance is dependent on the amount of lactose ingested. Lactose can be ingested both consciously and unconsciously in foods that have not been adequately labelled, and the complete composition was not stated. Lactose intolerance has been described 400 years ago, but its clinical symptoms have been described and recognised only in the last sixty years (Matthews et al., 2005). The symptoms occur within two hours after the ingestion of the food containing lactose; they include abdominal pain, flatulence, diarrhoea, nausea, vomiting, and stomach discomfort. The formation of short chains of fatty acids, hydrogen, methane and carbon dioxide during the fermentation of unabsorbed lactose by bacterial microflora increases the time of food passage through the intestinal tract. This slowdown causes abdominal pain and flatulence. There are several types of lactose intolerance (LI). The most common cause of LI is primary lactase deficiency. The inducing dose is variable, most individuals tolerate one glass of milk (12 – 18 g of lactose) (Arola, 1994; Roginski, Foquay and Fox., 2002; Park and Haenlein, 2013; Rosado, 2016).

The prevalence of lactose intolerance is characterized by binding to ethnic groups. In the Scandinavian countries 1 – 5% of population is affected; 10-20% in countries such as England and Russia; 15 – 50% in Central Europe. In the Mediterranean countries such as Greece, the incidence is 46 – 70% in children within 5 – 12 years of age, 75 – 80% in children more than 12 years, just as in adults; 70 – 100% in Japan, China, Thailand. The prevalence is extremely high in Asian population, 60 – 80% or higher. The situation in Africa is completely different. In North Africa it is within 70 – 80%, in both nomadic and black cattle-breeding population it is lower than 40%. The prevalence in Bedouins in Jordan and Saudi Arabia is lower than 25%. In the northern parts of America, Canada and Australia, the prevalence is typically lower (under 30%) than in Native Americans and aboriginal populations of Australia and Oceania, in which the prevalence usually exceeds 60% (in some cases it reaches 100%) (Roginski, Foquay and Fox, 2002).

Another factor influencing the prevalence of lactose intolerance is the age, since the activity of lactase physiologically decreases from the thirtieth year of life,

and its activity is dependent on the frequency of milk and dairy products intake.

The inducing dose appears to be of a great variability. In case of not a complete absence of the enzyme lactase, 250 mL of milk a day is accepted (Roginski at al., 2002; Hegar and Widodo, 2015, Buzas, 2015; Silanikove et al., 2015). Most dairy products (not considering lactose-free milk), contain a low or even no level of lactose and thus might be the solution for people with this disease. In addition, some strains of the added Lactobacilli (*L. acidophilus*) have the ability to adapt themselves in the digestive tract and then to product the required enzyme – lactase. Some studies show that the lactose coming from dairy products is better tolerated than lactose from milk (Roginski, Foquay and Fox, 2002). In case of fermented milk products, the lactose content is naturally reduced by 20 – 50% (Fox and McSweeney, 2008; Roginski, Foquay and Fox, 2002). The lactose content in cheese, however, shows quite great variability, depending on the type of cheese and used technology.

Scientific hypothesis

The aim of this study was to determine the lactose in various stages of ripening of Edam cheese of Czech provenance to assess the possibility of its consumption as a dietary option for those with lactose intolerance.

MATERIAL AND METHODOLOGY

The study was carried out in the dairy company Moravia Lacto Ltd. Jihlava, which is traditionally an important producer of Dutch type Edam cheese, the cheese is produced using the classical technology used in the production of this type of cheese (Düsterhöft, 2002). Four blocks (each weighing 15 kg) out of one batch of Edam cheese were collected, which were already during production divided into 10 smaller blocks (Figure1) and stored in the dairy at 8 – 12 °C and 80% relative humidity, and were successively analyzed: on the day of production, and then after one, two and six months of ripening.

On the day of sample analysis, the pads of Edam cheese were always transferred to the university laboratory in cooling boxes (0 – 5 °C) . From each cheese pad such a sample was taken to enable covering the process of ripening around the whole 15 kg block.

During each sampling (block of cheese pick up),

altogether 10 analyses were carried out; each time from the same ten locations. Each sample of cheese was grated and 10 g ±0.001 g of cheese was weighed out. Then the cheese was heated with distilled water at 50 °C under constant stirring and Carres rippling was performed. After subsequent alkalization and filtration, the filtrate was taken for determination.

For the detection of lactose content the reference enzymatic method was used. For the determination The enzymatic set Megazyme Assay Kit Lactose & D-Galactose Patent Pending [PCT/IE2004/00170] © 2005 (Ireland) was applied. This set is intended for determination of lactose in samples presented as low-lactose or lactose-free products and is based on the hydrolysis of lactose to D-galactose and D-glucose by the enzyme β-galactosidase. After the subsequent oxidation of galactose, the amount of formed NADH (stoichiometrically related to the amount of lactose contained in the sample) is measured in a spectrophotometer HALIOS β UNICAM (UK) at 340 nm. The enzymatic set, works with a detection limit of 0.00296 g.100 g⁻¹. Methods based on this principle have been accepted by AOAC 2006.06, NBN, DIN, GOST and IDF

Statistic analysis

The obtained results were statistically evaluated using software STATISTIKA CZ (CR), version No. 10. The graphs were processed in Microsoft Office Excel and Word with respect to data obtained from STATISTIKA CZ, version No. 10.

RESULTS AND DISCUSSION

The usual period of ripening of Edam cheese prior to shipment to the market network in Czech dairies ranges from 4 to 8 weeks. In some cases, the cheese may be distributed into market network later, possibly up to six months after production. **Decree No. 46/2014 Coll. of Czech Republic, Amending Decree no. 54/2004 Coll. of Czech Republic**, On foodstuffs intended for particular nutritional uses and how to use them, as amended, addresses the definition of lactose-free foods and foods low in lactose. Lactose-free product contains up to 10 mg of lactose in 100 g or 100 mL of the product, while a product with low lactose content is such one that contains up to 1 g of lactose in 100 g or 100 mL of the product

1	10
2	9
3	8
4	7
5	6

Figure 1 Each block of cheese (15 kg) was already during production divided into 10 smaller blocks, and each block sector was indicated by the same index.

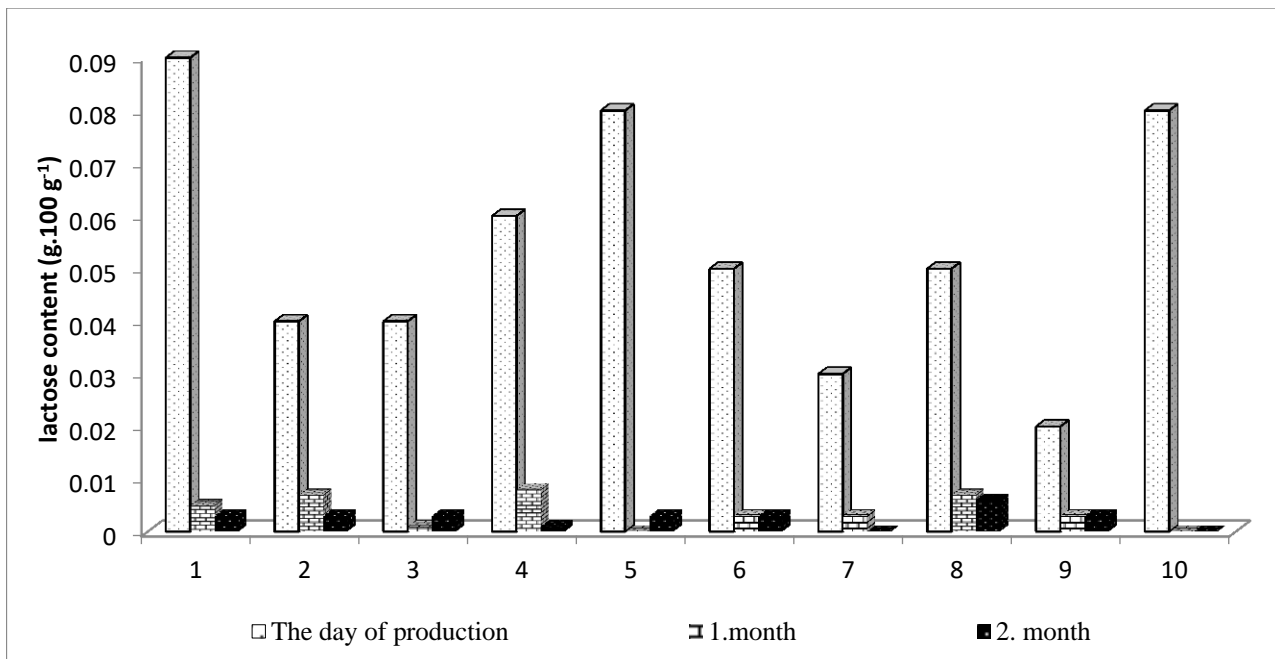

Figure 2 The lactose content (g.100 g⁻¹) for each of the block sectors (1 to 10) on the day of production and after one and two months of storage.

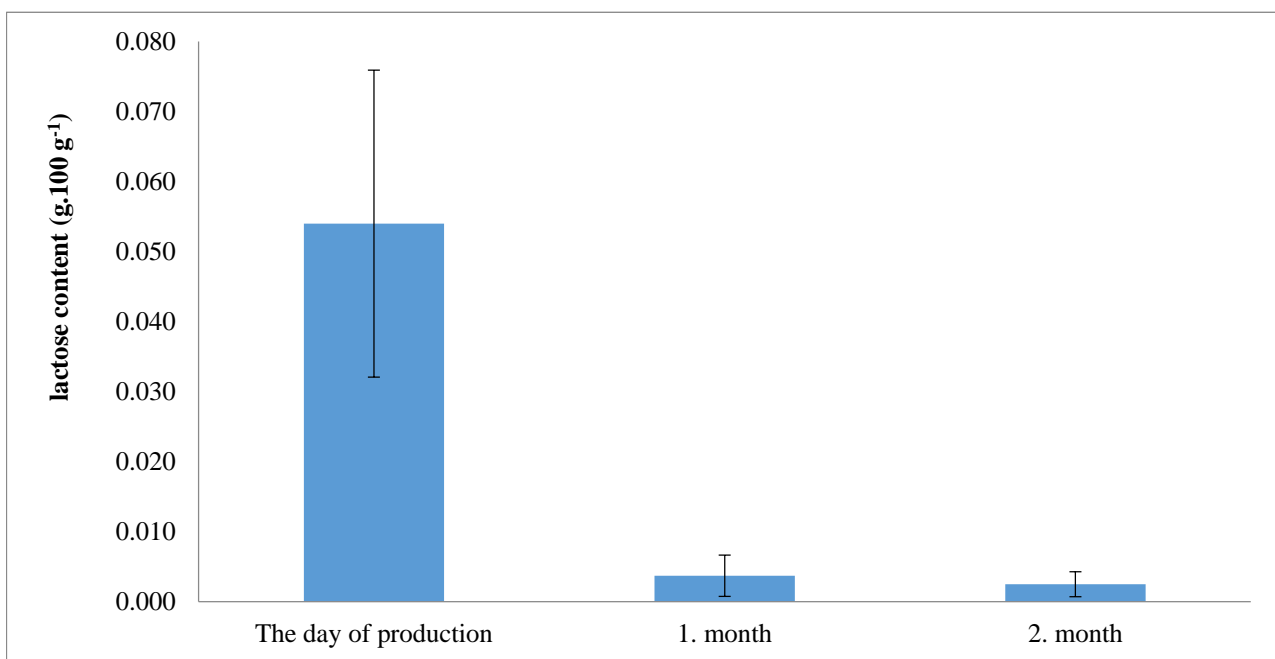

Figure 3 The lactose content in cheese including variability ($x \pm SD$) in individual samplings.

consumed. Lactose content (g.100 g⁻¹) for each of the block sectors (1 to 10) analyzed at the day of production, after one and two months of storage are shown in the Figure 2. In our study we found out the concentration of lactose in cheese at the day of production 0.0540 ± 0.0232 g.100 g⁻¹. Already after one month of ripening statistically significantly lower ($p < 0.01$) concentration of lactose 0.0037 ± 0.0029 g.100 g⁻¹ was determined. After another (second month of ripening), the concentration of lactose (0.0025 ± 0.0018 g.100 g⁻¹), was very close to the detection limit of the method. The planned offtake of the sample in the 6th month of storage was superfluous regarding to the low lactose content being close to the detection limit of the method used, and therefore was not implemented.

From the results obtained, it is obvious that the residual lactose content in cheese is already very low on the day of manufacture and the main metabolic bacterial degradation of lactose takes place within the first month of ripening process. The results correspond with **Park and Haenlein (2013)**, who state that fresh cheese curd (rennet curd) contains approximately 1% of lactose. However, other types of cheese, technology of which also involve washing the curd with water, e.g. cottage cheese, the curd does not contain any lactose.

As stated in study of **Hettinga et al. (1970)**, who for the determination also used the enzymatic method, the presence of lactose in cheese of Cheddar type can be detected even during long storage, up to the level of detection of 0.004% lactose. These and lower values can

be then detected by thin layer chromatography. **Shakeel-Ur-Rehman, Waldron and Fox (2004)** in his study compared the breakdown of lactose in cheese of Cheddar type with a modified amount of lactose. For his tests he produced Cheddar cheese of standard lactose content, which is commercially available, the second variant of the cheese was produced with a reduced content of lactose and the third type was produced by enriching the cheese with 8.4% of lactose. For Cheddar cheese with the reduced content of lactose, a value close to 0 was found within 60 days of production. For cheese designated as standard, therefore with the usual lactose content, the values were close to zero after about 150 days of ripening and in cheese with added lactose there was even after 180 days of ripening the amount of 1.4% lactose detected in laboratory findings. Later degradation of lactose in cheese of Cheddar type than in cheese of Edam type could be due to a different technology of production, when the Cheddar curd could have been more heated by a couple of degrees. In both types of cheese, the technology of low-boiled curd with the heating range of 36 – 40°C is used, and the range of used temperature could influence the viability of the fermentation culture and the depth of subsequent fermentation. The concentration of the salt bath used, the size of the produced block, the temperature of the cellars and many other factors could have affected the lactose content of these (similar, yet different) cheeses (**Shakeel-Ur-Rehman, Waldron and Fox, 2004**).

A study by the **Izco (2002)** team is dedicated to the determination of lactose and other substances in cheese by capillary electrophoresis. By this method his team determined not only cheeses as such but also yogurt. Two variants of farmer cheese, which is an unripened cheese, were analyzed by capillary electrophoresis. The one variant was stored at a standard temperature of 8 – 10°C, the amount of the detected lactose was 2.3 g.100 g⁻¹ of dry matter. The other variant of the same cheese was stored for two days at 32 °C and the detected lactose content was 1.9 g.100 g⁻¹ of dry matter. From this study can be concluded that the lactose content is influenced by many aspects, not only by the amount of the fermentation culture, the salt bath concentration, but also by storage temperature. The **Izco study (2002)** has shown that even two days can affect the lactose content of the cheese, because at higher temperatures, the surviving microorganisms in the cheese are much more active in decomposing lactose into final products. **Silanikove, Leitner and Merin (2015)** in their study state that both hard and fresh cheeses always contain residual amounts of lactose since the separation of curd from whey is never absolute, at least when the conventional process of production is used. The portion of fresh cheese (according to the authors this is 43 g) contains lactose but within the tolerated limit of 12 g. The lactose content of hard-matured (long-ripened) cheeses is very low and according to **Van Calcar et al. (2014)** it is also well tolerated by those who suffer from congenital defect of lactase production (or even galactosemia). Nonetheless, **Silanikove, Leitner and Merin (2015)** take it for useful that these types of cheese, which are expected to contain low or tolerable lactose content, bear specific information about their content as well, so as to form a safe part of the regular diet of people suffering from the defect of lactase formation.

The results obtained in this Edam ripening study (the cheese is in many ways the optimal choice for consumption) are also significant in the context of prevention of osteoporosis or rather bone mineral density (BMD). For example a study done by **Makbul et al. (2016)** proved a relationship between lactose intolerance and BMD ($p = 0.031$). Hence, lactose intolerance consequently affects decreasing of an individual's BMD.

All the studies that have been conducted on cheeses suggest that nearly all ripened cheeses can be described as low-lactose and those ripened longer with higher dry matter, even as lactose-free dairy products.

CONCLUSION

In our study, using the reference enzymatic method we verified that the content of lactose in Edam cheese is already the first day after the production (concentration of lactose 0.0540 ± 0.0232 g.100 g⁻¹) as low as the product may be marked, in accordance to current legislation, as low lactose food. One month after date of production, the Edam cheese may be declared as lactose-free food (concentration of lactose 0.0037 ± 0.0029 g.100 g⁻¹).

REFERENCES

- Arola, H. 1994. Diagnosis Of Hypolactasia and Lactose Malabsorption. *Scandinavian Journal Of Gastroenterology Supplement*, vol. 202, p. 26-35. <https://doi.org/10.3109/00365529409091742>
- Azcarate-Peril, M. A.; Ritter, A. J.; Savaiano, D., Monteagudo-Mera, A., Anderson, C., Magness, S. T., Klaenhammer, T. R. 2017. Impact of Short-Chain Galactoligosacharides on the Gut Microbiome of Lactose-Intolerant Individuals. *Proceedings of the National Academy of Sciences Of the USA*, vol. 114, no. 3, p. E367-E375.
- Buzas, G. M. 2015. Lactose Intolerance: Past and Present. Part I. *Orvosi Hetilap*, vol. 156, no. 43, p. 1741-1749. [PMid:26477616](https://pubmed.ncbi.nlm.nih.gov/26477616/)
- Düsterhöft, E. M., Engels, W. J., van den Berg, G. 2002. Dutch-Type Cheeses. In: Roginski, H. et al. *Encyklopedia Of Dairy Sciences*, vol. 3 and 4, London, UK : Academic Press, p. 557.
- Fox, P. F, McSweeney, P. L. H. 2006. Advanced Dairy Chemistry, vol. 2: Lipids. 3rd ed. New York, USA : Springer, p. 801. ISBN 978-0-387-28813-0.
- Fox, P. F., Mcsweeney, P. L. H. 1998. *Dairy Chemistry and Biochemistry*. UK : Springer Science & Business Media, p. 478. ISBN 9780412720000.
- Hegar, B., Widodo, A. 2015. Lactose Intolerance in Indonesian Children. *Asia Pacific Journal of Clinical Nutrition*, vol. 24, suppl. no. 1, p. S31-S40. [PMid:26715082](https://pubmed.ncbi.nlm.nih.gov/26715082/)
- Hettinga, D. H. 1970. Sensitive Enzymatic Method For Determination of Glucose, Galactose and Lactose in Cheddar Cheese. *Journal of Dairy Science*, vol. 53, no. 10, p. 1377-1380. [https://doi.org/10.3168/jds.S0022-0302\(70\)86402-5](https://doi.org/10.3168/jds.S0022-0302(70)86402-5)
- Izco, J. M. 2002. Rapid Simultaneous Determination of Organic Acids, Free Amino Acids, And Lactose in Cheese By Capillary Electrophoresis. *Journal of Dairy Science*, vol. 85, no. 9, p. 2122-2129. [https://doi.org/10.3168/jds.S0022-0302\(02\)74290-2](https://doi.org/10.3168/jds.S0022-0302(02)74290-2)
- Makbul, I. A. A., Daud, N. M., Aziz, N., A. A. A., Yahya, N. F. S. 2016. Lactose Intolerance Among Malay and Orang Asli Female Children in Selected Rural Selangor and Its Effect on Bone Mineral Density. In *Aip Conference Proceedings*. Selangor : Malaysia. ISBN 978-0-7354-1446-4.

Matthews, S. B., Waud, J. P., Roberts, A. G., Campbell, A. K. 2005. Systemic Lactose Intolerance: A New Perspective on an Old Problem. *Postgraduate Medical Journal*, vol. 81, no. 953, p. 167-173. <https://doi.org/10.1136/pgmj.2004.025551>
[PMid:15749792](https://pubmed.ncbi.nlm.nih.gov/15749792/)

Meyer-Rochow, V., B. 2009. Food Taboos: Their Origins And Purposes. *Journal Of Ethnobiology And Ethnomedicine*, vol. 5, no 18., p. 1-10. <https://doi.org/10.1186/1746-4269-5-18>

Park, Y. W., Haenlein, G. F. W. 2013. *Milk And Dairy Products in Human Nutrition: Production, Composition and Health: Lactose Intolerance*. United Kingdom : John Wiley & Sons Ltd., 728 p., ISBN 9780470674185.

Roginski, H., Foquay, J., W., Fox, P. F. 2002. *Encyclopedia of Dairy Sciences*. 1st ed. London : Academic Press. p. 2485. ISBN 9780122272356.

Rosado, J. L. 2016. Lactose Intolerance. *Gaceta Medica De Mexico*, vol. 152, Supp. no. 1, p. 67-73. [PMid:27603891](https://pubmed.ncbi.nlm.nih.gov/27603891/)

Shakeel-Ur-Rehman, Waldron, D., Fox, P. F. 2004. Effect of Modifying Lactose Concentration in Cheese Curd on Proteolysis and in Quality Of Cheddar Cheese. *Journal of Dairy Science*, vol. 14, no. 7, p. 591-597. <https://doi.org/10.1016/j.idairyj.2003.11.008>

Silanikove N., Leitner G., Merin U. 2015. The Interrelationships Between Lactose Intolerance and The Modern Dairy Industry: Global Perspectives in Evolutional and Historical Backgrounds. *Nutrients*, vol. 7, no. 9, p. 7312-7331. <https://doi.org/10.3390/nu7095340>

[PMid:26404364](https://pubmed.ncbi.nlm.nih.gov/26404364/)

Van Calcar, S. C., Bernstein, L. E., Rohr, F. J., Scaman, C. H., Yanniceli, S., Berry, G. T. 2014. A Re/Evaluation Of Life-Long Severe Galactose Restriction For The Nutrition Management Of Classic Galactosemia. *Molecular Genetics And Metabolism*, vol. 112, no. 3, p. 191-197. <https://doi.org/10.1016/j.ymgme.2014.04.004>
[PMid:24857409](https://pubmed.ncbi.nlm.nih.gov/24857409/)

Decree No. 46/2014/Coll. of Czech Republic. *Regulations on Collection of Land Rent and Water Surface*. 01.07.2014.

Decree no. 54/2004 Coll. of Czech Republic on foodstuffs intended for particular nutritional uses and on the method of their use.

Acknowledgments:

This work was supported by grant NAZV QJ1230044.

Contact address:

Lenka Vorolová, University of Veterinary and Pharmaceutical Sciences, Faculty of Veterinary Hygiene and Ecology, Department of Milk Hygiene and Technology, Palackého tř. 1946/1, 612 42 Brno, Czech Republic, E-mail: voroloval@vfu.cz

Lenka Prokopová, University of Veterinary and Pharmaceutical Sciences, Faculty of Veterinary Hygiene and Ecology, Department of Milk Hygiene and Technology, Palackého tř. 1946/1, 612 42 Brno, Czech Republic, E-mail: H12369@vfu.cz

Jan Pospíšil, University of Veterinary and Pharmaceutical Sciences, Faculty of Veterinary Hygiene and Ecology, Department of Milk Hygiene and Technology, Palackého tř. 1946/1, 612 42 Brno, Czech Republic, E-mail: pospisilj@vfu.cz

Petr Tichovský, Moravia Lacto Ltd. Jihlava, Jiráskova 94, 586 01 Jihlava, Czech Republic, E-mail: moravia@moravialacto.cz

Zuzana Derflerová Brázdová, Masaryk University, Faculty of Medicine, Department of Public Health, Kamenice 5, 625 00 Brno, Czech Republic, E-mail: brazdova@med.muni.cz

Kateřina Bogdanovičová, University of Veterinary and Pharmaceutical Sciences, Faculty of Veterinary Hygiene and Ecology, Department of Milk Hygiene and Technology, Palackého tř. 1946/1, 612 42 Brno, Czech Republic, E-mail: bogdanovicovak@vfu.cz

EVALUATION AND COMPARISON OF BIOACTIVE SUBSTANCES IN SELECTED SPECIES OF THE GENUS *ALLIUM*

Ján Kovarovič, Judita Bystrická, Alexander Fehér, Marianna Lenková

ABSTRACT

Allium is a genus of some 650 species belonging to the family *Liliaceae*. However only a few of these are important as food plants, notably garlic (*Allium sativum* L.), onion (*Allium cepa* L.), leek (*Allium porrum* L.) and wild garlic (*Allium ursinum* L.). They contain many health beneficial substances, such as sulphur compounds, vitamins (vitamin C), mineral substances (Fe, Mg, Ca, P), polyphenols (especially quercetin) and substances antioxidant activity and fiber. In this work we evaluated the content of bioactive substances, especially the content of total polyphenols and antioxidant activity in several species (red onion, yellow onion, white onion, garlic, leek, wild garlic) of the genus *Allium*. Samples of plant material were collected at full maturity stages from Zohor (Slovak Republic). Zohor is an area without negative influences and emission sources. Samples of fresh species of the genus *Allium* were homogenized and prepared as an extract: 25 g cut plants material (red onion, yellow onion, white onion, garlic, leek, wild garlic) extracted with 50 mL of 80% ethanol for sixteen hours. These extracts were used for analyzes. The content of total polyphenols was determined using the Folin-Ciocalteu reagent (FCR). The absorbance was measured at 765 nm of wavelength versus blank. Antioxidant activity was measured using DPPH' (2,2-diferyl-1-picrylhydrazyl) at 515.6 nm in the spectrophotometer. In the present experiment it was found that total polyphenols content in samples ranged from 83.59 mg.kg⁻¹ to 758.63 mg.kg⁻¹ and values of antioxidant activity were in the range from 7.19% to 53.55%.

Keywords: polyphenols; antioxidant activity; *Allium*; species; variety

INTRODUCTION

Vegetables are an important part of any dietary pattern. Because vegetables are typically high in nutrients and low in calories, they can play an essential role in health promotion and disease prevention (Manero et al., 2017). An increased intake of fruits and vegetables has been linked to lowering of important cardiovascular disease risk factors including hypertension, obesity, and type II diabetes mellitus. Furthermore, an inverse association between vegetables and fruits intake and cardiovascular disease incidents such as coronary heart disease and stroke has also been established (Bvenura and Sivakumar, 2017). Miller et al. (2017) published that the World Health Organization recommends a daily intake of five to eight portions of fruits and vegetables to reduce the risk of micronutrient deficiencies, cardiovascular disease, cancer, cognitive impairment, and other diet-related health conditions.

Currently, a major goal among researchers in food science is finding objective evidence that demonstrates food functionality. Consequently, studies regarding both the biological properties of putative phytochemicals and the chemical composition of plant species are of interest

(Ramirez et al., 2017). Onion (*Allium cepa* L.), garlic (*Allium sativum* L.), leek (*Allium porrum* L.), wild garlic (*Allium ursinum* L.) and chive (*Allium schoenoprasum* L.) are known species of the genus *Allium* which is important in the agriculture, food industry, gastronomy and modern food technologies. The genus *Allium* is composed of 600-700 species plants with specific taste and aroma. The specific aroma and taste of *Allium* plants caused by sulfur containing phytochemicals (Poojary et al., 2017; Kamenetsky and Rabinowitch, 2017). Lee et al. (2011) reported that sulfur containing phytochemicals in plants of *Allium* have anti-platelet and potential cancer-prevention activities.

Onions and garlic are universally used spice plants, and their medicinal properties are well known. Chive and the more recently introduced species are also much appreciated as spices, but leek and welsh onion are more important as vegetables with additional flavouring properties (Fritsch and Keusgen, 2006).

Onion (*Allium cepa* L.) is a plant of the *Liliaceae* family (of the genus *Allium*) and it contend phytochemicals, such as copanens, flavonoids, anthocyanins, minerals,

phenolics, phytoestrogens, terpenoids, vitamins, anthocyanins, and amino acids (Saxena et al., 2013).

Garlic (*Allium sativum* L.) is one of the most extensively studied species, not only among *Alliums*, but among all vegetables, and it has been considered a medicinal food for centuries, being used as a traditional remedy for common disorders (Ramirez et al., 2017). Naheed et al. (2017) reported that garlic is a rich source of health-promoting phytochemicals including antioxidants such as phenolics, flavonoids, and allicin.

Leek (*Allium porrum* L.) is a member of the genus *Allium* and grown is cultivated in Asia, America, and Europe, especially in the Mediterranean region (Tighe-Neira et al., 2017). Leek is source of flavonoids, kaempferol derivatives quercetin derivatives, flavonoids, phenolic, saponins, steroidal saponin, essential oils (Mohamed et al., 2016).

Wild garlic (*Allium ursinum* L.) also known under the name "bear's garlic" is a wild plant of the genus *Allium*. Wild garlic prefer nutritive substrate in the forest near rivers and streams. The important part of plant are leaves which are used in the food industry. The flowers and bulbs also are edible. The species has antiseptic, bacteriostatic, anti-parasitic properties and it is used during hypertension, hyperlypemia, and hypercholesterolemia treatment in alternative medicine. The leaves of wild garlic are highly appreciated as a spice, salads or soups, as raw, pickled, or as a vegetable in the gastronomy (Kęsik et al., 2011).

Antioxidants are defined as compounds present at low concentration compared to the oxidizable substrate that can significantly delay or prevent oxidation of that substrate. Phytochemical components, especially polyphenols are known to reduce oxidative stress. Phenolic compounds are secondary metabolites are known to be responsible for the antioxidant activity of plants. These compounds are suggested to contribute to the health-promoting properties. In addition to nutritive dietary components plants are a good source of different classes of polyphenolic components as well as flavan-3-ols, hydroxybenzoic and hydroxycinnamic acids, anthocyanins, stilbenoids and other flavonoids (Radovanović et al., 2015).

Scientific hypothesis

Our hypothesis is that different species of the genus *Allium* has different content of total polyphenols, values of antioxidant activity and we expects the positive correlation between antioxidant activity values and total polyphenols content in this experiment.

MATERIAL AND METHODOLOGY

Plant material

Samples of plant material were collected at full maturity stages from area of Zohor (Slovak Republic). The sample of plant material were analyzed individually by selected methods, and were used in fresh material on analysis. The analysed *Allium* species (leek, garlic, wild garlic, white onion, yellow onion and red onion) are the most grown in Slovakia. The analysed species of the genus *Allium* (leek, garlic, wild garlic, white onion, yellow onion and red onion) are shown in Figure 7 – Figure 12.

The local climate conditions

This study was performed in area of Zohor, Slovak Republic. It is situated on the western Slovakia (Zahorska lowland). Zohor belongs to warmer areas in Slovakia. Zahorska lowland is characterized by the cultivation of *Allium* plants such as onion, leek and garlic. The average annual rainfall is 600 mm and the average annual temperature is 9.5 °C.

Chemicals and extraction

High-purity chemical reagents were used for all operations. Folin-Ciocalteu assay and gallic acid were purchased from Merck, Darmstadt, Germany. Sodium carbonate, ethanol and 2,2-diphenyl-1-picrylhydrazyl radical (DPPH[•]) were obtained from Sigma-Aldrich (St. Louis, Missouri, USA). Ethanol extracts were prepared by adding 50 mL of 80% ethanol to 25 g milled sample and was extracted in the Twisselmann apparatus for 12 h. Samples were then filtered through filter paper (130 g.m⁻², Filtrak, Thermalbad Wiesenbad, Germany) and kept at 8 °C for further analysis.

Spectrophotometric determination of total polyphenols

Total polyphenols were determined by the method of Lachman et al. (2003) and expressed as milligrams of gallic acid equivalent per kilogram (mg GAE.kg⁻¹) fresh mater (FW). Gallic acid is usually used as a standard unit for phenolics content determination because a wide spectrum of phenolic compounds. The total polyphenol content was estimated using Folin-Ciocalteu assay. The Folin-Ciocalteu (Merck) phenol reagent was added to a volumetric flask containig 100 mL of extract of plants samples (leek, onion, garlic, wild garlic).

The content was mixed and 5 mL of a sodium carbonate solution by Merck (20%) was added after 3 min. The volume was adjusted to 50 mL by adding of distilled water. After two hours, the samples were centrifuged for 10 min. and the absorbance was measured at 765 nm (Spektrofotometer Shimadzu UV-1800; Shimadzu, Kyoto, Japan) of wavelength against blank. The concentration of polyphenols was calculated from a standard curve plotted with known concentration of gallic acid.

Spectrophotometric determination of antioxidant activity

Antioxidant activity was measured by the (Brand-Williams et al., 1995) method-using a compound DPPH[•] (2,2-diphenyl-1-pikrylhydrazyl). 2,2-diphenyl-1-pikrylhydrazyl (DPPH[•]) by Sigma – Aldrich, USA was pipetted to cuvette (3.9 cm³) then the value of absorbance, which corresponded to the initial concentration of DPPH[•] solution in time A₀ was written. Then 0.1 cm³ of the followed solution was added and then the dependence A = f (t) was immediately started to measure. The absorbance of 10 minutes at 515.6 nm in the spectrophotometer (Shimadzu UV – 1800, Shimadzu, Kyoto, Japan) was mixed and measured. The percentage of inhibition reflects how antioxidant compound are able to remove DPPH[•] radical at the given time.

$$\% \text{ inhibition DPPH} = \frac{A_0 - A_t}{A_0} \times 100 (\%)$$

Statistical analysis

Results were statistically evaluated by the Analysis of Variance. All the assays were carried out in quadruplicates and results are expressed as mean ±SD. The data were subjected to the F-test in the one-way analysis of variance (ANOVA) If the *p*-value of the F-test is less than 0.05, there is a statistically significant difference between the at the 95% confidence level; the Multiple Range Tests will tell which means are significantly different from which others. The method currently being used to discriminate among the means of Fisher's least significant difference (LSD) procedure. Using statistical software Statgraphics Centurion XVI.I (Statpoint Technologies, The Plains, Virginia, USA) and a correlation analysis (Microsoft Excel, Washington, USA) was used.

RESULTS AND DISCUSSION

In this work the content of polyphenols and antioxidant activity (% inhibition) in leek, wild garlic, garlic, white onion, yellow onion and red onion was tested and evaluated. The results of antioxidant activity value and the content of total polyphenols in selected samples of the

genus *Allium* are summarized in Table 1.

The content of total polyphenols in selected samples species of the genus *Allium* ranges from 83.59 mg GAE.kg⁻¹ (white onion) to 758.63 mg GAE.kg⁻¹ (red onion). Based on the measured content of total polyphenols in leek, wild garlic, garlic, white onion, yellow onion and red onion can be in the ensuing order: white onion <leek <yellow onion <garlic <wild garlic <red onion.

Dalaram (2016) published that the content of total polyphenols was recorded in selected species of the genus *Allium* (garlic, white onion, yellow onion and red onion) in the interval from 322.83 mg.kg⁻¹ FW to 626.61 mg.kg⁻¹ FW. In comparison to our determined values of polyphenols their results were in similar interval. Our results are higher compared to **Benkeblia (2005)**, who has published the content of total polyphenols in garlic (490 mg.kg⁻¹ FW). **Kavalcová et al. (2014)** that the content of total polyphenols was recorded in selected varieties of leek is in the interval from 210.67 mg GAE.kg⁻¹ FW to 254.80 mg GAE.kg⁻¹ FW. In comparison to our determined values of polyphenols their results were in similar interval. Statistically significant highest content of total polyphenols (*p* <0.05) was recorded in red onion in variety of Karmen (758.63 ±12.30 mg GAE.kg⁻¹ FW). Statistically significant the lowest content of total

Table 1 The averag values of antioxidant activity (% inhibition FW) and content of total polyphenols (mg GAE.kg⁻¹ FW) in selected species of the genus *Allium*.

Plant	Variety	AOA (% ±SD)	TPC (mg GAE.kg ⁻¹ ±SD)
Leek	Starozagorski kamuš	7.19 ±0.39 ^{a)}	167.71 ±10.09 ^{b)}
Wild garlic	-	26.66 ±0.74 ^{d)}	687.36 ±17.85 ^{e)}
Garlic	Dukat	24.25 ±0.52 ^{c)}	600.30 ±7.89 ^{d)}
Onion (white)	Ala	12.71 ±0.67 ^{b)}	83.59 ±10.62 ^{a)}
Onion (yellow)	Bamberger	22.79 ±1.36 ^{c)}	466.87 ±14.39 ^{e)}
Onion (red)	Karmen	53.55 ±1.84 ^{e)}	758.63 ±12.30 ^{f)}
	HD_{0.05}	1.56322	18.7296
	HD_{0.01}	2.1474	25.6612

Note: ^{a-f} values with different letters mean significant differences (*p* <0.05) among selected species of the genus *Allium*, values AOA and TPC are expressed as arithmetic mean.

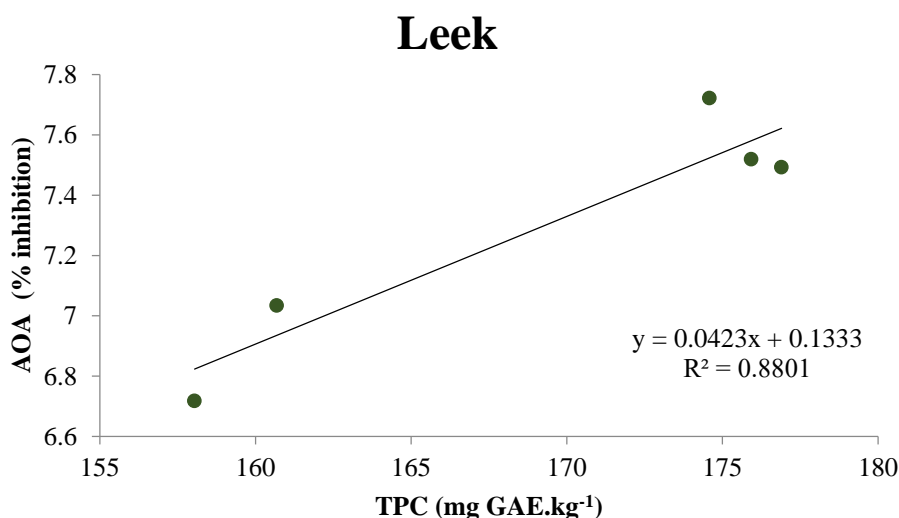

Figure 1 Correlation between antioxidant activity and total polyphenols content of leek (Starozagorski kamuš).

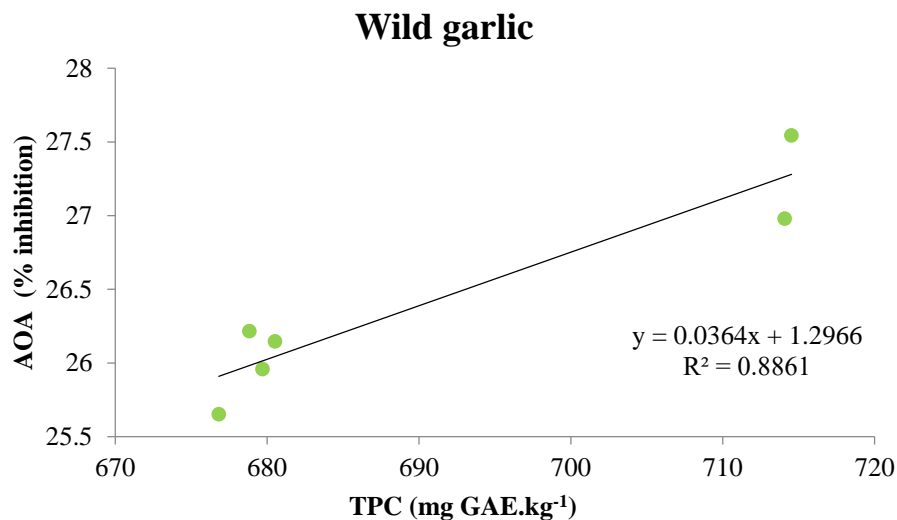

Figure 2 Correlation between antioxidant activity and total polyphenols content of wild garlic.

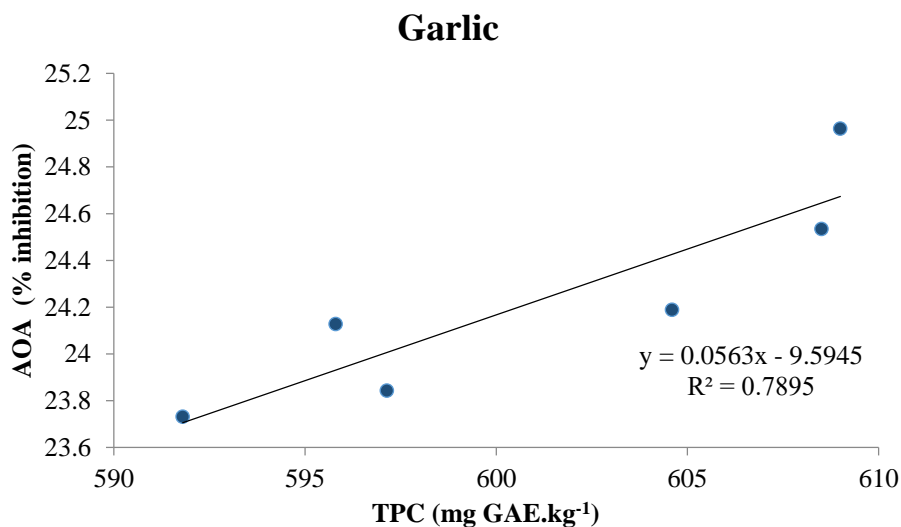

Figure 3 Correlation between antioxidant activity and total polyphenols content of garlic (Dukat).

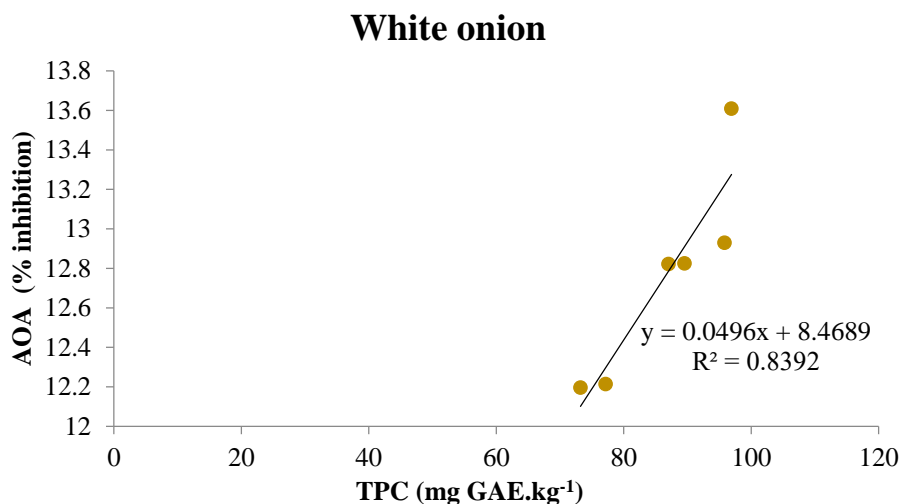

Figure 4 Correlation between antioxidant activity and total polyphenols content of white onion (Ala).

polyphenols ($p < 0.05$) was recorded in white onion in variety of Ala (83.59 ± 10.62 mg GAE.kg⁻¹ FW).

The last indicator that has been evaluated and compared was the antioxidant activity of selected species of the genus *Allium* (wild garlic, leek, garlic, white onion, yellow

onion red onion). The values of antioxidant activity were in interval from $7.19 \pm 0.39\%$ (leek) to $53.55 \pm 1.84\%$ inhibition FW (red onion). Based on the measured values of antioxidant activity in leek, wild garlic, garlic, white onion, yellow onion and red onion can be in the ensuing

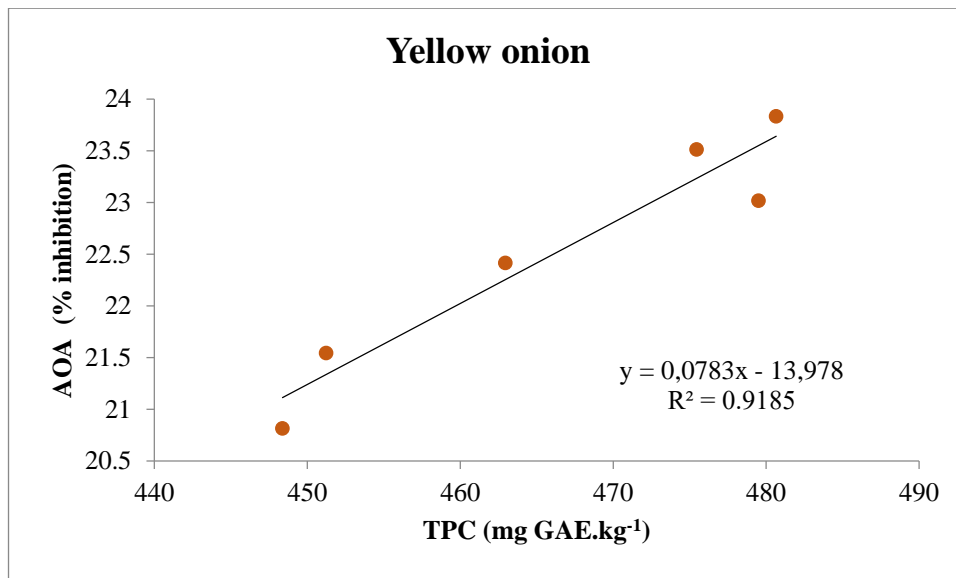

Figure 5 Correlation between antioxidant activity and total polyphenols content of yellow onion (Bamberger).

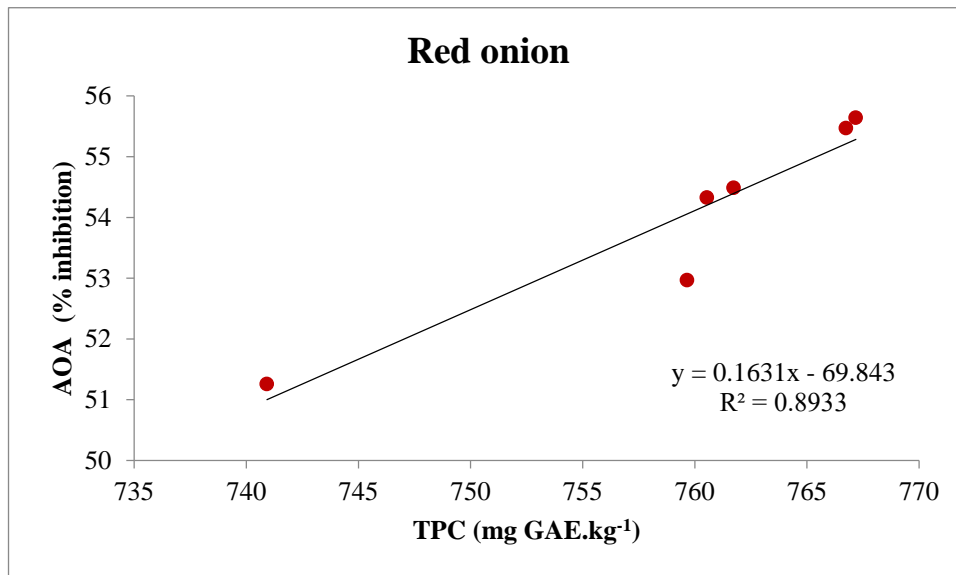

Figure 6 Correlation between antioxidant activity and total polyphenols content of red onion (Karmen).

order: leek <white onion <yellow onion <garlic <wild garlic <red onion. Our results are lower to Ashwini (2013) who has published that the values of antioxidant activity in onion were 57.11% inhibition.

Our results are in a similar range to Shon et al. (2004) and Prakash et al. (2007). Kavalcová et al. (2014) reported that the value of antioxidant activity was recorded in leek (*Allium porrum* L.) in the interval from 8.55 to

12.92% inhibition FW. Statistically significant highest values of antioxidant activity ($p < 0.05$) was recorded in red onion in variety of Karmen ($53.55 \pm 1.84\%$ FW). Statistically significant the lowest content of total polyphenols ($p < 0.05$) was recorded in leek in variety of Starozagorski kamuš ($7.19 \pm 0.39\%$ FW). Benkeblia (2005) stresses that antioxidant activity depended on both phenolics and sulfur compounds of *Alliums*.



Figure 7 Red onion (Karmen).



Figure 8 White onion (Ala).



Figure 9 Yellow onion (Bamberger).



Figure 10 Leek (Starozagorski kamuš). **Figure 11** Garlic (Dukat).

Figure 12 Wild garlic (leaves).

In this study we have found positive correlation between the content of total polyphenols and antioxidant activity ($r = 0.938$, $r = 0.941$, $r = 0.889$, $r = 0.916$, $r = 0.958$, $r = 0.945$). Results are shown in Figure 1, Figure 2, Figure 3, Figure 4, Figure 5, Figure 6. These results are in good accordance with Cheng et al. (2013), who reported a positive correlation between total antioxidant activity and total phenolic content in onion ($r = 0.793$ - $r = 0.912$). Lenková et al. (2016) also observed a positive relationship between the content of polyphenolic compounds and antioxidant activity in selected species of the genus of *Allium*.

CONCLUSION

The present paper was focused on the content of total polyphenols and antioxidant activity in selected *Allium* species. The results suggest that red onion and wild garlic contains higher amount of polyphenolic substances. The six *Allium* species for this study represent majority *Allium* species currently grown in Slovakia. The coefficient of correlation confirmed strong dependency between the antioxidant activity and the total content of polyphenols. Content of polyphenolic compounds contained in *Allium* species are quite variable. It is also important to note that the main factor affecting the content of total polyphenols are species and variety. The content of chemoprotective compounds may be affected also by agrochemical composition of the soil for example content of humus, climatic condition and nutrients. The results obtained in this work provide further information about of the content of total polyphenols and antioxidant activity in *Allium* species.

REFERENCES

- Ashwini, M., Balaganesh, J., Balamurugan, S., Murugan, S. B., Sathishkumar, R. 2013. Antioxidant activity in in Vivo and in Vitro cultures of onion varieties (Bellary and CO 3). *Food and Nutrition Sciences*, vol. 4, no. 9, p. 918-923. <https://doi.org/10.4236/fns.2013.49119>
- Benkeblia, N. 2005. Free-radical scavenging capacity and antioxidant properties of some selected onions (*Allium cepa* L.) and garlic (*Allium sativum* L.) extracts. *Brazilian Archives of Biology and Technology*, vol. 48, no. 5, p. 753-759. <https://doi.org/10.1590/S1516-89132005000600011>
- Brand-Williams, W., Cuvelier, M. E., Berset, C. 1995. Use of a free radical method to evaluate antioxidant activity. *Lebensmittel-Wissenschaft und Technologie*, vol. 28, no. 1, p. 25-30. [https://doi.org/10.1016/S0023-6438\(95\)80008-5](https://doi.org/10.1016/S0023-6438(95)80008-5)
- Bvenura, C., Sivakumar, D. 2017. The role of wild fruits and vegetables in delivering a balanced and healthy diet. *Food Research International*, vol. 99, no. 1, p. 15-30. <https://doi.org/10.1016/j.foodres.2017.06.046> PMID:28784471
- Dalaram, I. S. 2016. Content of total polyphenols and antioxidant activity in varieties of onion and garlic. *Potravinárstvo Slovak Journal of Food Sciences*, vol. 10, no. 1, p. 444-451. <https://doi.org/10.5219/658>
- Fritsch, R. M., Keusgen, M. 2006. Occurrence and taxonomic significance of cysteine sulphoxides in the genus *Allium* L. (*Alliaceae*). *Phytochemistry*, vol. 67, no. 11, p. 1127-1135. <https://doi.org/10.1016/j.phytochem.2006.03.006> PMID:16626766
- Cheng, A., Chen, X., Jin, Q., Wang, W., Shi, J., Liu, Y. 2013. Comparison of phenolic content and antioxidant capacity of red and yellow onions. *Czech Journal of Food Science*, vol. 31, no. 5, p. 501-508.
- Kamenentsky, R., Rabinowitch, H. D. 2017. Physiology of Domesticated Alliums: Onions, Garlic, Leek, and Minor Crops. *Encyclopedia of Applied Plant Sciences*, 2nd ed., vol. 3, p. 255-261.
- Kavalcová, P., Bystrická, J., Tomáš, J., Karovičová, J., Kuchtová, V. 2014. Evaluation and comparison of the content of total polyphenols and antioxidant activity in onion, garlic and leek. *Potravinárstvo Slovak Journal of Food Sciences*, vol. 8, no. 1, p. 272-276. <https://doi.org/10.5219/394>
- Kęsík, T., Błażewicz-Woźniak, M., Michowska, A. E. 2011. Influence of mulching and nitrogen nutrition on bear garlic (*Allium ursinum* L.) growth. *Acta Scientiarum Polonorum – Hortorum Cultus*, vol. 10, no. 3, p. 221-233.
- Lachman, J., Proněk, D., Hejtmánková, A., Pivec, V., Faitová, K. 2003. Total polyphenol and main flavonoid antioxidants in different onion (*Allium cepa* L.) varieties. *Scientia Horticulturae*, vol. 30, no. 4, p. 142-147.
- Lee, G. A., Kwon, S. J., Park, Y. J., Lee, M. C., Kim, H. H., Lee, J. S., Lee, S. Y., Lee, S. Y., Gwag, J. G., Kim, C. H., Ma, K. H. 2011. Cross-amplification of SSR markers developed from *Allium sativum* to other *Allium* species. *Scientia horticulturae*, vol. 128, no. 4, p. 401-407. <https://doi.org/10.1016/j.scienta.2011.02.014>
- Lenkova, M., Bystrická, J., Tóth, T., Hrstkova, M. 2016. Evaluation and comparison of the content of total polyphenols and antioxidant activity of selected species of the genus *Allium*. *Journal of Central European Agriculture*, vol. 17, no. 4, p. 1119-1133. <https://doi.org/10.5513/JCEA01/17.4.1820>
- Manero, J., Philips, C., Ellison, B., Lee, S. Y., Nickols-Richardson, S. M., Chapman-Novakowski, K. M. 2017. Influence of seasoning on vegetable selection, liking and intent to purchase. *Appetite*, vol. 116, no. 1, p. 239-245. <https://doi.org/10.1016/j.appet.2017.04.035> PMID:28472642
- Miller, M. G., Thangthaeng, N., Poulouse, S. M., Shukitt-Hale, B. 2017. Role of fruits, nuts, and vegetables in

maintaining cognitive health. *Experimental Gerontology*, vol. 94, p. 24-28. <https://doi.org/10.1016/j.exger.2016.12.014> PMID:28011241

Mohamed, S. M., Jaleel, G. A. A., Abdallah, H. M. I., Bashandy, S. A. E., Salama, A. B., Mahmoud, A. H. 2016. Hypoglycemic, hypolipidemic and antioxidant activities of *Allium porrum* leaves extract in streptozotocin-induced diabetic rats. *International Journal of Pharm Tech Research*, vol. 9, no. 11, p. 187-200.

Naheed, Z., Cheng, Z., Wu, C., Wen, Y., Ding, H. 2017. Total polyphenols, total flavonoids, allicin and antioxidant capacities in garlic scape cultivars during controlled atmosphere storage. *Postharvest Biology and Technology*, vol. 131, p. 39-45. <https://doi.org/10.1016/j.postharvbio.2017.05.002>

Poojarym, M. M., Putnik, P., Kovačević, D. B., Barba, F. J., Lorenzo, J. M., Dias, D. A., Shipigelman, A. 2017. Stability and extraction of bioactive sulfur compounds from *Allium* genus processed by traditional and innovative technologies. *Journal of Food Composition and Analysis*, vol. 61, p. 28-39. <https://doi.org/10.1016/j.jfca.2017.04.007>

Prakash, D., Singh, B. N., Upadhyay, G. 2007. Antioxidant and free radical scavenging activities of phenols from onion (*Allium cepa*). *Food chemistry*, vol. 102, no. 4, p. 1389-1393. <https://doi.org/10.1016/j.foodchem.2006.06.063>

Radovanović, B., Mladenović, J., Radovanović, A., Pavlović, R., Nikolić, V. 2015. Phenolic Composition, Antioxidant, Antimicrobial and Cytotoxic Activities of *Allium porrum* L. (Serbia) Extracts. *Journal of Food and Nutrition Research*, vol. 3, no. 9, p. 564-569.

Ramirez, D., Locatelli, D. A., González, R. E., Cavagnaro, P. F., Camargo, A. B. 2017. Analytical methods for bioactive sulfur compounds in *Allium*: An integrated review and future directions. *Journal of Food Composition and Analysis*, vol. 61, p. 4-19. <https://doi.org/10.1016/j.jfca.2016.09.012>

Saxena, M., Saxena, J., Nema, R., Singh, D., Gupta, A. 2013. Phytochemistry of Medicinal Plants. *Journal of Pharmacognosy and Phytochemistry*, vol. 1, no. 6, p. 168-182.

Shon, M. Y., Choi, S. D., Kahng, G. G., Nam, S. H., Sung, N. J. 2004. Antimutagenic, antioxidant and free radical scavenging activity of ethyl acetate extracts from white, yellow and red onions. *Food and Chemical Toxicology*, vol. 42, no. 4, p. 659-666. <https://doi.org/10.1016/j.fct.2003.12.002> PMID:15019191

Tighe-Neira, R., Alberdi, M., Arce-Johnson, P., Romero-Romero, J. L., Reyes-Díaz, M., Inostroza-Blancheteau, C. 2017. Foods with functional properties and their potential uses in human health. In Waisundara, V. et al. *Superfood and Functional Food-An Overview of Their Processing and Utilization*. London, UK : InTech p. 189-190. ISBN: 978-953-51-2920-2.

Acknowledgments:

This work was supported by grant KEGA No. 011SPU-4/2017 and VEGA No. 1/0139/17.

Contact address:

Ján Kovarovič, Slovak University of Agriculture in Nitra, Faculty of Biotechnology and Food Sciences, Department of Chemistry, Tr. A. Hlinku 2, 949 76 Nitra, Slovakia, E-mail: xkovarovic@is.uniag.sk

Judita Bystrická, Slovak University of Agriculture in Nitra, Faculty of Biotechnology and Food Sciences, Department of Chemistry, Tr. A. Hlinku 2, 949 76 Nitra, Slovakia, E-mail: judita.bystricka@centrum.sk

Alexander Fehér, Slovak University of Agriculture in Nitra, Faculty of European Studies and Regional Development, Department of Sustainable Development, Tr. A. Hlinku 2, 949 76 Nitra, Slovakia, E-mail: alexander.feher@uniag.sk

Marianna Lenková, Slovak University of Agriculture in Nitra, Faculty of Biotechnology and Food Sciences, Tr. A. Hlinku 2, 949 76 Nitra, Slovakia, E-mail: mariannalenkova@gmail.com



IMPACT OF SENSORY MARKETING ON CONSUMER'S BUYING BEHAVIOUR

Andrej Géci, Ludmila Nagyová, Jana Rybanská

ABSTRACT

Knowing consumer's behaviour, his/her preferences and reactions provides company with better chance to establish itself in trade. While doing research, it is very important to analyse and search for answers to questions why customers do the shopping, what they buy, when, where and how often they do the shopping. The decision to buy a product or service is influenced by many factors, including not only cultural, social, psychological but also personal factors. Sensory marketing itself is coming to the foreground and more and more people are realising its position. This document is dedicated to issue which is useful not only for companies but also for consumer himself. It deals with involvement of sensory and tries to clarify their importance in business communication. The aim of research document was evaluation of senses and their influence on consumer's behaviour in shopping area. The comparison of generations and their buying habits during shopping behaviour was also important. Primary data were gained through a questionnaire which was realised on sample of 312 respondents. The impact of sensory marketing was generally aimed on factors which influence consumers while doing shopping. In questionnaire, respondents were divided into three groups/generations according to their age (young, middle aged and elder). The questionnaire research confirmed that sight was the most influenced sense when doing shopping (62%). Irrational consumer's behaviour was also confirmed. There were some differences shown among generation groups. Research confirmed that the sensory perception of these generations is different. More assumptions were formulated for a deeper analysis and their relations were verified by means of statistical test (Pearson Chi-kvadrat goodness-to-fit test). On the basis of required results was confirmed that most of customers do not realise the impact of individual senses on shopping behaviour.

Keywords: sensory marketing; human senses; consumer; shopping behaviour; impact of factors

INTRODUCTION

The task of sensory marketing is to persuade consumers to give preference to buy products and services among others. In order to manage that five senses are used. This type of marketing is based on requirements of consumers. Customer's loyalty influenced by their experience has a big role (Hultén et al., 2009).

Terms *taste*, *touch* and *sight* have been a part of marketing area for longer time, but term *sensory marketing* has appeared primarily after application of other senses (smell and hearing). According to this, we can define term sensory marketing as relatively young sphere of marketing, because using these tools appeared on European and international market at the turn of 20th century (Martínez, 2007).

Krishna (2012) defines sensory marketing as a type of marketing whose main task is to connect senses and influence consumers' perception, judgement and behaviour (Hultén, 2011).

Sensory marketing deals with creating atmosphere in stores. Its aims are five senses – visual, auditory, tactile,

olfactive and gustative. Its task is to have an indirect impact on consumers' senses and arouse emotions which may influence them (Lee and O' Mahony, 2005).

Visual marketing is based on visual sense. It is a special kind of marketing, because application of its particular parts is complicated. Sight belongs to the most used sense among the others (Chingching, 2001).

Auditory marketing belongs to later forms of marketing. Gradually, it is becoming an integral part of our daily routine – shopping. As emerged from marketing researches, music in stores has an impact on time spent in stores and also on the amount of money spent. From the psychological point of view, the consumers are influencable by music. If customers listen to music they like while shopping, they are willing to spend more money (McLeod, 2014).

Tactile marketing is based on touch, by means of which the customer familiarizes with a product and its functional characteristics. Touch is a very significant sense for shopping because there are many products where it is important to touch them. Touch itself is influenced not

only by shape and structure of package, but also by its graphical aspect (Wright et al., 2013; Mokry et al., 2016).

Olfactory marketing – a scent in stores as a marketing tool is used since time immemorial. People are able to recognize more than four thousand scents. As mentioned above, it is necessary to approach this marketing with sense and reason (Winer, 2009).

Gustatory marketing – taste is considered to be one of the most oblivious senses, which human is capable to perceive. Taste is related to other senses and their combination creates final gustatory experience, e. g. taste and smell, taste and sound (Chylinski, 2011).

The above mentioned five senses serve to enable people processing perceived information by means of sense organs. When hearing the term sense organs we recall five basic senses: sight, olfactory sense, gustatory sense, auditory sense and tactile sense. On one hand, it is logical that people use these senses in shopping process to gain necessary information in order to make right decision. On the other hand, naturally, the same applies to the sellers (Lindstrom, 2006; Krishna, 2013).

Consumer perceives the setting of a store through all of senses. This perception can be defined as a process on the basis of which people organise, select and gain information from the surrounding (Berčík et al., 2016).

Consumer's behaviour is behaviour of an individual, groups or organisations on the market of products and services where the main aim is to satisfy their needs (Nagyová, Berčík and Horská, 2014; Kozelová et al., 2011). This term also includes also usage, sale and purchase of products and services (Perner, 2016; Swait and Adamowicz, 2001).

Nagyová (2012) claims that decision-making of consumers on the food market is influenced by trends in food industry and also by eating habits and consumers' relations (Plassmann et al., 2007; Strack et al., 2006).

Decisions made by consumers might be influenced by other factors as well, e.g. price, brand, country of origin or choice of shop (Kapsdorferová, 2008; Soars, 2009). Lately, country of origin is coming to fore as one of the main factors which influences consumers when buying food. This was confirmed also in document by Kubelaková and Šugrová (2017). Among factors which influence consumers belong their preferences though which they make decisions (Guziy, Šedík and Horská, 2017). Preferences are different with each consumer. It was found out that there are some specific differences in consumers' behaviour on the basis of sense preferences of men and women (Bruwer et al., 2011). According to researches, women are more impulsive shoppers. This fact is caused by failure of self-control which leads to rash shopping (Baumeister, 2002).

Scientific hypothesis

We set assumptions on which we applied pivot tables. Subsequently, we verified assumptions through one mathematical-statistical method - Pearson Chi-kvadrat of goodness-to-fit test.

Assumption No. 1: We assume no the dependence between sex of respondent and the most used sense when shopping.

Assumption No. 2: We assume no the dependence between colour of product and sex of respondent.

Assumption No. 3: We assume no the dependence between sound factors and sex of respondent.

Assumption No. 4: We assume no the dependence between gustatory factor and sex of respondent.

Assumption No. 5: We assume no the dependence between time horizon of day when doing shopping and sex of respondent.

MATERIAL AND METHODOLOGY

For research purposes, a questionnaire research was held in physical and paper form in Slovakia. Research was innovated and it was connected to questionnaire survey (Géci; 2017). In period from February to March 2017 we gained sample of 312 respondents of different age groups. The aim was to gain relevant number of answers for questionnaire research. Questions in questionnaire were divided into two parts (demographic data and general sensory marketing) and questions offering alternative answers.

According to structure of respondents, there were 51% of women and 49% men. Our aim was to gain the answers from respondents of different age groups. Most respondents marked interval from 6-18 year (38%). Second interval which represented middle generation (from 19 to 65 years), was marked by 30% of respondents. People of elder generation represented 32% of total number of respondents. The highest achieved educational interval was high school with leaving exam (35%), high school without leaving exam (23%) and primary school (19%). The aim is to make the most detailed evaluation of sensory marketing. Its explanatory power will be most significant. Based on results, we set assumptions which we subsequently confirm or dismiss by chosen statistics methods. Pivot tables will be used to verify assumptions. Assumptions will be verified by method of mathematical statistics – Pearson Chi-kvadrat of goodness-to-fit test.

We will determine the probability level – alpha ($\alpha = 0.05$), which will be compared to the significance level (*p-value*). Based on alpha (α), we can evaluate the hypothesis with the *p-value* comparison. If *p-value* is lower than alpha (α), we will refuse H_0 . If *p-value* is higher than alpha (α), we will not refuse H_0 .

RESULTS AND DISCUSSION

Data were gained from 312 respondents and bigger part consisted of women (51%). Each age interval reached nearly same number (%) of respondents. The highest educational status (high school with leaving examination) has 35% of respondents. The economical status *Student* was marked by most respondents (47%) and second biggest group were retired people (32%).

Monthly income of respondents ranged in large range (Figure 1). From the graph we can see that most of respondents claimed that their monthly income is from 301 € to 500 €. Another most marked group was income from 101 € to 300 € (27%). Those results were expected because questionnaire research was aimed on all three existential generations. Interesting fact is that income above 1,001 € and more is maintained by only two percents of our research. Regarding the permanent residence, 56% of respondents stated that they live in a village, whereas other 44% live in a city.

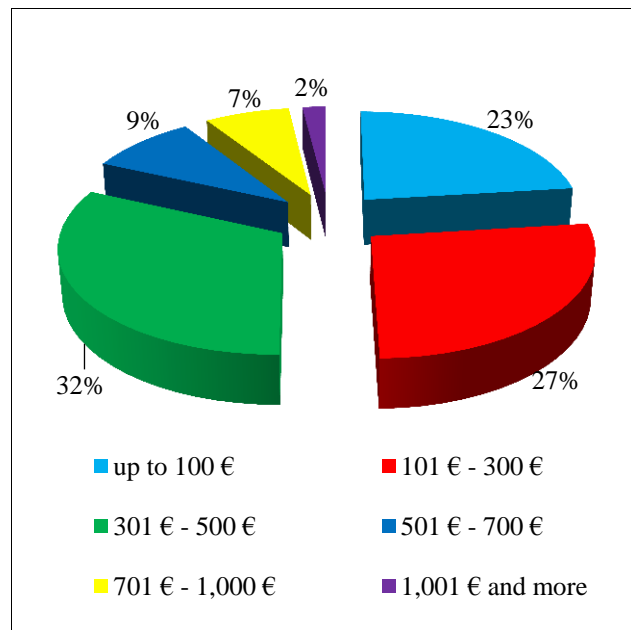

Figure 1 Monthly income of the respondent.

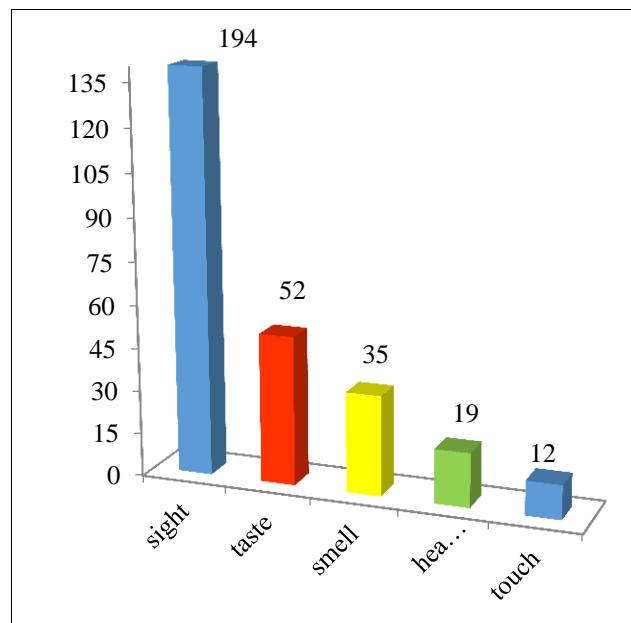

Figure 2 The most affected sense when buying food.

Another question was aimed on sense which often influences respondent the most while purchasing. Sight was on the first place (62%). Gustative sense was on the second place with 17%, then olfactory sense and on the last place hearing (Figure 2). Based on above mentioned and also on research *Dílčí výsledky výzkumu GA 402/02/0152 (Koudelka, 2008)* we may claim that sight is the most significant sense among other senses which influence consumer in his shopping decision-making (Hultén, 2012; Bloch, 2008).

Statistical observation on set assumption was realized on the basis of these factors – whether there is relation between sex of respondent and the most used sense when shopping.

H_0 : There is no the dependence between sex of respondent and the most used sense when shopping.

H_1 : There is the dependence between sex of respondent and the most used sense when shopping.

In order to verify this relation we use in pivot tables p-value of Pearson Chi-kvadrat goodness-of-fit test and significance level:

$$p\text{-value} = 0.4007 > \alpha = 0.05$$

We accept null hypothesis and we claim that with 95% reliability there is the dependence between sex of respondent and the most used sense when shopping. Based on results of Pearson Chi-kvadrat goodness-of-fit test we consider our assumption to be correct.

Following question dealt with irrational behavior which is realized by consumer (Figure 3). We asked whether they bought some food only on the basis of senses. Most of respondents answered positively, concretely 79%.

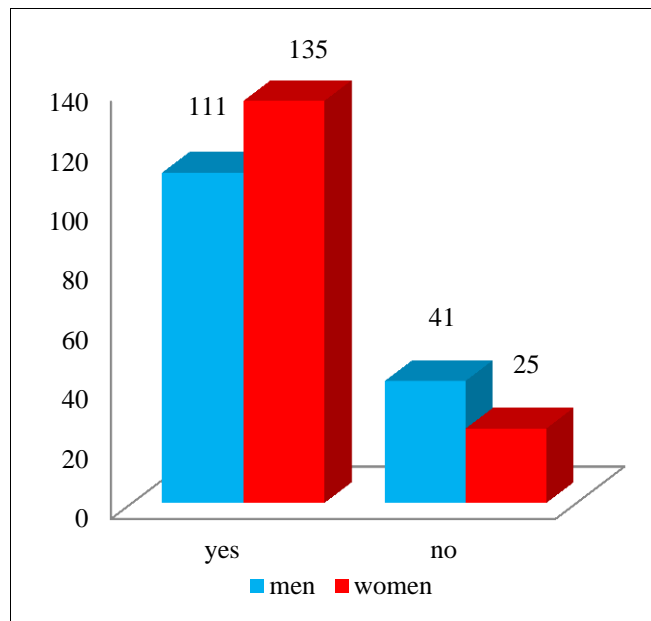

Figure 3 Comparison of women and men.

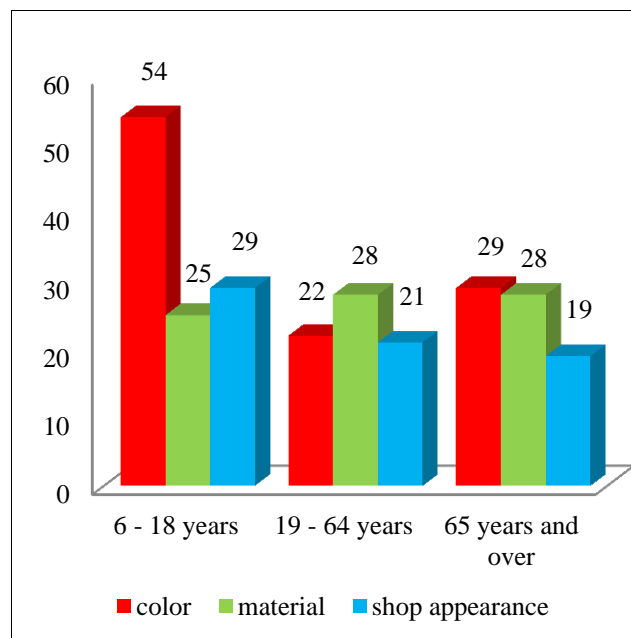

Figure 4 Comparing visual facts on generations.

Research held by **Dunning (2007)** also confirmed that most of consumers behave irrationally. Comparison among sexes showed that 84% of women and 73% of men purchased food because of sense perception.

Next we evaluated basic senses of respondent's perception. Questions referred to factors which affect purchase decision-making. We aimed on all five senses, so all of them were evaluated in questionnaire research.

On the basis of visual evaluation we can say that respondents took notice of colourfulness of particular food – their surface or packaging (34%). Similar visual character was researched in document by **Mueller and Szolnoki (2010)**. Furthermore they take notice of design of packaging. This fact was marked by 26% of asked people. On the third place was shop. It was marked by 22% of respondents. Figure 4 shows comparison of generation differences through visual factor.

All three generation groups have the same visual factor same, there is only change in multiplicity. Young generation prefer colour (50%). Secondly, they notice design of a store and its cleanliness (27%), another factor is material (23%). Regarding middle generation are visual preferences follows: on the first place is material (39%), on the second is colour (31%) and thirdly it is design (30%). Elder generation first takes notice of material (37%), then colours (38%) and finally design (25%). We can claim that existence of differences is clear, whether it is connected to particular sexes or consumers themselves. According to authors **Bruwer, Saliba and Miller (2011)** we claim that there is existence of individual differences among particular consumers and their shopping performance.

One of visual factors of this study is colour. We aimed on colour captivation in store. Most respondents marked red (39%), then yellow (20%) and green (15%). These three

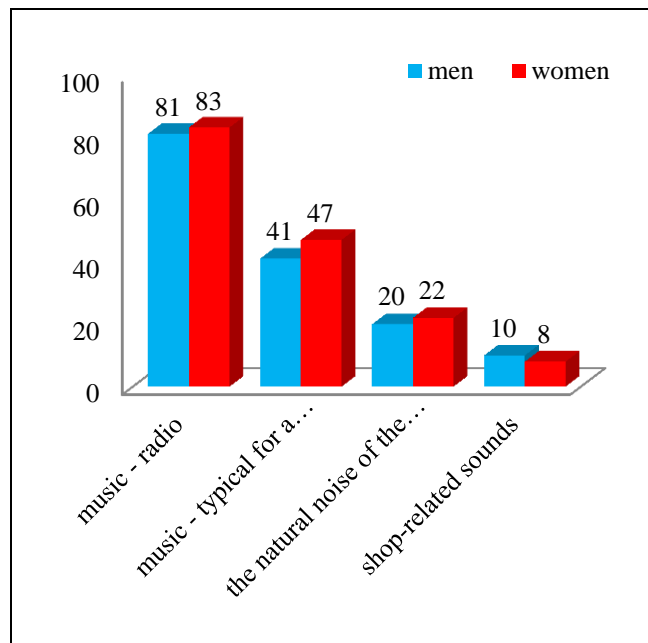

Figure 5 Comparison sound factor.

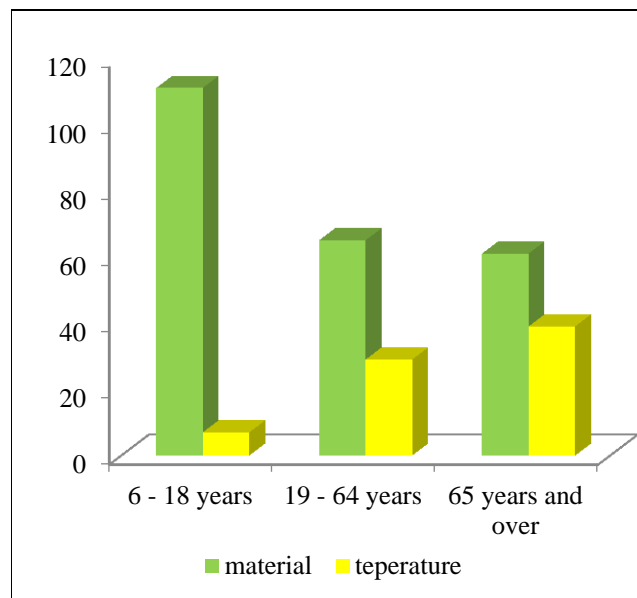

Figure 6 Comparison of tactile factors.

colours were more or less expected because red colour calls for activity and attracts attention of buyers. This colour is used to signalise sales or discounts. Yellow colour is colour of gold and it expresses energy and joy. Combination of these two colours (red and yellow) is mostly visible in chain stores. "Green" bio food is coming to fore lately. They are marked by green colour. This colour symbolises nature, environment, activity and it has calming effect (Chu and Rahman, 2012). Research studies claim that consumer is probably by more than 78% capable to remember word or phrase, which is printed colourfully, because it activates the right hemisphere of brain and printed word (text) activates the left hemisphere of brain (Aprilianty et al., 2016).

Statistical observation on set assumption: whether there is not relation between colour of product and sex of respondent.

H_0 : There is no the dependence between colour of product and sex of respondent.

H_1 : There is the dependence between colour of product and sex of respondent.

This relation we will use p-value in pivot tables from Pearson Chi-kvadrat goodness-of-fit test and significance level:

$$p\text{-value} = 0.7090 > \alpha = 0.05$$

We accept null hypothesis and claim that with 95% reliability there is the dependence between colour of product and sex of respondent. From the results of Pearson Chi-kvadrat goodness-of-fit test we consider our assumption to be correct.

Furthermore, the research was aimed on sound factors which affect consumers while shopping. More than half of

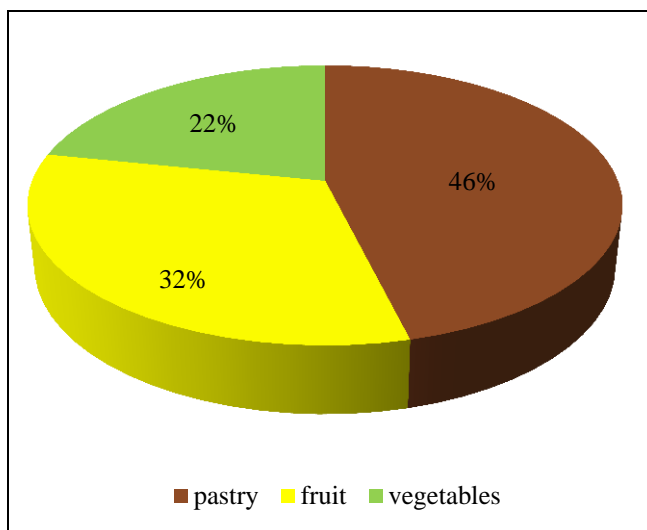

Figure 7 Sections where the smell is perceived the most.



Figure 8 Comparison of taste factor.

respondents (53%) stated that they are affected by radio music while shopping. 28% of respondents stated that it is typical music for a particular shop. On the third place was natural sound of a store (13%) and on the last were shop-related sounds (6%). According to research it is clear that all three generations are affected by music broadcast by radio. In Figure 5 we can see that the same fact was confirmed in comparison of men and women.

In accordance to above mentioned factors we realised statistical observation on set assumption – whether there is connection between sound factor and sex of respondent.

H_0 : There is no the dependence between sound factor and sex of respondent.

H_1 : There is the dependence between sound factor and sex of respondent.

To verify this relation we will use p-value in pivot tables from Pearson Chi-kvadrat goodness-of-fit test and significance level:

$$p\text{-value} = 0.9086 > \alpha = 0.05$$

We accept null hypothesis and claim that with 95% reliability there is the dependence between sound factor and sex of respondent. According to results of Pearson Chi-kvadrat goodness-of-fit test we consider our assumption to be correct.

Touch was another sense observed. From the research it is clear that 76% of respondents takes notice of product material via touch, i.e. packaging and surface treatment. 24% of respondents stated that they are affected by temperature in a store when choosing food. Based on generation comparison among particular groups of respondents we can claim that all generations take more notice of packaging material (Figure 6).

Due to results displayed in the graph we can say that the older the person the more attention he pays to temperature of a store. This is confirmed by fact that person becomes smarter consumer throughout his life.

The most affected olfactory factor is natural smell of store marked by 82% of respondents. Artificially created smell was marked by only 18% of respondents. We also asked in which part of store smell was the most intensive (Figure 7).

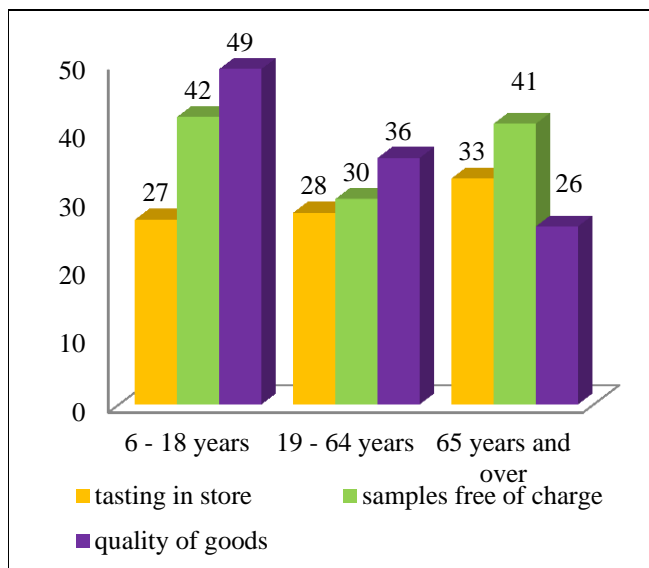

Figure 9 Comparison of taste factor.

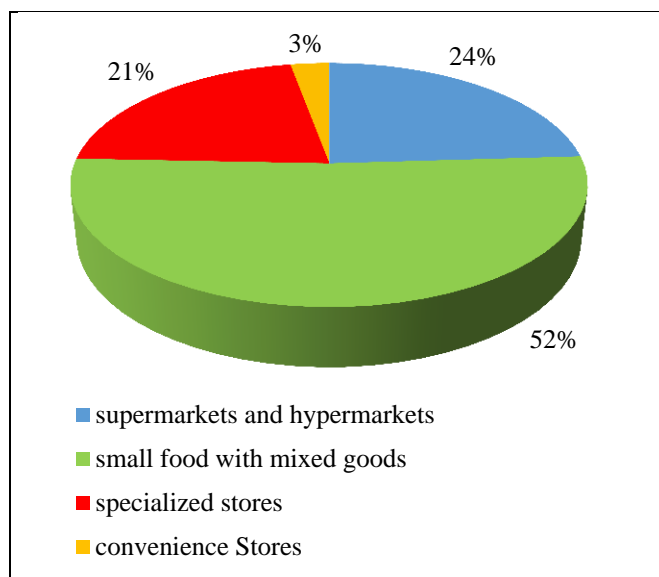

Figure 10 Shops.

From the facts mentioned above it is clear that the smell is most intense in pastry department, then in fruit and vegetables department. Olfactory factor was used in spices department, meat and dairy products department.

The last sense evaluated was gustatory sense. The most affecting factor were free samples marked by 36% of respondents, secondly the quality of product (35%) followed by degustation of food (29%). On the basis of comparison of both sexes (Figure 8) we can say that women were more affected by quality of products whereas men were by free samples.

To be more transparent, we decided to compare this question on the basis of generation differences. Figure 9 states differences of gustatory factor.

Graph shows that young and middle generations prefer quality of product, while elder generation is affected by free samples the most.

Last category of questionnaire questions concerns shopping it self. We asked how often respondents buy convenience food, e.g. bread, butter, milk, etc. More than half of respondents' (58%) answer was daily. 16% of respondents stated that they do shopping once a week and

13 % stated that they do shopping once within three or four days.

Application of statistical research assumption – whether there is relation between gustatory factor and sex of respondent.

H_0 : There is no the dependence between gustatory factor and sex of respondent.

H_1 : There is the dependence between gustatory factor and sex of respondent.

To verify this relation we will use p-value in pivot tables from Pearson Chi-kvadrat goodness-to-fit test and significance level:

$$p\text{-value} = 0.7130 > \alpha = 0.05$$

We accept null hypothesis and claim that with 95% reliability there is the dependence between gustatory factor and sex of a respondent. According to results of Pearson

Chi-kvadrat goodness-to-fit test we consider our assumption to be correct.

Following question dealt with in which time horizon of day consumers do shopping. Most of them answered (63%) that they perform this activity in the morning. Secondly, it was performed in the evening (16%). These results were expected – young and middle generations mostly do shopping before work/school or after work/school.

The penultimate question was aimed on stores. According to Figure 9 it is clear that most of respondents prefer shopping in general merchandise stores (52%). Secondly, supermarkets and hypermarkets (24%), then specialised stores (21%), like butcher's, chemist's, stationery.

Convenience store was on the last place. This kind of stores is slowly disappearing because of growth of supermarkets and hypermarkets. Due to their opening hours and broad sortiment of supermarkets and hypermarkets convenience stores have no chance.

Statistical observation on set assumption – whether there is no relation between time horizon of day when doing shopping and sex of respondent.

H_0 : There is no the dependence between time horizon of day when doing shopping and sex of respondent.

H_1 : There is the dependence between time horizon of day when doing shopping and sex of respondent.

To verify this relation we will use p-value in pivot tables from Pearson Chi-kvadrat goodness-to-fit test and significance level:

$$p\text{-value} = 0.5063 > \alpha = 0.05$$

We accept null hypothesis and claim that with 95% reliability there is the dependence between time horizon of day when doing shopping and sex of respondent. From the results of Pearson Chi-kvadrat goodness-to-fit test we consider our assumption to be correct.

Last question was aimed on average of money respondents spend in a week for convenience food only, e.g. bread, milk, butter, etc. (Figure 10).

According to research, 46% of respondents is willing to spend from 51 € to 101 €, next interval was up to 50 € and third was from 101 € to 150 €. Only 2% of respondents spend on convenience food from 251 € and more.

CONCLUSION

Based on research, it was confirmed that most consumers behave irrationally when doing shopping. According to submitted document it is clear that 246 respondents (79%) behaved irrationally, that means they purchased food based on perception of particular sense

Sight is the most important sense from all of senses, which influences consumer. Second sense is gustatory sense (17%), followed by olfactory sense. The least used sense is hearing.

Colour and material of surface of particular packaging of visual factors influences consumers. Colours that attract attention the most are red, yellow and green. The most affected auditory factor marked by consumers is radio

music. Touch is affected the most by material of particular products. Olfactory sense is affected by natural smell. Respondents marked that the most perceived smell is smell in these departments: pastry, fruit, vegetables, spices. Gustatory senses are affected most by free samples.

Young generation has different sense perception than elder generation. Their purchasing habits are different. According to research it was confirmed that elder generation does shopping more often than young and middle generation. Elder people do shopping rather in the morning, middle generation prefer to do shopping later in the evening.

According to generation comparison of respondents we claim that they perceive their surrounding through sense differently so they also perceive impact of sensory marketing differently.

REFERENCES

- Aprilianty, F., Purwanegara, M. S., Suprijanto. 2016. Effects of colour towards underwear choice based on electroencephalography. *Australasian marketing journal*, vol. 24, no. 4, p. 331-336. <https://doi.org/10.1016/j.ausmj.2016.11.007>
- Baumeister, F. R. 2002. Yielding to temptation: Self-Control failure, impulsive purchasing, and consumer behavior. *Journal of consumer research*, vol. 28, no. 4, p. 670-676. <https://doi.org/10.1086/338209>
- Berčík, J., Palúchová, J., Vietoris, V., Horská, E. 2016. Placing of aroma compounds by food sales promotion in chosen services business. *Potravinarstvo*, vol. 10, no. 1, p. 672-679. <https://doi.org/10.5219/666>
- Bloch, M. 2008. Truth and sight: generalizing without universalizing. *Journal of the royal anthropological institute*, vol. 14, no. 1, p. 522-532. <https://doi.org/10.1111/j.1467-9655.2008.00490.x>
- Bruwer, J., Saliba, A., Miller, B. 2011. Consumer behaviour and sensory preference differences: implications for wine product marketing. *Journal of Consumer Marketing*, vol. 28, no. 1, p. 5-18. <https://doi.org/10.1108/07363761111101903>
- Koudelka, J. 2008. *Female and male roles in the perspective of consumer marketing (Ženské a mužské role v perspektivě spotřebního marketingu)* – Dílčí výsledky výzkumu GA 402/02/0152. Praha : Oeconomica, p. 150. ISBN: 978-80-245-1401-7.
- Dunning, D. 2007. Self-Image motives and consumer behavior: How sacrosanct self-beliefs sway preferences in the marketplace. *Journal of consumer psychology*, vol. 17, no. 4, p. 237-249.
- Géci, A. 2017. Sensory marketing and irrational consumer behavior (Senzorický marketing a iracionálne spotrebiteľské správanie). In *Zborník príspevkov z konferencie ŠVOČ 2017 s medzinárodnou účasťou*. Nitra : SUA, p. 24-33. ISBN 978-80-552-1687-4.
- Guziy, S., Šedík, P., Horská, E. 2017. Comparative study of honey consumption in Slovakia and Russia. *Potravinárstvo*, vol. 11, no. 1, p. 472-479.
- Hultén, B., Broweus, N., van Dijk, M. 2009. What is Sensory marketing? *Sensory marketing*, p. 1-23. <https://doi.org/10.1057/9780230237049>
- Hultén, B. 2011. Sensory marketing: the multi-sensory brand-experience concept. *European Business Review*, vol. 23, no. 3, p. 256-273. <https://doi.org/10.1108/09555341111130245>
- Hultén, B. 2012. Sensory cues and shoppers' touching behaviour: the case of IKEA. *International Journal of Retail*

& *Distribution Management*, vol. 40, no. 4, p. 273-289. <https://doi.org/10.1108/09590551211211774>

Chingching, Ch. 2001. The Impacts of personality differences on products evaluations. *Association for consumer behaviour*, vol. 28 p 26-33.

Chu, A., Rahman, O. 2012. Colour, clothing, and the concept of „green“: Colour trend analysis and professionals' Perspectives. *Journal of global fashion marketing*, vol. 3, no. 4, p. 147-157.

Chylinski, M. 2011. Sensory marketing: research on the sensuality of products. *Journal of Consumer Psychology*, vol. 32, no. 5, p. 832-833.

Kapsdorferová, Z. 2008. *Manažment kvality*. Nitra, Slovakia : SPU, 120 p. ISBN 978-80-552-0115-3.

Kozelová, D., Mura, L., Matejková, E., Lopašovský, E., Vitoris, V., Mendelová, A., Bezáčková, M., Chreneková, M. 2011. Organic products, consumer behavior on market and european organic product market situation. *Potravinárstvo*, vol. 5, no. 3, p. 20-26. <https://doi.org/10.5219/96>

Krishna, A. 2012. An integrative review of sensory marketing: Engaging the senses to affect perception, judgment and behavior. *Journal of Consumer Psychology*, vol. 22, no. 3, p. 332-351. <https://doi.org/10.1016/j.jcps.2011.08.003>

Krishna, A. 2013. Introduction: What Is Sensory Marketing?. In *Customer Sense*.

Kubelaková, A., Šugrová, M. 2017. Habit or choice? The decision-making process of young generation in purchasing dairy products in the Slovak Republic. In *International day of science 2017. Economics, Management, Innovation day of science 2017*. Brno : Tribun EU s.r.o., p.113-120. ISBN 978-80-7455-060-7.

Lee, H. S., O'Mahony, M. 2005. Sensory evaluation and marketing: measurement of a consumer concept. *Food Quality and Preference*, vol. 16, no. 3, p. 227-235.

Lindstrom, M. 2006. Brand Sense: How to Build Powerful Brands Through Touch, Taste, Smell, Sight and Sound. *Strategic Direction*, vol. 22, no. 2. <https://doi.org/10.1108/sd.2006.05622bae.001>

Martínez, L. 2007. Sensory evaluation based on linguistic decision analysis. *International journal of approximate reasoning*, vol. 44, no. 2, p. 148-164. <https://doi.org/10.1016/j.ijar.2006.07.006>

McLeod, S. 2014. Theories of Personality. [online] s.a. [cit. 02-09-2017] Available at: www.simplypsychology.org/personality-theories.html.

Mokry, S., Birčiaková, N., Slováčková, T., Stávková, J., Nagyová, E. 2016. Perception of wine labels by generation Z: Eye-tracking experiment. *Potravinárstvo*, vol. 10, no. 1, p. 524-531. <https://dx.doi.org/10.5219/647>

Mueller, S., Szolnoki, G. 2010. The relative influence of packaging, labelling, branding and sensory attributes on liking and purchase intent: Consumers differ in their responsiveness. *Food quality and preference*, vol. 21, no. 7, p. 774-783. <https://doi.org/10.1016/j.foodqual.2010.07.011>

Nagyová, E., Berčík, J., Horská, E. 2014. The efficiency, energy intensity and visual impact of the accent light in the retail grocery stores. *Potravinárstvo*, vol. 8, no. 1, p. 296-305. <https://dx.doi.org/10.5219/398>

Nagyová, E. 2012. *Trends in consumer behavior in the food market in Slovakia (Trendy v spotrebiteľskom správaní na trhu potravin v SR)*. 1st ed. Nitra, Slovakia : SUA, 83 p. ISBN 978-80-552-0899-2.

Perner, L. 2016. Consumer behavior: The psychology of marketing [online] s.a. [cit. 02-09-2017] Available at: <https://www.consumerpsychologist.com/>.

Plassmann, H., O'Doherty, J., Shiv, B., Rangel, A. 2007. Marketing actions can modulate neural representations of experienced pleasantness. *Proceedings of the National Academy of Sciences of the United States of America*, vol. 105, no. 3, p. 1050-1054. <https://doi.org/10.1073/pnas.0706929105> PMID:18195362

Soars, B. 2009. Driving sales through shoppers' sense of sound, sight, smell and touch. *International Journal of Retail & Distribution Management*, vol. 37, no. 3, p. 286-298. <https://doi.org/10.1108/09590550910941535>

Strack, F., Werth, L., Deutsch, R. 2006. Reflective and impulsive determinants of consumer behavior. *Journal of consumer psychology*, vol. 16, no. 3, p. 250-216. https://doi.org/10.1207/s15327663jcp1603_2

Swait, J., Adamowicz, W. 2001. Choice environment, market complexity, and consumer behavior: A theoretical and empirical approach for incorporating decision complexity into models of consumer choice. *Organizational behavior and human decision processes*, vol. 86, no. 2, p. 141-167. <https://doi.org/10.1006/obhd.2000.2941>

Winer, R S. 2009. New Communications Approaches in Marketing: Issues and Research Directions. *Journal of Interactive Marketing*, vol. 23, no. 2, p. 108-117. <https://doi.org/10.1016/j.intmar.2009.02.004>

Wright, S. A., de Costa Hernandez, J. M., Sundar, S., Dinsmore, J., Kardes, F. R. 2013. I fit tastes bad it must be good: Consumer naive theories and the marketing placebo effect. *International Journal of Research in Marketing*, vol. 30, no. 2, p. 197-198. <https://doi.org/10.1016/j.ijresmar.2012.11.002>

Acknowledgments:

The paper is part of the research project VEGA 1/0502/17 "The personality of the consumer and his impact on emotional behavior and consumer judgment" conducted at the Department of Marketing and Trade at the Faculty of Economics and Management of the Slovak University of Agriculture in Nitra.

The paper is part of the research project APVV-16-0244 "Quality Factors Affecting the Production and Use of Milk and Cheese" conducted at the Department of Marketing and Trade at the Faculty of Economics and Management of the Slovak University of Agriculture in Nitra.

Contact address:

Ing. Andrej Géci, Slovak University of Agriculture, Faculty of Economics and Management, Department of Marketing and Trade, Tr. A. Hlinku 2, 949 76 Nitra Slovakia, E-mail: geci.andrej@gmail.com

prof. Ing. Ľudmila Nagyová, PhD., Slovak University of Agriculture, Faculty of Economics and Management, Department of Marketing and Trade, Tr. A. Hlinku 2, 949 76 Nitra, Slovakia, E-mail: ludmilanagyova@hotmail.com

Mgr. et Mgr. Jana Rybanská, PhD., Slovak University of Agriculture, Faculty of Economics and Management, Department of Marketing and Trade, Tr. A. Hlinku 2, 949 76 Nitra, Slovakia, E-mail: jane.rybanska@gmail.com

SELENIUM, CADMIUM AND DIAZINON INSECTICIDE IN TISSUES OF RATS AFTER PERORAL EXPOSURE

Róbert Toman, Martina Tunegová

ABSTRACT

The concentrations of selenium (Se), cadmium (Cd) and diazinon (DZN) in selected tissues of rats after an oral administration in various combinations were analyzed. Male rats were orally dosed with diazinon (40 mg.L^{-1}), diazinon (40 mg.L^{-1}) + selenium (5 mg.L^{-1}), diazinon (40 mg.L^{-1}) + cadmium (30 mg.L^{-1}), and diazinon (40 mg.L^{-1}) + selenium (5 mg.L^{-1}) + cadmium (30 mg.L^{-1}) in drinking water. After 90 days of per oral administration of compounds, the samples of liver, kidney, muscle tissue (*m. quadriceps femoris*), and adipose tissue were collected. The content of DZN was analyzed using Gas Chromatography – Mass Spectrometry (GC-MS), Cd was analyzed using an Electrothermal Atomic Absorption Spectrometry (ETAAS) and Se using a Hydride Generation Atomic Absorption Spectrometry (HG-AAS) methods. Cadmium significantly increased in liver and kidney after DZN +Cd and DZN +Se +Cd administration. Se significantly increased in liver of DZN +Se, DZN +Se +Cd and DZN +Cd exposed rats, in kidney of DZN +Se and DZN +Se +Cd and DZN +Cd, and in muscle of DZN +Se +Cd group. Highest DZN content was found in the adipose tissue in DZN, DZN +Cd and DZN +Se +Cd but not in combined exposure with Se. Anyway, the differences between the control and experimental groups were not significant. The results indicate that cadmium and selenium accumulate mainly in liver, kidney and selenium also in muscle after p.o. administration but diazinon concentrations increases were not significant. The co-administration of diazinon, Se and Cd affects the content of these compounds in the organism and the accumulation rate depends on the combination of administered compounds. Diazinon and cadmium could contribute to the selenium redistribution in the organism after the peroral intake.

Keywords: cadmium; selenium; diazinon; tissue; rat

INTRODUCTION

Diazinon is used in agriculture to control soil and foliage insects and pests on a variety of fruit, vegetable, nut and field crops. Diazinon (DZN) (O,O-diethyl O-2-isopropyl-6-methylpyrimidin-4-yl phosphorothioate) is also used on non-lactating cattle in an insecticidal ear tag. Prior to the cancellation of all residential uses by 2004, diazinon was used outdoors on lawns and gardens, indoors for fly control and in pet collars designed to control fleas and ticks. Diazinon was one of the most widely used insecticides for household and agricultural pest control. In 2000, the United States Environmental Protection Agency (U.S. EPA) announced an agreement with the registrants of diazinon to cancel all residential uses of DZN. Indoor uses were canceled in 2002 and outdoor uses in 2004, leaving only agricultural uses for diazinon (U.S. EPA, 2007). Current agricultural uses of DZN are limited to selected crops, and diazinon products (other than cattle ear tags) are regulated as restricted use pesticides (U.S. EPA, 2006). Organophosphate insecticides are able to induce the neurotoxicity and impair the neurobehavioral functions

(Ross et al., 2012; Wang et al., 2014). Like other organophosphates, diazinon toxicity is realized through the inhibition of enzyme acetylcholinesterase (AChE) which biological role is the termination of impulse transmissions at cholinergic synapses within the nervous system by rapid hydrolysis of the neurotransmitter, acetylcholine (Schumacher et al., 1986). Inhibition of the activity of AChE by phosphorylation of the serine hydroxyl group of the enzyme results in accumulation of acetylcholine (Fulton and Key, 2001). Symptoms of chronic poisoning are always connected with depression of cholinesterase activity (Gallo and Lawryk, 1991; Tomlin, 1997; Toman et al., 2013). Despite of this general conclusion, reduction in AChE activity does not necessarily mean that the neurotoxic symptoms will also disappear. The manifestations of exposure persist long after ChE levels return to normal (Rohlman, Anger and Lein, 2011).

Diazinon is not a typical cumulative compound in the animal or human organisms but increased levels of this insecticide or its metabolites can be found in fat tissue, liver and hair during relatively short time period (Túri

Soós and Végh, 2000; Maravgakis et al., 2011). Kamel et al. (2007) stated that symptoms reflecting several neurologic domains, including affect, cognition, autonomic and motor function, and vision, are also associated with pesticide exposure. Neurologic symptoms are associated with cumulative exposure to moderate levels of organophosphate and organochlorine insecticides, regardless of recent exposure or history of poisoning. Due to its liposolubility, organochlorines can be absorbed via skin contact and their accumulation in the human's organism has been related to hepatotoxic and neurologic injuries and reproductive problems, among others (Cabaj et al., 2010; 2012). Co-administration to Cd and DZN led to weakened mechanical properties of the bones. Moreover, Cd in combination with DZN had less expressive effect on bone microstructure in male rats than Cd in a sole dose (Chovancova et al., 2014). Information about organophosphorus insecticide distribution and its metabolites are also important since they have significant consequences for the treatment of contaminated persons (Paraiba, Castro and Maia, 2009).

Selenium (Se) is an essential trace element, and its low status in humans has been linked to increased risk of various diseases, such as cancer and heart disease (Tinggy, 2008). It has important antioxidant role in human and animal organisms. The human selenoproteome consists of 25 selenoproteins (Kryukov et al., 2003). However, selenium can be toxic in large amounts and alters the liver transcriptome and growth decrease in rats (Raines and Sunde, 2011), causes nephrotoxicity in mice (Nagy et al., 2015), negatively affected the macroscopic and microscopic structures femoral bone tissue in rats (Martiniakova et al., 2013). Selenium is characterized by a narrow safety range between deficiency and toxic doses (Spallholz and Hoffman, 2002; Tapiero, Townsend and Tew, 2003). This element together with genetic variations in selenoprotein genes may influence susceptibility to cancer risk (Gupta et al., 2013). Se accumulation was observed after selenate, selenite, SelPlex, selenite and nanoSe administration in mice kidney (Nagy et al., 2015). Organoselenium compounds like SelPlex are associated with greater Se accumulation in both maternal and fetal tissues (Ma et al., 2014). Rats treated via oral administration with 5 µg of selenium showed the highest Se concentration in liver and kidney 24 hours after the Se administration (Poletini et al., 2015).

Cadmium (Cd) is an extremely toxic metal found in polluted industrial and agricultural areas. Exposure to cadmium occurs as a result of atmospheric emission during Cd production and processing, from combustion of fossil energy sources, waste and sludge, phosphate fertilizers and deposition of waste and slag at disposal sites. Higher concentrations of cadmium are found in the kidneys of animals slaughtered for food, in wild mushrooms and in seafood such as mussels and oysters (Fried et al., 2008). In general, about 50% of the total body burden is found in liver and kidney, so that they are considered to be the major site of Cd accumulation. The functional and structural changes in almost all organs were described (Massanyi et al., 2007; Martiniakova et al., 2011; Lukacinova et al., 2012; Stolakis et al., 2013; Oh et al., 2014; Dkhil et al., 2014; Wallin et al., 2014; Adamkovicova et al., 2016; Rinaldi et al., 2017).

Cadmium interacts with essential elements such as zinc, copper, iron, and calcium (Ohta, Ichikawa and Seki, 2002) and may cause their deficiency. Moreover, some of these essential elements may ameliorate the cadmium toxicity, such as selenium and zinc, the well-known cadmium antagonists (Kippler et al., 2009; Ugwuja et al., 2015; Liu et al., 2015; Rasic-Milutinovic et al., 2017).

Scientific hypothesis

The contamination of the environment and food chain and interactions between the contaminants entering the human body may have a negative impact on the human health and is hard to predict. Therefore, the main goal of this study was to determine the level of pesticide diazinon and elements cadmium and selenium in the organism of rats after the separate and combined administration and if there is any relationships between the compounds accumulation in the animal organism.

MATERIAL AND METHODOLOGY

Experimental design

Fifty males Wistar rats were divided to five groups, diazinon treated group DZN (40 mg.L⁻¹), DZN +Se group (diazinon 40 mg.L⁻¹ +selenium 5 mg.L⁻¹), DZN +Cd group (diazinon 40 mg.L⁻¹ +cadmium 30 mg.L⁻¹), and DZN +Se +Cd group (diazinon 40 mg.L⁻¹ +selenium 5 mg.L⁻¹ +cadmium 30 mg.L⁻¹), and control, untreated group, each containing 10 males. The males were housed in plastic cages (Tecniplast, Italy) in an environment maintained at 20 – 24°C, 55 ±10% humidity, with access to water and food (feed mixture M3, Machal, Czech Republic) ad libitum. Young, 4 weeks old males were chosen at the beginning of the experiment and continuously dosed with diazinon (Sigma-Aldrich, USA), selenium (Na₂SeO₃, Sigma, USA) and cadmium (CdCl₂, Reachem, Slovak Republic) in drinking water for 90 days, reaching the sexual maturity at the end of the experiments.

Tissue diazinon, Se and Cd content analysis

The liver, kidney, adipose tissue and muscle tissue (m. quadriceps femoris) were sampled 90 days after the daily diazinon, Cd and Se peroral intake. The samples were weighed and stored at -20°C and then analyzed. Cadmium was analyzed using the electrothermal atomic absorption spectrometry (ETAAS, Varian SpectrAA 220, The Netherlands). Selenium was determined using the hydride generation atomic absorption spectrometry (HGAAS, Varian SpectrAA 220 with VGA-76 hydride generator, The Netherlands), diazinon was determined using the gas chromatography–mass spectrometry (GC–MS, Varian MS-4000, USA) in certified laboratory (EL, s.r.o. Spišská Nová Ves, Slovak Republic).

Statistical analysis

The values of control and experimental animal analyses were expressed as mean ±SD. The results were analyzed by one-way analysis of variance (ANOVA) followed by Scheffe's test for post hoc comparisons using statistical software Stata 9 (StataCorp LP, TX, USA). Differences were considered significant at *p* <0.05.

RESULTS AND DISCUSSION

The results of our experiments summarize Tables 1 – 4. Diazinon content in the selected tissues was almost under the detection limit (<0.005 mg.kg⁻¹). When administered with Se or Cd or Se +Cd, the levels of diazinon were lower in liver and kidney but not in the muscle and adipose tissues than that of the diazinon-exposed group. This could be caused by co-administration with selenium because Se could act as a protective element against the diazinon effects. Selenium in combination with DZN partially or totally alleviated its toxic effects on the liver and kidney.

Therefore, selenium could be able to antagonize DZN toxicity (El-Demerdash and Nasr, 2014). Moreover, some authors speculate that adipose tissue could be the target organ to organophosphate pesticides (OPs) toxicity (Pakzad et al., 2013). OPs are known to accumulate in adipose tissue and Tanvir et al. (2016) found the highest concentration of OPs chlorpyrifos in the adipose tissue. The similar results were confirmed in our experiments (Table 4).

Treatment of rats with diazinon significantly enhances renal lipid peroxidation which is accompanied by a decrease in the activities of renal antioxidant enzymes

Table 1. Content of diazinon, Cd and Se in the rat liver.

Group	Diazinon (mg.kg ⁻¹ ±SD)	Selenium (mg.kg ⁻¹ ±SD)	Cadmium (mg.kg ⁻¹ ±SD)
Control	<0.005	1.085 ±0.26	0.006 ±0.002
DZN	0.0054 ±0.001	1.099 ±0.10	<0.005
DZN+Se	<0.005	2.946 ±0.48**	<0.005
DZN+Se+Cd	<0.005	3.098 ±0.88**	0.067 ±0.02**
DZN+Cd	<0.005	2.422 ±0.15**	0.072 ±0.03**

**p <0.01; 0.005 – detection limit.

Table 2. Content of diazinon, Cd and Se in the rat kidney.

Group	Diazinon (mg.kg ⁻¹ ±SD)	Selenium (mg.kg ⁻¹ ±SD)	Cadmium (mg.kg ⁻¹ ±SD)
Control	<0.005	1.527 ±0.24	0.013 ±0.003
DZN	0.014 ±0.003	1.574 ±0.30	0.015 ±0.008
DZN+Se	<0.005	4.023 ±1.06**	0.03 ±0.009
DZN+Se+Cd	<0.005	3.775 ±0.55**	0.647 ±0.174**
DZN+Cd	<0.005	2.424 ±0.15*	1.566 ±0.30**

*p <0.05; **p <0.01; 0.005 – detection limit.

Table 3. Content of diazinon, Cd and Se in the rat muscle.

Group	Diazinon (mg.kg ⁻¹ ±SD)	Selenium (mg.kg ⁻¹ ±SD)	Cadmium (mg.kg ⁻¹ ±SD)
Control	<0.005	0.250 ±0.03	0.006 ±0.001
DZN	0.012 ±0.002	0.207 ±0.04	0.005 ±0.0006
DZN+Se	<0.005	0.214 ±0.12	0.005 ±0.0009
DZN+Se+Cd	0.008 ±0.003	0.884 ±0.48**	<0.005
DZN+Cd	0.007 ±0.001	0.210 ±0.03	<0.005

**p <0.01; 0.005 – detection limit.

Table 4. Content of diazinon, Cd and Se in the rat adipose tissue.

Group	Diazinon (mg.kg ⁻¹ ±SD)	Selenium (mg.kg ⁻¹ ±SD)	Cadmium (mg.kg ⁻¹ ±SD)
Control	<0.005	0.137 ±0.05	<0.005
DZN	0.032 ±0.01	0.031 ±0.02	<0.005
DZN+Se	<0.005	0.197 ±0.096	0.005 ±0.0006
DZN+Se+Cd	0.038 ±0.01	<0.005	<0.005
DZN+Cd	0.033 ±0.02	<0.005	0.015 ±0.01

0.005 – detection limit.

(catalase, glutathione peroxidase, glutathione reductase, glucose-6-phosphate dehydrogenase, glutathione S-transferase) and depletion in the level of glutathione reduced. These changes result in the oxidative stress and renal dysfunction (Shah and Iqbal, 2010). Selenium has the ability to counteract free radicals and protect the structure and function of proteins, DNA and chromosomes against the injury of oxidation (Reddy, Sailaja and Krishnaiah, 2009). There is a difference between the effective dose of selenium in relation to the activity of glutathione peroxidase (GSH-Px) and depends on the animal species. The highest GSH-Px level was observed when the animals were fed 0.5 mg.kg⁻¹ dietary Se level in roosters (Shi et al., 2014) but at the 4.0 mg.kg⁻¹ in goats (Shi et al., 2010). Due to the scavenging of free radicals and increasing the antioxidant status, Se particularly at low doses had a potent antigenotoxic effect against DZN-induced toxicity in rats (Shokrzadeh et al., 2013). However, mechanisms of interaction between DZN and Se are still not clear and further studies are still required.

Excessive exposure to cadmium and selenium causes increase in their contents in the internal organs. Cadmium content in the selected tissues in our experiments was low, mostly near or under the detection limit. Only cadmium content in kidney was higher in all groups than in other tissues. The main cadmium storage organs are kidneys and liver which has been confirmed in many studies (Toman and Massányi, 1996; Jihen et al., 2008; Kolesarova et al., 2008; Roggeman et al., 2014). In fact, the significant increase in Cd content was observed in the liver and kidney after p.o. exposure in DZN +Cd and DZN +Se +Cd group (Table 1 and 2).

Ognjanovic et al. (2008) reported that with increased Cd concentration in the liver and kidneys, Se concentration also rises, although it was not administered additionally. We confirm these findings as selenium content in analyzed tissues was highest in kidney, followed by liver, muscle and adipose tissue. The same trend in Se tissue concentrations was recorded by Zachara et al. (2001). The statistically significant increase in selenium content was found in the kidney and liver when Se was administered with DZN or Cd or DZN+Cd (Table 1 and 2). In muscle tissue, the significantly higher Se content was found only in DZN +Se +Cd group (Table 3). Selenium antagonizes cadmium, especially in acute exposures and was found to have a protective effect by decreasing Cd content in the liver and kidneys (Chen, Whanger and Weswig, 1975). However, it has also been observed that simultaneous administration of cadmium and selenium (200 ppm and 0.1 ppm, respectively) in drinking water for five weeks did not decrease Cd concentration in the liver and kidney and only affected the toxic effects of Cd in these organs (Jihen et al., 2008). Dietary selenium did not significantly affect the concentration of cadmium in tissues in our experiments but there was also diazinon present in the same period and dose which could affect the role of Se in antioxidant capability. Similarly, no decrease in cadmium, zinc, iron or copper in rat liver was found after selenium intake in food (Meyer, House and Welch, 1982). The lipid peroxidation, one of the main manifestations of the oxidative damage, plays an important role in the toxicity of many xenobiotics. Intoxication with cadmium causes a significant increase of lipid

peroxidation in liver and kidneys of rats (Ognjanovic et al., 2008) which are also the main organs cumulating the cadmium. Therefore, increase in selenium content in these organs (Table 1 and 2) may be connected with the selenium protective role in oxidative stress induced by cadmium and diazinon. This protection includes the capability of Se to alter the distribution of Cd in tissues and induces binding of the Cd-Se complexes to proteins, which are similar to metallothioneins (Jamba, Nehru and Bansal, 1997; Combs and Gray, 1998; Ognjanovic et al., 2008). The significant increase in cadmium content in kidney and liver after its administration in DZN +Cd or DZN +Se +Cd is a logical consequence but was somewhat limited by selenium addition (Table 1 and 2).

CONCLUSION

The results indicate that cadmium and selenium accumulate mainly in liver, kidney and selenium also in muscle after p.o. administration but diazinon concentrations increases were not significant. The co-administration of diazinon, Se and Cd affects the content of these compounds in the organism and the accumulation rate depends on the combination of administered compounds. We propose the role of diazinon and cadmium in redistribution of selenium as these compounds administered simultaneously caused the elevation in the selenium content in liver and kidney.

REFERENCES

- Adamkovicova, M., Toman, R., Martiniakova, M., Omelka, R., Babosova, R., Krajcovicova, V., Grosskopf, B., Massanyi, P. 2016. Sperm motility and morphology changes in rats exposed to cadmium and diazinon. *Reproductive Biology and Endocrinology*, vol. 14, no. 1, p. 42. <https://doi.org/10.1186/s12958-016-0177-6> PMID:27503218
- Cabaj, M., Toman, R., Adamkovicova, M., Massanyi, P., Šiška, B., Lukáč, N., Golian, J. 2010. Structural changes in the testis caused by diazinon and selenium. *Potravinárstvo*, vol. 4, no. 2, p. 8-16. <https://doi.org/10.5219/44>
- Cabaj, M., Toman, R., Adamkovicova, M., Massanyi, P., Šiška, B., Lukáč, N., Golian, J., Hluchý, S. 2012. Quantitative and structural changes of testis and semen quality parameters changes caused by peroral administration of diazinon in rats. *Potravinárstvo*, vol. 6, no. 2, p. 9-14. <https://doi.org/10.5219/188>
- Chen, R. W., Whanger, P. D., Weswig, P. H. 1975. Selenium – induced redistribution of cadmium binding to tissue proteins: a possible mechanism of protection against cadmium toxicity. *Bioinorganic Chemistry*, vol. 4, no. 2, p. 125-133. [https://doi.org/10.1016/S0006-3061\(00\)81021-2](https://doi.org/10.1016/S0006-3061(00)81021-2)
- Chovancova, H., Omelka, R., Bobonova, I., Formicki, G., Toman, R., Martiniakova, M. 2014. Bone adaptation to simultaneous cadmium and diazinon toxicity in adult male rats. *Potravinárstvo*, vol. 8, no. 1, p. 107-113. <https://doi.org/10.5219/343>
- Combs, G. F. Jr., Gray, W. P. 1998. Chemopreventive agents: selenium. *Pharmacology & Therapeutics*, vol. 79, no. 3, p. 179-192. [https://doi.org/10.1016/S0163-7258\(98\)00014-X](https://doi.org/10.1016/S0163-7258(98)00014-X)
- Dkhil, M. A., Al-Quraishy, S., Diab, M. M., Othman, M. S., Aref, A. M., Abdel Moneim, A. E. 2014. The potential protective role of *Physalis peruviana* L. fruit in cadmium-induced hepatotoxicity and nephrotoxicity. *Food and*

Chemical Toxicology, vol. 74, p. 98-106.
<https://doi.org/10.1016/j.fct.2014.09.013>
 PMID:25265456

El-Demerdash, F. M., Nasr, H. M. 2014. Antioxidant effect of selenium on lipid peroxidation, hyperlipidemia and biochemical parameters in rats exposed to diazinon. *Journal of Trace Elements in Medicine and Biology*, vol. 28, no. 1, p. 89-93.
<https://doi.org/10.1016/j.jtemb.2013.10.001>
 PMID:24188896

Fried, K. W., Rozman, K. K., Summer, K.-H., Halbach, S., Kappus, H., Greim, H., Borm, P. J. A., Degen, G. H., Owens, J. W., Dekant, W., Anders, M. W., Szinicz, L., Zilker, T. 2008. Toxicity of selected chemicals. In Greim, H. et al. *Toxicology and risk assessment: A comprehensive introduction*. Chichester, UK : John Wiley & Sons, Ltd., p. 513-655. ISBN-978-0-470-86893-5.

Fulton, M. H., Key, P. B. 2001. Acetylcholinesterase inhibition in estuarine fish and invertebrates as an indicator of organophosphorus insecticide exposure and effects. *Environmental Toxicology and Chemistry*, vol. 20, no. 1, p. 37-45.
<https://doi.org/10.1002/etc.5620200104>
 PMID:11351414

Gallo, M. A., Lawryk, N. J. 1991. Organic phosphorus pesticides. In Hayes, W. J. Jr., Laws, E. R. Jr. *Handbook of pesticide Toxicology*. New York, USA : Academic Press, p. 3-5. ISBN-10: 0123341612.

Gupta, S., Jaworska-Bieniek, K., Lubinski, J., Jakubowska, A. 2013. Can selenium be a modifier of cancer risk in CHEK2 mutation carriers? *Mutagenesis*, vol. 28, no. 6, p. 625-629.
<https://doi.org/10.1093/mutage/get050>
 PMID:24106007

Jamba, L., Nehru, B., Bansal, M. P. 1997. Redox modulation of selenium binding proteins by cadmium exposures in mice. *Molecular and Cellular Biochemistry*, vol. 177, no. 1-2, p. 169-175.
<https://doi.org/10.1023/A:1006869623864>

Jihen, el H., Imed, M., Fatima, H., Abdelhamid, K. 2008. Protective effects of selenium (Se) and zinc (Zn) on cadmium (Cd) toxicity in the liver and kidney of the rat: Histology and Cd accumulation. *Food and Chemical Toxicology*, vol. 46, no. 11, p. 3522-3527.

Kamel, F., Engel, L. S., Gladen, B. C., Hoppin, J. A., Alavanja, M. C. R., Sandler, D. P. 2007. Neurologic symptoms in licensed pesticide applicators in the Agricultural Health Study. *Human & Experimental Toxicology*, vol. 26, no. 3, p. 243-250.
<https://doi.org/10.1177/0960327107070582>
 PMID:17439927

Kippler, M., Goessler, W., Nermell, B., Ekstrom, E. C., Lonnerdal, B., El Arifeen, S., Vahter, M. 2009. Factors influencing intestinal cadmium uptake in pregnant Bangladeshi women-a prospective cohort study. *Environmental Research*, vol. 109, no. 7, p. 914-921.
<https://doi.org/10.1016/j.envres.2009.07.006>
 PMID:19646688

Kolesarova, A., Slamecka, J., Jurcik, R., Tataruch, F., Lukac, N., Kovacik, J., Capcarova, M., Valent, M., Massanyi, P. 2008. Environmental levels of cadmium, lead and mercury in brown hares and their relation to blood metabolic parameters. *Journal of Environmental Science and Health. Part A*, vol. 43, no. 6, p. 646-650.

Kryukov, G. V., Castellano, S., Novoselov, S. V., Lobanov, A. V., Zehtab, O., Guigó, R., Gladyshev, V. N. 2003. Characterization of mammalian selenoproteomes. *Science*, vol. 300, no. 5624, p. 1439-1443.
<https://doi.org/10.1126/science.1083516>
 PMID:12775843

Liu, L., Yang, B., Cheng, Y., Lin, H. 2015. Ameliorative effects of selenium on cadmium-induced oxidative stress and endoplasmic reticulum stress in the chicken kidney. *Biological Trace Element Research*, vol. 167, no. 2, p. 308-319.
<https://doi.org/10.1007/s12011-015-0314-7>
 PMID:25805271

Lukacinova, A., Novakova, J., Lovasova, E., Cimbolakova, I., Nistiar, F. 2012. Influence of lifetame exposure of sublethal doses of cadmium to selected parameters of carbohydrate metabolism. *Potravinarstvo*, vol. 6, no. 4, p. 36-40.
<https://dx.doi.org/10.5219/231>

Ma, Y. L., Lindemann, M. D., Pierce, J. L., Unrine, J. M., Cromwell, G. L. 2014. Effect of inorganic or organic selenium supplementation on reproductive performance and tissue trace mineral concentrations in gravid first-parity gilts, fetuses, and nursing piglets. *Journal of Animal Science*, vol. 92, no. 12, p. 5540-5550.
<https://doi.org/10.2527/jas.2014-7590>
 PMID:25403188

Maravgakis, G., Tzatzarakis, M. N., Alegakis, A. K., Stivaktakis, P. D., Tsatsakis, A. M. 2012. Diethyl phosphates accumulation in rabbits' hair as an indicator of long term exposure to diazinon and chlorpyrifos. *Forensic Science International*, vol. 218, no. 1-3, p. 106-110.
<https://doi.org/10.1016/j.forsciint.2011.10.017>
 PMID:22024651

Martiniaková, M., Boboňová, I., Omelka, R., Grosskopf, B., Stawarz, R., Toman, R. 2013. Structural changes in femoral bone tissue of rats after subchronic peroral exposure to selenium. *Acta Veterinaria Scandinavica*, vol. 55, no. 1, p. 8.
<https://doi.org/10.1186/1751-0147-55-8>
 PMID:23369508

Martiniaková, M., Chovancová, H., Omelka, R., Grosskopf, B., Toman, R. 2011. Effects of a single intraperitoneal administration of cadmium on femoral bone structure in male rats. *Acta Veterinaria Scandinavica*, vol. 53, no. 1, p. 49.
<https://doi.org/10.1186/1751-0147-53-49>
 PMID:21884588

Massányi, P., Lukáč, N., Uhrin, V., Toman, R., Pivko, J., Rafay, J., Forgács, Z., Somosy, Z. 2007. Female reproductive toxicology of cadmium. *Acta Biologica Hungarica*, vol. 58, no. 3, p. 287-299.
<https://doi.org/10.1556/ABiol.58.2007.3.5>
 PMID:17899786

Meyer, S. A., House, W. A., Welch, R. M. 1982. Some metabolic interrelationships between toxic levels of cadmium and nontoxic levels of selenium fed to rats. *Journal of Nutrition*, vol. 112, no. 5, p. 954-961.
 PMID:7077426

Nagy, G., Benko, I., Kiraly, G., Voros, O., Tanczos, B., Sztrik, A., Takács, T., Pócsi, I., Prokisch, J., Banfalvi, G. 2015. Cellular and nephrotoxicity of selenium species. *Journal of Trace Elements in Medicine and Biology*, vol. 30, p. 160-170.
<https://doi.org/10.1016/j.jtemb.2014.12.011>
 PMID:25604949

Ognjanović, B. I., Marković, S. D., Pavlović, S. Z., Zikić, R. V., Stajin, A. S., Sačić, Z. S. 2008. Effect of chronic cadmium exposure on antioxidant defense system in some tissues of rats: protective effect of selenium. *Physiological Research*, vol. 57, no. 3, p. 403-411.
 PMID:17465690

Oh, C. M., Oh, I. H., Lee, J. K., Park, Y. H., Choe, B. K., Yoon, T. Y., Choi, J. M. 2014. Blood cadmium levels are associated with a decline in lung function in males. *Environmental Research*, vol. 132, p. 119-125.
<https://doi.org/10.1016/j.envres.2014.04.008>
 PMID:24769560

Ohta, H., Ichikawa, M., Seki, Y. 2002. Effects of cadmium intake on bone metabolism of mothers during pregnancy and

- lactation. *The Tohoku Journal of Experimental Medicine*, vol. 196, no. 1, p. 33-42. <https://doi.org/10.1620/tjem.196.33> [PMid:12498324](#)
- Pakzad, M., Fouladdel, S., Nili-Ahmadabadi, A., Pourkhalili, N., Baeeri, M., Azizi, E., Sabzevari, O., Ostad, S. N., Abdollahi, M. 2013. Sublethal exposures of diazinon alters glucose homostasis in Wistar rats: Biochemical and molecular evidences of oxidative stress in adipose tissues. *Pesticide Biochemistry and Physiology*, vol. 105, no. 1, p. 57-61. <https://doi.org/10.1016/j.pestbp.2012.11.008> [PMid:24238291](#)
- Paraiba, L. C., Castro, V. L. S. S., Maia, A. H. N. 2009. Insecticide distribution model in human tissues viewing worker's health monitoring programs. *Brazilian Archives of Biology and Technology*, vol. 52, no. 4, p. 875-881. <https://doi.org/10.1590/S1516-89132009000400011>
- Polettini, A. E., Fortaner, S., Farina, M., Groppi, F., Manenti, S., Libralato, G., Sabbioni, E. 2015. Uptake from water, internal distribution and bioaccumulation of selenium in *Scenedesmus obliquus*, *Unio mancus* and *Rattus norvegicus*: part A. *Bulletin of Environmental Contamination and Toxicology*, vol. 94, no. 1, p. 84-89. <https://doi.org/10.1007/s00128-014-1407-2> [PMid:25327388](#)
- Raines, A. M., Sunde, R. A. 2011. Selenium toxicity but not deficient or super-nutritional selenium status vastly alters the transcriptome in rodents. *BMC Genomics*, vol. 12, p. 12-26. <https://doi.org/10.1186/1471-2164-12-26> [PMid:21226930](#)
- Rasic-Milutinovic, Z., Jovanovic, D., Bogdanovic, G., Trifunovic, J., Mutic, J. 2017. Potential influence of selenium, copper, zinc and cadmium on L-thyroxine substitution in patients with Hashimoto thyroiditis and hypothyroidism. *Experimental and Clinical Endocrinology & Diabetes*, vol. 125, no. 2, p. 79-85. [PMid:27793066](#)
- Reddy, K. P., Sailaja, G., Krishnaiah, C. 2009. Protective effects of selenium on fluoride induced alterations in certain enzymes in brain of mice. *Journal of Environmental Biology*, vol. 30, suppl. no. 5, p. 859-864. [PMid:20143719](#)
- Rinaldi, M., Micali, A., Marini, H., Adamo, E. B., Puzzolo, D., Pisani, A., Trichilo, V., Altavilla, D., Squadrito, F., Minutoli, L. 2017. Cadmium, organ toxicity and therapeutic approaches. A review on brain, kidney and testis damage. *Current Medicinal Chemistry*, vol. 24, no. 35, p. 3879-3893. <https://doi.org/10.2174/0929867324666170801101448> [PMid:28762312](#)
- Roggegan, S., de Boeck, G., De Cock, H., Blust, R., Bervoets, L. 2014. Accumulation and detoxification of metals and arsenic in tissues of cattle (*Bos taurus*), and the risks for human consumption. *Science of the Total Environment*, vol. 466-467, p. 175-184. <https://doi.org/10.1016/j.scitotenv.2013.07.007> [PMid:23906855](#)
- Rohlman, D. S., Anger, W. K., Lein P. J. 2011. Correlating neurobehavioral performance with biomarkers of organophosphorous pesticide exposure. *Neurotoxicology*, vol. 32, no. 2, p. 268-276. <https://doi.org/10.1016/j.neuro.2010.12.008> [PMid:21182866](#)
- Ross, S. M., McManus, I. C., Harrison, V., Mason, O. 2013. Neurobehavioral problems following low-level exposure to organophosphate pesticides: a systematic and meta-analytic review. *Critical Reviews in Toxicology*, vol. 43, no. 1, p. 21-44. <https://doi.org/10.3109/10408444.2012.738645> [PMid:23163581](#)
- Schumacher, M., Camp, S., Maulet, Y., Newton, M., MacPhee-Quigley, K., Taylor, S. S., Friedmann, T., Taylor, P. 1986. Primary structure of Torpedo californica acetylcholinesterase deduced from its cDNA sequence. *Nature*, vol. 319, no. 6052, p. 407-409. <https://doi.org/10.1038/319407a0> [PMid:3753747](#)
- Shah, M. D., Iqbal, M. 2010. Diazinon-induced oxidative stress and renal dysfunction in rats. *Food and Chemical Toxicology*, vol. 48, no. 12, p. 3345-3353. <https://doi.org/10.1016/j.fct.2010.09.003> [PMid:20828599](#)
- Shi, L., Yue, W., Zhang, C., Ren, Y., Zhu, X., Wang, Q., Shi, L., Lei, F. 2010. Effects of maternal and dietary selenium (Se-enriched yeast) on oxidative status in testis and apoptosis of germ cells during spermatogenesis of their offspring in goats. *Animal Reproduction Science*, vol. 119, no. 3-4, p. 212-218. <https://doi.org/10.1016/j.anireprosci.2010.02.012> [PMid:20226605](#)
- Shi, L., Zhao, H., Ren, Y., Yao, X., Song, R., Yue, W. 2014. Effects of different levels of dietary selenium on the proliferation of spermatogonial stem cells and antioxidant status in testis of roosters. *Animal Reproduction Science*, vol. 149, no. 3-4, p. 266-272. <https://doi.org/10.1016/j.anireprosci.2014.07.011> [PMid:25115807](#)
- Shokrzadeh, M., Ahangar, N., Abdollahi, M., Shadboorestan, A., Omid, M., Payam, S. S. 2013. Potential chemoprotective effects of selenium on diazinon-induced DNA damage in rat peripheral blood lymphocyte. *Human & Experimental Toxicology*, vol. 32, no. 7, p. 759-765. <https://doi.org/10.1177/0960327112468179> [PMid:23821592](#)
- Spallholz, J. E., Hoffman, D. J. 2002. Selenium toxicity: cause and effects in aquatic birds. *Aquatic Toxicology*, vol. 57, no. 1-2, p. 27-37. [https://doi.org/10.1016/S0166-445X\(01\)00268-5](https://doi.org/10.1016/S0166-445X(01)00268-5)
- Stolakis, V., Tsakiris, S., Kalafatakis, K., Zarros, A., Skandali, N., Gkanti, V., Kyriakaki, A., Liapi, C. 2013. Developmental neurotoxicity of cadmium on enzyme activities of crucial offspring rat brain regions. *Biometals*, vol. 26, no. 6, p. 1013-1021. <https://doi.org/10.1007/s10534-013-9678-3> [PMid:24065572](#)
- Tanvir, E. M., Afroz, R., Chowdhury, M., Gan, S. H., Karim, N., Islam, M. N., Khalil, M. I. 2016. A model of chlorpyrifos distribution and its biochemical effects on the liver and kidneys of rats. *Human & Experimental Toxicology*, vol. 35, no. 9, p. 991-1004. <https://doi.org/10.1177/0960327115614384> [PMid:26519480](#)
- Tapiero, H., Townsend, D. M., Tew, K. D. 2003. The antioxidant role of selenium and seleno-compounds. *Biomedicine & Pharmacotherapy*, vol. 57, no. 3-4, p. 134-144. [https://doi.org/10.1016/S0753-3322\(03\)00035-0](https://doi.org/10.1016/S0753-3322(03)00035-0)
- Tinggi, U. 2008. Selenium: its role as antioxidant in human health. *Environmental Health and Preventive Medicine*, vol. 13, no. 2, p. 102-108. <https://doi.org/10.1007/s12199-007-0019-4> [PMid:19568888](#)
- Toman, R., Hluchy, S., Maruniakova, N., Hajkova, Z. 2013. Selenium and diazinon neurotoxicity after an intraperitoneal administration in rats. *Scientific Papers*, vol. 46, no. 2, p. 166-170.
- Toman, R., Massányi, P. 1996. Cadmium in selected organs of fallow-deer (*Dama dama*), sheep (*Ovis aries*), brown hare

(*Lepus europaeus*) and rabbit (*Oryctolagus cuniculus*) in Slovakia. *Journal of environmental science and health. Part A*, vol. 31, no. 5, p. 1043-1051.

Tomlin, C. D. S. 1997. *The pesticide manual. A World Compendium*. Hampshire, UK : British Crop Protection Council, p. 1606. ISBN-10: 1901396118.

Túri, M. S., Soós, K., Végh, E. 2000. Determination of residues of pyrethroid and organophosphorous ectoparasiticides in foods of animal origin. *Acta Veterinaria Hungarica*, vol. 48, no. 2, p. 139-149. [PMid:11402696](https://pubmed.ncbi.nlm.nih.gov/11402696/)

Ugwuja, E. I., Ogonnaya, L. U., Uro-Chukwu, H., Obuna, J. A., Ogiji, E., Ezenkwa, S. U. 2015. Plasma cadmium and zinc and their interrelationship in adult Nigerians: potential health implications. *Interdisciplinary Toxicology*, vol. 8, no. 2, p. 77-83. <https://doi.org/10.1515/intox-2015-0012> [PMid:27486364](https://pubmed.ncbi.nlm.nih.gov/27486364/)

U.S. EPA I.R.E.D Facts. Diazinon. 2007. *U.S. Environmental Protection Agency, Office of Prevention, Pesticides and Toxic Substances, Office of Pesticide Programs*.

U.S. EPA Reregistration Eligibility Decision (RED). Diazinon. 2006. *EPA 738-R-04-006; U.S. Environmental Protection Agency, Office of Prevention, Pesticides and Toxic Substances, Office of Pesticide Programs, U.S. Government Printing Office: Washington, DC, 2006*.

Zachara, B.A., Pawluk, H., Korenkiewicz, J. Skok, Z. 2001. Selenium levels in kidney, liver and heart of newborns and

infants. *Early Human Development*, vol. 63, no. 2, p. 103-111. [https://doi.org/10.1016/S0378-3782\(01\)00141-4](https://doi.org/10.1016/S0378-3782(01)00141-4)

Wallin, M., Sallsten, G., Lundh, T., Barregard, L. 2015. Low-level cadmium exposure and effects on kidney function. *Occupational and Environmental Medicine*, vol. 71, no. 12, p. 452-461.

Wang, A., Cockburn, M., Ly, T. T., Bronstein, J. M., Ritz, B. 2014. The association between ambient exposure to organophosphates and Parkinson's disease risk. *Occupational and Environmental Medicine*, vol. 71, no. 4, p. 275-281. <https://doi.org/10.1136/oemed-2013-101394> [PMid:24436061](https://pubmed.ncbi.nlm.nih.gov/24436061/)

Acknowledgments:

This work was supported by AgroBioTech Research Centre built in accordance with the project Building „AgroBioTech“ Research Centre ITMS 26220220180.

Contact address:

Robert Toman, Slovak University of Agriculture, Faculty of Agrobiolgy and Food Sources, Department of Veterinary Disciplines, Tr. A. Hlinku 2, 949 76 Nitra, Slovakia, E-mail: robert.toman@uniag.sk

Martina Tunegová, Slovak University of Agriculture, Faculty of Agrobiolgy and Food Sources, Department of Veterinary Disciplines, Tr. A. Hlinku 2, 949 76 Nitra, Slovakia, E-mail: tunegova.martina@gmail.com



DETECTION OF SELECTED HEAVY METALS AND MICRONUTRIENTS IN EDIBLE INSECT AND THEIR DEPENDENCY ON THE FEED USING XRF SPECTROMETRY

Jiří Mlček, Martin Adámek, Anna Adámková, Marie Borkovcová, Martina Bednářová, Josef Skácel

ABSTRACT

Edible insect can be a valuable source of nutrients, but also a potential source of heavy metals. Quick detection of over-limit heavy metals concentration could be a key to processing and quick distribution of edible insect products. The aim of this work was to evaluate the feed-dependent content of heavy metals in the mealworm and superworm using the X-ray fluorescence spectrometry as an easy, cheap and a timeless screening method for evaluating the content of heavy metals and microelements. Using a handheld analyser the content of Cd, Pb, Cu and Zn were detected. Both analysed species proved dependency of metal content on a feed. Detected level of Cu in mealworm was between 571 mg.kg⁻¹ and 1768 mg.kg⁻¹ and in superworm from 571 mg.kg⁻¹ to 1768 mg.kg⁻¹ based on the feed. The content of Zn was similar, between 725 mg.kg⁻¹ and 1437 mg.kg⁻¹ in mealworm and 555-1482 mg.kg⁻¹ in superworm. The level of Pb was below the detection limit in all samples, thus from this point of view this food seems to be safe. On the contrary, the content of Cd in the dry matter samples was above the food limit – 147 mg.kg⁻¹ to 230 mg.kg⁻¹. From this point of view, the samples were evaluated as unsuitable for consuming.

Keywords: edible insect; mealworm; superworm; X-ray fluorescence spectrometry; heavy metal

INTRODUCTION

Edible insect is an important food source for more than 2 billion people, especially in developing countries. Given the ever-growing cost of animal protein production and the ecological consequences of livestock farming, edible insect appears to be a very important strategic resource (Mlček et al., 2014), because the demand for animal commodities such as beef, pork and fish meat is constantly increasing (van Huis, 2013; Belluco et al., 2013; Menzel and D'Aluisio, 1998; DeFoliart, 2002; Paoletti, 2005). Although in developed western countries the entomophagy is often associated with disgust, primitive behaviour, poverty and diseases; edible insect is also becoming an interesting commodity (De Foliart, 1992; Ramos-Elorduy et al., 2006). The demand for products made of edible insects is gradually increasing even in European countries, but until now the consumption of edible insects has not been spread to a greater extent. Thus, according to the Regulation (EU) of the European Parliament and of the Council 2015/2283 on novel foods, edible insect from the 1st January 2018 belongs to the novel foods in the countries of the EU.

The insect is highly nutritive and healthy source of food with higher content of fat, protein, vitamins, fiber and minerals (van Huis, 2013). However, insect can

accumulate dangerous chemicals, including heavy metals, in its tissues (Handley et al., 2007; Zhuang et al., 2009), along with dioxins (Devkota and Schmidt, 2000) and flame retardants (Gaylor et al., 2012). Risks connected with the consumption of edible insects were also addressed by EFSA in the document „Risk profile related to production and consumption of insects as food and feed“ published in October 2015 (EFSA, 2015).

Cd, Pb, Zn and Cu belong to the highly toxic and relatively accessible elements (Toman, 2003; Pavlovský, 2014). The impact of cadmium exposure on the human organism is wide - from gastroenteritis and the possibility of osteomalacia to carcinogenic and teratogenic effects (Velíšek, 2002; Toman, 2005). WHO suggests a maximum weekly intake of cadmium 7000 mg.kg⁻¹. High content of cadmium can be found in wheat, rice, mussels and animal kidney corns (Oymak et al., 2009). The limit for cadmium content in the meat of cattle, sheep, pigs and poultry is 0.05 mg.kg⁻¹ fresh weight, crustaceans 0.50 mg.kg⁻¹ fresh weight, clams 1.00 mg.kg⁻¹ fresh weight and cephalopods 1.00 mg.kg⁻¹ fresh weight (Commission Regulation (EC) No 1881/2006).

A typical toxic element, which has no physiological function in the body, is lead. The effect of lead on the human organism is, as with cadmium, very wide – from

gastroenteritis to neurotoxic effects (Velíšek, 2002; Sola et al., 1998). Children have experienced decreased intelligence and anemia when exposed to very low doses (Memon et al., 2005). Limit for lead content in the meat of cattle, sheep, pigs and poultry is 0.10 mg.kg⁻¹ fresh weight, crustaceans 0.50 mg.kg⁻¹ fresh weight, clams 1.50 mg.kg⁻¹ fresh weight and cephalopods 1.00 mg.kg⁻¹ fresh weight (Commission Regulation (EC) No 1881/2006).

Zinc is an essential element that is part of enzymes, but at higher concentrations it is toxic. Zinc ingestion causes gastrointestinal problems, such as osteoporosis, in case of long-term exposure. Higher doses result in disorders of cholesterol metabolism, resulting in atherosclerosis (Toman, 2003; Pavlovský, 2014). Recommended daily intake, according to Decree No. 352/2009 Coll. (CZ) is 10 mg.

Copper is essential for life, is part of enzymes and important for hematopoiesis. Exposure tolerance in adults is high, but children are poisoned at low concentrations (Toman, 2003; Pavlovský, 2014). Recommended daily intake, according to Decree No. 352/2009 Coll. (CZ) is 1 mg.

Due to an insufficient examination of edible insect safety as a novel food for humans in the EU, it is necessary to analyse not only the nutritional value of farmed insects, but also to know the influence of insect consumption on the human health, its risks and safety. Given the uncertainties in European law, it is not yet clear what regulation and maximum levels of contaminants are to be applied to edible insects as a novel food. Before introducing insects to the European market, it is therefore necessary to amend and clarify the legislation and along with it the maximum levels of contaminants (Spiegel, 2013) including heavy metals (EFSA, 2015). At present, however, the toxicological limits of heavy metals in insect insects are not legislatively established, and therefore limits for the crustaceans are used, as the crustaceans are anatomically related to edible insects and have similar allergens (chitin).

Hyun (2012), Zielinska (2015), Nowak (2016) and Poma (2017) published chemical analyses with heavy metal contents in different insect species. It is assumed that the dependency of the content of selected elements in the body of insects depends mainly on the feed, the species and the breeding environment. E.g. Oonincx (2011) states that in *Locusta migratoria*, the change of feed led to changes in the content of copper from 24.5 to 28.5 mg.kg⁻¹ in penultimate instars and from 33.8 to 41.3 mg.kg⁻¹ in adults. In his study, the content of zinc detected was 137-150 mg.kg⁻¹ in penultimate instars and 137 – 172 mg.kg⁻¹ in adults. However, these studies do not focus either on edible insects kept in Central European conditions or on the rapid determination of metallic content in edible insects using X-ray spectrometry methods.

The aim of this study was to determine the selected elements' content using the X-ray fluorescence spectrometry in mealworm (*Tenebrio molitor*) and superworm (*Zophobas morio*) bred in the Czech Republic and to evaluate the influence of feed on the content of heavy metals and nutrients.

Scientific hypothesis

Scientific hypothesis is: The content of metals in the edible insect varies according to the type of feed and this change can be measured by means of a handheld X-ray spectrometer.

MATERIAL AND METHODOLOGY

Material

Chemicals

There were used:

- HNO₃ p. a., Mr. 63.01, Penta, Praha, CZ,
- H₂O₂ p. a., Mr. 34.02, Penta, Praha, CZ,
- CdCl₂ p. a., Mr. 183.32, CAS No.: [10108-64-2], Fluka analytical, Sigma Aldrich,
- ZnCl₂ p. a., Mr. 136.29, ML chemical, Troubsko, CZ,
- PbCl₂ p. a., Mr. 278.11, Lachema, n. p., Brno, CZ,
- CuCl₂ .2 H₂O p. a., Mr. 170.48, CAS No.: [10125-13-01], ML chemical, Troubsko, CZ,
- CH₃COOH p. a., Mr. 60.05, CAS No.: [64-19-7],
- Deionized water, 18.2 MOhm.cm, Milli-Q, Millipore.

All chemicals were of analytical reagent grade or equivalent analytical purity.

Insect

Larvae samples of the following species were used for analyses: superworm (*Zophobas morio*), mealworm (*Tenebrio molitor*). Samples were purchased at the Hostivice Feed Shop. The insects were kept in optimal conditions for development of each species. Insect species were divided into three experimental groups. The first group was fed with wheat bran, the second group was fed with oat bran, and the third group was fed with soy flour. All groups were fed ad libitum. Before the analysis, all insect samples of all species were modified as follows: larvae in the last and penultimate growth stages (full length of the body just prior to pupation) were taken. The next steps were: starving for 48 hours, killing with boiling water (100 °C) and drying at 105 °C. The samples prepared were homogenized and stored in a refrigerated box at 4 – 7 °C until analysis. In the next step, feed was analysed - wheat bran, oat bran and soy flour.

Nutrition values of the feed

Data by manufacturer are per 100 g of product:

- Wheat bran/crude: energy value: 1,210 kJ / 292kcal, fats 5.3 g, of which saturated fatty acids 0.88 g, carbohydrates 24.9 g, of which sugars 2.2 g, fiber 40.2 g, protein 16.2 g, salt 0.1 g. Company: Country Life, s.r.o., Beroun 1.
- Oat bran: energy value: 73.95 kJ / 17.67 kcal, fats 0.390 g, of which saturated fatty acids 0.070 g, carbohydrates 2.675 g, proteins 0.825 g, fiber 0.730 g, salt 0.004 g. Company: Natural Jihlava JK s.r.o., Jihlava.
- Soy flour/crude, whole: energy value: 1.770 kJ / 423 kcal, fats 20.7 g, of which saturated fatty acids 3 g, carbohydrates 25.6 g, of which sugars 7.5 g, protein 34.5 g, salt 0 g. Company: Paleta s.r.o., Lipnice 152.

Analyses of selected elements

A homogeneous 0.1 g of sample was placed in a tube, followed by the addition of 2 mL of 65% HNO₃. The metals were extracted for 24 hours at room temperature and then heated to 110 °C for 1 hour. Next, 200 µL of 30% H₂O₂ was added and the sample was heated for a further 30 minutes. After cooling, the sample was diluted with 5 times deionized water (v/v) (18.2 MOhm.cm, Milli-Q, Millipore).

In XRF spectrometry, the sample is identified by its radiation emission of a characteristic wavelength or energy. The amount of elements present is determined by measuring the intensity of its characteristic wave energy. The handheld ED-XRF spectrometer Innov-X DELTA (Innov-X Systems, INC., Woburn, USA) was used for the measurement. Samples were put in a special measuring capsule and then placed in a measuring box for analysis. The analysis was started using the control program DELTA Premium PC Software (Innov-X Systems, INC.).

Statistic analysis

The data were analysed using Excel 2013 (Microsoft Corporation, USA) and STATISTICA CZ version 12 (StatSoft, Inc., USA). The data obtained from experiment were evaluated according to basic statistical characteristic and results were expressed by average ±standard deviation.

Since the measured values of spikes and obliquities correspond to the normal distribution, the parametric statistical test ANOVA was used.

Comparison of the results was performed using a Fisher LSD assay ($\alpha = 0.05$).

RESULTS

In this study, in the first place the commodities used for feeding were analysed. In the next stage the insect itself was analysed. From the feed analysis results, it is clear that the largest amount of metals is found in wheat bran. In addition to the monitored elements, iron was also detected.

Lead was below the detection limit in all the measured samples. Similarly, copper was also often below the detection threshold for oat bran and soy flour. The statistical values of the monitored elements in the feed are shown in Table 1.

Next, element content was measured in samples of insects (mealworm and superworm) fed with various feeds (wheat bran, oat bran and soy flour). The mean and standard deviation of the monitored elements (Cu, Zn, Cd and Pb) are shown in Table 2.

Each measurement was performed 3 times and statistically processed by the ANOVA method, also the Fisher LSD test was performed. Comparison of zinc, cadmium and copper content in superworm and mealworm using the Fisher LSD assay between groups of different feeds (wheat bran, oat bran and soybean meal) is shown in Table 3. This test indicates statistically significant differences in the content of the monitored metals in the edible insect depending on the feed.

In the case of copper and superworm, a statistically significant difference was found between the group fed with wheat bran fried and other groups fed with oat bran and soy flour. There was no statistically significant difference between the groups fed with oat bran and soy flour, but the result was close to its limit ($p = 0.06$). A statistically significant difference between the group fed with wheat bran and the other groups is shown again in the mealworm. Similarly, the group fed with oat bran is statistically different from all other groups.

For zinc, statistically significant differences between all monitored groups were found in both species. The exception were the groups of superworm fed with oat bran and soy flour, among which no statistically significant difference were confirmed. Furthermore, a statistically significant difference was found between the two species fed with the same feed (wheat bran, soy flour), but in the case of oat bran no statistically significant difference was detected.

Table 1 Content of metals and microelements in feed.

Feed	Content of metals			
	Cu (mg.kg ⁻¹ ±SD)	Zn (mg.kg ⁻¹ ±SD)	Cd (mg.kg ⁻¹ ±SD)	Pb (mg.kg ⁻¹ ±SD)
Wheat bran	586 ±43	1095 ±72	102 ±11	<LOD
Oat bran	293 ±38	322 ±46	72 ±6	<LOD
Soy flour	315 ±16	415 ±25	74 ±13	<LOD

Table 2 Concentrations of metals and microelements in analysed samples of mealworm (TM) and superworm (ZM) with different feed (wheat bran, oat bran and soy flour).

Species	Feed	Content of metals			
		Cu (mg.kg ⁻¹ ±SD)	Zn (mg.kg ⁻¹ ±SD)	Cd* (mg.kg ⁻¹ ±SD)	Pb (mg.kg ⁻¹ ±SD)
ZM	Wheat bran	1768 ±131	1482 ±43	230 ±9	<LOD
ZM	Oat bran	828 ±138	666 ±21	163 ±22	<LOD
ZM	Soy flour	571 ±34	555 ±71	147 ±28	<LOD
TM	Wheat bran	1201 ±108	1071 ±24	183 ±23	<LOD
TM	Oat bran	767 ±56	725 ±92	157 ±18	<LOD
TM	Soy flour	1866 ±293	1437 ±143	186 ±27	<LOD

Note: * The Cd value exceeds the limit of 1.00 mg.kg⁻¹ in fresh weight, (Commission Regulation (EC) No 1881/2006).

In the case of cadmium, a statistically significant difference between the group of superworm fed with wheat bran and superworm groups fed with other feed was confirmed. There was no statistically significant difference between the other monitored groups.

DISCUSSION

In this study, two basic heavy metals (Cd, Pb), which are highly toxic to humans, and two microelements (Cu, Zn) have been investigated. These two microelements are important from the health point of view and their intake needs to be properly balanced to avoid undesirable health problems (The Czech Society for Nutrition, 2011).

In the case of superworm (*Zophobas morio* – ZM), the content of the monitored elements (except for the lead, which was below the detection limit), had a similar trend as for the feed that the insect was fed with. The high content of metals in wheat was reflected in the total content of the monitored metals in the body of the superworm. For other feeds with the lower content of the monitored elements, the content of these elements was also reduced in the body of the superworm.

For the mealworm (*Tenebrio molitor* – TM), the content of the observed elements in the insect body was higher when fed with wheat bran than oat bran. However, when using soy flour as feed, the observed microelements and Cd in the body of insects increased significantly in comparison with bran.

The copper content was between 571 – 1,768 mg.kg⁻¹ in superworm, and 767 mg.kg⁻¹ to 1,866 mg.kg⁻¹ in mealworm. These values indicate a high concentration of copper in these species, so they can serve as the source of this element. Compared with other authors, its content is significantly higher. A similar trend was also found in zinc, ranging from 555 mg.kg⁻¹ to 1482 mg.kg⁻¹ in superworm, and 725 mg.kg⁻¹ to 1437 mg.kg⁻¹ in mealworm.

The average cadmium content was higher than 147 mg.kg⁻¹ in all monitored samples and significantly exceeds the limit of 1.00 mg.kg⁻¹ in the fresh weight. For this reason, all analysed samples are potentially dangerous. The lead content was below the limit of detection for both species analysed and for all feeds used. Poma (2017), who studied nine minerals in his study, also came to this

Table 3 Comparison of zinc, copper and cadmium content in the analysed samples of mealworm (TM) and superworm (ZM) depending on feed (wheat bran, oat bran and soy flour) using the Fisher LSD test.

Species	Feed	Content of copper					
		ZM Wheat bran	ZM Oat bran	ZM Soy flour	TM Wheat bran	TM Oat bran	TM Soy flour
ZM	Wheat bran		0.00	0.00	0.00	0.00	0.45
ZM	Oat bran	0.00		0.06	0.00	0.64	0.00
ZM	Soy flour	0.00	0.06		0.00	0.15	0.00
TM	Wheat bran	0.00	0.00	0.00		0.00	0.00
TM	Oat bran	0.00	0.64	0.15	0.00		0.00
TM	Soy flour	0.45	0.00	0.00	0.00	0.00	

Species	Feed	Content of zinc					
		ZM Wheat bran	ZM Oat bran	ZM Soy flour	TM Wheat bran	TM Oat bran	TM Soy flour
ZM	Wheat bran		0.00	0.00	0.00	0.00	0.52
ZM	Oat bran	0.00		0.13	0.00	0.41	0.00
ZM	Soy flour	0.00	0.13		0.00	0.03	0.00
TM	Wheat bran	0.00	0.00	0.00		0.00	0.00
TM	Oat bran	0.00	0.41	0.03	0.00		0.00
TM	Soy flour	0.52	0.00	0.00	0.00	0.00	

Species	Feed	Content of cadmium					
		ZM Wheat bran	ZM Oat bran	ZM Soy flour	TM Wheat bran	TM Oat bran	TM Soy flour
ZM	Wheat bran		0.00	0.01	0.00	0.00	0.04
ZM	Oat bran	0.00		0.57	0.86	0.76	0.26
ZM	Soy flour	0.01	0.57		0.48	0.72	0.18
TM	Wheat bran	0.00	0.86	0.48		0.61	0.28
TM	Oat bran	0.00	0.76	0.72	0.61		0.16
TM	Soy flour	0.04	0.26	0.18	0.28	0.16	

conclusion. In the case of the mealworm, the Cu content was 5.81 mg.kg⁻¹, Zn 58.60 mg.kg⁻¹, Cd 0.06 mg.kg⁻¹, and the Pb content was lower than the detection limit. **Poma (2017)** proves in the study that insects can be a valuable source of micronutrients (Cu and Zn). The level of heavy metals detected in his study was lower than that of **Commission Regulation 1881/2006** and lower or comparable to conventional foods of animal origin.

Zielinska et al. (2015) also focused on the determination of minerals in edible insects, level of Cu for the *Tenebrio molitor* was 18.6 mg.kg⁻¹ and for Zn 112 mg.kg⁻¹ in their experiment. Recommended daily doses for humans reported by **Zielinská et al. (2015)** are 0.9 – 1.3 mg.day⁻¹ for Cu and 3 – 14 mg.day⁻¹ for Zn. ** (Linus Pauling Institute's Micronutrient Center). **Bukkens (2005)** states that insect is generally rich in minerals and their content is higher than that of the slaughtered animals. For mealworm the zinc content is comparable to beef (125 mg.kg⁻¹ beef and 112 mg.kg⁻¹ mealworm). **Finke (2004)**, in its review, reported a quantity of Cu for a mealworm 16 mg.kg⁻¹ and Zn 137 mg.kg⁻¹ and for superworm Cu 9 mg.kg⁻¹ and Zn 73 mg.kg⁻¹. In 2015, **Finke (2004)** measured copper Cu (8.3 mg.kg⁻¹) and Zn (49.5 mg.kg⁻¹) and in superworm Cu 3.6 mg.kg⁻¹ and Zn 30. 2 mg.kg⁻¹.

Analytical methods, which are often destructive and time-consuming for the preparation of samples, and in which concentrated acids are often used, were also used in the cited articles to analyse these values. Sample preparation for chemical analysis of elements usually takes from 20 minutes to several hours. Subsequent analysis is also time-consuming. The advantage of XRF spectrometry that was used in this work is its speed and simplicity of identification and quantification of basic elements over a wide range of concentrations ranging from several mg.kg⁻¹ to practically 100% of weight. The sample is not destroyed by XRF spectrometry itself and its preparation is not time-consuming. The sample returns to its original state in milliseconds.

CONCLUSION

This study was the first step in finding a quick and simple method for determining the heavy metal content (Cd and Pb) and micronutrients (Cu and Zn) by XRF analysis in order to obtain safe food from selected insect species (mealworm, superworm). The results prove that the content of the monitored elements depends on the species and the feed. The lead level was below the detection limit for all species observed, thus the food appears to be safe from this point of view. On the contrary, higher cadmium, zinc and copper contents were found in the study. The cadmium content in samples exceed the allowed sanitary limits, therefore they are unsuitable for consumption. X-ray fluorescence spectrometry can serve as a primary screening for the detection of heavy metals and micronutrients in food commodities including edible insects. It is quick, simple, and financially undemanding method.

REFERENCES

Belluco, S., Losasso, C., Maggioletti, M., Alonzi, C. C., Paoletti, M. G., Ricci, A. 2013. Edible Insects in a Food Safety and Nutritional Perspective: A Critical Review. *Comprehensive Reviews in Food Science and Food Safety*,

vol. 12, no. 3, p. 296-313. <https://doi.org/10.1111/1541-4337.12014>

Bukkens, G. F. 2005. Insects in the human diet: Nutritional aspects. In: Paoletti, M. G. *Ecological implications of minilivestock: potential of insects, rodents, frogs and snails*. Enfield, NH, USA : Science Publishers, p. 545-577. ISBN-13: 978-1578083398.

Decree No. 352/2009 of 29 April 2004. September 2009, amending Decree No 225/2008 Coll., laying down the requirements for the supplements and fortification. *Collection of laws (Czech Republic)*, 12.10.2009, 110 p.

DeFoliart, G. R. 1992. Insects as human food: Gene DeFoliart discusses some nutritional and economic aspects. *Crop Protection*, vol. 11, no. 5, p. 395-399. [https://doi.org/10.1016/0261-2194\(92\)90020-6](https://doi.org/10.1016/0261-2194(92)90020-6)

DeFoliart, G. R. 2002. The Human Use of Insects as a Food Resource: a Bibliographic Account in Progress [online] 2002-09-29. [cit. 2017-11-19] Available at: <http://labs.russell.wisc.edu/insectsasfood/the-human-use-of-insects-as-a-food-resource/#Preface/>.

Devkota, B., Schmidt, G. H. 2000. Accumulation of heavy metals in food plants and grasshoppers from the Taigetos Mountains, Greece. *Agriculture, Ecosystems & Environment*, vol. 78, no. 1, p. 85-91. [https://doi.org/10.1016/S0167-8809\(99\)00110-3](https://doi.org/10.1016/S0167-8809(99)00110-3)

EFSA, 2015. Risk profile related to production and consumption of insects as food and feed [online] s.a. [cit. 2017-11-19] Available at <http://dx.doi.org/10.2903/j.efsa.2015.4257>.

Finke, M. D. 2004. Nutrient content of insects. In Caoinera, J. L. *Encyclopedia of Entomology*. Heidelberg, Germany : Springer, p. 1563-1575. ISBN-13: 978-0-306-48380-6.

Finke, M. D. 2015. Complete nutrient content of four species of commercially available feeder insects fed enhanced diets during growth. *ZOO Biology*, vol. 34, no. 6, p. 554-564. <https://doi.org/10.1002/zoo.21246> PMID:26366856

Gaylor, M. O., Harvey, E., Hale, R. C. 2012. House crickets can accumulate polybrominated diphenyl ethers (PBDEs) directly from polyurethane foam common in consumer products. *Chemosphere*, vol. 86, no. 5, p. 500-505. <https://doi.org/10.1016/j.chemosphere.2011.10.014> PMID:22071374

Handley, M. A., Hall, C., Sanford, E., Diaz, E., Gonzalez-Mendez, E., Drace, K., Wilson, R., Villalobos, M., Croughan, M. 2007. Globalization, binational communities, and imported food risks: results of an outbreak investigation of lead poisoning in Monterey County, California. *American journal of public health*, vol. 97, no. 5, p. 900-906. <https://doi.org/10.2105/AJPH.2005.074138> PMID:17395841

Hyun, S. H., Kwon, K. H., Park, K. H., Jeong, H. C., Kwon, O., Tindwa, H., Han, Y. S. 2012. Evaluation of nutritional status of an edible grasshopper, *Oxya Chinensis Formosana*. *Entomological Research*, vol. 42, no. 5, p. 284-290. <https://doi.org/10.1111/j.1748-5967.2012.00469.x>

Memon, S. Q., Hasany, S. M., Bhangar, M. I., Khuhawar, M. Y. 2005. Enrichment of Pb(II) ions using phthalic acid functionalized XAD-16 resin as a sorbent. *Journal of Colloid And Interface Science*, vol. 291, no. 1, p. 84-91. <https://doi.org/10.1016/j.jcis.2005.04.112> PMID:15963526

Menzel, P., D'Aluisio, F. 1998. *Man eating bugs: the art and science of eating insects*. Berkeley, USA : Ten Speed Press. 191 p. ISBN-13: 978-1580080224.

- Mlcek, J., Rop, O., Borkovcova, M., Bednarova, M. 2014. A comprehensive look at the possibilities of edible insects as food in Europe – A Review. *Polish Journal of Food and Nutrition Sciences*, vol. 64, no. 3, p. 147-157. <https://doi.org/10.2478/v10222-012-0099-8>
- Nowak, V., Persijn, D., Rittenschober, D., Charrondiere, U. R. 2016. Review of food composition data for edible insects. *Food chemistry*, vol. 193, no. 1, p. 39-46. <https://doi.org/10.1016/j.foodchem.2014.10.114> PMID:26433285
- Oonincx, D. G. A. B., van der Poel, A. F. B. 2011. Effects of diet on the chemical composition of migratory locusts (*Locusta migratoria*). *Zoo Biology*, vol. 30, no. 1, p. 9-16. PMID:21319208
- Oymak, T., Tokaloğlu, Ş., Yılmaz, V., Kartal, Ş., Aydın, D. 2009. Determination of lead and cadmium in food samples by the coprecipitation method. *Food Chemistry*, vol. 113, no. 4, p. 1314-1317. <https://doi.org/10.1016/j.foodchem.2008.08.064>
- Paoletti, M. G. *Ecological implications of minilivestock: potential of insects, rodents, frogs and snails*. Enfield, Enfield, NH, USA : Science Publishers, 662 p. ISBN-13: 978-1578083398.
- Pavlovský, J. 2014. *Toxikologie (Toxicology)*, (Scriptum) [online] s.a. [cit. 2017-11-19] Available at: https://www.fmfi.vsb.cz/export/sites/fmfi/617/cs/ke-stazeni/Stud_opora_ModIn-Toxikologie-Jiri-Pavlovsky.pdf.
- Poma, G., Cuykx, M., Amato, E., Calaprice., Focant, J.F., Covaci, A. 2017. Evaluation of hazardous chemicals in edible insects and insect-based food intended for human consumption. *Food and Chemical Toxicology*, vol. 100, p. 70-79. <https://doi.org/10.1016/j.fct.2016.12.006> PMID:28007452
- Ramos-Elorduy, J. 2006. Threatened edible insects in Hidalgo, Mexico and some measures to preserve them. *Journal of Ethnobiology and Ethnomedicine*, vol. 2, no. 1, p. 1-10. <https://doi.org/10.1186/1746-4269-2-51> PMID:17144918
- Regulation (EC) No. 1881/2006 setting maximum levels for certain contaminants in foodstuffs. *OJ L 364/5*, 20.12.2006, p. 5-24.
- Regulation (EU) 2015/2283 of the European Parliament and of the Council of 25 November 2015 on novel foods, amending Regulation (EU) No 1169/2011 of the European Parliament and of the Council and repealing Regulation (EC) No 258/97 of the European Parliament and of the Council and Commission Regulation (EC) No 1852/2001. *OJ L 327*, 11.12.2015, p. 1-22.
- Sola, S., Bario, T., Martin, A. 1998. Cadmium and lead in pork and duck liver pastes produced in Spain. *Food Additives & Contaminants*, vol. 15, no. 5, p. 580-584. <https://doi.org/10.1080/02652039809374684> PMID:9829043
- The Czech Society for Nutrition. 2011. *Reference values for nutrient intake (Referenční hodnoty pro příjem živin)*. 1st ed. Praha, CZ : Výživa servis s.r.o. 192 p. ISBN-13: 978-80-254-6987-3.
- Toman, R., Golian, J., Massányi, P. 2003. *Food Toxicology (Toxikológia potravín)*. 1st ed. Nitra : Slovak University of Agriculture. 113 p. ISBN-10: 80-8069-166-5.
- Toman, R., Massányi, P., Lukác, N., Ducsay, L., Golian, J. 2005. Fertility and content of cadmium in pheasant (*Phasianus colchicus*) following cadmium intake in drinking water. *Ecotoxicology and Environmental Safety*, vol. 62, no. 1, p. 112-117. <https://doi.org/10.1016/j.ecoenv.2005.02.008> PMID:15978296
- van der Spiegel, M., Noordam, M. Y., van der Fels-Klerx, H. J. 2013. Safety of novel protein sources (insects, microalgae, seaweed, duckweed, and rapeseed) and legislative aspects for their application in food and feed production. *Comprehensive Reviews in Food Science and Food Safety*, vol. 12, no. 6, p. 662-678. <https://doi.org/10.1111/1541-4337.12032>
- van Huis, A., van Itterbeek, J., Klunder, H., Mertens, E., Halloran, A., Muir, G., Vantomme, P. 2013. *Edible insects: Future prospects for food and feed security*. Rome, Italy : FAO UN, Forestry Department, 201 p. ISBN 978-92-5-107595-1.
- Velišek, J. 2002. *Food Chemistry (Chemie potravín)*. 2nd ed. Tábor : OSSIS, 303 p. ISBN 80-86659-01-1.
- Zhuang, P., Zou, H., Shu, W. 2009. Biotransfer of heavy metals along a soil-plant-insect-chicken food chain: field study. *Journal of Environmental Sciences*, vol. 21, no. 6, p. 849-853. [https://doi.org/10.1016/S1001-0742\(08\)62351-7](https://doi.org/10.1016/S1001-0742(08)62351-7)
- Zielińska, E., Baraniak, B., Karaś, M., Rybczyńska, K., Jakubczyk, A., 2015. Selected species of edible insects as a source of nutrient composition. *Food Research International*, vol. 77, no. part 3, p. 460-466.

Acknowledgments:

This research was supported by the internal grant of TBU in Zlín [No. IGA/FT/2017/006] and project no. FEKT-S-17-3934 Utilization of novel findings in micro and nanotechnologies for complex electronic circuits and sensor applications.

Contact address:

Jiří Mlček, Tomas Bata University in Zlin, Faculty of Technology, Department of Food Analysis and Chemistry, Vavreckova 275, 760 01 Zlin, Czech Republic, E-mail: mlcek@ft.utb.cz

Martin Adánek, Brno University of Technology, Faculty of Electrical Engineering and Communication, Department of Microelectronics, Technická 3058/10, 616 00 Brno, Czech Republic, E-mail: adamek@feec.vutbr.cz

Anna Adámková, Tomas Bata University in Zlin, Faculty of Technology, Department of Food Analysis and Chemistry, Vavreckova 275, 760 01 Zlin, Czech Republic, E-mail: aadamkova@ft.utb.cz

Marie Borkovcová, Mendel University in Brno, Faculty of Agronomy, Department of Zoology, Fisheries, Hydrobiology and Agriculture, Zemědělská 1, 613 00 Brno, Czech Republic, marie.borkovcova@mendelu.cz

Martina Bednářová, Mendel University in Brno, Department of Information Technology, Zemědělská 1, 613 00 Brno, Czech Republic, E-mail: bednarova@mendelu.cz

Josef Skácel, Brno University of Technology, Faculty of Electrical Engineering and Communication, Department of Microelectronics, Technická 3058/10, 616 00 Brno, Czech Republic, E-mail: xskace09@stud.feec.vutbr.cz



CONSUMERS' PURCHASING PREFERENCES TOWARDS ORGANIC FOOD IN SLOVAKIA

Zdenka Kádeková, Roman Récky, Ludmila Nagyová, Ingrida Košičiarová, Mária Holienčinová

ABSTRACT

Submitted paper deals with the consumers' purchasing preferences towards organic food in Slovakia, pointing at the situation on the organic food market in Slovakia finding the consumers' preferences when buying organic food. The results of the questionnaire survey identified the preferences and opinions of respondents about organic food.

Paper analyses the questionnaire survey by 227 respondents concerning the purchasing preferences towards organic food in Slovakia. In order to achieve given aim and to ensure deeper analysis of the results, there had been stated 3 assumptions and 5 hypothesis. As the results of the survey proved, 65% of respondents buy organic food, of which 39% of respondents buy organic food at least once a week. Up to 98% of respondents have already met the concept of organic food and know what it means. 37 % of respondents buy mostly organic fruit and vegetables, 18% of respondents buy the most the meat and meat products in organic quality and 13% of respondents prefer dairy products in organic quality. The most preferred place to buy organic food are specialized stores (36 %), to buy organic food directly from the producer is the most popular way for 29 % of respondents, hypermarket and supermarkets are favorite place to buy organic food for 19% of respondents, and 12% of respondents buy organic food mostly in farmers' markets. Only 4% of respondents prefer another way to buy organic food. Quality of organic food and not using the pesticides is the most important criteria for buying organic food (36%). Price has also really strong influence on purchasing decision, when 34% of respondents are the most affected by the price when purchasing organic food. Package is considered as the least important criteria when buying organic food by 72% of respondents. On the basis of provided results of our survey and formulated hypothesis which were evaluated by Chi-square goodness of fit test, Chi square test of the square contingency and Kolmogorov-Smirnov test. Based on research can be concluded that there is a difference in preferences of respondents. In Slovakia exists the dependence between the consumers' preferences towards organic food and conventional food product and there are strong preferences for buying the organic food.

Keywords: organic food; consumer; purchasing preference; Slovak republic

INTRODUCTION

Organic food is currently widespread and an increasing number of consumers are becoming more interested in organic products and domestic products (Kretter, Kádeková, 2013). Consumers are aware of their benefits, but for many of them are inaccessible due to the higher price compared to conventional food (Givens et al., 2008). The higher price is caused by higher demands on the production of this food and a relatively demanding certification system (Krystallis, 2005).

Domestic organic food production is not big enough to cover the growing demand of consumers and therefore we need to import organic products (Hoyer, 2010). The most common is the import from the third-countries like China (Jankajová et al., 2016). Many consumers do not trust these products and are afraid that they are not real organic.

However, these imported foods must meet the strict criteria laid down by Slovak and European legislation (Baourakis, 2005).

Slovak consumers are increasingly looking for organic farming products and the private brands are trying to meet them. They include organic food in their assortment, and also expand by organic farming products (Halberg et al., 2006). However, organic products have insufficient marketing communications and therefore have to stand up to a competitive battle with conventional foods that have very strong marketing communication, especially advertising (Huttmanová et al., 2009). In general, we can say that the interest in organic food is increasing (Koivisto-Hursti, Magnusson, 2003). Consumers are aware that this food do not contain any pesticides and has better and more pronounced flavor (Golian, 2011).

Organic farming is receiving more and more attention in all its sectors (Horký et al., 2017).

The increasing consumer demand for organic products caused that the organic food market has expanded in all continents of the world (Nagyová et al., 2014). Organic foods represent a specific segment of the food market. Currently land area farmed organically in Slovakia represents 9% of the total agricultural land (Kozelová et al., 2013). In the year 2015, total 552 operators were registered in the organic farming system, with increase by 5% over the previous year. Besides organic farmers are also included the processors, importers, exporters and traders of organic food. Most Slovak organic produce goes as a raw material for further processing (Nagyová et al., 2014). The reason why there is no interest in supplying these products to the domestic market is the lower purchasing power of consumers in Slovakia compared to the Western European countries (Jankajová et al., 2016).

The organic food market is still shaping in Slovakia and it is important to keep consumers' confidence in organic products (Lacko-Bartošová et al., 2005). From the point of view of consumers, organic products attach a lot of benefits, in particular, that they consider them healthier, tastier and qualitative at a level comparable to that of ordinary foods, and last but not least, they attribute many benefits to the environment (Bordeleau et al., 2012).

Whatever the benefits of these products, there are also limitations that do not support the purchase of these foods (Laroche et al., 2001). On the one hand, there is insufficient public awareness, so people do not even realize that such products are in the market and on the other hand are there are some marketing problems associated with insufficient supply, distribution and promotion, which result in consumers' inability to find such products and easily distinguish them from conventional farming products (Kubelaková, 2015).

Europe has the largest and most elaborate market for organic products in the world (Kubelaková and Šugrová, 2017). The high level of growth in this market causes many sectors to suffer from insufficient supply, so the lack of local production must be offset by imports. (Blair, 2012).

Organic farming is experiencing boom, including the number of farmers, producers, processors and importers. Over the last few years, retail in organic products has grown strongly in most European countries, from 5% to 30% (Nagyová et al., 2012). Organic brand people abroad recognize as a sign of high quality food, which is characterized by natural taste and guarantees a healthier and more responsible approach to life (Magnusson et al., 2003). Since the share of organic food is small in the overall market, it is still addressing a target group of ecologically and healthily aware consumers who are not indifferent to their environment and their own health (Pickett-Baker et al., 2008).

In the Slovak Republic can be organic food and organic products bought:

- on organic farms and on sale from the yard
- in specialized retail stores with a healthy diet and local products
- in retail chains
- in online stores
- on fairs and exhibitions

- from farmers' markets (Kretter, Kádeková, 2013).

It can be concluded that consumer behavior is changing with the increasing demand for product quality and increasing environmental awareness among the population (Thompson, 1995). The situation in Slovakia, where organic food and environmentally friendly products have also been given space in trade chains, also looks good (Šugrová et al., 2016).

Recent research by TNS Slovakia (2017) shows that the potential for buying organic food in Slovakia really exists, generally almost 84% of inhabitants recognize the organic food and 29% of the Slovak population really purchase organic food (mainly yoghurts, meat, fruit and vegetables). Organic food is most often purchased by residents of Bratislava and Nitra region and people from the cities with more than 20,000 inhabitants. The biggest barrier to increasing environmental consumption is the high price of organic food and its relatively narrow range as well as the unavailability of different product categories. A positive trend affecting consumers as well as manufacturers or traders is that the issue of sustainable consumption at home and abroad is getting more attention to all types of media as well as to all levels of the education system. It is therefore likely that the segment of "environmentally conscious consumers" will grow over time (Padel, Foster, 2005). Organic food awareness is slightly higher in the neighboring Czech Republic, where it is known by up to 87% of people. There is also a slightly higher percentage of people buying these products, when 31% of Czechs buy organic food in comparison with Poland, where 57% of inhabitants know organic food but only 19% of Poles really purchase it (GfK Slovakia, 2017).

Although Slovakia can boast of intensive organic farming, the bulk of the production is directed towards exports, where organic food is processed and re-imported (Smutka et al., 2016). This increases their price and reduces sales in Slovakia. The reasons for the relatively small organic food market and the low demand for Slovaks are several, but the biggest one is undoubtedly a high price compared to the Slovak population's purchasing power (Récky, 2011).

Another dampening of domestic sales is limited distribution (Kubicová and Habánová, 2012). One of the welcome options is to sell from the yard so that the customer can buy organic food directly from the producers and therefore at discounted prices, helping to increase the sales of small family farms and the availability of organic products to the Slovak consumer (Rovný, 2016).

MATERIAL AND METHODOLOGY

The aim of the paper was to point at Slovak consumers' purchasing preferences towards organic food. In order to achieve the stated aim, there had been used the research methods of survey and structured questionnaire. The questionnaire survey was conducted from January to March 2017 on a sample of 227 respondents chosen randomly, their basic characteristics are given in the Table 1.

The questionnaire covered the entire territory of Slovakia, representing all regions. The questionnaire was conducted over the internet and consisted of 18 questions divided into two parts, the first part consisted of classification questions through which we surveyed the

Table 1 Characteristics of Respondents.

Category of Respondents	Number
Male	104
Female	123
Place of Residence	Number
City	129
Village	98
Age Structure	Number
15 – 19 years	9
20 – 25 years	38
26 – 35 years	79
36 – 49 years	69
50 years and more	32
Education Structure	Number
Primary education	9
Secondary education without A level	18
Secondary Education with A level	31
Higher professional education	67
Higher education	102
Net Family Income	Number
Up to 500 €	27
501 – 1.000 €	101
1.001 – 1.500 €	76
1.501 € and more	23
Region	Number
Banska Bystrica	22
Bratislava	55
Kosice	2
Nitra	94
Presov	4
Trencin	23
Trnava	12
Zilina	15

Source: Results of the research.

basic data on respondents. The second part of the questions concerned the issue of the purchase of organic food. In order to ensure the representativeness of the results, we applied the random selection and geographic diversification of our respondents. The questionnaire was evaluated using the contingency tables prepared by Microsoft Office Excel, under which they were subsequently created the graphs.

In the evaluation of the questionnaire was used Chi-square goodness of fit test, Chi square test of the square contingency and Kolmogorov-Smirnov test.

For deeper analysis of the results, there had been stated following assumptions:

-Assumption No.1 – we assume that most of our respondents have higher education.

-Assumption No.2 – we assume that most of our respondents have monthly income between 501 Euro and 1000 Euro.

-Assumption No.3 – we assume that most of our respondents live in the city.

We had stated following hypothesis:

H₀₁ – there does not exist the dependence between the frequency of organic food purchase and the respondent's place of living.

H₁₁ – there exists the dependence between the frequency of organic food purchase and the respondent's place of living.

H₀₂ – there does not exist the dependence between the respondents' purchasing preferences towards organic food and the respondent's income.

H₁₂ – there exists the dependence between the respondent's purchasing preferences towards organic food and the respondent's income.

H₀₃ – there does not exist the dependence between the place of purchase of organic food and the respondent's level of education.

H₁₃ – there exists the dependence between the place of purchase of organic food and the respondent's level of education.

H₀₄ – there does not exist the dependence between the price of purchased organic food and the respondent's level of income.

H₁₄ – there exists the dependence between the price of purchased organic food and the respondent's level of income.

H₀₅ – there does not exist the dependence between the consumers' preferences towards organic food and conventional food products, preferences are the same.

H₁₅ – there exists the dependence between the consumers' preferences towards organic food and conventional food

products, there are strong preferences for buying the organic food.

RESULTS AND DISCUSSION

According to the results of the questionnaire survey, 65% of respondents buy organic food, of which 39% of respondents buy organic food at least once a week (Figure 1). The majority of respondents buying organic food live in the city (78%). Up to 98% of respondents have already met the concept of organic food and know what it means.

Most respondents (37%) said they buy mostly organic fruit and vegetables. The second most important group that consumers most buy in organic quality is meat and meat products 18%, dairy products such as butter, yoghurt, cheese are purchased by 13% of respondents (Figure 2). At least consumers buy organic sweets, bakery, etc., which can also be caused by the fact that there is a difference in price by 100% or more. Consumer preferences are highly influenced by income, with up to 42% respondents said they would buy organic food in larger quantities and more often if they had a higher income.

Repondents in the questionnaire stated that the most preferred place to buy organic food are specialized stores (36%). To buy organic food directly from the producer is the most popular way for 29% of respondents, they also believe this is the way to make sure the purchased food is high quality and as fresh as possible. Hypermarkets and

supermarkets are the most preferred place to buy organic food for 19% of respondents, where they can find a wide range of organic food. Just 12% of respondents buy organic food mostly in farmers' markets and 4% of respondents prefer another way to buy organic food (e.g. internet store with organic food etc.) (Figure 3). Education of respondents plays an important role when deciding about purchasing the food, respondents with higher education are more likely to buy organic food, and at the same time tend to buy these products in specialized stores, directly from the producer or in the farmers' markets.

Figure 4 shows that 36% of respondents emphasize the quality of organic food, they strongly consider previous using of pesticides, price, when 34% of respondents is the most affected by the price when purchasing organic food and content of the product (18%). Another important criteria when buying organic food is the country of origin, 8% of respondents believe this is the most important factor when deciding about the purchase of organic food and the brand (4%). Slovak consumers are trying to favor domestic producers and thus support the domestic economy. In general, consumer behavior in organic food purchases is mainly influenced by the fact that no pesticides are used for cultivation, level of the organic food prices, organic food quality and its origin. Different cultural and social environment also significantly influence which food consumers choose. Package is considered as the least important criteria when buying organic food, this option was marked by 72% of respondents.

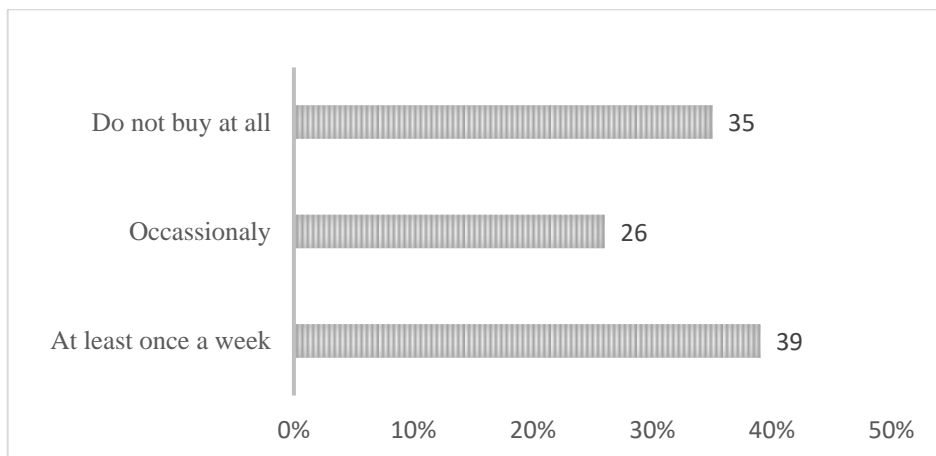

Figure 1 Frequency of Buying Organic Food (in %). Source: Results of the research.

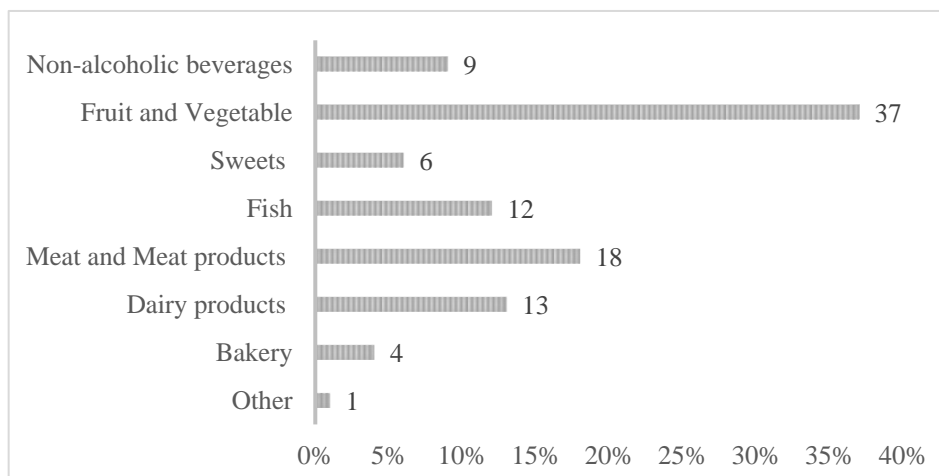

Figure 2 Preference of Purchased Organic Food (in %). Source: Results of the research.

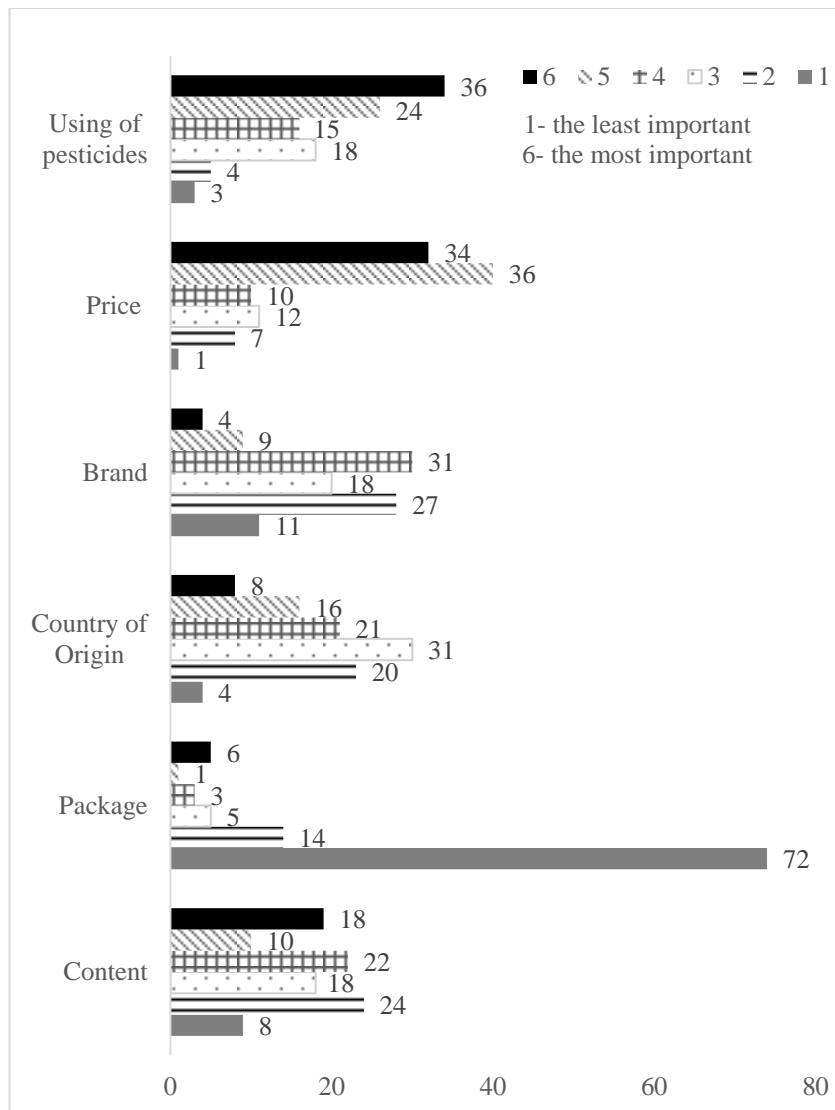

Figure 3 Preferred Place to buy Organic Food (in %). Source: Results of the research

Subsequently, we have identified the respondents' attitude towards the purchase of conventional food and organic food. To compare real, empirical preferences with theoretical preferences, we used the Kolmogorov-Smirnov test. We have set the following hypotheses:

H05 – there does not exist the dependence between the preferences towards organic food and conventional food products, preferences are the same.

H15 – there exists the dependence between the preferences

towards organic food and conventional food products, there are strong preferences for buying the organic food.

The value of the test characteristics 0.357 was greater than the table value 0.113465, meaning that we rejected the null hypothesis H05 and accepted hypothesis H15, claiming that there is a difference in consumer preferences when buying food, and with 95% probability we can claim that there is a difference in preferences of respondents and there is a clear preference for organic food purchases.

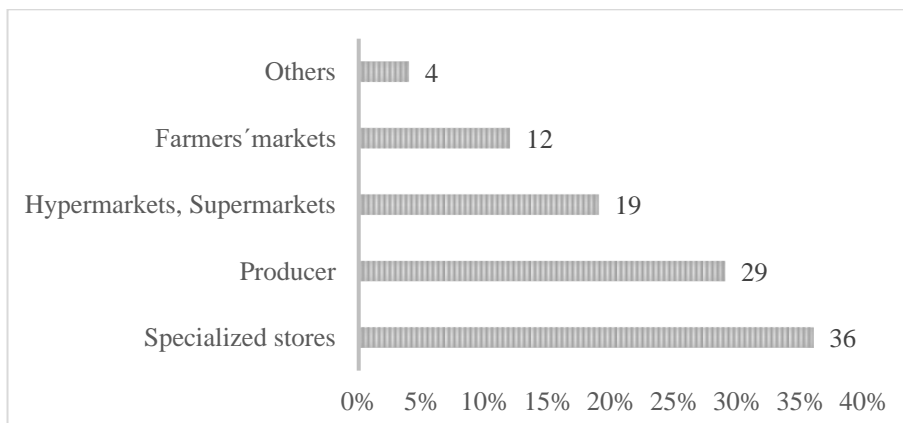

Figure 4 The Most Important Criteria when Buying Organic Food (in%). Source: Results of the research.

There exists the dependence between the preferences towards organic food and conventional food products, there are strong preferences for buying the organic food – accepted.

Evaluation of Formulated Hypotheses

Connected with few of above evaluated questions, there have appeared also the questions of the dependence resp. independence between few variables. This is the reason for formulating five different hypotheses in Material and Methodology. These have been tested by using Chi-square goodness of fit test, Chi square test of the square contingency and Kolmogorov-Smirnov test.

H₀₁ – there does not exist the dependence between the frequency of organic food purchase and the respondent's place of living- rejected.

H₁₁ – there exists the dependence between the frequency of organic food purchase and the respondent's place of living – accepted.

H₀₂ – there does not exist the dependence between the respondents' purchasing preferences towards organic food and the respondent's income – rejected.

H₁₂ – there exists the dependence between the respondents' purchasing preferences towards organic food and the respondent's income - accepted.

H₀₃ – there does not exist the dependence between the place of purchase of organic food and the respondent's level of education- rejected.

H₁₃ – there exists the dependence between the place of purchase of organic food and the respondent's level of education- accepted.

H₀₄ – there does not exist the dependence between the price of purchased organic food and the respondent's level of income- rejected.

H₁₄ – there exists the dependence between the price of purchased organic food and the respondent's level of income – accepted.

H₀₅ – there does not exist the dependence between the consumers' preferences towards organic food and conventional food products, preferences are the same- rejected.

H₁₅ – there exists the dependence between the consumers' preferences towards organic food and conventional food products, there are strong preferences for buying the organic food- accepted.

CONCLUSION

Nowadays, many people realize the importance of a healthy lifestyle. Organic food is becoming more popular and almost all of our everyday products can be found in the organic quality as well. Consumers buy organic products because they consider them healthier and better than conventional foods and because they are grown without using of pesticides. Paper analyses the consumers' purchasing preferences towards organic food in Slovakia, pointing at the situation on the organic food market in Slovakia. To find the consumers' preferences when buying organic food was taken the questionnaire survey by 227 respondents. In order to achieve given aim and to ensure deeper analysis of the results, there had been stated following 3 assumptions and 5 hypothesis:

-Assumption No.1 – we assumed that most of our respondents have higher education.

-Assumption No.2 – we assumed that most of our respondents have monthly income between 501 Euro and 1000 Euro.

-Assumption No.3 – we assumed that most of our respondents live in the city.

We had stated following hypothesis:

H₀₁ – there does not exist the dependence between the frequency of organic food purchase and the respondent's place of living.

H₁₁ – there exists the dependence between the frequency of organic food purchase and the respondent's place of living.

H₀₂ – there does not exist the dependence between the respondents' purchasing preferences towards organic food and the respondent's income.

H₁₂ – there exists the dependence between the respondent's purchasing preferences towards organic food and the respondent's income.

H₀₃ – there does not exist the dependence between the place of purchase of organic food and the respondent's level of education.

H₁₃ – there exists the dependence between the place of purchase of organic food and the respondent's level of education.

H₀₄ – there does not exist the dependence between the price of purchased organic food and the respondent's level of income.

H₁₄ – there exists the dependence between the price of purchased organic food and the respondent's level of income.

H₀₅ – there does not exist the dependence between the consumers' preferences towards organic food and conventional food products, preferences are the same.

H₁₅ – there exists the dependence between the consumers' preferences towards organic food and conventional food products, there are strong preferences for buying the organic food.

As the results of the survey proved, 65% of respondents buy organic food, of which 39% of respondents buy organic food at least once a week. Up to 98% of respondents have already met the concept of organic food and know what it means. 37% of respondents buy mostly organic fruit and vegetables, 18% of respondents buy the most the meat and meat products in organic quality and 13% of respondents prefer dairy products in organic quality. Respondents in the questionnaire stated that the most preferred place to buy organic food are specialized stores (36%). To buy organic food directly from the producer is the most popular way for 29% of respondents, hypermarket and supermarkets are the most preferred place to buy organic food for 19% of respondents, 12% of respondents buy organic food mostly in farmers' markets and 4% of respondents prefer another way to buy organic food (e.g. internet store with organic food etc.). Education of respondents plays an important role when deciding about purchasing the food, respondents with higher education are more likely to buy organic food. Quality of organic food and not using the pesticides is the most important criteria for buying organic food (36%). Price has also really strong influence on purchasing decision, when 34% of respondents are the most affected by the price

when purchasing organic food. Package is considered as the least important criteria when buying organic food by 72% of respondents.

On the basis of provided results of our survey and formulated hypothesis which were evaluated by Chi-square goodness of fit test, Chi square test of the square contingency and Kolmogorov-Smirnov test can be concluded, that

–there exists the dependence between the frequency of organic food purchase and the respondent's place of living,
 –there exists the dependence between the respondents' purchasing preferences towards organic food and the respondent's income,

–there exists the dependence between the place of purchase of organic food and the respondent's level of education,

–there exists the dependence between the price of purchased organic food and respondent's level of income.

To compare real, empirical preferences with theoretical preferences, we used the Kolmogorov-Smirnov test. The value of the test characteristics 0.357 was greater than the table value 0.113465, meaning that we rejected the null hypothesis H_0 and accepted hypothesis H_1 , claiming that there is a difference in consumer preferences when buying food, and with 95% probability we can claim that there is a difference in preferences of respondents and there is a clear preference for organic food purchases. There exists the dependence between the consumers' preferences towards organic food and conventional food products, there are strong preferences for buying the organic food.

On the basis of the findings from the questionnaire survey, we formulate the following suggestions:

•Ensuring higher demand for organic food can be achieved by increasing of promotion of organic food at least to the level of promotion of conventional food, in order to increase consumer awareness.

•Another possibility to increase organic food sales is financial support from the state for domestic organic farmers and processors of organic products, which would also increase the interest in the production and processing of organic products by young farmers as well.

•Another option to increase demand for organic food and the interest of consumers in organic food is to organize healthy nutrition projects in schools so the children realize the benefits of healthy nutrition.

REFERENCES

Baourakis, G. 2004. *Marketing trends for organic food in the 21st Century*. 3rd ed. New York, USA : World Scientific. 338 p. ISBN 981-238-768-4.

Lacko-Bartošová, M. et al. 2005. *Udržateľné a ekologické poľnohospodárstvo (Sustainable and Organic Farming)*. 1st ed. Nitra : SUA. 575 p. ISBN 80-8069-556-3. (In Slovak)

Blair, R. 2012. *Organic Production and Food Quality: A Down to Earth Analysis*. 1st ed. Oxford : Wiley-Blackwell. ISBN 978-0-8138-1217-5.

Bordeleau, G., Myers-Smith, I., Midak, M., Szeremeta, A. 2002. *Food quality: Comparison of organic and conventional fruits and vegetables*. Frederiksberg : NL Den Kongelige Veterinærlog. p. 81.

GfK Slovakia, 2017. [online] s.a. [cit. 2017-02-11] Available at: <http://www.gfk.com/sk/insights/>.

Givens, I., Baxter, S., Minihane, A. M., Shaw, E. 2008. *Health benefits of organic food: Effects of the environment*. 1st

ed. Wallingford : CABI Publishing. 336 p. ISBN 978-1-84593-459-0.

Golian, J. 2011. Food – quality and safety for the consumer (Potraviny – kvalita a bezpečnosť pre spotrebiteľa). *Epicure*, no. 21, p. 64-67. (In Slovak)

Halberg, N., Alrøe, H. F., Knudsen, M. T., Kristensen, E. S. 2006. *Global development of organic agriculture: Challenges and prospects*. 1st ed. Oxford : CABI Publishing. ISBN 978-18-4593-078-3.

Honkanen, P., Verplanken, B., Svein, O. O. 2006. Ethical values and motives driving organic food choice. *Journal of Consumer Behavior*, vol. 5, no. 5, p. 420-430. <https://doi.org/10.1002/cb.190>

Horký, P., Skládanka, J., Nevrlka, P., Falta, D., Čáslavová, I., Knot, P. 2017. Effect of protein concentrate supplementation on the composition of amino acids in milk from dairy cows in an organic farming system. *Potravinarstvo*, vol. 11, no. 1, p. 88-95. <https://doi.org/10.5219/707>

Hoyer, W. D., Macinnis, D. J. 2008. *Consumer behavior*. 5th ed. South Western College : Nelson Education. 672 p. ISBN 9780547079929.

Huttmanová, E., Synčáková, L. 2009. Dimensions for evaluation of sustainable development and human development. In *Hradecké ekonomické dny 2009: ekonomický rozvoj a management regionů*. Hradec Králové : Gaudeamus, p. 204-211. ISBN 978-80-7041-455-2.

Jankajová, E., Kotus, M., Holota, T., Zach, M. 2016. Risk Assessment of Handling Loads in Production Process. *Acta Universitatis Agriculturae et Silviculturae*, vol. 64, no. 2, p. 449-453. <https://doi.org/10.11118/actaun201664020449>

Kohls, L. R., Uhl, N. J. 2012. *Marketing of Agricultural Products*. 1st ed. Madison : University of Wisconsin. 544p. ISBN 978-013-010-584-4.

Koivisto-Hursti, U. K., Magnusson, M. K. 2003. Consumer perceptions of genetically modified and organic foods. What kind of knowledge matters? *Appetite*, vol. 41, no. 2, p. 207-209.

Kozelová, D., Vietoris, V., Fikselová, M. 2013. Quality and availability of organic foods by Slovak consumers. *Potravinarstvo*, vol. 7, no. 1, 2013, p. 146-150. <https://doi.org/10.5219/306>

Kretter, A. 2005. *Organic farming and eco-products marketing (Marketing ekologického poľnohospodárstva a ekoproduktov)*. 1st ed. Nitra : SUA. 38 p. ISBN 80-8069-620-9.

Kretter, A., Kádeková, Z. 2013. Eco marketing in agriculture and barriers to organic food sales. *Zeszyty Naukowe Szkoły Głównej Gospodarstwa Wiejskiego w Warszawie*, vol. 59, no. 10, p. 394-401.

Krystallis, A., Chrysosoidis, G. 2005. Consumer's willingness to pay for organic food factors that affect it and variation per organic, product type. *British Food Journal*, vol. 107, no. 4-5, p. 320-323. <https://doi.org/10.1108/00070700510596901>

Kubelaková, A. 2015. Visualizing the importance of marketing aimed at supporting the sale of domestic products on the Slovak market (Zviditeľnenie významu marketingu zameraného na podporu predaja domácich produktov na slovenskom trhu). In *Zborník príspevkov z konferencie ŠVOČ s medzinárodnou účasťou*. Nitra : Slovenská poľnohospodárska univerzita. p. 84-100. ISBN 978-80-552-1350-7.

Kubelaková, A., Šugrová, M. 2017. Habit or choice? The decision – making process of young generation in purchasing dairy products in the Slovak Republic. In *International Day of*

Science 2017 – economics, management, innovation. Olomouc : Moravian University College, p. 113-120.

Kubicová, E., Habánová, M. 2012. Development of milk consumption and marketing analysis of its demand. *Potravinárstvo*, vol. 6, no. 4, p. 66-72. <https://doi.org/10.5219/236>

Laroche, M., Bergeron, J., Barbaro-Forleo, G. 2001. Targeting consumers who are willing to pay more for environmentally friendly products. *Journal of Consumer Marketing*, vol. 18, no. 6, p. 503-520. <https://doi.org/10.1108/EUM00000000006155>

Magnusson, M. K., Arvola, A., Hursti, U. K. K., Åberg, L., Sjöden, P. O. 2003. Choice of organic food is related to perceived consequences for human health and to environmentally friendly behaviour. *Appetite*, vol. 40, no. 2, p. 109-117. [https://doi.org/10.1016/S0195-6663\(03\)00002-3](https://doi.org/10.1016/S0195-6663(03)00002-3)

Nagyová, E., Horská, E., Paluchová, J., Kleinová, K., Kádeková, Z., Récky, R. 2012. *Trends in consumer behavior on the food products market in the Slovak Republic (Trendy v spotrebiteľskom správaní na trhu potravinárskych produktov v SR)*. 1st ed. Nitra : SUA. 83 p. ISBN 978-80-552-0899-2. (In Slovak)

Nagyová, E. et al. 2014. *Marketing*. 1st ed. Nitra : SUA. 460 p. ISBN 978-80-552-1269-2. (In Slovak)

Nagyová, E., et al. 2014. *Výskum trhu*. 1st ed. Nitra : SUA. 315 p. ISBN 978-80-552-1271-5. (In Slovak)

Padel, S., Foster, C. 2005. Exploring the gap between attitudes and behaviour: Understanding why consumers buy or do not buy organic food. *British Food Journal*, vol. 107, no. 8, p. 606-625. <https://doi.org/10.1108/00070700510611002>

Pickett-Baker, J., Ozaki, R. 2008. Pro-environmental products: marketing influence on consumer purchase decision. *Journal of Consumer Marketing*, vol. 25, p. 281-293. <https://doi.org/10.1108/07363760810890516>

Récky, R. 2011. Consumer behavior by purchase of foodstuff (Spotrebiteľské správanie úri nákupe potravín). In Poláčik, T. *Marketing in practise of agro-food sector (Marketing v praxi agropotravinárskeho sektora: zborník vedeckých prác)*. Nitra : SUA, p. 82-86. ISBN: 978-80-552-0529-8. (In Slovak)

Rovný, P. 2016. Efficiency of small farms in the Slovak agriculture. In Olexová, C. et al. *Marketing management,*

trade, financial and social aspects of business. Bratislava : University of Economics, p. 6.. ISBN 978-80-225-4293-7.

Smutka, L., Rovný, P., Pulkrábek, J., Horská, E. 2016. Foreign trade in sugar (HS1701) and sugar containing products (HS17) – comparison of the Czech and Slovak Republic during the last two decades. *Listy cukrovarnícké a řepařské*, vol. 132, p. 234-240.

Šugrová, M., Šedík, P., Svetlíková, V. 2016. Brand influence of young generations's decisions in purchasing yogurts in the Slovak Republic. In *Future scientists for sustainable development*. Gödöllő : Szent István University, p. 482-495. ISBN 978-963-269-451-1.

Thompson, G. D. 1995. Consumer demand for organic foods: What we know and what we need to know. *American Journal of Agricultural Economics*; vol. 80, no. 5, p.1113-1118. <https://doi.org/10.2307/1244214>

TNS Slovakia. 2017. [online] s.a. [cit. 2017-05-23] Available at: <http://www.tns-global.sk/slovensky-marketer>.

Contact address:

Zdenka Kádeková, Slovak University of Agriculture, Faculty of Economics and Management, Department of Marketing and Trade, Tr. A. Hlinku 2, 949 76 Nitra, Slovakia, E-mail: zdenka_kadekova@yahoo.com

Roman Récky, Slovak University of Agriculture, Faculty of Economics and Management, Department of Marketing and Trade, Tr. A. Hlinku 2, 949 76 Nitra, Slovakia, E-mail: roman.recky@uniag.sk

Ludmila Nagyová, Slovak University of Agriculture, Faculty of Economics and Management, Department of Marketing and Trade, Tr. A. Hlinku 2, 949 76 Nitr, Slovakia, E-mail: ludmilanagyova@hotmail.com

Ingrida Košičiarová, Slovak University of Agriculture, Faculty of Economics and Management, Department of Marketing and Trade, Tr. A. Hlinku 2, 949 76 Nitra, Slovakia, E-mail: ingrida.kosiciarova@gmail.com

Mária Holienčinová, Slovak University of Agriculture, Faculty of Economics and Management, Department of Marketing and Trade, Tr. A. Hlinku 2, 949 76 Nitra, Slovakia, E-mail: maria.holiencinova@gmail.com



THE WINE MARKET – AN EMPIRICAL EXAMINATION OF IN-STORE CONSUMER BEHAVIOUR

Bartłomiej Pierański, Barbara Borusiak, Elena Horská

ABSTRACT

Business success in the current highly competitive environment determines primarily the ability to understand the customer and his needs and identify the factors that influence consumer behavior. Therefore, the examination of consumer behavior and obtaining feedback on the development and state of the market as well as identifying current trends is an essential part of any successful business. Producers and traders are increasingly forced to adapt to the rapid development and changes in the market. This is especially important with food products, given the wide range of assortment, substitutability of particular groceries and strengthening competitive pressure of manufacturers and retailers. In general, consumer decision-making related to food is influenced by a number of different factors that are changing under the influence of new trends (greater emphasis on quality, country of origin etc.). Even more specific category is the wine market, which is subject to specific criteria of consumer choice, since from a consumer perspective, it is not a product of daily consumption. The world wine market is increasing; new producers as well as new groups of customers are emerging on the market. The distribution channels are becoming more diversified and wine is offered in both specialty stores and self-service outlets; hypermarkets, supermarkets and discount stores. Due to this trend the investigation of in-store consumer behavior becomes crucial. The aim of the paper is to discuss the usefulness of eye tracking based research for examining perceptions of people shelf displays. The research integrates measurements with a mobile eye camera (Eye tracker glasses) in real conditions of a wine shop in order to reveal the impact of merchandising (display of domestic and foreign wines) on the visual attention of the consumer. The results of qualitative research carried out in March 2015 will be presented.

Keywords: in-store behaviour; eye tracking; merchandising; wine market

INTRODUCTION

As the importance of self-service retail increases, so does the interest in research on the behaviour of customers in self-service stores. This also applies to the customers' perception of in-store merchandise displays because it has a significant impact on the level of sales for the products concerned. Perceptual studies are based on non-participant observation methods using recording tools, in particular eye trackers. The aim of this article is to present the results of studies on the perception of wine shelf displays within stores conducted using an eye tracker.

I. The Polish and Slovak wine markets

The Polish and Slovak wine markets have a relatively short history and are in the early stages of development. Under a communist economy, the wine producing industry was virtually non-existent in these countries. The very small demand for this beverage was satisfied primarily by imported wines, produced mainly in Bulgaria, Romania and Hungary. In view of the fact that the most commonly consumed alcoholic drinks were vodka and beer, the

requirements regarding wine quality were very low. The small quantities of wine that were consumed were mostly young wines of high acidity and unsophisticated taste (Rekowski 2013). The fall of communism and the resultant opening of their economies to free trade created the foundations for a transformation of the Polish and Slovak wine markets, which involved the wide availability of wines imported from European countries (mainly Italy and France) and from the so-called New World producers (Australia, USA, Chile and Argentina).

It must be noted, however, that despite a similar history and similar geographical location the wine markets in Poland and Slovakia are different in several important aspects. First of all, unlike in Slovakia, wine production in Poland is at a marginal level and is conducted primarily as a hobby. As a result, the demand for wine is met almost entirely through imports. The vineyards which exist in Poland produce wines that are of no commercial significance. Their production is the result of the not very profitable passion of the vineyard owners. Polish wines are distributed mainly through hotels and restaurants. In

Slovakia, on the other hand, the production and consumption of wine are an important part of the national market. For example, in 2014 the low supply of Slovak wines due to bad harvests had a negative impact on overall wine sales in Slovakia. This is probably connected with the fact that, according to estimates, approximately half of the total supply of wine comes from domestic producers (Horská et al. 2016). Moreover, the production of wine is so high that some of it is exported. The main direction for exports is the market of the neighbouring Czech Republic (Euromonitor International, 2015).

Another noticeable difference between the Polish and Slovak wine markets is the consumption of wine. In absolute terms, the consumption in Poland is about twice as high as in Slovakia (Figure 1). However, considering the populations of the two countries (about 38.4 million in Poland and about 5.4 million in Slovakia), the consumption of wine *per capita* in Slovakia is about five times higher than in Poland (Figure 2).

Data analysis also points to different dynamics for changes in wine consumption. While in the period analysed the Slovak market remained unchanged, the Polish market recorded a clear increase in wine consumption (by 21% between 2009 and 2014). This is connected mainly with certain economic and social changes in Poland. The former include the increased availability of wines of relatively high quality offered at very attractive prices. This trend is driven by discount stores, which are a leader in wine sales in Poland (Figure 3). As a result of competitive pressure, a similar range of wines is increasingly being offered by hypermarkets and supermarkets as well as specialty stores. The availability of wines is complemented by an ongoing social transformation, manifested in the changing preferences of customers, who consume less and less vodka and mass-produced lager beer and more and more whisky and wine. However, this does not change the fact that in Poland wine is often regarded as a luxury and elitist beverage. This is because it is consumed mainly by people with above-average earnings and higher education. Due to its relatively low alcohol content, wine consumers are predominantly women (Euromonitor International,

2015). In Slovakia, on the other hand, due to its higher consumption and hence greater popularity, wine has a much more democratic appeal. Its consumption is not noticeably correlated with, among others, age or gender. In addition, high price elasticity of demand is evident, as reflected by a considerable growth in purchases as a result of promotional price reductions (Kubicová & Kádeková, 2011; Kozelová et al. 2012; Euromonitor International, 2015).

Despite some significant differences, the wine markets in Poland and Slovakia also exhibit some similarities. The most significant one concerns the places where consumers from both countries frequently purchase wine. Generally it can be concluded that these are self-service stores (see Figures 3 and 4).

In Poland, self-service type stores sell 80% of wine (discount stores, hypermarkets and supermarkets), while in Slovakia it is 70% (hyper- and supermarkets as well as convenience stores). Although the above figures are not entirely consistent (no category of convenience stores for the Polish market and no discount stores for the Slovak market), they clearly show that customers usually make decisions relating to wine purchases alone (without the help of qualified staff). This fact, combined with the relatively low knowledge and culture of drinking wine in these countries, means that in self-service stores the main factor that customers take into consideration when buying wine is the price. This is the case not only in the markets under discussion, but also in countries with an incomparably longer wine-drinking tradition, for example Italy (Riviezzo et al., 2014; Vietoris et al. 2016). In addition, issues related to merchandising are becoming increasingly important, for example those relating to the organization of the entire wine shelf. A retailer has to decide on the criterion according to which the wines will be grouped (e.g. country of origin, type, or colour). Moreover, from the point of view of the suppliers of wines, the matter of the appropriate presentation of their products is very important, which involves, for example, placing the bottles on appropriate shelves, proper lighting, etc. (Barborová et al. 2013; Nagyová, Berčík & Horská, 2014).

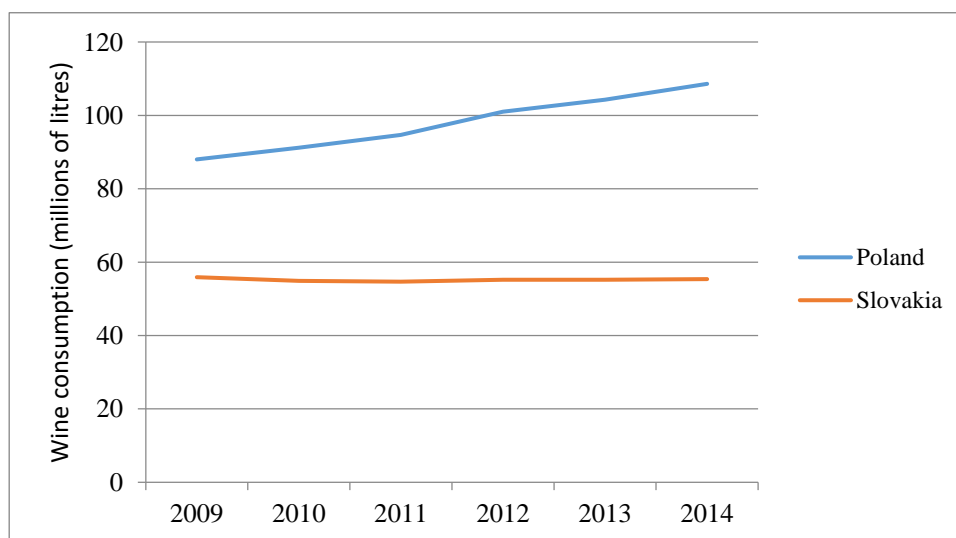

Figure 1 Wine consumption in Poland and Slovakia (in millions of litres) for the years 2009-2014. Source: own compilation based on: Euromonitor International, July 2015 and August 2015.

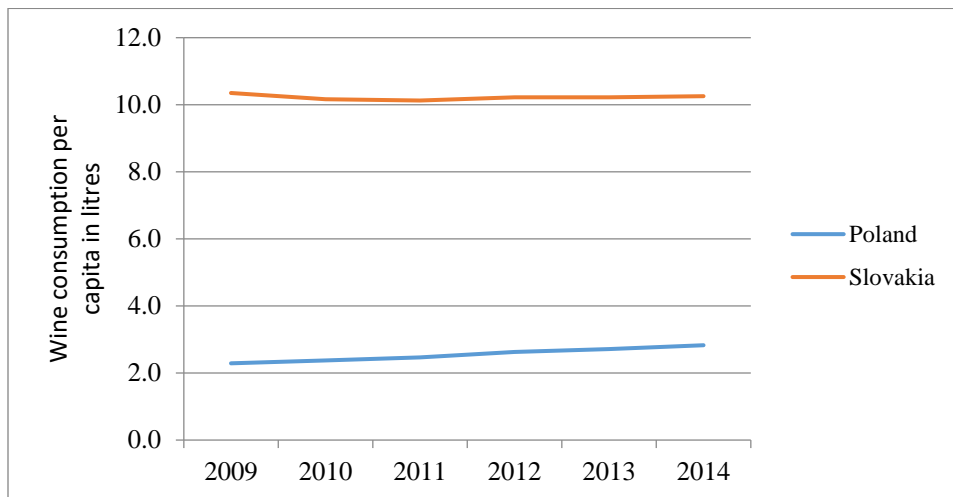

Figure 2 Wine consumption per capita in Poland and Slovakia (in litres) for the years 2009-2014.
Source: own compilation based on: Euromonitor International, July 2015 and August 2015.

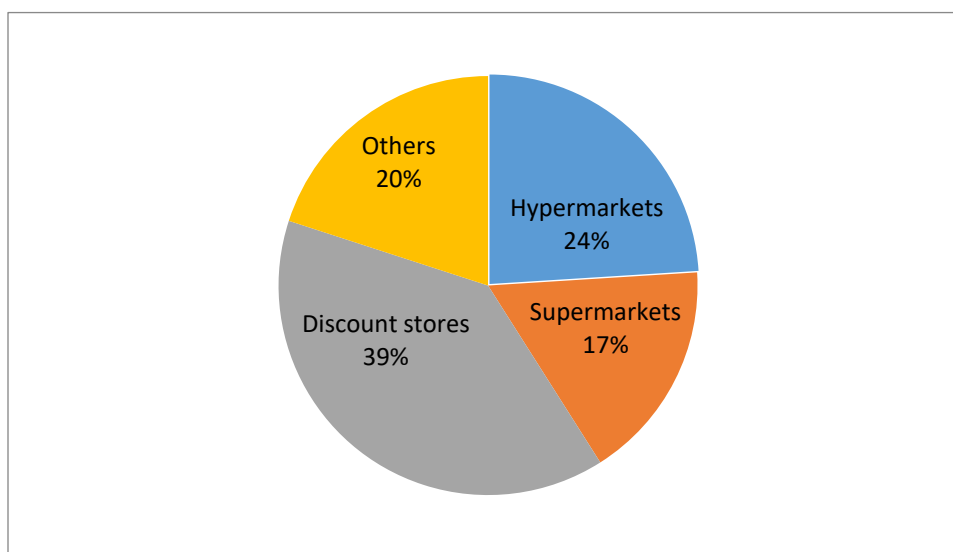

Figure 3 Places where wine purchases are made in Poland.
Source: own compilation based on www.dlahandlu.pl.

II. Consumer perception of shelf displays

The display and the placement on the shelf become particularly important in affecting the perception of quality and the level of involvement before and during the purchase (Marchini et al. 2015; Berčík et al. 2016). Creating a plan of how products are placed on retail shelves, i.e. constructing a planogram, is one of the techniques of merchandising (Buttle 1985; Borusiak 2009; Berčík, 2016). This can be regarded as a set of activities undertaken by the retailer with the aim of organising the store area, or as part of manufacturers' promotional activities. The importance of designing a planogram for the level of sales of a particular category of products is directly proportional to the share of self-service stores in the distribution of these products, i.e. stores where customers select a product (in this case wine) on their own. This is closely connected with the different productivity of specific parts of each shelf, resulting from differences in the perception of shelf displays. Research on visual perception using an eye tracker indicates that the preferred viewing line is approximately 15 degrees below the line of sight (see Fig. 5). As regards the perception of

objects, the visual field is important, which is the area that can be seen when the eyes are focused on a central point. Generally, the visual field is species-specific (Maggs, Miller and Ofri 2009; Berčík et al. 2015, Mokry et al. 2016). In humans it is somewhat narrower than in the case of many birds, fish and other mammals, being approximately 150 degrees in the horizontal plane (with the partial overlapping of the fields of vision it is 200 degrees for both eyes) and 120 degrees in the vertical plane. In the case of close-up views, however, the visual field is much smaller: it is an area defined by the angle between lines running approximately 25 degrees above the line of sight, and 30-35 degrees below eye level (Hendrickson and Ailawadi, 2014).

The best perception and the highest productivity of a shelf pertain to the area within the range of the customer's sight: the goods displayed there are in a place that the customer notices first. The productivity of the shelves situated within an arm's reach is slightly lower. The least productive are shelves located just above the floor as well as the topmost ones, i.e. those above the line of sight. However, the visibility of products placed on the top shelf depends on the distance between the customer and the

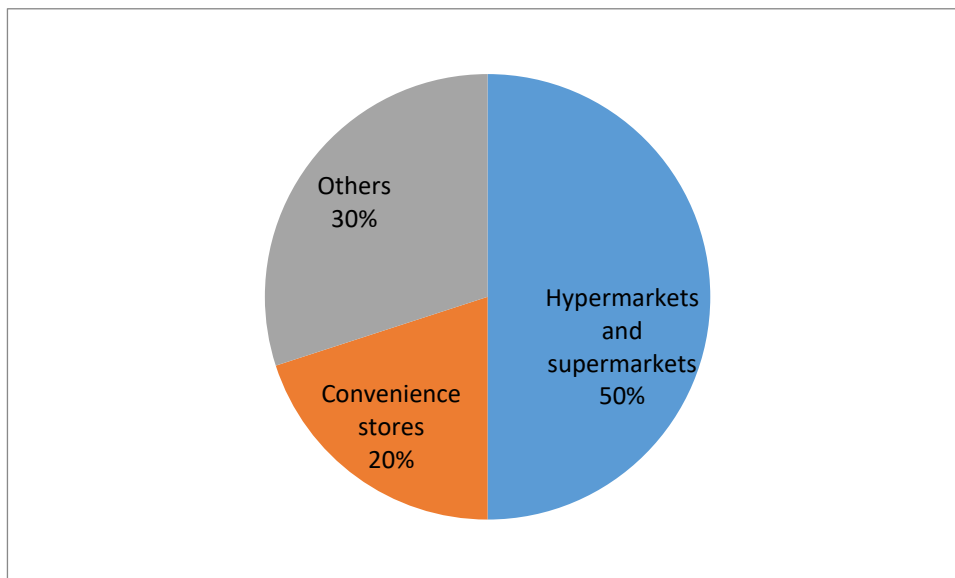

Figure 1 Research on visual attention when checking wines under real conditions. Source: Individual processing by the author based on his research in 2015.

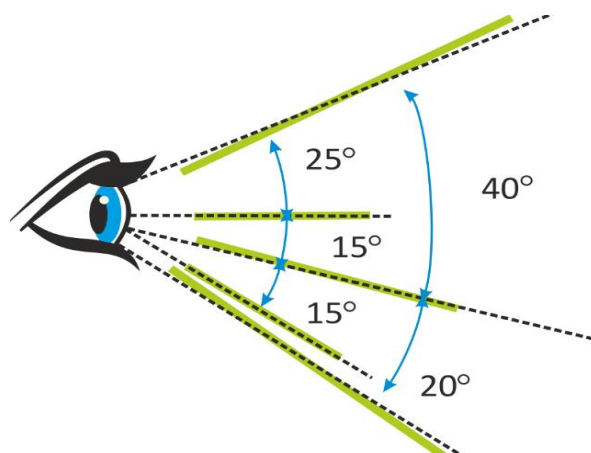

Figure 5 The natural angle of a person's gaze when standing. Source: Hendrickson & Ailawadi, 2014.

shelf (Borusiak 2009; Berčík 2013). If the shopper is close to the shelf, their field of vision may not include the highest place (though this also depends on the customer's height).

MATERIAL AND METHODOLOGY

Neuromarketing research on visual attention when people looked at Slovak and foreign wines on display was conducted under real conditions of a wine shop in Nitra, Slovakia. During the study, care was taken to ensure such conditions in which consumers usually buy wine. The participants independently made decisions with regard to choosing wine, thus a self-service environment was simulated. The visual attention measurement was executed using a biometric method (eye movement measurement with a Tobii mobile eye tracker, see Picture 1).

Ten respondents aged between 22 and 50 years took part in the test; 6 of them were Polish and 4 Slovak; with distribution according to gender being shown in Table 1. The neuromarketing research sample is already relevant with 6 participants (Nagel, 2014; Berčík, 2016; Rybanská, Nagyová and Košičiarová, 2016).

Special glasses – mobile eye tracker glasses by the company Tobii – were used to monitor eye movements.

This device uses eye tracking Pupil Centred Corneal Reflection, dark pupil technology, and in this case it was a monocular system focused on the right eye with a sampling rate of 30 Hz. We located IR Markers fixed to IR Marker Holders in the tested area (specific display shelves) in a way that the IR sensor built into the front part of the eye tracking glasses was able to differentiate signals transmitted from these miniature sensors to analyse the attraction of the merchandising display in detail at the point of purchase. The initial phase of the eye tracking tested in simulated, but also under real conditions, was an individual calibration of every participant with a system guide (9 point calibration).

Processing of the acquired primary data was conducted using software developed by the Tobii Studio, in which the following statistical indicators were generated to increase clarity.

Heat maps

Heat maps are two-dimensional graphic representations of data where the values of a variable are depicted in colours. The first step in heat map creation is the division of looks based on stimuli. This is executed via all fixations from all selected records one by one following completion



Picture 1 Research on visual attention when checking wines under real conditions.

Source: Individual processing by the author based on his research in 2015.

Table 1 Research sample.

	Absolute frequency	Relative frequency
Male	7	70%
Female	3	30%
Total	10	100.00%

Source: Individual processing by the authors.

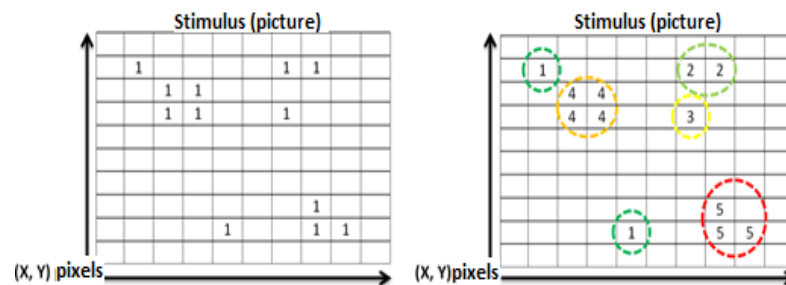

Figure 6 The creation of heat maps.

Source: Individual processing by the author based on the Tobii software manual.

of their values in the fixation which shares the same X and Y pixel location as the others. When we choose a number, we add the number of fixations in the same position. In the case of the absolute time of duration, the length of every fixation is added. Along with the relative time duration, first the length of every fixation is divided according to the display time of the presented media (video, picture), and after that it is added (Wilkinson 2008). According to the companies Tobii and Sensomotoric Instruments, heat maps are relevant statistical tools (Tobii Studio, 2013; SMI, 2016).

Immediately after all the fixation values are assigned, colour values are assigned to all places with the warmest colour representing the highest values.

Fixation points

Visualisation of the fixation points represents the successive position of views (circles) on a static or dynamic medium. The size of the circle indicates the length of the view and the number within it means the order and average duration of a view. This visualisation is suitable for use with a smaller number of participants over a short time interval (Tobii Studio, 2013).

Clusters

A series of polygons display those areas with the highest concentration of gaze points recorded during the test, showing the percentage of respondents who were interested in each cluster. The displayed clusters may easily be transformed into areas of interest (AOIs) (Bojko 2009).

RESULTS AND DISCUSSION

Data gained in modern neuromarketing research using biometric methods in the form of a heat map (see Fig. 6) has made it possible to identify key aspects of customers' visual attention when looking at a specialised display of Slovak and foreign wines in close proximity to the entrance of a specialist shop. The heat map showed that most of the respondents looked for the longest time and the most often at the wines which were displayed in the left-hand and central part of the display equipment. Attention was concentrated primarily on the brands and types of the individually displayed wines. As the price of the wines was displayed in only a few cases and was not clearly readable, the respondents paid only minimum of attention to it.

The heat map made it possible to ascertain the real preferences of customers and this indicated that those

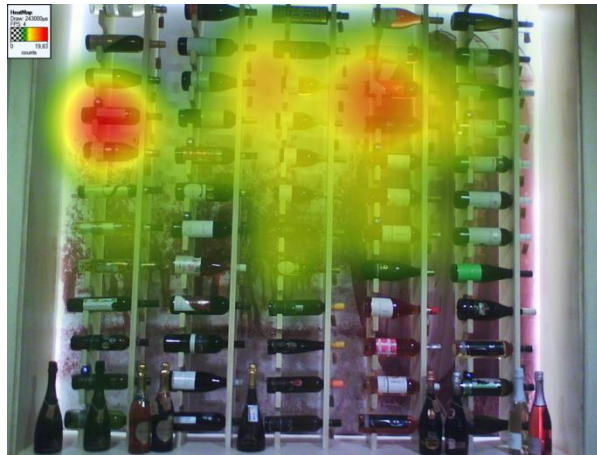

Picture 2 Heat map of visual attention when looking at the wine shelf.
Source: Individual processing by the author using Tobii software.

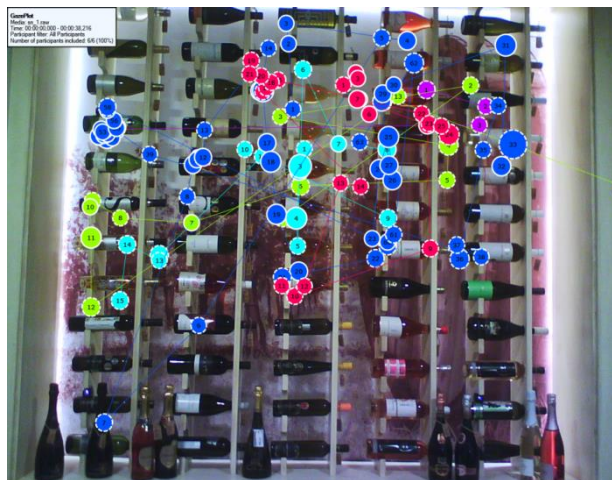

Picture 3 Fixation points of attention when looking at the wine shelf.
Source: Individual processing by the author using Tobii software.

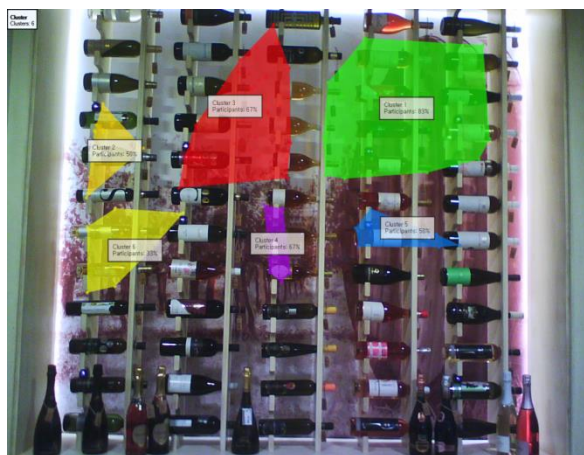

Picture 4 Clusters of visual attention when looking at the wine shelf.
Source: Individual processing by the author using Tobii software.

types of wine which were placed higher were considered to be more interesting.

The designed presentation area for types of wine with vineyard wallpaper really caught customers' attention. Picture 2 depicts a map of the fixation points on which the respondents concentrated for more than 0.5 second. The first look of customers which lasted longer than 0.5 second was devoted to the central part of the display. More fixation points could be found on the right side of the

display, where more expensive products were placed. Attention was equally focused on red, rosé and white wines.

Apart from the final heat map of the consumers' observations and the map of the fixation points, clusters of visual attention were also created, which indicate the individual zones of consumer interest when checking the types of wine (see Picture 4). The display was shown to 10 respondents for 10 seconds. The results show that the

respondents' attention was scattered around the image. The items that attracted the attention of 83% of the respondents are on the right side of shelf, where people usually looked first.

CONCLUSION

The research was focused on testing customers' visual attention in a specialised wine shop in Nitra, Slovakia. According to the biometric tests conducted, most of the respondents' attention was attracted by the higher places on the right side of the display. The biometric method made it possible to observe real consumers' visual preferences connected with merchandising. The effects of merchandising in such specialised shops can be even more intense. This study is devoted only to respondents' visual attention; further research ought to be conducted which would analyse customers' emotions. The authors recommend that specialist shops should place the more expensive products on higher shelves since these areas are the most visually attractive for customers, and should use ordinary backlighting for the displays (plus dramatic accent lighting for the wines), which improves the look of the products sold, attracts the customers' attention and promotes the desired behaviour among customers, thus resulting in increased sales and profit. The principal contribution of this study is to stimulate the interest of specialist shops in the use of neuromarketing for merchandising.

REFERENCES

- Barborová, P., Jančovičová, J., Zajác, P., Čapla, J., Vietoris, V. 2013. Perception of basic tastes and threshold sensitivity during testing of selected judges. *Potravinárstvo*, vol. 7, no. 1, p. 12-17. <https://doi.org/10.5219/259>
- Berčík, J. 2013. The modern forms of marketing research in selected agri-food businesses. In *Business management - practice and theory in the 21st century: international scientific conference : proceedings of scientific papers*. Nitra : Slovak University of Agriculture, p. 154-161. ISBN 978-80-552-1026-1.
- Berčík, J. 2016. Consumers Neuroscience as a Modern Consumer Research Tool: Ethical Aspects and Size of the Research Sample. In *Marketing Management, Trade, Financial and Social Aspects of Business – 4th International Scientific Conference*, Košice : University of Economics in Bratislava, p.6-11. ISBN 978-80-225-4293-7.
- Berčík, J. 2016. Consumer neuroscience brings new ways to get a customer to your side (Spotrebiteľská neuroveda prináša nové možnosti ako si získať zákazníka na svoju stranu). *AGROmagazín*, vol. 18, p. 20-22.
- Berčík, J., Horská E., Gálová J., Margianti E. S. 2016. Consumer neuroscience in practice: the impact of store atmosphere on consumer behavior. *Periodica Polytechnica Social and Management Sciences*, vol. 24, no. 2, p. 96-101. <https://doi.org/10.3311/PPso.8715>
- Berčík, J., Horská E., Paluchová J., Neomaniová K. 2015. Using of eye tracker in HORECA segment: visual proposal of chosen communication tool on restaurant guests decision. *European Journal of Business Science and Technology*, vol. 1, no. 2, p. 93-103. <https://doi.org/10.11118/ejbsat.v1i2.28>
- Bojko, A. 2009. Informative or Misleading? Heatmaps Deconstructed. In Jacko J. A. *Human – Computer Interaction. New Trends*. Berlin, Germany : Springer – Verlag, p. 30-39. https://doi.org/10.1007/978-3-642-02574-7_4
- Borusiak, B. 2009. *Merchandising*. Poznań : Wydawnictwo Uniwersytetu Ekonomicznego w Poznaniu. 105 p.
- Buttle F., 1984. Merchandising. *European Journal of Marketing*, vol. 18, no. 6/7, p. 104-123. <https://doi.org/10.1108/EUM000000004795>
- CANADEAN, 2015. Consumer and Market Insights: Wine Market in Slovakia. 2015. [online] s.a. [cit. 2016-05-12] Available at: <http://www.marketresearch.com/product/sample-9053527.pdf>.
- Hendrickson, K., Ailawadi K. L. 2014. Six Lessons for In-Store Marketing from Six Years of Mobile Eye-Tracking Research. *Shopper Marketing and the Role of In-Store Marketing Review of Marketing Research*, vol. 11, p. 57-74. <https://doi.org/10.1108/S1548-643520140000011002>
- Horská, E., Berčík, J., Krasnobeški, A., Matysek-Pejas R., Bakayová, H. 2016. Innovative approaches to examining consumer preferences when choosing wines. *Agricultural Economics*, vol. 62, no. 3, p. 124-133. <https://doi.org/10.17221/290/2015-AGRICECON>
- Kozelová, D., Fikselová, M., Dodoková S., Mura L., Mendelová, A., Vietoris, V. 2012. Analysis of consumer preferences focused on food additives. *Acta Universitatis Agriculturae et Silviculturae Mendelianae Brunensis*, vol. 60, no. 6, p. 197-204. <https://doi.org/10.11118/actaun201260060197>
- Kubicová, E., Kádeková, Z. 2011. Comparison of the income development and the food demand elasticities of the private households in Slovakia. *Agricultural Economics*, vol. 57, no. 8, p. 404-411.
- Maggs, D. J., Miller, P. E., Ofri, R. 2009. *Veterinary Ophthalmology Slatter* (Okulistyka weterynaryjna Slattera). 1st ed. Wrocław, Poland : Elsevier Urban & Partner. 532 p. ISBN: 978-83-7609-144-0.
- Marchini, A., Diotallevi, F., Paffarini, Ch., Stasi, A., Baselice, A. 2015. Visualization and purchase. *Qualitative Market Research: An International Journal*, vol. 18, no. 3, p. 346-361. <https://doi.org/10.1108/QMR-02-2015-0009>
- Mokry, S., Birčiaková, N., Slováčková, T., Stávková J., Nagyová, E. 2016. Perception of wine labels by generation z: eye-tracking experiment. *Potravinárstvo*, vol. 10, no. 1, p. 524-531. <https://doi.org/10.5219/647>
- Nagel, C. 2014. Sample Size in Neuromarketing. *Neuromarketing Theory & Practice*, no. 9, p. 6-9.
- Nagyová, E., Berčík, J., Horská, E. 2014. The efficiency, energy intensity and visual impact of the accent lighting in the retail grocery. *Potravinárstvo*, vol. 8, no. 1, p. 296-305. <https://doi.org/10.5219/398>
- Rekowski, M. 2013. *World wine markets* (Światowe rynki wina). Poznań : Wydawnictwo Akademia. 301 p. ISBN 83-922589-0-8.
- Riviezzo, A., De Nisco, A., Garofano, A. 2014. Understanding wine purchase and consumption behavior: a market. *International Journal of Sales and Marketing Management*, vol. 3, no. 1, p. 11-24.
- Rybanská, J., Nagyová, E., Košičiarová, I. 2016. The use of HRV analysis in the marketing research. In The agri-food value chain: challenges for natural resources management and society: International scientific days 2016. Nitra : Slovak Republic : Slovak University of Agriculture, p. 1050-1057. <https://doi.org/10.15414/isd2016.s13.06>
- SMI, 2016. *SensoMotoric Instruments (SMI), BeGaze Manual* Version 3.6, February 2016.

Tobii Studio, 2012. *Tobii Studio Manual* Version 3.2 Rev A 11/2012 – User Manual.

Vietoris, V., Barborova, P., Jancovicova, J., Eliasov, L., Karvaj, M. 2016. Flavour and identification threshold detection overview of Slovak adepts for certified testing. *Neuroendocrinology Letters*, vol. 37, no. 3, p. 226-232. [PMid:27618598](#)

Wilson, M., Gaines, J., Hill, R. P. 2008. Neuromarketing and Consumer Free Will. *Journal of Consumer Affairs*, vol. 42, no. 3, p. 389-410. <https://doi.org/10.1111/j.1745-6606.2008.00114.x>

www.dlahandlu.pl, Dyskonty liderem sprzedaży win gronowych [online] s.a. [cit. 2016-05-13] Available at: <http://www.dlahandlu.pl/handel-wielkopowierzchniowy/wiadomosci/dyskonty-liderem-sprzedazy-win-gronowych,50704.html>.

Acknowledgments:

The paper is part of the research project VEGA 1/0874/14 "The use of neuromarketing in visual food merchandising" and KEGA 038SPU-4/2016 "Using of new technologies and

interdisciplinary associations in consumer studies " conducted at the Department of Marketing and Trade at the Faculty of Economics and Management of the Slovak University of Agriculture in Nitra.

Contact address:

Bartłomiej Pierański, Poznań University of Economics and Business, Faculty of Management, Department of Commerce and Marketing, Al. Niepodległości 10, 61-875 Poznań, Poland, E-mail: bartlomiej.pieranski@ue.poznan.pl

Barbara Borusiak, Poznań University of Economics and Business, Faculty of Management, Department of Commerce and Marketing, Al. Niepodległości 10, 61-875 Poznań, Poland, E-mail: b.borusiak@ue.poznan.pl

Elena Horská, Slovak University of Agriculture, Faculty of Economics and Management, Department of Marketing and trade, Tr. A. Hlinku 2, 949 76 Nitra, Slovakia, E-mail: Elena.Horska@gmail.com

EFFECT OF SELECTED POLYMORPHISMS OF GENES LEP, MTHFR AND FTO
TO BMI LEVEL AND GENDER-SPECIFICITY

*Kristína Candráková, Anna Trakovická, Michal Gábor, Martina Miluchová,
Radovan Kasarda, Nina Moravčíková*

ABSTRACT

The aim of this study is to investigate the effect of selected polymorphisms LEP (G2548A), MTHFR (C677T) and FTO (*rs1121980*) on body mass index in humans. In the study participated 79 people from Slovakia with some genetic relatedness. Genomic DNA was isolated from the buccal swabs using a commercial kit Qiagen DNA Mini Kit (Qiagen). The detection of SNP polymorphisms in human genes LEP, MTHFR and FTO was performed using molecular genetics methods such as PCR-RFLP and ARMS. The most common genotypes in all 3 polymorphism were found in heterozygous form (for LEP AG = 0.5190, for MTHFR CT = 0.519, for FTO CT = 0.4051). The LEP gene had increased frequency of G allele (0.5506), the MTHFR gene T allele (0.6646) and FTO gene T allele (0.50635). The least frequent genotype in LEP was AA (0.1899), in MTHFR was TT (0.0759), in FTO it was CC (0.2911). According to the results we can assume that the genotypes AA (LEP G2548A), CC (FTO *rs1121980*) and TT (MTHFR C677T) in case of women have a protective effect on the prevalence of obesity, based on BMI, compared to the other genotypes and this polymorphism is gender-specific. Added anthropometric measurements, blood test and extension of the group in the future evaluation could increase the statistical relevance in relation to obesity and gender-specificity.

Keywords: FTO *rs1121980*; LEP G2548A; MTHFR C677T; BMI; gender-specificity

INTRODUCTION

The prevalence of the obesity enormously increases every year as in adult population, same in the children one. As chronic disease, in obesity should be taken into account many of aspects they could influence its incidence, also with non-nutritive origin. Genetic effect should be considered as one from the main factors in relation to obesity and the genetic predisposition as possible influence by a large extent.

Parenthood obesity has shown as big predictor to prevalence of the obesity to their children, as they have 25.2 times greater chance of developing obesity in comparing the children whose parents do not suffer of any forms of obesity. When mother is obese, in 23% of boys and only 16% of girls have the obesity presented but conversely by paternal obesity, the boy has 6.5 times and the girl 40.1 times higher risk of obesity in comparing to the control group. Therefore we can say that children obesity is highly influenced by genetic factors. Obesity parent was most pronounced in boys and paternal obesity, especially among girls. It could be possible that an improvement of environmental factors affecting the parents, could reduce the risk of obesity in their children (Kumar et al., 2010).

The objective of this study was to find a relationship between selected gene polymorphisms and body mass index level considered as one from the obesity linkage. All 3 candidates genes were characterized as possible indicators to higher level of BMI. Numbers of genetic studies have indicated FTO as an important gene for obesity risk in different populations, leading to further development of metabolic disease and diabetes (Mittal, Srivastava A., Srivastava N., 2013).

In research of LEP polymorphism G2548A (Constantin et al., 2010) were found that the G allele carriers had significantly higher leptin and increased risk for developing obesity ($p = 0.013$) were pointed in genotype GG (taking into account the age, sex and BMI). Similar results demonstrated also Ali et al. (2009), when they showed that women with obesity in Tunisian population, which were carriers of the A allele had a significantly lower leptin levels.

Scientific hypothesis

The aim of this study is to investigate the effect of selected polymorphisms LEP (G2548A), MTHFR (C677T) and FTO (*rs1121980*) on body mass index in humans.

MATERIAL AND METHODOLOGY

The target group consisted of people with different age structures and with certain genetic similarity, which created relatedness between individuals. Because of the formation of a general examination of overweight and obesity in humans, there were 79 people evaluated, belonged to 14 families.

Genomic DNA was isolated from the buccal swabs using a commercial kit Qiagen DNA Mini Kit (Qiagen). SNP analysis of genes LEP polymorphism (G2548A) and MTHFR polymorphism (C677T) was performed using molecular genetic PCR-RFLP method (restriction fragment length polymorphism). PCR amplification products observed polymorphism G2548A and C677T and subsequent restriction analysis was carried out following the methodology **Mammès et al. (2000)** and **Deeparani et al. (2009)**.

The single nucleotide polymorphism *rs1121980* in FTO gene was performed by amplification-refractory mutation system (ARMS) analysis of point mutation, following the methodology **Shabana and Hasnain (2015)**.

Followed identification of specific fragment describing the presence of different alleles of the selected SNP polymorphisms was performed by agarose gel electrophoresis.

Age, height, weight were assessed in the target group and then the body mass index (BMI) was calculated according to the following formula:

$$BMI = \text{weight (kg)} / \text{body height}^2 \text{ (m)}$$

Basic statistical analysis of gene polymorphism was performed by the following relationships:

1. Alleles frequencies for double allelic system according to the Hardy-Weinberg law

$$p_A = (2 \cdot AA + AB) : 2N \quad q_B = (2 \cdot BB + AB) : 2N$$

p_A , q_B - the frequency of each allele, N - total number of individuals

2. Genotypes frequencies according to the Hardy-Weinberg law

$$(p_A + q_B)^2 = p_A^2 + 2 p_A q_B + q_B^2 = 1$$

3. Genotypic balance was verified by χ^2 - test

$$\chi_{(n-1)}^2 = \sum \frac{(e-t)^2}{t}$$

n - total number of phenotypic classes, e - observed number of genotypes, t - theoretical number of genotypes

4. The polymorphic information content (PIC) of Botstein et al., (1980)

$$P = 1 - \sum (p^2 + q^2) - \left(\sum_{i=1}^{n-1} \sum_{j=i+1}^n 2p_i^2 p_j^2 \right)$$

5. Heterozygosity (H_e) by Nei, (1978)

$$H_e = 1 - \sum (p^2 - q^2)$$

The relationship of body mass index (BMI) and the polymorphism studied genes was analyzed on the basis of a linear model:

$$BMI_{ijk} = \mu + POHL_i + LEP_j + b(\text{age})_{ijk} + e_{ijk}$$

BMI - body mass index, μ - mean value, $POHL_i$ - fixed effect of sex, LEP_j - fixed effect of genotype (gene LEP), $b(\text{age})_{ijk}$ - effect of age in the form of linear regression, e_{ijk} - residual effect

For the numerical expression of the alleles and genotypes, we used the following substitution: gene LEP (allele A = 0, G allele = 1, genotype AA = 0, genotype AG = 1, the genotype GG = 2), gene MTHFR (allele T = 0, allele C = 1, the genotype TT = 0, 1 = CT genotype, genotype CC = 2), gene FTO (allele C = 0, T allele = 1, genotype CC = 0, genotype CT = 1, TT = 2). Numerical expression of the genes was used because of the expression of genetic predisposition obesity to individuals and families by individual analyzed genes studied separately and also together, based on expected positive or negative effect from the previous studies.

Statistic analysis

Laboratory processing of samples and the DNA analyzes were carried out at the Department of Genetics and Animal Breeding Biology, Slovak University of Agriculture in Nitra. Statistical analysis was performed in the program SAS Enterprise Guide 5.1 and the program SAS 9.2.

RESULTS AND DISCUSSION

Analysis of frequency and basic statistical characteristics

The group consisted of 79 people of people of different age structures, usually with a known family relatedness, including 48 women and 31 men. Tables 1 and 2 show the basic statistical characteristics of the analyzed indicators of the group.

The average age of people was 40.08 years and the mean of BMI was 26.04 kg.m⁻² (79 reviews people). For persons who have reached the minimum age of 20 years the average age of 44.17 years was found and the mean of BMI was 26.97 kg.m⁻² (70 reviews people).

The age structure of the group was very diverse. In the case of man it was from 2 to 79 years and in women from 2 to 74 years. The diverse age structure is justified from the standpoint of families and needed (existence of a joint analysis of one or two generations of ancestors).

According to our results, the age is not a limiting factor in the analysis of the relationship of BMI of the individual genes and polymorphisms. When comparing the body mass index of men (27.09) and women (25.37) of all subjects and average values of subjects who had at least 20 years (male 28.10 and female 26.30) there was a difference of about only 1 point.

In any case, since individual human body measurements are significantly affected by age, also the effect of age was taken into account in the analysis.

The classification of individuals analyzed according to the international classification of underweight, normal weight, overweight and obesity are presented in Table 3.

Table 1 The basic statistical characteristics.

Gender	Indicator	Mean	s _x	min.	max.	n
Men	Weight (kg)	80.85	23.21	14.00	128.00	31
	Height (m)	1.71	0.20	0.88	1.91	31
	BMI (kg.m ⁻²)	27.09	5.35	18.08	39.51	31
	Age (year)	42.29	20.82	2.00	79.00	31
Women	Weight (kg)	69.23	18.29	12.00	113.00	48
	Height (m)	1.64	0.1418.42	0.98	1.80	48
	BMI (kg.m ⁻²)	25.37	5.99	11.15	43.06	48
	Age (year)	38.65	18.42	2.0	74.00	48

Table 2 The basic statistical characteristics (minimal age – 20).

Gender	Indicator	Mean	s _x	min.	max.	n
Men	Weight (kg)	87.80	15.49	64.00	128.00	26
	Height (m)	1.77	0.07	1.55	1.91	26
	BMI (kg.m ⁻²)	28.10	4.87	21.14	39.51	26
	Age (year)	48.65	16.00	20.00	79.00	26
Women	Weight (kg)	73.00	12.96	51.00	113.00	44
	Height (m)	1.67	0.06	1.54	1.80	44
	BMI (kg.m ⁻²)	26.30	5.25	17.86	43.06	44
	Age (year)	41.52	16.37	20.00	74.00	44

Table 3 Classification of overweight and obesity.

BMI (kg.m ⁻²)	Men	%	Women	%	Count	%
< 25	12	38.7	23	47.9	35	44.3
25-30 (<i>overweight</i>)	10	32.3	15	31.3	25	31.6
30 ≥ (<i>obesity</i>)	9	29.0	10	20.8	19	24.1

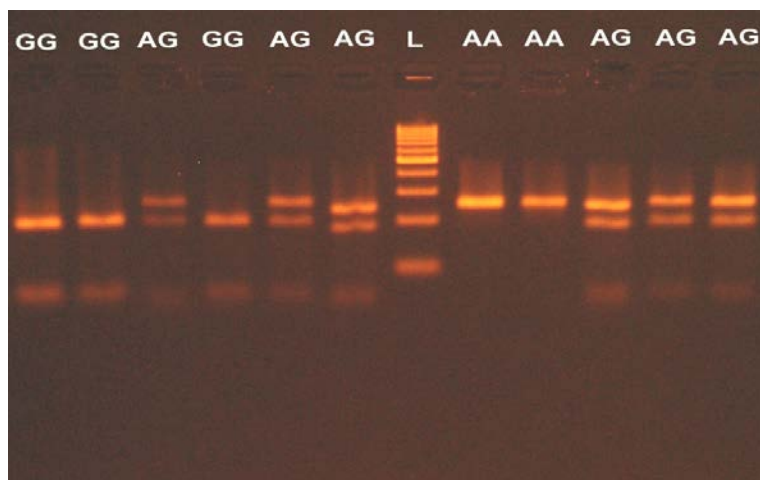
**Figure 1** Molecular genetic analysis of the PCR-RFLP for the detection of single nucleotide polymorphism G2548A localized in the gene LEP encoding the leptin.

Note: AA - homozygous genotype (242 bp), AG – heterozygous genotype (242 bp +181 bp +61 bp), GG – homozygous genotype (181 bp +61 bp), L – 100 bp DNA ladder (Thermo Scientific).

Based on the classification of overweight and obesity we can conclude that, overall, 55.7% of people (61.3% men and 52.1% women) we analyzed, suffer from overweight and obesity.

Molecular-genetic analysis of genes LEP (G2548A), MTHFR (C677T), FTO (rs1121980)

Based on the genotyping group of people (79 people) were analyzed gene LEP (G2548A), MTHFR (C677T) and selected polymorphism rs1121980 in FTO gene, in relation to obesity in humans based on BMI values with respect to gender and age.

Statistical analysis of polymorphism of gene LEP (G2548A), MTHFR (C677T), FTO rs1121980

Basic statistical analysis of polymorphisms of individual genes analyzed are presented in Table 4 and shown in Figure 4.

For all polymorphisms was the most frequent heterozygous genotype, for LEP and MTHFR in 51.90% and in FTO in 40.51%.

Testing frequencies of genotypes according to the Hardy-Weinberg law χ^2 test confirmed the maintenance of equilibrium in the evaluated group of people.

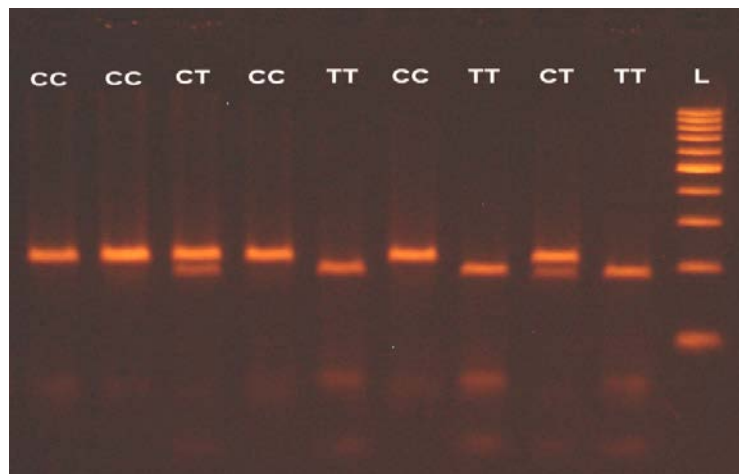

Figure 2 Molecular genetic analysis of the PCR-RFLP for the detection of single nucleotide polymorphism C677T localized in the gene MTHFR.

Note: CC - homozygous genotype (198 bp), CT - heterozygous genotype (198 bp + 175 bp + 23 bp), TT - homozygous genotype (175 bp + 23 bp), L - 100 bp DNA ladder (Thermo Scientific).

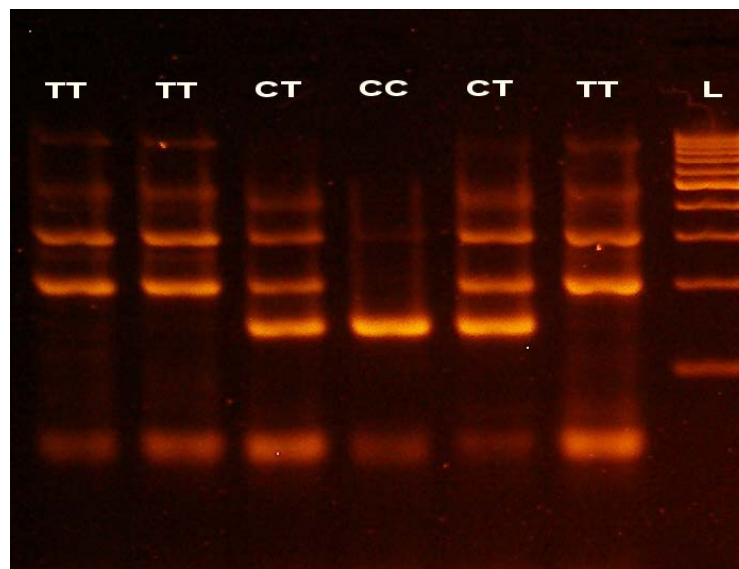

Figure 3 Molecular genetic analysis of the ARMS for the detection of FTO rs1121980.

Note: CC - homozygous genotype (148 bp), CT - heterozygous genotype (208 bp + 148 bp + 60 bp), TT - homozygous genotype (208 bp), L - 100 bp DNA ladder (Fermentas), control fragment defined at 311 bp.

Analysis of the relationship of body mass index (BMI) and polymorphisms of genes

Analysis of the relation of body mass index, and the gene polymorphism of the LEP, MTHFR and FTO was made from a linear model [1] referred in the methodology of the research and its comparison is in Figure 5.

The average BMI in relation to age highlighted differences in BMI in different genotypes in the polymorphism G2548A of the LEP gene (AA = 26.88 kg.m⁻², AG = 27.00 kg.m⁻², GG = 27.87 kg.m⁻²) as opposed to values if we do not take account of the age of participants (AA = 25.50 kg.m⁻², AG = 25.35 kg.m⁻², GG = 26.94 kg.m⁻²). We can see increasing tendency from AA to AG genotype if we consider the age.

In MTHFR C677T have been the average BMI lower (CC = 26.18 kg.m⁻², CT = 25.73 kg.m⁻², TT = 24.87 kg.m⁻²) in comparing those with consideration of the age (CC = 27.53 kg.m⁻², CT = 27.05 kg.m⁻²,

TT = 25.89 kg.m⁻²) and the tendency of allele effect is shown the best from all 3 genes.

The average BMI values in FTO rs1121980 (CC = 25.39 kg.m⁻², CT = 24.84 kg.m⁻², TT = 27.62 kg.m⁻²) to those where the age were took to account (CC = 26.88 kg.m⁻², 26.85 kg.m⁻², 27.91 kg.m⁻²). The most abundant difference is in heterozygous genotype, more than 2 kg.m⁻².

The correlation between selected genes and influence to BMI level were not statistically very significant when each from genes were compared separately, however they have together cumulative effect (0.1967) and it is more significant ($p = 0.0823$). FTO rs1121980 has shown the biggest influence to BMI in comparing the other 2 polymorphisms. With gender consideration comes to decreasing of statistical relevance cause of the decreasing number in each group (M = 31, W = 68).

In gene MTHFR (C677T) has shown variability between genders. Homozygous genotype CC is considered as

Table 4 Frequency of genotypes and alleles of the genes LEP, MTHFR and FTO

Gene	Genotype	Count	Frequencies		PIC	Het.	χ^2 - test
			Genotype	Allele			
LEP G2548A	AA	15	0.1899	A	0.3724	0.519	0.1876
	AG	41	0.519	G			
	GG	23	0.2911	± 0.0386			
MTHFR C677T	CC	32	0.4051	C	0.3465	0.519	2.1264
	CT	41	0.519	T			
	TT	6	0.0759	± 0.0343			
FTO rs1121980	CC	23	0.2911	C	0.375	0.4051	2.8442
	CT	32	0.4051	T			
	TT	24	0.3038	± 0.0434			

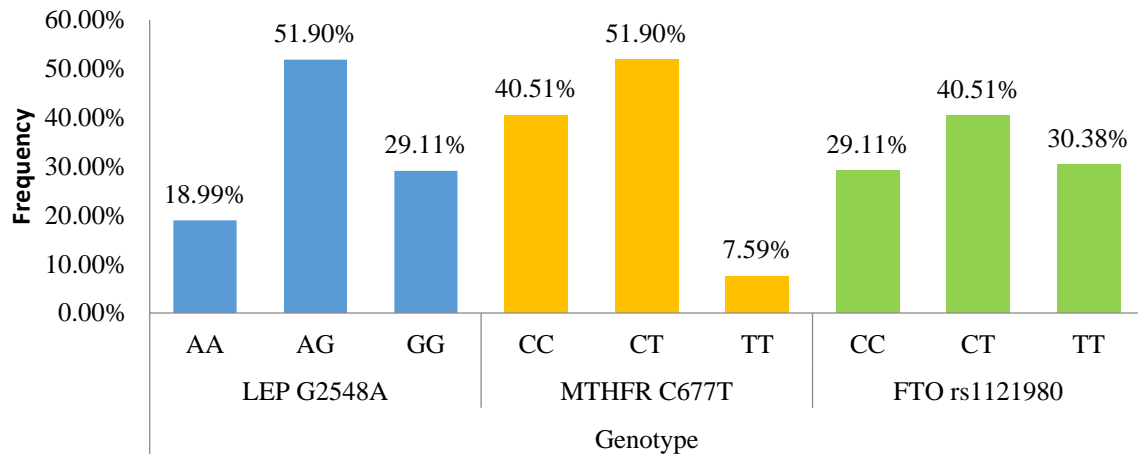
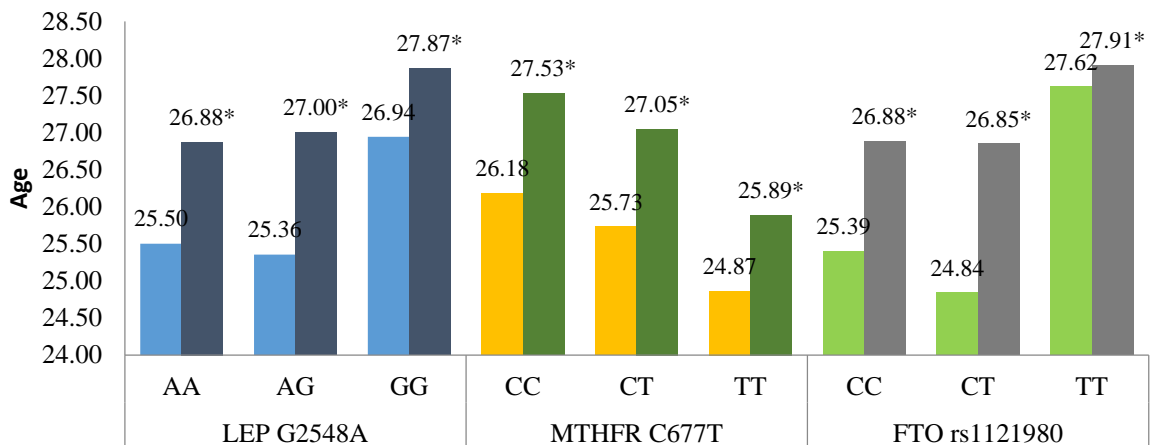
**Figure 4** Comparison of frequency LEP G2548, MTHFR C677T and FTO rs1121980 genotypes.

*age took into account

Figure 5 The average of BMI level for LEP G2548A, MTHFR C677T, FTO rs1121980 without and with consideration of age.

protective factor (-0.1100), TT (0.1100), in opposite to women, where is protective genotype TT (-0.1819), CC (0.1819) and the cumulative effect together with LEP and FTO is bigger and more significant ($W = 0.2639$, $p = 0.07$, $M = 0.1163$, $p = 0.53$). With age consideration the protection of TT genotype MTHFR in women is much more relevant (-0.2952) and more significant ($p < 0.05$). In other cases the significant changes were not observed.

With the cumulative effect of the selected genes polymorphisms, using the numerical substitution described in the methodology we can see in Figure 6 the increased

BMI level (28.41 $\text{kg}\cdot\text{m}^{-2}$) in case of the worse genotype scenario – 6 risk alleles (LEP – genotype GG, MTHFR – genotype CC, FTO – genotype TT) in comparison with the occurrence just two risk allele (23.49 $\text{kg}\cdot\text{m}^{-2}$).

In a study conducted on a population of people in the US, an average BMI of 27.8 $\text{kg}\cdot\text{m}^{-2}$ was reported (Morland and Evenson, 2008). Dukát (2007) states that in Slovakia, the mean BMI is 26.94 $\text{kg}\cdot\text{m}^{-2}$. In comparison with these values the first set of users has only a slightly lower mean BMI. Similar results were recorded in the first group of people by gender. When considering the

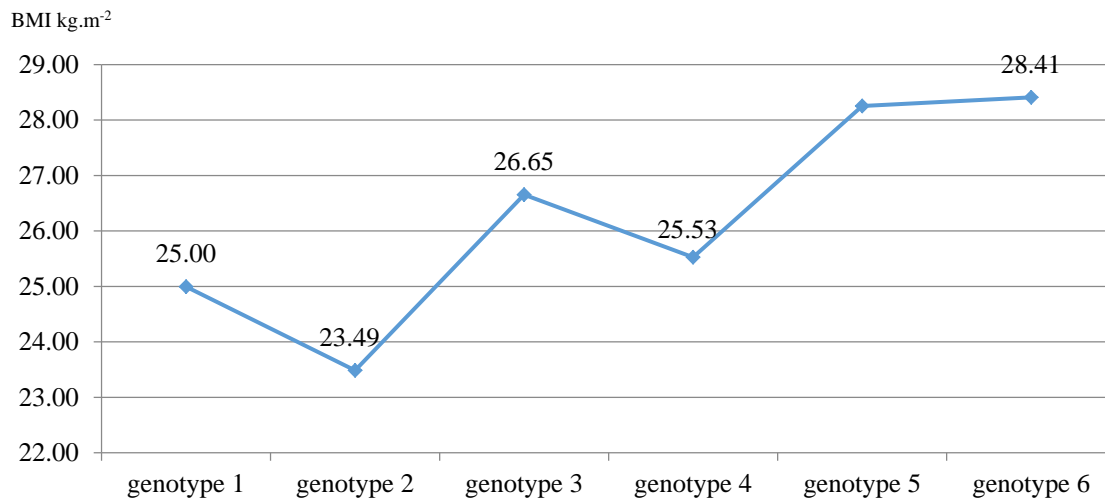

Figure 6 Showing the impact of combinations of alleles of genes and LEP G2548A, MTHFR C677T, FTO rs1121980 on BMI.

minimum age of 20 years, we find the mean of BMI 26.97 kg.m⁻² is virtually identical to the average for Slovakia.

In this study, effect of 3 selected polymorphisms was examined to BMI level in 79 individuals. Our results confirm the findings of **Li et al. (2009)** that the largest effect shown for the FTO locus. Common polymorphism variants have small effects on obesity measures and they have cumulative effects but their predictive value for obesity risk is kindly limited.

Vimalaswaran et al. (2009) have confirmed the effect of polymorphism FTO *rs1121980* to BMI and also to the waist circumference. They found a highly significant association of BMI with allele T and increasing the BMI level in an average 0.40 – 0.66 points per risk allele. They considered bigger effect of the FTO gene variant in less physical active people. The FTO gene has been investigated in the search for gene variants that are mainly related to obesity risk and BMI. Several single nucleotide polymorphisms have been described and one of these is also rs1121980 (**Saldaña-Alvarez et al., 2016**). Also their results support the hypothesis that sex plays an important role in the relationship between FTO SNPs and the obesity development.

Lieskovská (2011) has confirmed negative effect of GG genotype in LEP G2548A gene to BMI level (+2.0499), frequency of A allele (0.46) and G allele (0.54) were similar to our findings (A allele = 0.45, G allele = 0.55). The previous study of **Trakovická et al. (2016)** confirmed the key role of this leptin gene in control of nutritional organism status and indicates the LEP G2548A polymorphism as genetic markers for the level of BMI and obesity related disorders and affirm its significance in genetic evaluation in relation to the lipids metabolism disorders prediction.

Kucukhuseyin et al. (2013) came to finding that owner of the T allele in the MTHFR gene has a protective association for BMI level. This result we found just in group of women (-0.2952, $p < 0.05$), in men group we found the opposite and the T allele has negative effect to BMI (0.2557, $p = 0.1650$). According to **Zhi et al. (2016)** in MTHFR C677T are observed gender-specific

interactions in Chinese Han population what we can confirm also for the European population even with smaller examined group.

CONCLUSION

The results achieved in analysis of the relation for body mass index and polymorphisms studied gene allow us to confirm the hypothesis that the polymorphism of LEP, MTHFR and FTO gene is related to obesity expressed human body mass index (BMI).

In the MTHFR gene (C677T) we observed the gender differences and the protective effect of raviTT genotype in women and CC genotype in men, however cause of low number of frequency TT genotype in the population other observations are needed.

For a more comprehensive evaluation of polymorphisms studied genes and their impact on obesity, we suggest future conduct additional anthropometric measurements, blood tests in connection with the nutritional history and in particular the extension samples of observed people.

REFERENCES

- Ali, S. B., Kallel, A., Ftouhi, B., Sediri, Y., Feki, M., Slimane, H., Jemaa, R., Kaabachi, N. 2009. Association of G-2548A LEP polymorphism with plasma leptin levels in Tunisian obese patients. *Clinical Biochemistry*, vol. 42, no. 7-8, p. 584-588. <https://doi.org/10.1016/j.clinbiochem.2008.11.001> PMID:19041299
- Botstein, D., White, R. L., Skolnick, M., Davis, R. W. 1980. Construction of a genetic linkage map in man using restriction fragment length polymorphisms. *American Journal of Human Genetics*, vol. 32, no. 3, p. 314-331. PMID:6247908
- Castro, R., Rivera, I., Ravasco, P., Camilo, M. E., Jakobs, C., Blom, H. J., De Almeida I. T. 2004. 5,10-methylenetetrahydrofolate reductase (MTHFR) 677C/T and 1298A/C mutations are associated with DNA hypomethylation. *Journal of Medical Genetics*, vol. 41, no. 6, p. 454-458. <https://doi.org/10.1136/jmg.2003.017244> PMID:15173232
- Constantin, A., Costache, G., Sima, A. V., Glavce, C. S., Vladica, M., Popov, D. L. 2010. Leptin G-2548A and leptin receptor Q223R gene polymorphisms are not associated with

- obesity in Romanian subjects. *Biochemical and Biophysical Research Communication*, vol. 391, no. 1, p. 282-286. <https://doi.org/10.1016/j.bbrc.2009.11.050>
PMid:19913498
- Deeparani, T., Radhakrishna, P. M., Elavazhagan, T. 2009. Detection of MTHFR C677T and A1298C gene polymorphism in congenital heart disease. *Middle-East Journal of Scientific Research*, vol. 4, no. 2, p. 127-132.
- Dukát, A., Lietava, J., Krahulec, B., Čaprnda, M., Vacula, I., Sirotiaková, J., Kosmálová, V., Minárik, P. 2007. Prevalence of Abdominal Obesity in Slovakia, IDEA Slovakia Study (Prevalencia abdominálnej obezity na Slovensku, Štúdia IDEA Slovakia). *Vnitřní Lékařství*, vol. 53, no. 4, p. 326-330. [PMid:17578161](https://doi.org/10.1002/jcla.21623)
- Hasnain, S., Hasnain, S. 2015. Effect of the Common Fat Mass and Obesity Associated Gene Variants on Obesity in Pakistani Population: A Case-Control Study. *BioMed Research International*, vol. 2015, p. 1-8.
- Kucukhuseyin, O., Kurnaz, O., Akadam-Teker, A. B., Isbir, T., Bugra, Z., Ozturk, O., Yilmaz-Aydogan, H. 2013. The association of MTHFR C677T gene variants and lipid profiles or body mass index in patients with diabetic and nondiabetic coronary heart disease. *Journal of Clinical Laboratory Analysis*, vol. 27, no. 6, p. 427-434. <https://doi.org/10.1002/jcla.21623>
PMid:24218123
- Kumar, S., Raju, M., Gowda, N. 2010. Influence of Parental Obesity on School Children. *Indian Journal of Pediatrics*, vol. 77, no. 3, p. 255-258. <https://doi.org/10.1007/s12098-010-0015-3>
PMid:20140775
- Lewis, S. J., Lawlor, D. A., Nordestgaard, B. G., Tybjaerg-Hansen A., Ebrahim, S., Zacho, J., Ness, A., Leary, S., Smith, G. D. 2008. The methylenetetrahydrofolate reductase C677T genotype and the risk of obesity in three large population-based cohorts. *European Journal of Endocrinology*, vol. 159, no. 1, p. 35-40. <https://doi.org/10.1530/EJE-08-0056>
PMid:18426813
- Li, S., Zhao, J. H., Luan, J., Luben, R. N., Rodwell, S. A., Khaw, K. T., Ong, K. K., Wareham, N. J., Loos, R. J. F. 2010. Cumulative effects and predictive value of common obesity-susceptibility variants identified by genome-wide association studies. *The American Journal of Clinical Nutrition*, vol. 91, no. 1, p. 184-190. <https://doi.org/10.3945/ajcn.2009.28403>
PMid:19812171
- Lieskovská, Z. 2011. *Genetic markers of lipid metabolism disorders and human nutrition (Genetické markery porúch metabolizmu lipidov a výživy ľudí)*: dissertation theses. Nitra, Slovakia : Slovak University of Agriculture.
- Mammès, O., Betoulle, D., Aubert, R., Herbeth, B., Siest, G., Fumeron, F. 2000. Association of the G-2548A polymorphism in the 5' region of the LEP gene with overweight. *Annals of Human Genetics*, vol. 64, no. Pt. 5, p. 391-394.
- Mittal, B., Srivastava, A., Srivastava, N. 2013. Is fat mass & obesity-associated (FTO) gene master regulator of obesity? *Indian Journal of Medical Research*, vol. 143, no. 3, p. 264-266. <https://doi.org/10.4103/0971-5916.182614>
PMid:27241637
- Morland, K. B., Evenson, K. R. 2008. Obesity prevalence and the local food environment. *Health Place*, vol. 15, no. 2, p. 491-495. <https://doi.org/10.1016/j.healthplace.2008.09.004>
PMid:19022700
- Nei, M. 1978. Estimation of average heterozygosity and genetic distance from a small number of individuals. *Genetics*, vol. 89, no. 3, p. 583-590. [PMid:17248844](https://doi.org/10.1016/j.bbrc.2009.11.050)
- Saldaña-Alvarez, Y., Salas-Martínez, M. G., García-Ortiz, H., Luckie-Duque, A., García-Cárdenas, G., Vicenteño-Ayala, H, et al. 2016. Gender-Dependent Association of FTO Polymorphisms with Body Mass Index in Mexicans. *PLoS ONE*, vol. 11, no. 1, p. e0145984. <https://doi.org/10.1371/journal.pone.0145984>
PMid:26726774
- Trakovická, A., Moravčíková, N., Candráková K., Kasarda, R. 2016. Associations between LEP G2548A polymorphisms and lipids metabolism. *Acta fytotechn zootech*, vol. 19, special no., p. 75-79.
- Vimaleswaran, K. S., Li, S., Zhao, J. H., Luan, J., Bingham, S. A., Khaw, K. T., Ekelund, U., Wareham, N. J., Loos, R. J. F. 2009. Physical activity attenuates the body mass index-increasing influence of genetic variation in the FTO gene. *The American Journal of Clinical Nutrition*, vol. 90, no. 2, p. 425-428. <https://doi.org/10.3945/ajcn.2009.27652>
PMid:19553294
- Zhi, X., Yang, B., Fan, S., Wang, Y., Wei, J., Zheng, Q., Sun, G. 2016. Gender-specific interactions of MTHFR C677T and MTRR A66G polymorphisms with overweight/obesity on serum lipid levels in a Chinese Han population. *Lipids in Health and Disease*, vol. 15, no. 1, p. 185. <https://doi.org/10.1186/s12944-016-0354-9>
PMid:27793164

Acknowledgments:

This work was supported by the research project: APVV-0636-11 and VEGA 1/0742/17.

Contact address:

Kristína Candráková, Slovak University of Agriculture, Faculty of Agrobiolgy and Food Resources, Department of Genetics and Animal Breeding Biology, Tr. A. Hlinku 2, 949 76 Nitra, Slovakia, E-mail: name@domainname.sk

Anna Trakovická, Slovak University of Agriculture, Faculty of Agrobiolgy and Food Resources, Department of Genetics and Animal Breeding Biology, Tr. A. Hlinku 2, 949 76 Nitra, Slovakia, E-mail: anna.trakovicka@uniag.sk

Michal Gábor, Slovak University of Agriculture, Faculty of Agrobiolgy and Food Resources, Department of Genetics and Animal Breeding Biology, Tr. A. Hlinku 2, 949 76 Nitra, Slovakia, E-mail: michal.gabor@uniag.sk

Martina Miluchová, Slovak University of Agriculture, Faculty of Agrobiolgy and Food Resources, Department of Genetics and Animal Breeding Biology, Tr. A. Hlinku 2, 949 76 Nitra, Slovakia, E-mail: martina.miluchova@uniag.sk

Radovan Kasarda, Slovak University of Agriculture, Faculty of Agrobiolgy and Food Resources, Department of Genetics and Animal Breeding Biology, Tr. A. Hlinku 2, 949 76 Nitra, Slovakia, E-mail: radovan.kasarda@uniag.sk

Nina Moravčíková, Slovak University of Agriculture, Faculty of Agrobiolgy and Food Resources, Department of Genetics and Animal Breeding Biology, Tr. A. Hlinku 2, 949 76 Nitra, Slovakia, E-mail: nina.moravcikova1@gmail.com

MORPHOLOGICAL CHARACTERISTICS FOR FRUITS OF *ARONIA* *MITSCHURINII* A.K. SKVORTSOV & MAITUL.

Yulia Vinogradova Maitulina, Olga Grygorieva, Olena Vergun, Ján Brindza

ABSTRACT

The aim of this study was to determine morphometric characteristics of fruits within some phenotypes of *Aronia mitschurinii* A.K. Skvortsov & Maitul. Their morphometric parameters were following: weight from 0.75 g (AM-03) to 1.52 g (AM-04), length from 9.46 mm (AM-03) to 12.73 mm (AM-04), diameter from 10.49 mm (AM-03) to 13.73 mm (AM-04), fruits number in the corymb from 11.33 (AM-07) to 20.13 (AM-03), cumulative weight of fruits in the corymb from 10.42 g (AM-07) to 21.73 g (AM-04), volume of fruits from 0.55 (AM-03) to 1.26 (AM-04) cm³. The shape index of the fruits was found in the range of 0.87 (AR-01, AR-05, AR-07) to 0.93 (AM-02). The analysis of coefficient of variation showed the difference of variability in morphological characteristics between *Aronia mitschurinii* samples. Data showed that the most variability of important selection characteristics are the average cumulative mass of fruits in a corymb – from 12.34 (AM-03) to 38.61 (AM-02) % and fruit number of fruits in the corymb – from 14.56 (AM-03) to 36.88 (AM-02) %. The other characteristics are more or less stable. The introduction population of the *Aronia mitschurinii*, was created in the M.M. Gryshko National Botanical Garden in Kyiv, has a sufficient potential for successful selection work.

Keywords: *Aronia mitschurinii*; fruits; morphometric characteristics

INTRODUCTION

Nowadays, the conversance is given more and more to underutilized and unusual fruits plants as *Cornus mas* L. (Brindza et al., 2007), *Sorbus domestica* L. (Žiarovská and Poláčková, 2012), *Cydonia oblonga* Mill., *Pseudocydonia sinensis* Schneid. (Monka et al., 2014; Bystrická et al., 2017), *Ziziphus jujuba* Mill., *Castanea sativa* Mill. (Grygorieva et al., 2014; 2017), *Morus nigra* L. (Kucelova et al., 2016).

Aronia mitschurinii A. K. Skvortsov & Maitul. also has a great resource potential. This species is still sometimes not considered self consistent taxon, but is included in the *Aronia melanocarpa* (Michx.) Elliott, which was the wild ancestor of this species (Skvortsov and Maitulina, 1982; Skvortsov et al., 2005; Vinogradova and Kuklina, 2014).

Meanwhile, North American *Aronia melanocarpa* is considered a low-quality ornamental shrub and thus is seldom cultivated, sometimes even exterminated as a weed by chemical applications. At the same time, the black-fruited aronia cultivated in Europe and considered to be *Aronia melanocarpa*, is well distinguished from its wild ancestors. It characterized by extremely low variability because of apomixes. In addition, mass of fruits from cultivated plants is 2 – 3 times as large as that of fruits originating from North American plants. In the North American wild plants, fruits are oval or slightly pyriform (pear-shaped), shiny, less juicy. In the cultivated aronia,

they are globular, mostly somewhat depressed (at least at the apex), and always opaque, juicier than those wild-collected. There are differences in size and quantity of flowers: North American plants have fewer and smaller flowers than specimens of cultivated aronia. Reliable differences in the shape and size of leaf blades were also revealed. While North American aronia is only moderately hardy (Zone 4), aronia cultivated in the Europe is extremely hardy, so that it is possible to assign it to Zone 2 (Skvortsov and Maitulina, 1982). Cultivated black-fruited aronia is capable of autonomous, spontaneous apomixes and is a tetraploid race $2n = 68$ (Skvortsov et al., 1983). On the contrary, in *Aronia melanocarpa* within its natural range (North Carolina), similar experiments (isolation, castration, and artificial pollination) did not yield any evidence of apomixis (Hardin, 1973; Hall et al., 1978).

Since the cultivated aronia exhibits distinct differences from its wild ancestors, remains constant in its characteristics, and has acquired a very wide range across Northern Eurasia, it appears to be described as a new species *Aronia mitschurinii* (Skvortsov and Maitulina, 1982).

Selection of chokeberry is conducted in Russia, Belarus, Finland, Poland, Sweden and the USA, sometimes with the involvement of other species (*Sorbus*, *Aronia*, *Crataegus*). In the USA, while the selection of fruit cultivars, the forms *Aronia mitschurinii*, obtained from Eastern Europe, are

more often used (Strik and Wrolstad, 2003). In the literature, there are data on several varieties of *Aronia mitschurinii*, but these cultivars are difficult to distinguish one from another according to morphological characteristics (Leonard, 2011). Moreover, all these cultivars have a similar genotype (Persson-Hovmalm et al., 2004). So we are talking about the only selective form, cultivated in different countries under different names. Artificial pollination of experimental plants does not lead to the production of hybrids and has no significance since the fruits develop by apomixis and are, as it were, clones of the mother plant. The following cultivars used for fruit production have been obtained from *Aronia mitschurinii*: Nero (Czech Republic), Ahonnen, De Belder, Hakkija, Rubina, Viking (Finland), Hugin (Sweden), Aron (Denmark), Chernookaja, Chernoplodnaja, Chernavka, Altaiskaja krupnoplodnaja (Russia), Venisa, Nadzeja (Belarus), Albigowa, Darbrowice, Egerta, Kutno, Nowa Wies, Galicjanka (Poland), Zerina (Germany), Fertödi (Hungary), Moskva (Norway) (Vinogradova and Kuklina, 2014).

Nutritional supplements, syrup, juice, jellies, and tea were made from the fruits. The *Aronia* is also used for liqueur and spirit production and wines (Ara, 2002).

The juice from fruits of *Aronia* has an antimutagenic activity (Gasiorowski et al., 1997), gastroprotective effect (Matsumoto et al., 2004), hepatoprotective activity (Valcheva-Kuzmanova S.V., Belcheva, 2006), anticancer activity (Sharif et al., 2012), cardioprotective and antidiabetes effect (Kulling and Rawel, 2008; Denev et al., 2012), anti-inflammatory effect (Martin et al., 2014), antiatherogenic activity (Daskalova et al., 2015).

Aronia mitschurinii have a very high content of polyphenols (Mayer-Miebach et al., 2012; Bräunlich, 2013; Taheri, 2013), namely cyanidin anthocyanins, proanthocyanins, flavonols, chlorogenic acid and neochlorogenic acid (Oszmiański and Wojdyło, 2005; Slimestad et al., 2005; Koponen et al., 2007).

Scientific hypothesis

The aim of this study was to distinguish the best phenotypes from our collections of *Aronia mitschurinii*, which could be successfully grown on plantations. The high variability of the artificial introduction population will contribute to successful results of directed selection work with this fruit plant in the future.

MATERIAL AND METHODOLOGY

Locating trees and data collection

The objects of the research were 10-year-old plants of *Aronia mitschurinii*, which are growing in the Forest-

Steppe of Ukraine in M.M. Gryshko National Botanical Garden of NAS of Ukraine (NBG). They are well adapted to the climatic and soil conditions. Observations on the collection's forms of *Aronia mitschurinii* in the period 2015-2016 were performed during mass fruiting. We have described 7 phenotypes of *Aronia mitschurinii*.

Morphometric characteristics

Pomological characteristics were conducted with four replications on a total 30 fruits and 30 corymb per phenotypes. In the study only one plant (tree) used for per phenotype.

The following measurements were taken: fruit weight, in g, fruit length, in mm, fruit width, in mm, fruit volume, in cm^3 (calculated according formula of ellipsoid $\frac{4}{3} \pi abc$ where a, b, c are semiaxes of fruits), number of fruits in the corymb, corymb weight, in g. Data, we are working with, were tested for normal distribution.

Statistical analyses

Basic statistical analyses were performed using PAST 2.17; hierarchical cluster analyses of similarity between phenotypes were computed on the basis of the Bray-Curtis similarity index; multi-dimensional scaling (MDS) analyses were performed in PRIMER (Clarke and Gorley, 2006). Variability of all these parameters was evaluated using descriptive statistics. Level of variability determined by Stehlíková (1998).

RESULTS AND DISCUSSION

The images of *Aronia mitschurinii* fruits of various phenotypes are shown in Figure 1, 2.

Morphometric characteristics

The average weight of *Aronia mitschurinii* fruits of present study was in the range from 0.48 to 1.92 g (Table 1). The coefficient of variation was 26.50%, which shows a high degree of variability of fruit weight. According to Khromov (2016), the fruit weight of cultivars such as Chernookaja, Venisa, Nadzeja was determined as 0.91 – 1.03 g and choice genotypes 1.13 – 1.24 g.

The average length of fruit in our analyses was determined in the range from 8.14 to 14.40 mm. The value of the coefficient of variation was 10.30%, which shows a medium level of variability of fruit length.

In our experiments, the average diameter of fruit was determined in the range from 8.67 to 15.44 mm. The variation coefficient (9.84%) confirmed the medium level of variability for this characteristic within the collection.



Figure 1 Variability in the shape of *Aronia mitschurinii* A.K. Skvortsov & Maitul. fruits.



Figure 2 Variability in the shape and number of fruits in the corymb of *Aronia mitschurinii* A.K. Skvortsov & Maitul.

Ochmian et al. (2012) have established a range of fruit’s weight of cultivar Galicjanka from 12.9 to 16.4 mm, Hugin from 6.1 to 7.2 mm, Nero from 12.1 to 15.8 mm and Viking from 12.8 to 16.2.

The size of fruit will be better illustrated by using such characteristic as a volume of fruit. The average volume of *Aronia mitschurinii* fruits in the present study was in the range from 0.32 to 1.61 cm³. The coefficient of variation was 28.70%, which shows a very high level of fruit’s volume variability.

An average number of fruits in the corymb was identified in range from 6 to 36. Coefficient of variation was 32.16%, which shows a very high degree of variability.

The average number of fruits in the corymb was determined in a range of cultivar 13 – 14 and choice genotype from 12 – 20 by Khromov (2016).

The average cumulative mass of fruits in a corymb was determined in the range from 6.10 to 47.12 g. The coefficient of variation was 36.42%, which shows a very high degree of variability of corymb weight. According to

Khromov (2016), the same characteristic of corymb for cultivars was determined as 11.83 – 13.72 g and for choice genotypes – 13.80 – 24.80 g.

The shape of each object can be characterized by the shape index, i.e. the length to width ratio. Figure 3 represents the shape indexes of fruits. The shape index of the fruits was found in the range from 0.87 (AM-01, AM-05, AM-07) to 0.93 (AM-02). These parameters can be used for the identification of different phenotypes and genotypes (at a later stage).

The analysis of coefficient of variation showed the difference of variability of morphological signs between *Aronia mitschurinii* samples. Data showed that the most variability of important selection characteristics are the average cumulative mass of fruits in a corymb – from 12.34 (AM-03) to 38.61 (AM-02) % and fruit number of fruits in the corymb – from 14.56 (AM-03) to 36.88 (AM-02) %. The other characteristics are more or less stable (Figure 3).

Table 1 The variability of some morphometric parameters of fruits for the whole collection of *Aronia mitschurinii* A.K. Skvortsov & Maitul. genotypes from Kyiv.

Characteristics	Unit	n	min	max	mean	CV%
Fruit weight	g	210	0.48	1.92	1.07	26.50
Fruit length	mm	210	8.14	14.4	10.94	10.30
Fruit diameter	mm	210	8.67	15.44	12.09	9.84
Fruit volume	cm ³	210	0.32	1.61	0.86	28.70
Number of fruits in the corymb		3370	6.0	36.0	16.04	32.16
Corymb weight	g	210	6.10	47.12	15.78	36.42

Note: n – number of measurements; min, max – minimal and maximal measured values; mean – arithmetic mean; CV – coefficient of variation (%).

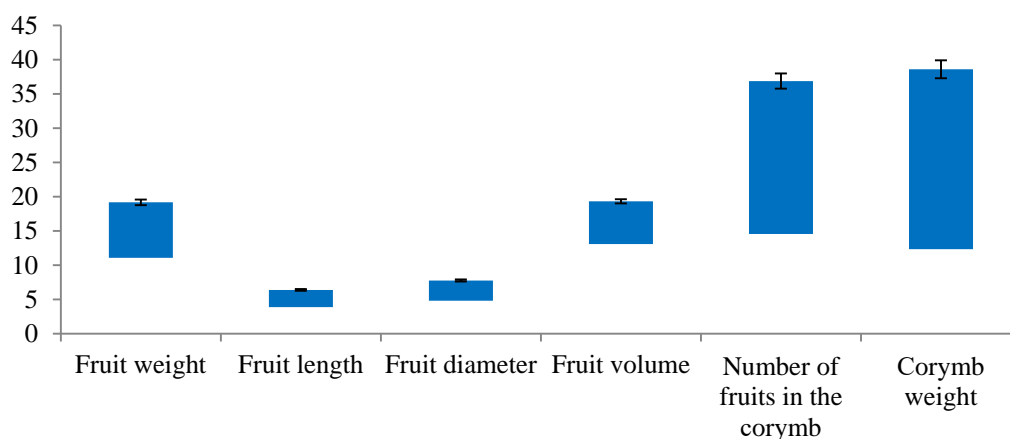

Figure 3 Variability level according to the minimum and maximum means of a coefficient of variation (CV) of every morphological character of fruit *Aronia mitschurinii* A. K. Skvortsov & Maitul. (%).

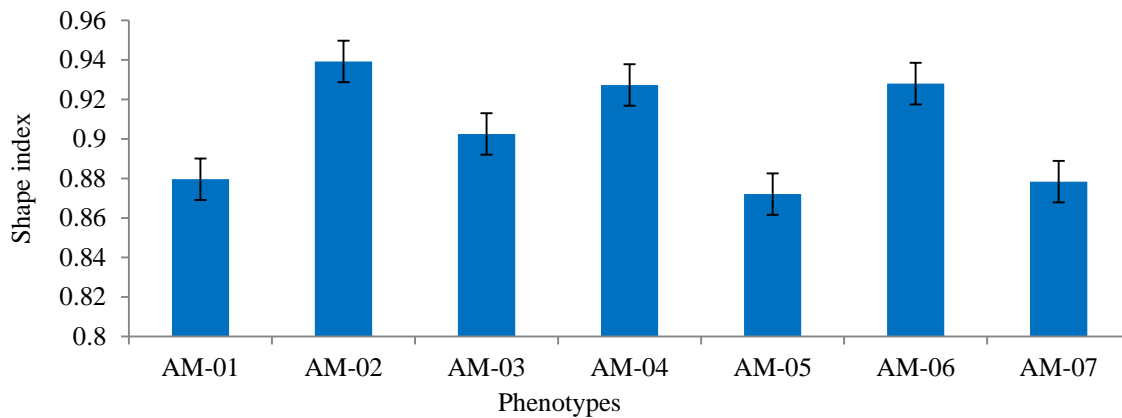

Figure 4 Comparison of the tested *Aronia mitschurinii* A. K. Skvortsov & Maitul phenotypes in the shape index of fruit.

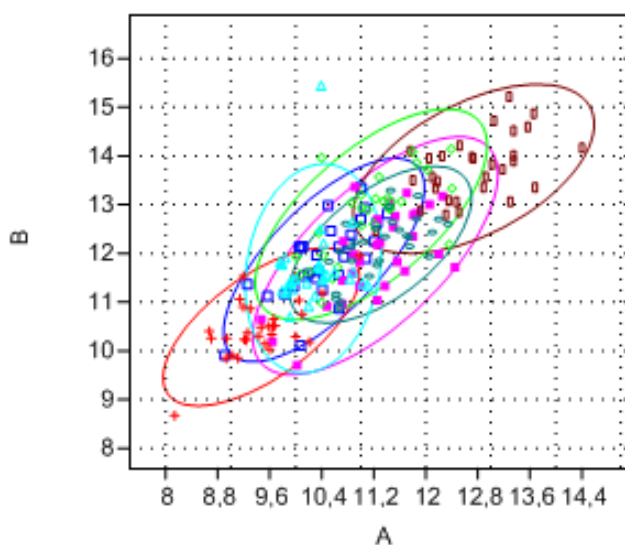

Figure 5 MDS plot of the similarity illustrating the length (A) and diameter (B) of fruits for studying samples of *Aronia mitschurinii* A. K. Skvortsov & Maitul.

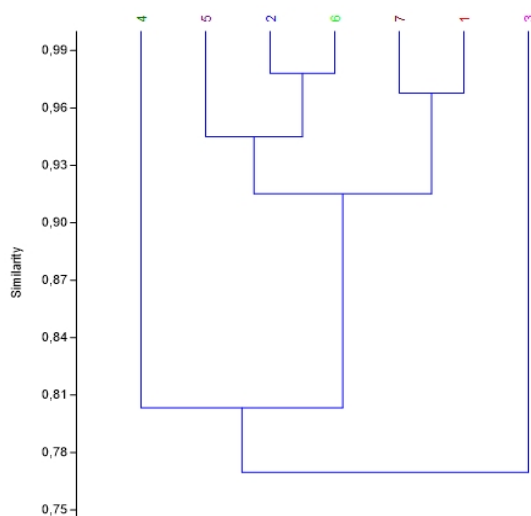

Figure 6 Cluster dendrogram of studying phenotypes of *Aronia mitschurinii* A.K. Skvortsov & Maitul.

Results of multi-dimensional scaling are shown in Figures 4. In Figure, it is possible to see the visual distribution the size of the fruits of the studied phenotypes. The sample AM-03 (red ellipse) with the smallest fruit size and the sample AM-04 (brown ellipse) with the largest fruit size differ each another with the probability of 95% (the ellipses in the figure do not overlap). Differences in fruit size for other samples are not reliable.

Based on the cluster analysis of all 6 studied fruit's characteristics, a dendrogram for the phenotypes of Aronia was made (Figure 5). On the dendrogram (Figure 6), you can see that the sample AM-03 is really separated from the other samples. It is distinguished not only by the smallest fruits but also by reddish branches of the corymb.

This sample is probably a unique genotype and can be used in the future for the selection of decorative forms of Aronia. A sample AM-04 with the largest fruits is separated almost immediately, too. This sample also represents perhaps a particular genotype (this hypothesis will be tested later by molecular genetic methods). Samples 1 – 2 and 5 – 7 do not differ significantly from each other and, apparently, represent an integrated cluster.

This is a very high indicator for this species, given into consideration its apomixis and the presence of only one genotype on the cultural plantations of Europe and America (Persson-Hovmalm et al., 2004). According to Skvortsov et al. (2008), for successful selection work, it is necessary at the first stage to create a wide variable introduction population that is resistant to the environmental and climatic conditions of the region. At the second stage, it is necessary to get rid of extremely undesirable phenotypes (for example, individuals with very small or bitter fruits). And only in the third stage, after free or controlled pollination in the introduction population, new sortotypes can be selected. The multiplication of new sortotypes and the creation of cultivars is the final stage of selection. The cultivars were created by this method are not as "beautiful" as those obtained with traditional artificial pollination, but can bear fruit every year and are resistant to unfavorable conditions.

CONCLUSION

The results of the experiment, which presented in this work, are consistent with the results reported earlier. Selection potential of chokeberry in the M.M. Gryshko National Botanical Garden is quite high, and our data demonstrate the presence at least 2 or 3 genotypes of Aronia mitschurinii in the collection. Their morphometric parameters were following: the weight from 0.75 to 1.52 g, the length from 9.46 to 12.73 mm, the diameter from 10.49 to 13.73 mm, the fruits number in the corymb from 11.33 to 20.13, the cumulative weight of fruits in the corymb from 10.42 to 21.73 g, the volume of fruits from 0.55 to 1.26 cm³. The shape index of the fruits was found in the range of 0.87 to 0.93. The most variability of important selection characteristics are the average cumulative mass of fruits in a corymb – from 12.34 to 38.61% and fruit number of fruits in the corymb – from 14.56 to 36.88%.

The introduction population of the Aronia mitschurinii, was created in the Botanical Garden, has a sufficient potential for successful selection work.

REFERENCES

- Ara, V. 2002. Schwarzfruchtige Aronia: Gesund – und bald "in aller Munde"? *Flüssiges Obst*, vol. 10, p. 653-89.
- Brand, M. 2010. Aronia: Native Shrubs With Untapped Potential. *Arnoldia*, vol. 67, no. 3, p. 14-25.
- Bräunlich, M. 2013. *Bioactive constituents in aronia berries* : dissertation theses. Oslo, Norway : University of Oslo. 110 p.
- Brindza, P., Brindza, J., Tóth, D., Klimenko, S. V., Grigorieva, O. 2007. Slovakian cornelian cherry (*Cornus mas* L.): potential for cultivation. *Acta Horticulturae*, vol. 760, p. 433-437. <https://doi.org/10.17660/ActaHortic.2007.760.59>
- Bystrická, J., Musilová, J., Lichtnerová, H., Lenková, M., Kovarov, J., Chalas, M. 2017. The content of total polyphenols, ascorbic acid and antioxidant activity in selected varieties of quince (*Cydonia oblonga* Mill.). *Potravinárstvo Slovak Journal of Food Sciences*, vol. 11, no. 1, p. 77-81. <https://doi.org/10.5219/699>
- Clarke, K., Gorley, R. 2006. *PRIMER v6: User Manual – Tutorial*. Plymouth, UK : Plymouth Marine Laboratory. 192 p.
- Daskalova, E., Delchev, S., Peeva, Y., Vladimirova-Kitova, L., Kratchanova, M., Kratchanov, Ch., Denev, P. 2015. Antiatherogenic and Cardioprotective Effects of Black Chokeberry (*Aronia melanocarpa*) Juice in Aging Rats. *Evidence-Based Complementary and Alternative Medicine*, vol. 2015, p. 1-10. <https://doi.org/10.1155/2015/717439> PMID:26351516
- Denev, P. N., Kratchanov, C. G., Ciz, M., Lojek, A., Kratchanova, M. G. 2012. Bioavailability and antioxidant activity of black chokeberry (*Aronia melanocarpa*) polyphenols: In vitro and in vivo evidences and possible mechanisms of action: A review. *Comprehensive Reviews in Food Science and Food Safety*, vol. 11, no. 5, p. 471-489. <https://doi.org/10.1111/j.1541-4337.2012.00198.x>
- Gasiorowski, K., Szyba, K., Brokos, B., Kołaczyńska, B., Jankowiak-Włodarczyk, M., Oszmiański, J. 1997. Antimutagenic activity of anthocyanins isolated from *Aronia melanocarpa* fruits. *Cancer Letters*, vol. 119, no. 1, p. 37-46. [https://doi.org/10.1016/S0304-3835\(97\)00248-6](https://doi.org/10.1016/S0304-3835(97)00248-6)
- Grygorieva, O., Abrahamová, V., Karnatovská, M., Bleha, R., Brindza, J. 2014. Morphological characteristic of fruit, drupes and seeds genotypes of *Ziziphus jujuba* Mill. *Potravinárstvo*, vol. 8, no. 1, p. 306-314. <https://doi.org/10.5219/414>
- Grygorieva, O., Klymenko, S., Brindza, J., Schubertová, Z., Nikolaieva, N., Šimková, J. 2017. Morphometric characteristics of sweet chestnut (*Castanea sativa* Mill.) fruits. *Potravinárstvo Slovak Journal of Food Sciences*, vol. 11, no. 1, p. 288-295. <https://doi.org/10.5219/684>
- Hall, I. V., Woodz, G. W., Jackson, L. P. 1978. The biology of Canadian weeds. 30. *Pyrus melanocarpa* (Michx.) Willd. *Canadian Journal of Plant Science*, vol. 58, no. 2, p. 499-504. <https://doi.org/10.4141/cjps78-075>
- Hardin, J. W. 1973. The enigmatic chokeberries. *Bulletin Torrey Botanical Club.*, vol. 100, no. 3, p. 178-184. <https://doi.org/10.2307/2484630>
- Khromov, N. V. 2016. Estimation of *Aronia melanocarpa* genetic resources collected at I.V. Michurin research Institute for horticulture. *Contemporary horticulture. Electronic Journal*, vol. 1, p. 52-56.
- Koponen, J. M., Happonen, A. M., Mattila, P. H., Torronen, A. R. 2007. Contents of anthocyanins and ellagitannins in selected foods consumed in Finland. *Journal of Agricultural Food Chemistry*, vol. 55, no. 4, p. 1612-1619.

<https://doi.org/10.1021/jf062897a>

PMid:17261015

Kucelova, L., Grygorieva, O., Ivanisova, E., Terentjeva, M., Brindza, J. 2016. Biological properties of black mulberry-derived food products (*Morus nigra* L.). *Journal of Berry Research*, vol. 6, no. 3, p. 333-343.

<https://doi.org/10.3233/JBR-160141>

Kulling, S. E., Rawel, H. M. 2008. Chokeberry (*Aronia melanocarpa*) – A review on the characteristic components and potential health effects. *Planta Medica*, vol. 74, no. 13, p. 1625-1634.

<https://doi.org/10.1055/s-0028-1088306>

PMid:18937167

Leonard, P. J. 2011. *Aronia mitschurinii: Solving a Horticultural Enigma* : dissertation theses. Connecticut, UK : University of Connecticut. 96 p.

Martín, D. A., Taheria, R., Brand, M. H., Draghi, A., Sylvester, F. A., Bollinga, B. W. 2014. Anti-inflammatory activity of aronia berry extracts in murine splenocytes. *Journal of Functional Foods*, vol. 8, p. 68-75.

<https://doi.org/10.1016/j.jff.2014.03.004>

Matsumoto, M., Hara, H., Chiji, H., Kasai, T. 2004. Gastroprotective effect of red pigments in black chokeberry fruit (*Aronia melanocarpa* Elliot) on acute gastric hemorrhagic lesions in rats. *Journal of Agricultural and Food Chemistry*, vol. 52, no. 8, p. 2226-2229.

<https://doi.org/10.1021/jf034818q>

PMid:15080625

Mayer-Miebach, E., Adamiuk, M., Behnlian, D. 2012. Stability of Chokeberry Bioactive Polyphenols during Juice Processing and Stabilization of a Polyphenol-Rich Material from the By-Product. *Agriculture*, vol. 2, no. 3, p. 244-258.

<https://doi.org/10.3390/agriculture2030244>

Monka, A., Grygorieva, O., Chlebo, P., Brindza, J. 2014. Morphological and antioxidant characteristics of quince (*Cydonia oblonga* Mill.) and chinese quince fruit (*Pseudocydonia sinensis* Schneid.). *Potravinárstvo*, vol. 8, no. 1, p. 333-340.

<https://doi.org/10.5219/415>

Ochmian, I., Grajkowski, J., Smolik, M. 2012. Comparison of Some Morphological Features, Quality and Chemical Content of Four Cultivars of Chokeberry Fruits (*Aronia melanocarpa*). *Notulae Botanicae Horti Agrobotanici Cluj-Napoca*, vol. 40, no. 1, p. 253-260.

Oszmiański, J., Wojdyło, A., 2005. *Aronia melanocarpa* phenolics and their antioxidant activity. *European Food Research and Technology*, vol. 221, no. 6, p. 809-813.

<https://doi.org/10.1007/s00217-005-0002-5>

Persson-Hovmalm, H. A., Jeppsson, N., Bartish, I. V., Nybom, H. 2004. RAPD analysis of diploid and tetraploid populations of *Aronia* points to different reproductive strategies within the genus. *Hereditas*, vol. 141, no. 3, p. 301-312.

<https://doi.org/10.1111/j.1601-5223.2004.01772.x>

PMid:15703047

Sharif, T., Alhosin, M., Auger, C., Minker, C., Kim, J. H., Etienne-Selloum, N., Bories, P., Gronemeyer, H., Lobstein, A., Bronner, C., Fuhrmann, G., Schini-Kerth, V. B. 2012. *Aronia melanocarpa* juice induces a redox-sensitive p73-related caspase 3-dependent apoptosis in human leukemia cells. *PLoS One*, vol. 7, no. 3, p. e32526.

<https://doi.org/10.1371/journal.pone.0032526>

PMid:22412883

Skvortsov, A. K., Maitulina, Y. K. 1982. On distinctions of cultivated black-fruited aronia from its wild ancestors [online] s.a. [cit. 2017-11-05] Available at : <http://www.salicicola.com/translations/Skv1982Aronia.htm>

Skvortsov, A. K., Maitulina, Y. K., Gorbunov, Y. N. 1983. Cultivated black-fruited aronia: place, time, and probable mechanism of formation [online] s.a. [cit. 2017-11-05] Available at : <http://www.salicicola.com/translations/Skv1983Aronia.html>

Skvortsov, A. K., Vinogradova, Y. K., Kuklina, A. G. 2005. *Formation of resistant introduction populations: apricot, cherry, bird cherry, currant, aronia*. Moscow, Russia : Nauka. 187 p. ISBN 5-02-033677-7.

Slimestad, R., Torskangerpoll, K., Nateland, H. S., Johannessen, T., Giske, N. H. 2005. Flavonoids from black chokeberries, *Aronia melanocarpa*. *Journal of Food Composition and Analysis*, vol. 18, no. 1, p. 61-68.

<https://doi.org/10.1016/j.jfca.2003.12.003>

Slimestad, R., Torskangerpoll, K., Nateland, H. S., Johannessen, T., Giske, N. H., 2005. Flavonoids from black chokeberries, *Aronia melanocarpa*. *Journal of Food Composition and Analysis*, vol. 18, no. 1, p. 61-68.

<https://doi.org/10.1016/j.jfca.2003.12.003>

Stehlíková, B., 1998. *Basis of Bio-statistics – Biodiversity protection 51 (Základy bioštatistiky – Ochrana biodiverzity 51)*. Nitra, Slovakia : SPU. 79 p. ISBN 80-7137-539-X (In Slovak)

Strik, B., Wrolstad, R. 2003. Performance of Chokeberry (*Aronia melanocarpa*) in Oregon, USA. *Acta Horticulturae*, vol. 626, p. 447-451.

<https://doi.org/10.17660/ActaHortic.2003.626.61>

Taheri, R. 2013. *Polyphenol Composition of Underutilized Aronia Berries and Changes in Aronia Berry Polyphenol Content Through* : dissertation theses. Connecticut, UK : University of Connecticut. 126 p.

Valcheva-Kuzmanova, S. V., Belcheva, A. 2006. Current knowledge of *Aronia melanocarpa* as a medicinal plant. *Folia Medica (Plovdiv)*, vol. 48, no. 2, p. 11-17.

Vinogradova, Y. K., Kuklina, A. G. 2014. *Aronia mitschurinii: from origination to naturalization*. Moscow, Russia : GEOS. 137 p. ISBN 978-5-89118-667-5.

Žiarovská, J., Poláčková, P. 2012. Efficiency of real-time PCR for 18S rRNA amplification of *Sorbus domestica* L. *Potravinárstvo*, vol. 6, no. 3, p. 47-49.

<https://doi.org/10.5219/203>

Acknowledgments:

The publication was prepared with the active participation of researchers in international network AGROBIONET, as a part of international program "Agricultural biodiversity to improve nutrition, health and quality of life" within the project ITMS 25 110 320 104 Innovation of test methods and procedures for the detection of sources of bioactive substances for the improvement of health and quality of life. Experimental activities were realized in laboratories of Excellent center for the conservation and use of agrobiodiversity at the Faculty of Agrobiolgy and Food Resources, Slovak Agricultural University in Nitra. Yulia Vinogradova (51700340) is thanking to the International Visegrad Scholarship Fund for the realization of research at the Institute of Biodiversity Conservation and Biosafety.

Contact address:

Prof. Yulia Vinogradova, Doctor of biology, N.V. Tsitsin Main Botanical Garden of Russian Academy of Sciences, Botanicheskaya, 4, 127276 Moscow, Russia, E-mail: gbsad@mail.ru.

Mgr. Olga Grygorieva, PhD., M.M. Gryshko National Botanical Gardens of Ukraine National Academy of

Sciences, Timiryazevska 1, 01014 Kyiv, Ukraine, E-mail:
olgrygorieva@gmail.com

Mgr. Olena Vergun, PhD., M. M. Gryshko National
Botanical Gardens of Ukraine National Academy of
Sciences, Timiryazevska 1, 01014 Kyiv, Ukraine, E-mail:
en_vergun@ukr.net

Doc. Ing. Ján Brindza, PhD., Slovak University of
Agriculture in Nitra, Faculty of Agrobiological and Food
Resources, Institute of Biological Conservation and
biosafety, Trieda Andreja Hlinku 2, 949 76 Nitra,
Slovakia, E-mail: Jan.Brindza@uniag.sk

THE INFLUENCE OF GLUTEN-FREE BAKERY PRODUCTS CONSUMPTION ON SELECTED ANTHROPOMETRIC PARAMETERS

*Martina Gažarová, Zuzana Chlebová, Jana Kopčėková,
Petra Lenártov, Mria Holovičov*

ABSTRACT

The aim of the study was to evaluate the effect of a short-term consumption (six weeks) of gluten-free bakery products on the anthropometric parameters. The study group was composed of volunteers from the general population and consisted of 30 healthy adults. The amount of bakery product was determined as follows: women consumed 150 – 200 grams per day; men 200 – 250 grams per day. Anthropometric measurements were made by using InBody 720, we received data such as body weight, Body Mass Index (BMI) and Waist-to-Hip Ratio (WHR), which we evaluated the presence of overweight and obesity in the monitored groups. We also observed visceral fat area (VFA). We found out that the 6-week consumption of gluten-free bread and bakery products showed a significant reduction in body weight and BMI ($p < 0.01$), but also a significant increase in VFA ($p < 0.05$). By the impact of consumption we recorded the increase of body weight and BMI in 70% of participants (in 30% there was slight increase), decrease of WHR in 33% (increase in 43%) and decrease of VFA in 43% (increase in 57%). For other participants, the values remained unchanged. Two months after the termination of the consumption of gluten-free products we found out the increase of body weight and BMI, WHR remained unchanged, however in the case of VFA showed significant increase of values. We can summarize that dietary habits play a crucial role in the development of overweight and obesity and the consumption of bread and bakery products can also affect it. However, the overall effect of bread and bakery consumption on the development of overweight depends on many factors, such as the composition of the bread and bakery products and the presence of gluten.

Keywords: gluten, bakery products, body mass index, waist-to-hip ratio, visceral fat area

INTRODUCTION

Obesity is health problem affecting more than a million adults worldwide (WHO, 2008). Health professionals recommend the exclusion of some foods in weight loss diets (Layman et al., 2003; Luscombe et al., 2003; Yancy et al., 2004; Noakes et al., 2005). Restricting the consumption of carbohydrates, especially bread, is a frequent practice since these foods are considered as inappropriate and are included in the list of forbidden foods by those trying to lose weight (Malinauskas et al., 2006; Lpez Sobaler et al., 2007). High carbohydrate content in cereals is considered as one of the factors contributing to the obesity epidemic (Hoffmanov and Snchez, 2015).

Bread is one of the most popular staple foods in the world and its consumption provides energy, proteins, dietary fiber, minerals and vitamins intake (Nanditha and Prabhasankar, 2009). Bread and bakery products are usually produced from wheat and rye containing gluten. Prolamins such as gliadins of wheat, hordeins of barley, secalins of rye and avenins of oats cause health problems

to people with disorders such as coeliac disease, allergy and non-coeliac gluten sensitivity (Hamer, 2005).

The prevalence of celiac disease is high, ranging from 0.5 – 1% in Europe and America, a similar prevalence is also estimated in Australia, the Middle East, North Africa and probably also in northern China. In Slovakia, the incidence of celiac disease is 1:250. Prevalence is more pronounced in women with a ratio of 2:1 to 3:1 (Such et al., 2015). Celiac disease also known as celiac sprue or glutene enteropathy is a digestive and autoimmune disorder resulting in damage to the small intestine mucosa caused by eating foods containing gluten (Bansal, Gupta and Bansal, 2017). Recognition of symptoms, as well as a responsible approach to disease therapy and nutrition counseling is very important for the patient's prognosis (Haas et al., 2014). At present, the only affordable and acceptable treatment for celiac disease is a strict gluten-free diet, which in practice means excluding all foods containing rye, wheat and barley. The inclusion of oats in the diet is still under discussion. At present, we are still working on the development and validation of new

methods for determining the presence of gliadins, secalins and hordeins in plant material and on the possibilities of using various alternative plants and pseudocereals in nutrition of celiacs (**Socha, Raždíková and Urminská, 2010; Chňapek et al., 2014**).

Dietary measures usually lead to normalization of clinical, laboratory and enterobiotic findings at a different time from the introduction of a gluten-free diet (**Suchá et al., 2015**). The content of some vitamins (B₁, B₂, B₁₂, D), minerals (iron, calcium, zinc, magnesium) and dietary fiber in the gluten-free diet may be lower than recommended for a sufficient intake (**Frič and Keil, 2011**). In the western civilization, daily consumption of gluten is very high, on average 20-50 g (**Hoffmanová and Sánchez, 2015**).

Recently, gluten-free products are very popular among consumers without diagnosed celiac disease, which has caused an exponential increase in gluten-free product sales. This report was updated by NHANES (National Health and Nutrition Examination Survey) from 2009 – 2012. From all of study participants (14,701 participants), 0.9% of them adhered to a gluten-free diet even though they had no diagnosed celiac disease (**Missbach et al., 2015**). A gluten-free diet is necessary for patients with any form of gluten sensitivity. However, today many healthy people adhere to a gluten-free diet, although this is not necessary (**Kolesárová et al., 2017**). This is a trend promoting gluten-free diet as a healthier diet. According to the survey, up to 30% of Americans are adhering to this diet. After removing gluten from the diet, these people feel less tired and, above all, do not have a weight problem. In fact, gluten-free foods are known to have an increased amount of fat, in some cases they contain up to 5 times more fat than gluten-containing products, so it is difficult to lose weight with this diet (**Kutner, 2014**). According to **Penagini et al. (2013)** gluten-free products contain more carbohydrates and lipids compared to the gluten products and have a high glycemic index (estimated glycemic index of gluten-free products is ranged between 83.3 – 96.1 vs. 71 for white bread). In 2015, a study involving 30,000 respondents from 60 countries worldwide was carried out. It was found that 21% of respondents rated gluten-free products as an important attribute when they purchased food. The older generation is less affected by the gluten-free industry, despite the reports of an increased incidence of hypersensitivity to gluten in the elderly. According to the study, 37% of respondents under the age of 20 and 31% aged 21 – 34 were willing to pay higher prices for gluten-free products and only 22% of respondents aged 50 – 64 years and 12% aged 65 and over were also willing to invest in gluten-free products (**Reilly, 2016**).

At present, the results of scientific studies have been gathered to find out the impact (also negative impact) of gluten-free foods on a healthy consumer. Some commonly used gluten-free foods contain more fat and carbohydrates and have a lower protein, iron and folic acid content compared to the conventional products (**Kulai and Rashid, 2014**). For a healthy consumer, gluten-free foods do not provide additional health benefits from a nutritional point of view, so it is not appropriate to replace products containing gluten by gluten-free foods that are considerably more expensive (**Missbach et al., 2015**). Our

study was mainly focused on the effect of six weeks consumption of gluten-free bread and bakery products on changes in selected anthropometric parameters. Simultaneously, we assessed other changes of selected parameters two months after the termination of consumption of gluten-free bakery products.

Scientific hypothesis

Six weeks consumption of gluten-free bread and bakery products have effect on changes in selected anthropometric parameters.

MATERIAL AND METHODOLOGY

The trial was approved by the Ethic Committee at the Specialized Hospital St. Zoerardus Zobor, n.o. Nitra, Slovakia (protocol no. 012911/2016). The requirement for participation in the research was informed consent of volunteers with all the study and measurement conditions which they will have to complete during the research. All participants signed written informed consent to participate in the study. The participant group was composed of volunteers from the general population and consisted of 30 healthy adults (3 men and 27 women), who during 6-week period consumed gluten-free bread and gluten-free bakery products, however the participant of the study were not allowed total gluten-free diet. Participants with the present severe disease or with recommended special dietary regimen were excluded from the study group. The amount of bread and bakery products was determined according to the recommended consumption of food for the Slovak population as follows: women consumed 150-200 grams per day; men 200 – 250 grams per day. All participants were asked not to change their eating habits and also not to change their habits related to the physical activity.

Probands had a total of 3 anthropometric measurements (first measurement before consumption of gluten-free bakery products, second measurement after the 6-week consumption of gluten-free bread and bakery products, and the third measurement 2 months after end of consuming gluten-free bakery products).

The anthropometric measurements were made by using InBody 720 (Biospace Co. Ltd., Seoul, Republic of Korea). Each of the participants was informed with the measurement procedure, explained the possible risks of measuring in the case of pregnancy or having an artificial pacemaker at the heart. Before the measurement, participants were asked to excrete and refrain from drinking excessive amounts of water (**Wiklund et al., 2014**). At the same time each participant signed informed consent for the measurement procedure and also agreed to the processing of personal data. We used the Lookin'Body 3.0 software to process the results. Through the Inbody 720 we received data such as weight, Body Mass Index (BMI) and Waist-to-Hip Ratio (WHR), which we evaluated the presence of overweight and obesity in the monitored groups. We also observed visceral fat area (VFA). Its excessive amount causes the metabolic and cardiovascular diseases. In the examination, the visceral fat area is defined as the cross-sectional area of visceral fat found in the abdomen.

Statistical analysis

We evaluated the collected data from the anthropometric measurements statistically and graphically in Microsoft Office Excel 2010 (Los Angeles, CA, USA). The changes in different groups were performed using Pared Student *t*-test and the data were presented as mean \pm standard deviation (SD). The levels of statistical significance were set at $p < 0.05$ (*), $p < 0.01$ (**), $p < 0.001$ (***)

RESULTS AND DISCUSSION

Figures 1 – 4 and Table 1 show the changes of selected monitored parameters of participants throughout the survey.

Body weight

Bread is one of the most restricted foods in hypocaloric and reduced diets. **Loria-Kohen et al. (2012)** found that the results obtained after the completion of a hypocaloric diet intervention in overweight and obese patients are not related to the presence or absence of bread in the diet. There were no significant differences between bread or no-bread groups, both groups significantly reduced their body weight. Study of **Lean et al. (1997)** showed that a greater intake of bread is associated with less weight loss in postmenopausal women; however, **Aston, Stokes and Jebb (2008)** reported that the presence of bread was associated with greater weight loss.

At the beginning of the study during the first measurement was the average body weight of probands 65.32 ± 12.60 kg. The value of maximal body weight was 101.40 kg and the lowest value of body weight was 48.50 kg. 20% of the participants exceeded their maximum recommended weight (Figure 1, Table 1). One proband was below the recommended minimum, other participants ranged within recommended values. After 6-week consumption of gluten-free bakery products, the average body weight of participants significantly decreased to 65.08 ± 12.54 kg ($p < 0.01$). The value of maximal body weight was 100.50 kg and the lowest value of body weight was 48.10 kg. The exceeding of the recommended body weight was again recorded in 20% probands and same as

below the recommended minimum value (1 participant). In one analytic study, in whose participated total 37 patients, were collected data about the patients with celiac disease, where after the year of the consumption of the gluten free diet the authors recorded significant increase of the body weight. The value of BMI remained within the normal range (**Quero et al., 2015**). After 2 months since the termination of the consumption of gluten free bakery products, we did not record any significant changes, despite the fact that the average weight was increased to 65.88 ± 12.78 kg, the maximum to 102.7 kg and the minimum to 50 kg. The exceeding of the recommended body weight was recorded in 20% probands, the rest of the participants were within the range of the recommended values.

Figure 1 compares the results of all 3 measurements with respect to the specified individual weight standard of each proband. During all 3 measurements, the variability of the body weight of our participants was as follows: in the second measurement (due to the consumption of bakery products), 9 participants (30%) changed its weight, which had an increase in body weight relative to the first measurement. The greatest deviation was shown in the weight gain by 2.59% and the lowest by 0.34%. 70% of the participants reduced their weight, the greatest weight loss was by 1.96% and the lowest weight loss was by 0.18%. According to **Diamanti et al. (2014)** the occurrence of overweight in patients with celiac disease is in the range from 8.8% to 20.8%. The overweight/obesity is more common in newly diagnoses patients with celiac disease. It is possible that disinclination to food is led to the preference of food with high content of fat and proteins and high caloric food. However, the occurrence of obesity is possible to explain as a global trend of the overweight/obesity in people, including celiatics. During the third measurement (two months after the end of the consumption of gluten-free bread and bakery products) 20 participants (67%) increased their body weight, while the greatest recorded increase of body weight was by 2.46%. The rest 10 probands (33%) reduced their body weight with the greatest deviation in the increase of body weight

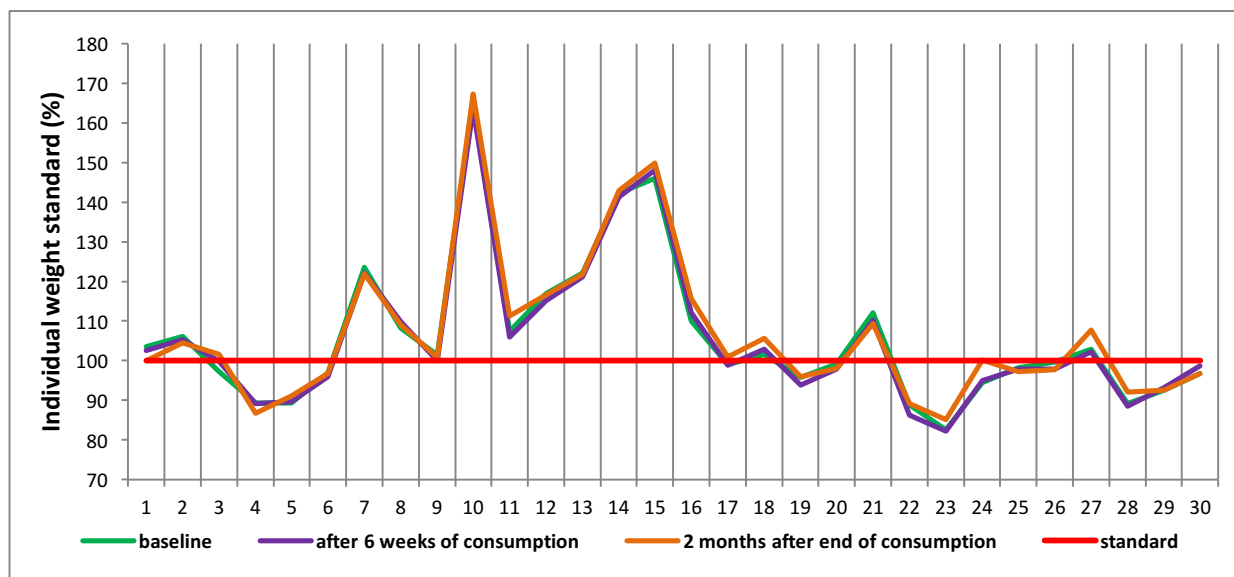

Figure 1 Changes of body weight compared to the individual weight standard in percent during the study.

by 5.35% and the lowest body weight decrease was by 0.15%. We found out that while at the beginning of the study 50% of the participants exceeded the ideal body weight, by the influence of the consumption of gluten-free bakery products the ideal body weight was exceeded in less probands (47%), but when comparing the number of subjects who exceeded the normalized body weight at the start and at the end of the study it was found the worsening, because up to 60% of the participants exceeded the normalized body weight limit in the conclusion of the study. Compared with the initial values, the body weight increased in 53% of participants, decreased in 40%, and 7% of the participants had the same body weight values between the first and last measurements. These changes were not significant.

Body Mass Index

The body mass index is used to determine the approximate degree of obesity. The BMI method is widely used in the general medicine, dietary and sport medicine as the main means for the evaluation of degree of obesity. The disadvantage of this method is that it can not be applied to adults with a high degree of muscle mass, to children and persons over 65 years or to pregnant women. The body mass index does not capture the changes in the nutritional status in the presence of overweight or obesity, because malnutrition can be present and masked by the abnormal amount of fat. Prior to the commencement of the consumption, a group with a normal weight was consisted of 23 participants, three probands had the overweight, two probands suffered from the first degree of obesity and the second degree of obesity was occurred in one participant (Figure 2, Table 1).

The average value of BMI was $22.83 \pm 3.95 \text{ kg.m}^{-2}$, while the values were in the range from 17.75 kg.m^{-2} to 35.5 kg.m^{-2} . After the 6-week consumption of gluten-free bakery products we recorded significant decrease of this index ($p < 0.01$), while the average value of BMI was $22.75 \pm 3.95 \text{ kg.m}^{-2}$ (Max value was 35.19 kg.m^{-2} and Min value was 17.68 kg.m^{-2}). After the last measurement we

observed the increase of the average value of BMI to $23.03 \pm 4.02 \text{ kg.m}^{-2}$, it was also increased Max value of BMI to 35.96 kg.m^{-2} and Min value to 18.3 kg.m^{-2} . Increase or decrease of BMI values in the dynamics of the study directly correlate with the changes in the body weight values. As it is shown in the Figure 2, nine participants (30%) increased their values of BMI in the range from 0.04 to 0.54 kg.m^{-2} , on the contrary, decreasing of BMI were observed in 21 participants (70%) in the range of $0.04 - 0.54 \text{ kg.m}^{-2}$. During the third measurement since 2 months after the consumption of gluten-free bakery products we observed further increase of BMI values in 20 probands (67%) in the range from 0.03 to 1.17 kg.m^{-2} , decreasing was found in 10 probands (33%) in the range of $0.03-0.05 \text{ kg.m}^{-2}$. During the study, BMI values over 25 kg.m^{-2} had 20% of the participants, under 19 kg.m^{-2} at the beginning 3%, after consumption since the end of the study 7% of participants. **Ukkola et al. (2012)** monitored the influence of the year consumption of gluten-free diet to the body mass index in the celiacs. The values of BMI at the determination of the diagnosis and after a year on the gluten-free diet were assessed and compared with the data of general population. At the beginning of the diagnosis of the disease were underweight 4% of monitored probands, 57% of probands had values in the normal range, 28% were overweight and 11% were obese. After a one year consumption of gluten-free diet, 69% of underweight participants increased their body weight, and 18% overweight and 42% obese participants lost weight. BMI values of other subjects remained unchanged. The celiac group showed more favorable BMI results than the normal population.

In Italy, a study was conducted to compare BMI between 150 patients with celiac disease and 288 healthy subjects. At the diagnosis of celiac disease the median value of BMI was significantly lower as in the healthy subjects; patients usually did not suffer from overweight or obesity. During gluten-free diet, there was a significant decrease in the number of underweight patients (13 vs. 27) and a minimal increase in the number of overweight patients (9 vs. 6).

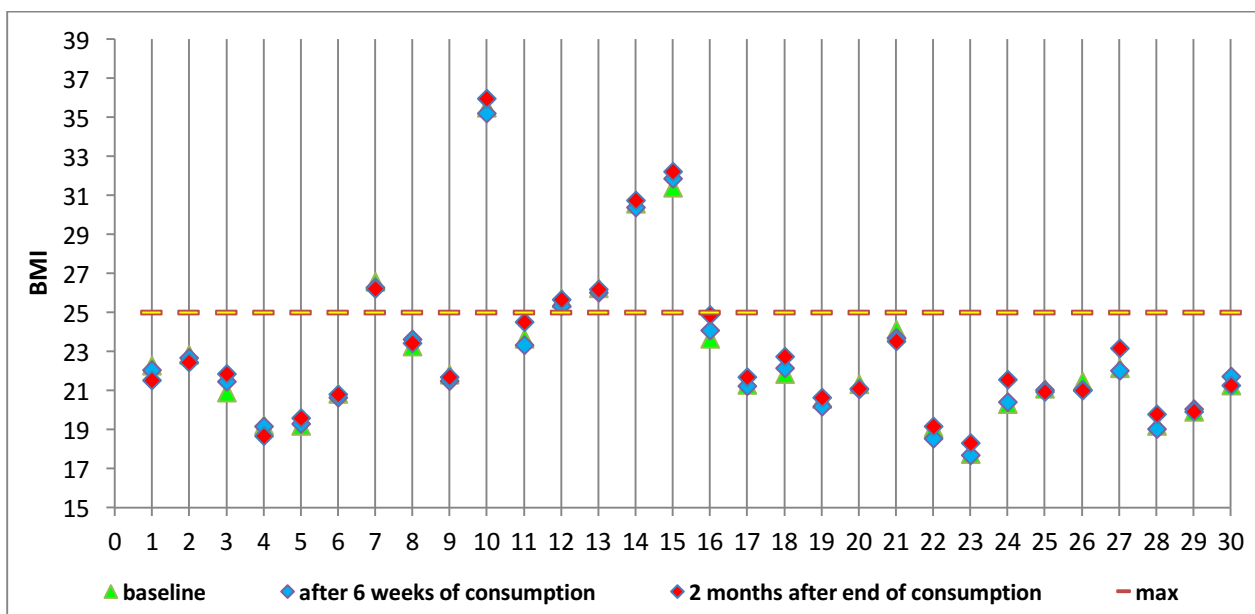

Figure 2 Changes of Body Mass Index during the study.

Table 1 Changes of body weight, BMI, WHR and VFA during the study.

	body weight (kg)			VFA (cm ²)		
	baseline	after 6 weeks of consumption	2 months after end of consumption	baseline	after 6 weeks of consumption	2 months after end of consumption
mean	65.32	65.08	65.88	72.70	73.26	75.65
±SD	12.60	12.54	12.78	29.18	30.32	29.01
Max	101.40	100.50	102.70	153.94	167.22	157.86
Min	48.50	48.10	50.00	37.80	41.07	41.50
Med	62.95	62.20	62.95	67.36	66.60	66.62
p	0.1576	0.0041 ^a	0.0587	0.4175	0.0244 ^a	0.0111 ^b
significance		**			*	*
	BMI (kg.m ⁻²)			WHR		
	baseline	after 6 weeks of consumption	2 months after end of consumption	baseline	after 6 weeks of consumption	2 months after end of consumption
mean	22.83	22.75	23.03	0.87	0.87	0.87
±SD	3.95	3.95	4.02	0.06	0.06	0.06
Max	35.50	35.19	35.96	1.00	1.01	1.02
Min	17.75	17.68	18.30	0.78	0.80	0.79
Med	21.62	21.61	21.69	0.85	0.86	0.86
p	0.1637	0.0033 ^a	0.0597	0.2550	0.5725	0.1110
significance		**				

Note: ±SD – standard deviation; Max – maximum value; Min – minimum value; Med – the median value of a range of values; VFA – visceral fat area, [cm²]; the levels of statistical significance chosen for the comparisons were $p < 0.05$ (*), $p < 0.01$ (**), $p < 0.001$ (***); ^a – intra-group differences after 6-weeks consumption of gluten-free bakery products; ^b – differences between baseline data and post-intervention data.

The high frequency of overweight patients in determining the diagnosis confirms the need for individual nutritional care (Brambilla et al., 2013). Loria-Kohen et al. (2012) recorded a significant reduction in BMI in both groups when comparing two groups with and without of bread consumption. Dickey and Kearney (2006) and Capristo et al. (2009) reported the increase of BMI during gluten-free diet. Zanini et al. (2013) found that during gluten-free diet the mean value of BMI increased significantly. The large majority of the patients remained in the same category as at baseline and 9% of patients moved from the underweight to the normal weight category. However, 8% of patients moved from normal to overweight/obese group.

Waist-to-hip ratio

Among the indices reflecting visceral fat accumulation, waist circumference or waist-to-hip ratio have been used for convenience. However, waist circumference includes both visceral and subcutaneous fat (Kuk et al., 2005). Waist-to-hip ratio (a trait of the criteria for metabolic syndrome) is more strongly related to the cardiovascular disease than BMI (St-Onge, Janssen and Heymsfield, 2004). Subjects with the WHR value 0.9 and higher are considered as the subjects suffer from abdominal obesity.

At the beginning of the study we found values higher than 0.9 in 23% of participants in the range of 0.91 – 1, the average value of the group was 0.87 ±0.06 (Figure 3, Table. 1).

During the study the WHR values did not significantly change, the mean WHR values were between 0.87 ±0.06. The Max and Min values of the observed parameter varied in the dynamics of the study by a more rising trend from 1.00 at the beginning of the study to 1.01 when the consumption of gluten-free bakery products was over, up to 1.02 at the end of the study (Min 0.78/0.8/0.79). Due to the consumption of gluten-free bakery products, the number of participants with abdominal obesity (23%) did not increase and two months after the end of the consumption the number of participants with WHR greater than 0.9 even decreased (20%). As shown in the Figure 3, during the consumption of gluten-free bakery products WHR increased in 43% of probands, decreased in 33% and in 23% of participants WHR did not change. Two months after the end of consumption, a further increase in WHR values occurred in 47% of participants and a decrease in 37% of participants. We compared the values of the observed parameter at the beginning and the end of the study and we found that 30% of the participants reduced their WHR values, 50% of participants increased their WHR values, and in 20% of probands the values remained unchanged.

Visceral fat area

The visceral fat area is defined as the cross-sectional area of the internal fat found in the abdomen. If VFA is greater than 100 cm² we talk about abdominal obesity

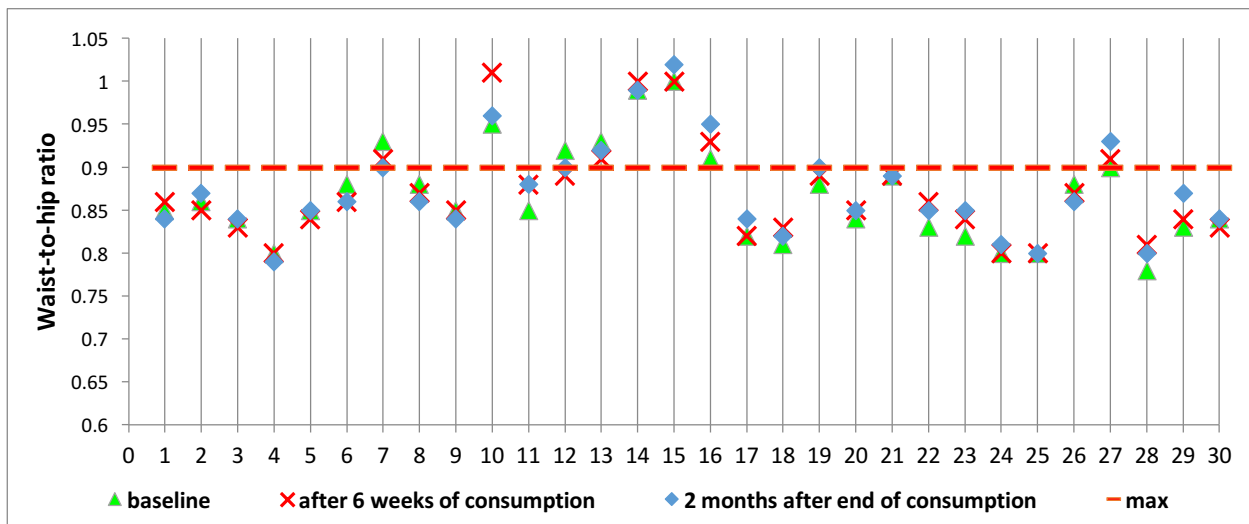

Figure 3 Changes of WHR during the study.

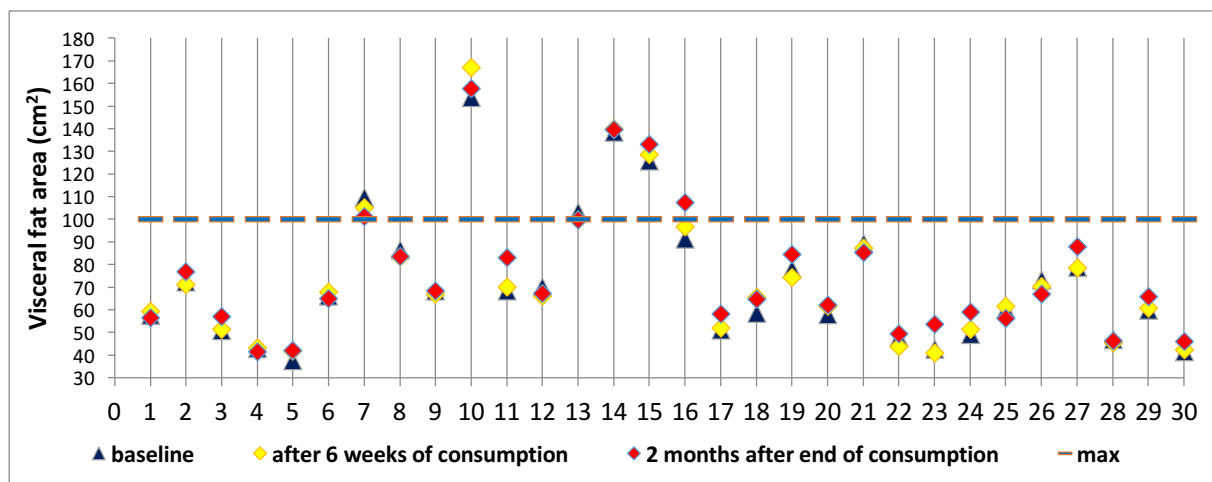

Figure 4 Changes of visceral fat area during the study in cm².

(Biospace, 2017). The visceral fat is deposited between the organs in the abdominal cavity where it is not normally present. In the case that this kind of fat is present in a higher amount, it is very dangerous and there is a risk of cardiovascular diseases, diabetes and the risk of the metabolic syndrome. Measurement of visceral fat area is also reported to be useful for predicting atherosclerosis (Fox et al., 2007). From the point of the risk assessment it is more important where the fat is stored and not its amount. Many studies have shown that the fat stored in the waist area represents a higher risk than the fat stored in the thighs, buttocks and loins. The visceral fat is hidden and therefore healthy and slim persons can suffer from it. It does not need to be produced only by increased energy intake, but paradoxically even at very low intake or even the energy intake is lower than the basal metabolic need.

Before the consumption of bread and bakery products five probands (17%) suffered from the abdominal obesity, their values were higher than 100 cm² (Figure 4, Table 1). The average value of the visceral fat area of all participants was 72.7 ± 29.18 cm² (the lowest value was 37,8 cm² and the highest value 153,94 cm²). At the same time we found value of VFA lower than 40 cm² which is undesirable from the endocrine side. It occurred only in one proband and only at the beginning of the study. After 6-weeks of gluten-free bread and bakery products consumption we

found that VFA values above 100 cm² had four participants, the increase in VFA values was observed in 57% of participants and decrease in 43% of participants.

Compared to the baseline values at the beginning of the study there was a statistically significant increase in VFA ($p < 0.05$), the mean value of the group increased to 73.26 ± 30.32 cm² (also the Max value to 167.22 cm², Min value to 41.07 cm²). The consumption of gluten-free bread and pastries may increase the area of visceral fat. Two months after the end of the gluten-free pastries consumption, the number of participants with abdominal obesity returned to the initial number (five participants). The mean value of the visceral fat area was 75.65 ± 29.01 cm² at the end of the study (Max VFA was significantly reduced to 157.86 cm² compared to the previous measurement, the Min VFA was 41.5 cm²). When comparing the initial and final values of VFA we found a significant increase ($p < 0.05$). Figure 4 shows changes in the visceral fat area throughout the study. During the consumption of gluten-free bread and bakery products the increase of visceral fat area was observed in 57% of participants in the range from 0.28 to 13.28 cm² and decrease in 43% of participants in the range of 0.28 – 4.39 cm². After releasing gluten-free bakery products we found in many participants a further increase in visceral fat area values (up to 67% of them) in the range of 0.12 – 12.85 cm². Two months after the end of the

consumption we recorded a reduction in visceral fat area in 33% of participants in the range of 0.12 – 9.36 cm². Compared with the baseline values at the end of the study we found a decrease in VFA in 37% of participants and an increase in 63% of them. According to **Vici et al. (2015)** with the consumption of gluten-free pastries is associated a higher risk of obesity due to the high glycemic index of gluten-free foods and also the high content of saturated fat. During the gluten-free diet, in many studies it was confirmed the inadequacies in the intake of some macronutrients and trace elements, mainly fiber, vitamin B₁₂, vitamin D, calcium, iron, zinc and magnesium. **Bautista-Castaño et al. (2013)** found that the different compositions of whole-grain and white bread have different influences on body weight and abdominal fat. This may be caused by factors such as postprandial insulin responses, gastric emptying after consuming a meal with high glycemic index and others (**Juntunen et al., 2002**). **Romaguera et al. (2011)** reported a direct association between the increase in white bread consumption and annual visceral adiposity gain, independent from BMI. Similar results were found in our survey, where we observed a higher increase in VFA values than BMI. Study results of authors **Bautista-Castaño et al. (2013)** suggest that reducing white bread, but not whole-grain bread consumption is associated with the lower gains in weight and abdominal fat. **Fuente-Arrillaga et al. (2014)** in their study found that participants in the highest category of white bread consumption (≥ 6 slices per day) showed a significantly increased risk of becoming overweight or obese and that a higher consumption of whole-grain bread was inversely associated with the risk of overweight and obesity although without statistically significant. Finally, it is important that the consumption of bread has continued to fall in the world over the past decades but world epidemic of obesity has been increasing (**WHO, 2000; Serra-Majem and Quintana, 2010**).

CONCLUSION

In our study we found that the 6-week consumption of gluten-free bread and bakery products had a significant reduction in the body weight and BMI ($p < 0.01$), but also had a significant increase in VFA ($p < 0.05$). WHR remained unchanged. Many people perceive benefit from the gluten-free products and diet often without a clear scientific explanation. There is no evidence that processed gluten-free foods are healthier than their gluten-containing counterparts.

REFERENCES

- Aston, L. M., Stokes, C. S., Jebb, S. A. 2008. No effect of a diet with a reduced glycaemic index on satiety, energy intake and body weight in overweight and obese women. *Int. J. Obes.*, vol. 32, p. 160-165. <https://doi.org/10.1038/sj.ijo.0803717>
 PMID:17923862
- Bansal, M., Gupta, R., Bansal, J. 2017. Celiac Disease: A Scientometric Analysis of World Publication Output, 2005-2014. *OGH Reports*, vol. 6, no. 1, p. 8-15. <https://doi.org/10.5530/ogh.2017.6.1.2>
- Bautista-Castaño, I., Sánchez-Villegas, A., Estruch, R., Martínez-González, M. A., Corella, D., Salas-Salvadó, J., Covas, M. I., Schroder, H., Alvarez-Pérez, J., Quilez, J., Lamuela-Raventós, R. M., Ros, E., Arós, F., Fiol, M., Lapetra, J., Muñoz, M. A., Gómez-Gracia, E., Tur, J., Pintó, X., Ruiz-Gutierrez, V., Portillo-Baquedano, M. P., Serra-Majem, L. 2013. Changes in bread consumption and 4-year changes in adiposity in Spanish subjects at high cardiovascular risk. *Br. J. Nutr.*, vol. 110, no. 2, p. 337-346. <https://doi.org/10.1017/S000711451200476X>
 PMID:23199451
- Biospace. 2017. Available on: <www.biospace.cz>
- Brambilla, P., Picca, M., Dilillo, D., Meneghin, F., Cravidi, C., Tischer, M. C., Vivaldo, T., Bedogni, G., Zuccotti, G. V. 2013. Changes of body mass index in celiac children on a gluten-free diet. *Nutrition Metabolism and Cardiovascular Diseases*, vol. 23, no. 3, p. 177-182. <http://dx.doi.org/10.1016/j.numecd.2011.10.002>
- Capristo, E., Malandrino, N., Farnetti, S., Mingrone, G., Leggio, L., Addolorato, G., Gasbarrini, G. 2009. Increased serum high-density lipoprotein-cholesterol concentration in coeliac disease after gluten-free diet treatment correlates with body fat stores. *Journal of Clinical Gastroenterology*, vol. 43, no. 10, p. 946-949. <https://doi.org/10.1097/MCG.0b013e3181978e4d>
- de la Fuente-Arrillaga, C., Martínez-González, M. A., Zazpe, I., Vazquez-Ruiz, Z., Benito-Corchon, S., Bes-Rastrollo, M. 2014. Glycemic load, glycemic index, bread and incidence of overweight/obesity in a Mediterranean cohort: the SUN project. *BMC Public Health*, vol. 14, no. 1091. <https://doi.org/10.1186/1471-2458-14-1091>
- Diamanti, A., Capriati, T., Basso, M. S., Panetta, F., Di Ciommo Laurora, V. M., Bellucci, F., Cristofori, F., Francavilla, R. 2014. Celiac Disease and Overweight in Children: An Update. *Nutrients*, vol. 6, no. 1, p. 207-220. <https://doi.org/10.3390/nu6010207>
- Dickey, W., Kearney, N. 2006. Overweight in coeliac disease: prevalence, clinical characteristics, and effect of a gluten-free diet. *American Journal of Gastroenterology*, vol. 101, p. 2356-2359. <https://doi.org/10.1111/j.1572-0241.2006.00750.x>
 PMID:17032202
- Fox, C. S., Massaro, J. M., Hoffmann, U., Pou, K. M., Maurovich-Horvat, P., Liu, C. Y., Vasan, R. S., Murabito, J. M., Meigs, J. B., Cupples, L. A., D'Agostino, R. B. Sr, O'Donnell, C. J. 2007. Abdominal visceral and subcutaneous adipose tissue compartments: Association with metabolic risk factors in the Framingham Heart Study. *Circulation*, vol. 116, no. 1, p. 39-48. <https://doi.org/10.1161/CIRCULATIONAHA.106.675355>
- Frič, P., Keil, R. 2011. Celiakie pro praxi. *Med. Praxi (Celiac disease for practice. Med. practice)*, vol. 8, no. 9, p. 354-359. (In Czech).
- Haas, S. V. The value of the banana in the treatment of coeliac disease. *American Journal of Diseased Child*, vol. 1924, no. 24, p. 421-437.
- Hamer, R. J. 2005. Coeliac disease: Background and biochemical aspects. *Biotechnology Advances*, vol. 23, no. 6, p. 401-408. <https://doi.org/10.1016/j.biotechadv.2005.05.005>
 PMID:16006084
- Hoffmanová, I., Sánchez, D. 2015. Neceliakálna gluténová senzitivita (Nonceliac glutene sensitivity). *Vnit. Lék.*, vol. 61, no. 3, p. 219-227. (In Czech)
- Chňapek, M., Tomka, M., Balážová, Ž., Gálová, Z. 2014. Protein complex of wheat, buckwheat and maize in relation to celiac disease. *J. M. B. F. S.*, vol. 3 (special issue 2), p. 88-92.
- Juntunen, K. S., Niskanen, L. K., Liukkonen, K. H., Poutanen, K. S., Holst, J. J., Mykkänen, H. M. 2002. Postprandial glucose, insulin, and incretin responses, grain products in healthy subjects. *Am. J. Clin. Nutr.*, vol. 75, no. 2, p. 254-262.
- Kolesárová, A., Zeleňáková, L., Gažarová, M., Cesneková, S. 2017. Konzumácia pekárskeho výrobkov. (Consumption of bakery products. Hygiene and Food Technology) In: Proceeding of: Hygiene a technologic potravín – XLVII. Lenfeldovy a Höklovy dny: sborník prednášiek a posterů, Veterinárni a farmaceutická univerzita Brno, 18.-19.10.2017. p. 165-170. ISBN 978-80-7305-793-0. (In Slovak)
- Kuk, J. L., Lee, S., Heymsfield, S. B., Ross, R. 2005. Waist circumference and abdominal adipose tissue distribution: Influence of age and sex. *The American Journal of Clinical Nutrition*, vol. 81, no. 6, p. 1330-1334.

- Kulai, T., Rashid, M. 2014. Assessment of Nutritional Adequacy of Packaged Gluten-free Food Products. *Can. J. Diet. Pract. Res.*, vol. 75, no. 4, p. 186-190. <https://doi.org/10.3148/cjdr-2014-022>
- Layman, D. K., Boileau, R. A., Erickson, D. J., Painter, J. E., Shiue, H., Sather, C., Christou, D. D. 2003. A reduced ratio of dietary carbohydrate to protein improves body composition and blood lipid profiles during weight loss in adult women. *J. Nutr.*, vol. 133, p. 411-417.
- Lean, M. E., Han, T. S., Prvan, T., Richmond, P. R., Avenell, A. 1997. Weight loss with high and low carbohydrate 1200 kcal diets in free living women. *Eur. J. Clin. Nutr.*, vol. 51, p. 243-248. <https://doi.org/10.1038/sj.ejcn.1600391>
PMid:9104574
- Loria-Kohen, V., Gomez-Candela, C., Fernandez-Fernandez, C., Perez-Torres, A., Garcia-Puig, J., Bermejo, L. M. 2012. Evaluation of the usefulness of a low-calorie diet with or without bread in the treatment of overweight/obesity. *Clinical Nutrition*, vol. 31, no. 4, p. 455-461. <https://doi.org/10.1016/j.clnu.2011.12.002>
- López Sobaler, A. M., Ortega, R. M., Aparicio, A., Bermejo, L. M., Rodríguez Rodríguez, E. 2007. Concerns about body weight. National study on related mistakes and habits. In: R. M. Ortega (Ed.) *Nutrition in the females population*. Madrid, Spain : Ergón, p. 39-50.
- Luscombe, N. D., Clifton, P. M., Noakes, M., Farnsworth, E., Wittert, G. 2003. Effect of a high protein, energy restricted diet on weight loss and energy expenditure after weight stabilization in hyperinsulinemic subjects. *Int J Obes.*, vol. 27, no. 582-590.
- Malinauskas, B. M., Raedeke, T. D., Aeby, V. G., Smith, J. L., Dallas, M. B. 2006. Dieting practices, weight perceptions, and body composition: a comparison of normal weight, overweight, and obese college females. *Nutr. J.*, vol. 5, 11. <https://doi.org/10.1186/1475-2891-5-11>
PMid:16579846
- Missbach, B., Schwingshackl, L., Billmann, A., Mystek, A., Hickelsberger, M., Bauer, G., Konig, J. 2015. Gluten-free food database: the nutritional quality and cost of packaged gluten-free foods. *Peer J.*, vol. 3, 1337. <https://doi.org/10.7717/peerj.1337>
- Nanditha, B., Prabhasankar, P. 2009. Antioxidants in bakery products: A review. *Critical Reviews in Food Science and Nutrition*, vol. 49, no. 1, p. 1-27. <https://doi.org/10.1080/10408390701764104>
PMid:18949596
- Noakes, M., Keogh, J. B., Foster, P. R., Clifton, P. M. 2005. Effect of an energy-restricted, high-protein, low-fat diet relative to a conventional high-carbohydrate, low-fat diet on weight loss, body composition, nutritional status, and markers of cardiovascular health in obese women. *Am. J. Clin. Nutr.*, vol. 81, no. 6, p. 1298-1306. PMid:15941879
- Penagini, F., Dilillo, D., Meneghin, F., Mameli, C., Fabiano, V., Zuccotti, G. V. 2013. Gluten-free diet in children: an approach to a nutritionally adequate and balanced diet. *Forum Nutr.*, vol. 5, no. 11, p. 4553-4565. <https://doi.org/10.3390/nu5114553>
- Reilly, N. 2016. The Gluten-Free Diet: Recognizing Fact, Fiction, and Fad. *Journal of Pediatrics*, vol. 175, p. 206-210. <http://dx.doi.org/10.1016/j.jpeds.2016.04.014>
- Romaguera, D., Ångquist, L., Du, H., Jakobsen, M. U., Forouhi, N. G., Halkjær, J., Feskens, E. J., van der A, D. L., Masala, G., Steffen, A., Palli, D., Wareham, N. J., Overvad, K., Tjønneland, A., Boeing, H., Riboli, E., Sørensen, T. I. 2011. Food composition of the diet in relation, changes in waist circumference adjusted for body mass index. *PLoS One*, vol. 6, no. 8, p. e23384. <https://doi.org/10.1371/journal.pone.0023384>
- Salazar Quero, J. C., Espín Jaime, B., Rodríguez Martínez, A., Argüelles Martín, F., García Jiménez, R., Rubio Murillo, M., Pizarro Martín, A. 2015. Nutritional assessment of gluten-free diet. Is gluten-free diet in some nutrient. *An. Pediatr. (Barc.)*, vol. 83, no. 1, p. 33-39. <https://doi.org/10.1016/j.anpedi.2014.08.011>
- Serra-Majem, L., Raido Quintana, B. 2010. Consumo de pan en el mundo y en España (Bread consumption in the world and in Spain). In Gil, A., Serra-Majem, L. *Libro Blanco del Pan (Bread's White Book)*, pp. 63-77. Madrid, Spain : Ed Med Panamericana. (In Spain)
- Socha, P., Raždíková, A., Urminská, D. 2010. Optimalizácia stanovenia celiakálne aktívnych bielkovín v cereáliách a pseudocereáliách (optimization of celiac disease active proteins estimation in cereals and pseudocereals). *Potravinarstvo*, vol. 4 (special issue February 2010), p. 497-508. (In Slovak) Available at: https://www.potravinarstvo.com/dokumenty/mc_februar_2010/pdf/5/Socha.pdf
- St-Onge, M. P., Janssen, I., Heymsfield, S. B. 2004. Metabolic syndrome in normalweight Americans: new definition of the metabolically obese, normalweight individual. *Diabetes Care*, vol. 27, no. 9, p. 2222-2228. <https://doi.org/10.2337/diacare.27.9.2222>
PMid:15333488
- Suchá, V., Jurgoš, L., Dostálová, K., Móricaová, Š. 2015. Aktuálny pohľad na Celiakiu. *Via pract.*, vol. 12, no. 1, p. 22-28.
- Ukkola, A., Mäki, M., Kurppa, K., Collin, P., Huhtala, H., Kekkonen, L., Kaukinen, K. 2012. Changes in body mass index on a gluten-free diet in coeliac disease: a nationwide study. *Eur. J. Intern. Med.*, vol. 23, no. 4, p. 384-388. <https://doi.org/10.1016/j.ejim.2011.12.012>
- Vici, G., Belli, L., Biondi, M., Polzonetti, V. 2016. Gluten free diet and nutrient deficiencies: A review. *Clin. Nutr.*, vol. 35, no. 6, p. 1236-1241. <https://doi.org/10.1016/j.clnu.2016.05.002>
- Wiklund, P., Alen, M., Munukka, E., Cheng, S. M., Yu, B., Pekkala, S., Cheng, S. 2014. Metabolic response to 6-week aerobic exercise training and dieting in previously sedentary overweight and obese pre-menopausal women: A randomized trial. *Journal of Sport and Health Science*, vol. 3, no. 3 p. 217-224. <http://dx.doi.org/10.1016/j.jshs.2014.03.013>
- World Health Organization. 2000. *Obesity: Preventing and Managing the Global Epidemic*. Report of a WHO Consultation. WHO Technical Report Series no. 894. Geneva, Switzerland : WHO.
- World Health Organization. 2008. *Obesity and overweight*. Geneva, Switzerland : WHO. Available at:
- Yancy, W. S. Jr., Olsen, M. K., Guyton, J. R., Bakst, R. P., Westman, E. C. 2004. A low-carbohydrate, ketogenic diet versus a low-fat diet to treat obesity and hyperlipidemia. *Ann. Intern. Med.*, vol. 140, no. 10, p. 769-777.
- Zanini, B., Mazzoncin, E., Lanzarotto, F., Ricci, C., Cesana, B. M., Villanacci, V., Lanzini, A. 2013. Impact of gluten-free diet on cardiovascular risk factors. A retrospective analysis in a large cohort of coeliac patients. *Dig. Liver Dis.*, vol. 45, no. 10, p. 810-815. <https://doi.org/10.1016/j.dld.2013.04.001>

Acknowledgments:

This study was supported by the Únia priemyselných pekárov Slovenska and by the project ITEBIO (ITMS 26220220115). We thank especially to Mr. Vladislav Baričák, all participants of the study and the staff of the Department of Human Nutrition at Slovak University of Agriculture in Nitra Slovakia.

Contact address:

Ing. Martina Gažarová, PhD., Slovak University of Agriculture in Nitra, Department of Human Nutrition, Faculty of Agrobiological and Food Resources, Tr. A. Hlinku 2, 949 76 Nitra, E-mail: martina.gazarova@gmail.com

Ing. Zuzana Chlebová, Slovak University of Agriculture in Nitra, Department of Human Nutrition, Faculty of

Agrobiology and Food Resources, Tr. A. Hlinku 2, 949 76
Nitra, E-mail: chlebova.z@gmail.com

Ing. Jana Kopčeková, PhD., Slovak University of
Agriculture in Nitra, Department of Human Nutrition, Faculty
of Agrobiology and Food Resources, Tr. A. Hlinku 2, 949 76
Nitra, E-mail: jana.kopcekova@gmail.com

Ing. Petra Lenártová, PhD., Slovak University of Agriculture
in Nitra, Department of Human Nutrition, Faculty of

Agrobiology and Food Resources, Tr. A. Hlinku 2, 949 76
Nitra, E-mail: petra.lenartova@uniag.sk

Ing. Mária Holovičová, Slovak University of Agriculture in
Nitra, Department of Human Nutrition, Faculty of
Agrobiology and Food Resources, Tr. A. Hlinku 2, 949 76
Nitra, E-mail: mariaholovicova23@gmail.com

H A C C P

C O N S U L T I N G

PODPORUJEME VEDU A VÝSKUM

www.haccp.sk

Table of Contents

PUBLISHED: 31. January 2017

EVALUATION OF THE PRESSING PROCESS DURING OIL EXTRACTION FROM GRAPE SEEDS

Patrik Burg, Vladimír Mašán, Kazimierz Rutkowski

Potravinárstvo Slovak Journal of Food Sciences, vol. 11, no. 1, 2017, p. 1-6

[\[abstract\]](#) doi: <https://dx.doi.org/10.5219/690> [\[fulltext\]](#)

STUDY ON FATTY ACIDS COMPOSITION OF LIPID CLASS IN FISH OIL, PROXIMATE ANALYSIS AND CALORIE VALUE OF KIJAR IN IRAN

Ali Aberoumand, Narges Mohamedi, Maryem Zemanpoor

Potravinárstvo Slovak Journal of Food Sciences, vol. 11, no. 1, 2017, p. 7-10

[\[abstract\]](#) doi: <https://dx.doi.org/10.5219/418> [\[fulltext\]](#)

EFFECTIVENESS OF A DEVELOPED POTATO STORAGE SYSTEM IN SHELF LIFE AND NUTRITIONAL QUALITY COMPARED TO TRADITIONAL PRACTICE IN BANGLADESH

Fahad Jubayer, Burhan Uddin, A. T. M. Ziauddin

Potravinárstvo Slovak Journal of Food Sciences, vol. 11, no. 1, 2017, p. 11-19

[\[abstract\]](#) doi: <https://dx.doi.org/10.5219/659> [\[fulltext\]](#)

COPPER CONTENT IN CEREALS GROWN IN THE MODEL CONDITION

Luboš Harangozo, Peter Lazor, Miriama Kopernická, Pavol Trebichalský, Janette Musilová, Július Árvay, Daniel Bajčan

Potravinárstvo Slovak Journal of Food Sciences, vol. 11, no. 1, 2017, p. 20-25

[\[abstract\]](#) doi: <https://dx.doi.org/10.5219/693> [\[fulltext\]](#)

EVALUATION OF TOTAL POLYPHENOL CONTENT AND ANTIOXIDANT CAPACITY OF DIFFERENT VARIETY LUPIN SEEDS

Ismael Sullaiman Dalaram

Potravinárstvo Slovak Journal of Food Sciences, vol. 11, no. 1, 2017, p. 26-34

[\[abstract\]](#) doi: <https://dx.doi.org/10.5219/678> [\[fulltext\]](#)

NUTRITIONAL AND TOXICOLOGICAL COMPOSITION ANALYSIS OF SELECTED CASSAVA PROCESSED PRODUCTS

Kuda Dewage Supun Charuni Nilangeka Rajapaksha, Madame Arachchige Dulani Somendrika, Indira Wickramasinghe

Potravinárstvo Slovak Journal of Food Sciences, vol. 11, no. 1, 2017, p. 35-42

[\[abstract\]](#) doi: <https://dx.doi.org/10.5219/689> [\[fulltext\]](#)

QUALITY CHANGES OF LONG-LIFE FOODS DURING THREE-MONTH STORAGE AT DIFFERENT TEMPERATURES

Zuzana Bubelová, Michaela Černíková, Leona Buňková, Jaroslav Talár, Václav Zajíček, Pavel Foltin, František Buňka

Potravinárstvo Slovak Journal of Food Sciences, vol. 11, no. 1, 2017, p. 43-51

[\[abstract\]](#) doi: <https://dx.doi.org/10.5219/688> [\[fulltext\]](#)

POLYPHENOLS CONTENT AND ANTIOXIDANT ACTIVITY OF PAPRIKA AND PEPPER SPICES

Soňa Škrovánková, Jiří Mlček, Jana Orsavová, Tünde Juríková, Pavla Dřimalová

Potravinárstvo Slovak Journal of Food Sciences, vol. 11, no. 1, 2017, p. 52-57

[\[abstract\]](#) doi: <https://dx.doi.org/10.5219/695> [\[fulltext\]](#)

INFLUENCE OF SELENIUM AND VITAMIN E SUPPLEMENTATION DURING PREGNANCY ON UDDER HEALTH AND MILK QUALITY IN DAIRY COWS AT PARTURITION

František Zigo, Milan Vasil', Zuzana Farkašová, Martina Zigová, Juraj Elečko

Potravinarstvo Slovak Journal of Food Sciences, vol. 11, no. 1, 2017, p. 58-64

[\[abstract\]](#) doi: <https://dx.doi.org/10.5219/694> [\[fulltext\]](#)

EVALUATION AND COMPARISON OF THE CONTENT OF TOTAL POLYPHENOLS AND ANTIOXIDANT ACTIVITY IN GARLIC (*ALLIUM SATIVUM* L.)

Marianna Lenková, Judita Bystrická, Alena Vollmannová, Tomáš Tóth, Ján Kovarovič

Potravinarstvo Slovak Journal of Food Sciences, vol. 11, no. 1, 2017, p. 65-70

[\[abstract\]](#) doi: <https://dx.doi.org/10.5219/698> [\[fulltext\]](#)

ASSESSMENT OF THE ANTIOXIDANT ACTIVITY AND CONTENT OF POLYPHENOLIC COMPOUNDS IN GRAPEVINE SEEDS

Lenka Tomášková, Jiří Sochor, Mojmir Baroň

Potravinarstvo Slovak Journal of Food Sciences, vol. 11, no. 1, 2017, p. 71-76

[\[abstract\]](#) doi: <https://dx.doi.org/10.5219/712> [\[fulltext\]](#)

PUBLISHED: 22. March 2017

THE CONTENT OF TOTAL POLYPHENOLS, ASCORBIC ACID AND ANTIOXIDANT ACTIVITY IN SELECTED VARIETIES OF QUINCE (*CYDONIA OBLONGA* MILL.)

Judita Bystrická, Janette Musilová, Helena Lichtnerová, Marianna Lenková, Ján Kovarovič, Marek Chalas

Potravinarstvo Slovak Journal of Food Sciences, vol. 11, no. 1, 2017, p. 77-81

[\[abstract\]](#) doi: <https://dx.doi.org/10.5219/699> [\[fulltext\]](#)

POLYPHENOLS AND PHENOLIC ACIDS IN SWEET POTATO (*IPOMOEA BATATAS* L.) ROOTS

Janette Musilová, Judita Bystrická, Július Árvay, Ľuboš Harangozó

Potravinarstvo Slovak Journal of Food Sciences, vol. 11, no. 1, 2017, p. 82-87

[\[abstract\]](#) doi: <https://dx.doi.org/10.5219/705> [\[fulltext\]](#)

EFFECT OF PROTEIN CONCENTRATE SUPPLEMENTATION ON THE COMPOSITION OF AMINO ACIDS IN MILK FROM DAIRY COWS IN AN ORGANIC FARMING SYSTEM

Pavel Horký, Jiří Skládanka, Pavel Nevrkla, Daniel Falta, Iva Čáslavová, Pavel Knot

Potravinarstvo Slovak Journal of Food Sciences, vol. 11, no. 1, 2017, p. 88-95

[\[abstract\]](#) doi: <https://dx.doi.org/10.5219/707> [\[fulltext\]](#)

COMPARISON OF ADSORPTIVE WITH EXTRACTIVE STRIPPING VOLTAMMETRY IN ELECTROCHEMICAL DETERMINATION OF RETINOL

Milan Sýs, Simona Žabčíková, Libor Červenka, Karel Vytřas

Potravinarstvo Slovak Journal of Food Sciences, vol. 11, no. 1, 2017, p. 96-105

[\[abstract\]](#) doi: <https://dx.doi.org/10.5219/713> [\[fulltext\]](#)

THE INFLUENCE OF VARIETY ON THE CONTENT OF BIOACTIVE COMPOUNDS IN BEETROOT (*BETA VULGARIS* L.)

Ján Kovarovič, Judita Bystrická, Ján Tomáš, Marianna Lenková

Potravinarstvo Slovak Journal of Food Sciences, vol. 11, no. 1, 2017, p. 106-112

[\[abstract\]](#) doi: <https://dx.doi.org/10.5219/702> [\[fulltext\]](#)

IMPACT OF NUTRITION ON THE QUALITY AND QUANTITY OF CAULIFLOWER FLORETS

Anton Uher, Ivana Mezeyová, Alžbeta Hegedúsová, Miroslav Šlosár

Potravinarstvo Slovak Journal of Food Sciences, vol. 11, no. 1, 2017, p. 113-119

[\[abstract\]](#) doi: <https://dx.doi.org/10.5219/723> [\[fulltext\]](#)

THE EFFECT OF CALCIUM AND MAGNESIUM SUPPLEMENTATION ON PERFORMANCE AND BONE STRENGTH OF BROILER CHICKENS

Filip Karásek, Hana Štenclová, Ondřej Štastník, Eva Mrkvicová, Leoš Pavlata, Šárka Nedomová, Ladislav Zeman

Potravinarstvo Slovak Journal of Food Sciences, vol. 11, no. 1, 2017, p. 120-125

[\[abstract\]](#) doi: <https://dx.doi.org/10.5219/710> [\[fulltext\]](#)

GENETIC VARIATION OF EUROPEAN MAIZE GENOTYPES (*ZEAMAYS* L.) DETECTED USING SSR MARKERS

Martin Vivodík, Zdenka Gálová, Želmíra Balážová, Lenka Petrovičová

Potravinarstvo Slovak Journal of Food Sciences, vol. 11, no. 1, 2017, p. 126-131

[\[abstract\]](#) doi: <https://dx.doi.org/10.5219/697> [\[fulltext\]](#)

THE STUDY OF ANTIOXIDANTS IN GRAPEVINE SEEDS

Lenka Tomášková, Jiří Sochor, Mojmír Baroň

Potravinarstvo Slovak Journal of Food Sciences, vol. 11, no. 1, 2017, p. 132-137

[\[abstract\]](#) doi: <https://dx.doi.org/10.5219/711> [\[fulltext\]](#)

PRINCIPAL COMPONENT ANALYSIS OF SENSORY PROPERTIES OF CHICKEN BREAST MUSCLE SUPPLEMENTED WITH DIFFERENT FEED ADDITIVES

Peter Haščík, Lenka Trembecká, Tomáš Fekete, Juraj Čuboň, Marek Bobko, Miroslav Kročko

Potravinarstvo Slovak Journal of Food Sciences, vol. 11, no. 1, 2017, p. 138-144

[\[abstract\]](#) doi: <https://dx.doi.org/10.5219/750> [\[fulltext\]](#)

THE EFFECT OF FEEDING WHEAT VARIETIES WITH DIFFERENT GRAIN PIGMENTATION ON GROWTH PERFORMANCE, TEXTURE, COLOUR AND MEAT SENSORY TRAITS OF BROILER CHICKENS

Ondřej Štastník, Filip Karásek, Miroslav Jůzl, Eva Mrkvicová, Leoš Pavlata, Šárka Nedomová, Václav Trojan, Tomáš Vyhnánek, Petr Doležal, Petr Martinek

Potravinarstvo Slovak Journal of Food Sciences, vol. 11, no. 1, 2017, p. 145-150

[\[abstract\]](#) doi: <https://dx.doi.org/10.5219/753> [\[fulltext\]](#)

PUBLISHED: 26. April 2017

EFFECT OF SHORT-TERM CONSUMPTION BITTER APRICOT SEEDS ON THE BODY COMPOSITION IN HEALTHY POPULATION

Jana Kopčėková, Anna Kolesárová, Martina Gažarová, Petra Lenártová, Jana Mrázová, Adriana Kolesárová

Potravinarstvo Slovak Journal of Food Sciences, vol. 11, no. 1, 2017, p. 151-155

[\[abstract\]](#) doi: <https://dx.doi.org/10.5219/718> [\[fulltext\]](#)

HORMONAL CHANGES IN SPRING BARLEY AFTER TRIAZINE HERBICIDE TREATMENT AND ITS MIXTURES OF REGULATORS OF POLYAMINE BIOSYNTHESIS

Pavol Trebichalský, Tomáš Tóth, Daniel Bajčan, Ľuboš Harangozo, Alena Vollmannová

Potravinarstvo Slovak Journal of Food Sciences, vol. 11, no. 1, 2017, p. 156-161

[\[abstract\]](#) doi: <https://dx.doi.org/10.5219/719> [\[fulltext\]](#)

CHARACTERISTICS OF STARCH BREADS ENRICHED WITH RED POTATOES

Dorota Gumul, Wiktor Berski, Eva Ivanišová, Halina Gambuś, Miroslava Kačániová, Ľuboš Harangozo, Marián Tokár

Potravinarstvo Slovak Journal of Food Sciences, vol. 11, no. 1, 2017, p. 162-166

[\[abstract\]](#) doi: <https://dx.doi.org/10.5219/720> [\[fulltext\]](#)

MICROBIOLOGICAL QUALITY OF CHICKEN BREAST MEAT AFTER APPLICATION OF THYME AND CARAWAY ESSENTIAL OILS

Simona Kunová, Lucia Zeleňáková, Ľubomír Lopašovský, Martin Mellen, Jozef Čapla, Peter Zajác, Miroslava Kačániová
Potravinárstvo Slovak Journal of Food Sciences, vol. 11, no. 1, 2017, p. 167-174

[\[abstract\]](#) doi: <https://dx.doi.org/10.5219/759> [\[fulltext\]](#)

THE REGULATION OF THE FUNCTIONAL STATE OF SUBTROPICAL CROPS WITH MICRONUTRIENTS

Alexej Ryndín, Oksana Belous, Yuliya Abilfazova, Zoya Prytula

Potravinárstvo Slovak Journal of Food Sciences, vol. 11, no. 1, 2017, p. 175-182

[\[abstract\]](#) doi: <https://dx.doi.org/10.5219/669> [\[fulltext\]](#)

CHARACTERIZATION OF BIOACTIVE COMPOUNDS FROM *MONASCUS PURPUREUS* FERMENTED DIFFERENT CEREAL SUBSTRATES

Eva Ivanišová, Martin Rajtar, Helena Frančáková, Marián Tokár, Štefan Dráb, Maciej Kluz, Miroslava Kačániová

Potravinárstvo Slovak Journal of Food Sciences, vol. 11, no. 1, 2017, p. 183-189

[\[abstract\]](#) doi: <https://dx.doi.org/10.5219/722> [\[fulltext\]](#)

EFFECT OF DNA EXTRACTION METHOD IN THE *ROSA CANINA* L. IDENTIFICATION UNDER DIFFERENT PROCESSING TEMPERATURE

Jana Žiarovská, Matúš Kysel', Radka Cimermanová, Ľudmila Knoteková

Potravinárstvo Slovak Journal of Food Sciences, vol. 11, no. 1, 2017, p. 190-196

[\[abstract\]](#) doi: <https://dx.doi.org/10.5219/717> [\[fulltext\]](#)

DETECTION GENETIC VARIABILITY OF *SECALE CEREALE* L. BY SCOT MARKERS

Lenka Petrovičová, Želmíra Balážová, Martin Vivodík, Zdenka Gálová

Potravinárstvo Slovak Journal of Food Sciences, vol. 11, no. 1, 2017, p. 197-202

[\[abstract\]](#) doi: <https://dx.doi.org/10.5219/726> [\[fulltext\]](#)

STUDY OF RHEOLOGY AND FRICTION FACTOR OF NATURAL FOOD HYDROCOLLOID GELS

Vojtěch Kumbár, Šárka Nedomová, Roman Pytel, Libor Kilián, Jaroslav Buchar

Potravinárstvo Slovak Journal of Food Sciences, vol. 11, no. 1, 2017, p. 203-209

[\[abstract\]](#) doi: <https://dx.doi.org/10.5219/735> [\[fulltext\]](#)

THE IMPACT OF VARIETIES, RIPENESS, AND HEAT TREATMENT ON THE RETENTION OF VITAMIN C AND CONTENT OF SOLUBLE SOLIDS IN SWEET PEPPER

Magdaléna Valšíková, Marián Rehuš, Patrik Komár, Oleg Paulen

Potravinárstvo Slovak Journal of Food Sciences, vol. 11, no. 1, 2017, p. 210-215

[\[abstract\]](#) doi: <https://dx.doi.org/10.5219/754> [\[fulltext\]](#)

PHYSICO-CHEMICAL CHARACTERISATION OF SLOVAK WINES

Barbora Lapčíková, Ľubomír Lapčík, Jana Hupková

Potravinárstvo Slovak Journal of Food Sciences, vol. 11, no. 1, 2017, p. 216-222

[\[abstract\]](#) doi: <https://dx.doi.org/10.5219/727> [\[fulltext\]](#)

ANTIBACTERIAL ACTIVITY OF *CAPSICUM* EXTRACT AGAINST SELECTED STRAINS OF BACTERIA AND MICROMYCETES

Peter Popelka, Pavlína Jevinová, Karel Šmejkal, Pavol Roba

Potravinárstvo Slovak Journal of Food Sciences, vol. 11, no. 1, 2017, p. 223-229

[\[abstract\]](#) doi: <https://dx.doi.org/10.5219/731> [\[fulltext\]](#)

ANTIMICROBIAL EFFECT OF SELECTED LACTIC ACID BACTERIA AGAINST MICROORGANISMS WITH DECARBOXYLASE ACTIVITY

Khatantuul Purevdorj, Kristýna Maršálková, Iva Březinová, Adéla Žalková, Pavel Pleva, Leona Buňková

Potravinarstvo Slovak Journal of Food Sciences, vol. 11, no. 1, 2017, p. 230-235

[\[abstract\]](#) doi: <https://dx.doi.org/10.5219/740> [\[fulltext\]](#)

QUALITY DETERMINATION OF VEGETABLE OILS USED AS AN ADDITION TO FERMENTED MEAT PRODUCTS WITH DIFFERENT STARTER CULTURES

Hana Šulcerová, Tomáš Gregor, Radka Burdychová

Potravinarstvo Slovak Journal of Food Sciences, vol. 11, no. 1, 2017, p. 236-243

[\[abstract\]](#) doi: <https://dx.doi.org/10.5219/745> [\[fulltext\]](#)

DOES APRICOT SEEDS CONSUMPTION CAUSE CHANGES IN HUMAN URINE?

Eva Tušimová, Anton Kováčik, Marek Halenár, Katarína Michalcová, Katarína Zbyňovská, Anna Kolesárová, Jana Kopčeková, Jozef Valuch, Adriana Kolesárová

Potravinarstvo Slovak Journal of Food Sciences, vol. 11, no. 1, 2017, p. 244-251

[\[abstract\]](#) doi: <https://dx.doi.org/10.5219/755> [\[fulltext\]](#)

LINSEED FIBRE – EFFECT ON COMPOSITE FLOUR PROPERTIES AND CEREAL PRODUCTS QUALITY

Marie Hrušková, Ivan Švec

Potravinarstvo Slovak Journal of Food Sciences, vol. 11, no. 1, 2017, p. 252-259

[\[abstract\]](#) doi: <https://dx.doi.org/10.5219/729> [\[fulltext\]](#)

PUBLISHED: 23. May 2017

SELECTED PARAMETERS OF ARABICA COFFEE QUALITY AFFECTED BY ITS GEOGRAPHICAL ORIGIN

Alica Bobková, Martina Fikselová, Marek Šnirc

Potravinarstvo Slovak Journal of Food Sciences, vol. 11, no. 1, 2017, p. 260-265

[\[abstract\]](#) doi: <https://dx.doi.org/10.5219/794> [\[fulltext\]](#)

ANTIOXIDANT PROPERTIES, TOTAL PHENOLIC AND TOTAL FLAVONOID CONTENT OF THE SLOVAK WHITE WINES – WELSCHRIESLING AND CHARDONNAY

Daniel Bajčan, Július Árvay, Alena Vollmannová, Judita Bystrická, Pavol Trebichalský, Ľuboš Harangozo, Vladimír Šimanský

Potravinarstvo Slovak Journal of Food Sciences, vol. 11, no. 1, 2017, p. 266-271

[\[abstract\]](#) doi: <https://dx.doi.org/10.5219/730> [\[fulltext\]](#)

THE CONTENT OF POLYPHENOLS AND CHOSEN HEAVY METALS IN FABA BEAN (FABA VULGARIS MOENCH) RELATING TO DIFFERENT DOSES OF ZINC APPLICATION

Mária Timoracká, Alena Vollmannová, Dalaram Sulaiman Ismael

Potravinarstvo Slovak Journal of Food Sciences, vol. 11, no. 1, 2017, p. 272-278

[\[abstract\]](#) doi: <https://dx.doi.org/10.5219/638> [\[fulltext\]](#)

THE INFLUENCE OF SOME SELECTED VARIABLES FROM ACCOUNTING SYSTEM ON PROFIT OR LOSS OF AGRICULTURAL COMPANIES IN THE SLOVAK REPUBLIC

Alexandra Ferenczi Vaňová, Renáta Krajčírová, Michal Munk, Iveta Košovská, Ivana Váryová

Potravinarstvo Slovak Journal of Food Sciences, vol. 11, no. 1, 2017, p. 279-287

[\[abstract\]](#) doi: <https://dx.doi.org/10.5219/777> [\[fulltext\]](#)

MORPHOMETRIC CHARACTERISTICS OF SWEET CHESTNUT (CASTANEA SATIVA MILL.) FRUITS

Oľga Grygorieva, Svitlana Klymen, Ján Brindza, Zuzana Schubertová, Nataliia Nikolaiev, Jana Šimková

Potravinarstvo Slovak Journal of Food Sciences, vol. 11, no. 1, 2017, p. 288-295

[\[abstract\]](#) doi: <https://dx.doi.org/10.5219/684> [\[fulltext\]](#)

EFFECT OF RIPENING TIME ON COLOUR AND TEXTURE PROPERTIES IN CHEESE

Šárka Nedomová, Libor Kilián, Roman Pytel, Vojtěch Kumbár

Potravinárstvo Slovak Journal of Food Sciences, vol. 11, no. 1, 2017, p. 296-301

[\[abstract\]](#) doi: <https://dx.doi.org/10.5219/744> [\[fulltext\]](#)

BIOGENIC AMINES DEGRADATION BY MICROORGANISMS ISOLATED FROM CHEESE

Irena Butor, Hana Pištěková, Khatantuul Purevdorj, Petra Jančová, František Buňka, Leona Buňková

Potravinárstvo Slovak Journal of Food Sciences, vol. 11, no. 1, 2017, p. 302-308

[\[abstract\]](#) doi: <https://dx.doi.org/10.5219/736> [\[fulltext\]](#)

EFFECT OF APRICOT SEEDS ON RENAL STRUCTURE OF RABBITS

Anna Kolesárová, Juraj Pivko, Marek Halenár, Katarína Zbyňovská, Ľubica Chrastinová, Ľubomír Ondruška, Rastislav Jurčík, Jana Kopčeková, Jozef Valuch, Adriana Kolesárová

Potravinárstvo Slovak Journal of Food Sciences, vol. 11, no. 1, 2017, p. 309-314

[\[abstract\]](#) doi: <https://dx.doi.org/10.5219/751> [\[fulltext\]](#)

ORAL AND INTRAMUSCULAR APPLICATION OF CYANOGENIC GLYCOSIDE AMYGDALIN DID NOT INDUCE CHANGES IN HAEMATOLOGICAL PROFILE OF MALE RABBITS

Katarína Zbyňovská, Marek Halenár, Ľubica Chrastinová, Ľubomír Ondruška, Rastislav Jurčík, Peter Čupka, Eva Tušimová, Anton Kováčik, Eduard Kolesár, Jozef Valuch, Adriana Kolesárová

Potravinárstvo Slovak Journal of Food Sciences, vol. 11, no. 1, 2017, p. 315-321

[\[abstract\]](#) doi: <https://dx.doi.org/10.5219/756> [\[fulltext\]](#)

INFLUENCE OF ESSENTIAL OILS ON THE GROWTH OF ASPERGILLUS FLAVUS

Denisa Foltinová, Dana Tančinová, Miroslava Císarová

Potravinárstvo Slovak Journal of Food Sciences, vol. 11, no. 1, 2017, p. 322-331

[\[abstract\]](#) doi: <https://dx.doi.org/10.5219/725> [\[fulltext\]](#)

MOLECULAR VARIABILITY OF OAT BASED ON GENE SPECIFIC MARKERS

Želmíra Balážová, Zdenka Gálová, Martin Vivodík, Lenka Petrovičová, Radomíra Hornyák Gregáňová

Potravinárstvo Slovak Journal of Food Sciences, vol. 11, no. 1, 2017, p. 332-337

[\[abstract\]](#) doi: <https://dx.doi.org/10.5219/774> [\[fulltext\]](#)

DETECTION OF OVINE MILK ADULTERATION USING TAQMAN REAL-TIME PCR ASSAY

Marek Šnirc, Tomáš Fekete, Ľubomír Belej, Radoslav Židek, Jozef Golian, Peter Haščík, Peter Zajác, Jozef Čapla

Potravinárstvo Slovak Journal of Food Sciences, vol. 11, no. 1, 2017, p. 338-343

[\[abstract\]](#) doi: <https://dx.doi.org/10.5219/782> [\[fulltext\]](#)

NITRATE AND NITRITE CONTENTS IN IN THE PRIVATE GROUND WATER WELLS

Mária Angelovičová, Zuzana Szabóová, Jana Tkáčová, Marek Angelovič

Potravinárstvo Slovak Journal of Food Sciences, vol. 11, no. 1, 2017, p. 344-354

[\[abstract\]](#) doi: <https://dx.doi.org/10.5219/757> [\[fulltext\]](#)

QUANTITATIVE REAL-TIME PCR DETECTION OF PUTRESCINE-PRODUCING GRAM-NEGATIVE BACTERIA

Kristýna Maršáľková, Khatantuul Purevdorj, Petra Jančová, Hana Pištěková, Leona Buňková

Potravinárstvo Slovak Journal of Food Sciences, vol. 11, no. 1, 2017, p. 355-362

[\[abstract\]](#) doi: <https://dx.doi.org/10.5219/739> [\[fulltext\]](#)

EFFECT OF MILK ORIGIN ON PROTEOLYSIS AND ACCUMULATION OF BIOGENIC AMINE DURING RIPENING OF DUTCH-TYPE CHEESE

Vendula Pachlová, Zuzana Charousová, Tomáš Šopík

Potravinárstvo Slovak Journal of Food Sciences, vol. 11, no. 1, 2017, p. 363-367

[\[abstract\]](#) doi: <https://dx.doi.org/10.5219/741> [\[fulltext\]](#)

QUALITY PARAMETERS OF CURD

Roman Pytel, Šárka Nedomová, Vojtěch Kumbár, Libor Kilián

Potravinarstvo Slovak Journal of Food Sciences, vol. 11, no. 1, 2017, p. 368-372

[\[abstract\]](#) doi: <https://dx.doi.org/10.5219/742> [\[fulltext\]](#)

EFFECT OF PUMPKIN POWDER INCORPORATION ON COOKING AND SENSORY PARAMETERS OF PASTA

Lucia Minarovičová, Michaela Lauková, Zlatica Kohajdová, Jolana Karovičová, Veronika Kuchtová

Potravinarstvo Slovak Journal of Food Sciences, vol. 11, no. 1, 2017, p. 373-379

[\[abstract\]](#) doi: <https://dx.doi.org/10.5219/743> [\[fulltext\]](#)

AGING OF BEEF RUMPSTEAK ON SENSORY QUALITY, COLOR APPEARANCE AND TEXTURE PROPERTIES

Hana Šulcerová, Vladimír Sýkora, Šárka Nedomová, Michal Mihok

Potravinarstvo Slovak Journal of Food Sciences, vol. 11, no. 1, 2017, p. 380-385

[\[abstract\]](#) doi: <https://dx.doi.org/10.5219/747> [\[fulltext\]](#)

SOMATIC CELL COUNT IN MILK OF INDIVIDUAL LACAUNE EWES UNDER PRACTICAL CONDITIONS IN SLOVAKIA: POSSIBLE EFFECT ON MILK YIELD AND ITS COMPOSITION

Vladimír Tančín, Michal Uhrinčať, Lucia Mačuhová, Štefan Baranovič, Martina Vršková

Potravinarstvo Slovak Journal of Food Sciences, vol. 11, no. 1, 2017, p. 386-390

[\[abstract\]](#) doi: <https://dx.doi.org/10.5219/767> [\[fulltext\]](#)

EVALUATION OF RABBIT MEAT MICROBIOTA FROM THE VIEWPOINT OF MARKETING METHOD

Olga Cwíková, Roman Pytel

Potravinarstvo Slovak Journal of Food Sciences, vol. 11, no. 1, 2017, p. 391-397

[\[abstract\]](#) doi: <https://dx.doi.org/10.5219/764> [\[fulltext\]](#)

A COMPARATIVE STUDY OF SUS SCROFA M. LONGISSIMUS DORSI WITH DIFFERENT CHANGES IN QUALITY

Irina Chernukha, Liliya Fedulova, Anastasia Akhremko, Elena Kotenkova

Potravinarstvo Slovak Journal of Food Sciences, vol. 11, no. 1, 2017, p. 398-402

[\[abstract\]](#) doi: <https://dx.doi.org/10.5219/769> [\[fulltext\]](#)

SPECIES OF GENERA BOTRYTIS, FUSARIUM AND RHIZOPUS ON GRAPES OF THE SLOVAK ORIGIN

Dana Tančinová, Zuzana Mašková, Ľubomír Rybárik, Viera Michalová

Potravinarstvo Slovak Journal of Food Sciences, vol. 11, no. 1, 2017, p. 403-409

[\[abstract\]](#) doi: <https://dx.doi.org/10.5219/763> [\[fulltext\]](#)

EFFECT OF COCOA FAT CONTENT ON WETTING AND SURFACE ENERGY OF CHOCOLATE

Lubomír Lapčík, Barbora Lapčíková, Hana Žižková, Li Peng, Viera Vojteková

Potravinarstvo Slovak Journal of Food Sciences, vol. 11, no. 1, 2017, p. 410-416

[\[abstract\]](#) doi: <https://dx.doi.org/10.5219/732> [\[fulltext\]](#)

DEMONSTRATION OF PHYSICAL PHENOMENAS AND SCAVENGING ACTIVITY FROM D-PSICOSE AND METHIONINE MAILLARD REACTION PRODUCTS

Arum Tiyas Suminar, Ahmad Ni'matullah Al-Baari, Anang Mohamad Legowo

Potravinarstvo Slovak Journal of Food Sciences, vol. 11, no. 1, 2017, p. 417-424

[\[abstract\]](#) doi: <https://dx.doi.org/10.5219/776> [\[fulltext\]](#)

POSSIBLE CONSEQUENCES OF THE SUCROSE REPLACEMENT BY A FRUCTOSE-GLUCOSE SYRUP

Judit Sülí, Ingrid Hamarová, Anna Sobeková

Potravinárstvo Slovak Journal of Food Sciences, vol. 11, no. 1, 2017, p. 425-430

[\[abstract\]](#) doi: <https://dx.doi.org/10.5219/772> [\[fulltext\]](#)

THE EFFECT OF DHA OMEGA-3 FEEDING IN THE HIGH YIELDING HOLSTEIN HERD

Juraj Karcol, Radovan Kasarda, Milan Šimko, Ondrej Hanušovský

Potravinárstvo Slovak Journal of Food Sciences, vol. 11, no. 1, 2017, p. 431-435

[\[abstract\]](#) doi: <https://dx.doi.org/10.5219/801> [\[fulltext\]](#)

EFFECTS OF FLORAL HONEY AND PRESSED FLAX SEEDS ON INTENSITY OF YOGURT AROMA, SWEETNESS AND SOUR TASTE OF YOGURTS DURING STORAGE

Zuzana Remeňová, Margita Čanigová, Miroslav Kročko, Viera Ducková, Andrea Šimková

Potravinárstvo Slovak Journal of Food Sciences, vol. 11, no. 1, 2017, p. 436-440

[\[abstract\]](#) doi: <https://dx.doi.org/10.5219/760> [\[fulltext\]](#)

PREPARATION OF MALTS FOR PRODUCTION OF SPECIAL BEERS

Hana Kábelová-Ficová, Stanislav Kráčmar, Tomáš Gregor, Miroslav Fišera, Jozef Golian, Vlastimil Kubáň, Tomáš Šopík

Potravinárstvo Slovak Journal of Food Sciences, vol. 11, no. 1, 2017, p. 441-445

[\[abstract\]](#) doi: <https://dx.doi.org/10.5219/773> [\[fulltext\]](#)

PUBLISHED: 14. July 2017

ELECTRONIC NOSE IN EDIBLE INSECTS AREA

Martin Adámek, Anna Adámková, Marie Borkovcová, Jiří Mlček, Martina Bednářová, Lenka Kouřimská, Josef Skácel

Potravinárstvo Slovak Journal of Food Sciences, vol. 11, no. 1, 2017, p. 446-451

[\[abstract\]](#) doi: <https://dx.doi.org/10.5219/785> [\[fulltext\]](#)

COMPARATIVE STUDY ON NATURAL PLANT ANTIBIOTICS – VEGETABLE AND THEIR CONSUMPTION AMONG COLLEGE STUDENTS

Tünde Juríková, Ildikó Viczayová, Alžbeta Hegedúsová, Jiří Mlček, József Kontra, Lukáš Snopek, Marcel Golian

Potravinárstvo Slovak Journal of Food Sciences, vol. 11, no. 1, 2017, p. 452-459

[\[abstract\]](#) doi: <https://dx.doi.org/10.5219/778> [\[fulltext\]](#)

WELFARE OF THE MEALWORM (TENEBRIO MOLITOR) BREEDING WITH REGARD TO NUTRITION VALUE AND FOOD SAFETY

Anna Adámková, Martin Adámek, Jiří Mlček, Marie Borkovcová, Martina Bednářová, Lenka Kouřimská, Josef Skácel, Eva Vítová

Potravinárstvo Slovak Journal of Food Sciences, vol. 11, no. 1, 2017, p. 460-465

[\[abstract\]](#) doi: <https://dx.doi.org/10.5219/779> [\[fulltext\]](#)

EFFECT OF FEEDING OF PREFERMENTED BIOPRODUCT CONTAINING GAMMA-LINOLENIC ACID AND BETA-CAROTENE ON SELECTED PARAMETERS OF BROILER CHICKEN MEAT QUALITY

Ján Mačanga, Peter Popelka, Beáta Koréneková, Iveta Maskaľová, Tatiana Klemková, Adriána Fečkaninová, Martin Mellen, Dana Marcinčáková, Milan Čertík, Slavomír Marcinčák

Potravinárstvo Slovak Journal of Food Sciences, vol. 11, no. 1, 2017, p. 466-471

[\[abstract\]](#) doi: <https://dx.doi.org/10.5219/781> [\[fulltext\]](#)

COMPARATIVE STUDY OF HONEY CONSUMPTION IN SLOVAKIA AND RUSSIA

Snezhanna Guziy, Peter Šedík, Elena Horská

Potravinárstvo Slovak Journal of Food Sciences, vol. 11, no. 1, 2017, p. 472-479

[\[abstract\]](#) doi: <https://dx.doi.org/10.5219/784> [\[fulltext\]](#)

APPROACHES TO THE DETERMINATION OF ANTIOXIDANT ACTIVITY OF EXTRACTS FROM BEE BREAD AND SAFFLOWER LEAVES AND FLOWERS

Nataliia Hudz, Raisa Ivanova, Ján Brindza, Olga Grygorieva, Zuzana Schubertová, Eva Ivanišová

Potravinárstvo Slovak Journal of Food Sciences, vol. 11, no. 1, 2017, p. 480-488

[\[abstract\]](#) doi: <https://dx.doi.org/10.5219/786> [\[fulltext\]](#)

WINTER SQUASH (CUCURBITA MOSCHATA DUCH) FRUIT AS A SOURCE OF BIOLOGICALLY ACTIVE COMPONENTS AFTER ITS THERMAL TREATMENT

Andrea Mendelová, Ľubomír Mendel, Martina Fikselová, Ján Mareček, Alena Vollmannová

Potravinárstvo Slovak Journal of Food Sciences, vol. 11, no. 1, 2017, p. 489-495

[\[abstract\]](#) doi: <https://dx.doi.org/10.5219/788> [\[fulltext\]](#)

MYCOBIOTA OF SLOVAK WINE GRAPES WITH EMPHASIS ON ASPERGILLUS AND PENICILLIUM SPECIES IN THE SOUTH SLOVAK WINE REGION

Soňa Feľšöciová, Dana Tančinová, Ľubomír Rybárik, Zuzana Mašková

Potravinárstvo Slovak Journal of Food Sciences, vol. 11, no. 1, 2017, p. 496-502

[\[abstract\]](#) doi: <https://dx.doi.org/10.5219/789> [\[fulltext\]](#)

CO-ADMINISTRATION OF AMYGDALIN AND DEOXYNIVALENOL DISRUPTED REGULATORY PROTEINS LINKED TO PROLIFERATION OF PORCINE OVARIAN CELLS IN VITRO

Marek Halenar, Marina Medvedova, Simona Baldovska, Katarina Michalcova, Adriana Kolesarova

Potravinárstvo Slovak Journal of Food Sciences, vol. 11, no. 1, 2017, p. 503-509

[\[abstract\]](#) doi: <https://dx.doi.org/10.5219/791> [\[fulltext\]](#)

METHYLXANTHINES AND CATECHINES IN DIFFERENT TEAS (CAMELLIA SINENSIS L. KUNTZE) – INFLUENCE ON ANTIOXIDANT PROPERTIES

Július Árvay, Martin Hauptvogel, Eva Ivanišová, Ivana Tirdíľová, Miroslava Hrstková, Daniel Bajčan, Peter Lazor

Potravinárstvo Slovak Journal of Food Sciences, vol. 11, no. 1, 2017, p. 510-516

[\[abstract\]](#) doi: <https://dx.doi.org/10.5219/796> [\[fulltext\]](#)

EFFECT OF GRAPE SEED EXTRACT ON QUALITY OF RAW-COOKED MEAT PRODUCTS

Marek Bobko, Peter Haščík, Miroslav Kročko, Lenka Trembecká, Andrea Mendelová, Jana Tkáčová, Peter Czako, Tomáš Tóth

Potravinárstvo Slovak Journal of Food Sciences, vol. 11, no. 1, 2017, p. 517-521

[\[abstract\]](#) doi: <https://dx.doi.org/10.5219/797> [\[fulltext\]](#)

INFLUENCE OF THE ADDITION OF POST-EXTRACTION RAPESEED MEAL ON THE SENSORIC QUALITY OF POULTRY MEAT

Alžbeta Jarošová, Hana Šulcerová

Potravinárstvo Slovak Journal of Food Sciences, vol. 11, no. 1, 2017, p. 522-528

[\[abstract\]](#) doi: <https://dx.doi.org/10.5219/746> [\[fulltext\]](#)

GROWTH OF MICROORGANISMS IN THE PRE-FERMENTATION TANKS IN THE PRODUCTION OF ETHANOL

Viera Michalová, Dana Tančinová

Potravinárstvo Slovak Journal of Food Sciences, vol. 11, no. 1, 2017, p. 529-534

[\[abstract\]](#) doi: <https://dx.doi.org/10.5219/771> [\[fulltext\]](#)

EFFECT OF PERORAL SUPPLEMENTATION WITH SELENIUM AND VITAMIN E DURING LATE PREGNANCY ON UDDER HEALTH AND MILK QUALITY IN DAIRY COWS

Milan Vasiľ, Fratišek Zigo, Juraj Elečko, Martina Zígová, Zuzana Farkašová

Potravinárstvo Slovak Journal of Food Sciences, vol. 11, no. 1, 2017, p. 535-538

[\[abstract\]](#) doi: <https://dx.doi.org/10.5219/766> [\[fulltext\]](#)

COMPARATIVE STUDY OF BIOCORRECTIVE PROTEIN-PEPTIDE AGENT TO IMPROVE QUALITY AND SAFETY OF LIVESTOCK PRODUCTS

Irina Mikhailovna Chernukha, Liliya Vyacheslavovna Fedulova, Ekaterina Romanovna Vasilevskaya, Elena Alexandrovna Kotenkova

Potravinárstvo Slovak Journal of Food Sciences, vol. 11, no. 1, 2017, p. 539-543

[\[abstract\]](#) doi: <https://dx.doi.org/10.5219/590> [\[fulltext\]](#)

POTENTIAL OF *LACTOBACILLUS PLANTARUM* CCM 3627 AND *LACTOBACILLUS BREVIS* CCM 1815 FOR FERMENTATION OF CEREAL SUBSTRATES

Kvetoslava Romanová, Dana Urminská

Potravinárstvo Slovak Journal of Food Sciences, vol. 11, no. 1, 2017, p. 544-549

[\[abstract\]](#) doi: <https://dx.doi.org/10.5219/696> [\[fulltext\]](#)

A COMPARATIVE STUDY OF THE PHYSICO-CHEMICAL PROPERTIES AND ANTIMICROBIAL QUALITIES OF ABUAD MORINGA SOAP WITH CONVENTIONAL MEDICATED SOAPS

Pius Abimbola Okiki, Abiodun Ayodele Ojo, Hadiza Tani Onyibe, Olawale Oso, Basiru Olaitan Ajiboye

Potravinárstvo Slovak Journal of Food Sciences, vol. 11, no. 1, 2017, p. 550-557

[\[abstract\]](#) doi: <https://dx.doi.org/10.5219/733> [\[fulltext\]](#)

EFFECT OF HUMATES IN DIET OF DAIRY COWS ON THE RAW MILK MAIN COMPONENTS

Miroslava Potůčková, Lenka Kouřimská

Potravinárstvo Slovak Journal of Food Sciences, vol. 11, no. 1, 2017, p. 558-563

[\[abstract\]](#) doi: <https://dx.doi.org/10.5219/748> [\[fulltext\]](#)

DETERMINATION OF TIN, CHROMIUM, CADMIUM AND LEAD IN CANNED FRUITS FROM THE CZECH MARKET

Pavel Diviš, Elena Šťábová, Jaromír Pořízka, Juliána Drábíková

Potravinárstvo Slovak Journal of Food Sciences, vol. 11, no. 1, 2017, p. 564-570

[\[abstract\]](#) doi: <https://dx.doi.org/10.5219/749> [\[fulltext\]](#)

EFFECT OF THYME AND OREGANO AQUEOUS TEA INFUSIONS ON THE MICROBIOLOGICAL CHARACTERISTICS OF SAUSAGES

Miroslav Kročko, Viera Ducková, Margita Čanigová, Vladimíra Kňazovická, Zuzana Remeňová, Lenka Trembecká, Peter Haščík

Potravinárstvo Slovak Journal of Food Sciences, vol. 11, no. 1, 2017, p. 571-574

[\[abstract\]](#) doi: <https://dx.doi.org/10.5219/761> [\[fulltext\]](#)

BIOLOGICAL EFFECT OF MAGNETIC FIELD ON THE FERMENTATION OF WINE

Jakub Dobšínský, Jaroslav Jedlička

Potravinárstvo Slovak Journal of Food Sciences, vol. 11, no. 1, 2017, p. 575-579

[\[abstract\]](#) doi: <https://dx.doi.org/10.5219/762> [\[fulltext\]](#)

AUTHENTICATION OF CAPRINE MILK AND CHEESE BY COMMERCIAL QPCR ASSAY

Tomáš Fekete, Marek Šnirc, Lubomír Belej, Radoslav Židek, Jozef Golian, Peter Haščík, Lucia Zeleňáková, Peter Zajác

Potravinárstvo Slovak Journal of Food Sciences, vol. 11, no. 1, 2017, p. 580-586

[\[abstract\]](#) doi: <https://dx.doi.org/10.5219/780> [\[fulltext\]](#)

THE EFFECT OF CONFORMATIONAL TRANSITION OF GELATIN-POLYSACCHARIDE POLYELECTROLYTE COMPLEX ON ITS FUNCTIONAL PROPERTIES

Tomáš Valenta, Barbora Lapčíková, Lubomír Lapčík, Li Peng

Potravinarstvo Slovak Journal of Food Sciences, vol. 11, no. 1, 2017, p. 587-596

[\[abstract\]](#) doi: <https://dx.doi.org/10.5219/728> [\[fulltext\]](#)

SURVIVAL OF *LACTOBACILLUS BULGARICUS* AND *BIFIDOBACTERIUM ANIMALIS* IN YOGHURTS MADE FROM COMMERCIAL STARTER CULTURES DURING REFRIGERATED STORAGE

Eva Dudriková, Mária Nagyová, Zuzana Dičáková

Potravinarstvo Slovak Journal of Food Sciences, vol. 11, no. 1, 2017, p. 597-601

[\[abstract\]](#) doi: <https://dx.doi.org/10.5219/758> [\[fulltext\]](#)

EFFECT OF THYME AND OREGANO AQUEOUS TEA INFUSIONS ON THE LIPID OXIDATION AND SENSORY CHARACTERISTICS OF FRANKFURTERS SAUSAGES

Miroslav Kročko, Marek Bobko, Viera Ducková, Margita Čanigová, Peter Haščík, Jana Tkáčová

Potravinarstvo Slovak Journal of Food Sciences, vol. 11, no. 1, 2017, p. 602-605

[\[abstract\]](#) doi: <https://dx.doi.org/10.5219/798> [\[fulltext\]](#)

THE INVESTIGATION OF ALFAALFA EFFECT ON THE ACTIVITY OF SUPEROXIDE DISMUTASE IN CHICKEN MEAT IN DEPENDENCE ON TIME STORAGE

Jana Tkáčová, Mária Angelovičová, Marcela Capcarová, Adriana Kolesárová, Monika Schneidgenová, Adriana Pavelková, Marek Bobko, Juraj Čuboň

Potravinarstvo Slovak Journal of Food Sciences, vol. 11, no. 1, 2017, p. 606-611

[\[abstract\]](#) doi: <https://dx.doi.org/10.5219/800> [\[fulltext\]](#)

MORPHOLOGICAL CHARACTERISTICS AND DETERMINATION OF VOLATILE ORGANIC COMPOUNDS OF *DIOSPYROS VIRGINIANA* L. GENOTYPES FRUITS

Oľga Grygorieva, Svitlana Klymenko, Oľena Vergun, Nataliia Hudz, Nataliia Nikolaieva, Zuzana Schubertová, Oľena Palamarchuk, Ján Brindza

Potravinarstvo Slovak Journal of Food Sciences, vol. 11, no. 1, 2017, p. 612-622

[\[abstract\]](#) doi: <https://dx.doi.org/10.5219/808> [\[fulltext\]](#)

EFFECT OF DIFFERENT LEVELS OF GREEN TEA (*CAMELLIA SINENSIS*) ON PRODUCTIVE PERFORMANCE, CARCASS CHARACTERISTICS AND ORGANS OF BROILER CHICKENS

Cyril Hrnčár, Jozef Bujko

Potravinarstvo Slovak Journal of Food Sciences, vol. 11, no. 1, 2017, p. 623-628

[\[abstract\]](#) doi: <https://dx.doi.org/10.5219/809> [\[fulltext\]](#)

SEED OIL CONTENT AND SELECTED QUALITATIVE PARAMETERS OF OILS FROM GRAPE SEEDS

Patrik Burg, Vladimír Mašán, Kazimierz Rutkowski, Jana Burgová, Lubomír Lampíř, Vladimír Višacki

Potravinarstvo Slovak Journal of Food Sciences, vol. 11, no. 1, 2017, p. 629-633

[\[abstract\]](#) doi: <https://dx.doi.org/10.5219/810> [\[fulltext\]](#)

THE RABBIT MEAT QUALITY AFTER DIFFERENT FEEDING

Adriana Pavelková, Jana Tkáčová, Karin Červienková, Ondřej Bučko

Potravinarstvo Slovak Journal of Food Sciences, vol. 11, no. 1, 2017, p. 634-640

[\[abstract\]](#) doi: <https://dx.doi.org/10.5219/811> [\[fulltext\]](#)

PUBLISHED: 18. December 2017

PRODUCTION AND CHARACTERIZATION OF PECTINASE ENZYME FROM *RHIZOPUS ORYZAE*

Taminur Islam Chowdhury, Fahad Jubayer, Burhan Uddin, Gulzarul Aziz

Potravinarstvo Slovak Journal of Food Sciences, vol. 11, no. 1, 2017, p. 641-651

[\[abstract\]](#) doi: <https://dx.doi.org/10.5219/656> [\[fulltext\]](#)

MICROBIOLOGICAL QUALITY OF FRESH AND HEAT TREATED COW'S MILK DURING STORAGE

Simona Kunová, Jozef Golian, Lucia Zeleňáková, Ľubomír Lopašovský, Juraj Čuboň, Peter Haščík, Miroslava Kačániová

Potravinárstvo Slovak Journal of Food Sciences, vol. 11, no. 1, 2017, p. 652-657

[\[abstract\]](#) doi: <https://dx.doi.org/10.5219/799> [\[fulltext\]](#)

ANTIOXIDANT, ANTIMICROBIAL ACTIVITY AND MINERAL COMPOSITION OF LOW-TEMPERATURE FRACTIONING PRODUCTS OF *MALUS DOMESTICA BORKH* (COMMON ANTONOVKA)

Elena Kuznetsova, Alexander Emelyanov, Andrey Vinokurov, Tatyana Bychkova, Elena Klimova, Vladislav Zomitev, Natalia Selifonova, Ján Brindza

Potravinárstvo Slovak Journal of Food Sciences, vol. 11, no. 1, 2017, p. 658-663

[\[abstract\]](#) doi: <https://dx.doi.org/10.5219/820> [\[fulltext\]](#)

EVALUATION OF SELECTED PHYSICO-CHEMICAL PARAMETERS OF EXTRA VIRGIN OLIVE OIL COMMERCIALIZED IN THE CZECH MARKET AND STORED DURING A PERIOD OF 5 MONTHS

Richardos Nikolaos Salek, Iva Burešová, Stanislav Kráčmar, Eva Lorencová, Ludmila Zálešáková, Vikendra Dabash

Potravinárstvo Slovak Journal of Food Sciences, vol. 11, no. 1, 2017, p. 664-672

[\[abstract\]](#) doi: <https://dx.doi.org/10.5219/823> [\[fulltext\]](#)

VERIFICATION OF ANIMAL SPECIES IN HAM AND SALAMI BY DNA MICROARRAY AND REAL TIME PCR METHODS

Zuzana Drdolová, Jozef Golian, Jozef Čurlej, Lenka Maršalková

Potravinárstvo Slovak Journal of Food Sciences, vol. 11, no. 1, 2017, p. 673-678

[\[abstract\]](#) doi: <https://dx.doi.org/10.5219/831> [\[fulltext\]](#)

EFFECT OF THERMAL TREATMENT ON RUTIN CONTENT IN SELECTED BUCKWHEAT PRODUCTS USING CALCIUM AS AN INTERNAL TRACER

Eliška Krejzová, Miroslava Bittová, Stanislav Kráčmar, Petra Vojtíšková, Vlastimil Kubáň, Jozef Golian

Potravinárstvo Slovak Journal of Food Sciences, vol. 11, no. 1, 2017, p. 679-684

[\[abstract\]](#) doi: <https://dx.doi.org/10.5219/853> [\[fulltext\]](#)

COSTS OF GROWING WHEAT AND OILSEED RAPE IN SLOVAKIA AND OTHER V4 COUNTRIES

Lenka Hudáková Stašová, Radoslav Bajus

Potravinárstvo Slovak Journal of Food Sciences, vol. 11, no. 1, 2017, p. 685-695

[\[abstract\]](#) doi: <https://dx.doi.org/10.5219/832> [\[fulltext\]](#)

DYNAMICS OF LACTOSE CHANGES DURING RIPENING OF EDAM CHEESE

Lenka Vorlová, Lenka Prokopová, Jan Pospíšil, Petr Tichovský, Zuzana Derflerová Brázdová, Kateřina Bogdanovičová

Potravinárstvo Slovak Journal of Food Sciences, vol. 11, no. 1, 2017, p. 696-701

[\[abstract\]](#) doi: <https://dx.doi.org/10.5219/685> [\[fulltext\]](#)

EVALUATION AND COMPARISON OF BIOACTIVE SUBSTANCES IN SELECTED SPECIES OF THE GENUS *ALLIUM*

Ján Kovarovič, Judita Bystrická, Alexander Fehér, Marianna Lenková

Potravinárstvo Slovak Journal of Food Sciences, vol. 11, no. 1, 2017, p. 702-708

[\[abstract\]](#) doi: <https://dx.doi.org/10.5219/833> [\[fulltext\]](#)

IMPACT OF SENSORY MARKETING ON CONSUMER'S BUYING BEHAVIOUR

Andrej Géci, Ľudmila Nagyová, Jana Rybanská

Potravinárstvo Slovak Journal of Food Sciences, vol. 11, no. 1, 2017, p. 709-717

[\[abstract\]](#) doi: <https://dx.doi.org/10.5219/835> [\[fulltext\]](#)

SELENIUM, CADMIUM AND DIAZINON INSECTICIDE IN TISSUES OF RATS AFTER PERORAL EXPOSURE

Róbert Toman, Martina Tunegová

Potravinárstvo Slovak Journal of Food Sciences, vol. 11, no. 1, 2017, p. 718-724

[\[abstract\]](#) doi: <https://dx.doi.org/10.5219/827> [\[fulltext\]](#)

DETECTION OF SELECTED HEAVY METALS AND MICRONUTRIENTS IN EDIBLE INSECT AND THEIR DEPENDENCY ON THE FEED USING XRF SPECTROMETRY

Jiří Miček, Martin Adámek, Anna Adámková, Marie Borkovcová, Martina Bednářová, Josef Skácel

Potravinárstvo Slovak Journal of Food Sciences, vol. 11, no. 1, 2017, p. 725-730

[\[abstract\]](#) doi: <https://dx.doi.org/10.5219/850> [\[fulltext\]](#)

CONSUMERS' PURCHASING PREFERENCES TOWARDS ORGANIC FOOD IN SLOVAKIA

Zdenka Kádeková, Roman Récky, Ľudmila Nagyová, Ingrida Košičiarová, Mária Holienčinová

Potravinárstvo Slovak Journal of Food Sciences, vol. 11, no. 1, 2017, p. 731-738

[\[abstract\]](#) doi: <https://dx.doi.org/10.5219/846> [\[fulltext\]](#)

THE WINE MARKET – AN EMPIRICAL EXAMINATION OF IN-STORE CONSUMER BEHAVIOUR

Bartłomiej Pierański, Barbara Borusiak, Elena Horská

Potravinárstvo Slovak Journal of Food Sciences, vol. 11, no. 1, 2017, p. 739-746

[\[abstract\]](#) doi: <https://dx.doi.org/10.5219/671> [\[fulltext\]](#)

EFFECT OF SELECTED POLYMORPHISMS OF GENES LEP, MTHFR AND FTO TO BMI LEVEL AND GENDER-SPECIFICITY

Kristína Candráková, Anna Trakovická, Michal Gábor, Martina Miluchová, Radovan Kasarda, Nina Moravčíková

Potravinárstvo Slovak Journal of Food Sciences, vol. 11, no. 1, 2017, p. 747-753

[\[abstract\]](#) doi: <https://dx.doi.org/10.5219/834> [\[fulltext\]](#)

MORPHOLOGICAL CHARACTERISTICS FOR FRUITS OF ARONIA MITSCHURINII A.K. SKVORTSOV & MAITUL.

Yulia Vinogradova Maitulina, Olga Grygorieva, Olena Vergun, Ján Brindza

Potravinárstvo Slovak Journal of Food Sciences, vol. 11, no. 1, 2017, p. 754-760

[\[abstract\]](#) doi: <https://dx.doi.org/10.5219/845> [\[fulltext\]](#)

THE INFLUENCE OF GLUTEN-FREE BAKERY PRODUCTS CONSUMPTION ON SELECTED ANTHROPOMETRIC PARAMETERS

Martina Gažarová, Zuzana Chlebová, Jana Kopčeková, Petra Lenártová, Mária Holovičová

Potravinárstvo Slovak Journal of Food Sciences, vol. 11, no. 1, 2017, p. 761-769

[\[abstract\]](#) doi: <https://dx.doi.org/10.5219/861> [\[fulltext\]](#)

H A C C P

C O N S U L T I N G

PODPORUJEME VEDU A VÝSKUM

www.haccp.sk